

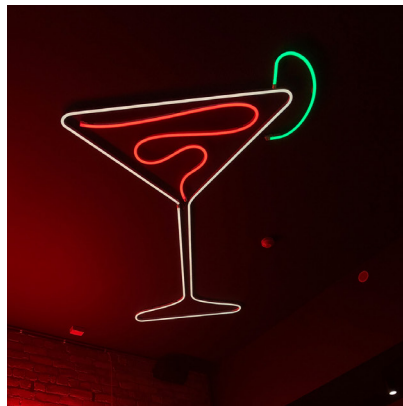

NEON CLASSIC | TUNEABLE WHITE | SILICONE



MARTINI GLASS OUTLINE IN NEON CLASSIC WHITE

Neon is a broad range of silicone encapsulated LED ribbons with a variety of light emissions and casings that closely reference glass neon tube.

Neon Classic is domed top model of W16.5 x H29mm (W11.5mm at the base).

Tuneable White allows lighting to be adjusted to suit the environment and time of day. Warmer temperatures create a cozy feel that is perfect for evenings, while cooler temperatures simulate day light, creating a more alert feel.

Neon is made to order, check with our team for lead times.

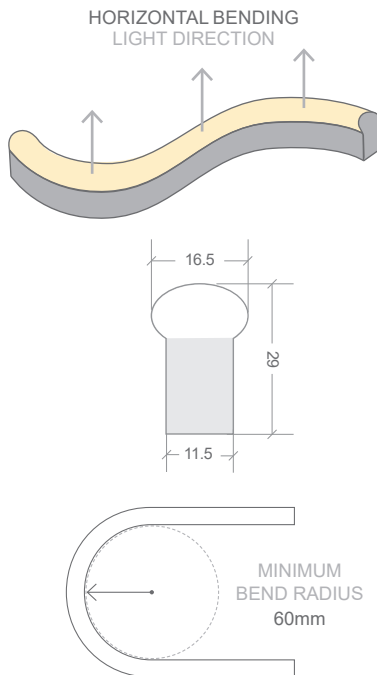

CODE	COLOUR	LUMENS
BL-LS-4900S	WARM WHITE 2200K +/- 140K	≥170lm/m
	COOL WHITE 5700K +/- 355K	≥210lm/m

ELECTRICAL & OPTICAL DATA VARIANCE +/- 10%. SOLD BY THE METRE. IES FILES AVAILABLE.

POWER & TEMP		PHYSICAL PARAMETERS & CONTROL	
LED WATTS	12W/m	MINIMUM BEND RADIUS	60mm
INPUT VOLTS	24V DC Constant voltage	BEND DIRECTION	Horizontal bending
OPERATING TEMP. (ENVIRONMENT)	-40°C ~ +55°C	DIMENSIONS	W16.5 x H29mm (W11.5mm at the base)
MAX. RUN PER POWER FEED	15m using one feed 30m using two feeds	INGRESS PROTECTION	IP67 or IP68 Protection established by use of connectors. <i>Dimensions of connectors shown on installation guide</i> SEE PAGE 2.
LIGHT & LIFE		CUTTING LENGTH	83.3mm
CRI	≥80	HOUSING	UV & flame resistant white silicone with opal diffuser
BEAM ANGLE	180°	MOUNTING	Profile / clips available SEE PAGE 3.
LED PER METRE	144	CONTROL	Requires 2-channel controller
SOURCE LIFE	50,000 hours		
WARRANTY	5 years		

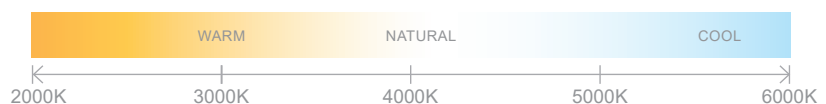

NEON CLASSIC | TUNEABLE WHITE | CONNECTIONS

Neon products are IP rated based on the fitted connections (power feed / end caps).

Bright Light recommend using Slimline injection moulding for the best result, a clean finish and IP68 rating. These are fitted at factory during the production process and can not be altered once produced - **ensure all lengths are double-checked before ordering.**

If on-site cutting is required (due to lengths being unknown in advance or site design alterations), Snap connector fittings can be used instead. Snap Connectors can be fitted on-site and offer an IP67 rating (provided all installation instructions are followed correctly).

Power feed connectors are priced & supplied with 1metre cable as standard. Please specify at time of quoting if alternate lengths are required.

SLIMLINE INJECTION MOULDING CONNECTIONS | IP68

RECOMMENDED



REQUIRES FITTING AT FACTORY.
EXACT LENGTH REQUIRED BEFORE PRODUCTION

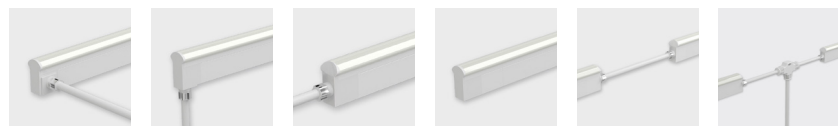

SIDE FEED BOTTOM FEED TOP END FEED END CAP 300MM FLEXIBLE CONNECTOR T FEED

SNAP CONNECTIONS | IP67

ON-SITE FITTING



FITTING ON-SITE - WHERE LENGTHS ARE UNKNOWN IN ADVANCE.
MUST BE FITTED CORRECTLY FOR IP RATING



TOP END FEED END CAP 300MM FLEXIBLE CONNECTOR

01 02 01 02

TUNEABLE WHITE

BL-LS-4517 BL-LS-4518 BL-LS-4526 BL-LS-4527 BL-LS-4519

NEON CLASSIC | MOUNTING ACCESSORIES

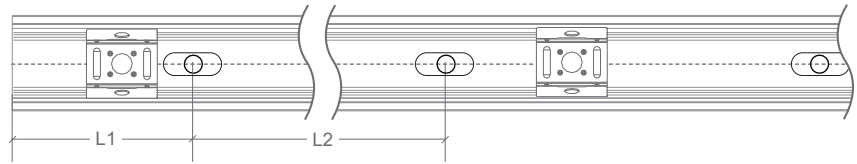

CODE	ACCESSORY	L1	L2	HOLE DIMENSIONS	HOLE NUMBER	CLIP NUMBER
BL-LS-4003	SELF-LOCKING ALUMINIUM PROFILE 2M	100mm	200mm	4 × 10mm	10	9
BL-LS-4004	SELF-LOCKING ALUMINIUM MOUNTING CLIP 35MM	5mm	25mm	4 × 10mm	2	1
BL-LS-4005	PLASTIC PROFILE 2M	100mm	200mm	Ø3.5mm	10	-
BL-LS-4006	PLASTIC PROFILE 1M	100mm	200mm	Ø3.5mm	5	-
BL-LS-4028	BENDABLE STAINLESS STEEL PROFILE 890MM MULTIPLE FIXING LOCATIONS	-	-	-	-	-

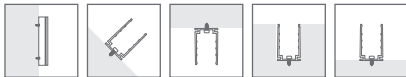
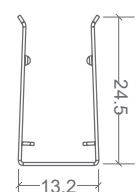
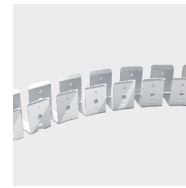
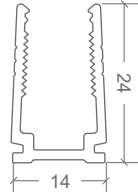
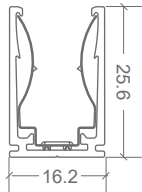
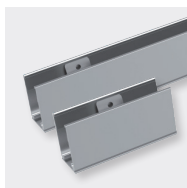

SELF-LOCKING ALUMINIUM PROFILE 2M / MOUNTING CLIP

Not recommend for underwater use

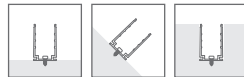

PLASTIC PROFILE

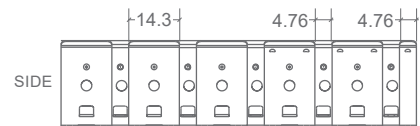

BENDABLE STAINLESS STEEL PROFILE 890MM