



NEON CLASSIC | RGB | SILICONE



PHOTO CREDIT: VICTOR CARINGAL FROM ARUP

Neon is a broad range of silicone encapsulated LED ribbons with a variety of light emissions and casings that closely reference glass neon tube.

Neon Classic is domed top model of W16.5 × H29mm (W11.5mm at the base).

RGB (Red, Green, Blue) ribbon provides a rainbow of colour options from hot pinks to vivid blues and anywhere in-between.

Neon is made to order, check with our team for lead times.

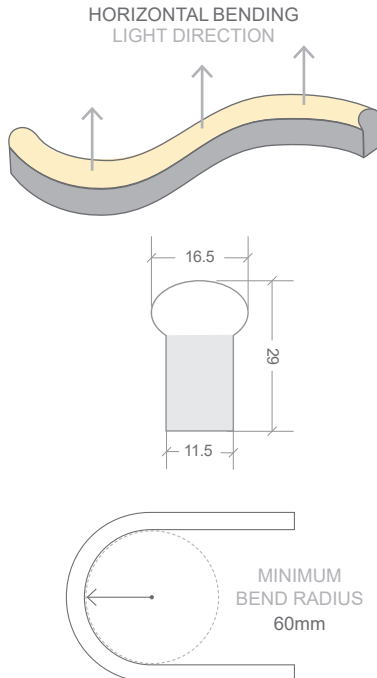

*STATIC VS DYNAMIC OPERATING

This product has a maximum wattage of 12W/m which is reached when all colours R+G+B are used simultaneously to create a white tone, with 3 × colour channels using approximately 4W/m each. Using Neon at this maximum load is called Static full loading (all colour channels, all powered continuously).

When R, G or B channels are used individually or blended to make colour mixes eg blue or purple (excluding white tones) the wattage used is below the maximum load and is considered dynamic operating. This also applies when the colours are constantly changing (including if a white tone is created but only used in a flashing or fading capacity).

When the maximum wattage of the product is reached, lengths longer than recommended may experience power loss, reduced luminosity & increased heat which can shorten the life of the product.

If unsure about the products intended usage, future proof by choosing the static full loading lengths.

APPLICATIONS

- Creative colour installations. Theatres, bars, restaurants, and retail
- Signage & cove lighting
- Architectural features
- Exterior or interior installations
- Swimming or feature pools

FEATURES

- A perfect replacement for traditional glass neon tube

CODE	COLOUR	LUMENS
BL-LS-4600S-RGB	R 615–625nm	≥60lm/m
	G 520–530nm	≥140lm/m
	B 465–475nm	≥30lm/m

ELECTRICAL & OPTICAL DATA VARIANCE +/- 10%. SOLD BY THE METRE. IES FILES AVAILABLE.

POWER & TEMP

LED WATTS	12W/m
INPUT VOLTS	24V DC Constant voltage
OPERATING TEMP. (ENVIRONMENT)	-40°C ~ +55°C
MAX. RUN PER POWER FEED	Static full loading* 10m using one feed 20m using two feeds Dynamic operating* 15m using one feed 30m using two feeds

LIGHT & LIFE

BEAM ANGLE	180°
LED PER METRE	60
SOURCE LIFE	50,000 hours
WARRANTY	5 years

PHYSICAL PARAMETERS & CONTROL

MINIMUM BEND RADIUS	60mm
BEND DIRECTION	Horizontal bending
DIMENSIONS	W16.5 × H29mm (W11.5mm at the base)
INGRESS PROTECTION	IP67 or IP68 Protection established by use of connectors. <i>Dimensions of connectors shown on installation guide</i> SEE PAGE 2.
CUTTING LENGTH	100mm
HOUSING	UV & flame resistant white silicone with opal diffuser
MOUNTING	Profile / clips available SEE PAGE 3.
CONTROL	Requires 3-channel RGB controller or compatible DMX-512 controller & decoder

NEON CLASSIC | RGB | CONNECTIONS

Neon products are IP rated based on the fitted connections (power feed / end caps).

Bright Light recommend using Slimline injection moulding for the best result, a clean finish and IP68 rating. These are fitted at factory during the production process and can not be altered once produced - **ensure all lengths are double-checked before ordering.**

If on-site cutting is required (due to lengths being unknown in advance or site design alterations), Snap connector fittings can be used instead. Snap Connectors can be fitted on-site and offer an IP67 rating (provided all installation instructions are followed correctly).

Power feed connectors are priced & supplied with 1metre cable as standard. Please specific at time of quoting if alternate lengths are required.

SLIMLINE INJECTION MOULDING CONNECTIONS | IP68

RECOMMENDED



REQUIRES FITTING AT FACTORY.
EXACT LENGTH REQUIRED BEFORE PRODUCTION



SIDE FEED



BOTTOM FEED



TOP END FEED



END CAP



300MM FLEXIBLE CONNECTOR



T FEED

SNAP CONNECTIONS | IP67

ON-SITE FITTING



FITTING ON-SITE - WHERE LENGTHS ARE UNKNOWN IN ADVANCE.
MUST BE FITTED CORRECTLY FOR IP RATING

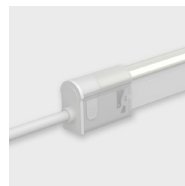

TOP END FEED

01

02



END CAP

01

02

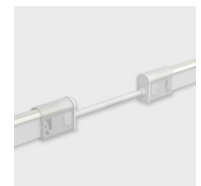

300MM FLEXIBLE CONNECTOR

RGB

BL-LS-4520

BL-LS-4521

BL-LS-4526

BL-LS-4527

BL-LS-4522

NEON CLASSIC | MOUNTING ACCESSORIES

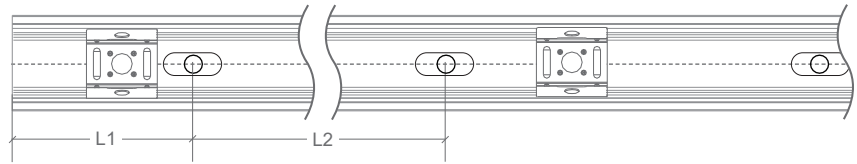

CODE	ACCESSORY	L1	L2	HOLE DIMENSIONS	HOLE NUMBER	CLIP NUMBER
BL-LS-4003	SELF-LOCKING ALUMINIUM PROFILE 2M	100mm	200mm	4 × 10mm	10	9
BL-LS-4004	SELF-LOCKING ALUMINIUM MOUNTING CLIP 35MM	5mm	25mm	4 × 10mm	2	1
BL-LS-4005	PLASTIC PROFILE 2M	100mm	200mm	Ø3.5mm	10	-
BL-LS-4006	PLASTIC PROFILE 1M	100mm	200mm	Ø3.5mm	5	-
BL-LS-4028	BENDABLE STAINLESS STEEL PROFILE 890MM MULTIPLE FIXING LOCATIONS	-	-	-	-	-

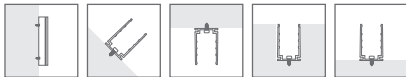
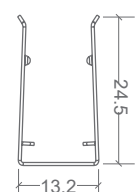
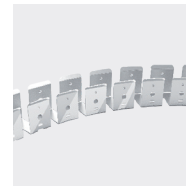
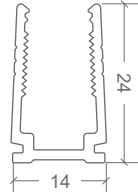
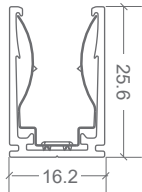
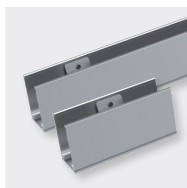

**SELF-LOCKING ALUMINIUM
PROFILE 2M / MOUNTING CLIP**

Not recommend for underwater use

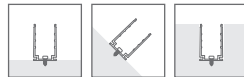

PLASTIC PROFILE

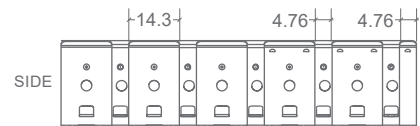

**BENDABLE STAINLESS STEEL
PROFILE 890MM**