

NEON ARC | SILICONE | ELECTRICAL AND PHYSICAL INSTALLATION GUIDE



Neon Arc is a square W16 × H17mm, vertical bending model perfect for cove lighting, or architectural features in exterior and interior applications.

Neon is made to order, check with our team for lead times.

FEATURES

- Neon Arc can be curved in the opposite direction of the other neon products
- UV & flame resistant

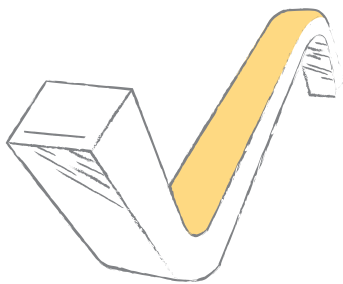
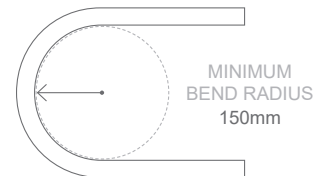
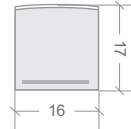
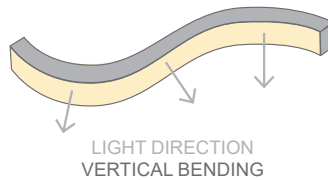

SUPPORTING NEON

Do not allow Neon to bend, twist or hang down as the weight of the light can damage the PCB.

When working with a length of Neon greater than 2m long, **ensure you have at least two installers.**



BENDING PARAMETERS



NEON ARC CAN BE CURVED AS SHOWN BELOW

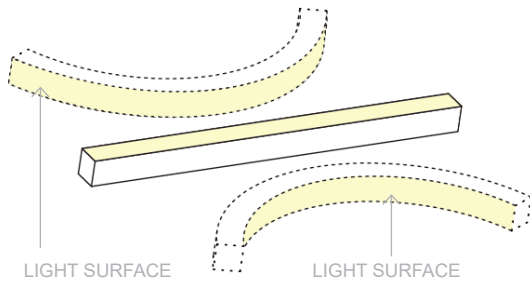

DO NOT TWIST THE LIGHT OR BEND AGAINST THE LIGHT SURFACE

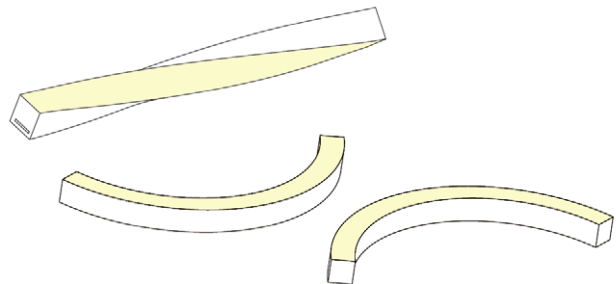

- Avoid bending LED Neon within the first unit (*units are clearly marked with dashed lines on the sides of the product*)

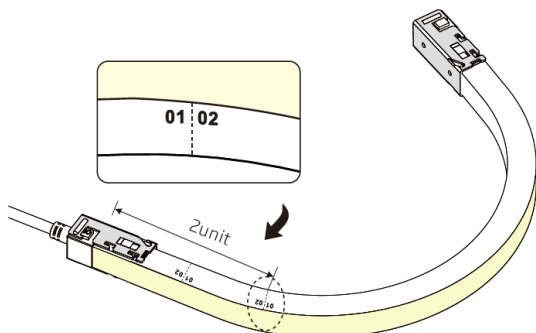

- LED Neon can be bent up to the defined "minimum bend radius" (150mm for Neon Arc)

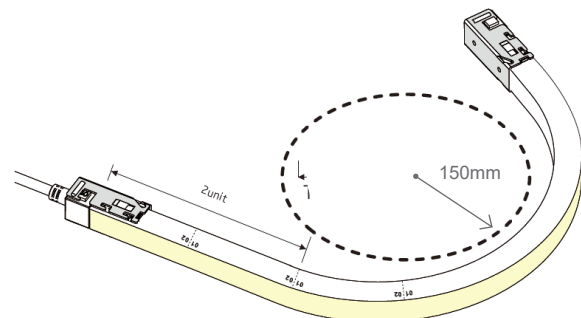

NEON ARC | SILICONE | ELECTRICAL AND PHYSICAL INSTALLATION GUIDE

REFER TO WIRING COLOUR PDF FOR MORE WIRING INFORMATION. REFER TO PRODUCT SPECIFICATION SHEET FOR MAX. RUN PER POWER FEED

BASIC WIRING GUIDE

WHITE (including Sauna & Dim to Warm models)

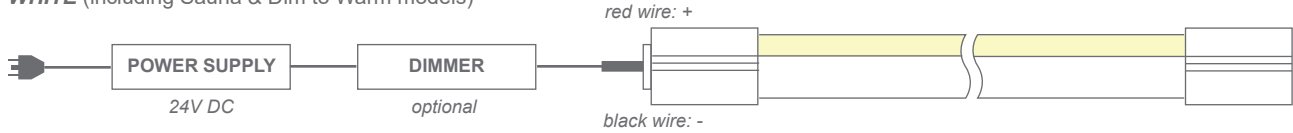

TUNEABLE WHITE

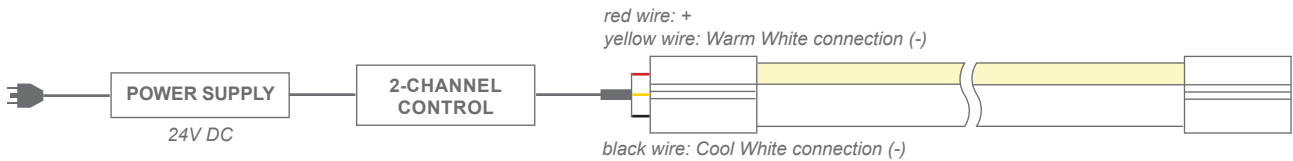

RGB

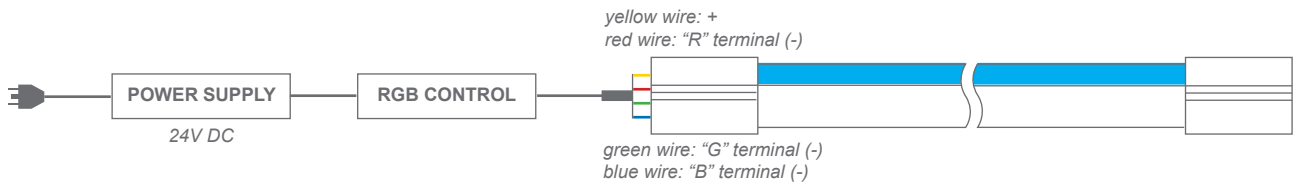

RGBW

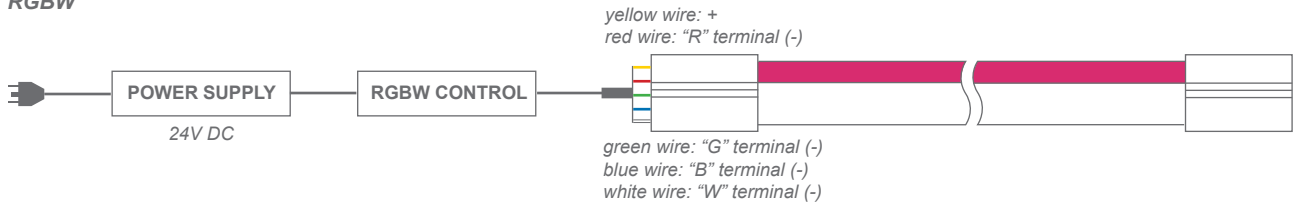

DYNAMIC RGB 'CHASING' (SPI CONTROL)

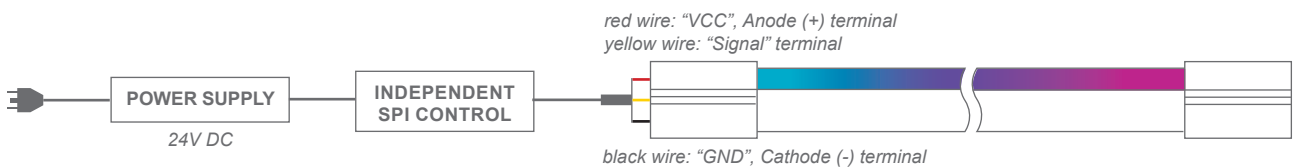

ABOVE DIAGRAMS ARE BASIC GUIDES, FINAL WIRING LAYOUT WILL DEPEND ON DESIRED OPERATION & CONTROL TYPE. MORE INFO ON SPEC SHEETS.

- LED Neon must always be used in conjunction with a certified Bright Light 24V DC power supply.
- Check the polarity of the connector before inserting the front connector and switching on the mains power.
- To minimise voltage drop and ensure consistent light output, position the power supply near to the power feed end of the LED Neon, and keep the line as short as possible.
- Ensure your maximum run per power feed adheres to the guidelines; see specification sheet.
- Ensure to add 20% buffer when selecting a power supply
- Before making any cuts, installation, maintenance, or connection, be sure the mains power is disconnected.
- If essential; cut and connect LED Neon correctly. Any incorrect operation can cause damage.
- All connector joints must be connected correctly to achieve connector IP rating.

NEON ARC | ELECTRICAL AND PHYSICAL INSTALLATION GUIDE

PROFILE INSTALLATION REQUIREMENTS

CODE	ACCESSORY
BL-LS-4803	SELF-LOCKING ALUMINIUM PROFILE 2m
BL-LS-4804	PLASTIC PROFILE 2m
BL-LS-4805	PLASTIC PROFILE 1m
BL-LS-4814	HYBRID PROFILE 2m

REFER TO
SPECIFICATION SHEETS
FOR PROFILE DETAILS
& DIMENSIONS

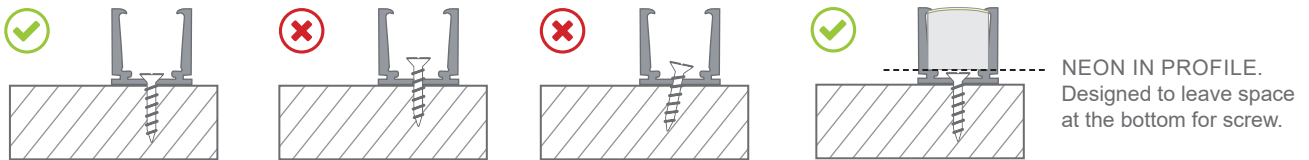

PROFILE MOUNTING: Install the screw ensuring head is flush or lower than the profile groove and into surface straight

ACCESSORY

BL-LS-4813	BENDABLE STAINLESS STEEL PROFILE 890MM MULTIPLE FIXING LOCATIONS
------------	---

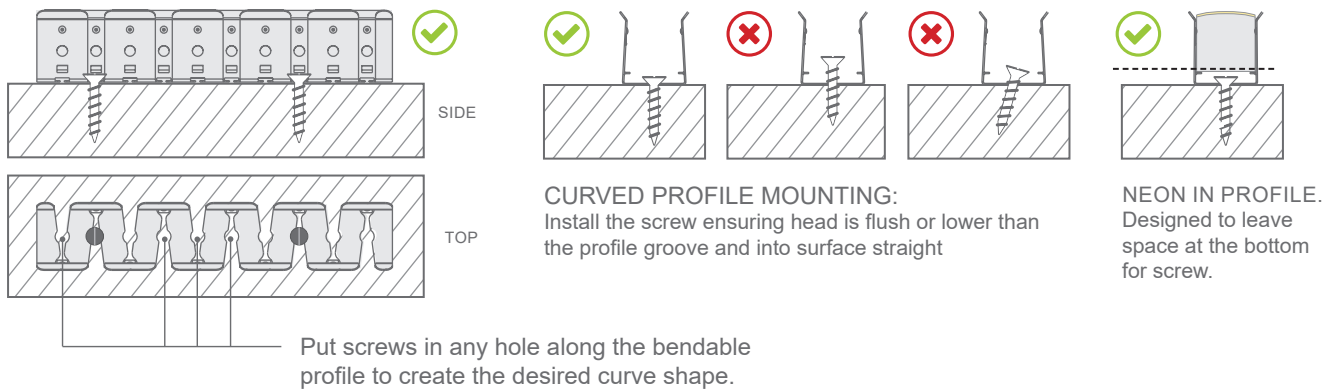

Curve stainless steel profile is flexible and can stretch or condense as the design requires.

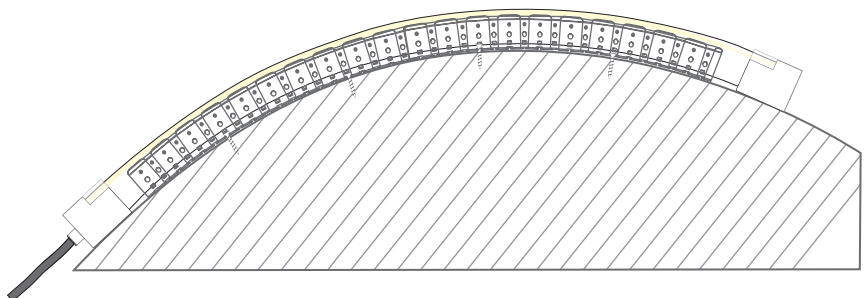

NEON ARC | ELECTRICAL AND PHYSICAL INSTALLATION GUIDE

PROFILE INSTALLATION REQUIREMENTS

- Keep 10–20mm space between the end of the profile and the connector or end cap. *This allows for contraction/expansion of the LED Neon and/or movement of the mounting profile with risking damage to the connector /end cap.*

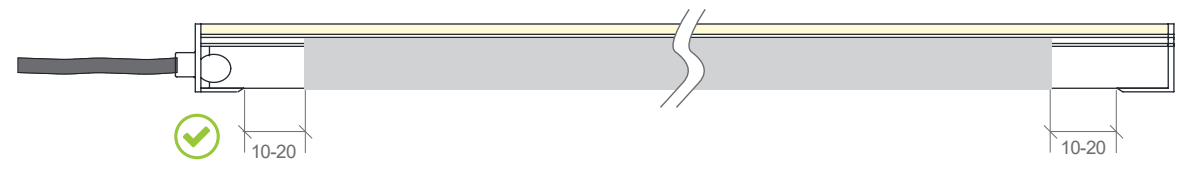
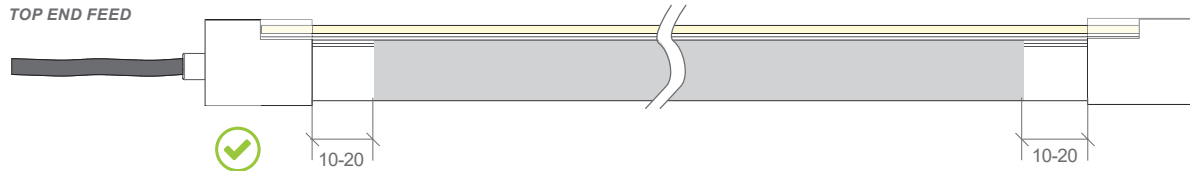

BOTTOM FEED / SIDE FEED

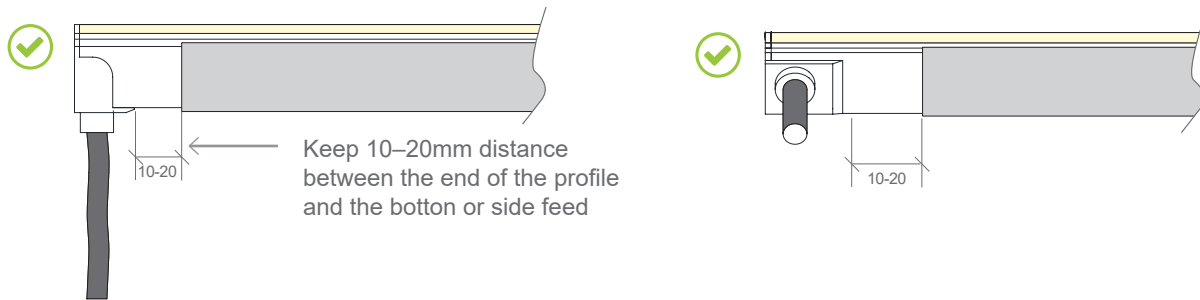

MIDDLE FEED

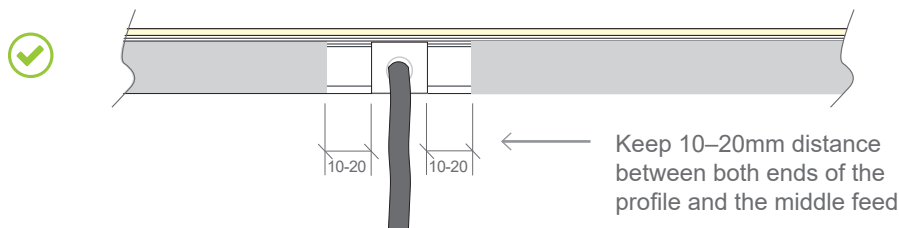

- Avoid placing mechanical stress on the front connector cable

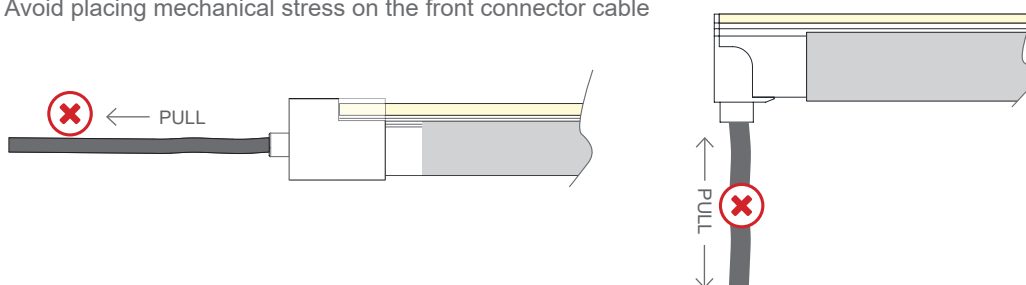

NEON ARC | ELECTRICAL AND PHYSICAL INSTALLATION GUIDE

PROFILE INSTALLATION REQUIREMENTS

- Do not curl or bend the front connector cable with excessive force.
- Try to keep at least 60mm of cable straight before any curve (top / bottom / side feed)

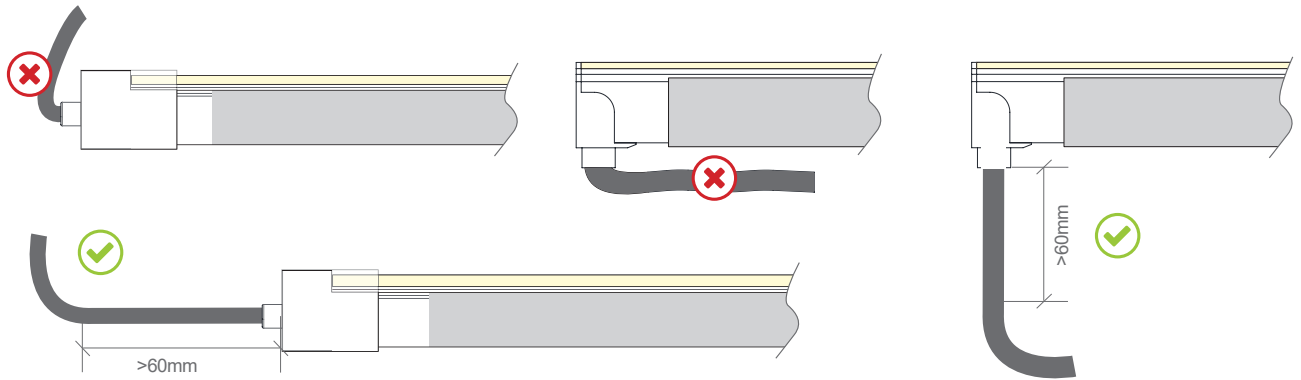

- Avoid installing the profile less than 10mm from the end mounting piece

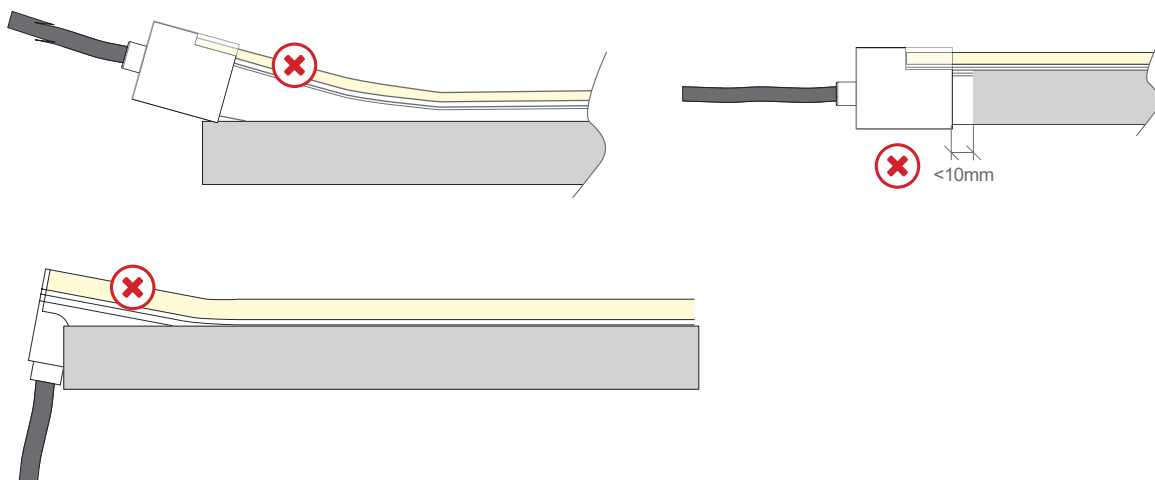

- Install the LED Neon into the profile in one direction, don't let it bow in the middle

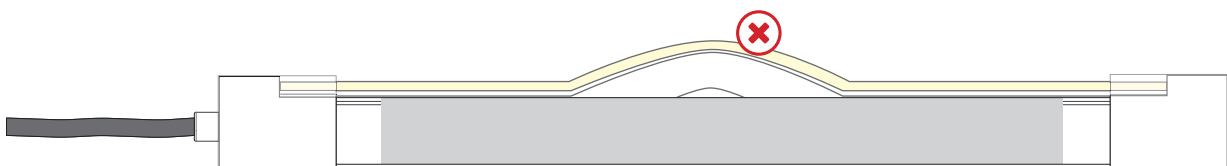

NEON ARC | ELECTRICAL AND PHYSICAL INSTALLATION GUIDE

ANTI-WICKING FERRULE

The **anti-wicking ferrule** is a small ring of metal fitted on Neon LED power feed cables. It is primarily for Neon installed outside or near water sources and is not required when Neon is being used indoors.

The ferrule is designed to lower the risk of water ingress into the Neon LED Light through the cable in the case of inadequate waterproofing of cable power supply connection on-site. The IP rating gives the rating of the connector type for external water/moisture. The ferrule is protecting from accidental internal moisture.

Bright Light has transitioned to a silicone-based Neon product that comes with a ferrule as standard for both IP68* injection connections and IP67 Snap Connectors, which can be fitted at the factory or on-site. (*Some models are only available in IP67)

Previous models of PVC Neon have several connection types available, but only connections with an IP67 rating or higher for outdoor use come with a ferrule as standard.

INDOOR OR OUTDOOR APPLICATION (NOT UNDER WATER)

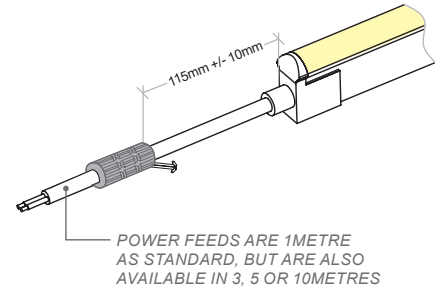

FAQ

DO I NEED A FERRULE?

Indoor applications: It's not essential, but recommended as it does provide an extra layer of protection.

Outdoor applications: It is strongly recommended and will come as standard unless requested to not be included.

If the cable & power supply connection location is suitable waterproofed to prevent any water ingress, then the ferrule is not required. However, if water ingress does occur it is not covered under warranty.

WHAT IF THE FERRULE DOESN'T FIT IN MY INSTALLATION?

Is it important to check and plan with on-site installers before ordering the product. The ferrule is larger than the cable and is an important consideration when planning installations - refer to diagrams on connection pages for dimensions.

If required, the ferrule can be left off at time of production, **however** the on-site installers/client will need to provide adequate waterproofing of cable and cable connection to the power supply to ensure there is no water ingress and any failures from this cause will not be covered by the warranty.

CAN I CUT IT OFF?

Not recommended. The ferrule is fitted 115mm from the connector (except underwater), so cutting it off doesn't leave much cable to work with.

Cutting off the ferrule will also void any warranty cover from failure due to water ingress.

UNDERWATER USE

For underwater use with IP68 injection connections, a minimum cable length of 3 metres is standard to ensure that the cable to power connection is located away from the water.

When using the anti-wicking ferrule for underwater applications, ensure that it is located above & away from water and in a waterproof location to prevent water ingress.

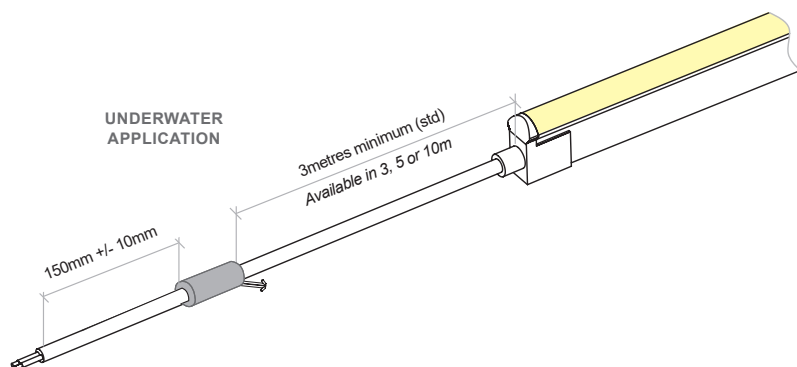

CALL US TO DISCUSS USING INJECTION
MOULDING FOR YOUR NEXT PROJECT

NEON ARC | SILICONE | FACTORY INJECTION CONNECTIONS

Bright Light recommend using Slimline injection moulding for the best result, a clean finish and IP68 rating. These are fitted at factory during the production process and can not be altered once produced - **ensure all lengths are double-checked before ordering.**

Power feed connectors are priced & supplied with 1metre cable as standard. Please specify at time of quoting if alternate lengths are required.

SLIMLINE INJECTION MOULDING CONNECTIONS | IP68



REQUIRES FITTING AT FACTORY.
LEAD TIMES APPLY.
CONNECTOR TOLERANCE +/-0.5MM

WHITE / DIM TO WARM / TUNEABLE WHITE
WHITE 6W/M SAUNA (IP67 ONLY)
RGB / RGB CHASING / RGBW

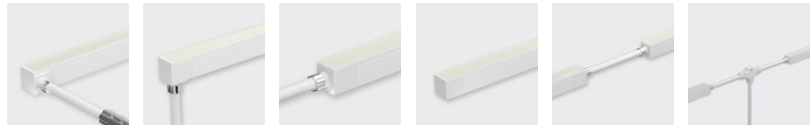

SIDE FEED BOTTOM FEED TOP END FEED END CAP FLEXIBLE CONNECTOR T FEED

WHITE / DIM TO WARM / TUNEABLE WHITE	●	●	●	●	●	●
WHITE 6W/M SAUNA (IP67 ONLY)	●	●	●	●	●	●
RGB / RGB CHASING / RGBW	●	●	●	●	●	●

SIDE FEED

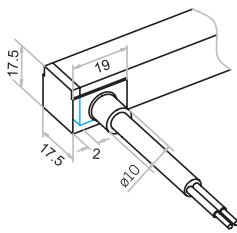

BOTTOM FEED

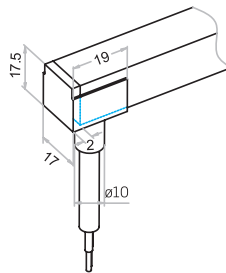

TOP END FEED

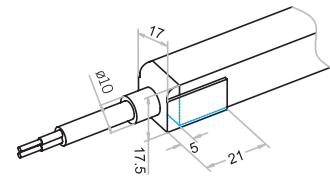

END CAP

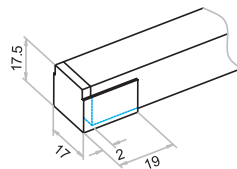

FLEXIBLE CONNECTOR

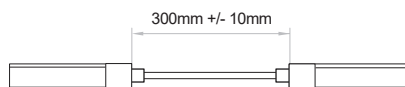

T-FEED

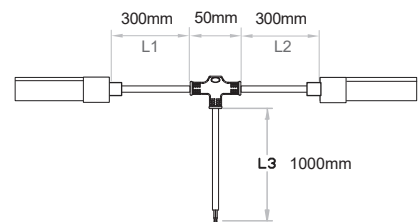

ANTI-WICKING FERRULE

(INCLUDED FOR ALL INJECTION CONNECTIONS)

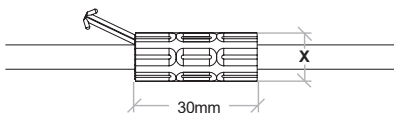

X = 12mm (White) OR
15mm (Tuneable white / RGB / RGBW / RGB Chasing)

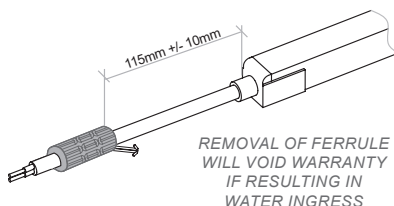

REMOVAL OF FERRULE
WILL VOID WARRANTY
IF RESULTING IN
WATER INGRESS

NEON ARC | SILICONE | SNAP CONNECTIONS

If on-site cutting is required (due to lengths being unknown in advance or site design alterations), Snap connector fittings are available for some colour types. Snap Connectors can be fitted on-site and offer an IP67 rating (provided all installation instructions are followed correctly).

Power feed connectors are supplied with 1metre cable.

SNAP CONNECTIONS | IP67



SUITABLE FOR OUTDOOR APPLICATIONS. MUST BE FITTED CORRECTLY FOR IP67 RATING

STANDARD INSTALLATION WITH SINGLE POWER FEED:
FEED 01 + END CAP 02 OR FEED 02 + END CAP 01

DOUBLE POWER FEED: FEED 01 + FEED 02
CONNECTOR TOLERANCE +/-0.5MM



TOP END FEED

01 02



END CAP

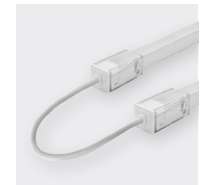

FLEXIBLE CONNECTOR

WHITE / DIM TO WARM

BL-LS-4808

BL-LS-4809

BL-LS-4811

BL-LS-4810

TUNEABLE WHITE / SAUNA / RGB / RGB CHASING / RGBW

NOT AVAILABLE

TOP END FEED

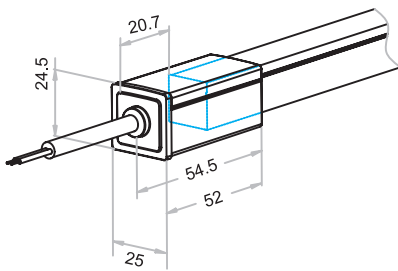

END CAP

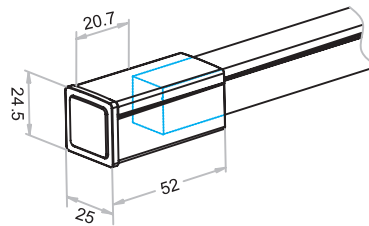

FLEXIBLE CONNECTOR

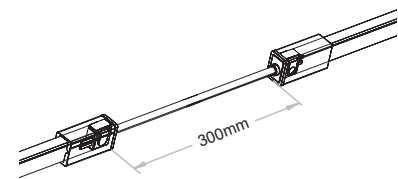

ANTI-WICKING FERRULE

(INCLUDED FOR SNAP TOP END FEED)

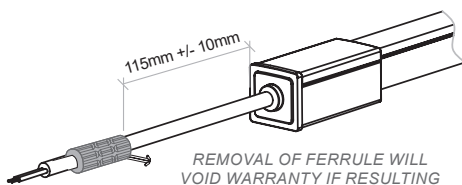
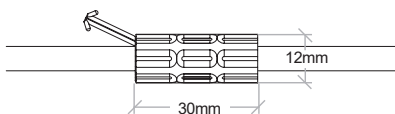

REMOVAL OF FERRULE WILL VOID WARRANTY IF RESULTING IN WATER INGRESS