

T3 2.4G LED RGB Controller



T3 is the 2.4GHZ RF wireless synchronization RGB controller which adopts LTECH multiple global initiate technology. The control system consists of two parts, the RF remote control and receiver; realize the signal synchronization on unlimited receivers within effective distance, a very good solution for the LED project needs sync control wirelessly. User-friendly full-color touch wheel for color selection, unique LED state light for sync change indicated, user can simply know the LED working state from distance by checking the remote control.

Can RF remote control the functions of switch, pause, changing modes, changing speed and the brightness and so on. Built-in 32 changing modes, you can save the changing modes in the shortcut key as you like, which not only can call at any time, but also can combine into a program to play in loop.

1. Technical Specs:

T3 Remote Control

- Input Voltage: DC5V Built-in Lithium Battery
- Working Current: $\leq 30\text{mA}$
- Working Frequency: 2.4GHZ
- RF Remote Distance: 30m
- Remote Option: Sync control unlimited receivers
- Change mode: 32 Fantastic modes
- Scale levels: 1024×1024×1024
- Battery Capacity: 1000mAh
- Standby Time: ≤ 6 Months
- Dimensions: L145×W55×H22(mm)
- Package Size: L168×W102×H28(mm)
- Weight (G.W.): 200g

T3-5A CV Receiving controller

- Input voltage: DC12V-DC24V
- Max current load: 5A×3CH Max 15A
- Max output power: 180W/360W(12V/24V)
- Control button: 8 touch button
- Compatible remote control: workable with T3, T3M, T3X
- Working temperature: $-30^{\circ}\text{C} \sim 55^{\circ}\text{C}$
- Dimension: L211×W40×H30mm
- Package size: L215×W42×H32mm
- Weight (G.W.): 180g

T3-CV Receiving controller

- Input voltage: DC5V-DC24V
- Max current load: 6A×3CH Max 18A
- Max output power: 90W/216W/432W(5V/12V/24V)
- Compatible remote control: T1/T2/T2M/T3/T3M/T3X
- Working temperature: $-30^{\circ}\text{C} \sim 55^{\circ}\text{C}$
- Dimension: L175×W44×H30(mm)
- Package size: L178×W48×H33mm
- Weight (G.W.): 110g

T3-CC Receiving controller (current 3 in 1)

- Input voltage: DC12V-DC48V
- Output voltage: DC3V-DC46V
- Output current: CC 350/700/1050mA ×3CH
- Output power: 1.05W~48.3W ×3CH Max 144.9W
- Compatible remote control: T1/T2/T2M/T3/T3M/T3X
- Working temperature: $-30^{\circ}\text{C} \sim 55^{\circ}\text{C}$
- Dimension: L175×W44×H30(mm)
- Package size: L178×W48×H33mm
- Weight (G.W.): 110g

1

2. Product Size:

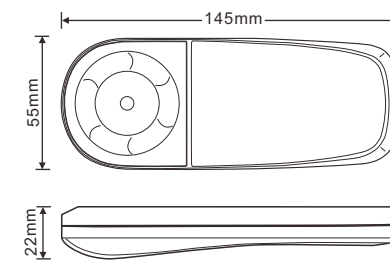

T3 RF remote control

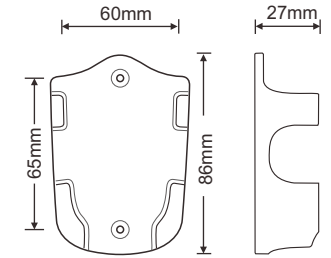

Remote holder

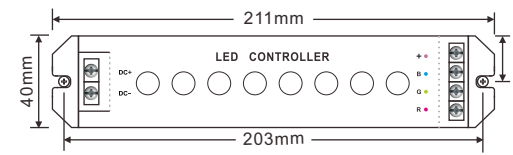

T3-5A

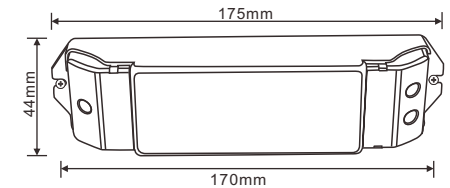

T3-CV/T3-CC

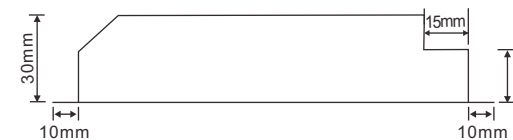

3. The learning ID method of remote control:

T3-5A learning ID:

1. Turn on the receiver and remote control.
2. Press "on/off button" on the T3-5A for 2 seconds, there is a buzzer sound, and do not release your hand on the button, at the same time press any keys on the remote control(except on/off key), until the green indicator light of remote control flashes 3 times(the long buzzer ring at the same time), learning ID successful, release all the keys.

If you have to control many receivers synchronously, each receiver should be learning ID according to the above steps learning ID.

T3-5A cancelling ID:

1. Turn on the receiver and remote control.
2. Press "on/off button" on the T3-5A for 2 seconds, there is a buzzer sound, and do not release your hand on the button, after 5 seconds press any keys on the remote control(except on/off key), until the red indicator light of remote control flashes 3 times(the long buzzer ring at the same time), release all the keys.

T3-CC/T3-CV learning ID:

1. Turn on the receiver and remote control.
2. Short press "ID learning button" on the T3-CC/T3-CV receiver, the running light keeps on, then long press any keys (except on/off key) on the remote, the running light returns to flash (the buzzer long beep, the green light flashes 3 times), activated successful.

T3-CC/T3-CV cancelling ID:

1. Turn on the receiver and remote control.
2. Press "ID learning button" on the receiver more than 8 seconds, the buzzer beep twice, delete all the learned remote.

If you have to control many receivers synchronously, each receiver should be learning ID according to the above steps learning ID.

2

4. Operation Panel and Component Instruction:

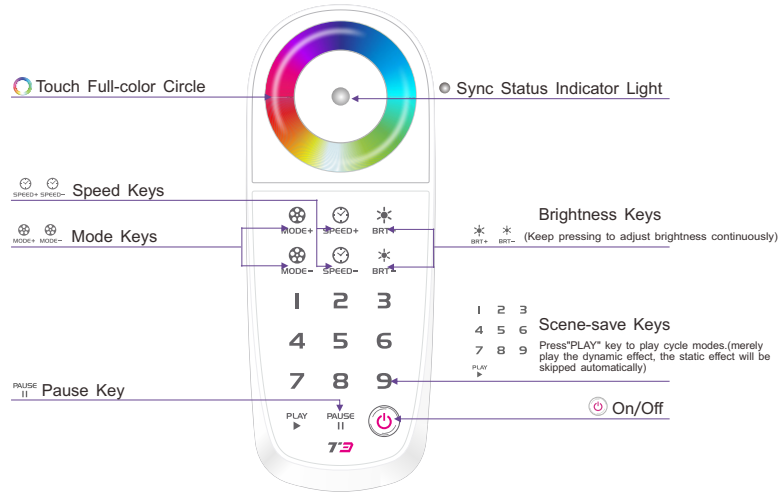

★Press "Pause" key in 3 seconds, the buzzer can be on or off.

5. Other Special Functions:

A. Reset Function:

Feature: Reset function is available when remote operates abnormally.

Operation: Long press simultaneously, release the 2 keys after 3 seconds, the remote will auto off, means reset completed. and then could restart the remote.

B. Check and Edit the Frequency Point on the Remote:

Feature:

- a. Revising the frequency point to eliminate the external disturbance. 12 revisable frequency points for user.
- b. Multiple remotes sync-control becomes available when they use the same frequency point.

Attn: After reset or revised the frequency points in the remote, receivers only can be used after relearn the ID.

Check the Frequency Point on the Remote:

Turn on the remote, long press the on/off key for 5 seconds until the red light flashes 3 times, and then the green light flashes, the numbers of the green flash will be the frequency point of the remote. you can only edit the frequency point after 3 seconds.

Edit the Frequency Point on the Remote: In frequency changing state

Method 1: short press any key from 1-9, the frequency point will be 1-9 correspondingly, the green light will flash in the same numbers. Press again any key or touch the color circle to exit the frequency edit state.

Method 2: long press "on/off" key over 5 seconds, the green light flashes, the flash times plus 1 means the frequency point accumulate 1. In short, long press the "on/off" key 5 seconds each time, the frequency point will accumulate 1, which will again become value 1 when added to 12, and that cycle repeats.

6. Tables of Changing Mode:

No.	Mode	Description	No.	Mode	Description
1	Static Red	Brightness Adjustable	17	Cyan Fade out and Fade in	Speed/Brightness Adjustable
2	Static Green	Brightness Adjustable	18	White Fade out and Fade in	Speed/Brightness Adjustable
3	Static Blue	Brightness Adjustable	19	RGB Fade out and Fade in	Speed/Brightness Adjustable
4	Static Yellow	Brightness Adjustable	20	Red Green Color Smooth	Speed/Brightness Adjustable
5	Static Purple	Brightness Adjustable	21	Red Blue Color Smooth	Speed/Brightness Adjustable
6	Static Cyan	Brightness Adjustable	22	Green Blue Color Smooth	Speed/Brightness Adjustable
7	Static White	Brightness Adjustable	23	Red Yellow Color Smooth	Speed/Brightness Adjustable
8	RGB Skipping	Speed/Brightness Adjustable	24	Green Cyan Color Smooth	Speed/Brightness Adjustable
9	7 Colors Skipping	Speed/Brightness Adjustable	25	Blue Purple Color Smooth	Speed/Brightness Adjustable
10	White Strobe	Speed/Brightness Adjustable	26	Green Yellow Color Smooth	Speed/Brightness Adjustable
11	7 Colors Strobe	Speed/Brightness Adjustable	27	Blue Cyan Color Smooth	Speed/Brightness Adjustable
12	Red Fade out and Fade in	Speed/Brightness Adjustable	28	Red Purple Color Smooth	Speed/Brightness Adjustable
13	Green fade out and Fade in	Speed/Brightness Adjustable	29	Blue White Color Smooth	Speed/Brightness Adjustable
14	Blue Fade out and Fade in	Speed/Brightness Adjustable	30	Yellow Purple Cyan Color Smooth	Speed/Brightness Adjustable
15	Yellow Fade out and Fade in	Speed/Brightness Adjustable	31	RGB Color Smooth	Speed/Brightness Adjustable
16	Purple Fade out and Fade in	Speed/Brightness Adjustable	32	Full-color Smooth	Speed/Brightness Adjustable

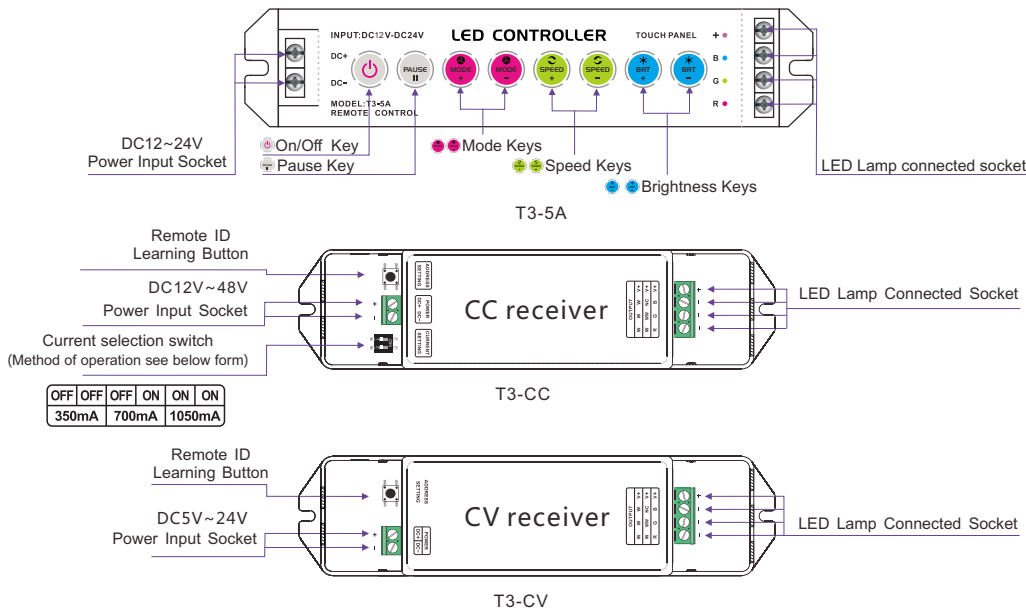

7. System Diagram:

Unlimited receivers can be installed within effective distance, no wiring needed between the receivers, which can be less or more in quantity according to your need for the installation, if you want to increase or decrease the receivers, just activate or cancel the control ID on the remote control will be fine, no any changes and effects on other receivers.

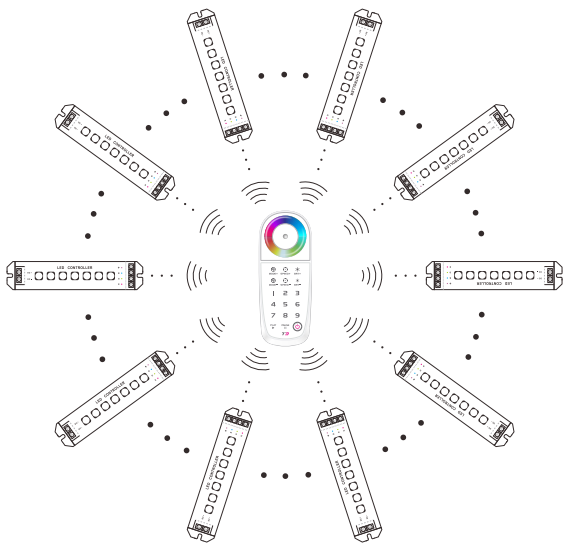

8. Wiring Diagram:

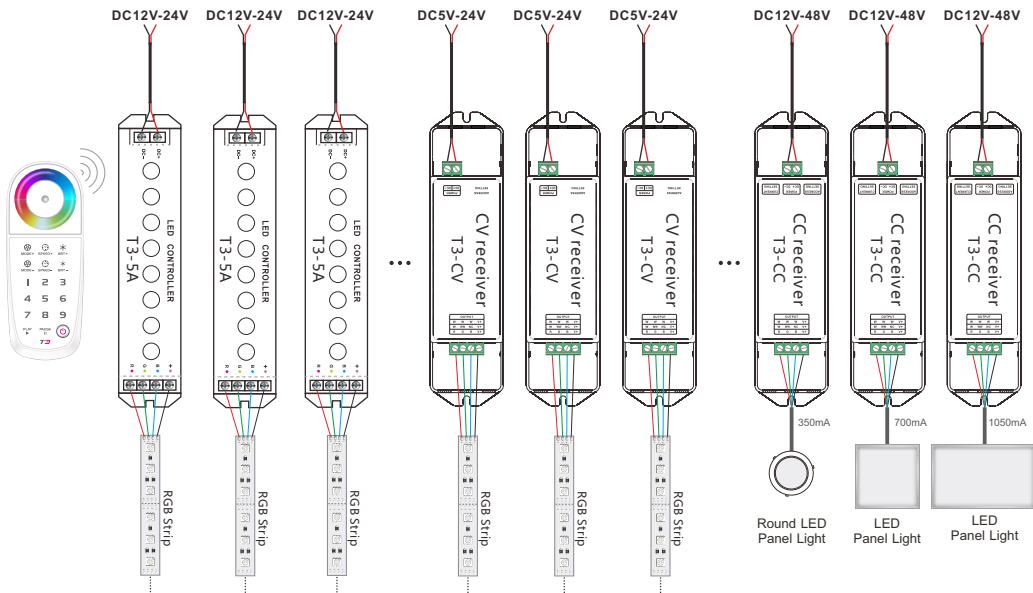

9. The Charging Methods for Remote Control:

1. When charging, please connect USB cable to the mobile charger or computer with the USB interface.
2. The blue indicator light flickers while charging, and turns green means the charging is completed. The remote control can be chargeable even at the OFF state, on which the indicator light is dark.
3. No memory effect in the lithium battery of remote control. Follow the standard charging procedure even for the first three times, no need over charge.
4. Red indicator light flickers meaning low battery and need to be charged. charging in low battery will affect life of battery.
5. The remote should be full charged and stored under low cold drying while a long time without being operated. And please full recharge every 3 months.

10. Attention:

1. The product shall be installed and serviced by a qualified person.
2. This product is non-waterproof. Please avoid the sun and rain. When installed outdoors please ensure it is mounted in a water proof enclosure.
3. Good heat dissipation will prolong the working life of the controller. Please ensure good ventilation.
4. Please check if the output voltage of any LED power supplies used comply with the working voltage of the product.
5. Please ensure that adequate sized cable is used from the controller to the LED lights to carry the current. Please also ensure that the cable is secured tightly in the connector.
6. Ensure all wire connections and polarities are correct before applying power to avoid any damages to the LED lights.
7. If a fault occurs please return the product to your supplier. Do not attempt to fix this product by yourself.

11. Warranty Agreement:

1. We provide lifelong technical assistance with this product:
 - A 5-year warranty is given from the date of purchase. The warranty is for free repair or replacement and covers manufacturing faults only.
 - For faults beyond the 5-year warranty we reserve the right to charge for time and parts.
2. Warranty exclusions below:
 - Any man-made damages caused from improper operation, or connecting to excess voltage and overloading.
 - The product appears to have excessive physical damage.
 - Damage due to natural disasters and force majeure.
 - Warranty label, fragile label and unique barcode label have been damaged.
 - The product has been replaced by a brand new product.
3. Repair or replacement as provided under this warranty is the exclusive remedy to the customer. LTECH shall not be liable for any incidental or consequential damages for breach of any stipulation in this warranty.
4. Any amendment or adjustment to this warranty must be approved in writing by LTECH only.

★This manual only applies to this model. LTECH reserves the right to make changes without prior notice.