

MCU-V4CCT

*Dimmer for constant voltage LEDs. Tunable white CCT control.
12-24Vdc. Max 4A (X 2CH), RX 433,92MHz and 1 wired input*

NEXTA
T E C H

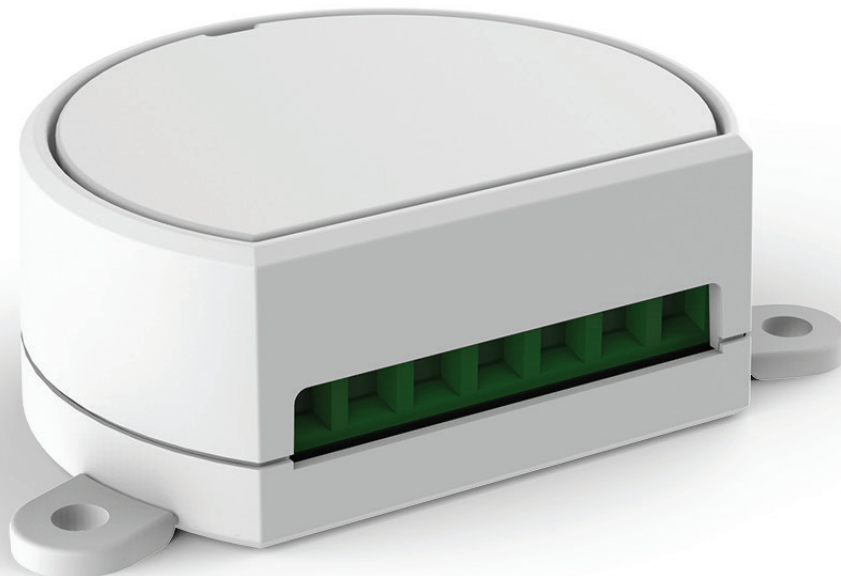

INDEX

1 - PRODUCT FEATURES

- 1.1 - TECHNICAL DATA
- 1.2 - DESCRIPTION

2 - ELECTRICAL CONNECTIONS

- 2.1 - CONNECTION DIAGRAM
- 2.2 - DESCRIPTION OF CONNECTIONS

3 - USE OF THE CONTROL UNIT

- 3.1 - USE VIA RADIO
- 3.2 - USE VIA WIRE

4 - CONTROL UNIT SETTINGS

- 4.1 - OPERATING MODE (TYPE OF LOAD CONTROL)
- 4.2 - FADE SETTING: GRADUAL SWITCH ON
- 4.3 - FADE SETTING: GRADUAL SWITCH OFF
- 4.4 - "SAVE" FUNCTION (BRIGHTNESS LEVEL AT SWITCH-ON)
- 4.5 - TIMED ON
- 4.6 - LOAD STATE WHEN THE CONTROL UNIT IS SWITCHED ON
- 4.7 - FACTORY SETTING

5 - RADIO PROGRAMMING

6 - DELETION OF TRANSMITTERS

7 - FURTHER DETAILS

- 7.1 - BEHAVIOUR OF THE "TUNABLE WHITE CYCLE"
- 7.2 - "SOFT OFF 1 HR" FUNCTION

WARNINGS

- Installation must be carried out only by qualified technicians in compliance with the electrical and safety standards in force.
- All connections must be made with the power turned off.
- Use suitable cables.
- Do not cut through the aerial (see picture 1.1b)
- A suitably sized disconnection device must be set up on the electric power line that supplies the product.
- Disposal of waste materials must fully respect local standards.

1 - PRODUCT FEATURES

1.1 TECHNICAL DATA

Power supply	12-24 Vdc
Output	Max load 4A: 48 W (with 12Vdc) per output 96 W (with 24Vdc) per output
Type of load	Cold+hot constant voltage white LED CCT Strip Warm white led strip + Cold white led strip
N° programmable transmitters	30
Radio frequency	433.920mhz ISM
Protection rating	IP20
Operating temperature	-20 +55 °C
Dimensions	52x43x21 mm

Pic.1.1a

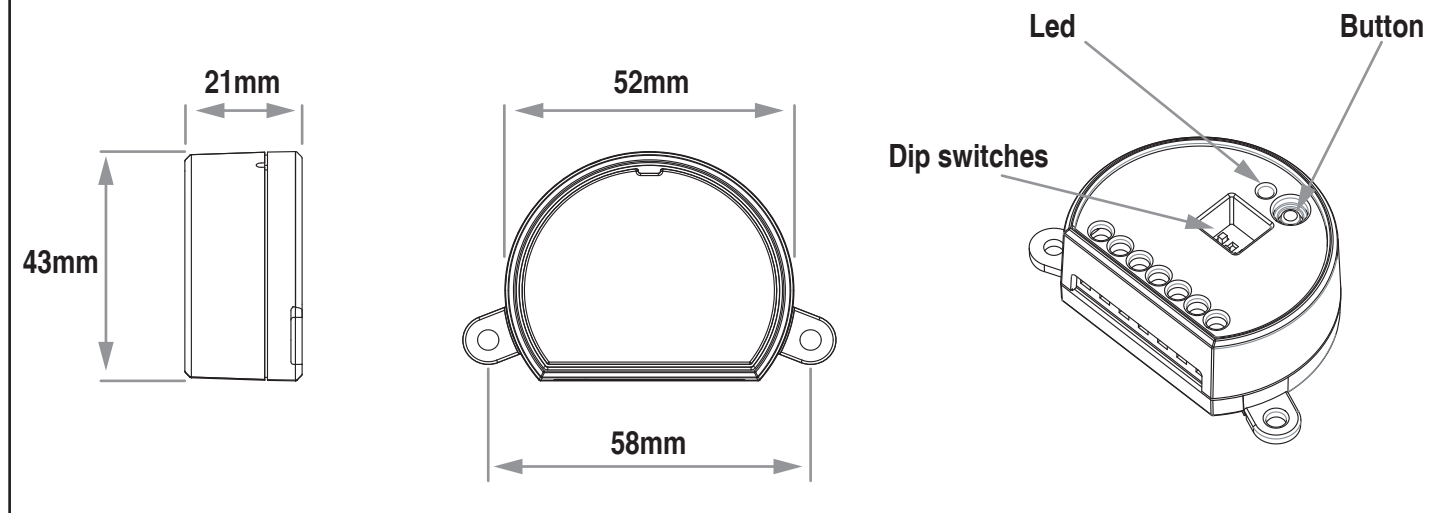

Pic.1.1b

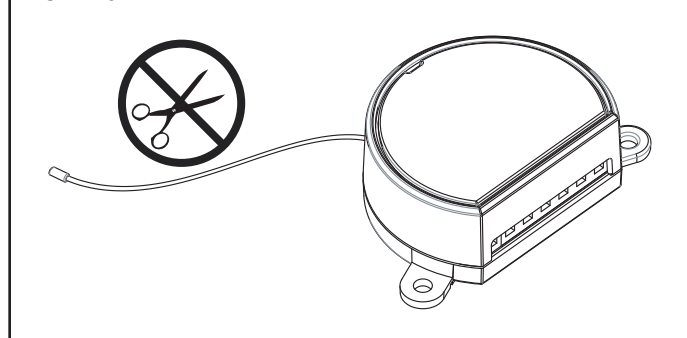

Pic.1.1c

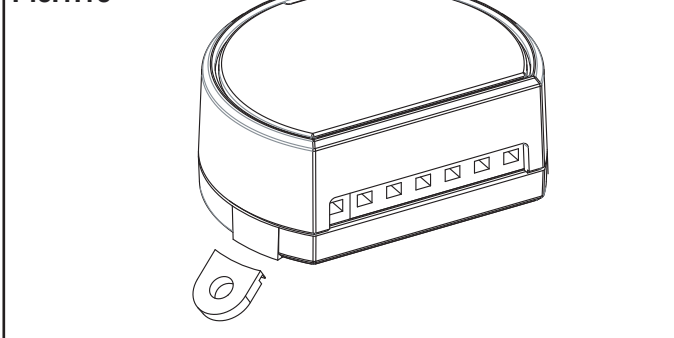

1.2 DESCRIPTION

This device is the electronic control unit with Dimmer function for wireless and wired control of LEDs with constant voltage. Designed for devices with dual LED (cold LED + hot LED), thanks to the mixing of these two components it is possible to adjust the temperature of the light (CCT correlated colour temperature).

One wired input with button, wide-ranging and accurate dimmer function; fade on and off that can be set to between 0 and 10 seconds.

The ISM (industrial, scientific and medical) radio frequency band guarantees a long range, even through walls and ceilings. Simple programming with dip-switch, reduced dimensions with breakable tabs for fixing with screws or for insertion into interconnection boxes with 55 mm diameter.

Pic.1.2a

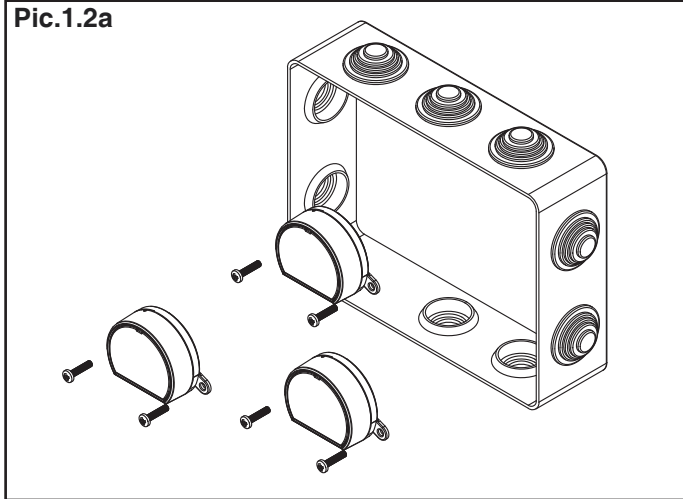

Pic.1.2b

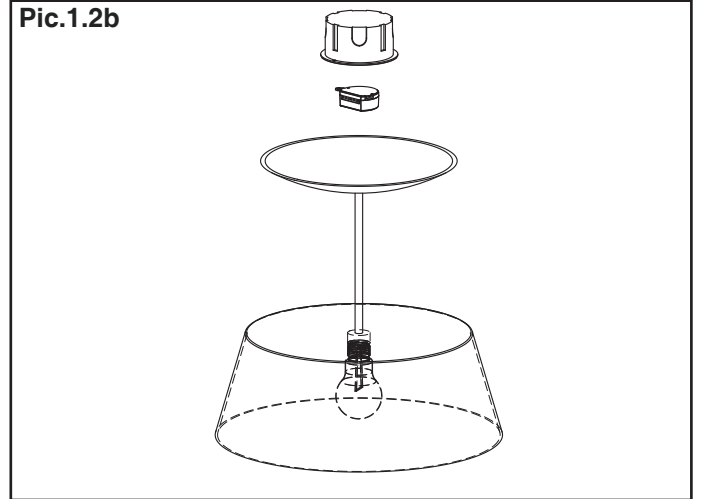

Pic.1.2c

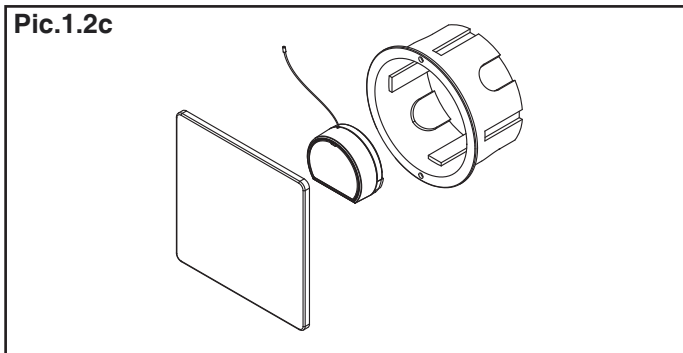

Pic.1.2d

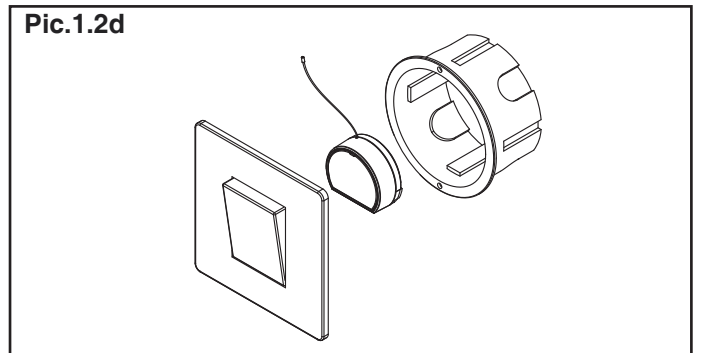

Pic.1.2e

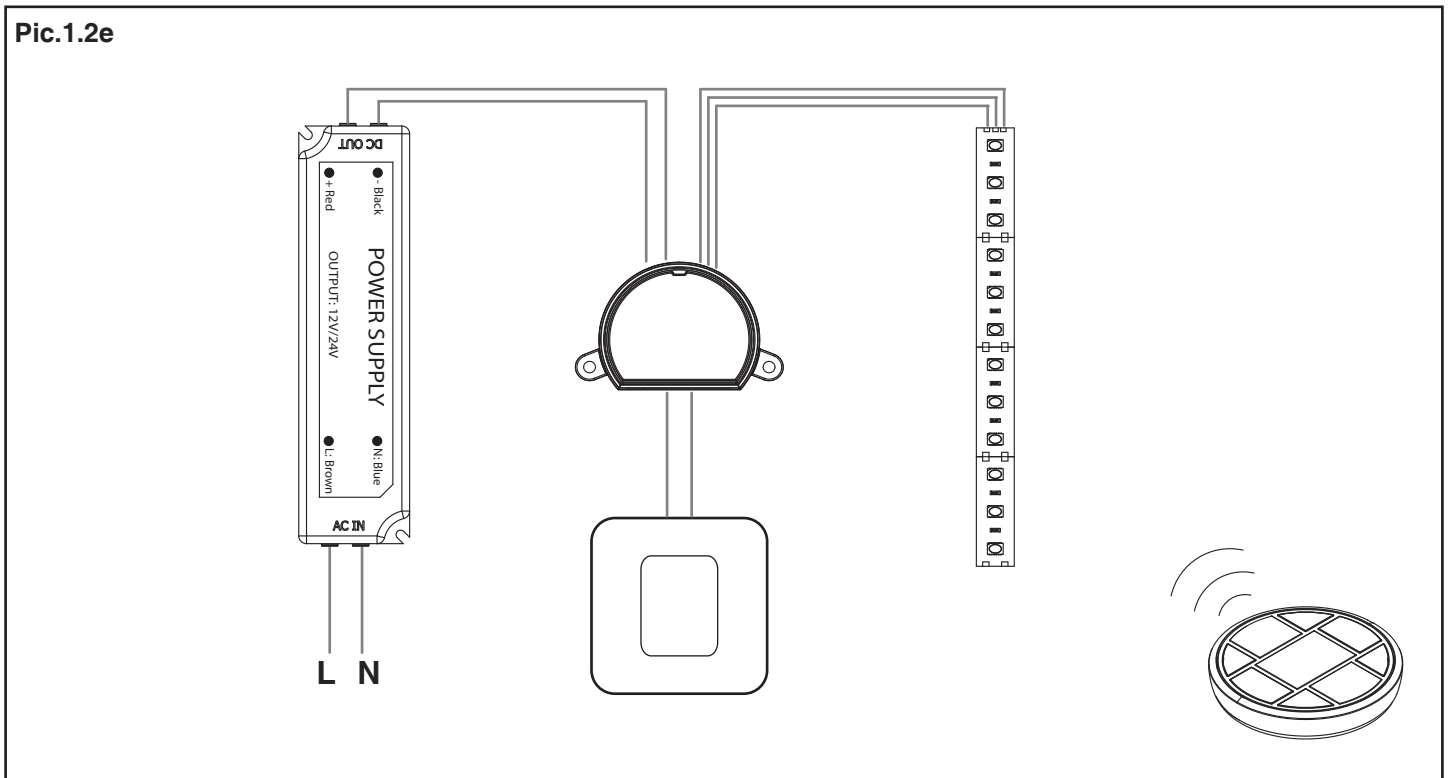

2 ELECTRICAL CONNECTIONS

2.1 CONNECTION DIAGRAM

Fig.2.1

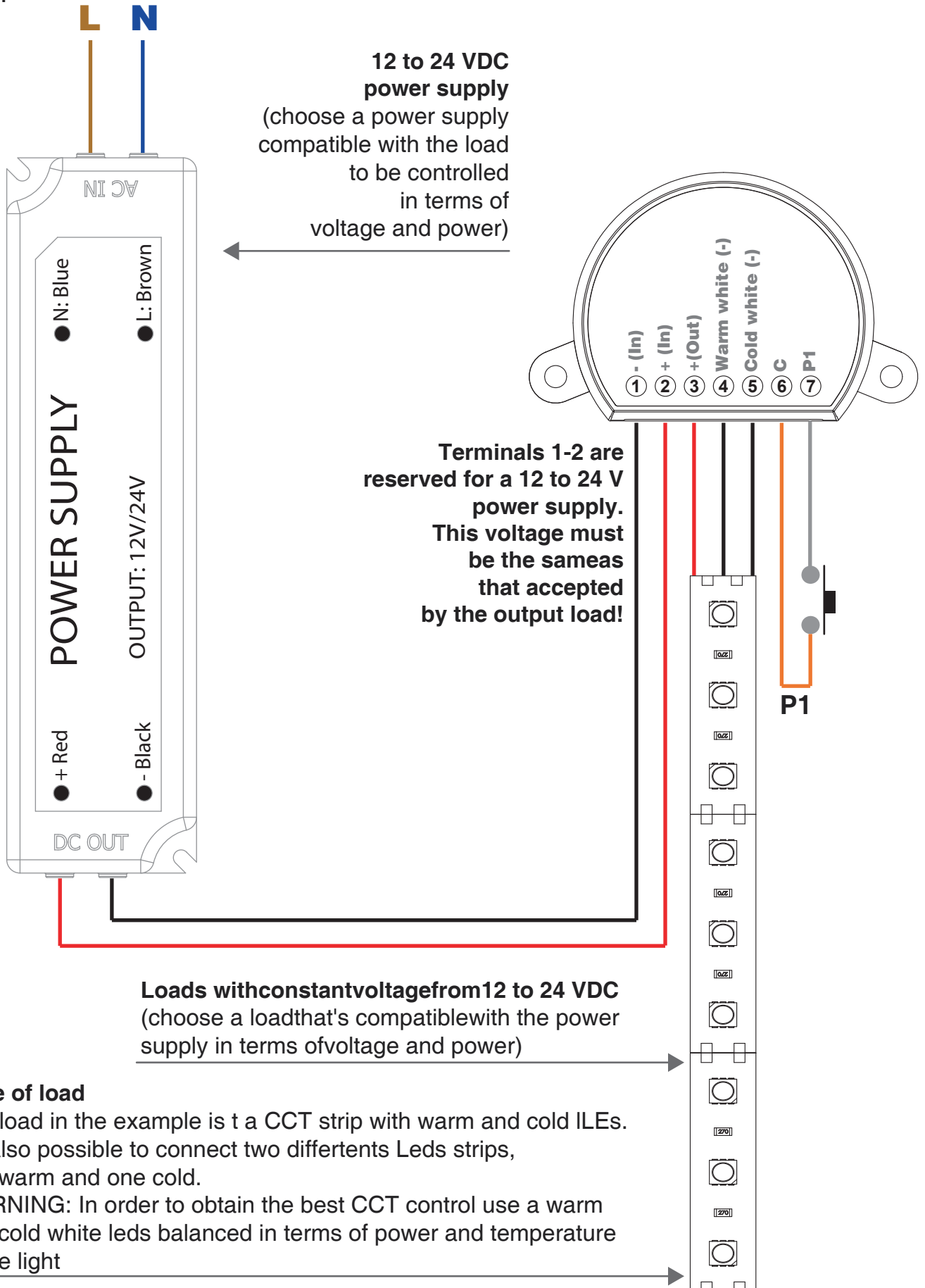

Type of load

The load in the example is a CCT strip with warm and cold LEDs. It's also possible to connect two different LED strips, one warm and one cold.

WARNING: In order to obtain the best CCT control use a warm and cold white LEDs balanced in terms of power and temperature of the light

2.2 DESCRIPTION OF CONNECTIONS

- Use wires with a suitable cross-section for the load connected.
- Multiple buttons can be connected by using parallel cabling.
- Multiple loads can be connected to the same output by using parallel cabling.

TERMINAL	DESCRIPTION
1	Power supply -
2	Power supply + (12-24)
3	Output +
4	Output warm white
5	Output cold white
6	Common for buttons
7	Button

3 USE OF THE CONTROL UNIT

3.1 USE VIA RADIO

To control the loads via radio you must have compatible transmitters and therefore must carry out the association procedure, see paragraph 5.

The transmitter's control modes depend on the transmitter model used.

If the transmitter is of a generic type, its operation depends on the way it is programmed (see paragraph 5, table 5.2a). If the transmitter is multifunctional, refer to the transmitter manual, to the paragraph entitled "commands sent by the transmitter", bearing in mind that it is a "CCT" device.

3.2 USE VIA WIRE

The device is set up to accept commands via wire by button in terminals 6 and 7.

Should you want to control the load only via radio, it is not necessary to connect these devices for the control unit to work properly.

The behaviour of the key is shown in the following table:

	LOAD OFF	LOAD ON
INPUT P1: short press	On of load	Off of load
INPUT P1: long press	After 1 second, the temperature of cold light is dimmed towards warm light, cyclically. When the key is released the value is saved	Dimmer intensity up / Dimmer intensity down of load 1 MEMO= After 10 seconds of long press the temperature of light will be saved. This value is used every time the light is switched on (see paragraph 7.3)

NOTE: If don't send any memo command (see paragraph 7.3), the load will switch on at the last temperature value set before it was switched off

4 - CONTROL UNIT SETTINGS

4.1 OPERATING MODE (TYPE OF LOAD CONTROL)

Default: modo1

With these procedures it is possible to set the method of controlling the load from the control unit.

MODE 1: CONSTANT MAXIMUM POWER AS WHITE LIGHT TEMPERATURE IS VARIED

The control unit will achieve the change in temperature by balancing the two hot and cold components so as to maintain constant consumption and therefore not see any variations in intensity during the change in temperature.

Table 4.1a

SETTING COLD LIGHT	SETTING INTERMEDIATE	SETTING NEUTRAL LIGHT	SETTING INTERMEDIATE	SETTING WARM LIGHT
Warm Led= 0% Cold Led= 100%	Warm Led= 25% Cold Led= 75%	Warm Led= 50% Cold Led= 50%	Warm Led= 75% Cold Led= 25%	Warm Led= 100% Cold Led= 0%

NOTE: with this mode you must use a power supply unit of a power that is slightly above half of the loads.

EXAMPLE: if there are two loads at 50W, it is recommended you use a 60W power supply unit

MODO 2: VARIABLE MAXIMUM POWER AS WHITE LIGHT TEMPERATURE IS CHANGED

The control unit will achieve the change in temperature by always maintaining the maximum intensity available from the LEDs. Therefore if the temperature of the light is changed a change of intensity of the load will be noticed.

Table 4.1b

SETTING COLD LIGHT	SETTING INTERMEDIATE	SETTING NEUTRAL LIGHT	SETTING INTERMEDIATE	SETTING WARM LIGHT
Warm Led= 0% Cold Led= 100%	Warm Led= 30% Cold Led= 100%	Warm Led= 100% Cold Led= 100%	Warm Led= 100% Cold Led= 30%	Warm Led= 100% Cold Led= 0%

NOTE: with this mode you must use a power supply unit of a power that is slightly above the total of the loads. EXAM-

PLE: if there are two loads at 50W, it is recommended you use a 110W power supply unit

PROCEDURE

STEP 1
Position DIPs 1, 2, 3 and 4 to OFF-OFF-OFF-OFF.

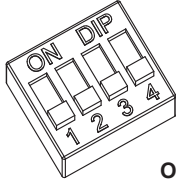

DIP 1, 2, 3, 4=
OFF OFF OFF OFF

STEP 2
Press the button on the receiver for a short time.
The LED comes on

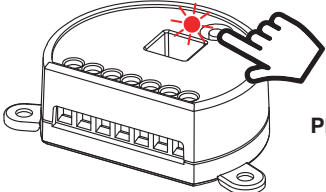

SHORT PRESSURE

MODE 1
(see table 4.1a)

MODE 2
(see table 4.1b)

STEP 3a
Position DIPs 3 to ON.
The LED flashes 9 times to confirm.

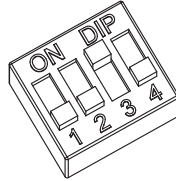

DIP 3=
ON

STEP 3b
Position DIPs 4 to ON.
The LED flashes 9 times to confirm.

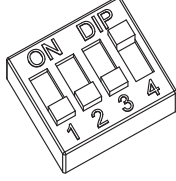

DIP4=
ON

4.2 FADE SETTING: GRADUAL SWITCH ON

Default: 0,5s

This procedure means you can set the duration of the switch-on time.

PROCEDURE:

STEP 1

Position DIPs 1, 2, 3 and 4 to ON-ON-OFF-ON.

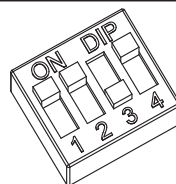

DIP 1, 2, 3, 4=
ON ON OFF ON

STEP 2

Press the button on the receiver for a short time.

The LED comes on and stays on.

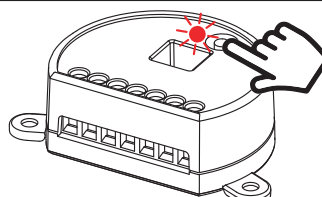

SHORT
PRESSURE

STEP 3

Press the button on the receiver for a short time count the number of flashes emitted by the LED:

FLASHES	SWITCH-ON TIME
1 flash	immediate ON
2 flashes	ON ~ 0,5s
3 flashes	ON ~ 2s
4 flashes	ON ~ 4s
5 flashes	ON ~ 10s

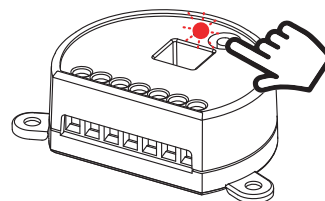

SHORT
PRESSURE

STEP 4

Press the button for a short time during the flash that corresponds to the function desired to end the count

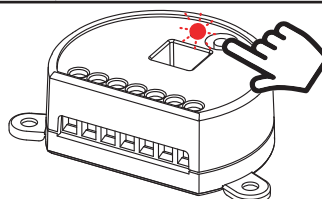

SHORT PRESSURE
DURING THE FLASH

4.3 FADE SETTING: GRADUAL SWITCH OFF

Default: 0,5s

This procedure means you can set the duration of the switch-off time.

PROCEDURE:

STEP 1

Position DIPs 1, 2, 3 and 4 to ON-OFF-OFF-ON.

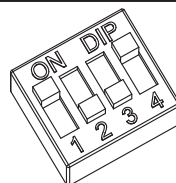

DIP 1, 2, 3, 4=
ON OFF OFF ON

STEP 2

Press the button on the receiver for a short time.

The LED comes on and stays on.

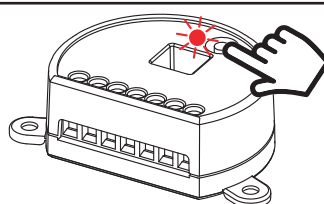

SHORT
PRESSURE

STEP 3

Press the button on the receiver for a short time count the number of flashes emitted by the LED:

FLASHES	SWITCH-OFF TIME
1 flash	immediate OFF
2 flashes	OFF ~ 0,5s
3 flashes	OFF ~ 2s
4 flashes	OFF ~ 4s
5 flashes	OFF ~ 10s

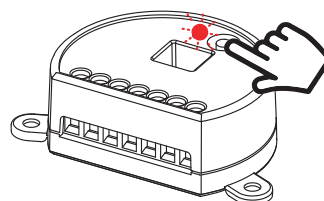

SHORT
PRESSURE

STEP 4

Press the button for a short time during the flash that corresponds to the function desired to end the count

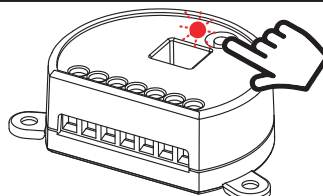

SHORT PRESSURE
DURING THE FLASH

4.4 "SAVE" FUNCTION (BRIGHTNESS LEVEL AT SWITCH-ON)

Default: save not on

With this procedure you can set the intensity value at which the load switches on.

PROCEDURE:

STEP 1

Position DIPs 1, 2, 3 and 4 to OFF-ON-OFF-ON.

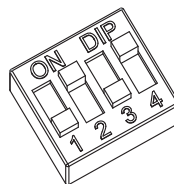

DIP 1, 2, 3, 4=
OFF ON OFF ON

STEP 2

Press the button on the receiver for a short time.

The LED comes on and stays on.

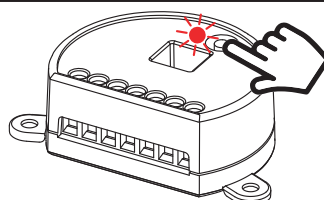

SHORT
PRESSURE

STEP 3

Press the button on the receiver for a short time.

Count the number of flashes emitted by the LED:

3 flashes= Last value set

6 flashes= Maximum brightness

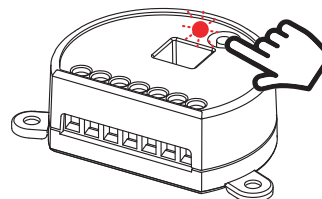

SHORT
PRESSURE

NUMBER OF FLASH	INTENSITY AT SWITCH-ON
3	Maximum brightness
6	Last value set

STEP 4

To change the setting, repeat the procedure from point 1; the control unit will alternate between 3 and 6 flashes.

4.5 TIMED ON

Default: No timing

This process is used to set the time for which the Leds stays on before an automatic switch off.

PROCEDURE:

STEP 1

Position DIPs 1, 2, 3 and 4 to OFF-OFF-OFF-ON.

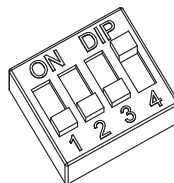

DIP 1, 2, 3, 4=
OFF OFF OFF ON

STEP 2

Press the button on the receiver for a short time.

The LED comes on and stays on.

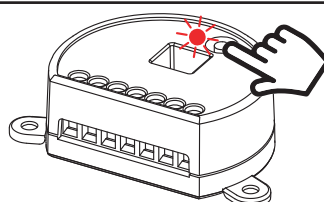

SHORT
PRESSURE

STEP 3

Press the button on the receiver for a short time count the number of flashes emitted by the LED:

FLASHES	TIMED ON
1 flash	No timing
2 flashes	1 minute
3 flashes	5 minute
4 flashes	15 minute
5 flashes	40 minute
6 flashes	1 hour
7 flashes	2 hours
8 flashes	3 hours
9 flashes	8 hours

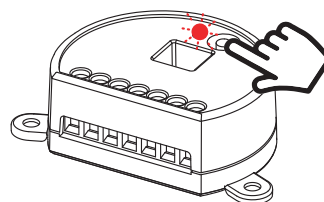

SHORT
PRESSURE

STEP 4

Press the button for a short time during the flash that corresponds to the function desired to end the count

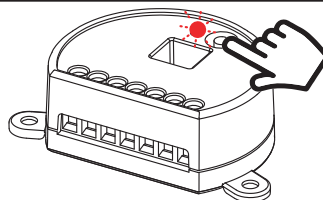

SHORT PRESSURE
DURING THE FLASH

4.6 LOAD STATE WHEN THE CONTROL UNIT IS SWITCHED ON

Default: Light Off

This process is used to set the state of Leds when the control unit is switched on (for example when the power supply is provided by a general switch or timer).

WARNING: the setting value can be "light off" in order to set the default.

PROCEDURE:

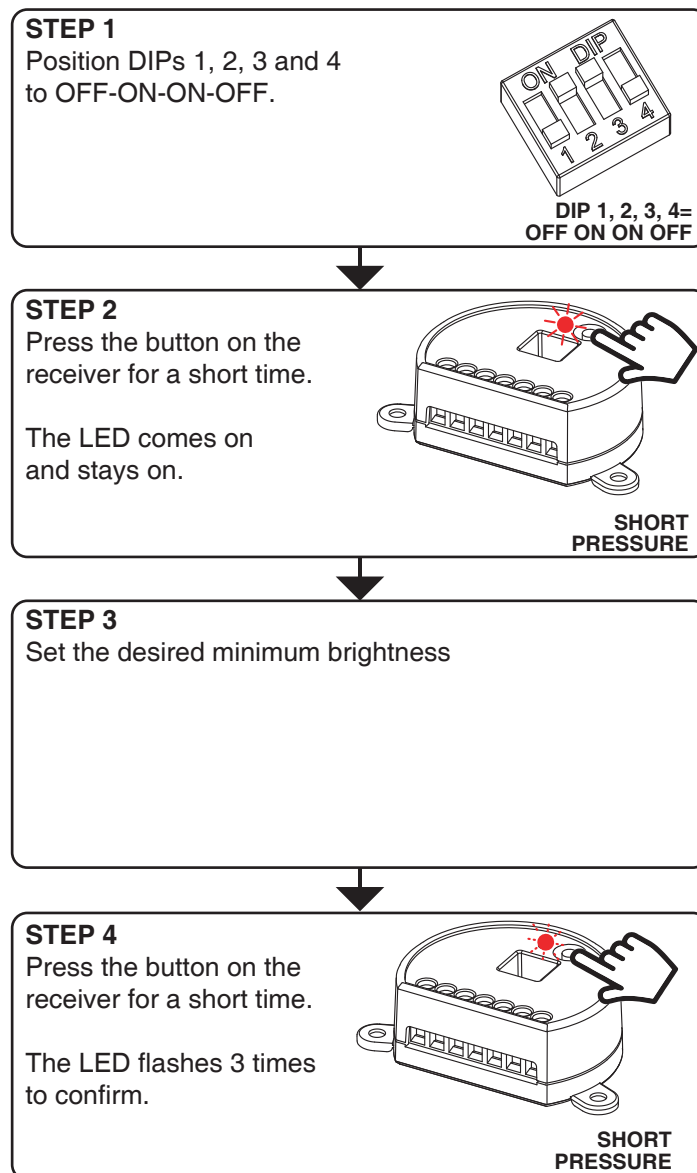

4.7 FACTORY SETTING

This procedure let you take the control unit back to factory settings.

FULL RESET OF THE CONTROL UNIT:

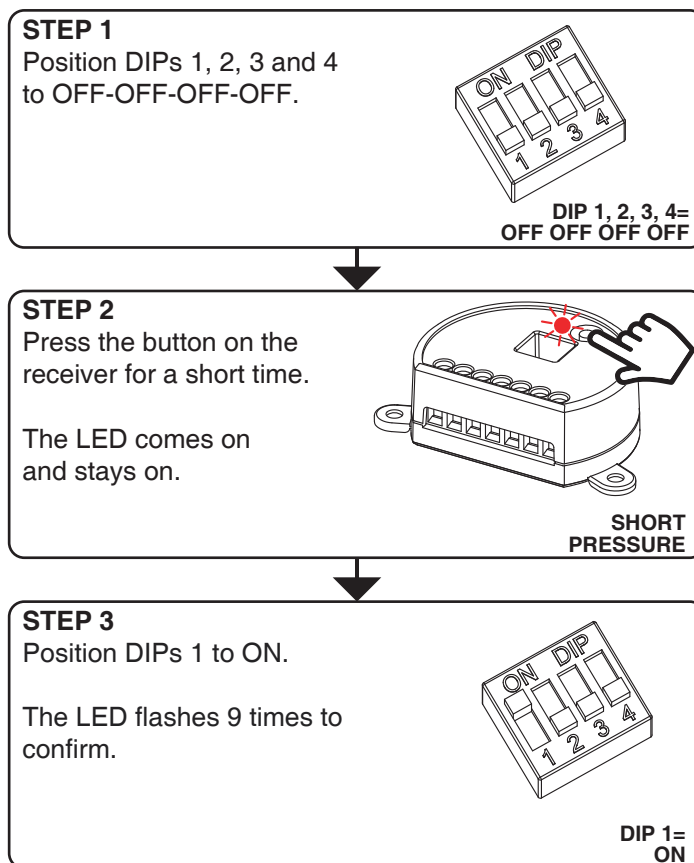

RESET PARAMETERS (NO DELETION OF RADIO MEMORY):

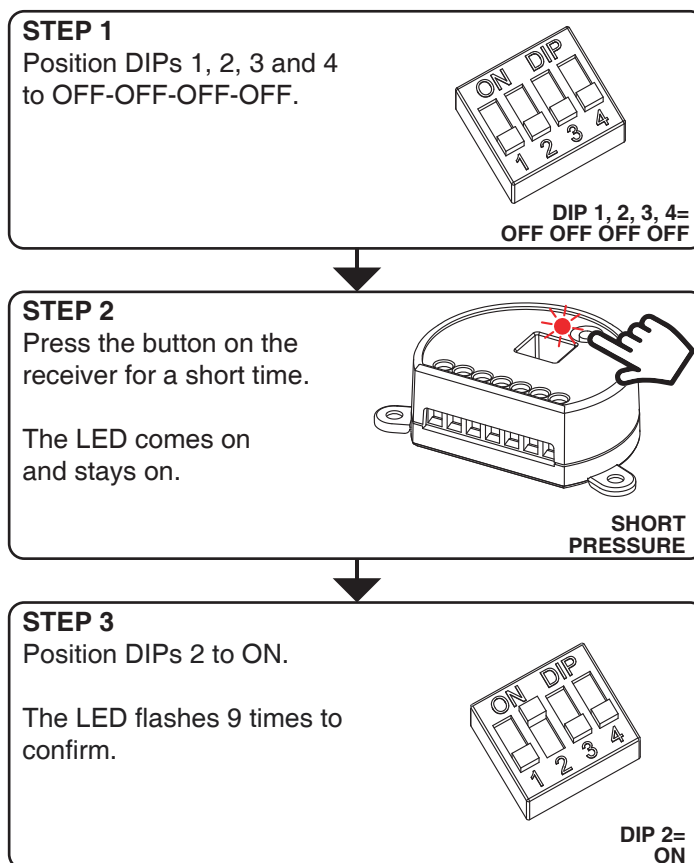

5 - RADIO PROGRAMMING

This procedure lets you programme compatible multifunctional or generic transmitters.

WHICH REMOTE CONTROL DO YOU WANT TO ASSOCIATE WITH THE CONTROL UNIT?

MULTIFUNCTIONAL TRANSMITTERS

CODES:

HB70-SLCT, HB70-SPCT,
 HB80-1C, HB80-1DIM, HB80-2L, HB80-30D, HB80-30RGBW, HB80-4C, HB80-4DIM, HB80-4L,
 HB90-6LT,
 ROUND-1SP,
 SENSА-M, SENSА-P, SENSА-R35M, SENSА-R35P, SENSА-R35T, SENSА-T,
 TOUCH-1, TOUCH-1CCT, TOUCH-1DIM, TOUCH-1SP, TOUCH-1L, TOUCH-1RGBW, TOUCH-3C, TOUCH-4DIM, TOUCH-CFU

With multifunctional transmitters the transmitter control modes depend on the model used. Refer to the transmitter manual, to the paragraph entitled "commands sent by the transmitter", bearing in mind that it is an "cct" device.

GENERIC TRANSMITTERS (WIRELESS BUS)









CODES:

HB80-6G,
 MCU-TX4,
 TOUCH-1G, TOUCH-2G, TOUCH-4G, TOUCH-LOCK4, TOUCH-TX2,
 ROUND-1G

With generic transmitters, the transmitter's control modes depend on the function associated with the key during the association procedure.

The available function for the key are:

TABLE 5.1 KEY FUNCTIONS OF THE GENERIC TRANSMITTER

POSITION OF DIP IN "STEP 1b" OF THE PROCEDURE	KEY FUNCTION	POSITION OF DIP IN "STEP 1b" OF THE PROCEDURE	KEY FUNCTION
 DIP: OFF ON ON ON	Short pressure= ON / OFF Long pressure= DIMMER UP / DIMMER DOWN	 DIP: OFF OFF ON OFF	Dimmer DOWN temperature of white light
 DIP: OFF OFF ON ON	OFF	 DIP: ON OFF ON OFF	Dimmer UP temperature of white light
 DIP: ON OFF ON ON	ON	 DIP: ON ON OFF OFF	Dimmer UP/DOWN temperature of white light
 DIP: ON OFF OFF OFF	Soft Off 1h: fade off in 1h. (see paragraph 7.2)	 DIP: OFF ON OFF OFF	Play / stop "cycle" (see paragraph 7.1)
		 DIP: ON ON ON OFF	Change duration of "cycle" (see paragraph 7.1)

PROCEDURE

WHICH TRANSMITTER DO YOU WANT TO PROGRAMME?

MULTIFUNCTION TRANSMITTER
(see models and codes on previous page)

GENERIC TRANSMITTER
(see models and codes on previous page)

STEP 1a

Position DIPs 1, 2, 3 and 4 to ON-ON-ON-ON

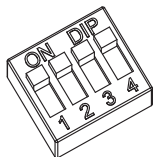

DIP 1, 2, 3 e 4=
ON ON ON ON

STEP 1b

Positions DIPs 1, 2, 3 and 4 according to the function you want to associate with the remote control key.
See table 5.1 on the previous page.

STEP 2

Press the button on the receiver for a short time.

The LED comes on and stays on.

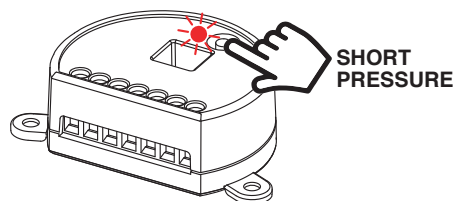

STEP 3

Make a transmission with the transmitter to be saved (see transmitter manual, paragraph entitled "transmitter programming").

The LED on the receiver flashes 3 times to signal that it has been received.



MAKE A TRANSMISSION WITH THE TRANSMITTER

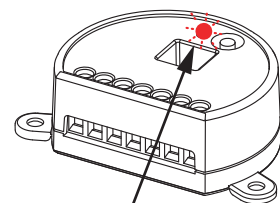

THE LED FLASHES 3 TIMES

STEP 4

The control unit listens for 30 seconds in case you want to add other transmitters.

To immediately exit the procedure give a short pressure on the button on the receiver.

The LED turns off

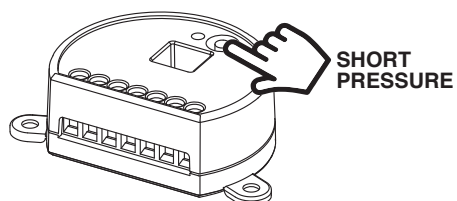

6 - DELETION OF TRANSMITTERS

These procedures let you delete from the memory transmitters that have already been programmed.

6.1 DELETION OF SINGLE TRANSMITTER

STEP 1

Hold the receiver button down for 8 seconds.

The LED begins to flash

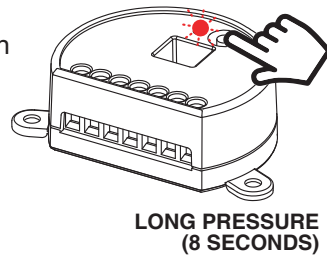

STEP 2

Make a transmission with the transmitter that you want to delete.

The LED flashes quickly and turns off.



MAKE A TRANSMISSION
WITH THE TRANSMITTER

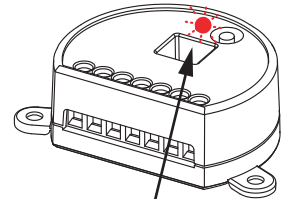

LED FLASHES QUICKLY

6.2 DELETION OF ALL THE SAVED TRANSMITTERS

STEP 1

Hold the receiver button down for 8 seconds.

The LED begins to flash

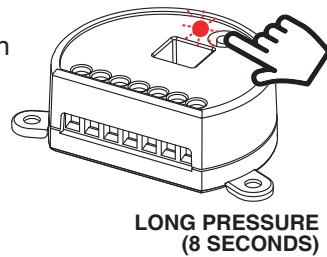

STEP 2

Press the button on the receiver for a short time.

The LED starts flashing quickly and turns off.

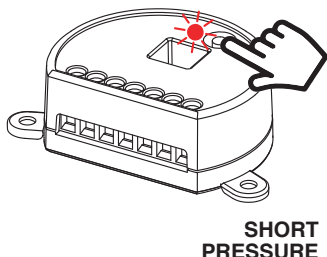

7 FURTHER DETAILS

The following paragraphs describe the ways the lights connected are commanded and controlled.

7.1 TUNABLE WHITE CYCLE

The "tunable white cycle" is an automatic and gradual changing of the temperature of light to create an effect.

The cycle can be played/stopped by sending commands:

- VIA RADIO WITH GENERIC TRANSMITTER: with a generic transmitter programmed with the "play/stop color cycle" function.

- VIA RADIO WITH MULTIFUNCTIONAL TRANSMITTER: with a compatible multifunctional transmitter

The way the command is sent depends on the transmitter model used, see the transmitter manual. With each press on one of these commands the load will:

flash once= play "color cycle"

flash twice= stop "color cycle"

CHANGE "COLOR CYCLE" DURATION

This function is used to adjust the duration of the colour cycle. At the end of the cycle with the time set it will start again from the beginning.

The duration of the cycle can be changed by sending commands:

- VIA RADIO WITH GENERIC TRANSMITTER: with a generic transmitter programmed with the "change color cycle duration" function

With each press on one of these commands the load will:

flash once= short 90 second "color cycle"

flash twice= long 15 minute "color cycle"

- VIA RADIO WITH MULTIFUNCTIONAL TRANSMITTER: with a compatible multifunctional transmitter

The way the command is sent depends on the transmitter model used, see the transmitter manual.

With multifunctional transmitter of table 7.1a can be set:

S1=10 secondi, S2=30 secondi, S3=90 secondi, S4=4 minuti, S5=15minuti e S6=un ora.

With multifunctional transmitter of table 7.1b can be set:

S1=10 secondi, S2=90 secondi, S3=15minuti e S4=un ora.

After sending a "change color cycle duration" command, the cycle will always be executed with the duration set. To change the duration of the cycle again, reset it as desired.

Tab. 7.1a

COMPATIBLE MULTIFUNCTIONAL TRANSMITTERS
<i>HB80-30RGBW</i>

Tab. 7.1b

COMPATIBLE MULTIFUNCTIONAL TRANSMITTERS
<i>HB80-4LRGBW</i>

7.2 "SOFT OFF 1 HR" FUNCTION: FADE OFF

The "Soft off 1 hr" function is a gradual fading off in one hour starting from the colour and intensity set at the time the command was sent.

This function can be activated after adjusting the colour and intensity as desired (via radio or wire):

- VIA RADIO WITH GENERIC TRANSMITTER: with a generic transmitter programmed with the "soft off 1 hr" function.

This gradual switch-off can be interrupted at any time by the sending of another command via radio or via wire.

7.3 "SAVE TEMPERATURE" FUNCTION

Default= the load will always switch on with the last set temperature

The "save temperature" function enables a temperature of light for the connected load to be saved, which can then be used every time it is switched on.

This function can be used after adjusting the temperature as desired (via radio or wire):

- VIA WIRE: with a prolonged press on the button connected to input "P1" (see paragraph 3.2 for the use of buttons via wire).

- VIA RADIO WITH MULTIFUNCTIONAL TRANSMITTER: with a compatible multifunctional transmitter (see table 7.3). The way the command is sent depends on the transmitter model used, see the transmitter manual.

Tab. 7.3

COMPATIBLE MULTIFUNCTIONAL TRANSMITTERS
<i>HB80-30RGBW, HB80-4LRGBW</i>

After sending a "save color" command, the load will always switch on with the colour and intensity saved.

To change the switch-on value:

- another "save color" value must be sent

- carry out the procedure described in paragraph 4.4



MNLMCU-V4CCTENV1.0

Nexta Tech

company brand of Team srl
via G.Oberdan 90, 33074
Fontanafredda (PN) - Italy
Ph. +39 0434 998682
Email: info@nexta-tech.com
Web: www.nexta-tech.com