

# LT-200 LED Digital Controller (2013 V1.0)



LT-200 controls LED with the following compatible ICs: LPD6803, LPD1101, D705, UCS6909, UCS6912, LPD8803, LPD8806, TM1804, TM1809, TM1812, UCS1903, UCS1909, UCS1912, UCS2903, TLS3001, TLS3002, Ws2801, WS2803, WS2811, WS2812, P9813.

Supporting international standard Protocol DMX512/1990 interface, with DMX administration mode to invoke the built-in functions for choosing mode, speed, brightness, types and direction changing. by DMX512 console. Furthermore, it has the DMX decoder mode, customers could use DMX512 console to program & control every channel of the LEDs with the compatible ICs listed above. (0-100% dimming range, program any lighting effect required)

Built-in LCD operator display, powerful but simple easy to use. Two ways to adjust modes, speed & brightness either by RF remote or controller itself. Auto timing. Max 540 modes selection.

## 1. Product Parameter:

### LT-200 LED Digital Controller(2013 V1.0)

• Working Voltage:	DC12V (with an adapter to covert AC100-240V to DC12V )	• Change mode:	540 modes
• Power consumption:	<2W	• Output signal:	1024 pixels
• Output signal:	SPI(TTL)	• Working temp.:	-30°C~65°C
• 3rd part port:	DMX512	• Dimension:	L163×W125×H40mm
• DMX channel :	DMX administration mode occupy 6 CHs DMX decoder mode 512 CHs	• Package Size:	L269×W129×H46mm
		• Weight (G.W):	760g

## 2. Performance Features:

- Built-in a LCD screen, it is easy to set up the parameters.
- Built-in perpetual calendar, real-time display system clock, can be set up to play different programs in any time, Monday to Sunday or holiday.
- Max combined 540 lighting effects, like seven colors, sync jumping and smooth, color flow, color chasing, smooth flow, meteor trailing, etc.
- Multilevel changing speed, brightness, RGB gray scale adjustment, effect of movement direction, etc. .
- Feel free to define many changing modes into a step, 8 independent cycle steps maximum.
- supporting 2 output ports: green terminals and signal & power combination terminal( load 20A current)
- Support third-party DMX512 interface, it can be realized DMX management mode, invoke controller's most function by DMX console
- Work as DMX-SPI decoder, using DMX512 console to control every channel and program new changing effect.

## 3. Construction Drawing:

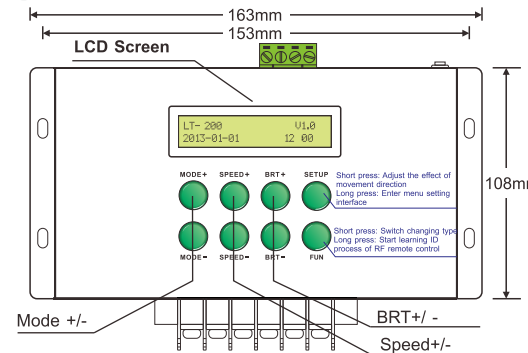

\*Long press Mode + to enter black change mode realizing power off, Long press Mode - to enter automatic change Mode 31.

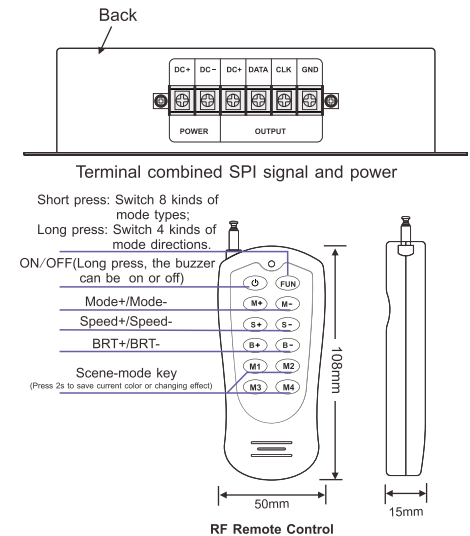
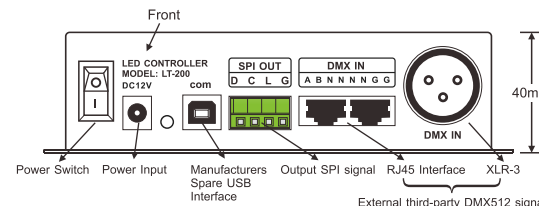

**The learning method for RF Remote control**  
Long Press the "FUN" key on the receiver, buzzer long sound, keep pressing the key.  
Press any key on the remote control in 3 seconds, activated successful between the remote control and the receiver.  
Press any key on the remote control in 3 seconds, cancelled successful between the remote control and the receiver.

## 4. Operating Instructions:

The controller has 8 function keys:

MODE+/MODE-(mode), SPEED+/SPEED-(speed), BRT+/BRT-(brightness), SETUP(setup), FUN(function)

### 1, Basic operation

Press MODE+/- to switch general change modes 1-28, DMX decoder 29, DMX administration mode 30, automatic change models 31-38 and automatic timing run change mode 39.

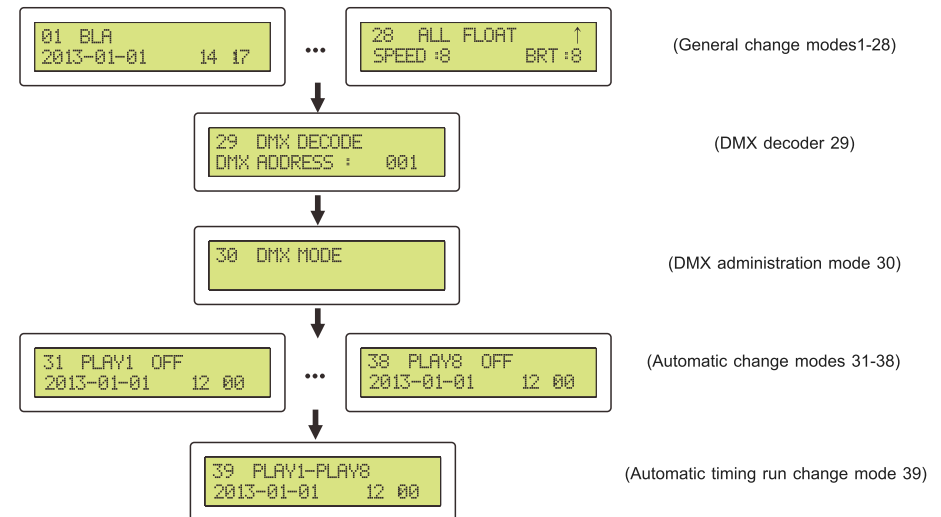

2. Operation for general changing modes 1-28:



1) Following form is general change functional modes.

No.	Changing Color	Changing Type Choice	Movement Direction	Instruction	No.	Changing Color	Changing Type Choice	Movement Direction	Instruction
Can be combined into 540 changing mode in total					Can be combined into 540 changing mode in total				
1	BLA(black)	\	\	\	15	R/Y(red/yellow)			S P E E D / B R I G H T N E S  A D J U S T M E N T
2	RED(red)				16	R/P(red/purple)			
3	GRN(green)				17	G/Y(green/yellow)			
4	BLU(blue)				18	G/C(green/cyan)			
5	YLW(yellow)				19	B/P(blue/purple)			
6	PUR(purple)				20	B/C(blue/cyan)			
7	GYN(cyan)	Press FUN to switch:	Press SETUP to Switch:		21	Y/P(yellow/purple)			
8	WHI(white)	JUMP	Under the four modes: flow/ chase/meteor/		22	Y/C(yellow/cyan)	JUMP	Under the four modes: flow/ chase/meteor/	
9	R/W(red/white)	FLASH	float, short		23	P/C(purple/cyan)	FLASH	float, short	
10	G/W(green/white)	SMOOTH	press "SETUP" to switch:		24	R/G(red/green)	SMOOTH	press "SETUP" to switch:	
11	B/W(blue/white)	FADE	forward (↑)		25	R/B(red/blue)	FADE	reverse (↓)	
12	Y/W(yellow/white)	FLOW	close (⌵)		26	G/B(green/blue)	FLOW	split (⌵)	
13	P/W(purple/white)	METEOR			27	RGB(red/green/blue)	METEOR		
14	C/W(cyan/white)	FLOAT			28	ALL(all color)	FLOAT		

[Note] : Method for selecting seven static colors: under 2-8 changing mode, select JUMP type and change the speed in Max. 8 or Min. 1.

2)Submenu setting method: in general changing modes 1-28, long press SETUP in 3 seconds to enter submenu, as follows:

No.	Submenu Function (Press MODE+/- to Change Menu Below)	LCD Display Condition	Setting Methods
1	PIXEL NUMBER CHOICE (range 0032-1024) PIXEL WIDTH CHOICE (08, 16, 32, 64)	PIXEL NUMBER 0032 COLOR PIXEL : 08	Press BRT+/- to choose the pixel number, Press SPEED+/- to switch the pixel number and color pixel length.
2	OPERATION TIMES CHOICE (range 000-255)	RUN TIMES 255 000=NOT RUNNING	Press BRT+/- to choose running times (only work in automatic change models 31-38)
3	RGB OUTPUT GREYSCALE CHOICE (127-255 per RGB,0-255 per RGB in Mode 8 for white)	RGB BRIGHT ADJ R255 G255 B255	Press BRT+/- to adjust each RGB value. Press SPEED+/- to switch R, G and B. (Be used with caution in this function, 255 level for default value RGB)
4	MODE RECOVER DEFAULT	LOAD DEFAULT SET PRESS BRT+ - KEY	Press BRT+/- to restore the default value of the current mode

Press "SETUP" to exit after parameter setting.

3. Mode 29-DMX address setting

In Mode 29 (DMX decoder), long press SETUP key in 3 seconds to enter DMX address setting submenu, as follows:

No.	Submenu Function (Press MODE+/- to Change Menu Below)	LCD Display Condition	Setting Methods
1	DMX address setting (range001~512)	DMX ADDRESS : 007 2013-07-10 17 08	Press SPEED+/- to increase or decrease the ten digit, press BRT+/- to increase or decrease the units digit.
2	Repeat channel value (range 003-510) repeat setting	DECODE NUM : 003 REPEAT SET : YES	Press SPEED+/- to switch DECODER NUM and REPEAT SET. Press BRT+/- to change the quantity of DECODER NUM and choose whether it repeat.

4. Mode 30 DMX administration mode

1)Short press Mode+/- to enter to enter Mode 30( DMX administration mode), in DMX console connecting, use 6 DMX channels to manage all modes' color, speed, brightness, types, direction and flash.

DMX channel	function	
CH1: 0-255	0-231: 1-28 modes selection/ 232-255: RGB brightness mode	232-255: RGB brightness mode (Push to the top)
CH2: 0-255	1-28 modes of change speed (8 levels)	red 0-100% Brightness adjustment
CH3: 0-255	1-28 modes brightness adjustment (8 levels)	green 0-100% Brightness adjustment
CH4: 0-255	1-28 mode change type: jump, flash, smooth, fade, flow, chase, meteor, float	blue 0-100% Brightness adjustment
CH5: 0-255	1-28 mode change direction (4 directions) forward (↑), reverse (↓), close (⌵), split(⌵)	/
CH6: 0-255	1-28 mode flash speed(16 level)	/

[Note] :

- The mode, speed, brightness, type, direction value changed by the console are very clearly displayed on the LCD screen.
- The last character of LCD line 1 ( ↓) showed with console signal or not.

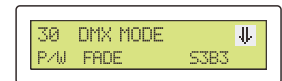

2)Sub-menu setting:

In Mode 30 ( DMX administration mode), press SETUP key in 3 seconds to enter DMX address setting submenu, as follows:



5. The Sub Menu of Automatic Changing Modes 31-38

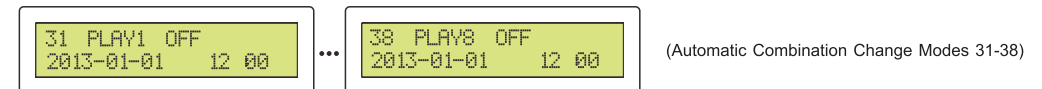

Under Automatic Combination Change Modes 31-38, long press STEUP key in 3 seconds to enter submenu, as follows:

No.	Submenu Function (Press MODE+/- to Change Menu Below)	LCD Display Condition	Setting Methods
1	Setting switch state		Press "BRT+/-" to set the switch state, Select "ON" to 39 automatic circle modes.
	Store the times of operating (convenient to set basic on the last time setting)		Press "SPEED+/-" enter into "OPEN" (Turn out the operation times of 1-30 modes), then Press "BRT+" to confirm.
	Save preset running times		Press "SPEED+/-" into "SAVE" mode(save preset running times of mode 1-30), Press "BRT+/-" to confirm.
2	Setting week's running times		Press SPEED+/- to switch "MTWTFSS" (Monday to Sunday) or 00:00-00:00 (time). Press BRT+/- for setting ( if without choose Monday to Sunday, marked "_").
3	Operate time and date 1		Press "SPEED+/-" to change the "0101-0103 (date)" or "00:00-00:00(time)"; Press BRT+/- to adjust the date and the time
4	Operate time and date 2		press "SPEED+/-" to change the "0101-0103 (date)" or "00:00-00:00(time)"; Press BRT+/- to adjust the date and the time
5	Operate time and date 3		press "SPEED+/-" to change the "0101-0103 (date)" or "00:00-00:00(time)"; Press BRT+/- to adjust the date and the time
6	System clock setting		Press "SPEED+/-" to switch "2013-01 01" (date), 12:00(time), press "BRT+/-" to adjust date and time.
7	IC types and RGB sequence setting		Press SPEED to switch the IC types and RGB sequence. Press RT+/- to adjust the IC types and RGB sequence, IC types: TM1809, LPD6803, LPD8806, WS2801, P9813, TLS3001, RGB sequence: RGB, RBG, GRB, GBR, BRG, BGR
8	Modes restore default value		Press "BRT+/-" restore the automatic default value.

Press "SETUP" to exit after parameter setting.

**6. Automatic Timing Run Mode 39:**

When set to Mode 39, according to the preset switch condition and running time of automatic change modes 31-38 to timing run the corresponding mode.

Submenu only recover the complete machine default (Please use this option with caution).

**5. Connection Schemes:**

Mode of connection	Signal cable	Choose of Controller IC	Support IC models
<p>Two cables DATA CLK</p>			LPD6803, LPD1101, D705, UCS6909, UCS6912
			LPD8803, LPD8806
			WS2801, WS2803
			P9813
<p>One cable DATA</p>			TM1804, TM1809, TM1812, UCS1903, UCS1909, UCS1912, UCS2903, UCS2909, UCS2912, WS2811
			TLS3001, TLS3002

**1. Unified powersupply**

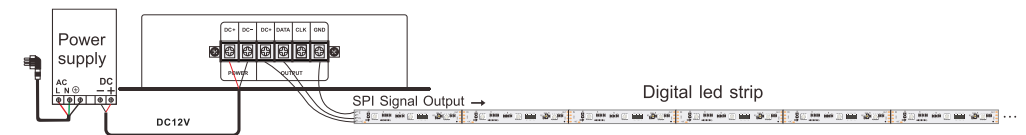

**2. Separated powersupply**

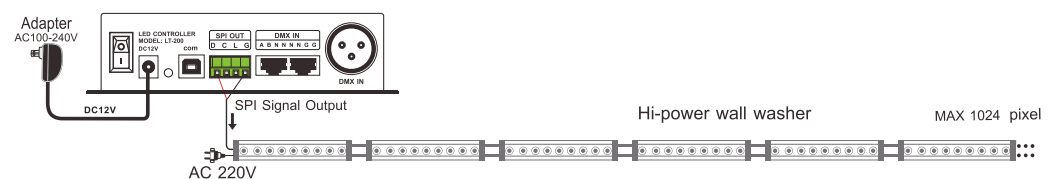
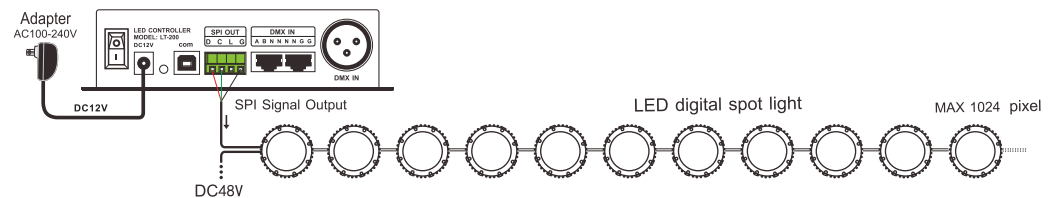

3. Connected with DMX 512 computer console to realize DMX decoder functions.

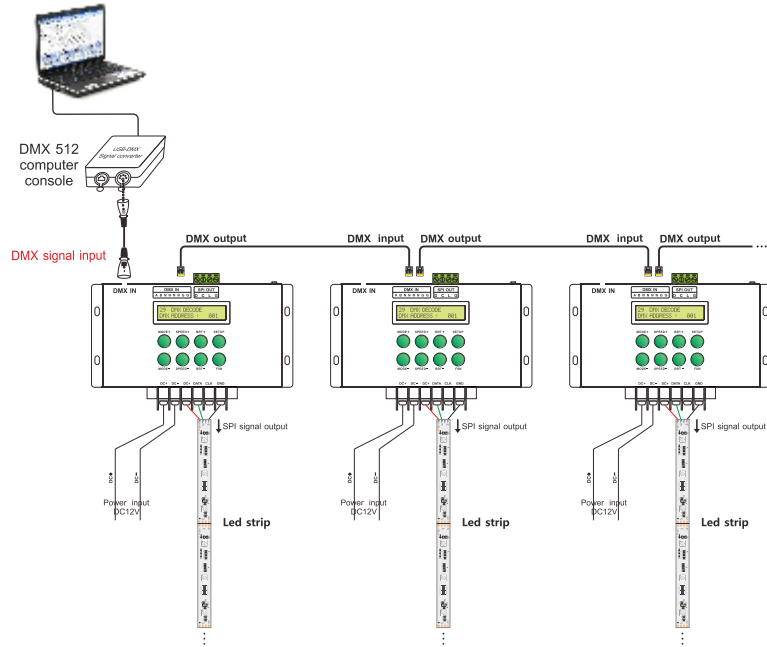

4. Connected with DMX 512 computer console, use the console to manage the controller

DMX512 Manual operation console

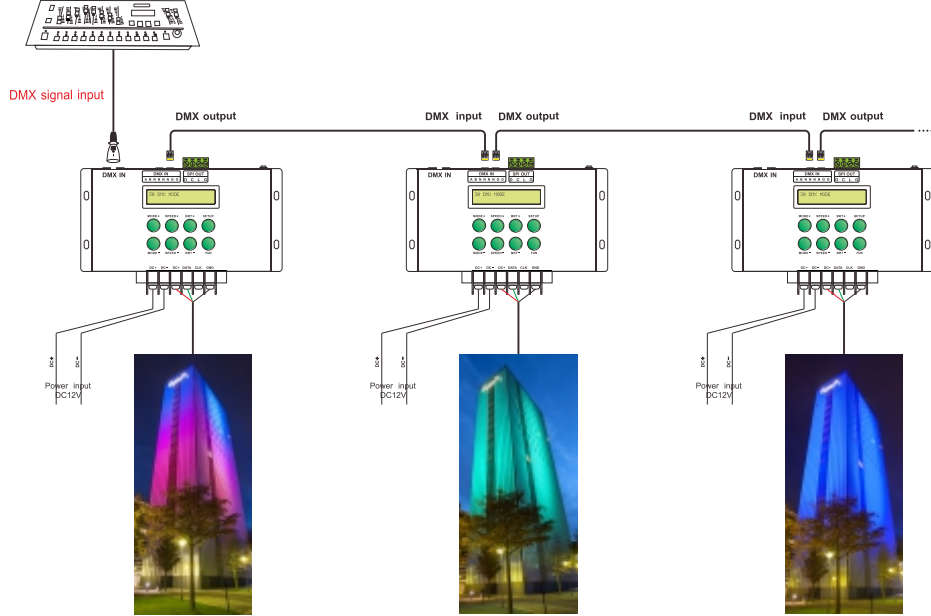

7

### 6. Attention:

1. The product shall be installed and serviced by a qualified person.
2. This product is non-waterproof. Please avoid the sun and rain. When installed outdoors please ensure it is mounted in a water proof enclosure.
3. Good heat dissipation will prolong the working life of the controller. Please ensure good ventilation.
4. Please check if the output voltage of any LED power supplies used comply with the working voltage of the product.
5. Please ensure that adequate sized cable is used from the controller to the LED lights to carry the current. Please also ensure that the cable is secured tightly in the connector to avoid the accidents due to overheat and poor contact on the wire.
6. Ensure all wire connections and polarities are correct before applying power to avoid any damages to the LED lights.
7. If a fault occurs please return the product to your supplier. Do not attempt to fix this product by yourself.

### 7. Warranty Agreement:

1. We provide lifelong technical assistance with this product:
  - A 5-year warranty is given from the date of purchase. The warranty is for free repair or replacement and covers manufacturing faults only.
  - For faults beyond the 5-year warranty we reserve the right to charge for time and parts.
2. Warranty exclusions below:
  - Any man-made damages caused from improper operation, or connecting to excess voltage and overloading.
  - The product appears to have excessive physical damage.
  - Damage due to natural disasters and force majeure.
  - Warranty label, fragile label and unique barcode label have been damaged.
  - The product has been replaced by a brand new product.
3. Repair or replacement as provided under this warranty is the exclusive remedy to the customer. Ltech shall not be liable for any incidental or consequential damages for breach of any stipulation in this warranty.
4. Any amendment or adjustment to this warranty must be approved in writing by Ltech only.

★ This manual only applies to this model. Ltech reserves the right to make changes without prior notice.

8