

LED RIBBON STRIP | 9 WATTS PER METRE

COLOUR	CODE	LUMENS
WARM WHITE 3000K	BL-LS-1001-WW	801lm/m
NATURAL WHITE 4000K	BL-LS-1001-NW	827lm/m
COOL WHITE 5000K	BL-LS-1001-CW	835lm/m

COLOUR VARIANCE +/- 200K
ELECTRICAL & OPTICAL DATA VARIANCE +/- 10%
SOLD BY THE METRE

LED WATTS	8.7W/m
INPUT VOLTS	24V DC constant voltage
OPERATING TEMP.	-20°C ~ +60°C
MAX. RUN PER POWER FEED	12 metres
CRI	≥80
BEAM ANGLE	120°
SOURCE LIFE	50,000 hours
WARRANTY	3 years
MOUNTING	3M adhesive backing <i>A Bright Light approved aluminium profile for thermal management is required</i>
INGRESS PROTECTION	IP20 indoor use only
CONTROL	Dimmable by PWM signal

ALWAYS UNCOIL BEFORE USE

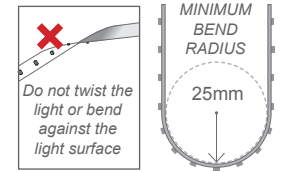
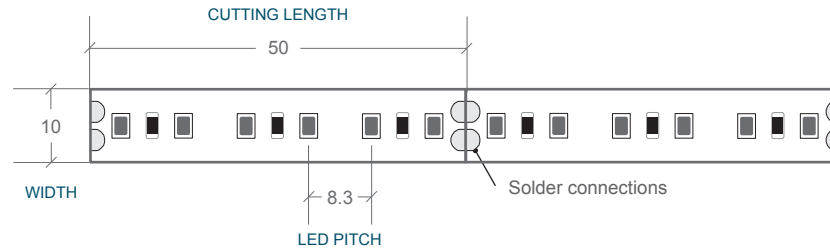

CUT

Cut LED ribbon strip at the cut marks outlined only.

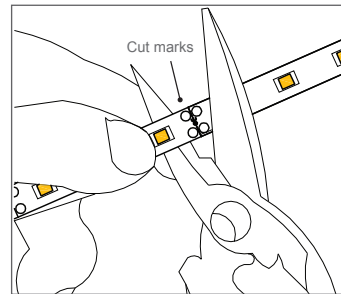

TO ADD A CABLE CONNECTION

Cut and trim the cable to the appropriate length. Solder the wires onto the end of the ribbon strip ensuring the correct +/- polarity.

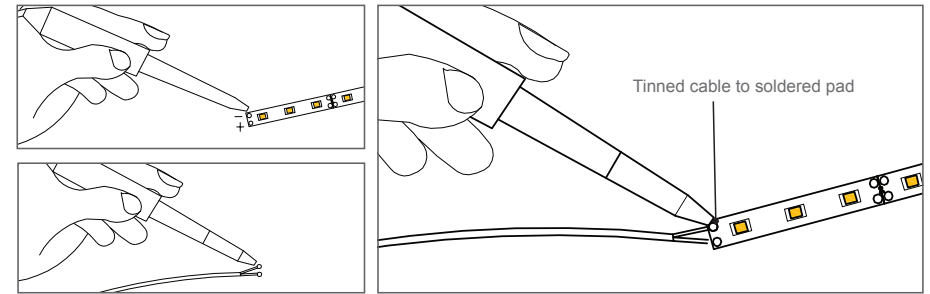

TO MAKE AN END TO END CONNECTION

To connect one length of ribbon strip to another, align LED ribbon strips end to end matching the correct +/- polarity between both lengths. Heat and solder the two lengths of ribbon together, using the solder pads on both strips to form a continuous electrical circuit.

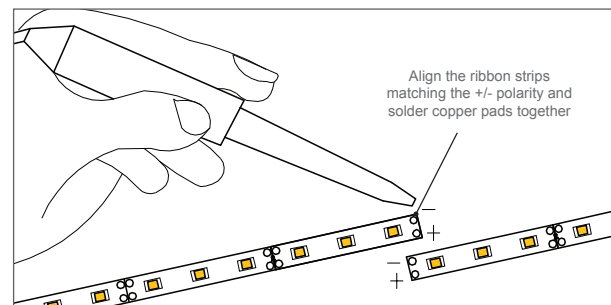

TO PROVIDE A CORNER CONNECTION

Cut and trim the wires to the appropriate length for the corner. Solder wires to the end of the ribbon strip and to the beginning of the new ribbon strip ensuring the correct +/- polarity.

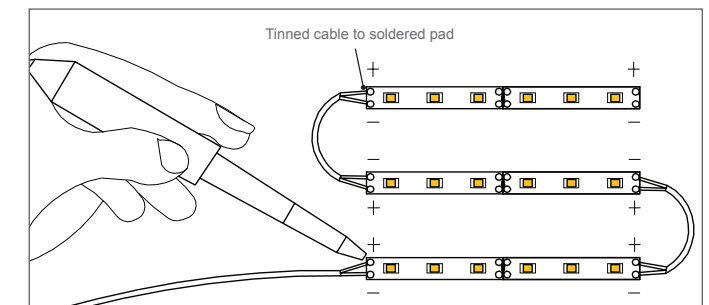

Please note drawings are an installation guide only. Each LED Ribbon Strip application may have variable factors. Cable size may need to be specified to limit the voltage drop throughout the circuit.