



# Thin Premium Floor Stand w/ Large Paragon Security Enclosure

PAD-CHKLB/PAD-CHKLW

INSTALLATION - MANUAL

## CONTENTS:

(A)



x1

(B)

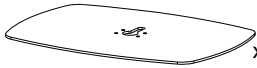

x1

(D)



x4

(E)



x4

M5X6  
Hex Nut

(F)



x4

M5X6  
Screw

(G)



x1

(C)

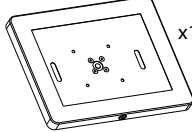

x1

(H)

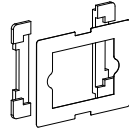

Foam Adapter  
& Sheet Bundle



x1

(J)

Allen  
Key

## INSTALLATION:

### 1. Assembling Floor stand :

### 2. Attaching Enclosure to VESA :

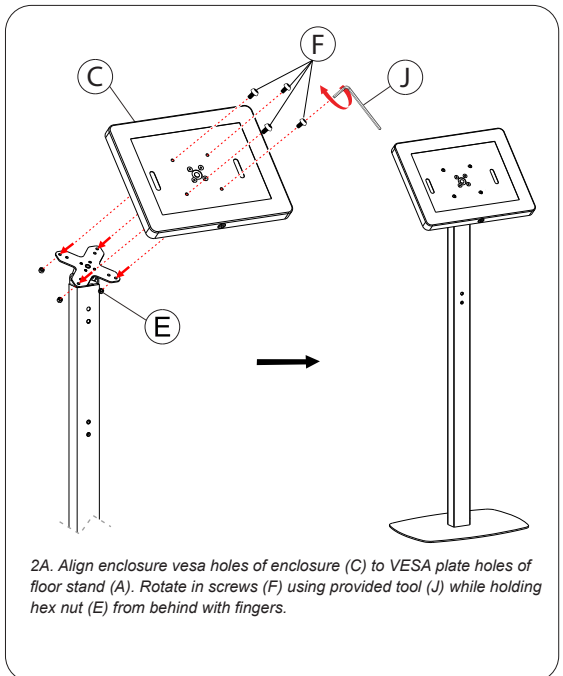
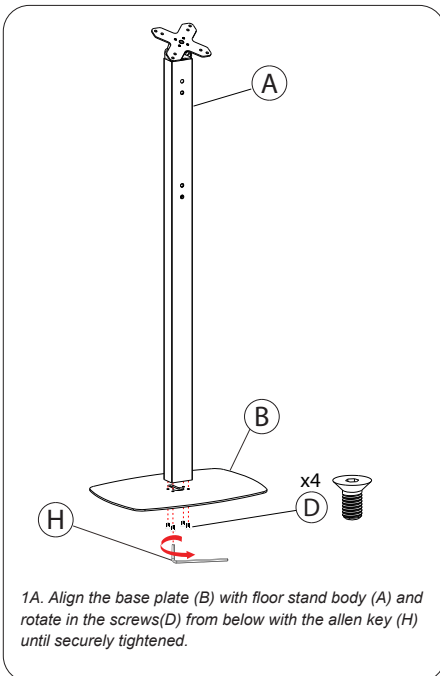

### 3. Setting up Device and Enclosure :

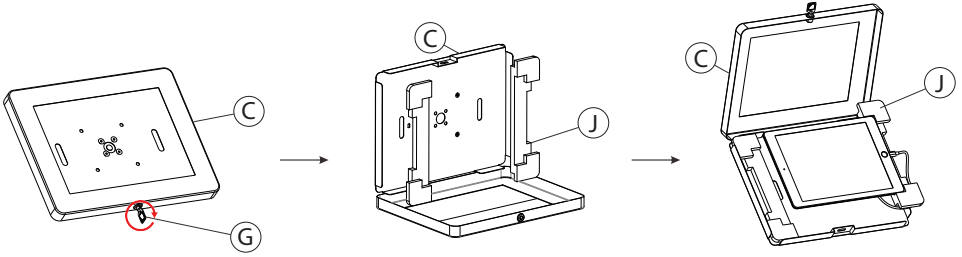

3A. Lock or unlock your tablet enclosure (C) with security key (G) as shown.

3B. Find the appropriate size foam padding (J) for the tablet you wish to use. Make sure device is compatible for the enclosure (C). Lay in device and connect any cables/cords as needed.

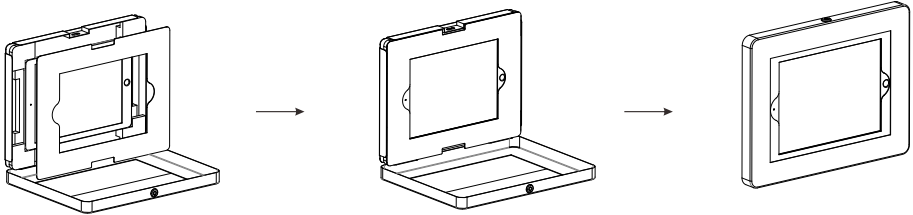

3C. If needed, lay-in correct included masking insert (J). Close and lock enclosure afterwards and you're set.

\*\*Tablet shown for illustration and NOT INCLUDED.

### 4. Cable Routing :

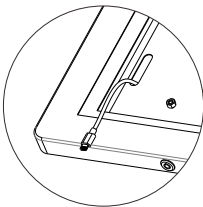

4A. Plug one end of the tablet cord into device, and route the other end through hole in the back as shown above.

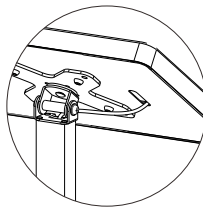

4B. Cable route from enclosure to the hole at the top of the body as shown above.

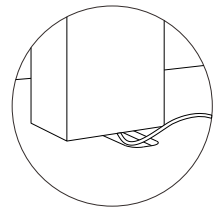

4C. Insert the cable through the cutouts at floorstand head and take it out in the cutout of the back of the base.

### Adjusting Angles and Orientation

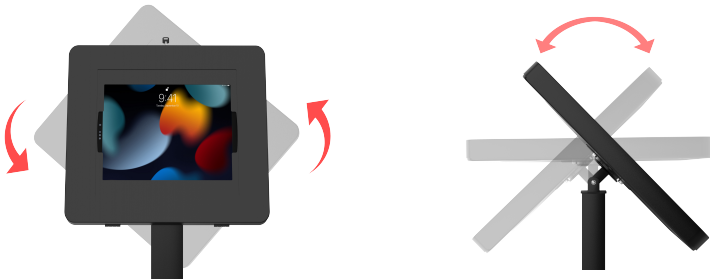

Tilt up/down for preferred angles as needed. Rotate left and right for preferred orientation.