



# Dual VESA Compatible Table Mount For POS

BLACK / WHITE

ADD-VPOS2W / ADD-VPOS2B

INSTRUCTION - MANUAL

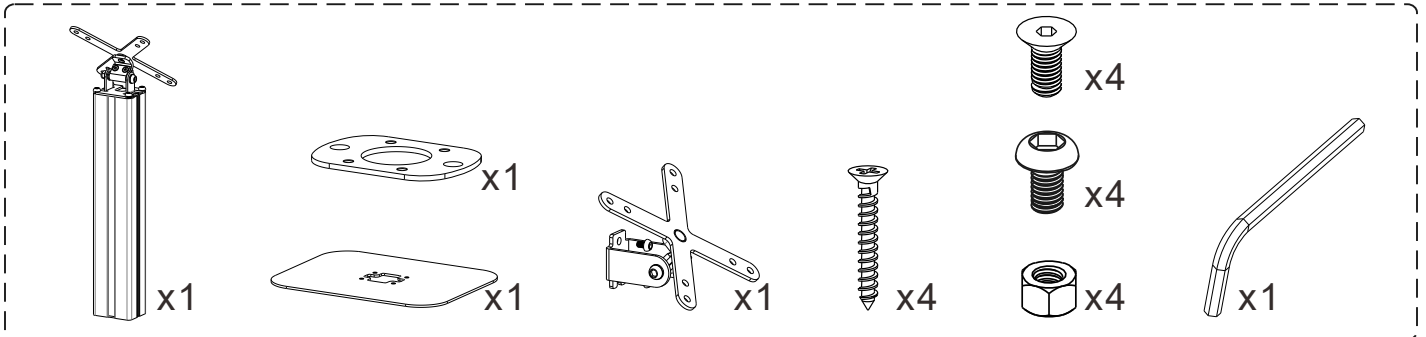

1. Screwing in main body bottom component

2. Mounting into surface. Screw nails into surface as shown.

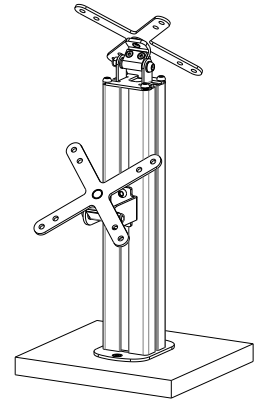
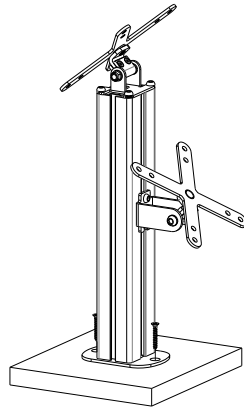
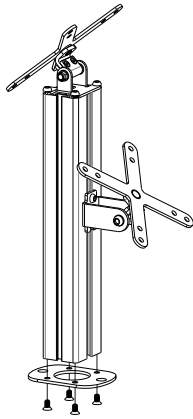

3. Mounting into base creating kiosk. Screw in nails from bottom into base as shown using tools provided .

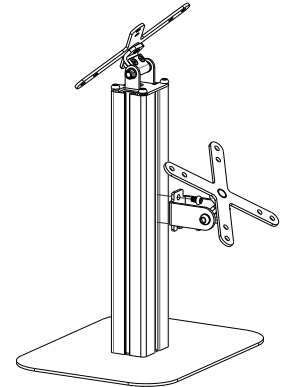
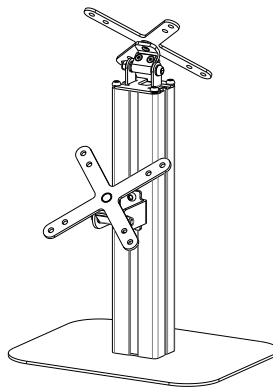
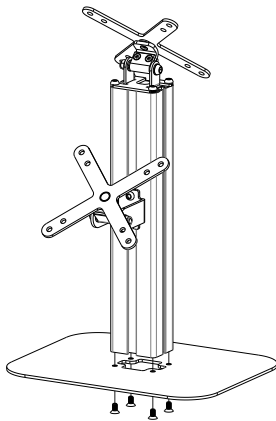

4. Mounting VESA compatible component (shown below)

\*\*Tablet Enclosures are not included and only being shown as an example

