

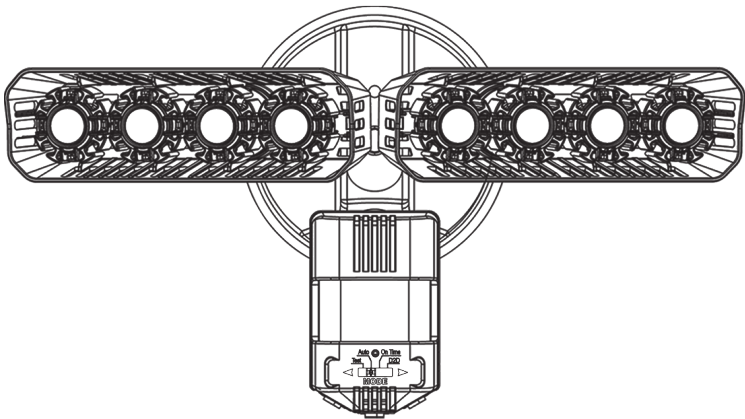

# SANSI

## MOTION-ACTIVATED CERAMIC LED SECURITY LIGHT

### User Manual



Model: C2440-GW / HW / JW / KW  
Color: White / Black

Before installation, please read all of the instructions thoroughly and keep it for future reference.

## Product and accessories

All installation parts should be in the box, if some of them are missing, please contact us firstly via [service@sansitech.us](mailto:service@sansitech.us)

Motion-activated ceramic LED security light

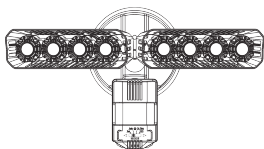

Bar-shaped mounting plate and 3 screws

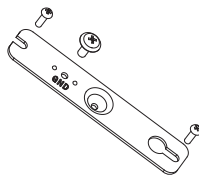

Waterproof Gasket

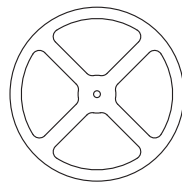

3 Wire Connectors



Mounting bolt



Rubber screw cap



## TOOLS NEEDED

Cross-head screwdriver #2

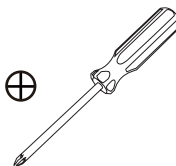

## Dimensions

Model: C2440-JW

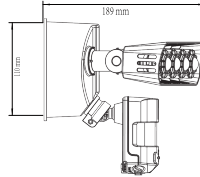
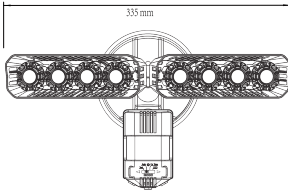

Model: C2440-HW

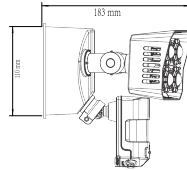
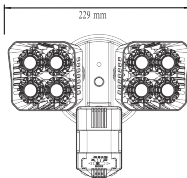

Model: C2440-GW

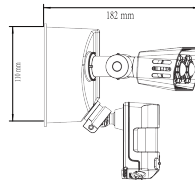
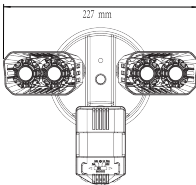

Model: C2440-KW

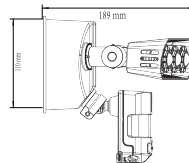
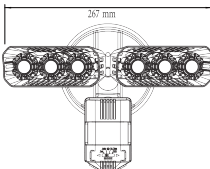

**Warning:** If you are not sure how to correctly assemble the light, consult a local specialist technician. The wiring transition shall be strictly applied in compliance with the local regulations, rules and national electrical codes.

## INSTALLATION

### Before Installation

1. The product should be assembled vertically on the flat surface of the wall.
2. Input voltage: local
3. Assemble the product on an object with a height ranging from 1 -4 m (3.2 - 13.1 ft.). The optimal height for installation is 2.4 m (7.87 ft.).

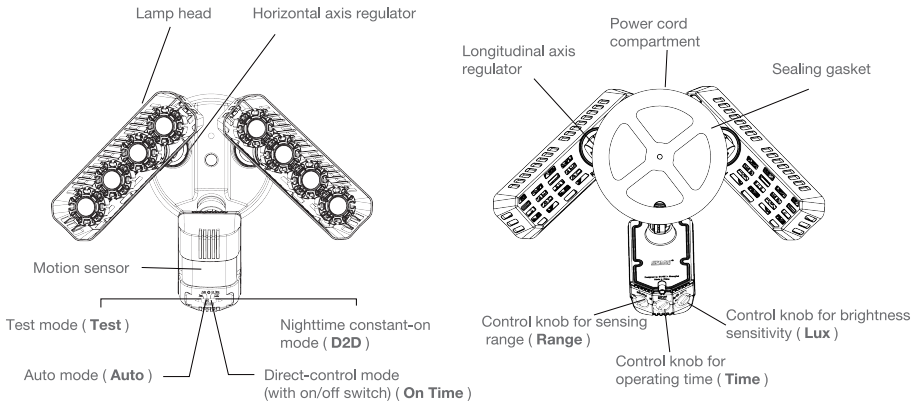

**Warning: Power off the circuit before installation.**

### Installation step 1: Mounting Plate Fixing

1. Find an installation place where house wires (live, neutral and ground) are available.
2. Ground the connect of the bar-shaped mounting plate with the # 8-32\*5/16" green headed screw (included).

Note: The bar-shaped mounting plate will only match with the standard junction box with an installation pitch of 88.9mm (31/2in). Make sure the bar plate is tightened firmly with screws.

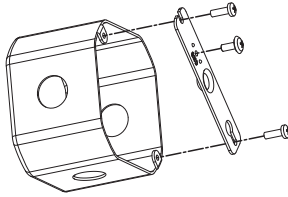

## Installation step 2: Wire Connection

### Black - Live (L) White - Neutral (N) Green - Ground (PE)

Strip the wires 3/8" (9.5mm) if not previously stripped. Hold the BLACK house wire and the BLACK fixture wire together with even ends. Align any frayed strands or conductors. Push the wires into the wire nut and screw. Turning clockwise until two twists are visible in the wires. Repeat the above procedure for both the WHITE house wire and the WHITE fixture wire. As well as the GREEN house wire and the GREEN fixture wire.

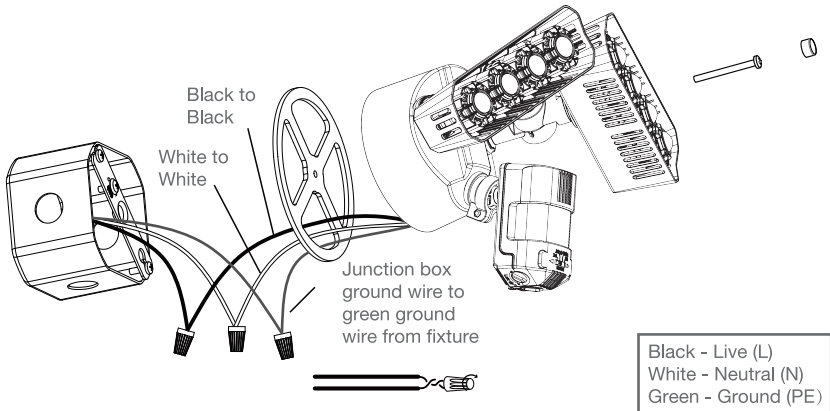

## Installation step 3: assembling the product

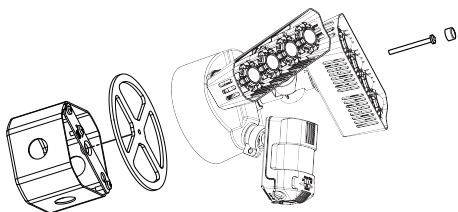

Insert mounting bolt through the center of the cover housing as shown. Align the mounting bolt through the small center of the gasket to hold the gasket in place. Position the cover housing and gasket over the junction box. Align the center bolt with the center hole of the mounting plate. Use a screwdriver to screw into the mounting plate until the LED fixture is securely mounted.

Cover the mounting bolt by inserting the rubber screw cap into the hole. Do this by aligning the rubber screw cap with the hole and press it in until it is secure.

## Settings

1. Switch on the circuit breaker and the product.

NOTE: The motion sensor needs to warm up for 1.5 minutes when it is first opened before it can capture any motion.

2. Set the working mode switch to test mode (**Test**) and then turn the sensory range control knob to the middle position (between the maximum and minimum settings).

NOTE: Set the lux switch to halfway in order to get a better performance.

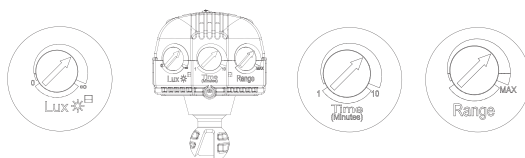

Bottom view of the motion sensor

## Caution:

Keep the product away from any objects with rapid temperature fluctuations, such as heating

air vents or air conditioners. These heat sources may result in activation faults. The product may be activated / switched on by moving pets or passing cars. Nearby large-sized light-colored objects, which reflect light may also activate the switching off of the product. Do not direct any type of light towards the motion sensor.

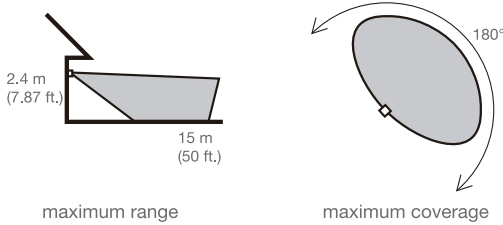

NOTE: Adjust the motion sensor downwards to shorten the sensory coverage distance if the product is mounted at a height over 2.4 m (7.87 ft.). The motion sensor has a lower sensitivity to objects moving towards it.

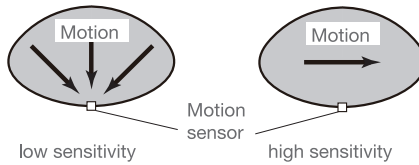

3. By moving through the test area, note your position when the product turns on (LED lamps will illuminate continuously for several minutes when any motion signal is captured). Adjust the motion sensor upwards, downwards or sideways to change the coverage area.

The distance between the motion sensor and the lamp heads should be at least 25 mm.

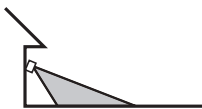

Adjust the motion sensor downwards to reduce the coverage area.

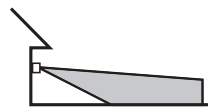

Adjust the motion sensor upwards to increase the coverage area.

4. Rotate the control knob for the sensory distance, if required. A sensory distance that is too long may result in activation fault.



5. If the motion sensor is loose, tighten the clamping screw . Do not overtighten the clamping screw.

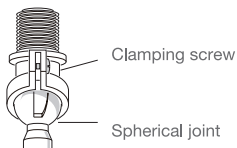

6. Set the working time from 1-10 minutes according to your needs.

Warning: Frequent switching on/off of the product will reduce the product's lifespan.

Warning: Keep the product away from any fire sources.

## Working mode

Mode	Operating time	Operation: Day / night
<b>Test</b>	5 seconds	✔ ✔
<b>Auto</b>	1 - 10 minutes	✔
<b>On Time</b>	Always on until switched off	✔ ✔
<b>D2D</b>	From dusk to dawn	✔

NOTE: When first using the product/ LED light source. Wait for 1-2 minutes for the electrical circuit to automatically calibrate.

## Functions

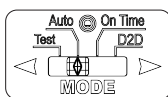

Setting the working mode switch

## Test — test mode

---

Light works for 5 seconds during the day or night when in test mode.

It was designed to check whether the sensor can work properly.

## Auto — auto mode

---

Light only works for 1-10 minutes at night when in auto mode. It depends on the working time you set. If you flip the home switch off for 1-2 seconds and then switch on, then light will work constantly for up to 8 hours at night. To back the auto mode, flip the switch off and on again. It also will be automatically back to auto mode when it's bright around (>150 LUX).

## On Time — direct-control mode (with on/off switch)

---

Both in the day time and night time, the LED light source will light up when the product is switched on and turns off when the product is switched off.

## D2D — night time constant-on mode

---

Light turns on automatically at dusk and turns off automatically at dawn when in d2d mode.



## Lux — control knob for brightness sensitivity

---

The lux switch was designed to set the brightness value for the sensor if the ambient brightness is higher than your setting, it's defined as "daytime" and the light doesn't turn on; if the brightness is lower than your setting it is defined as "night" and your light will turn on.

NOTE: Recommended lux setting is halfway on the lux dial. High LUX will turn the light on all the time. Low LUX will cause the light to flash.

## Time — control knob for operating time

---

This control knob is used for setting the operating time of continuous lighting once motion has been detected. The minimum setting is 1 minute and the maximum is 10 minutes.

## Range — control knob for sensing range

---

For setting the sensing range. Turn the control knob counterclockwise to decrease the sensing range, while clockwise to increase the sensing range.

### NOTE:

1. When you switch on the product, the LED light source is illuminated for approximately 35 seconds. This is called the “wake-up process”.
2. After the “wake-up process”, switch the product to the required working mode. Apart from **On Time** mode, the LED light source will flash several times after switching between each of the working modes.

## 5-year warranty

If you have any problems, questions or concerns, please feel free to contact us before returning the product. The Email of after-sales service is: [service@sansitech.us](mailto:service@sansitech.us).