

YUKATA

SMART DOLL

DESIGNED BY DANNY CHOO

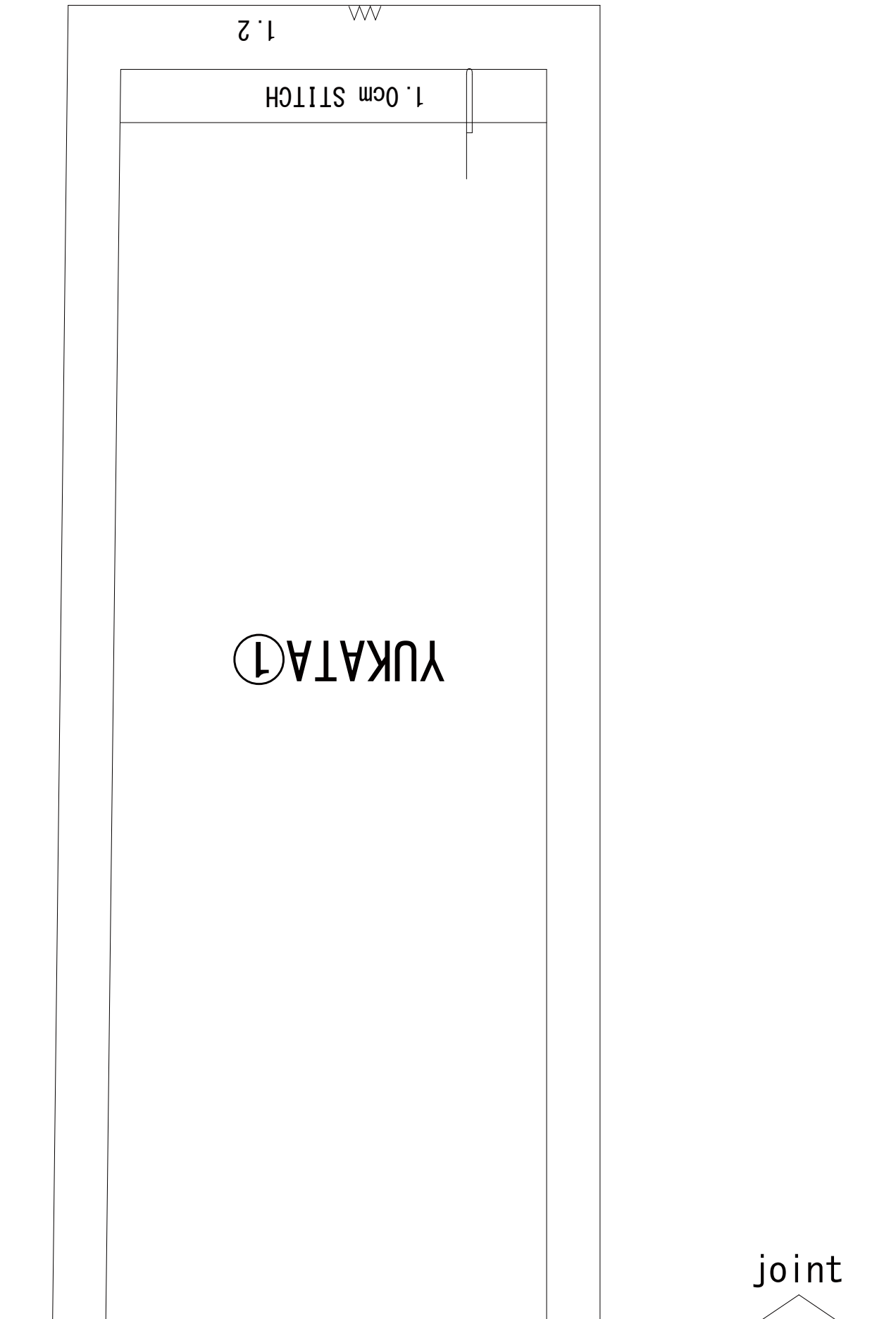
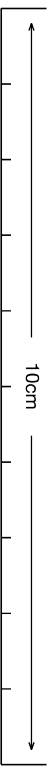

joint

joint

YUKATA ②

ㄣ/DIVIDE

ㄣ/DIVIDE

3.5cm SLIT

2cm SLIT

1.0

CB

SIDE

SLEEVE SEWING END

SLIT END

B C

CUT

NIP

S P

10cm

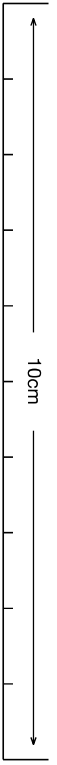

SMART DOLL

DESIGNED BY DANNY CHOO

YUKATA

SMART DOLL

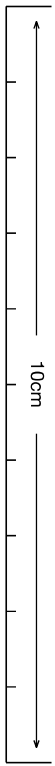

joint

1.0

SLEEVE SEWING END

SLIT END

Ⓛ  
2cm  
SLIT

YUKATA  
浴衣  
x2

YUKATA③

F C

joint

0.7cm STITCH

1.5

joint

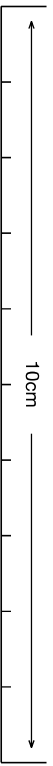

YUKATA④

1.0cm STITCH

1.2



S M A R T D O L L

DESIGNED BY DANNY CHOO

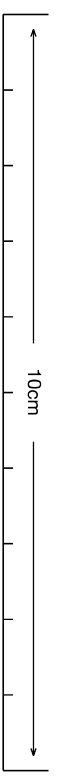
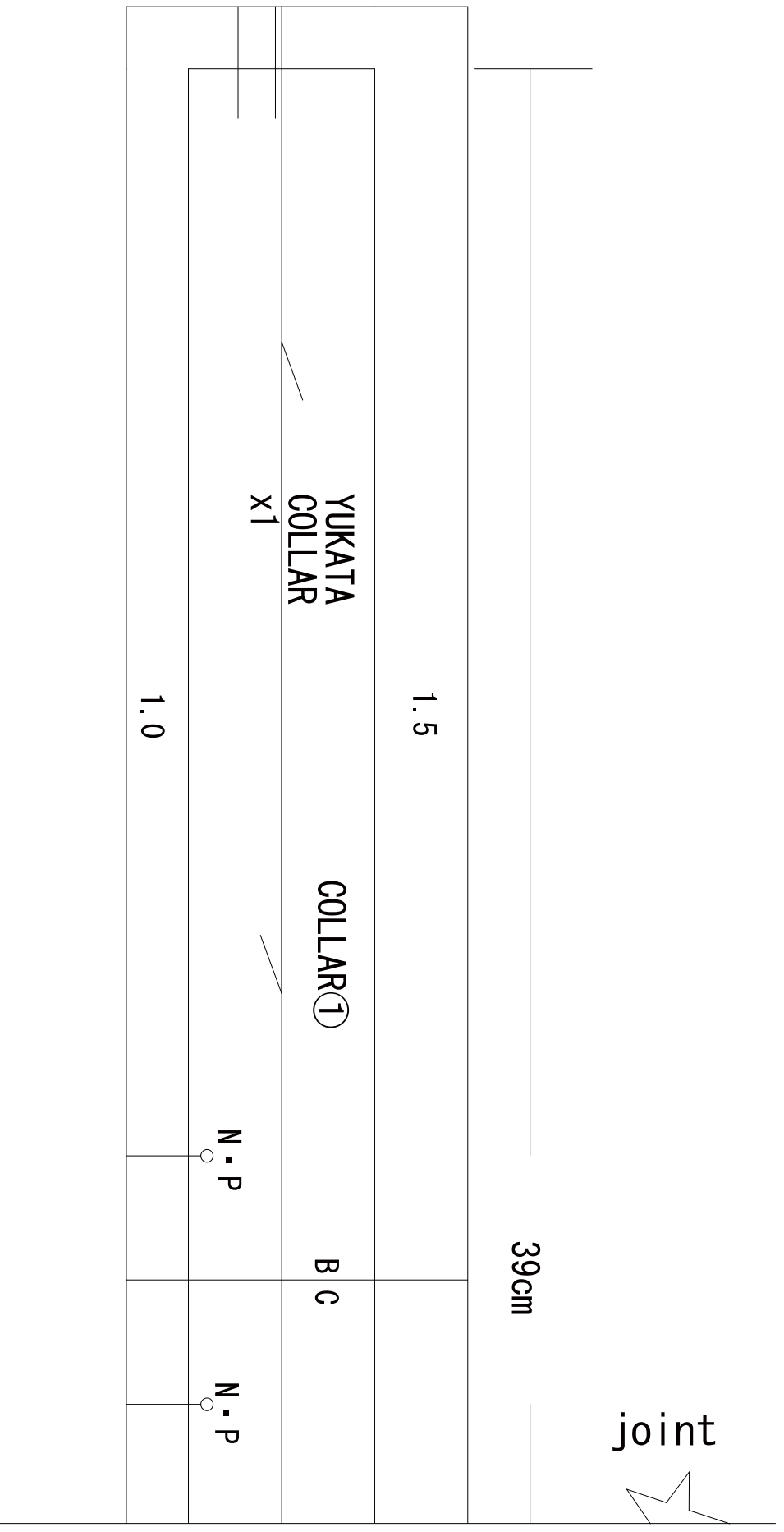

YUKATA

# S M A R T D O L L

DESIGNED BY DANNY CHOO

joint

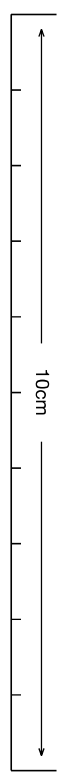
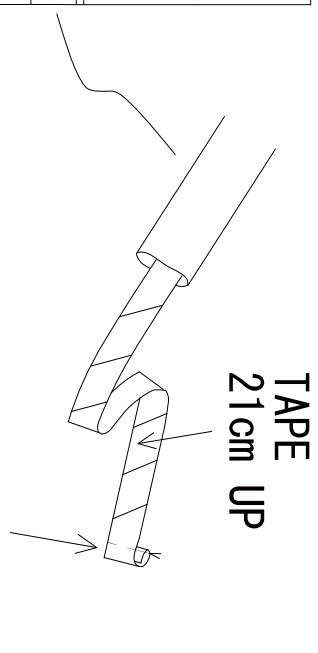
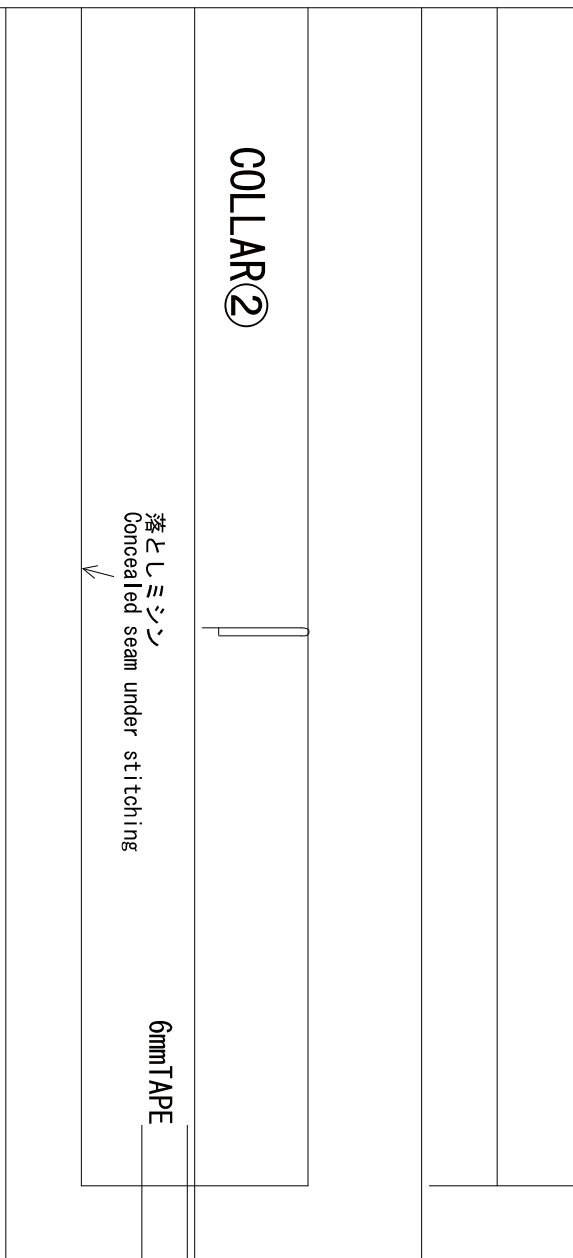

# SMART DOLL

# SMART DOLL

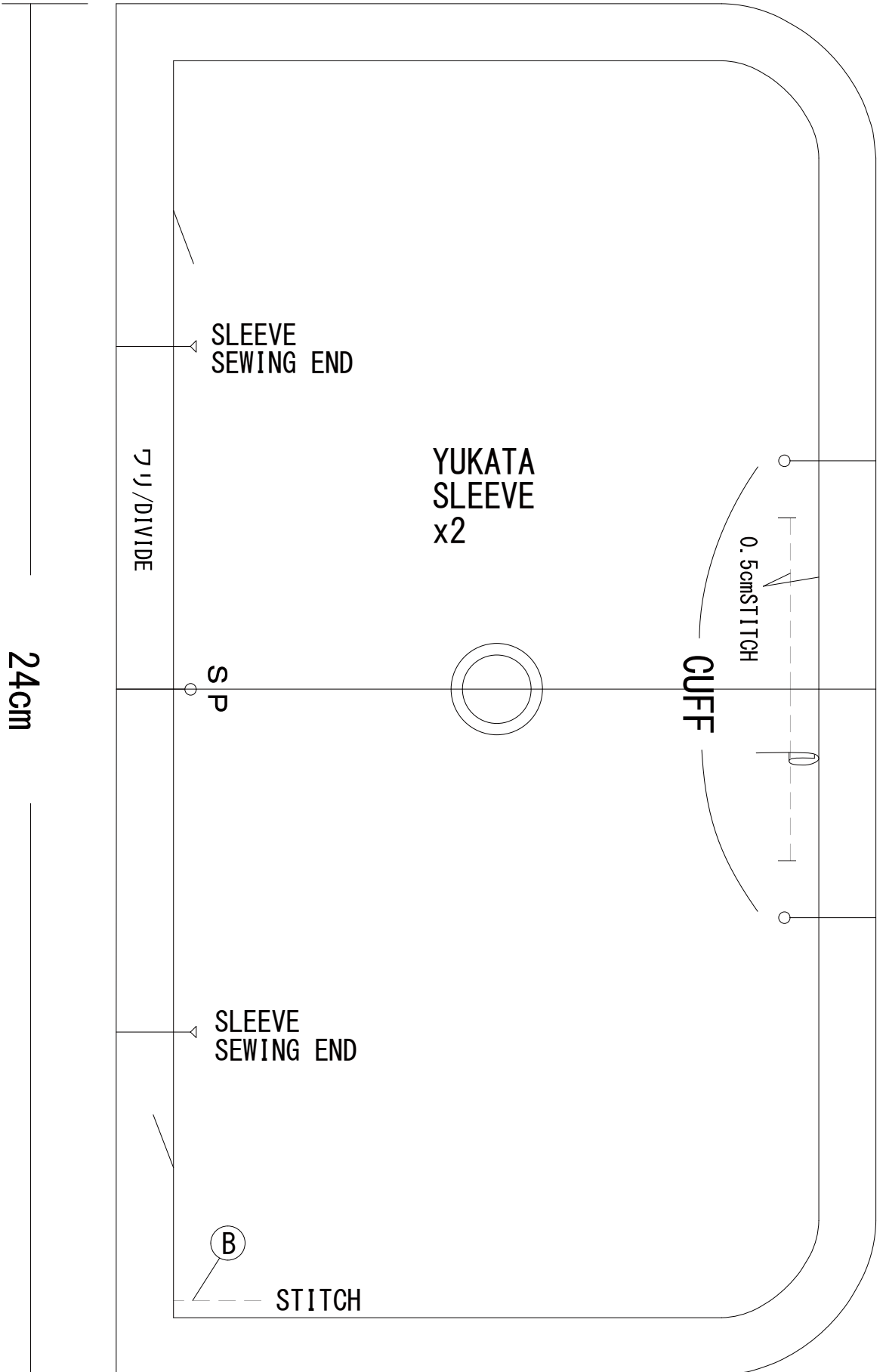

joint

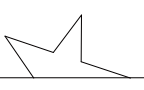

0.5

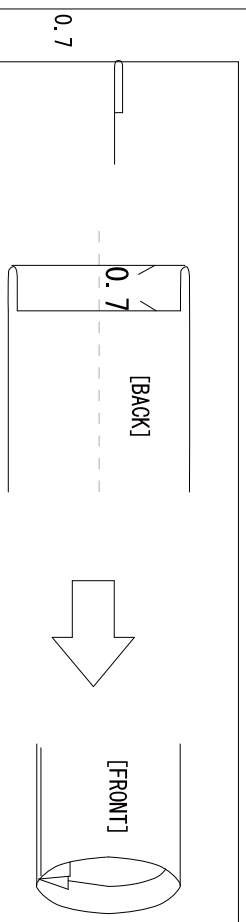

YUKATA  
BELT / 帯 (OBI)  
x1

BELT ①

0.5

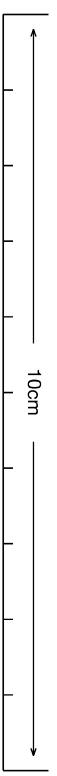



joint

joint

BELT ②

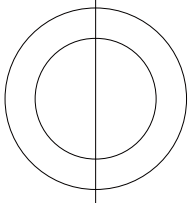

79cm

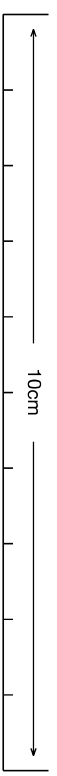

S M A R T D O L L

YUKATA

DESIGNED BY DANNY CHOO

joint

BELT ③

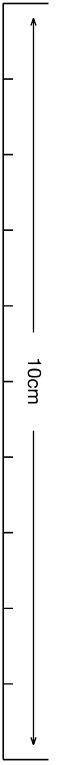

S M A R T D O L L

YUKATA

DESIGNED BY DANNY CHOO

