

# SMART DOLL

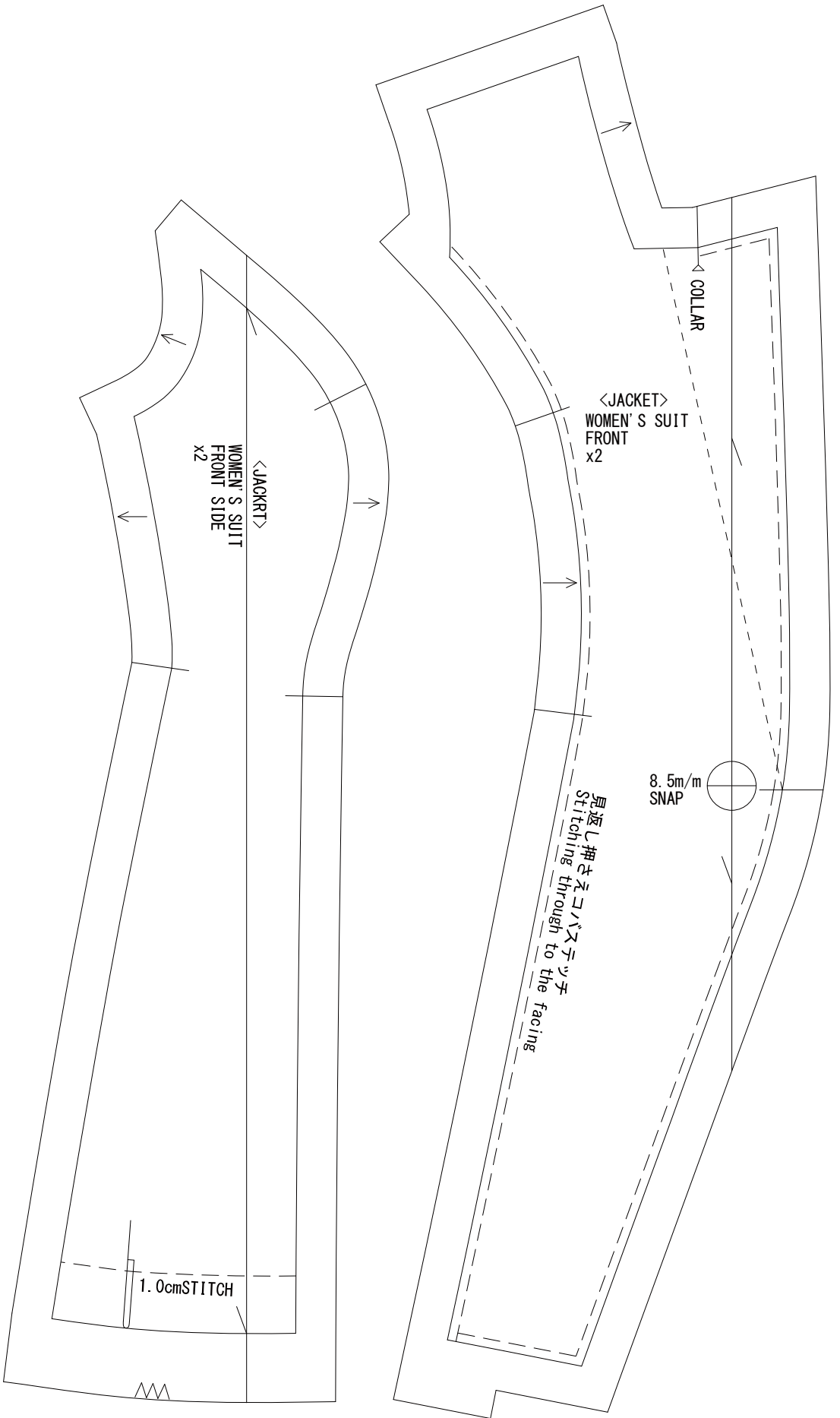

# SMART DOLL

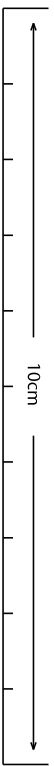
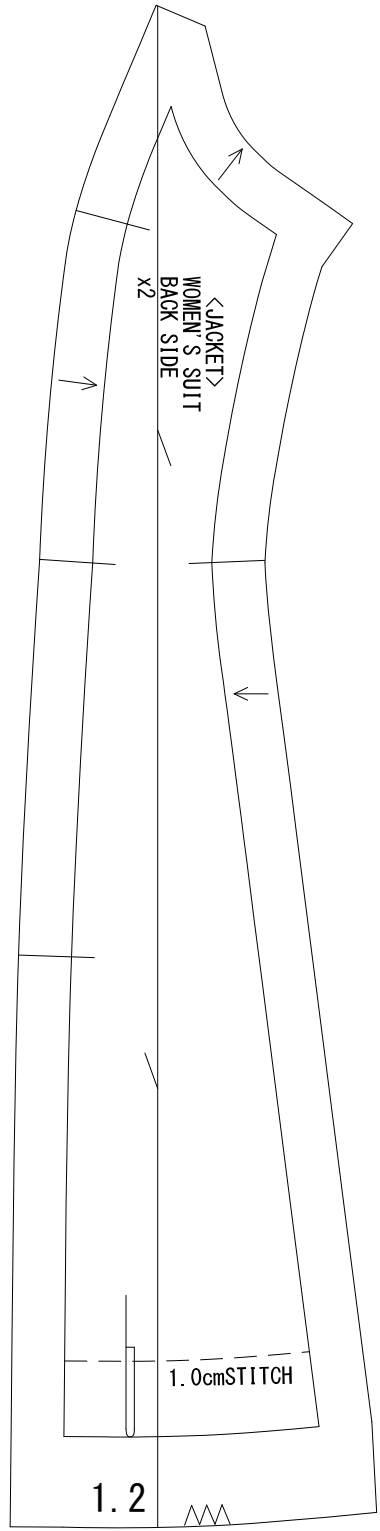
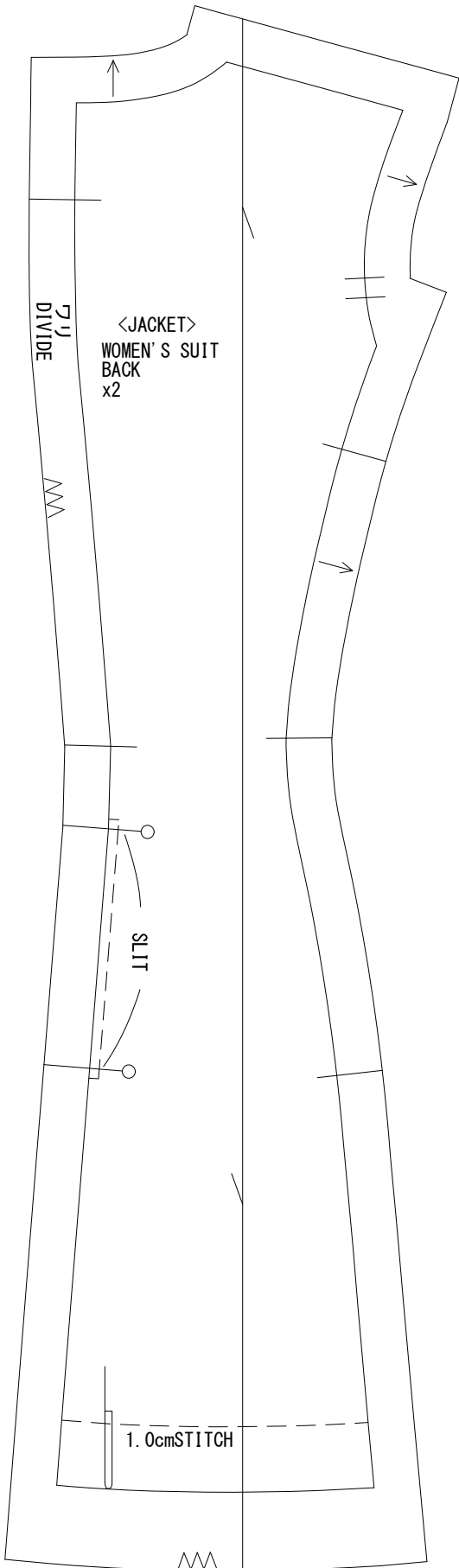
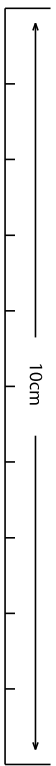

SMART DOLL  
DESIGNED BY DANNY CHOO

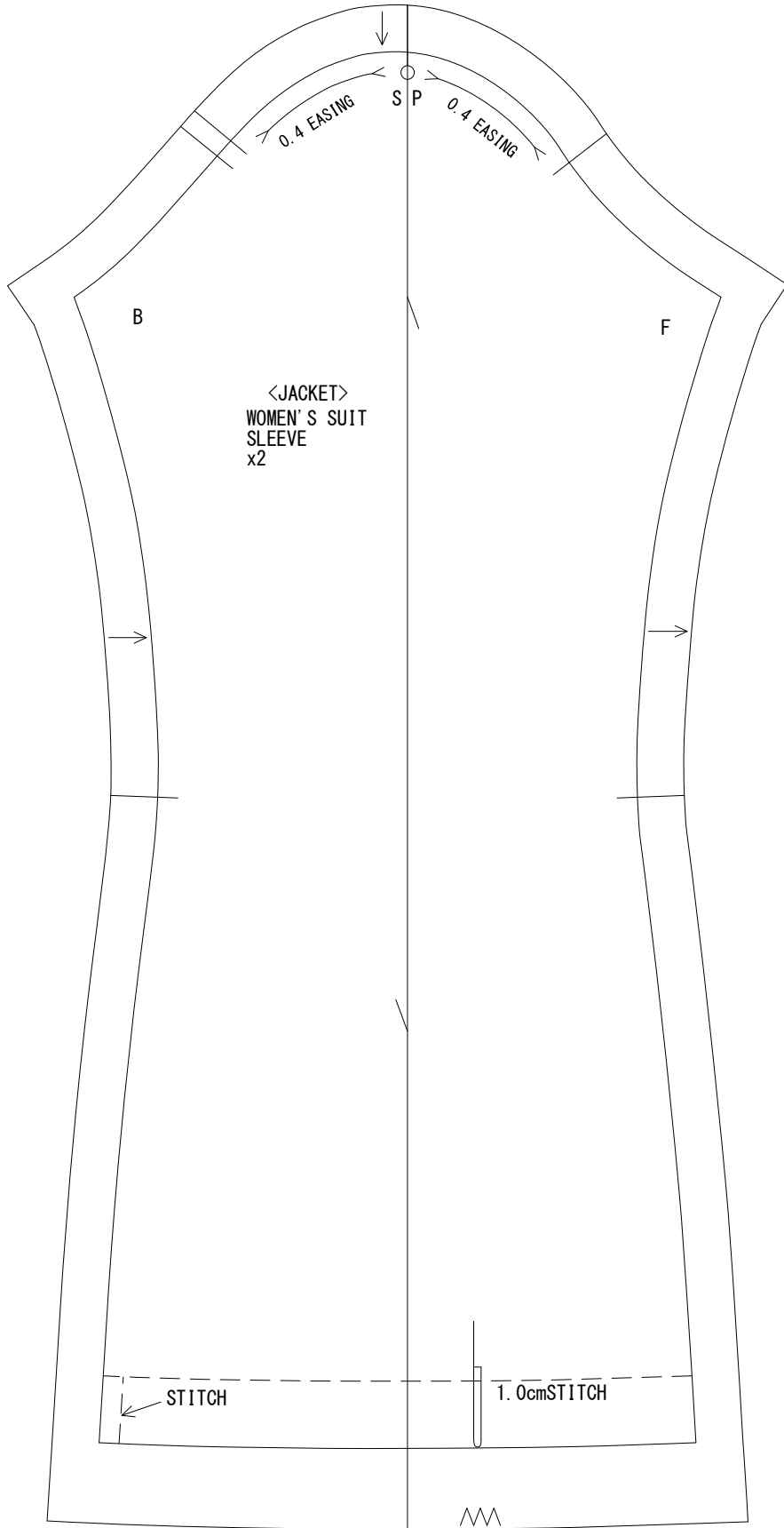
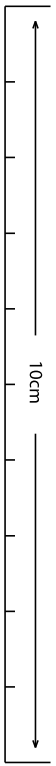

# SMART DOLL

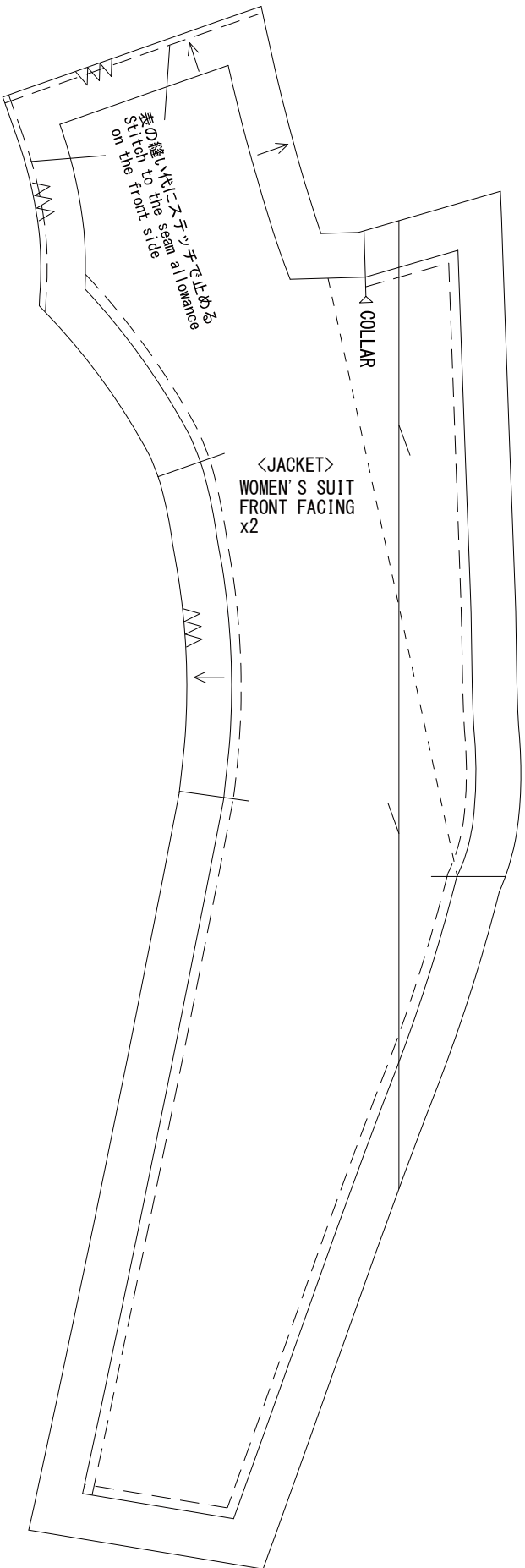
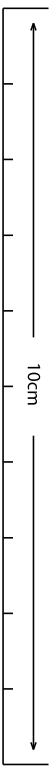

# SMART DOLL

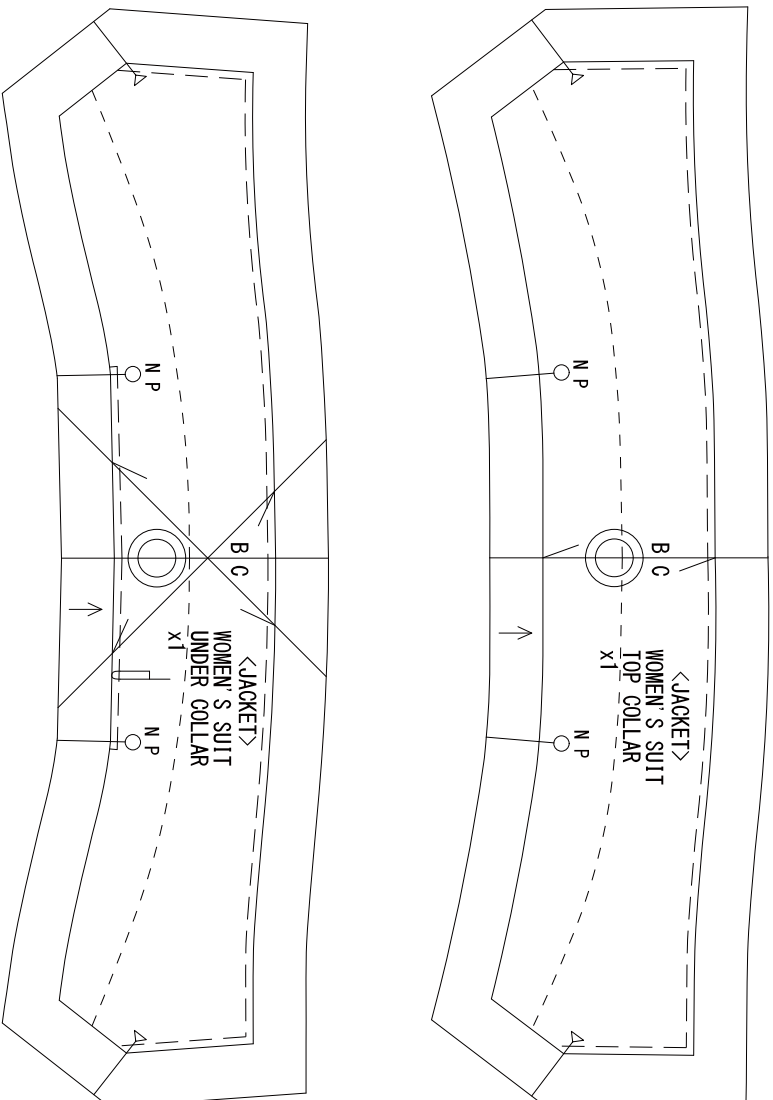
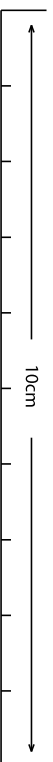

SMART DOLL  
DESIGNED BY DANNY CHOO

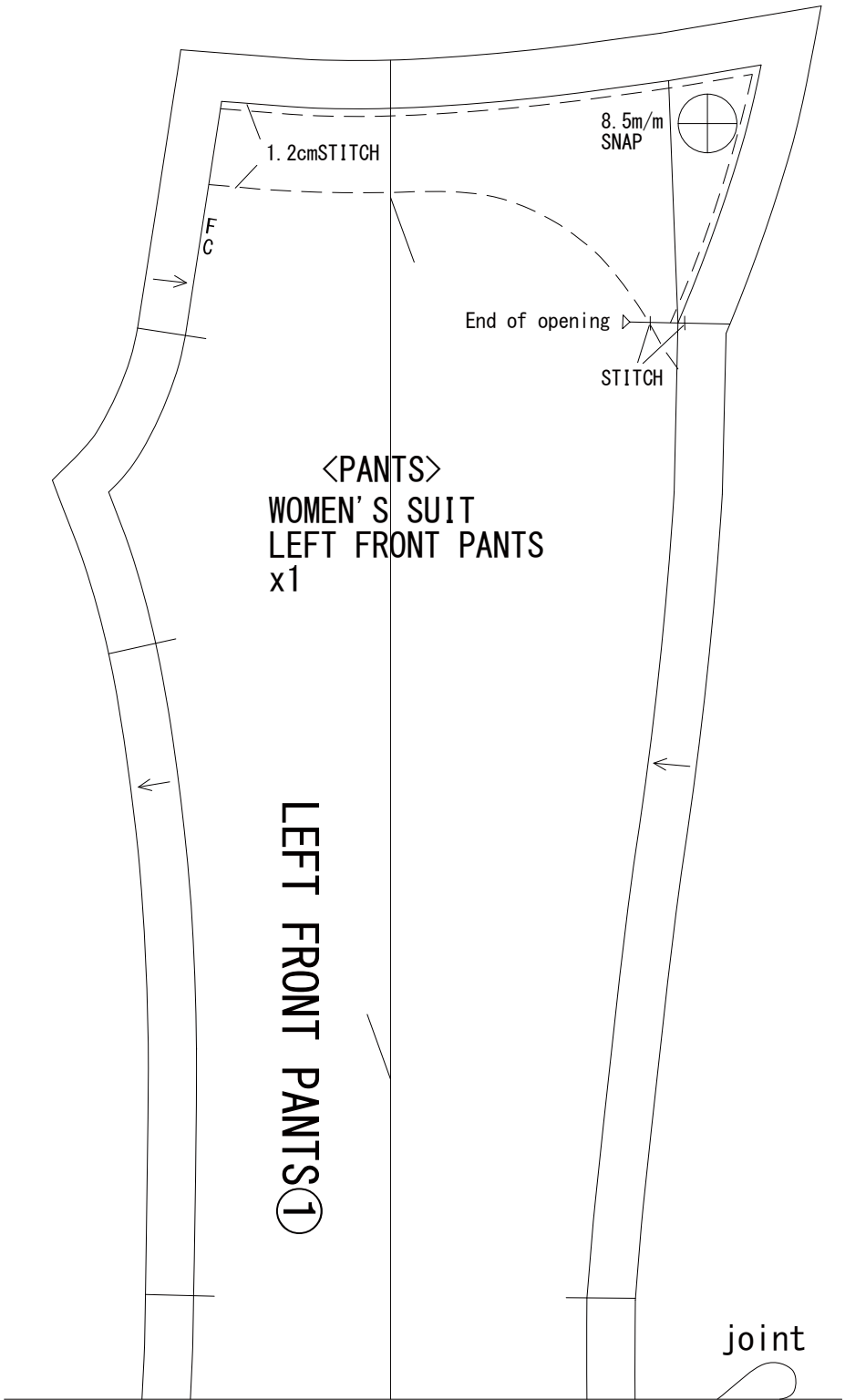
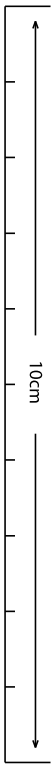

joint

LEFT FRONT PANTS ②

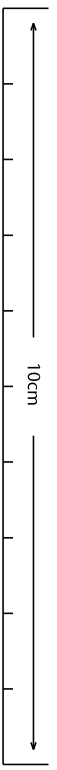
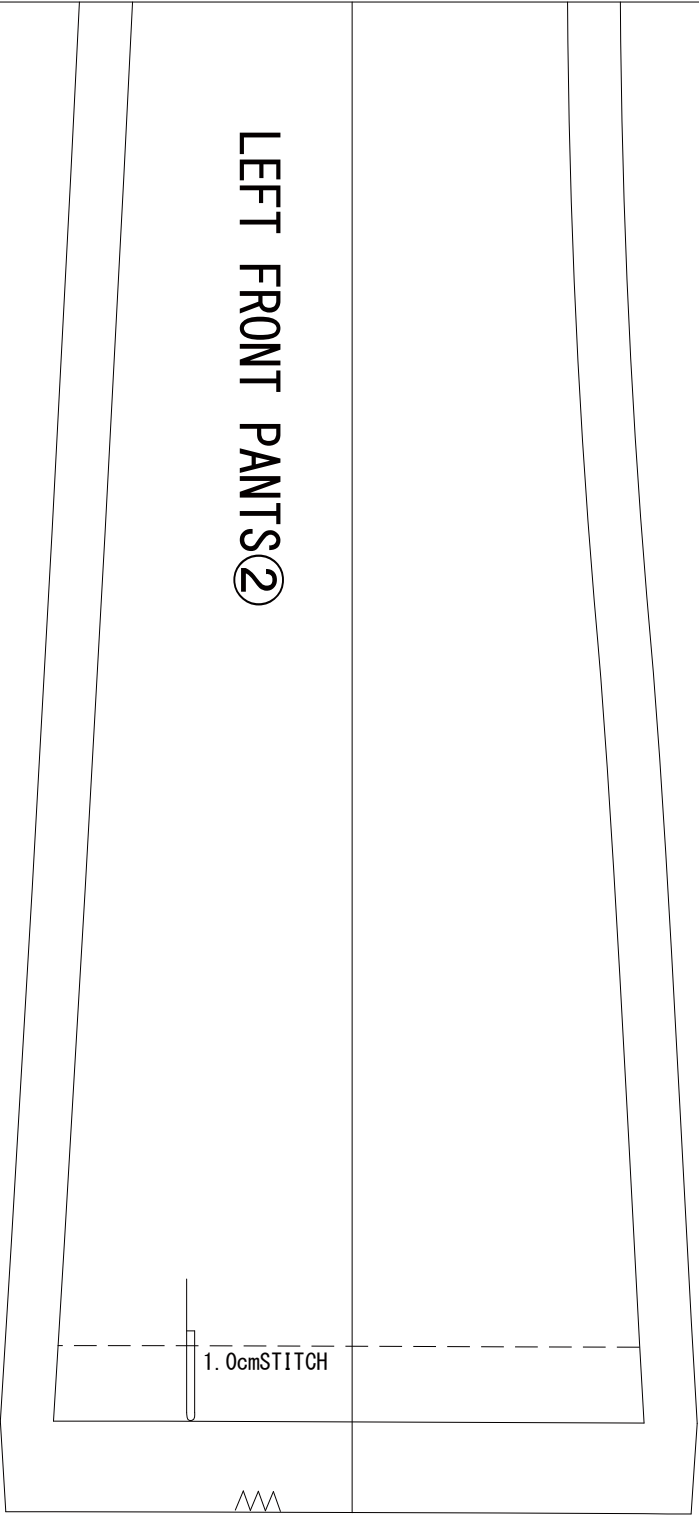

SMART DOLL  
DESIGNED BY DANNY CHOO

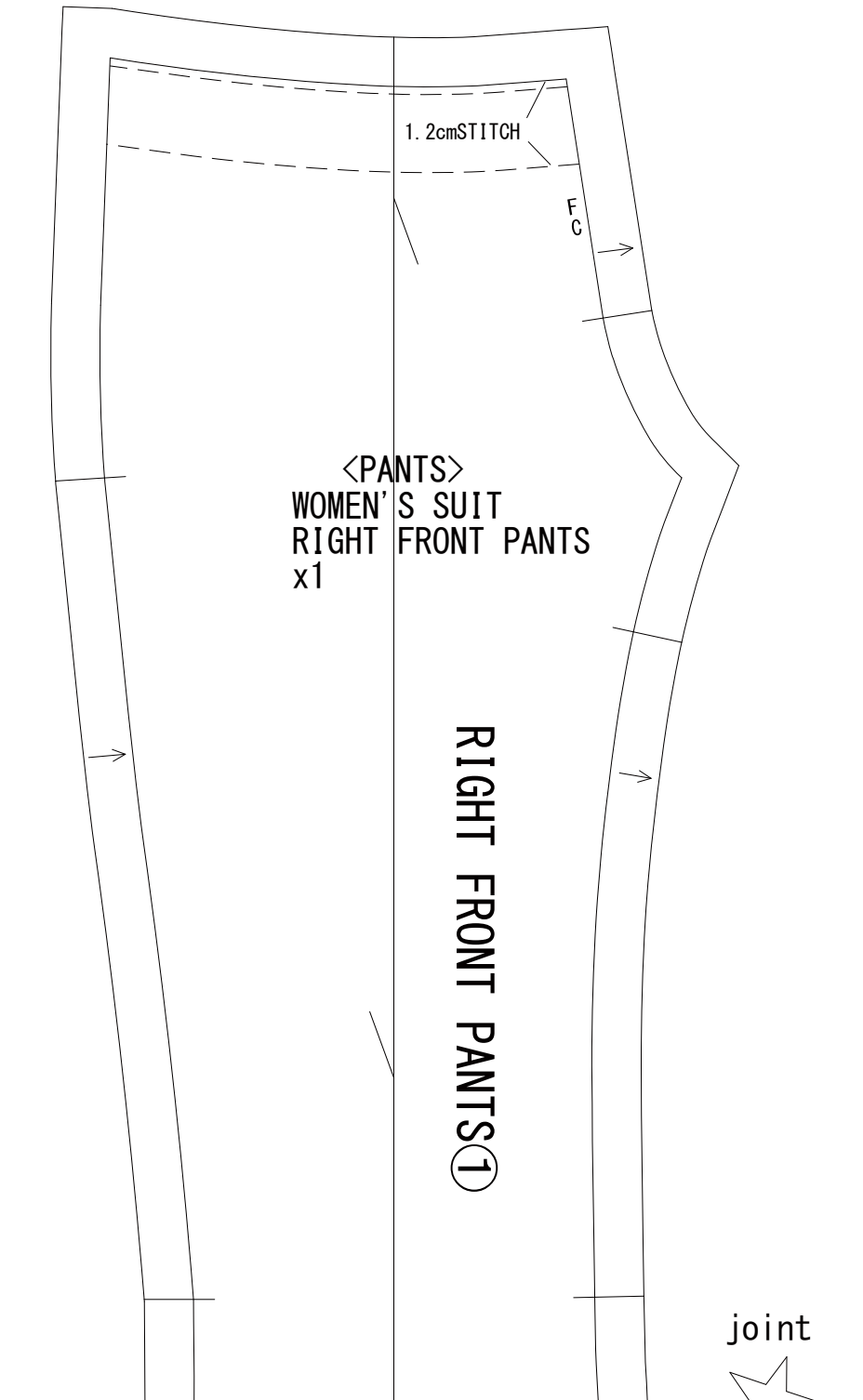
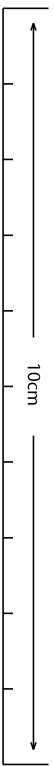



joint

**RIGHT FRONT PANTS ②**

1.0cm STITCH

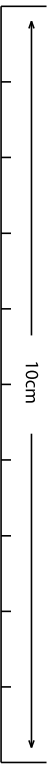

**S M A R T D O L L**

SMART DOLL  
DESIGNED BY DANNY CHOO

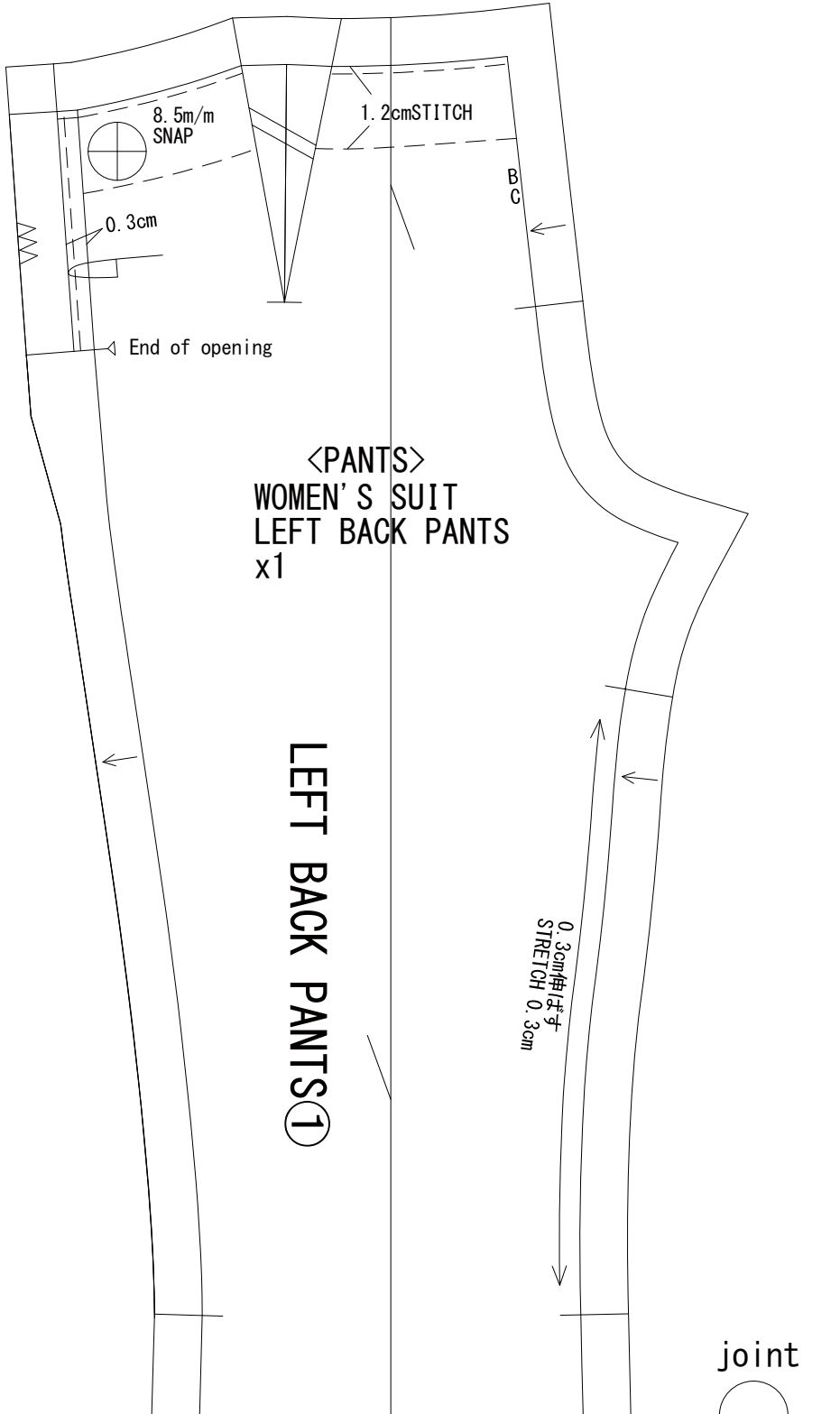

joint

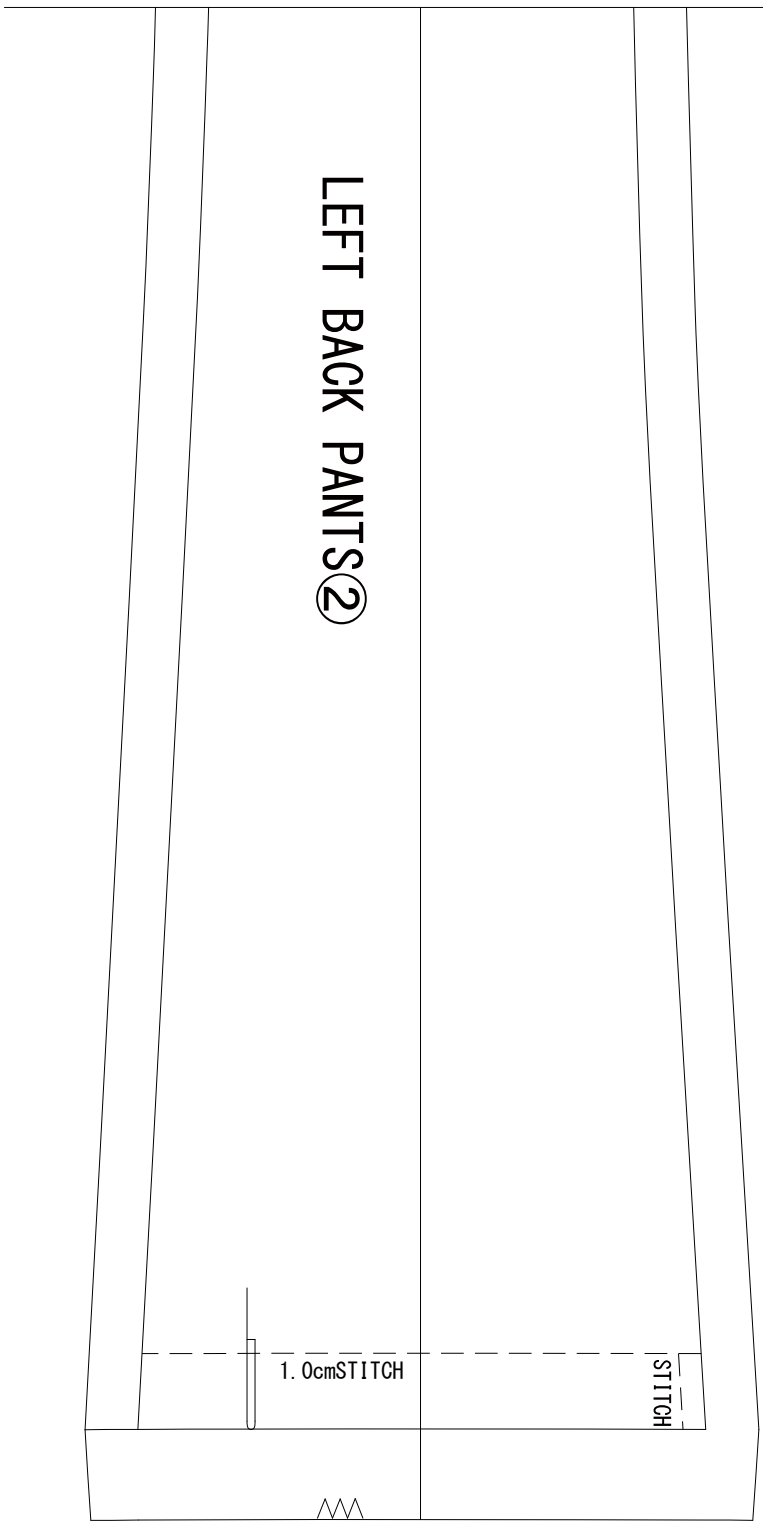

LEFT BACK PANTS ②

STITCH

1.0cm STITCH

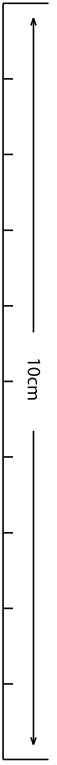

SMART DOLL

WOMEN'S SUIT

DESIGNED BY DANNY CHOO

# SMART DOLL

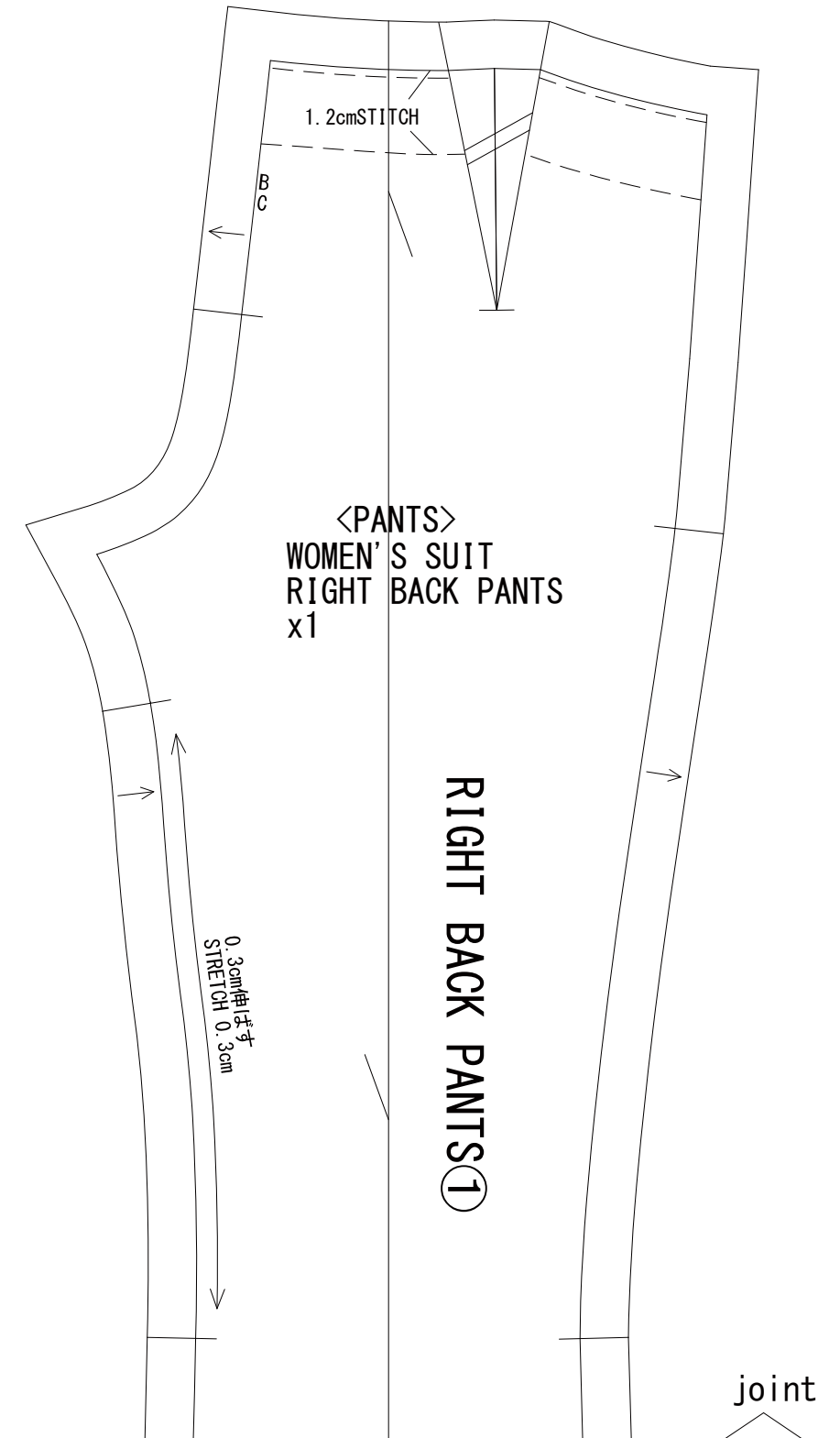

joint

RIGHT BACK PANTS ②

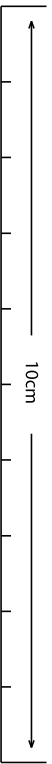
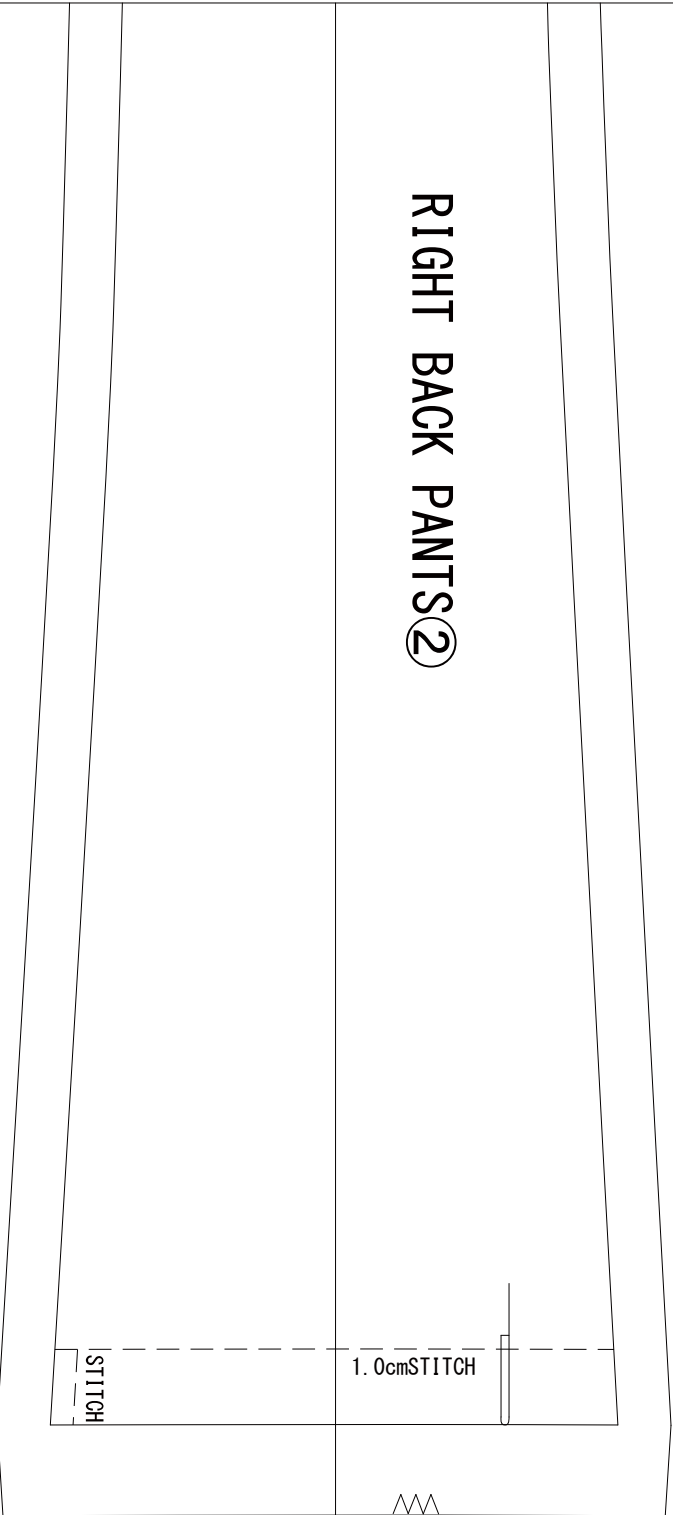

SMART DOLL

WOMEN'S SUIT

DESIGNED BY DANNY CHOO

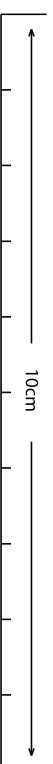
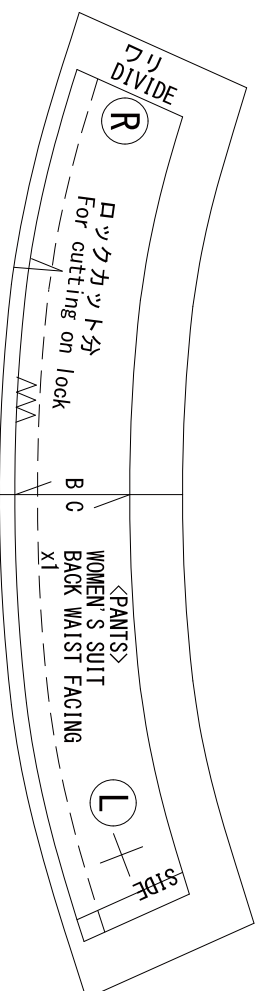
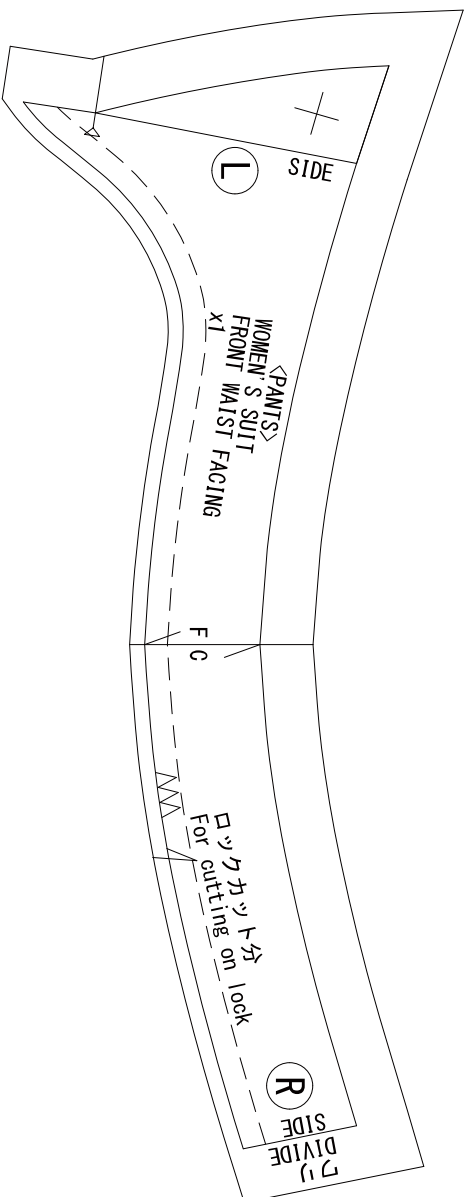

# SMART DOLL