

<THIS PATTERN IS MADE TO ACCOUNT FOR A 5% SHRINKAGE AFTER THE GARMENT HAS BEEN LAUNDERED.

MEANING THAT IF YOU DO NOT PLAN TO WASH THE GARMENT, THE PATTERN MAY LOOK AND FEEL 5% LARGE.>

<このパターンは、洗濯後に5%縮むことを考慮して作られています。

洗濯の予定がない場合、サイズが5%ほど大きく見えることがあります。>

S M A R T D O L L

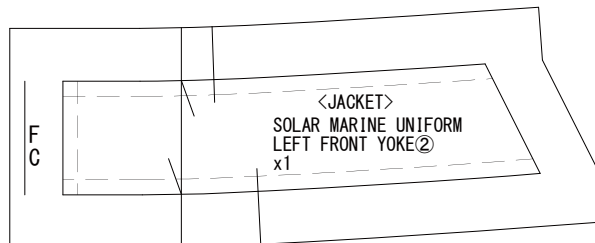
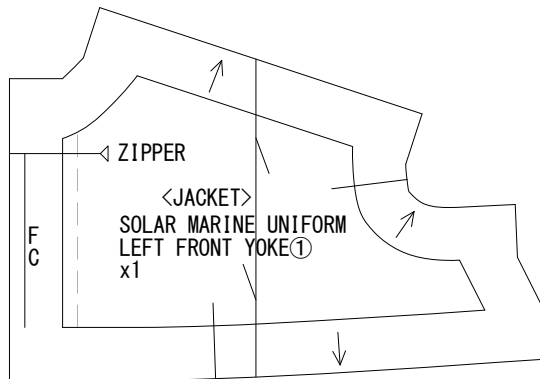
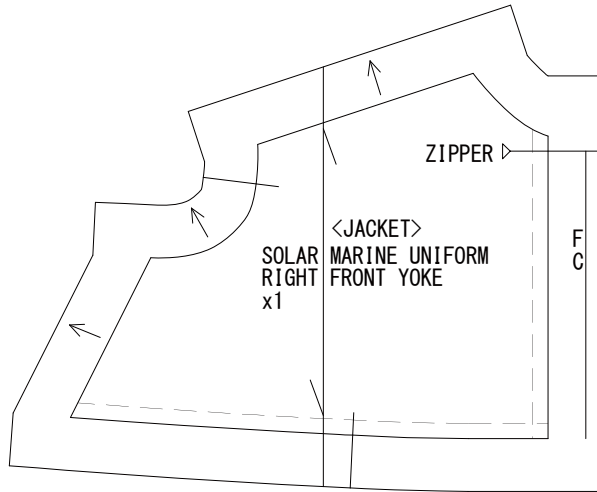
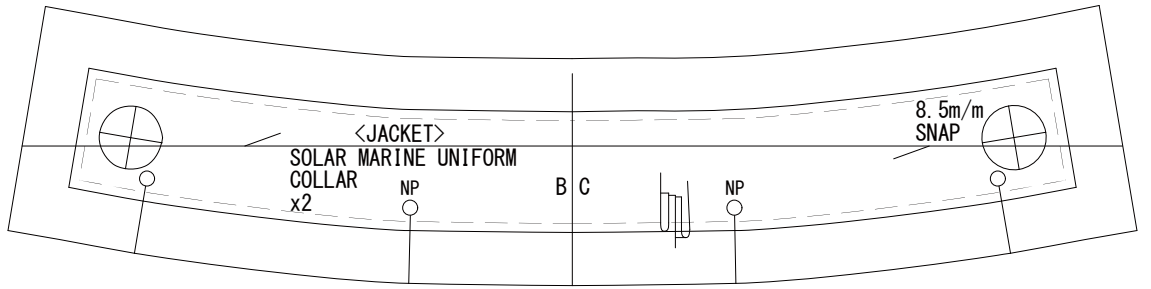
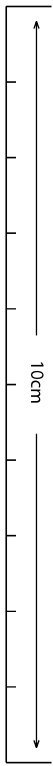

# S M A R T D O L L

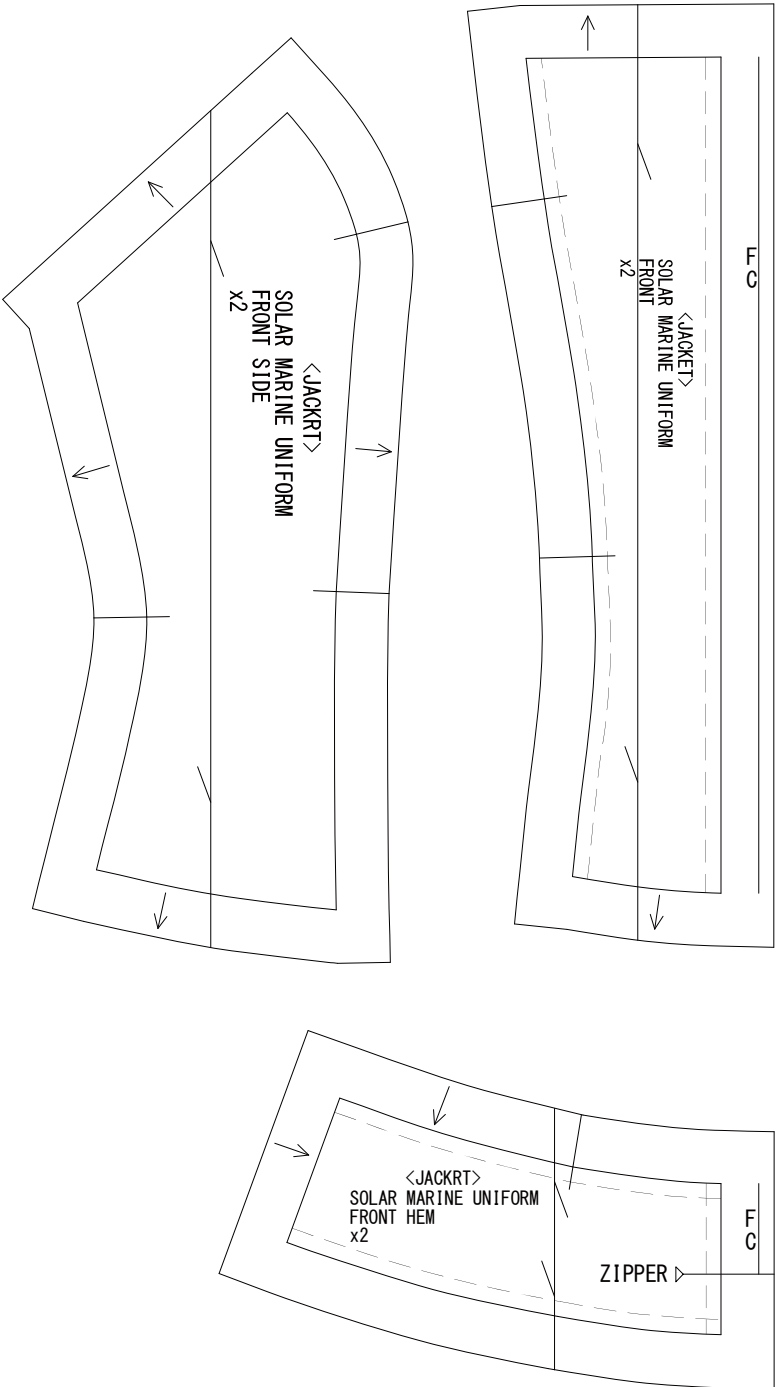
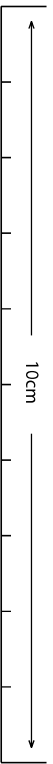

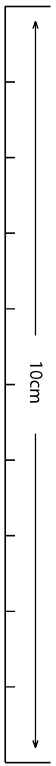
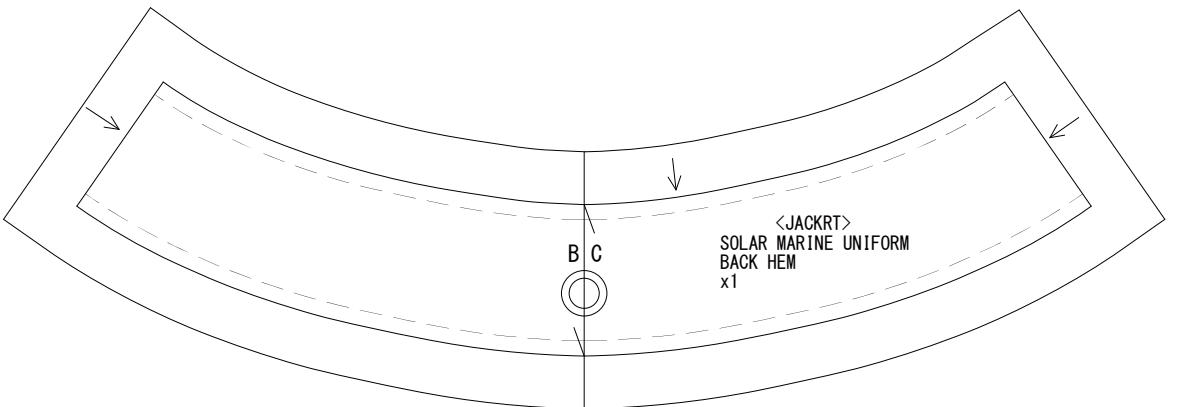
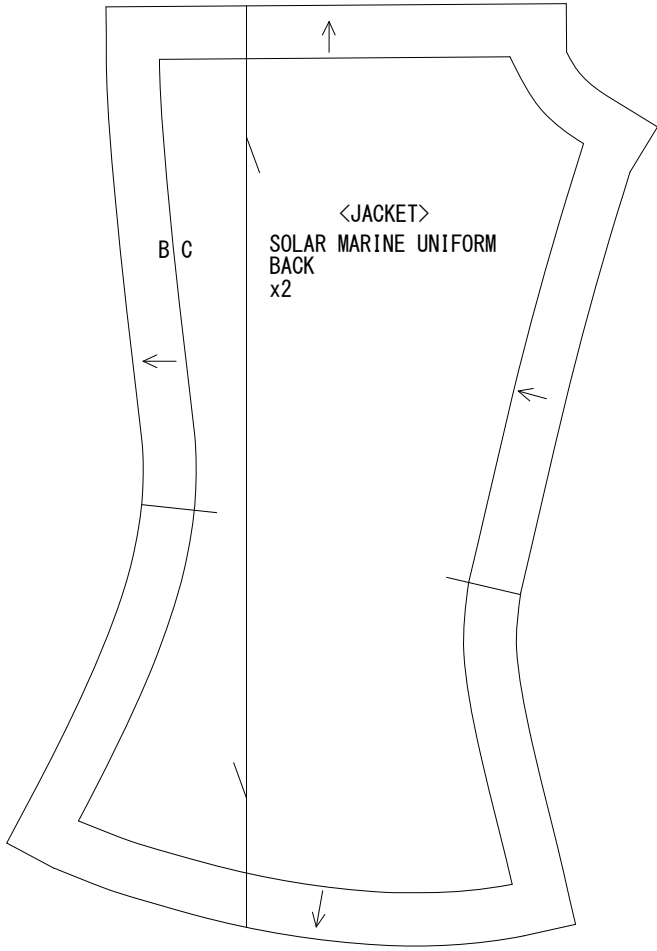
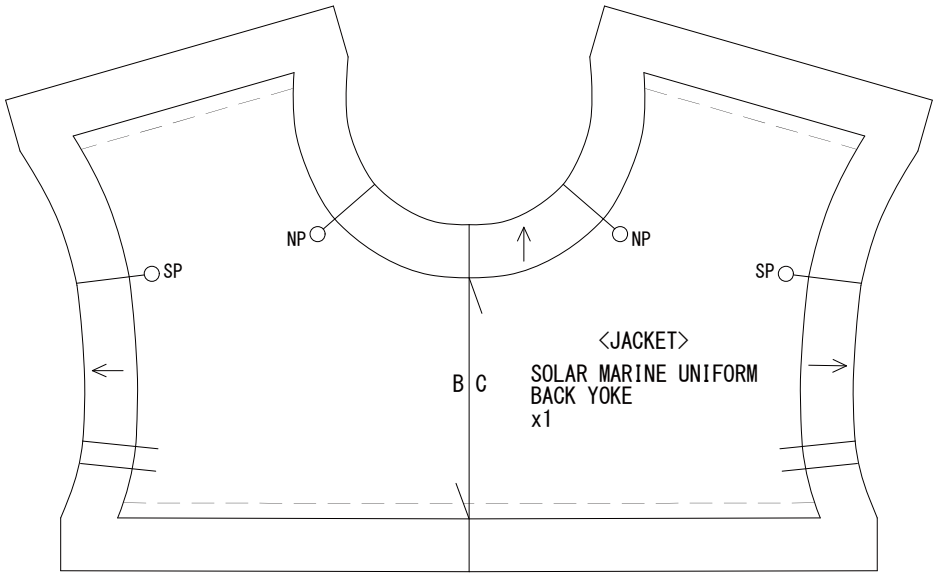

# S M A R T D O L L

# SMART DOLL

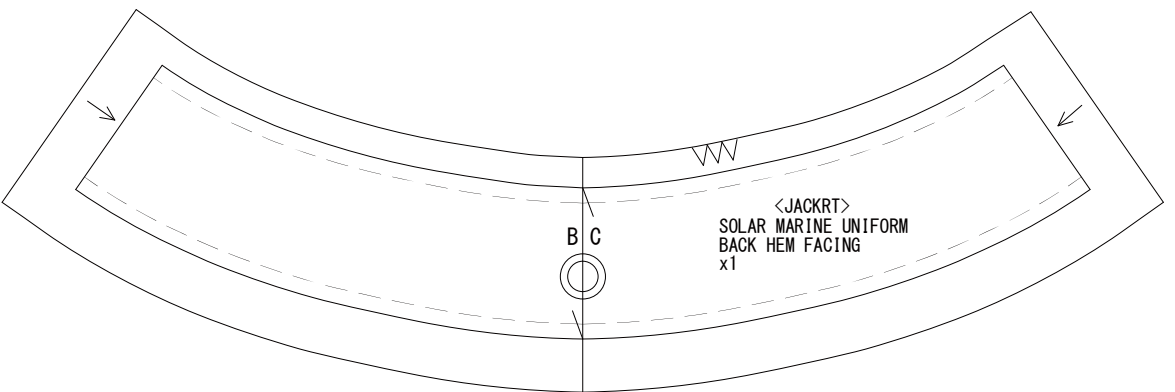
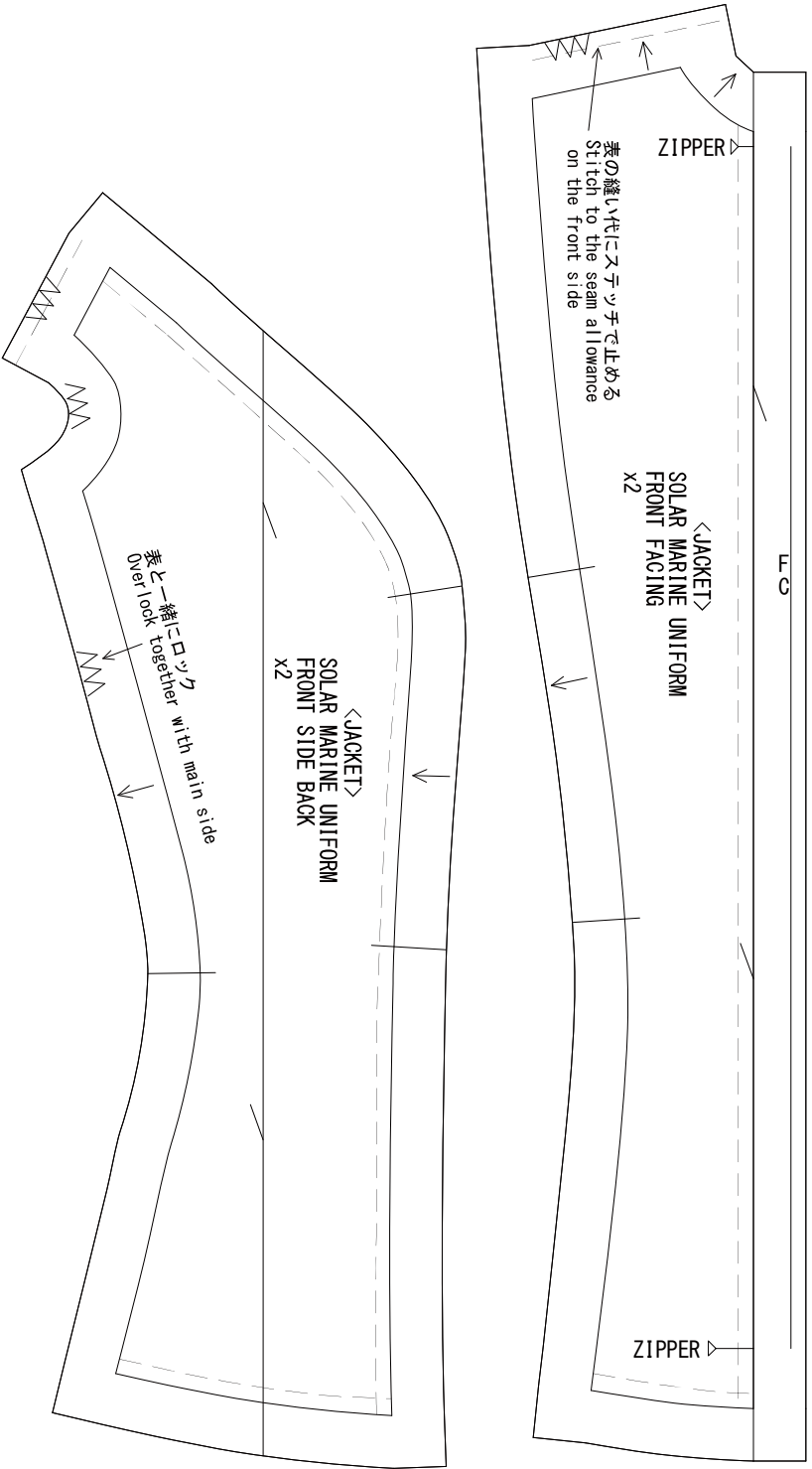
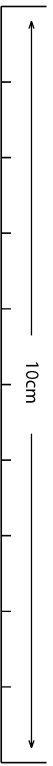

# S M A R T D O L L

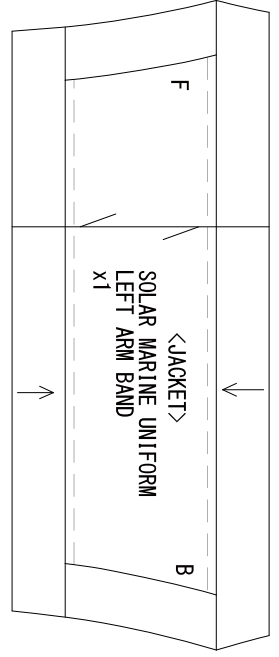
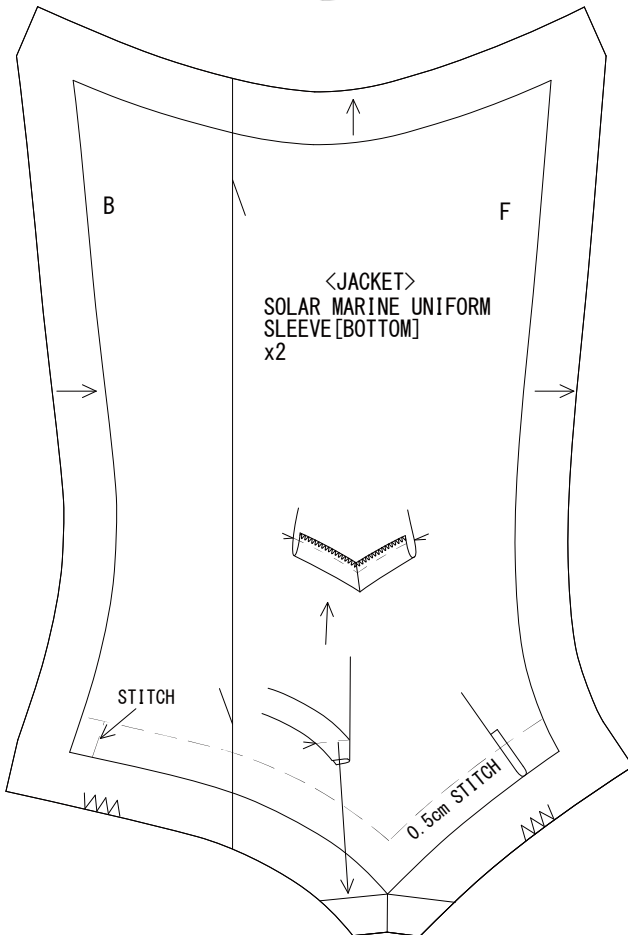
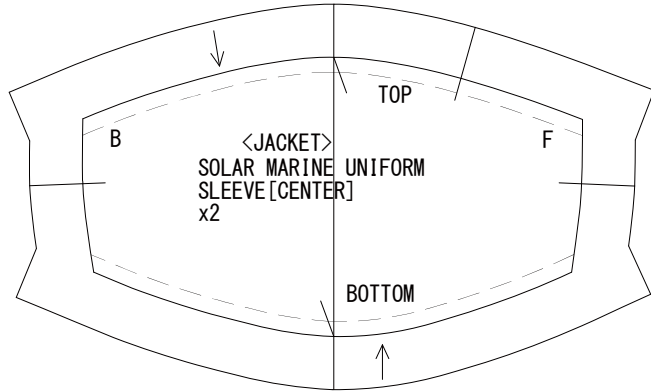
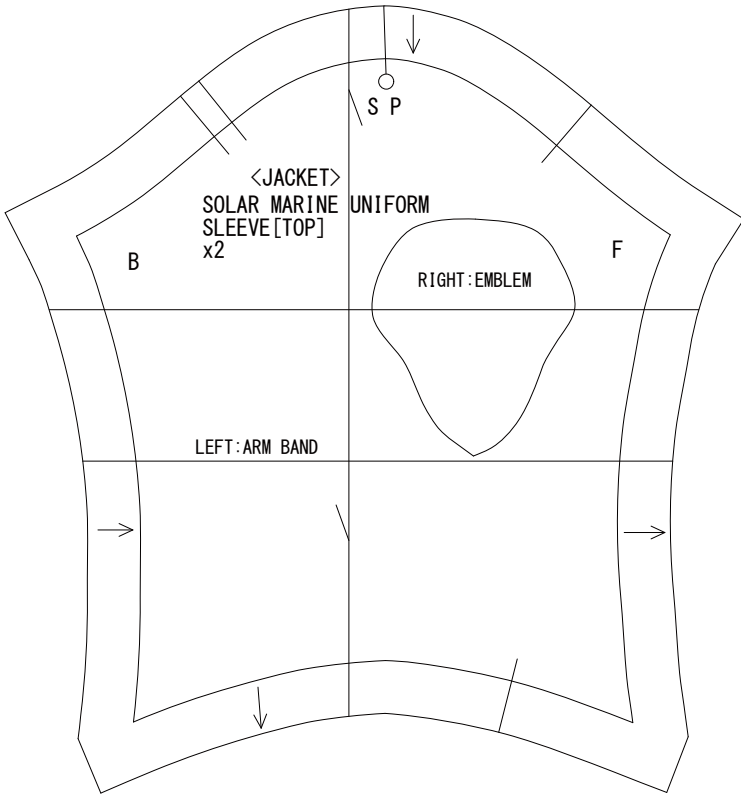
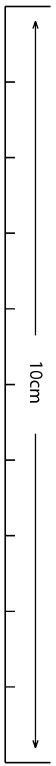

<THIS PATTERN IS MADE TO ACCOUNT FOR A 5% SHRINKAGE AFTER THE GARMENT HAS BEEN LAUNDERED.

MEANING THAT IF YOU DO NOT PLAN TO WASH THE GARMENT, THE PATTERN MAY LOOK AND FEEL 5% LARGE.>

<このパターンは、洗濯後に5%縮むことを考慮して作られています。

洗濯の予定がない場合、サイズが5%ほど大きく見えることがあります。>

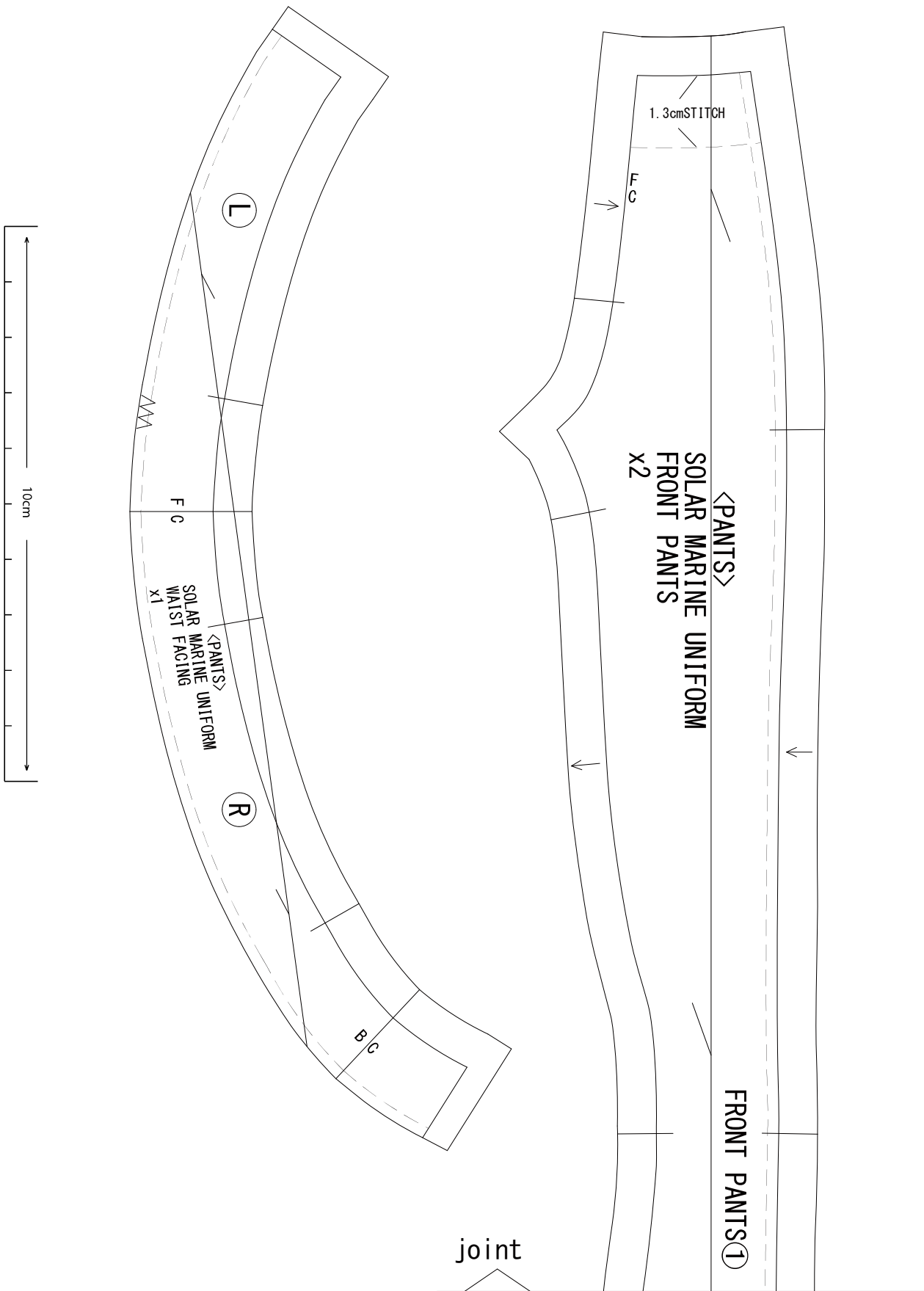

# SMART DOLL

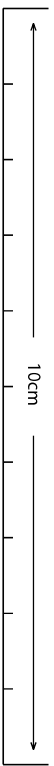
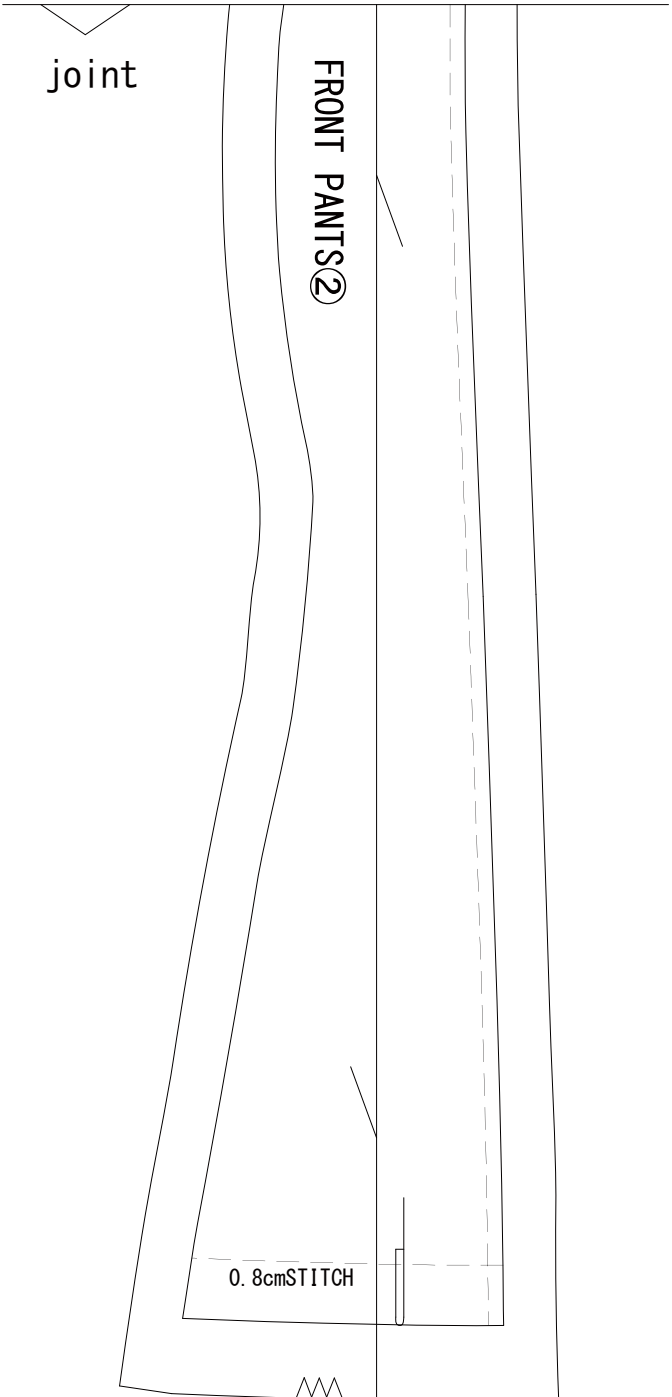

# SMART DOLL

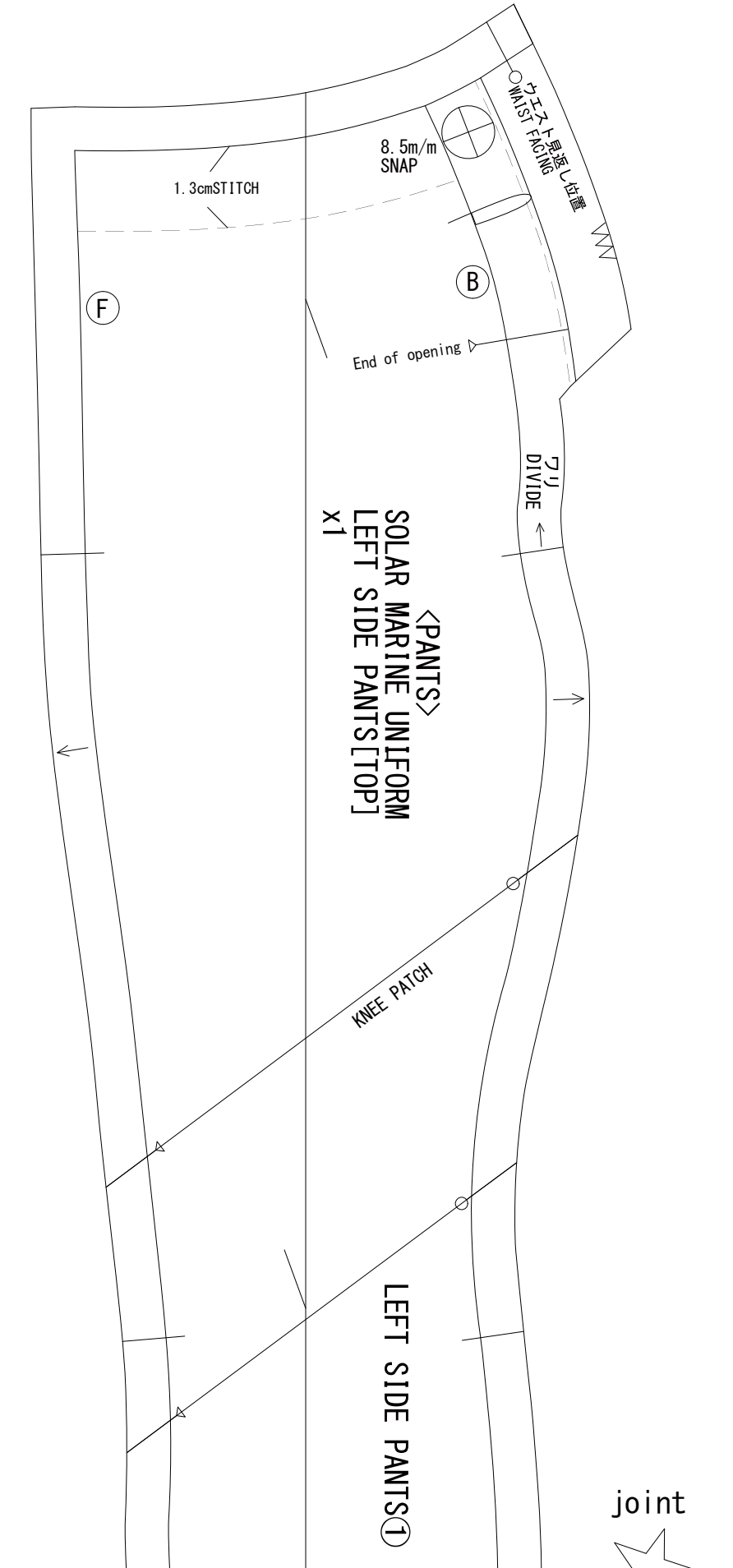
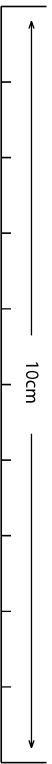



# SMART DOLL

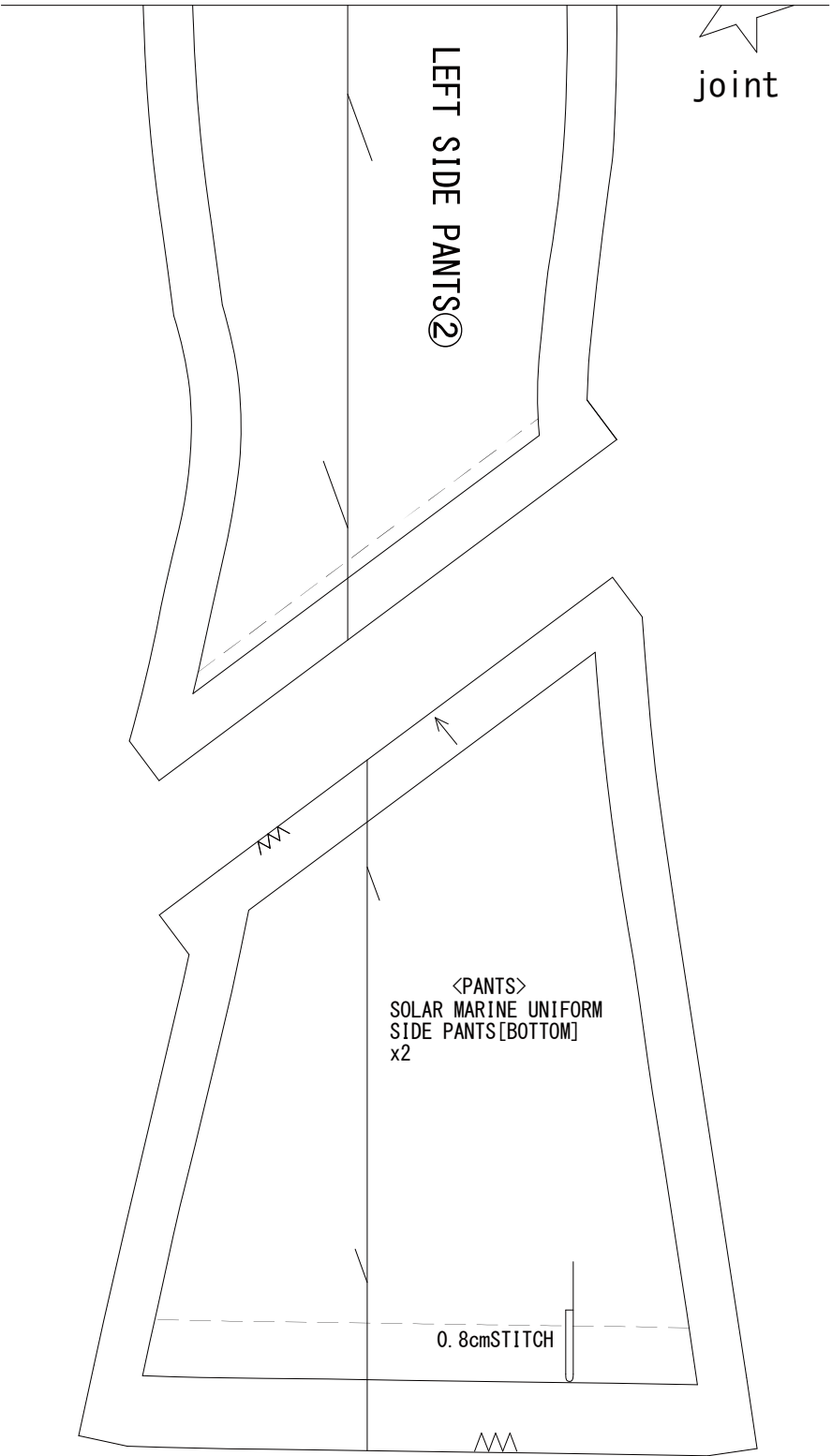
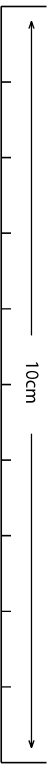

# S M A R T D O L L

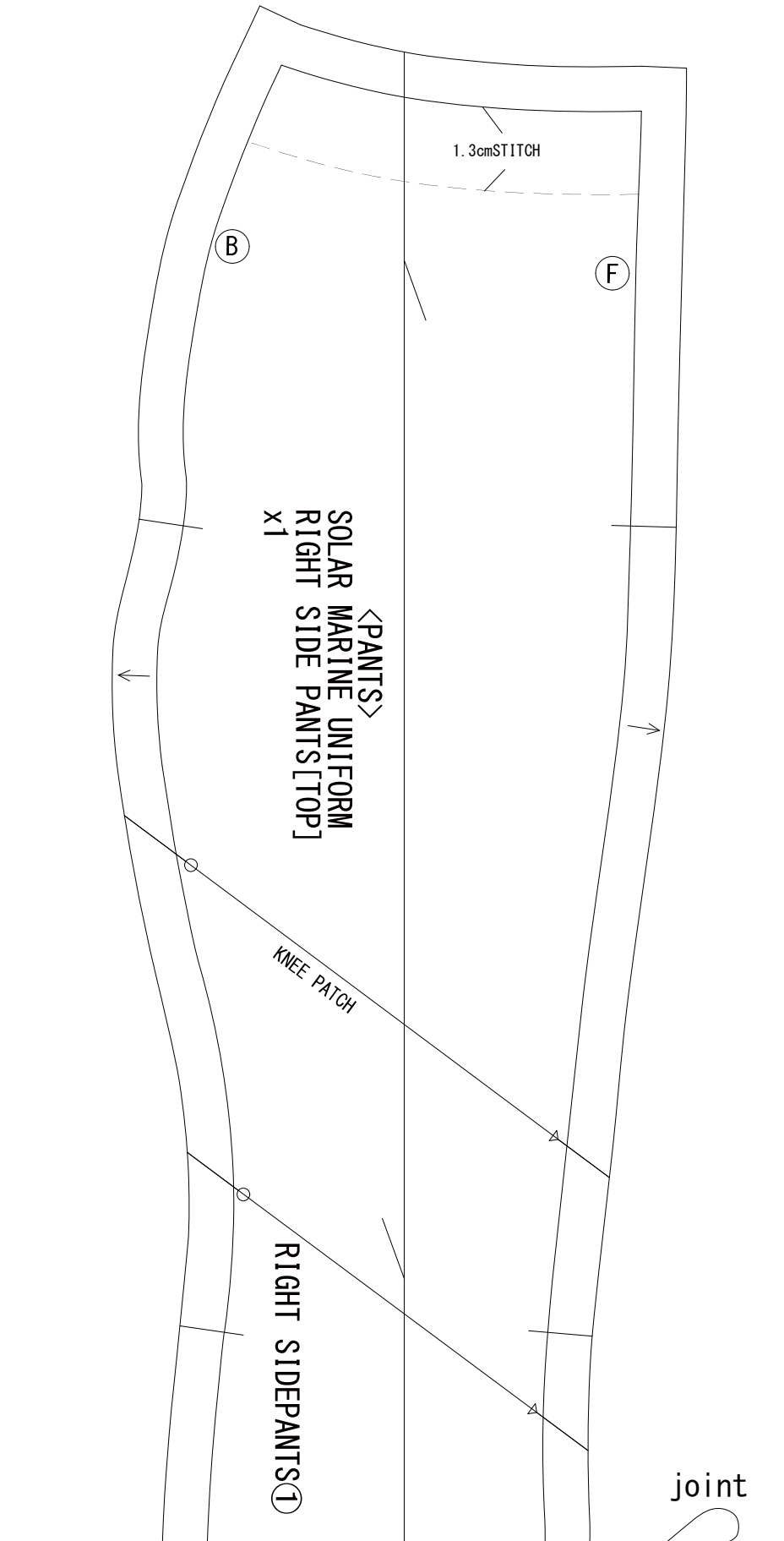

# SMART DOLL

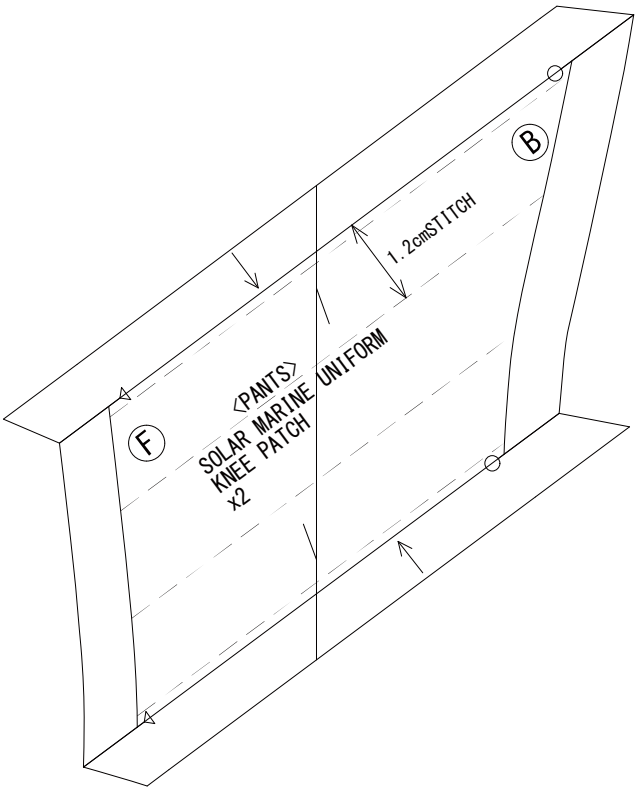
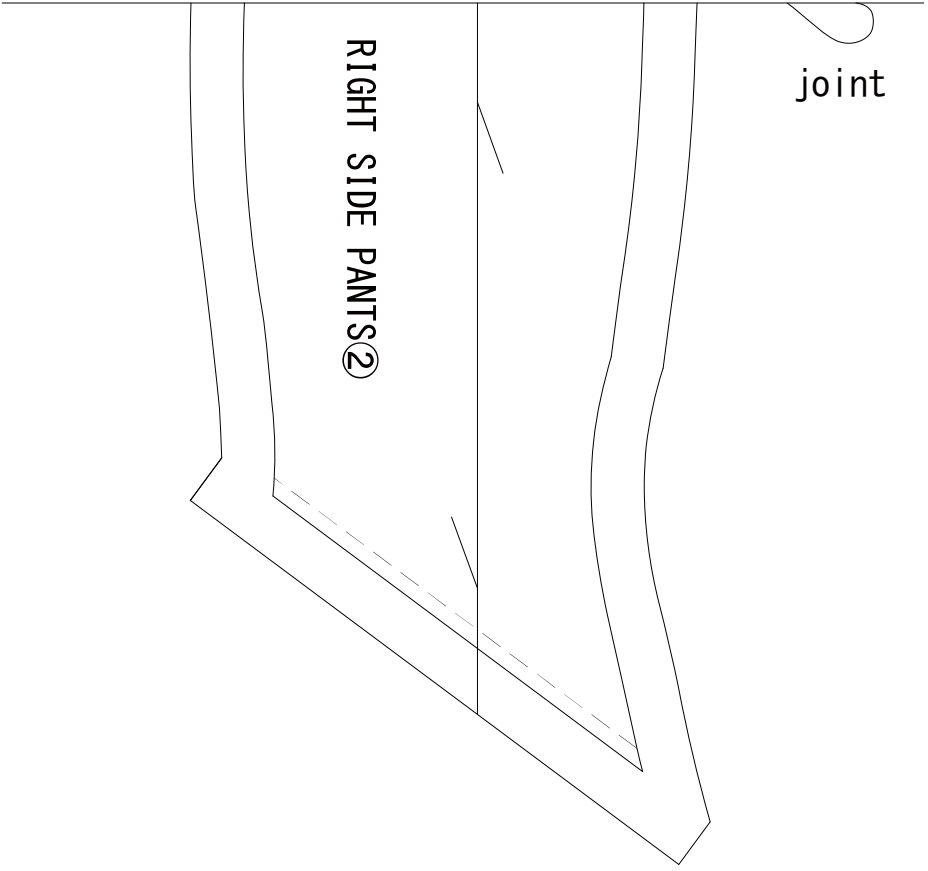
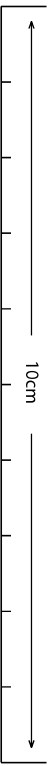

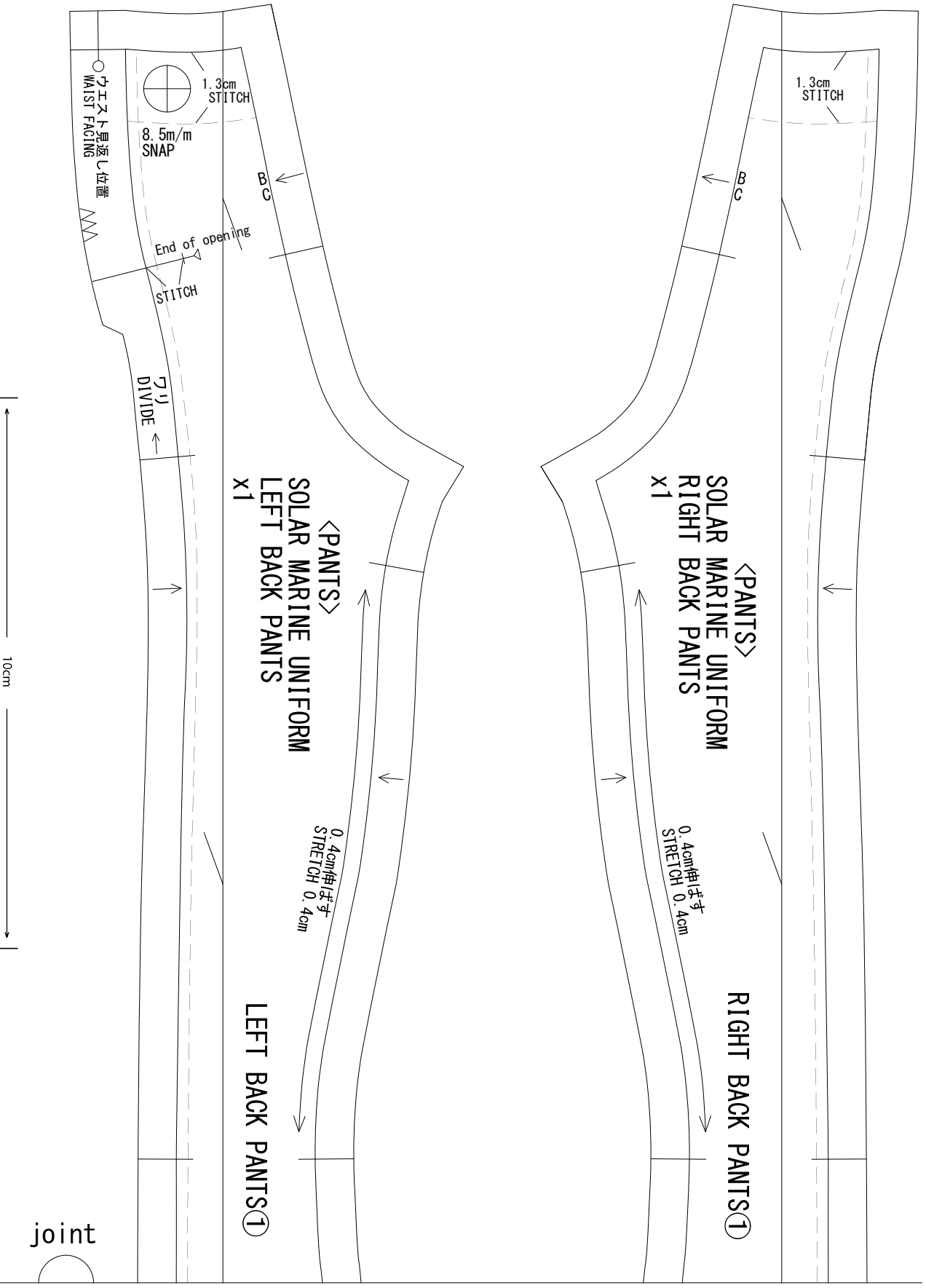

# S M A R T D O L L

# SMART DOLL

DESIGNED BY DANNY CHOO

