

# SMART DOLL

DESIGNED BY DANNY CHOO

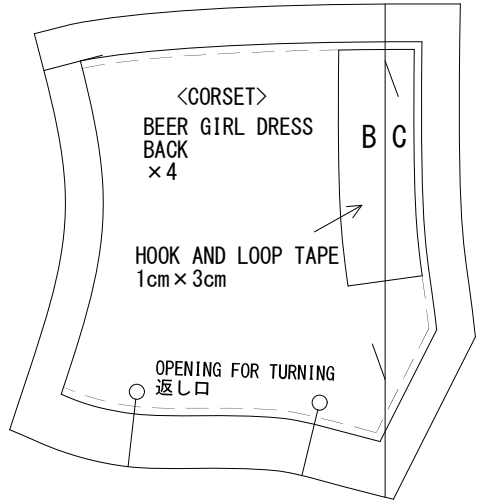

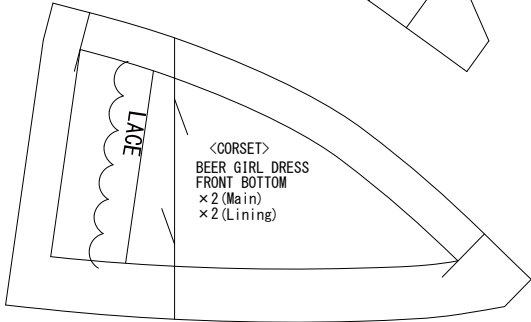
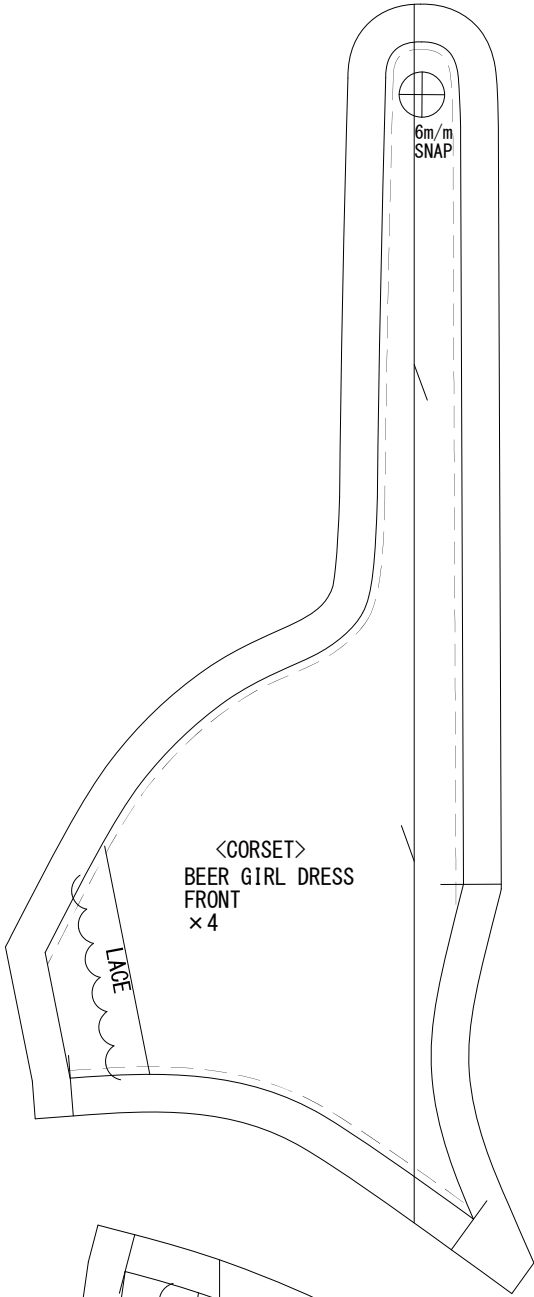
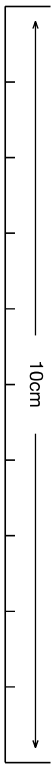
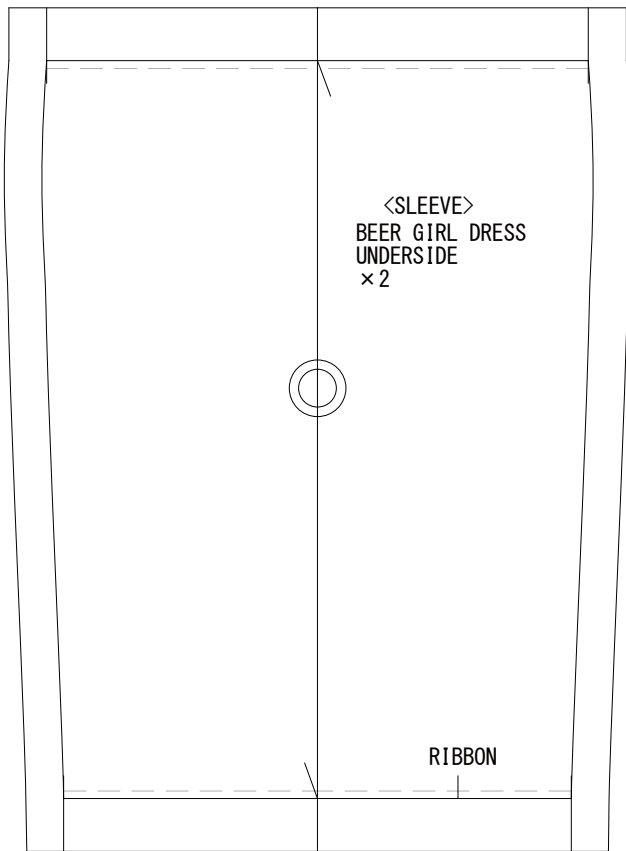
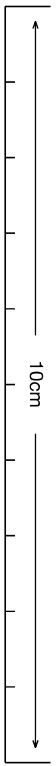
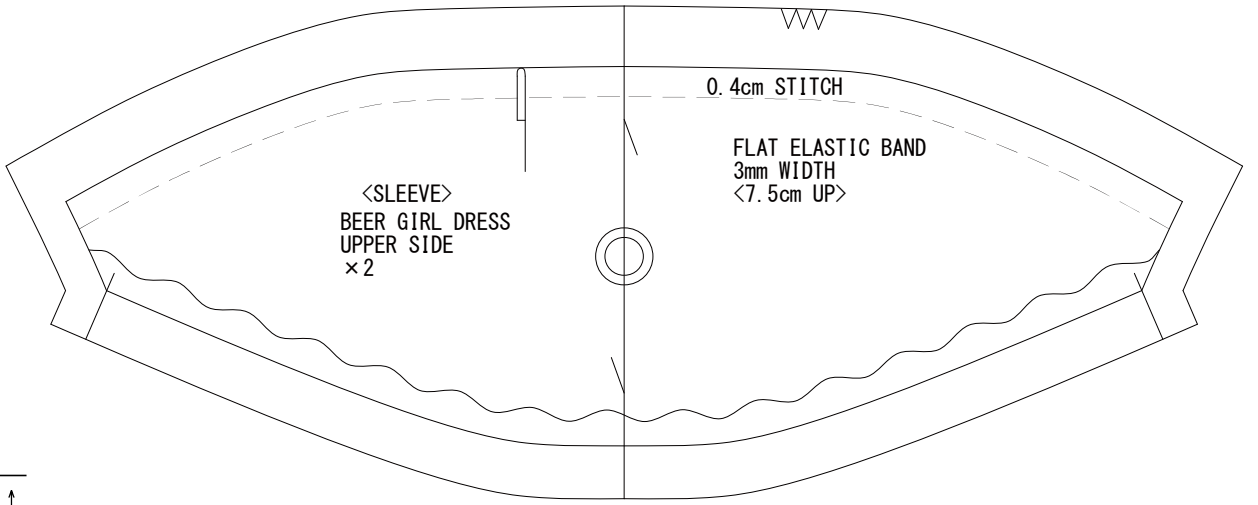

# SMART DOLL

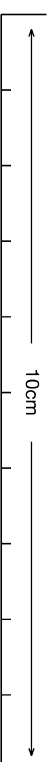
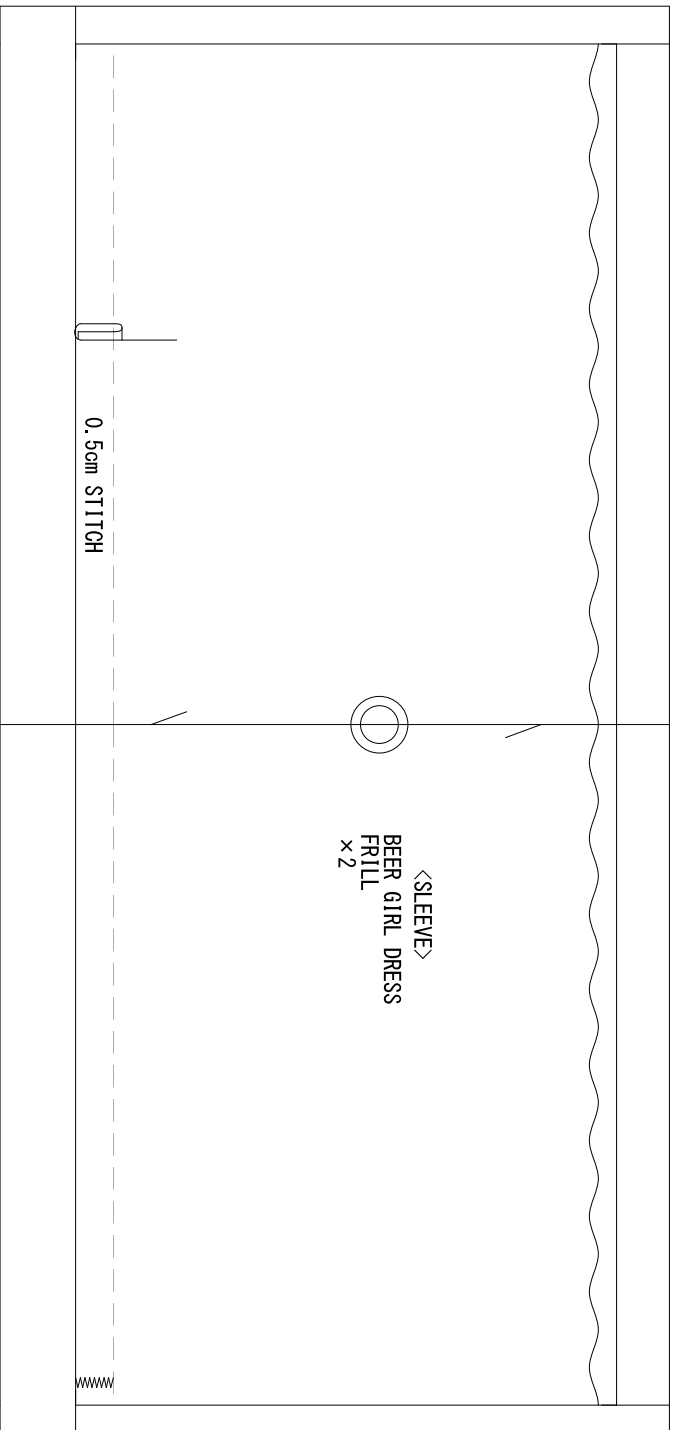

# SMART DOLL

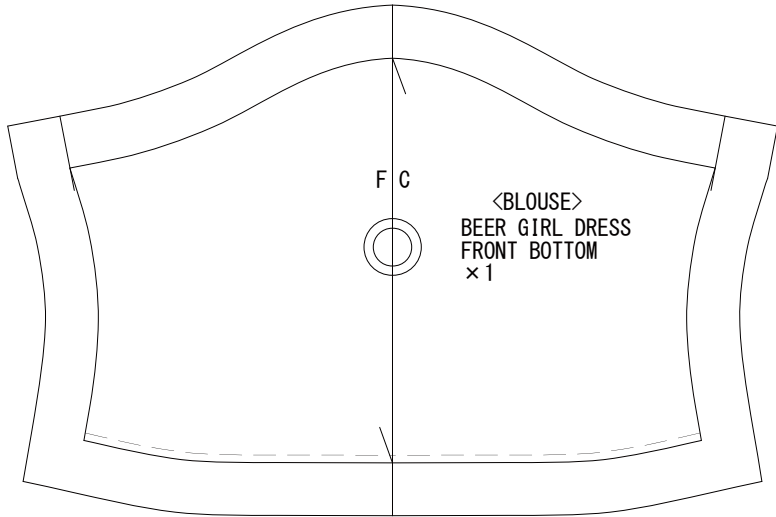
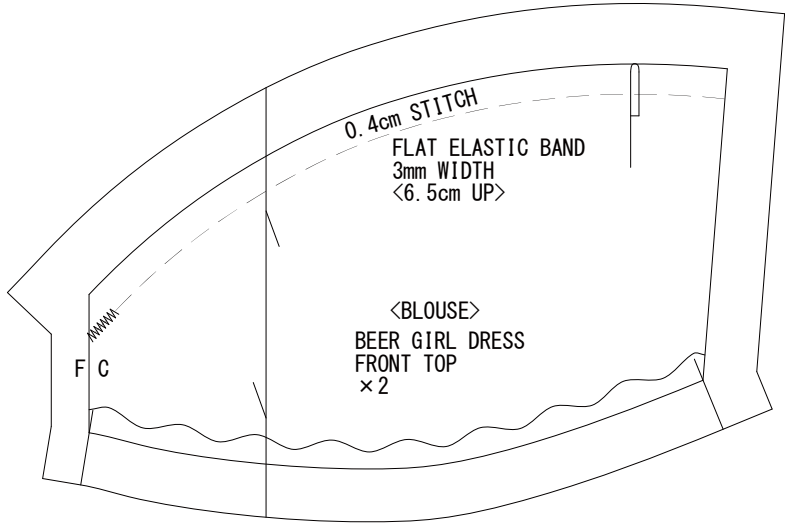
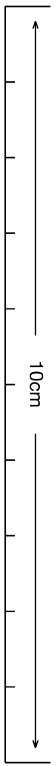

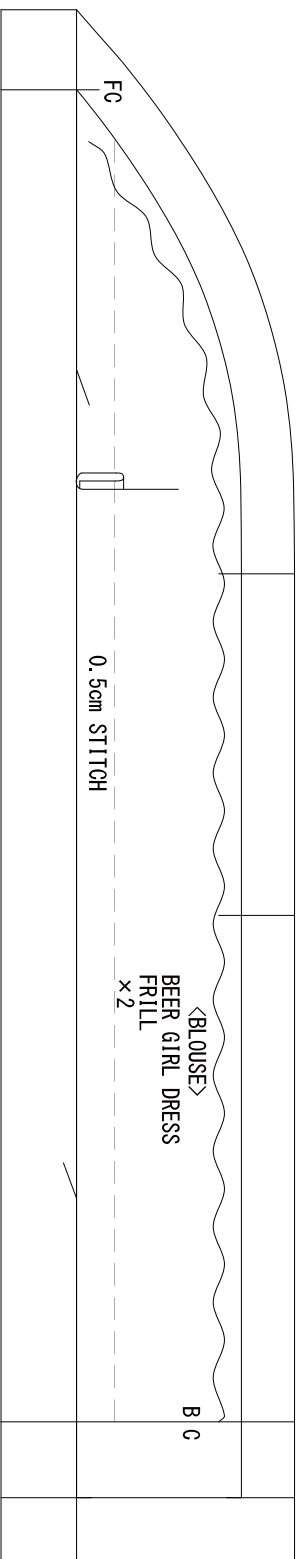
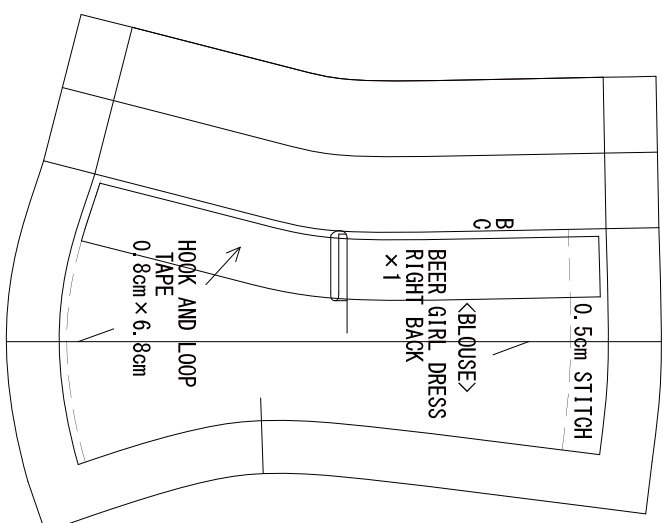
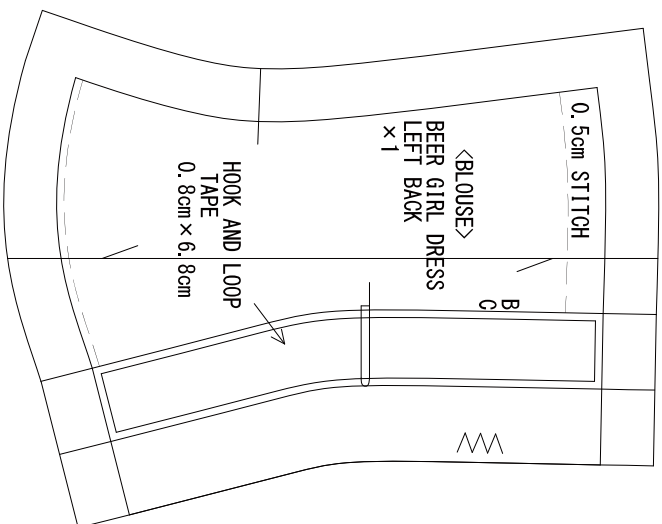
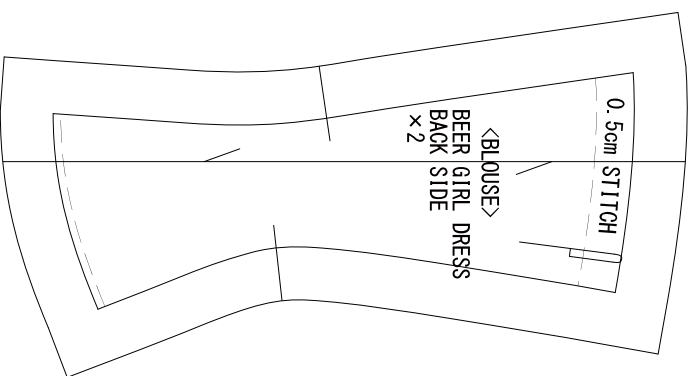

# SMART DOLL

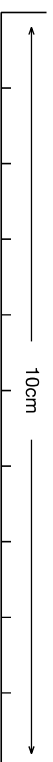
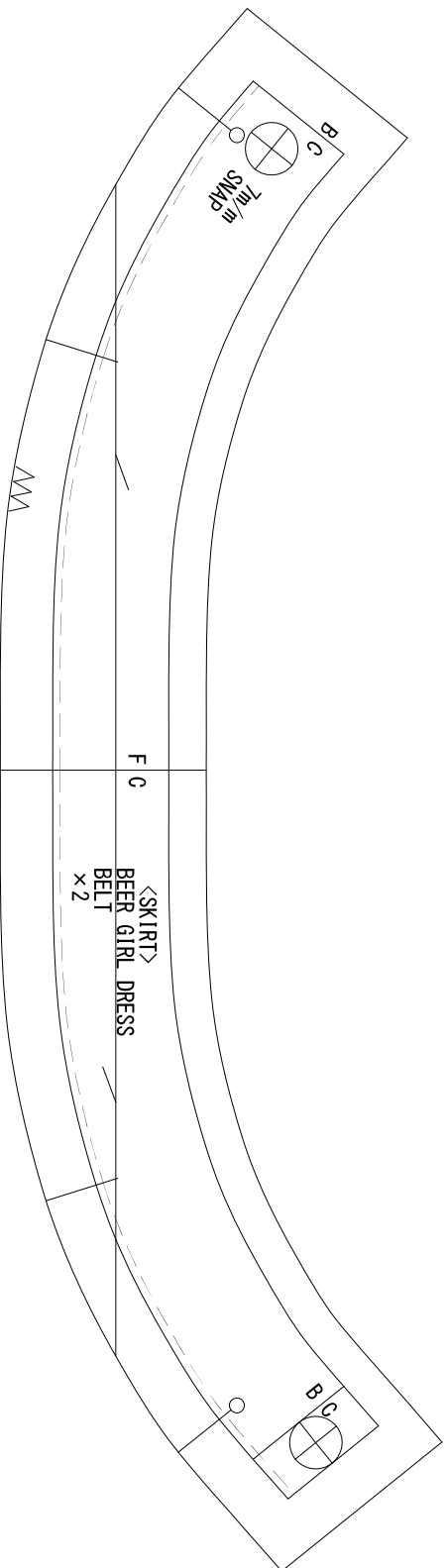

# SMART DOLL

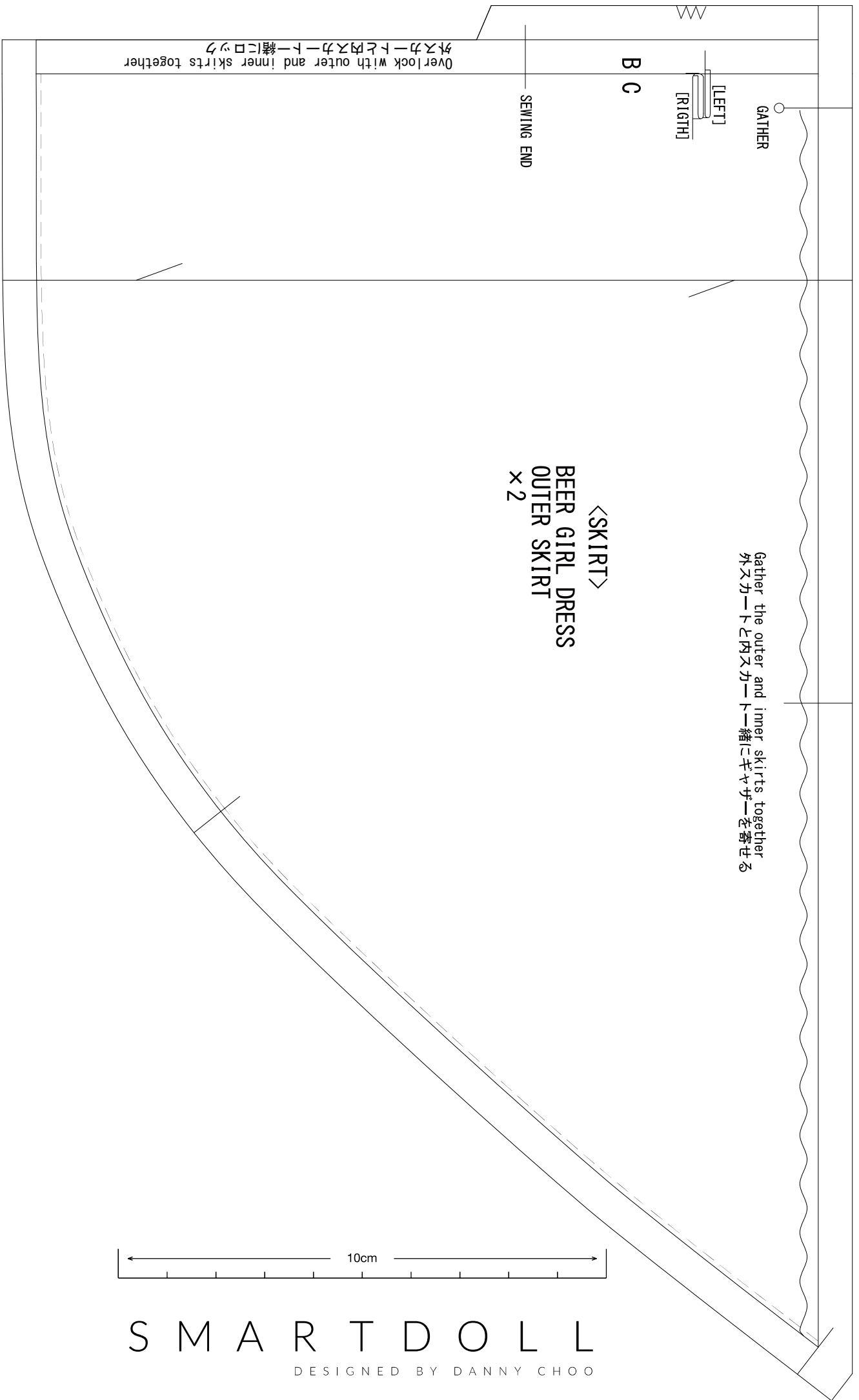

外スカートと内スカートを一緒にロック  
Overlock with outer and inner skirts together

GATHER  
[LEFT]  
[RIGHT]

SEWING END

B C

<SKIRT>  
BEER GIRL DRESS  
OUTER SKIRT  
x 2

Gather the outer and inner skirts together  
外スカートと内スカートを一緒にギャザーを寄せる

10cm

SMARTDOLL  
DESIGNED BY DANNY CHOO

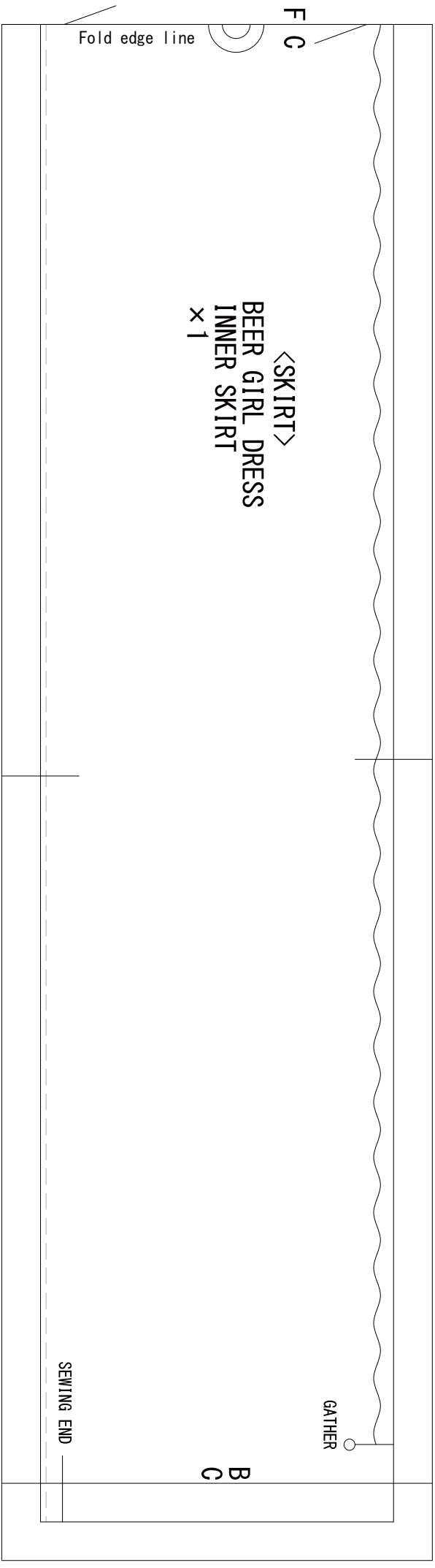

<SKIRT>  
 BEER GIRL DRESS  
 INNER SKIRT  
 x 1

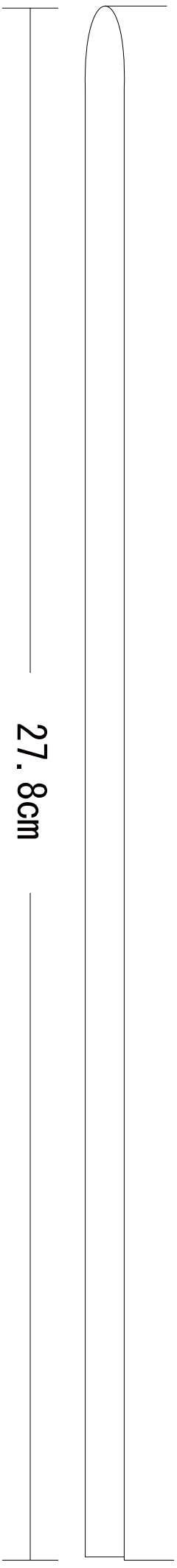

27.8cm

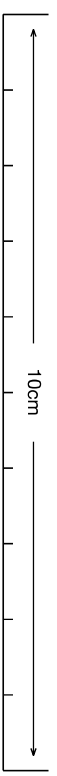

# S M A R T D O L L



joint

51.7cm

<SKIRT>  
BEER GIRL DRESS  
INNER SKIRT FRILL  
x 1

0.5cm STITCH

F C  
Fold edge line

<SKIRT>  
BEER GIRL DRESS  
OUTER SKIRT FRILL  
x 2

0.5cm STITCH

F C

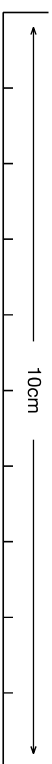

S M A R T D O L L

BEER GIRL DRESS

DESIGNED BY DANNY CHOO

# SMART DOLL

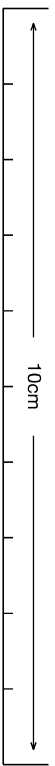

joint