

PALMA

mod-897

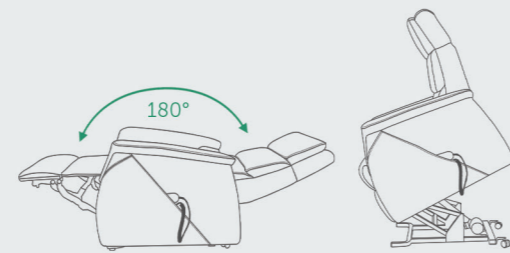

PROGETTO
RELAX

DIMENSIONS

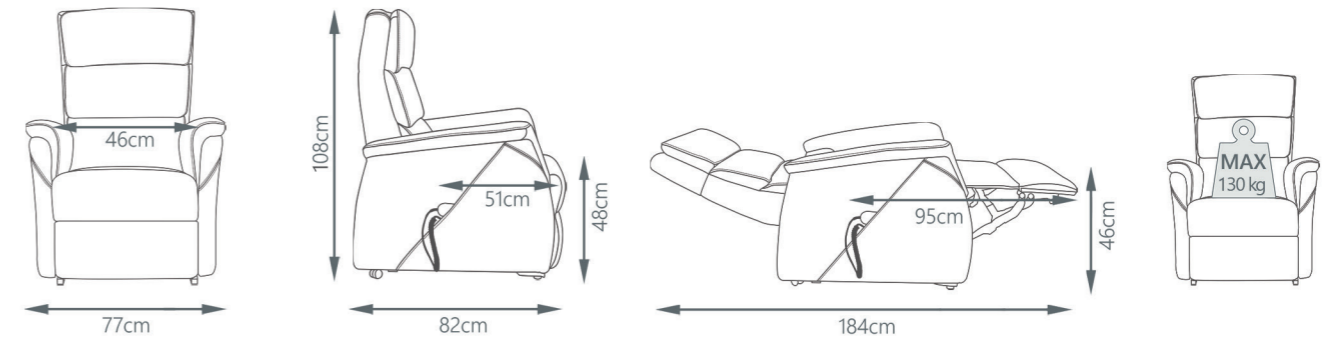

SPECIFICATIONS

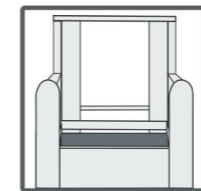

EN / FR

Solid wood and plywood
Bois massif et contre-plaqué

IT / DE

Legno massiccio e compensato
Massivholz und Sperrholz

NL / ES

Massief hout en multiplex
Madera maciza y madera contrachapada

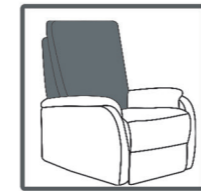

Webbing
Sangles élastiques

Cinch
Gurtband

Singelband
Cincha

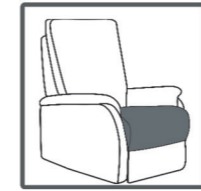

Sinuous springs
Ressorts nosag

Molle Nosag
Zig-zag Federn

Nosag veren
Muelles zig-zag

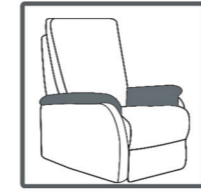

Polyurethane foam
Mousse de polyuréthane

Schiuma poliuretanic
Polyurethan Schaum

Polyurethaan schuim
Espuma de poliuretano



Recliner armchair with dual
motors power lift
Fauteuil releveur avec
bi-motors

Poltrona reclinabile
lift be-motore
Relaxsessel 2-motorisch
mit Aufstehhilfe

Relaxfauteuil 2-motorig met
sta-op hulp
Sillón relax de 2 motores con
función elevadora



Corrected grain leather 1,2-1,4mm
Cuir vachette corrigé 1,2-1,4mm

Pelle bovina coretta
e-pigmentata 1,2-1,4mm
Pigmentiertes korrigiertes
Rindsleder 1,2-1,4 mm

Rundleder gecorrigeerd en
gepigmenteerd 1,2-1,4mm
Piel de vacuno pigmentada
corregida 1,2-1,4 mm



Fabric Mozart 100% polyester
Tissu Mozart, 100% polyester

Tessuto Mozart. 100% polyester
Mozart-Stoff, 100% Polyester

Stof Mozart, 100% polyester
Tela Mozart, 100% poliéster

COLLI 1/2

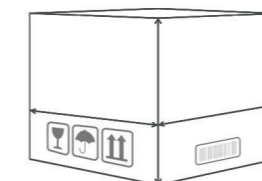

N.W.: 48 KG
G.W.: 53 KG
CBM.: 0,44 m³
85cm x 78cm x 66cm (LxWxH)

COLLI 2/2



N.W.: 7,5 KG
G.W.: 9,5 KG
CBM.: 0,13 m³
77cm x 62cm x 27cm (LxWxH)

PALMA

lift chair



FUNCTIONS



adjustable headrest

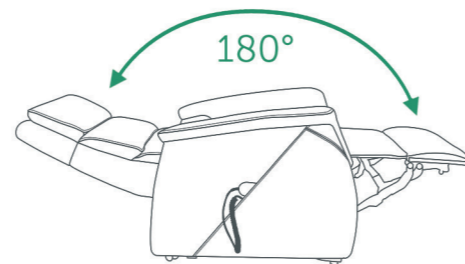

full relax



COLORS



gruppomastrotto leather 

9050 black 

9013 mokka 

9208 taupe 

mozart 

FX004 dark grey 

FX007 marble grey 

FX003 mastic 

PROGETTO
RELAX