

CRYSTORAMA

LIGHTING THE WAY FOR SIXTY YEARS



Crystorama.com

ASSEMBLY INSTRUCTION MODEL #GAB-B7312-MK

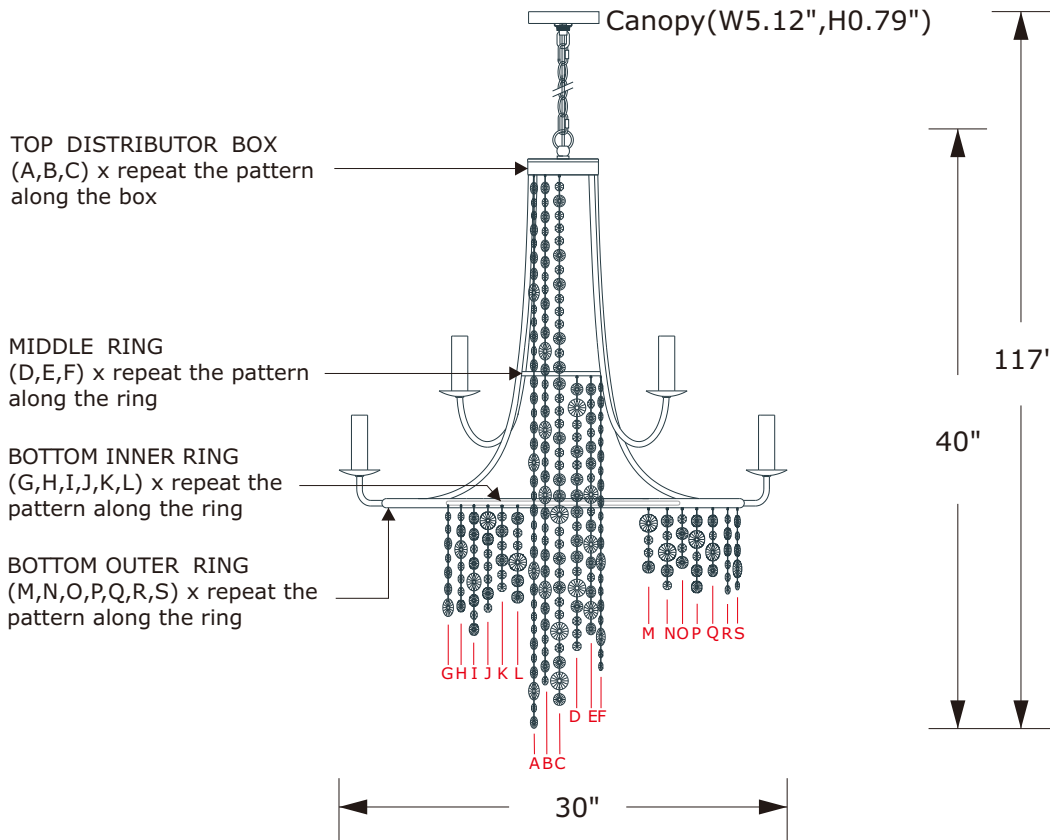

All electrical components must be installed by a licensed electrician in accordance with the National Electric Code and the appropriate local electrical codes.

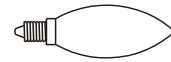

You will need 12-Candelabra Base Bulb
40 Watts Recommended 60 Watts Max.
USE LED BULBS FOR EXTENDED USE
THIS FIXTURE IS DAMP RATED

How to install

Refer to installation step on separate page.

DETAILED ILLUSTRATION

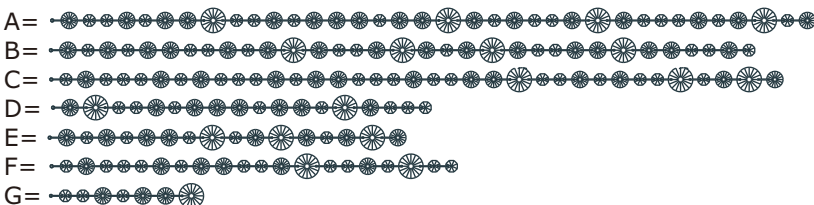
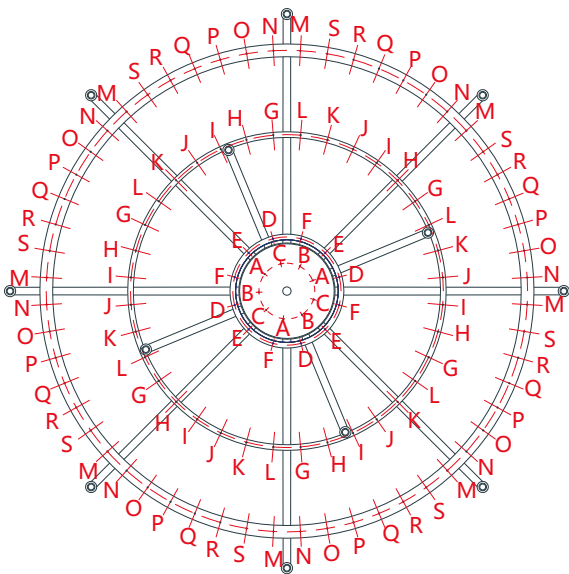

Crystal Key

- A.3 Sets. (15)14mm + (17)20mm + (4)30mm
- B.3 Sets. (13)14mm + (16)20mm + (4)30mm
- C.3 Sets. (20)14mm + (13)20mm + (3)30mm
- D.4 Sets. (8)14mm + (8)20mm + (2)30mm
- E.4 Sets. (5)14mm + (8)20mm + (3)30mm
- F.4 Sets. (12)14mm + (6)20mm + (2)30mm
- G.6 Sets. (3)14mm + (3)20mm + (1)30mm
- H.6 Sets. (4)14mm + (2)20mm + (1)30mm
- I.6 Sets. (2)14mm + (5)20mm + (1)30mm
- J.6 Sets. (4)14mm + (2)20mm + (1)30mm
- K.6 Sets. (4)14mm + (2)20mm
- L.6 Sets. (2)14mm + (3)20mm + (1)30mm
- M.8 Sets. (2)14mm + (1)20mm + (1)30mm
- N.8 Sets. (2)14mm + (2)20mm + (1)30mm
- O.8 Sets. (2)14mm + (2)20mm
- P.8 Sets. (1)14mm + (3)20mm + (1)30mm
- Q.8 Sets. (1)14mm + (2)20mm + (1)30mm
- R.8 Sets. (4)14mm + (2)20mm
- S.8 Sets. (2)14mm + (2)20mm + (1)30mm

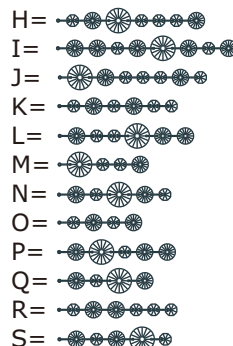

WARNING: This product can expose you to Lead, which is known to the State of California to cause cancer and/or birth defects or reproductive harm. For more information go to www.P65Warnings.ca.gov.

CRYSTORAMA

LIGHTING THE WAY FOR SIXTY YEARS



Crystorama.com

PART NUMBER MODEL #GAB-B7312-MK

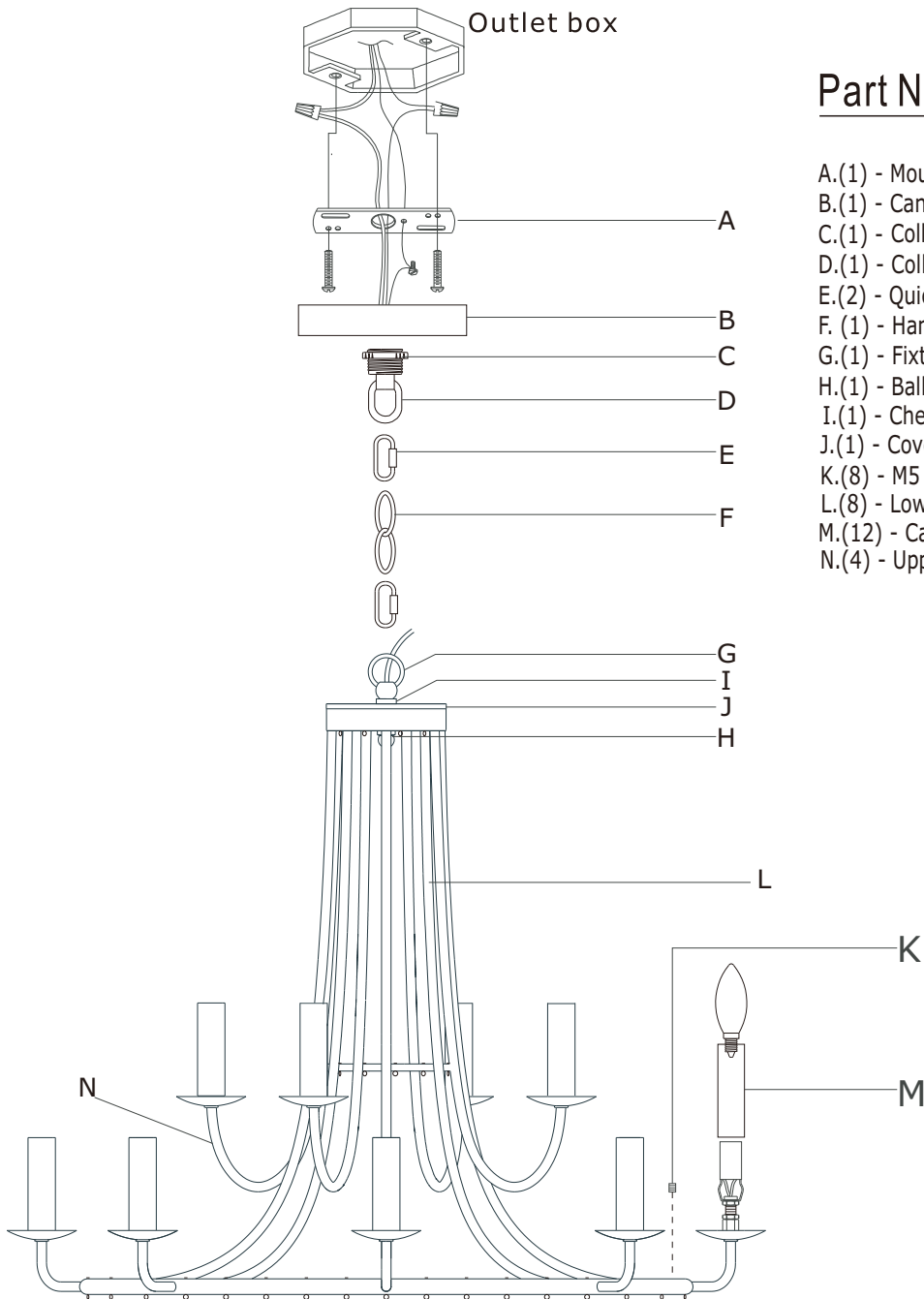

Part Number

- A.(1) - Mounting Hardware
- B.(1) - Canopy(W5.12",H0.79") #XRE7312MKCAN5.12IN
- C.(1) - Collar Ring
- D.(1) - Collar Loop
- E.(2) - Quick Link
- F.(1) - Hanging Chain(72",4mm) #XRE7304MKCHA4MM
- G.(1) - Fixture Loop
- H.(1) - Ball Nut #XRE7306MKBANUT
- I.(1) - Check ring(D20xH5mm)
- J.(1) - Cover(D132xH5mm)
- K.(8) - M5 screw
- L.(8) - Lower Arms
- M.(12) - Candle Sleeve(W0.87",H3.94") #XRE7312MKCDL3.94IN
- N.(4) - Upper Arms

CRYSTORAMA

LIGHTING THE WAY FOR SIXTY YEARS



Crystorama.com

ASSEMBLY INSTRUCTION MODEL #GAB-B7312-MK

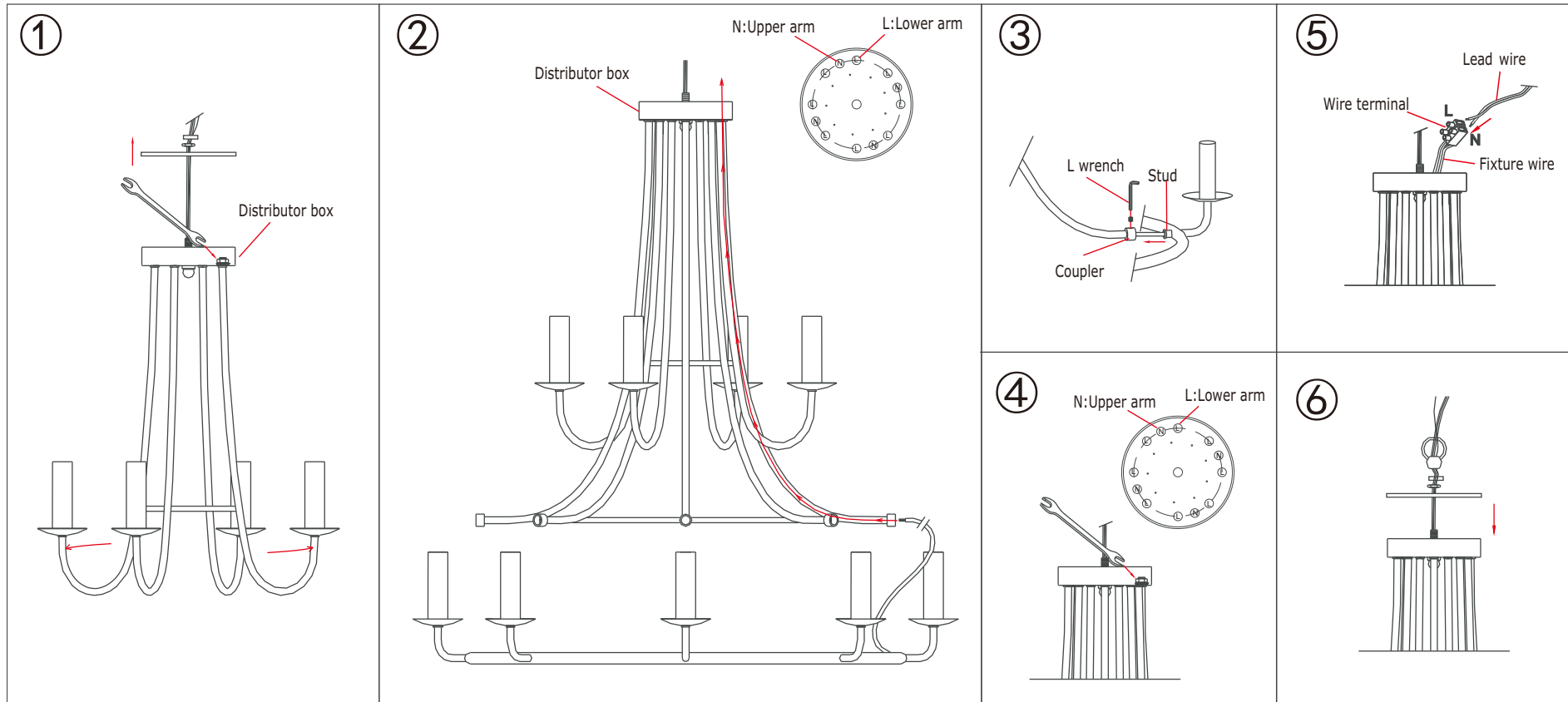

Please place the frame on a soft cloth covered table before installation.

Please do not remove the bubble wrap on the frame until the installation is completed..

1. Loosen the cover by removing the loop, check ring and hex nut. Loosen the hex nut on the top of the arms using a wrench and spread the arms out equally.
2. Feed the lead wire from bottom ring through the end of one arm(the end with coupler) and exit out of the distributor box.
3. Insert the coupler, at the bottom end of the lower arm, onto the stud on the bottom ring and secure it by inserting a screw and tightening it with the included "L" wrench. Repeat for the other lower arms.
4. Secure the other end of the arms onto the distributor box by tightening up the hex nut.
5. Connect the wire to the wire terminal .
6. Tuck the wires carefully inside the distributor box and put the cover back and secure with hex nut. Place the check ring over the hex nut and secure with loop.
7. Dress the crystal as illustrated.
8. Slide the candle sleeve over the socket and install the bulb(not included).