

# CRYSTORAMA

LIGHTING THE WAY FOR SIXTY YEARS



Crystorama.com

## ASSEMBLY INSTRUCTION MODEL # 525-SA\_CEILING

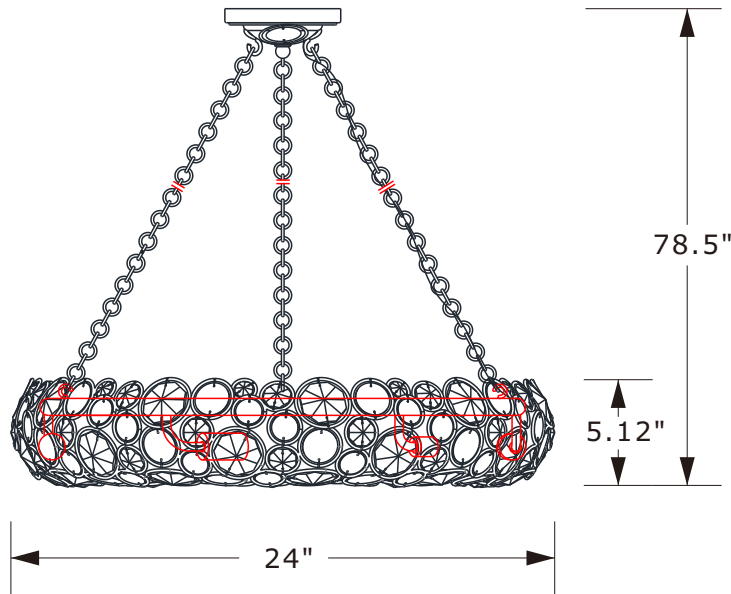

All electrical components must be installed by a licensed electrician in accordance with the National Electric Code and the appropriate local electrical codes.

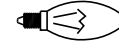

You will need 6 -Candelabra Base Bulb

40 Watts Recommended 60 Watts Max.

USE LED BULBS FOR EXTENDED USE

THE FIXTURE IS DAMP RATED

### How to install

1. Determine the preferred hanging height and adjust the chain accordingly.
2. Take one hanging chain. Hang one end onto the hook under the canopy and hang the other hook inside the frame assembly. Repeat for the other two chains.
3. Weave the fixture wire through one of the hanging chains and through the canopy.
4. Insert recommended bulb (not included).
5. Install the canopy onto outlet box and secure it with the ball nuts.

### SEMI FLUSH

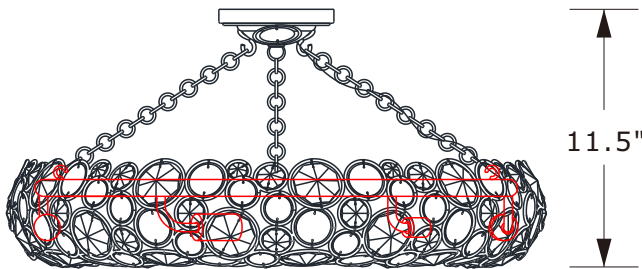

### Crystal Sets

A=  50mm 24PCS

B=  40mm 9 PCS

C=  30mm 12PCS

### Capiz Shell Sets

C=  40mm 102PCS

D=  30mm 99 PCS

 **WARNING:** This product can expose you to Lead, which is known to the State of California to cause cancer and/or birth defects or reproductive harm. For more information go to [www.P65Warnings.ca.gov](http://www.P65Warnings.ca.gov).

## PART NUMBER MODEL # 525-SA\_CEILING

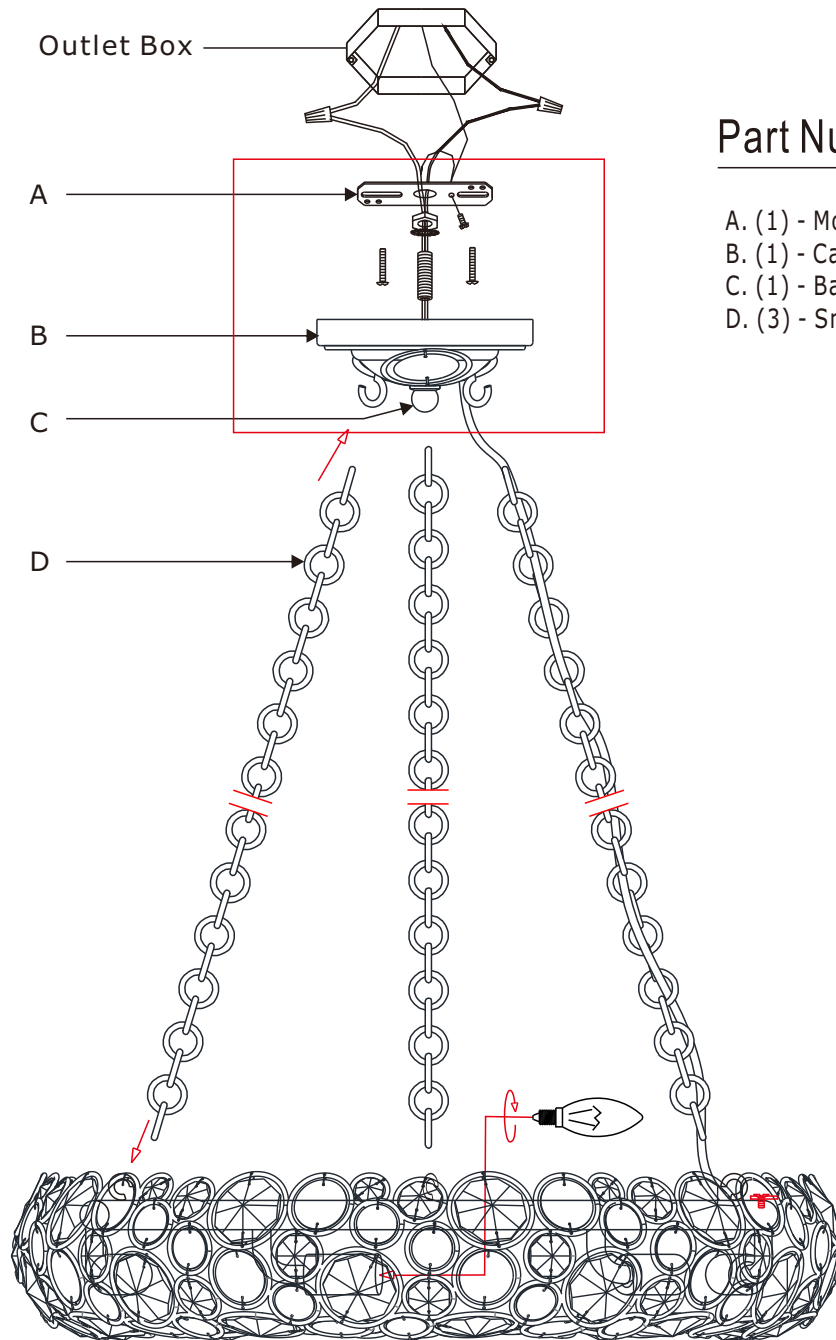

## Part Number

- A. (1) - Mounting Hardware
- B. (1) - Canopy(W5.1",H1.7") XRE525SACAN5.1IN
- C. (1) - Ball Nut #XRE525SABANUT
- D. (3) - Small Hanging Chain(72"3mm) #XRE525SACHA3MM