

Installation Guide

FOR HOME DIY-ERS & YOUR LOCAL PLUMBER

wödårTM

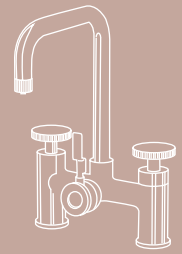

We are delighted that you have chosen our instant boiler and tap. This unique electronic instant hot water appliance will save you time and effort when requiring near boiling water for making tea and coffee and we are sure you will discover many new uses each day.

Please read and follow our step by step guide to the installation, operation and care for the electronic instant hot water appliance and you will soon be making that first cup of coffee or tea from your new appliance.

What you need to know...

Please read carefully

For your safety and satisfaction please read all the instructions, cautions and warnings before installing or using this electronic instant hot water appliance.

Note: This electronic instant hot water appliance is not intended for commercial use.

Important Notice

This product can cause harm if installed incorrectly and should only be installed by a competent person, if you feel for any reason unsure about the installation please contact a qualified plumber or electrician to install the appliance.

Wire connections

Make sure all electrical wiring and connections conform to local standards.

Make sure all water connections conform to local standards.

Electric Outlet is required

A standard 220/240v grounded 13 amp switched electrical outlet is required under the sink for the electronic instant hot water appliance electrical power and must supply electrical power continuously to the appliance.

The power outlet must be connected to the 13amp fused plug supplied.

Open vented system

The instant hot water appliance is an open vented system appliance when not being operated the pressure is 1.0bar. The operating pressure is 1.5 bar to 5 bar.

Water Filter

The water filter must be connected to the electronic instant hot water appliance.

Failure to change filter every 6 months may invalidate your warranty.

EQUIPMENT REQUIRED

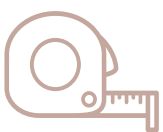

Tape Measure



Adjustable Wrench

Safety Instructions:

Please read before you start

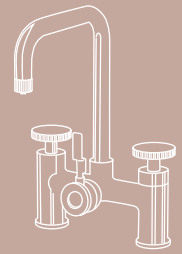

The alert symbols displayed on the below point to important safety information to make you aware of potential hazards that can cause serious injury or death. Please pay special attention to the information following these warning alerts. Failure to comply with these instructions could result in property damage, serious injury or death. Please read this chapter carefully for your own safety and the safety of those around you.

⚠ DANGER

⚠ WARNING

Please read the safety information in this instruction, installation guide and on the product in order to install and use the product accordingly, so as to avoid any injury. The safety information will tell you what the potential danger is, how to avoid it, and identify what will happen if you do not operate following the instruction.

Electric shock

Using an ungrounded connection or improper connection of the power supply to the product can result in a serious injury or death from electrical shock.

- Do not remove the earthing terminal
- Do not reconstruct the plug
- Do not disassemble main box and any part for the power.

IMPORTANT

The instructions are only intended as a guide, if there is any doubt then please contact a certified plumber or electrician or point of purchase and avoid using the product until it has been checked.

Protection

To protect against electrical shock, do not place cord, plugs or unit near or in water or other liquids and do not operate the electronic instant hot water appliance controls or power socket with wet hands

Power rating

Check the power rating of your electronic instant hot water appliance is suitable for the power rating of the electrical circuit it is being installed on.

Faulty

Do not operate or install the electronic instant hot water appliance if it appears to have any missing parts, be damaged / faulty eg damaged cord, plug.

Intended use

Do not use outdoors or in a damp area.

Do not use the electronic instant hot water appliance for anything other than the intended Domestic use

Safety Instructions:

Please read before you start

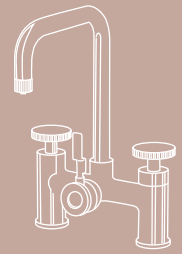

Installed vertically

The electronic instant hot water appliance must be installed vertically as shown on front cover with inlet and outlet connections at the top of appliance.

Ensure the front of the unit is visible and the front temperature dial can be easily reached.

Repairs

Do not attempt to open, modify or service this electronic instant hot water appliance. Repairs should be carried out by Authorised Service personnel. Opening the unit may void the guarantee.

Unplugging

Turn off all controls before unplugging.

Do not unplug by pulling the cable. To unplug, grasp the plug, not the cable.

Property Damage

Property Damage: To avoid the risk of flooding, regularly inspect the unit for any signs of leakage.

IMPORTANT

This electronic instant water appliance is not intended for use by persons (including children) with reduced physical, sensory or mental capabilities, or lack of experience and knowledge, unless they have been given supervision or instruction concerning use of the appliance by a person responsible for their safety. Children should be supervised to ensure that they do not play with the electronic instant hot water appliance or instant hot water tap, a safety spring back handle is used to control the flow of the near boiling water for additional safety.

Installation Requirements:

Please read before you start

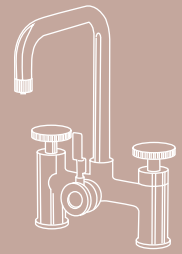

Components Included

The electronic instant hot water appliance is supplied with the following:

Electronic Instant Hot Water Appliance with 13amp UK Plug.

The water connections are to allow correct connections from the instant hot water tap to the electronic instant hot water Appliance.

Inlet and Outlet Connectors 3/8”BSP to Silicon. Inlet and Outlet Connectors 3/8”BSP to 1/2”BSP.

Electrical Requirements



A 220/240-volt, 50 Hz, AC -only 13 amp fused, grounded electrical power supply is required. It is recommended that a separate circuit serving only electronic instant hot water appliance be provided or use an outlet that can be turned on/off by a switch.

This electronic instant hot water appliance is equipped with a power supply cord with a power plug. To minimise possible shock hazard, the cord must be plugged into mating, ground-type outlet, grounded in accordance with all national and local codes and ordinances. If a socket outlet is not available, it is the responsibility and obligation of the customer to have a properly grounded outlet installed by a qualified electrician.

Water Supply Requirements



If local codes permit, the instant hot water tap feed line should be connected to the hot and cold water supply line using isolation valves or another means for providing the hot and cold water to the tap.

IMPORTANT: If local codes do not permit the use of isolation valves, special feed valves can be obtained from your local plumbing supply distributor has been checked.

Environment Requirement



Don't install the electronic instant hot water appliance outdoors or in location that may fall below zero degrees C, otherwise the pipes and the tap will be frozen and there will be serious safety trouble, possible bodily injury, accidents and damage caused.

It's forbidden to wash the electronic instant hot water appliance with water directly.

The installation environment should be ventilated, with protection from the direct sunshine.

When installing the electronic instant hot water appliance, provide approximately 10cm to 15cm (4-5 1/2”) of air space on the sides of the unit for air circulation and approximately 2.5cm(1”) from the mounting wall.

The environment humidity should be in the range of 10% to 60%. Be sure there is no dew.

Preparation for Installation: Please read before you start

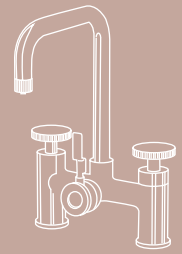

Instant Hot water Tap Information



WARNING

Connecting a standard Tap may cause injury and will damage the electronic instant hot water appliance and void the guarantee. Due to high water temperature, and for safety reasons, the electronic instant hot water appliance is not under pressure.

IMPORTANT



WARNING

Install the Instant Hot Water Tap in accordance with the fitting Instructions provided with the Hot Water Tap.

Observe all local governing codes and ordinances.

Location

The electronic instant hot water appliance must be mounted vertically and level.

Before you begin, select a suitable location ideally directly under the instant hot water tap or close to it to ensure the connection pipes will connect from the instant hot water tap to the electronic instant hot water appliance.

Ensure that the electronic instant hot water appliance is placed so that you will be able to view and reach the touch control on the front face for adjustments.

Not under pressure

The electronic instant hot water appliance is not under pressure, consequently, there is a slight delay in water flow after the Hot Water Handle has been turned on. This is normal and indicates that the electronic instant hot water appliance is functioning properly.

Recommendation

It is recommended that you have access to a separate power circuit serving only your electronic instant hot water appliance. See previous pages for more information on "ELECTRICAL REQUIREMENTS".

Installation:

Please read before you start

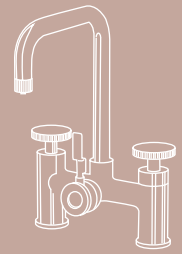

Position the Instant Hot Water Appliance



WARNING

Ensure the electronic instant hot water appliance is NOT connected to the Electric Power during installation.

Place the electronic instant hot water appliance in position and check to ensure that the instant hot water tap connection pipes and the power cord will reach without being stretched.

The electronic instant hot water appliance must be positioned so the tubes from and to the instant hot water tap do not twist or kink.

Connect Tap

The electronic instant hot water appliance inlet connection is a 3/8" BSP male threaded connector. The outlet connector is 3/8" BSP male thread connected to a push on connector.

Check the connections type and size on the instant hot water tap for the inlet connections.

Put the 3/8" BSP to Silicon adapter on the hot water outlet and put 3/8" BSP to 1/2" BSP adapter on the cold water inlet. Screw both adapters with wrench.

Connect the tank with the tap according to the boiling water tap manual. Fitting a pressure reducing valve to the cold mains inlet if the mains pressure is above 5bar. Tighten with a wrench and move to check if the complete installation leaks.

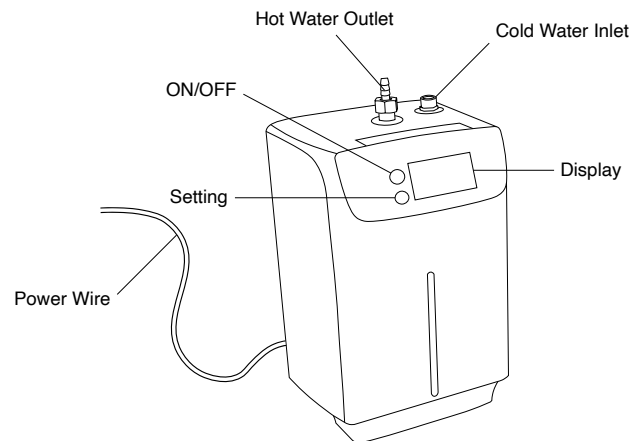

Priming and Checking for Water Tightness

Before the electronic instant hot water appliance is plugged into the power socket it must be tested for water tightness and no leaks.

Open all water valves to allow water to flow to the instant hot water tap. Turn the spring back instant hot water handle and hold to fill the electronic instant hot water appliance this will take about 90 seconds.

When the electronic instant hot water appliance is full, water will flow from the instant hot water tap spout.

Turn the instant hot water handle off and check all connections for water tightness and leaks.

Any leaking joint must be tightened to ensure no water leakage and the above priming undertaken again and checked for water tightness before connecting to the power socket.

 **DANGER**

 **WARNING**

Installation:

Please read before you start

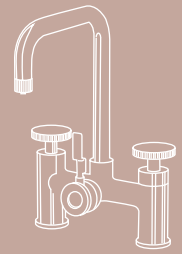

Any leaking joint must be tightened to ensure no water leakage and the above priming undertaken again and checked for water tightness before connecting to the power socket.

Connect the plug

Connect the plug to the power socket and turn on the power socket at the switch. The electronic instant hot water appliance display panel will now light up with the on/off.

Electronic Display Panel

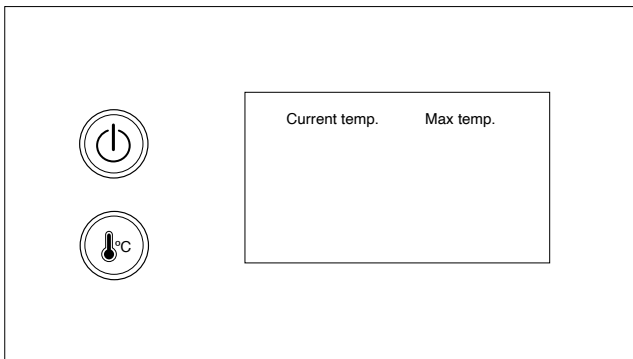

- ON/OFF to control the power. The light will illuminate Green.
- Temperature setting: press to select one of 5 temperature:

75°C, 85 °C, 90 °C, 95 °C, 98 °C

If the electronic instant hot water appliance is empty of water and is turned ON then this will be automatically sensed, the display will show “E3”. The tank needs to fill with water through the boiling water control handle on the tap.

When the display shows “E4”, please unplug the boiler. If the problem still exists, please contact service center to have the tank checked and repaired.

If the electronic instant hot water appliance is not powered off or filled with water then after approximately 5 minutes the electronic instant hot water appliance will automatically power down until it is primed with water using the instruction set out earlier.

Once the temperature is set the light will show Red while the tank is being heated. Once the temperature has been reached the light will turn Green.

When the instant hot water is drawn from the instant hot water tap or the water temperature falls below the required temperature setting then it will automatically re-heat to the required temperature setting. To turn off the electronic instant hot water appliance at any time push the ‘Off’ button.

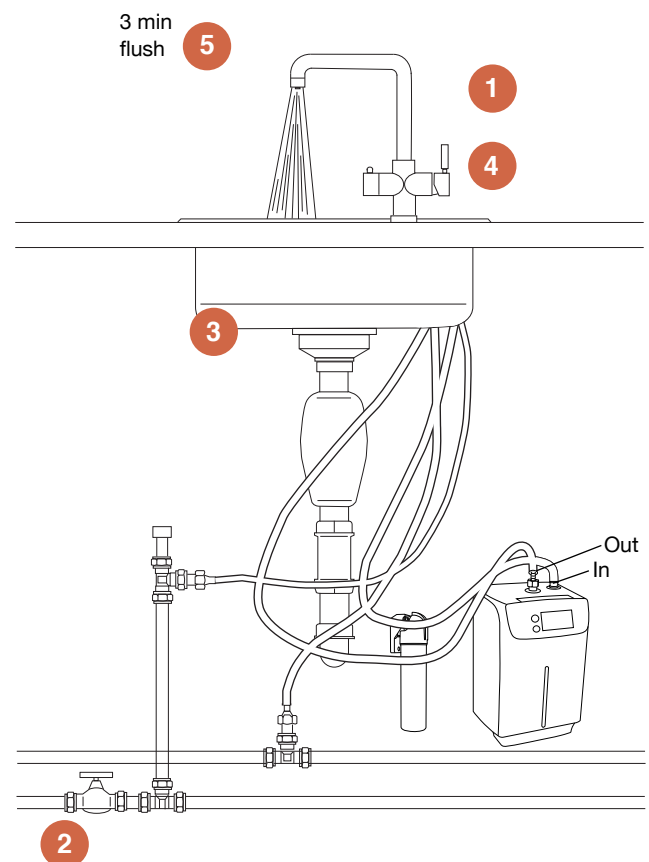

Maintenance & Care Instructions: Please read before you start

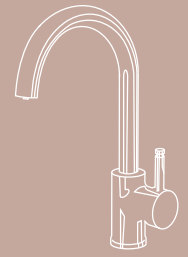

For servicing purposes, the services provided by the customer should have means of isolation. These should terminate with 1/2" BSP male fittings to accept the tap flexible tails (1 and 2).

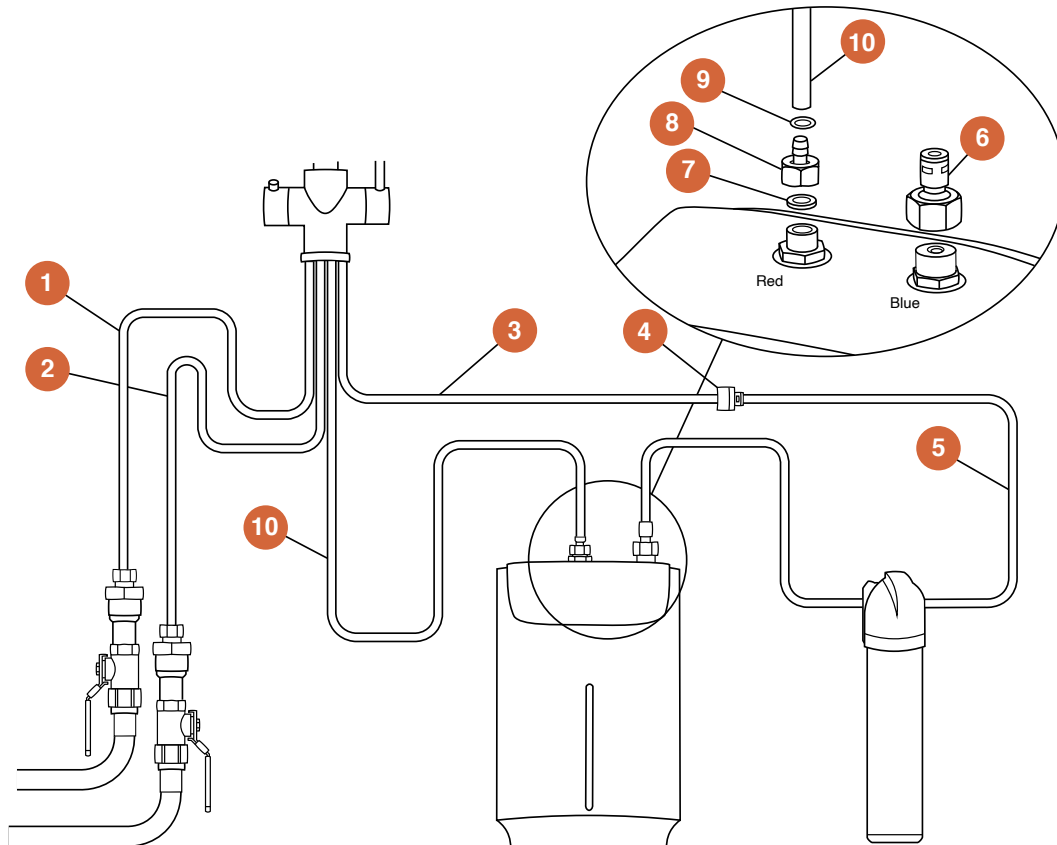

No.	Description	QTY	Packed with
1	Flexi Hose (Blue Stripe (Max 3Bar)) Connected To 'C' on Tap then Incoming Main Cold	1	Tap
2	Flexi Hose (Red Stripe (Max 3Bar)) Connected To 'H' on Tap then Incoming Domestic Hot	1	Tap
3	Flexi Hose (Blue Stripe (Water to Boiler)) Connected To 'O' on Tap then Fitting '4'	1	Tap
4	1/2" Male BSP to 6mm Push Fit	1	Filter
5	1m-6mm PE Pipe (To Cut)	1m	Filter
6	1/2" Female BSP to 6mm Push Fit	1	Filter
7	Silicone Washer	1	Boiler Tank
8	3/8" to Barb	1	Boiler Tank
9	Fixing Clip	1	Tap
10	Pre-Installed Silicone Hose	1	Tap

If you need further support please find more information on our website, wodar.com email us on hello@wodar.com

Maintenance & Care Instructions: Please read before you start

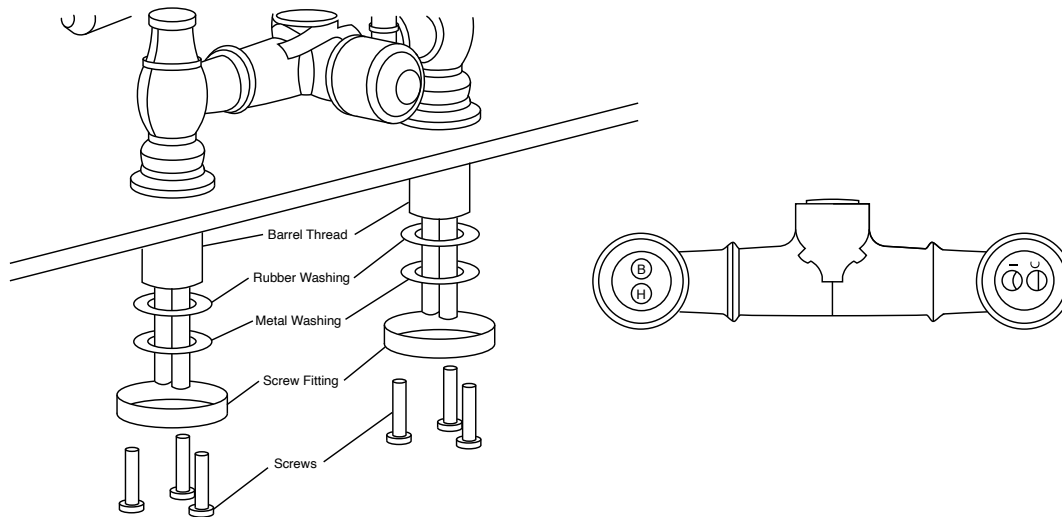
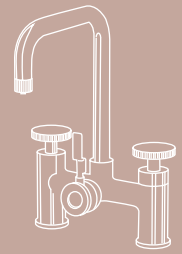

Feed the tails through the barrel thread and hand tighten into the tap. Fit the tap in the desired location using the locking nut and accompanying screws.

Fitting	Description
I	Pre-Installed Silicone Hose Connects to Barb Fitting on Boiler Tank with Fixing Clip
B	Flexi Hose (Blue Stripe (Water to Boiler)) Connected 'To' Filter
C	Flexi Hose (Blue Stripe (Max 3Bar)) Connected to Incoming Main Cold
H	Flexi Hose (Red Stripe (Max 3Bar)) Connected to Incoming Domestic Hot

General care instructions for all kitchen tap finishes

Dry completely with a soft cloth after each use.

Clean regularly with warm water or a mild pH-neutral liquid soap and then polish with a clean, soft, lint-free cloth. A Microfibre cloth is ideal as it is gentle but effective for cleaning without scratching and needs only to be dampened with water to clean the product.

Avoid getting household bleach or cleaners on to your fittings when using on surrounding surfaces. Any splashes should be immediately rinsed with clean water and dried and should not be allowed to remain on the metal finishes.

Under no circumstances should harsh cleaning agents containing acidic, caustic, or abrasive components such as bleach, alcohol or vinegar-based substances be used.

Do not use abrasive cloths, scouring pads, scrub sponges, steel wool etc. as they may damage the surface.

To avoid dye and 'patterning' transfer from wet cloths, avoid hanging them over the spout of the tap. Porous surfaces such as nickel and pewter may be affected by chemicals in or on the cloth.

Failure to Follow These Instructions Could Invalidate Your Warranty

If you need further support please find more information on our website, wodar.com email us on hello@wodar.com

Maintenance & Care Instructions: Please read before you start

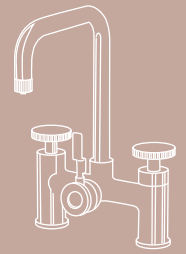

For servicing purposes, the services provided by the customer should have means of isolation. These should terminate with 1/2" BSP male fittings to accept the tap flexible tails (1 and 2).

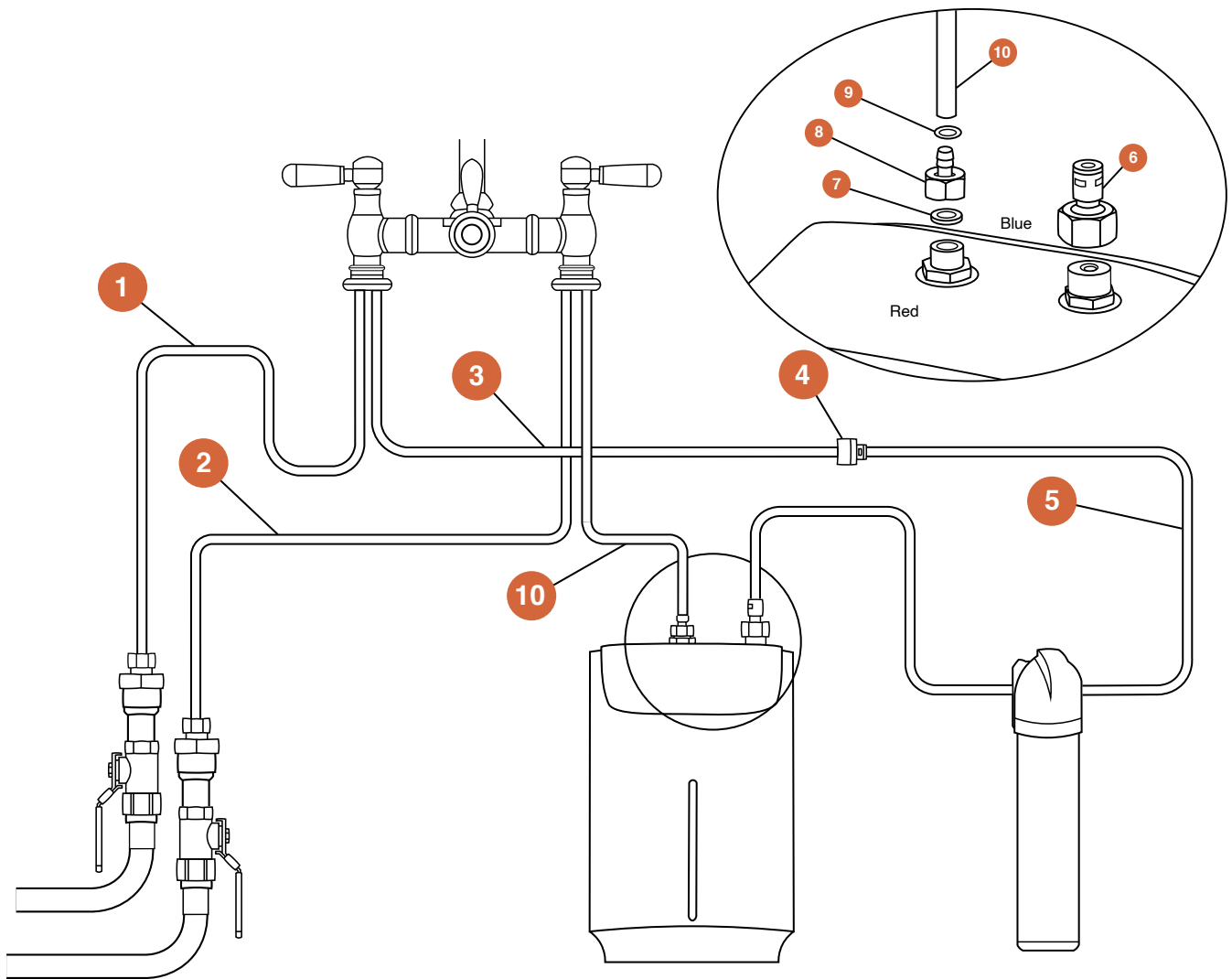

Maintenance & Care Instructions:

Please read before you start

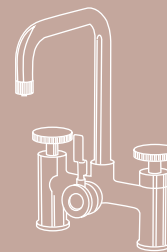

No.	Description	QTY	Packed with
1	Flexi Hose (Blue Stripe (Max 3Bar)) Connected To 'C' on Tap then Incoming Main Cold	1	Tap
2	Flexi Hose (Red Stripe (Max 3Bar)) Connected To 'H' on Tap then Incoming Domestic Hot	1	Tap
3	Flexi Hose (Blue Stripe (Water to Boiler)) Connected To 'O' on Tap then Fitting '4'	1	Tap
4	1/2" Male BSP to 6mm Push Fit	1	Filter
5	1m-6mm PE Pipe (To Cut)	1m	Filter
6	1/2" Female BSP to 6mm Push Fit	1	Filter
7	Silicone Washer	1	Boiler Tank
8	3/8" to Barb	1	Boiler Tank
9	Fixing Clip	1	Tap
10	Pre-Installed Silicone Hose	1	Tap

A switched socket outlet is required to power up the boiler tank, this must be fitted in accordance with the current IEE Wiring Regulations.

Maintenance & Care Instructions: Please read before you start

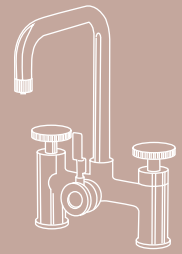

Maintenance & Power saving

If the electronic instant hot water appliance is not being used for long periods of time ie:

- over 7 days, to save power we recommend you switch off using
- the "ON/OFF" switch.

Seasonal Shutdown

The hot water system (tank and tap) must not be exposed to freezing temperatures. If there is a possibility of this the system must be drained of water. Shut-off the mains supply and unplug the unit from the electricity mains and allow the tank to cool for at least 1 hour.

Disconnect the inlet supply to the tank and remove the silicone hose outlet pipe, lift the unit to the sink, turn upside down and drain all the water from the tank. When reinstalling follow the original installation instructions

Notice

The electronic instant hot water appliance like any water heater has a limited operational life span and will eventually fail. In order to ensure maximum protection and to avoid possible damage to any property or personal injury the electronic instant hot water appliance should be inspected regularly for any water leakage or damage.

Regularly check for any signs of water leakage, if there is any water leakage then replace any loose or split silicon tubes or flexi tails which can cause water leakage and damage.

To provide additional water security to avoid property damage the electronic instant hot water appliance can be placed in a drain pan and connected to a suitable drain outlet to avoid any water damage. The drain pan should be installed using the manufacturers installation instructions.

Trouble Shooting

Please read before you start

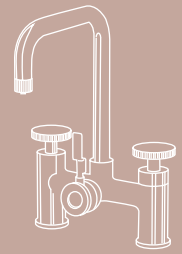

PROBLEM

- Water and Steam is spitting from the instant hot water tap spout
- Water is not hot.
- Water is too hot.
- Water is dripping from the instant hot water tap spout.
- Slow Flow from the spout

POSSIBLE CAUSE

- Unit is boiling
- Pressure is lower then 1.5 bar or higher then 5 bar
- The electronic instant hot water appliance is unplugged.
- Water temperature setting is set to high temperature.
- The expansion chamber isn't draining the system correctly due to very small draw off water.
- The spout is blocked
- Water Filter may be clogged from impurities in the inlet mains water

WHAT TO DO

- Turn the instant hot water tap handle on and release the water.
- Check the pipe pressure. Check if aerator is blocked and remove the dirt in the aerator.
- Make sure the electron inconstant hot water appliance is plugged in and connected to a grounded electric outlet.
- Make sure that the circuit breaker and fuse are working correctly.
- Re-set the temperature to the lower temperature.
- Draw off 0.5L of water to clear and prime the system. Avoid less than 150ml draw offs of water.
- Remove and clean the aerator
- The water filter must be changed every 6 months or this will void guarantee

Trouble Shooting

Please read before you start

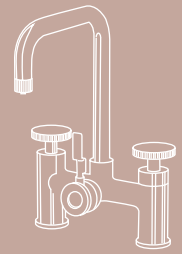

PROBLEM

- Water does not flow straight away
- No Water Flowing

POSSIBLE CAUSE

- The electronic instant hot water appliance is design for non pressurised operation and there will be slight delay till the near boiling water appears
- Water Valves have been turned off
- Inlet Pipes have been twisted or blocked

WHAT TO DO

- After a large volume of water has been drawn off there may a slightly longer delay in the water appearing from the instant hot water tap spout
- Turn on all the water valves
- Ensure the pipes are not twisted or kinked to restrict flow
- Remove and clean the aerator
- Remove the electronic instant hot water appliance as per the descaling instructions and flush through a ll pipes to ensure water flow.

IF YOU ARE IN ANY DOUBT THEN POWER OFF THE ELECTRONIC INSTANT HOT WATER APPLIANCE AND CALL THE SERVICE AGENT

wödårTM

If you need further support please find more information on our website,
wodar.com email us on **hello@wodar.com**