

Straight Square Steel Poles

Size: 4" (4" x 4"), 5" (5" x 5")

The WSD LED INC Series Straight Square Steel poles are built from high strength steel tube and are available side drilled for arm mounted area lighting luminaires or with tenon mounts for flood and post top luminaires. Typical area lighting applications include retail centers, industrial parks, schools and universities, public transit and airports, office buildings and medical facilities. Mounting heights of 10 to 30 feet can be used based on selected luminaire application.

(ACCESSORIES NEED TO PURCHASED SEPARATELY)

FEATURES

FINISH:

Textured architectural bronze powder-coat finish, baked to ensure maximum paint adhesion, hardness and durability.

ANCHOR BOLTS:

Anchor bolts are not included, sized based on pole data charts for the selected pole size.

HAND HOLE:

Cast iron reinforced hand hole and cover with ground screw.

BASE COVER:

Poles are provided with a two-piece formed steel base cover that is easily assembled and fitted over pole base.

POLE LENGTH:

Poles are available in standard lengths as shown in the order matrix. Poles can be custom cut to order. Consult factory.

SPECIFICATIONS: Conforms to ASTM-A 500 Grade B: Minimum Yield Strength of 46,000 PSI.

| SPECIFICATION | 10FT | 15FT | 20FT | 25FT | 30FT |
|-------------------|-------------|-------------|-------------|-------------|-------------|
| WSD-10FT4-11G-D-T | | | | | |
| WSD-15FT4-11G-D-T | | | | | |
| WSD-20FT4-11G-D-T | L = 3.0 (m) | L = 4.6 (m) | L = 6.1 (m) | L = 7.6 (m) | L = 9.1 (m) |
| WSD-25FT4-11G-D-T | | | | | |
| WSD-30FT5-11G-D-T | | | | | |

MOUNTING OPTIONS

Standard length poles include 2 3/8" OD tenon, side drilled 4@90°, polycarbonate top cover and hole plugs for unused grilling locations.

Cut to order poles can be side drilled for 2@180° or 4@90°, includes polycarbonate top cover and hole plugs for unused drilling locations.

Cut to order poles may also be ordered with 2 3/8" OD tenons for use with post top decorative luminaires, flood/area slip fitter fixtures, or any of a wide variety of pole top mounting accessories.

Our standard equipment is to make a top adapter with 2.5 inches. There is no opening on the top of the light pole. If ARM installation is needed, the top adapter shall be removed and holes shall be opened on the wall of the light pole. Finally, seal the top with a plastic rain cover.

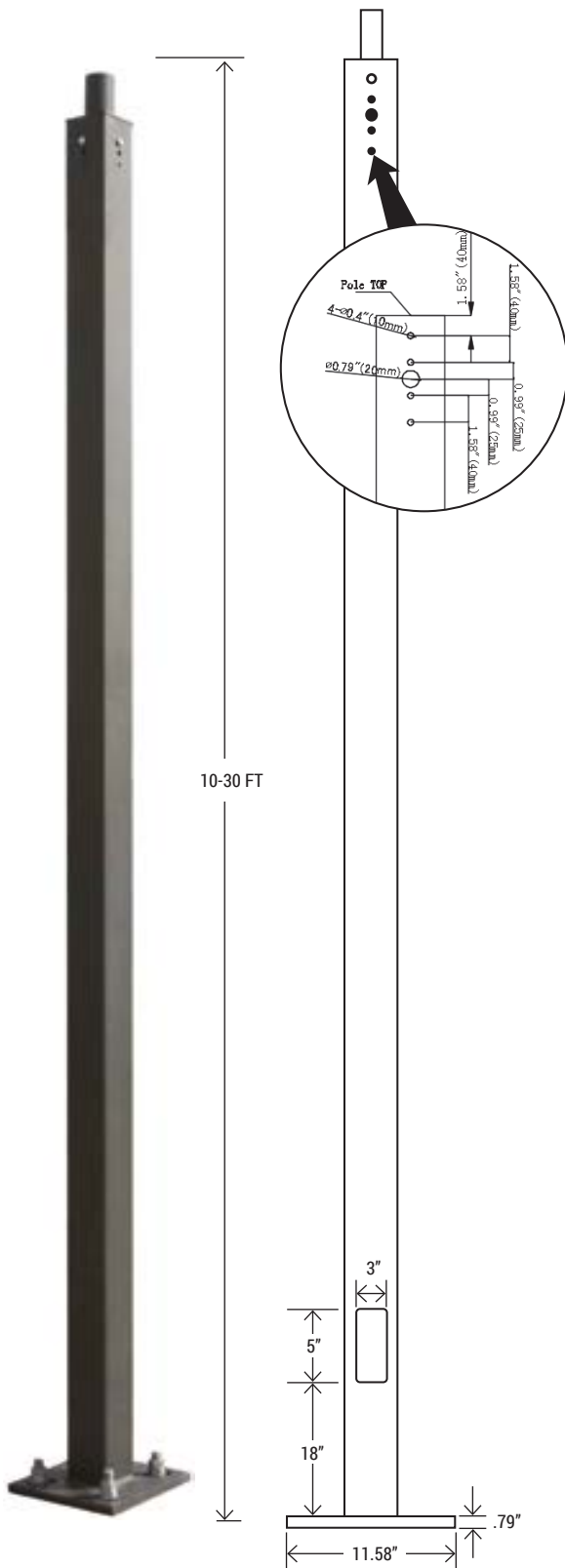

Straight Square Steel Poles

Size: 4" (4" x 4"), 5" (5" x 5")

DIMENSION

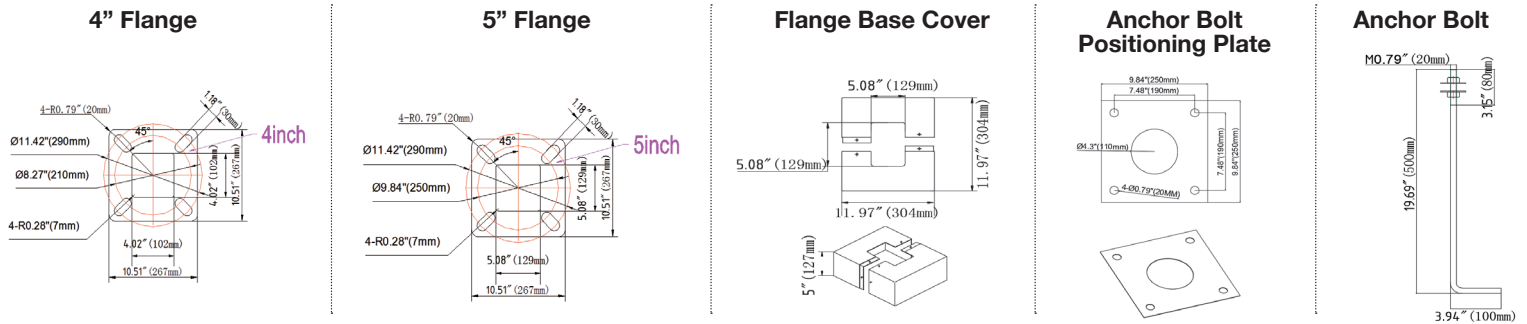

DIMENSION DATA

| CATALOG | HEIGHT | GAUGE | SIZE | BASE | BOLT CIRCLE | BOLT PROJ. | BOLT SIZE | WEIGHT (LBS) | EPA 70 | EPA 80 | EPA 90 | EPA 100 | EPA 110 | EPA 120 |
|--------------------|--------|-------|-------|-----------|-------------|-------------|-------------|--------------|--------|--------|--------|---------|---------|---------|
| WSD-10FTT4-11G-D-T | 10ft | 11 | 4"x4" | 11" | 8" - 10" | 2.75" | 3/4"x17"x3" | 88 | 25.2 | 20.5 | 17.1 | 11.4 | 10.3 | 9.6 |
| WSD-15FTT4-11G-D-T | 15ft | | | | | | | 117 | 15.2 | 12.5 | 10.1 | 8.5 | 6.9 | 5.4 |
| WSD-20FTT4-11G-D-T | 20ft | | | | | | | 152 | 9.2 | 7.3 | 6 | 4.2 | 3 | 1.6 |
| WSD-25FTT4-11G-D-T | 25ft | | | | | | | 190 | 8.9 | 6.9 | 5.7 | 4.1 | 3.6 | 2.2 |
| WSD-30FTT4-11G-D-T | 30ft | | 5"x5" | 10" - 12" | 3.375" | 3/4"x17"x4" | 267 | 7.2 | 5.4 | 4.1 | 3.8 | 2.8 | 2.8 | 1.2 |

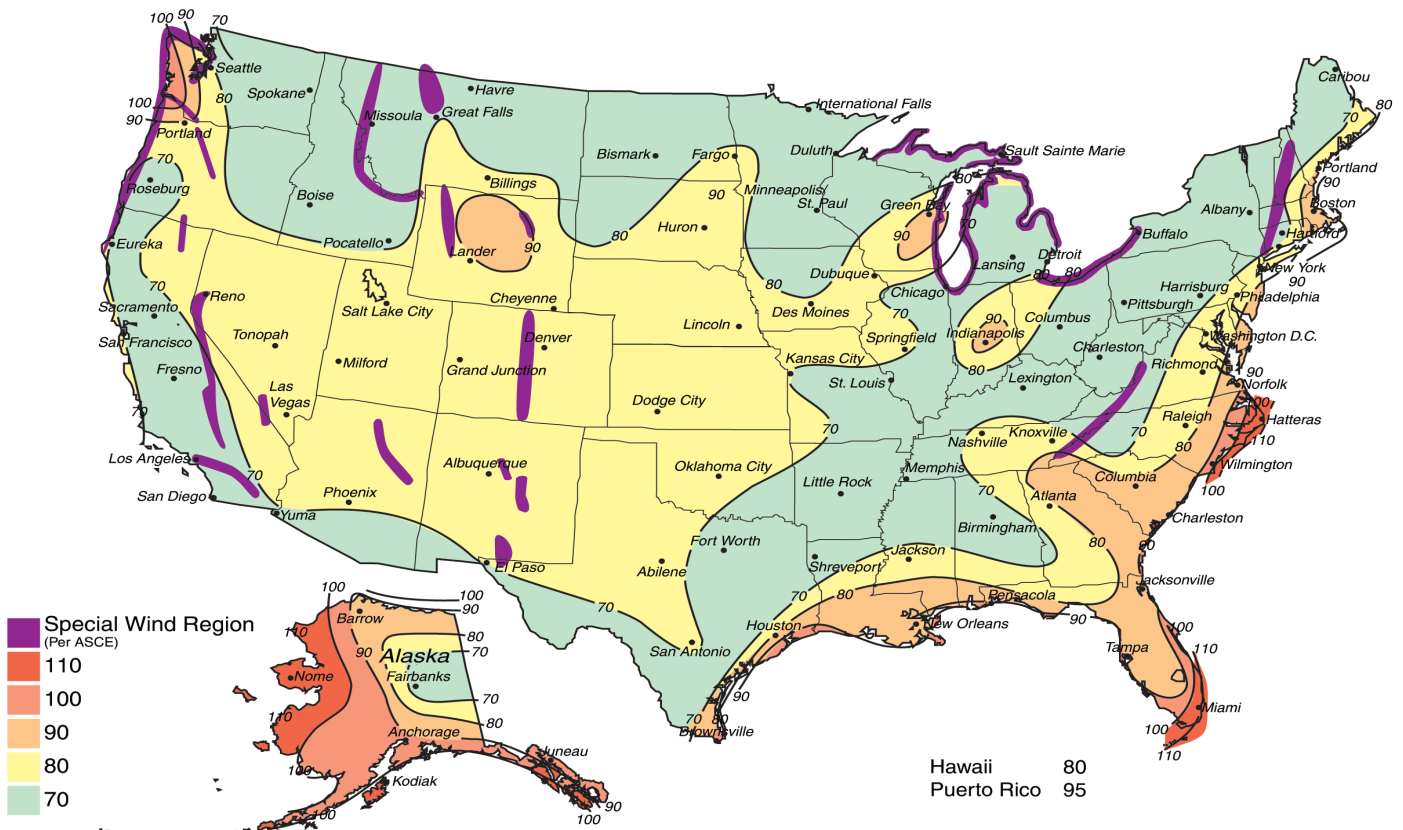

Straight Square Steel Poles

Size: 4" (4" x 4"), 5" (5" x 5")

ORDERING INFORMATION

EXAMPLE: **WSD-10FT4-11G-D-T**

| WSD | 10FT | 4 | 11G | D | T |
|-------------|--|--------------------------------|------------------|-------------------|--------------------|
| COMPANY | HEIGHT | SIZE | THICKNESS | FINISH | MOUNTING |
| WSD LED INC | 10FT - (3.0 M) 15FT - (4.6 M) 20FT - (6.1 M) 25FT - (7.6 M) 30FT - (9.1 M) | 4 - (4" x 4") 5 - (5" x 5") | 11G - (11 gauge) | D - (Dark Bronze) | T - (2.5" Adapter) |

FIXTURE CONFIGURATIONS

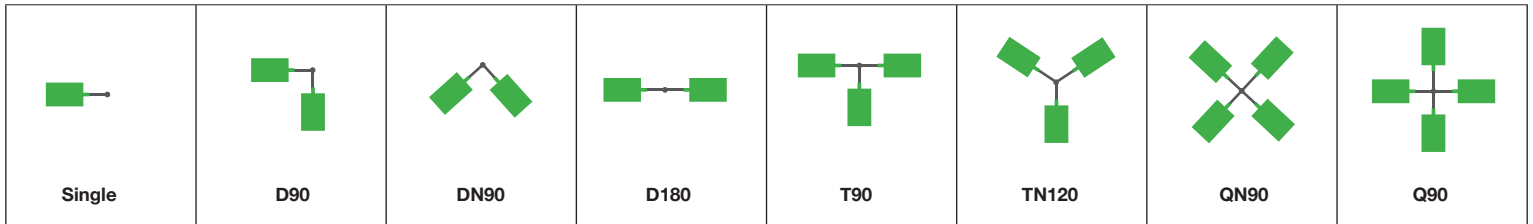

INSTALLATION

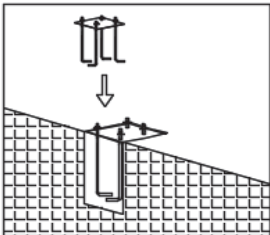

1. Dig a hole in the installation position of the lamp pole. Fixed four fastener fittings according to the hole position of lamp pole and poured with cement concrete. (as shown in the figure)

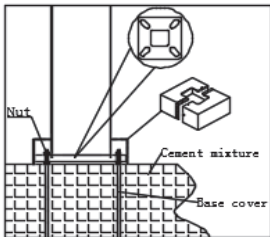

2. Install 4 screws onto the stick and adjust to same water level, then place the square plate and screw tightly. Install the cover at the bottom of pole. (as shown in the figure)

Foundation reference specification

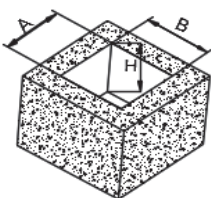

| Specifications | L | W | H |
|----------------|---------------|---------------|----------------|
| 10-15FT | 19.69"(500mm) | 19.69"(500mm) | 23.62"(600mm) |
| 20-25FT | 23.62"(600mm) | 23.62"(600mm) | 27.56"(700mm) |
| 30FT | 27.56"(700mm) | 27.56"(700mm) | 39.37"(1000mm) |

3"X5" HAND HOLE COVER

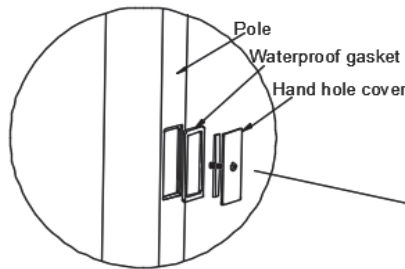

Flange base cover

ANCHORAGE GUIDE

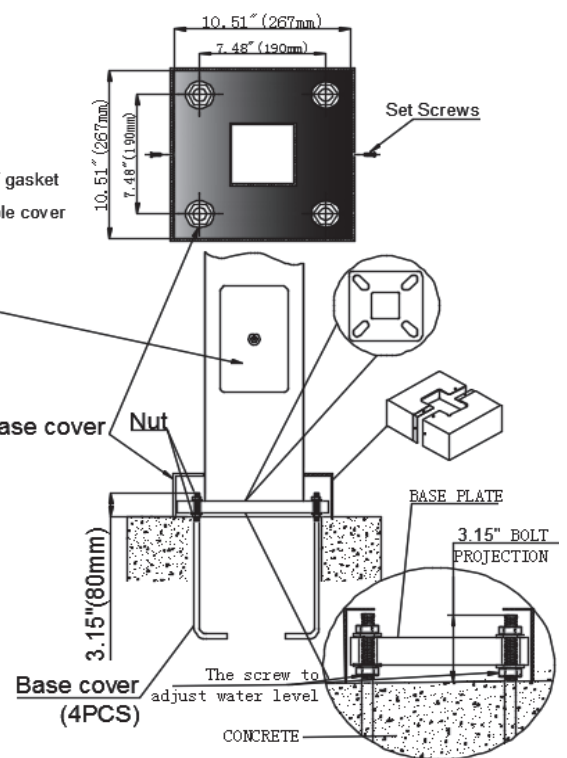



Straight Square Steel Poles

Size: 4" (4" x 4"), 5" (5" x 5")

| SQUARE EXTERNAL MOUNT HORIZONTAL TENON | | • To mount 2/3/4 fixtures on an existing pole | |
|--|---|--|---|
| <p>45" (1143mm) 20.5" (520mm) 3-Ø2.36" (60mm) 4.72" (120mm) 11.73" (44mm) 1.24" (31.5mm) Ø3" (76mm) 4-M8</p> | <p>Low Profile Bullhorn with 3 Tenons WSD-VTS4R-3T-D MAX EPA: 1.6 Finish: Dark Bronze The Bracket is designed to mount over 2-3/8" O.D. vertical tenon.</p> | <p>20.5" (520mm) Ø2.4" (60mm) 4.7" (120mm) 24.6" (624.38mm) Ø3" (76mm)</p> | <p>Low Profile Bullhorn with 2 Tenons WSD-VTS4R-2T-D MAX EPA: 1.0 Finish: Dark Bronze The Bracket is designed to mount over 2-3/8" O.D. vertical tenon.</p> |
| <p>11.62" (295.22mm) 9.56" (243.84mm) 3-Ø2.36" (60mm) 130° Ø2-M8 1.17" (29.7mm) Ø2.04" (51.8mm) Ø3" (76mm)</p> | <p>Triple 120° Horizontal Tenon Adapter WSD-QT120-3T-D MAX EPA: 1.4 Finish: Dark Bronze The Bracket is designed to mount over 2-3/8" O.D. vertical tenon.</p> | <p>30" (762mm) 24" (609mm) Ø2.36" (60mm) 1.17" (29.7mm) Ø2-M8 1.17" (29.7mm) Ø2.04" (51.8mm) Ø3" (76mm)</p> | <p>Quad 90° Horizontal Tenon Adapter WSD-VTS4R-3T-D MAX EPA: 1.6 Finish: Dark Bronze The Bracket is designed to mount over 2-3/8" O.D. vertical tenon.</p> |
| WALL BRACKET • Attaches to any flat surface • Provides wiring access | | MID-POLE TENON BRACKET | |
| <p>Ø2.36" 7" 5.9" 7" 7.8"</p> | <p>90° Wall Mount Bracket with 2-3/8" O.D. Tenon WSD-ADP2.5-90-D MAX EPA: 0.6 Finish: Dark Bronze The 90° wall mount bracket with 2-3/8" tenon attaches flood and area fixtures to almost any surface: wall, roof, or wood pole. Provides wiring access and a built-in 2-3/8" O.D. tenon to mount a fixture with our adjustable slip-fitter. Suggested 3/8" diameter bolts for mounting.</p> | <p>3.93" 8" 3.93" Ø2.36" 4.92" 3.75" 5.6" 0.12"</p> | <p>2-3/8" OD Horizontal Tenon Mid-Pole Bracket WSD-ADP2.5-D MAX EPA: 0.3 Finish: Dark Bronze 2-3/8" OD Horizontal Tenon Mid-Pole Bracket is designed to mount light fixture that is equipped with a adjustable slip-fitter onto a 2-3/8" OD horizontal tenon.</p> |
| <p>Ø54 Ø60 3.9" (99mm) R2 4-Ø9 0.16" (4mm) 7" (177.8mm) 90°</p> | <p>180° Wall Mount Bracket with 2-3/8" O.D. Tenon WSD-ADP2.5-180L3.9-D MAX EPA: 0.5 Finish: Dark Bronze The 180° wall mount bracket with 2-3/8" tenon attaches flood and area fixtures to almost any surface: wall, roof, or wood pole. Provides wiring access and a built-in 2-3/8" O.D. tenon to mount a fixture with our adjustable slip-fitter. Suggested 3/8" diameter bolts for mounting.</p> | <p>Ø2.36" (60mm) Ø2.13" (54mm) Ø3.15" (80mm) 5.04" (128mm) 0.16" (4mm) 8" (203.2mm) 1" (25.4mm) 0.49" (12.4mm) 3" (76.2mm) 3" (76.2mm) 1" (25.4mm)</p> | <p>2-3/8" OD Horizontal Tenon Arc Adapter WSD-ADP2.5-BAR5-D MAX EPA: 0.3 Finish: Dark Bronze For use with Round, non-tapered steel and aluminum poles. 2-3/8" OD Horizontal Tenon Mid-Pole Bracket is designed to mount light fixture that is equipped with a adjustable slip-fitter onto a 2-3/8" OD horizontal tenon.</p> |
| POLE BRACKET • For mounting one fixture on an existing pole | | | |
| <p>Ø2.38" 4.33" 4.0" 8.6" 3.5"</p> | <p>4" Square Pole Mount with 2-3/8" O.D. Tenon WSD-VTS4-D MAX EPA: 0.3 Finish: Dark Bronze For use with square, non-tapered steel and aluminum poles. Furnished with four 5/16" hex head stainless-steel bolts. Vertical tenon measures 2-3/8" O.D. and is made of steel tubing.</p> | <p>Ø2.36" 4" 4.8" Ø3.15" Ø3.46"</p> | <p>3" Round Pole Mount with 2-3/8" O.D. Tenon WSD-VT3-D MAX EPA: 0.3 Finish: Dark Bronze For use with round, non-tapered steel and aluminum poles. Furnished with four 3/8" hex head stainless-steel bolts. Vertical tenon measures 2-3/8" O.D.</p> |
| <p>Ø2.38" 5" 5" 4" 8.6" 4"</p> | <p>5" Square Pole Mount with 2-3/8" O.D. Tenon WSD-VTS5-D MAX EPA: 0.3 Finish: Dark Bronze For use with square, non-tapered steel and aluminum poles. Furnished with four 5/16" hex head stainless-steel bolts. Vertical tenon measures 2-3/8" O.D., and is made of steel tubing.</p> | <p>Ø2.36" 4" 4.8" Ø4.2" Ø4.4"</p> | <p>4" Round Pole Mount with 2-3/8" O.D. Tenon WSD-VT4-D MAX EPA: 0.3 Finish: Dark Bronze For use with round, non-tapered steel and aluminum poles. Furnished with four 3/8" hex head stainless-steel bolts. Vertical tenon measures 2-3/8" O.D.</p> |
| <p>Ø2.36" Ø2.13" 4-M8 4.01" 7.88" 11.89" 3.33" 1.97" Ø5.2" Ø5.51"</p> | <p>5" Round Pole Mount with 2-3/8" O.D. Tenon WSD-VT5-D MAX EPA: 0.3 Finish: Dark Bronze For use with round, non-tapered steel and aluminum poles. Furnished with four 3/8" hex head stainless-steel bolts. Vertical tenon measures 2-3/8" O.D., and is made of steel tubing.</p> | <p>Ø2.36" (60mm) Ø2.13" (54mm) Ø3.15" (80mm) 5.04" (128mm) 0.16" (4mm) 8" (203.2mm) 1" (25.4mm) 0.49" (12.4mm) 3" (76.2mm) 3" (76.2mm) 1" (25.4mm)</p> | <p>1/2" Round Pole Mount with 2-3/8" O.D. Tenon WSD-TADP2.5-1/2-D MAX EPA: 0.3 Finish: Dark Bronze For use with Round, non-tapered steel and aluminum poles. Vertical tenon measures 2-3/8" O.D., and is made of aluminum tubing.</p> |

Straight Square Steel Poles

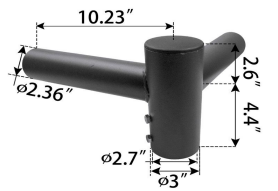
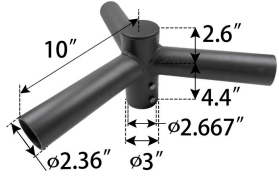
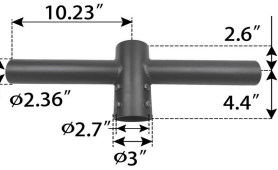
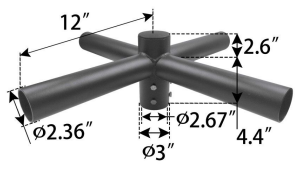
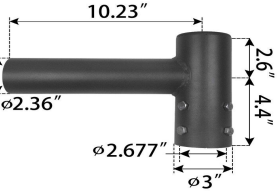
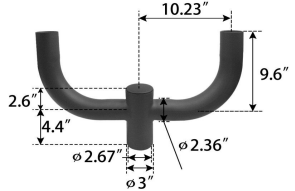
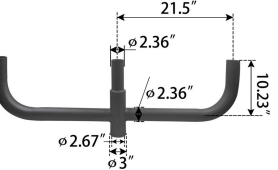
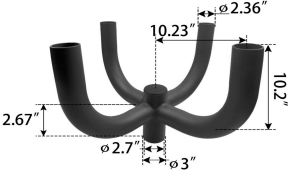
Size: 4" (4" x 4"), 5" (5" x 5")

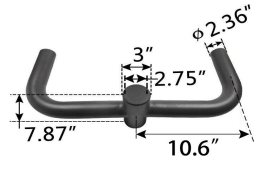
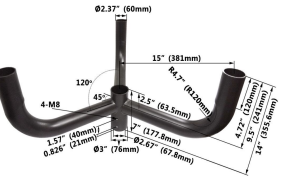
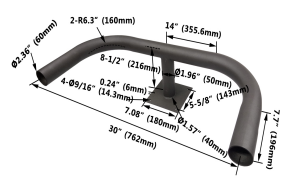
| ROUND EXTERNAL MOUNT HORIZONTAL TENON - To mount 2/3/4 fixtures on an existing pole | | | |
|---|--|--|--|
|  | <p>Double 90° Horizontal Tenon Adapter WSD-SB2.5TW90-D MAX EPA: 0.6 Finish: Dark Bronze The Bracket is designed to mount over 2-3/8" (60mm) O.D. vertical tenon. Two fixtures can be mounted to the Round External Mount Horizontal Tenon and adjusted horizontally.</p> |  | <p>Triple 120° Horizontal Tenon Adapter WSD-SB2.5TR120-D MAX EPA: 0.7 Finish: Dark Bronze The Bracket is designed to mount over 2-3/8" (60mm) O.D. vertical tenon. Three fixtures can be mounted to the Round External Mount Horizontal Tenon and adjusted horizontally.</p> |
|  | <p>Double 180° Horizontal Tenon Adapter WSD-SB2.5TW180-D MAX EPA: 0.4 Finish: Dark Bronze The Bracket is designed to mount over 2-3/8" (60mm) O.D. vertical tenon. Two fixtures can be mounted to the Round External Mount Horizontal Tenon and adjusted horizontally.</p> |  | <p>Quad 90° Horizontal Tenon Adapter WSD-SB2.5QD90-D MAX EPA: 0.3 Finish: Dark Bronze The Bracket is designed to mount over 2-3/8" (60mm) O.D. vertical tenon. Four fixtures can be mounted to the Round External Mount Horizontal Tenon and adjusted horizontally.</p> |
|  | <p>Single Spoke Bracket Tenon Adapter WSD-SB2.5S90-D MAX EPA: 0.4 Finish: Dark Bronze The Bracket is designed to mount over 2-3/8" (60mm) O.D. vertical tenon. One fixture can be mounted to the Round External Mount Horizontal Tenon and adjusted horizontally.</p> |  | <p>Double 180° Horizontal Tenon Adapter WSD-RB2.5D180-D MAX EPA: 0.9 Finish: Dark Bronze The Bracket is designed to mount over 2-3/8" (60mm) O.D. vertical tenon. Two fixtures can be mounted to the Round External Mount Horizontal Tenon and adjusted horizontally.</p> |
|  | <p>Triple 180° Horizontal Tenon Adapter WSD-RB2.5TR180-D MAX EPA: 1.4 Finish: Dark Bronze The Bracket is designed to mount over 2-3/8" (60mm) O.D. vertical tenon. Three fixtures can be mounted to the Round External Mount Horizontal Tenon and adjusted horizontally.</p> |  | <p>Quad 90° Horizontal Tenon Adapter WSD-RB2.5QD90-D MAX EPA: 1.5 Finish: Dark Bronze The Bracket is designed to mount over 2-3/8" (60mm) O.D. vertical tenon. Four fixtures can be mounted to the Round External Mount Horizontal Tenon and adjusted horizontally.</p> |
|  | <p>90° Wall Mount Bracket with 2-3/8" O.D. Tenon WSD-ADP2.5-90H-D MAX EPA: 0.7 Finish: Dark Bronze The 90° wall mount bracket with 2-3/8" tenon attaches flood and area fixtures to almost any surface: wall, roof, or wood pole. Provides wiring access and abuilt-in 2-3/8" O.D. tenon to mount a fixture with our adjustable slip-fitter. Suggested 3/8" diameter bolts for mounting. Mounting holes are spaced 3-1/4" apart.</p> |  | <p>Double 180° Horizontal Tenon Adapter WSD-RB2.5TR180H-D MAX EPA: 1.0 Finish: Dark Bronze The Bracket is designed to mount over 2-3/8" (60mm) O.D. vertical tenon. Two fixtures can be mounted to the Round External Mount Horizontal Tenon and adjusted horizontally.</p> |
|  | <p>Triple 120° Horizontal Tenon Adapter WSD-SB2.5TR120V-D MAX EPA: 1.5 Finish: Dark Bronze The Bracket is designed to mount over 2-3/8" (60mm) O.D. vertical tenon. Three fixtures can be mounted to the Round External Mount Horizontal Tenon and adjusted horizontally.</p> |  | <p>Double 180° Wall Mount Bracket with 2-3/8" O.D. Tenon WSD-ADP2.5-180H-D MAX EPA: 1.4 Finish: Dark Bronze The 180° wall mount bracket with 2-3/8" tenon attaches flood and area fixtures to almost any surface: wall, roof, or wood pole. Provides wiring access and abuilt-in 2-3/8" O.D. tenon to mount a fixture with our adjustable slip-fitter. Suggested 3/8" diameter bolts for mounting. Mounting holes are spaced 3-1/4" apart.</p> |

Straight Square Steel Poles

Size: 4" (4" x 4"), 5" (5" x 5")

MOUNTING OPTIONS:

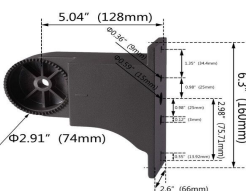
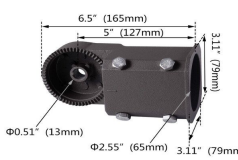
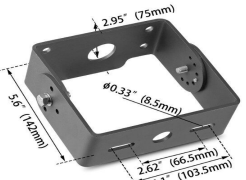
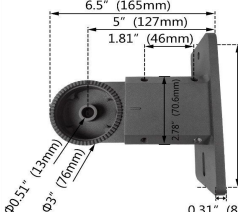
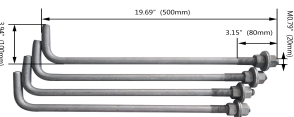
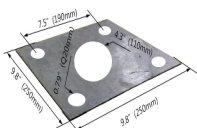
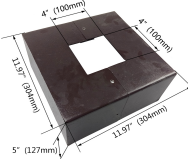
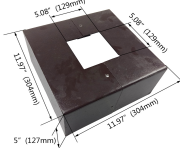
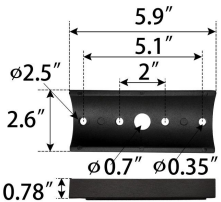
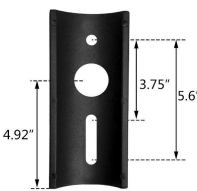
| | | | |
|---|---|---|--|
|  <p>5.04" (128mm) Φ2.91" (74mm) 6.3" (160mm) 3.11" (79mm) 2.6" (66mm)</p> | <p>WSD-NEWSBARM2-D Finish: Dark Bronze Arm Mount 4" and 5" Square and Round poles. Standard versatile mounting arm is simple to install and can be used with existing poles for retro installations.</p> |  <p>6.5" (165mm) 5" (127mm) 3.11" (79mm) Φ0.51" (13mm) Φ2.55" (65mm) 3.11" (79mm)</p> | <p>WSD-NEWSBSF2-D Finish: Dark Bronze Slipfitter Mount An optional cast aluminum mast arm adapter secures fixture head to nominal 2"(2-3/8" O.D. pipe size) horizontal steel tenon arm.</p> |
|  <p>2.95" (75mm) 5.6" (142mm) Φ0.33" (8.5mm) 2.62" (66.5mm) 4.1" (103.5mm)</p> | <p>WSD-SBT-D Finish: Dark Bronze Easy to install for direct wall mounting with 1/2" conduit wiring.</p> |  <p>6.5" (165mm) 5" (127mm) 1.81" (46mm) 6.3" (160mm) Φ0.31" (7.9mm) Φ3" (76mm) 0.31" (8mm)</p> | <p>WSD-SFARM2-D Finish: Dark Bronze SFARM2 Mount An optional cast aluminum mast arm adapter secures fixture head to nominal 2"(2-3/8" O.D. pipe size) horizontal steel tenon arm.</p> |
|  <p>19.69" (500mm) 3.15" (80mm) 3.84" (98mm) 4.83" (123mm)</p> | <p>Anchor Bolt WSD-BMS-S Finish: Silver Before installing the lamp pole, the installation hook should be buried underground and fixed by cement After fixing, the lamp pole should be fixed by locking screw and base installed.</p> |  <p>7.5" (30mm) 1.8" (45mm) 9.8" (250mm) 1.8" (45mm)</p> | <p>Anchor Bolt Positioning Plate WSD-SPP-D Finish: Dark Bronze This is a screw rod positioning plate. After the screw rod of the lamp rod base is fixed underground, the positioning plate is fixed with the screw rod to prevent the screw rod from deviation. Finally, the lamp rod is locked.</p> |
|  <p>4" (100mm) 4" (100mm) 11.97" (304mm) 5" (127mm) 11.97" (304mm)</p> | <p>Install Base Shield WSD-IBS4-D Finish: Dark Bronze The 4" Installation of base shield is used to protect the base after fixing the lamp pole, so that the lamp pole base is not damaged, thereby increasing the service life of the lamp pole.</p> |  <p>5.08" (129mm) 5.08" (129mm) 11.97" (304mm) 5" (127mm) 11.97" (304mm)</p> | <p>Install Base Shield WSD-IBS5-D Finish: Dark Bronze The 5" Installation of base shield is used to protect the base after fixing the lamp pole, so that the lamp pole base is not damaged, thereby increasing the service life of the lamp pole.</p> |
|  <p>5.9" 5.1" 2" Φ2.5" 2.6" Φ0.7" Φ0.35" 0.78"</p> | <p>Arm Square Tube Turn Tube Tenon Adapter WSD-ARM-BAR-D Finish: Dark Bronze Round tube light bar installation, with Arm installation of lamps.</p> |  <p>4.92" 3.75" 5.6"</p> | <p>Arm Square Tube Turn Tube Tenon Adapter WSD-SADP-BAR-D Finish: Dark Bronze Round tube light bar installation, with Arm installation of lamps.</p> |

LIGHT POLE TOP

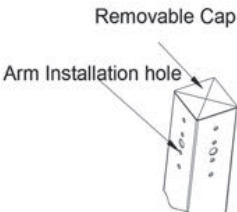
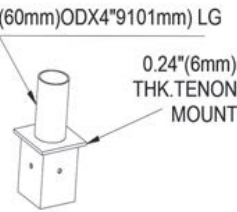
| | |
|--|---|
| <p>PRE-DRILL MOUNT OPTIONS</p>  <p>Removable Cap Arm Installation hole</p> | <p>TENON MOUNT INCLUDED ON TOP</p>  <p>Ø2.38"(60mm)ODX4"9101mm) LG 0.24"(6mm) THK.TENON MOUNT</p> |
|--|---|