

DIGITAL SIGNAGE  
PRO SERIES



Modular Design – Limitless possibilities. Strong ties with major AV distributors and installers as well as industry leaders enable us to develop head-end system specific digital signage solutions to the market needs of your business. We strive to always create simple and intuitive wall mounting solutions for digital signage display setups as well as in-room installations. Our aim is to consistently find ways to improve on our digital signage product offering. Maybe it's time for your business to discover a new level of refinement with our Pro Series signage solutions.



**PRO SERIES** Model name structure

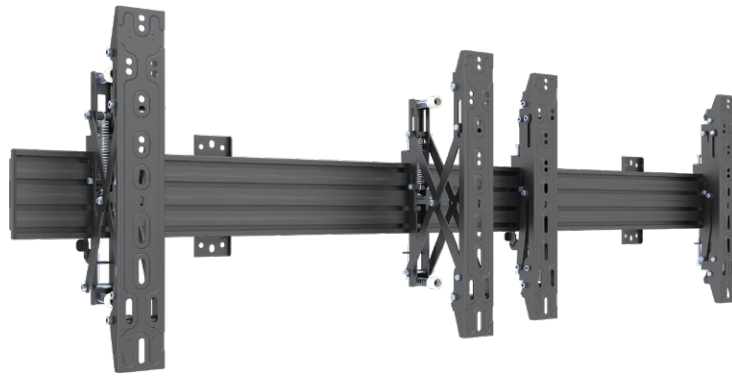

**MB 2 X1U P**

Multibrackets

2 rows

x1 units

Portrait



**Truly**  
Modular design

**Quick**  
Swift installation

**Powerful**  
Rigorously tested

**Experience**  
Sits in the details

**Creativity**  
Empower creativity

**Solutions**  
Vast possibilities

## DIGITAL SIGNAGE - PRO SERIES

<b>Introduction</b> .....	6 - 7
<b>Ceiling mounts</b> .....	8 - 21
<b>Menu Boards</b> .....	22 - 27
<b>Floor to Ceiling</b> .....	28 - 39
<b>Floor to wall</b> .....	40 - 41
<b>The wallmounts</b> .....	42 - 55
<b>From Wall &amp; Wall to Wall</b> .....	56 - 57
<b>Collaboration</b> .....	58 - 61
<b>Videowalls</b> .....	62 - 65
<b>Wire</b> .....	66 - 67
<b>Floorstands</b> .....	68 - 85
<b>Enclosures</b> .....	86 - 93
<b>LED</b> .....	94 - 99
<b>Customized</b> .....	100 - 109
<b>Control rooms</b> .....	110 - 111
<b>Column</b> .....	112
<b>The rail</b> .....	113
<b>Parts</b> .....	114 - 119

# PRO SERIES

## Digital Signage

### Wide range of configurations

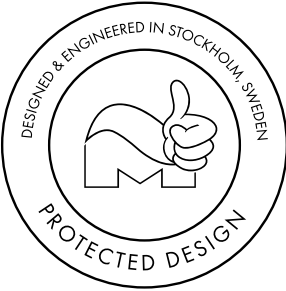

Pro Series is a Digital Signage product series, that can be configured to Ceiling Mounts, Floor to Ceiling Mounts, Menu Boards or Wallmounts. With its modular construction install-

ers have vast possibilities to change, update and reconfigure its design if ideas change. Over time the Pro Series installation can be combined into a wide range of new configurations.

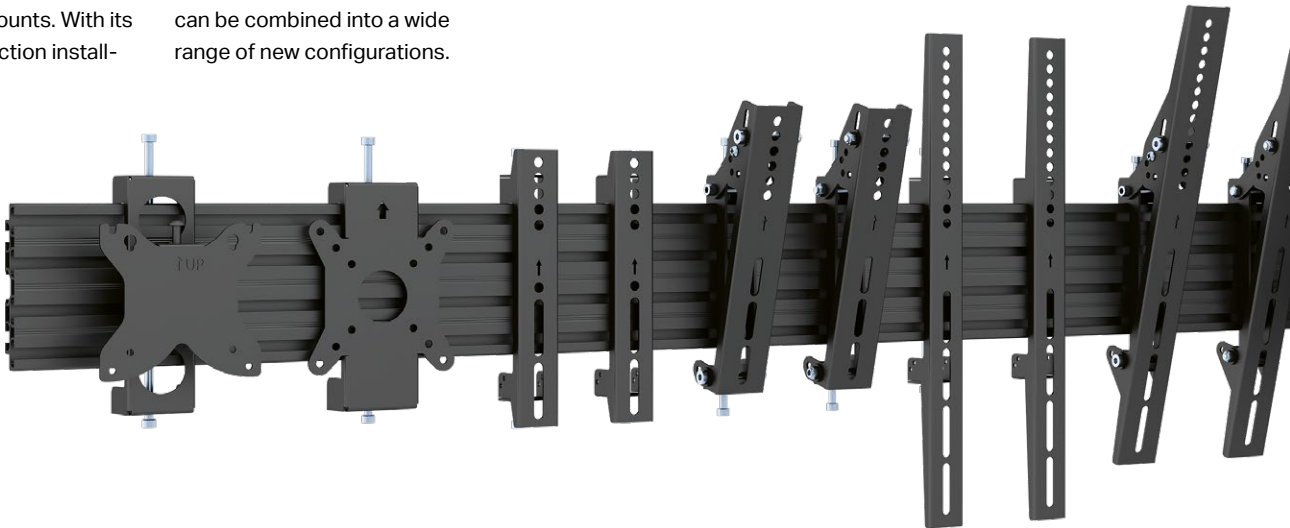

#### Precision leveling

Each mounting bracket allows for micro height adjustments to be made to ensure your screens are levelled and perfectly aligned.

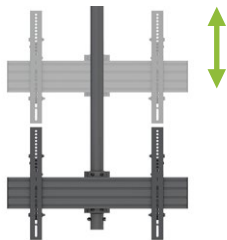

#### Extendable Height

The extendable poles allows you to position the center of the screen mounting plate no any height limitation. For tighter spaces, just with single pole to achieve a distance of 80cm.



#### Easy Tilt

Tilt the mounting brackets 5°, 10° or 15° forward to improve line-of-sight while maintaining alignment between your screens. To compensate for potential lean, the brackets can also be angled up to 6° backward.



#### Modular Design

Available in a wide range of models, Digital Signage ceiling mounts support single to 18 screens weighing up to 30kg each. Their modular design allows for additional extrusions to be added to accommodate screens with wider VESA patterns, or to connect multiple units together.



Selected models are TUV approved

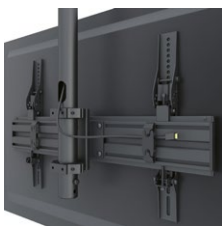
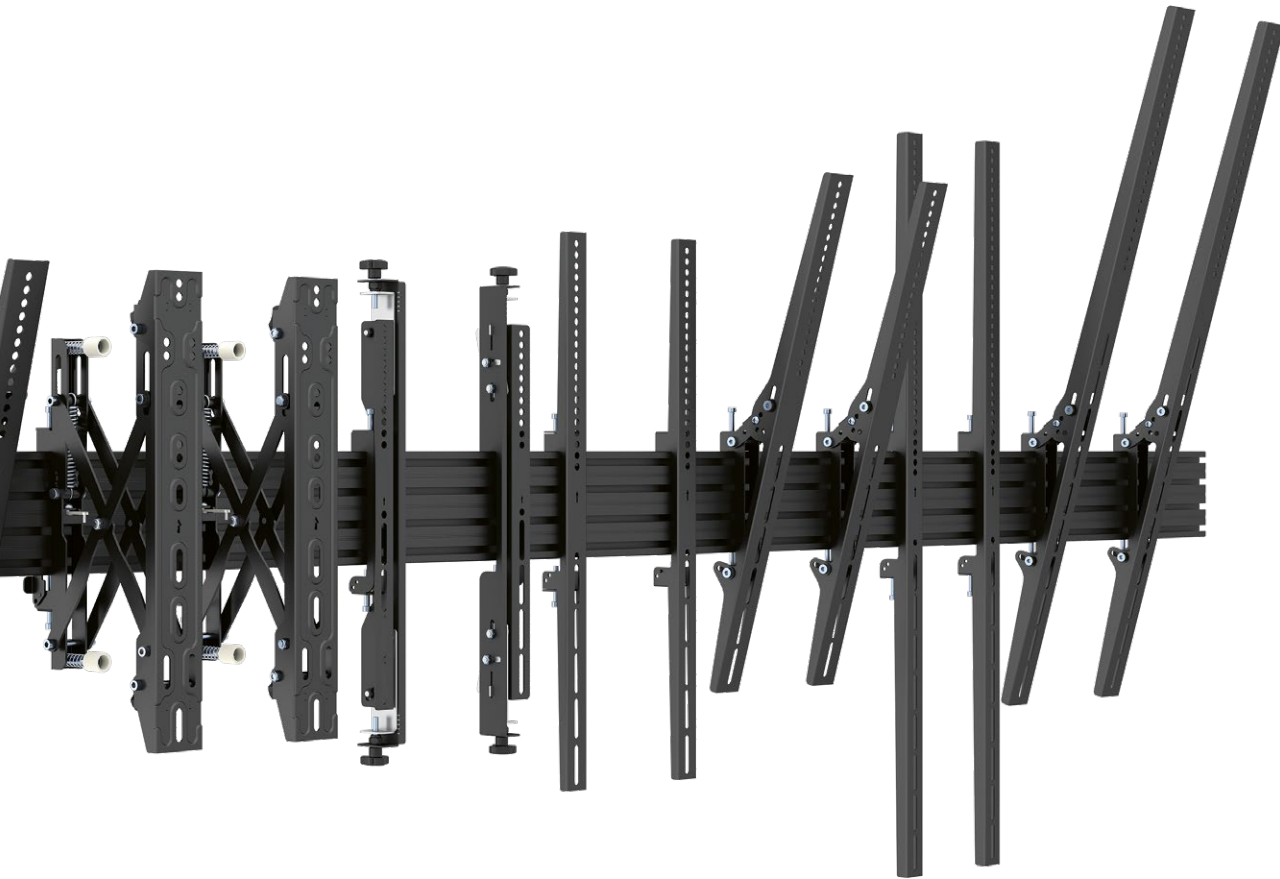

### Cable Management

The extension pole's hollow core provides an unobstructed path to route your cables, while an opening in the mounting plate allows them to continue through the ceiling for a truly professional setup.



### Easy Installation

To reduce strain, Digital Signage Mounts use lightweight ceiling plates that are installed independent of the rest of the mounting system. Simply slide each extension pole into place and secure it to complete the installation.



### Flexible floor mounting

Designed to service a variety of freestanding solutions Pro Series can cater most ideas; wheelbased, floorbased or bolted directly to the floor. Ideal for the heavy duty multi-screen setups. Aesthetically pleasing with premium quality finish.



### Displays or LED panels

As Multibrackets Pro Series line up is a truly universal mounting system it makes it compatible with various LED panels. Samsung, LG, Philips and other brand names can use Pro Series set ups in most formats one would need; Ceilingmounted, Wallmounted, Wheelbased, Freestanding and bolted down.



Pro Series MBC4U in a Volvo Showroom in Stockholm.

## Pro Series Ceiling mounted solutions





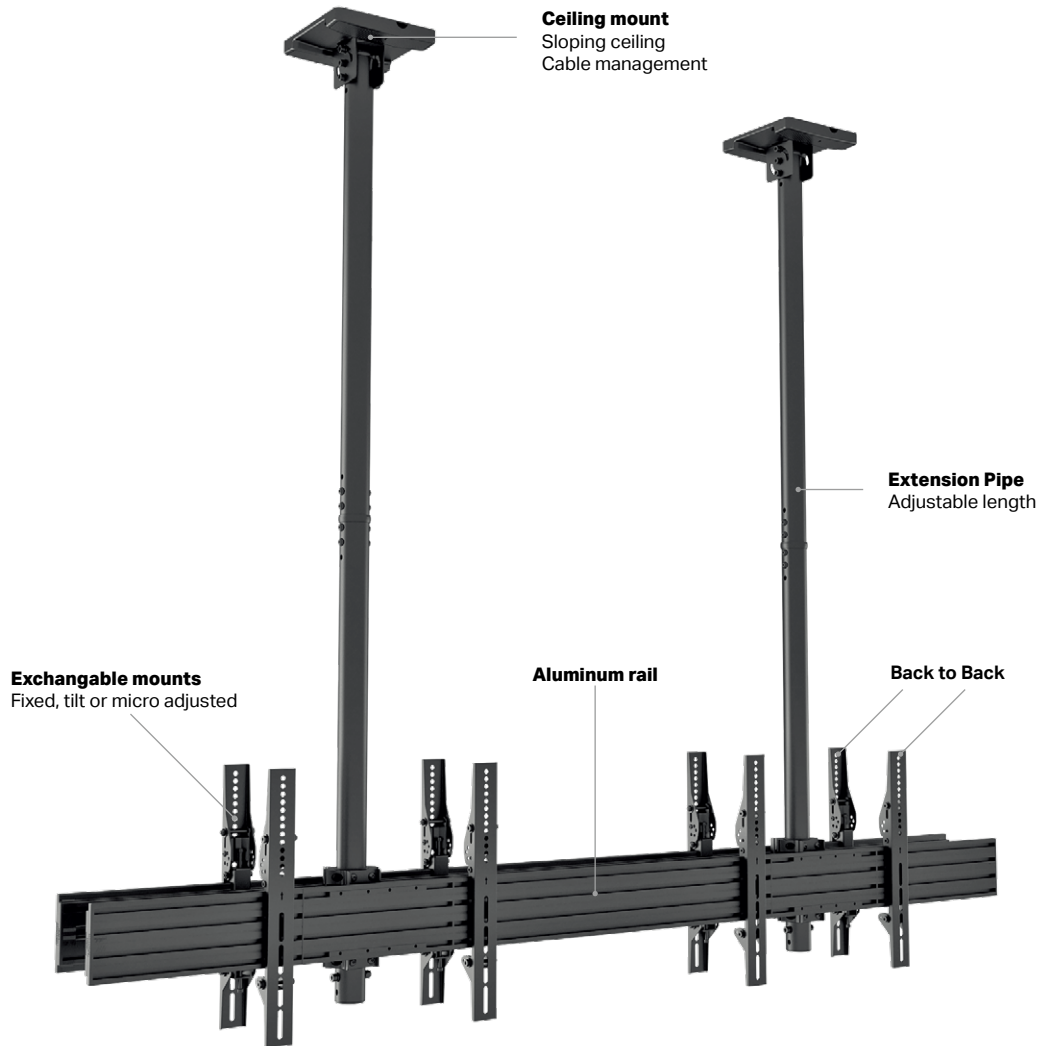

Great for installers and digital signage installations. Our ceiling mounted solutions make it possible to construct single, dual or video walls in prominent locations where

walls aren't available. Comes in a variety of arrangements. Our Ceilingmounts are designed to deliver a simple solution for any digital signage installations involving multiple commercial

displays 32"-100". Perfect for many commercial installations the space saving design ensures the very best installer experience.





					
Back to back optional	Cable management	Landscape and portrait	Max load tested 5x	Micro adjustable	

Starting from **1CU** to **9CUB2B**, using a total of 18 screens.

Multiple color options



**MBC1F VESA 200**



**MBC1F VESA 400**



**MBC1U VESA 200**



**MBC1U VESA 400**

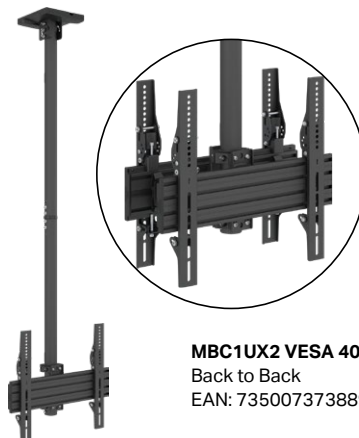

**MBC1UX2 VESA 400**  
Back to Back  
EAN: 7350073738892

	<b>MBC1F VESA 200</b>	<b>MBC1F VESA 400</b>	<b>MBC1U VESA 200</b>	<b>MBC1U VESA 400</b>
<b>Model name:</b>	MBC1F VESA 200	MBC1F VESA 400	MBC1U VESA 200	MBC1U VESA 400
<b>Recommended screen size:</b>	17"-42"	17"-42"	24"-42"	17"-42"
<b>VESA® &amp; non-VESA fixings:</b>	VESA200 ,20cm	VESA400 ,40cm	VESA200 ,20cm	VESA400 ,40cm
<b>EAN:</b>	7350073736416	7350073736423	7350073 733897	7350073738885
<b>Max load:</b>	30kg (Per screen)	30kg (Per screen)	30kg (Per screen)	30kg (Per screen)
<b>Bracket type:</b>	Tilt	Tilt	Tilt (Fixed optional)	Tilt (Fixed optional)
<b>Landscape/portrait:</b>	Yes	Yes	Yes	Yes
<b>Pole length:</b>	80 cm up to 150 cm	80 cm up to 150 cm	80 cm up to 150 cm	80 cm up to 150 cm
<b>Colour (VESA arms):</b>	Black	Black	Black	Black
<b>Colour (horizontal rail):</b>	Black (Silver optional)	Black (Silver optional)	Black (Silver optional)	Black (Silver optional)
<b>Colour (poles and ceiling mount):</b>	Black	Black	Black	Black
<b>Warranty:</b>	5 years	5 years	5 years	5 years
<b>Accessories:</b>	Cover plates	Cover plates	Cover plates	Cover plates

**MBC1U**



**MBC1UX2**



**MBC2X1U**



**MBC2X1U2**



Find 100+ models of Pro Series online

	<b>MBC1U</b>	<b>MBC1UX2</b>	<b>MBC2X1U</b>	<b>MBC2X1U2</b>
<b>Model name:</b>	MBC1U	MBC1UX2	MBC2X1U	MBC2X1U2
<b>Recommended screen size:</b>	40" - 65"	40" - 65"	40" - 65"	40" - 65"
<b>VESA® &amp; non-VESA fixings:</b>	VESA600x400 ,40cm	VESA600x400 ,40cm	VESA400 ,40cm	VESA400 ,40cm
<b>EAN:</b>	7350073733446	7350073733453	7350073733460	7350073733491
<b>Max load:</b>	30kg (Per screen)	30kg (Per screen)	30kg (Per screen)	30kg (Per screen)
<b>Bracket type:</b>	Tilt (Fixed optional)	Tilt (Fixed optional)	Tilt (Fixed optional)	Tilt (Fixed optional)
<b>Landscape/portrait:</b>	Yes	Yes	Yes	Yes
<b>Pole length:</b>	80 cm up to 150 cm	80 cm up to 150 cm	80 cm up to 300 cm	80 cm up to 300 cm
<b>Colour (VESA arms):</b>	Black	Black	Black	Black
<b>Colour (horizontal rail):</b>	Black (Silver optional)	Black (Silver optional)	Black (Silver optional)	Black (Silver optional)
<b>Colour (poles and ceiling mount):</b>	Black	Black	Black	Black
<b>Warranty:</b>	5 years	5 years	5 years	5 years
<b>Accessories:</b>	Cover plates	Cover plates	Cover plates	Cover plates

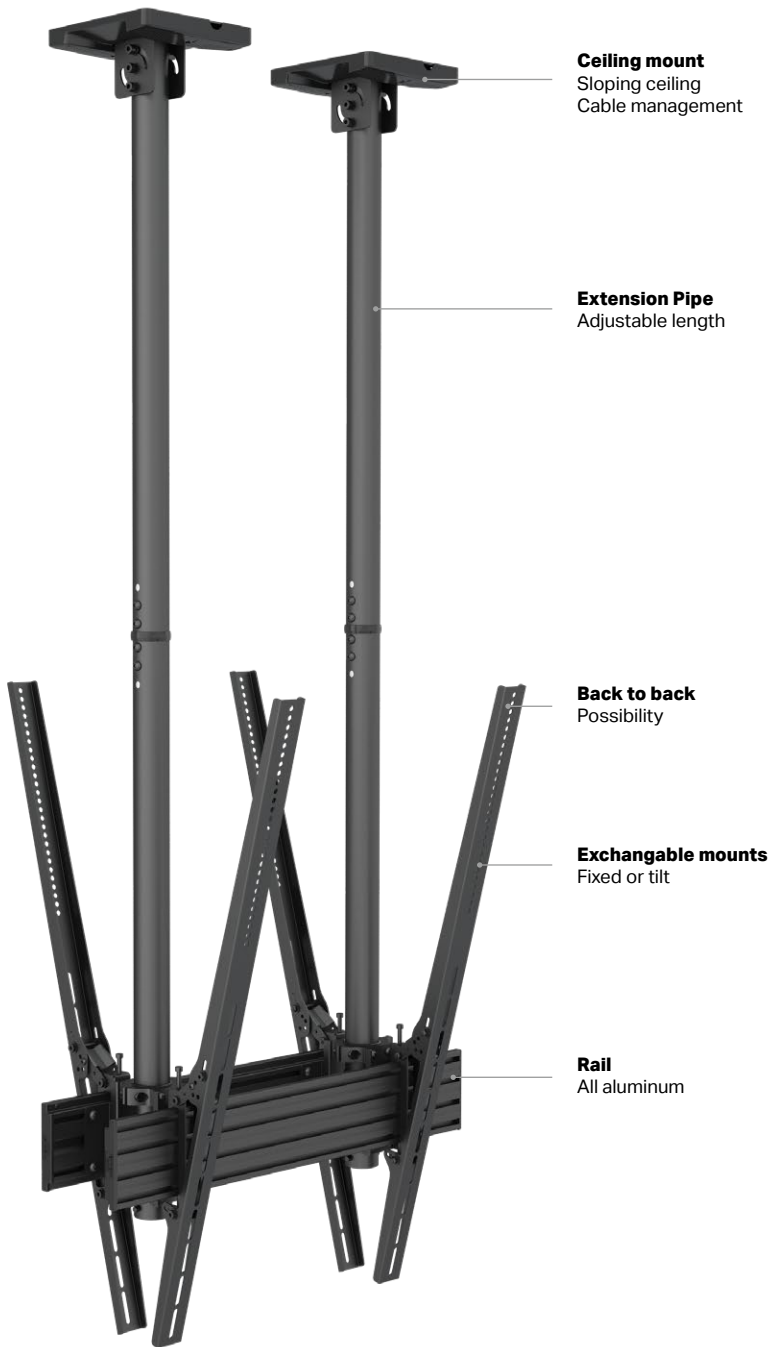

**Ceiling mount**  
Sloping ceiling  
Cable management

**Extension Pipe**  
Adjustable length

**Back to back**  
Possibility

**Exchangable mounts**  
Fixed or tilt

**Rail**  
All aluminum

# UHD Large Screen Ceiling Mounts

The Dual Pole range of Pro Series floorstand is designed to support one or two large size screens mounted back-to-back in either landscape or portrait. Simple to install, clean and attractive design, yet very robust and functional the Dual Pole series is ideal for a wide variety of applications and setting.

Designed to provide the ideal display viewing placement and match the décor of any environment. Ideal for public areas like stores, training rooms, lobbies, classrooms, auditoriums, or exhibit halls. As with all Pro series products a full line-up of accessories offering tailor possibilities functionality to meet your specific requirements. Internal cable management hides the AV cabling, showing a clean look.

-  Back to back optional
-  Cable management
-  Landscape and portrait
-  Max load tested 5x



Pro Series tested for 5 times the max load



Selected models are TUV approved



Design plate cover ceiling installation

**MBC1UHD**



**MBC1USD**



**MBC1UX2HD**



**MBC1UX2SD**



	<b>MBC1UPHD</b>	<b>MBC1USD</b>	<b>MBC1UX2HD</b>	<b>MBC1UX2SD</b>
<b>Model name:</b>	MBC1UPHD	MBC1USD	MBC1UX2HD	MBC1UX2SD
<b>Recommended screen size:</b>	40" - 75"	40" - 100"	40" - 75"	40" - 100"
<b>VESA® &amp; non-VESA fixings:</b>	VESA600 ,60cm	VESA600 ,60cm	VESA600 ,60cm	VESA600 ,60cm
<b>EAN:</b>	7350073735778	7350073735785	7350073736232	7350073736249
<b>Max load:</b>	90kg	135kg (Per screen)	90kg (Per screen)	90kg (Per screen)
<b>Bracket type:</b>	Tilt (Fixed optional)	Tilt (Fixed optional)	Tilt (Fixed optional)	Tilt (Fixed optional)
<b>Landscape/portrait:</b>	Yes	Yes	Yes	Yes
<b>Pole length:</b>	58 cm up to 150 cm	58 cm up to 150 cm	58 cm up to 150 cm	58 cm up to 150 cm
<b>Colour (VESA arms):</b>	Black	Black	Black	Black
<b>Colour (horizontal rail):</b>	Black (Silver optional)	Black (Silver optional)	Black (Silver optional)	Black (Silver optional)
<b>Colour (poles and ceiling mount):</b>	Black	Black	Black	Black
<b>Warranty:</b>	5 years	5 years	5 years	5 years
<b>Accessories:</b>	Cover plates	Cover plates	---	---

**MBC1UPHD**



**MBC1UPSD**



**MBC1UX2PHD**



**MBC1UX2PSD**



	<b>MBC1UPHD</b>	<b>MBC1UPSD</b>	<b>MBC1UX2PHD</b>	<b>MBC1UX2PSD</b>
<b>Model name:</b>	MBC1UPHD	MBC1UPSD	MBC1UX2PHD	MBC1UX2PSD
<b>Recommended screen size:</b>	40" - 75"	40" - 100"	40" - 75"	40" - 100"
<b>VESA® &amp; non-VESA fixings:</b>	VESA900 ,90cm	VESA900 ,90cm	VESA900 ,90cm	VESA900 ,90cm
<b>EAN:</b>	7350073736126	7350073736133	7350073736256	7350073736263
<b>Max load:</b>	90kg	180kg	90kg (Per screen)	90kg (Per screen)
<b>Bracket type:</b>	Tilt (Fixed optional)	Tilt (Fixed optional)	Tilt (Fixed optional)	Tilt (Fixed optional)
<b>Landscape/portrait:</b>	Yes	Yes	Yes	Yes
<b>Pole length:</b>	58 cm up to 150 cm	58 cm up to 150 cm	58 cm up to 150 cm	58 cm up to 150 cm
<b>Colour (VESA arms):</b>	Black	Black	Black	Black
<b>Colour (horizontal rail):</b>	Black (Silver optional)	Black (Silver optional)	Black (Silver optional)	Black (Silver optional)
<b>Colour (poles and ceiling mount):</b>	Black	Black	Black	Black
<b>Warranty:</b>	5 years	5 years	5 years	5 years
<b>Accessories:</b>	Cover plates	Cover plates	Cover plates	Cover plates

**MBC3X1U**



**MBC3X1U2**

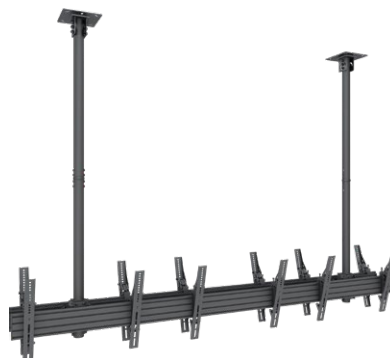

**MBC4X1U**

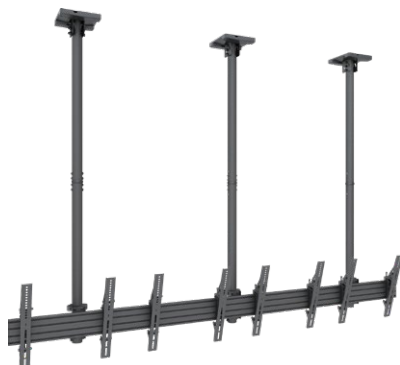

**MBC4X1U2**

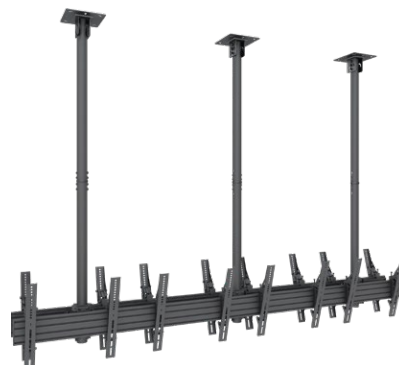

	<b>MBC3X1U</b>	<b>MBC3X1U2</b>	<b>MBC4X1U</b>	<b>MBC4X1U2</b>
<b>Model name:</b>	MBC3X1U	MBC3X1U2	MBC4X1U	MBC4X1U2
<b>Recommended screen size:</b>	40" - 65"	40" - 65"	40" - 65"	40" - 65"
<b>VESA® &amp; non-VESA fixings:</b>	VESA400 ,40cm	VESA400 ,40cm	VESA400 ,40cm	VESA400 ,40cm
<b>EAN:</b>	7350073733477	7350073733507	7350073733484	7350073733514
<b>Max load:</b>	30kg (Per screen)	30kg (Per screen)	30kg (Per screen)	30kg (Per screen)
<b>Bracket type:</b>	Tilt (Fixed optional)	Tilt (Fixed optional)	Tilt (Fixed optional)	Tilt (Fixed optional)
<b>Landscape/portrait:</b>	Yes	Yes	Yes	Yes
<b>Pole length:</b>	80 cm up to 300 cm	80 cm up to 300 cm	80 cm up to 300 cm	80 cm up to 300 cm
<b>Colour (VESA arms):</b>	Black	Black	Black	Black
<b>Colour (horizontal rail):</b>	Black (Silver optional)	Black (Silver optional)	Black (Silver optional)	Black (Silver optional)
<b>Colour (poles and ceiling mount):</b>	Black	Black	Black	Black
<b>Warranty:</b>	5 years	5 years	5 years	5 years
<b>Accessories:</b>	Cover plates	---	Cover plates	---

**MBC2U**



**MBC2U2**



**MBC2X2U**

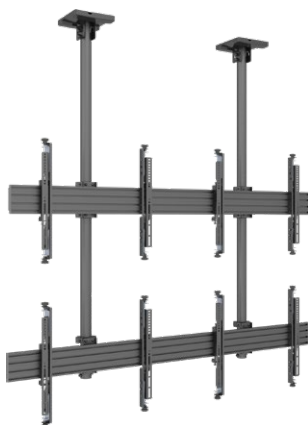

**MBC2X2U2**

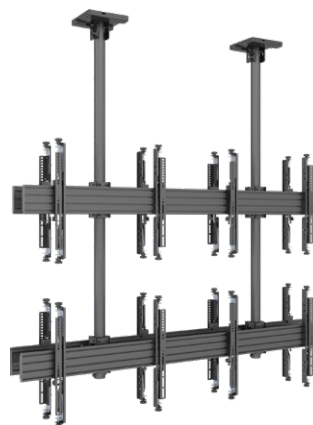

	<b>MBC2U</b>	<b>MBC2U2</b>	<b>MBC2X2U</b>	<b>MBC2X2U2</b>
<b>Model name:</b>	MBC2U	MBC2U2	MBC2X2U	MBC2X2U2
<b>Recommended screen size:</b>	40" - 65"	40" - 65"	46" - 65"	46" - 65"
<b>VESA® &amp; non-VESA fixings:</b>	VESA400,40cm	VESA400,40cm	VESA400,40cm	VESA400,40cm
<b>EAN:</b>	7350073733545	7350073733583	7350073733552	7350073733590
<b>Max load:</b>	30kg (Per screen)	30kg (Per screen)	30kg (Per screen)	30kg (Per screen)
<b>Bracket type:</b>	Fixed	Fixed	Micro-Adjustable Arms	Micro-Adjustable Arms
<b>Landscape/portrait:</b>	Yes	Yes	Yes	Yes
<b>Pole length:</b>	80 cm up to 150 cm	80 cm up to 150 cm	80 cm up to 300 cm	80 cm up to 300 cm
<b>Colour (VESA arms):</b>	Black	Black	Black	Black
<b>Colour (horizontal rail):</b>	Black (Silver optional)	Black (Silver optional)	Black (Silver optional)	Black (Silver optional)
<b>Colour (poles and ceiling mount):</b>	Black	Black	Black	Black
<b>Warranty:</b>	5 years	5 years	5 years	5 years
<b>Accessories:</b>	Cover plates	---	Cover plates	Cover plates



MBC3X2U



MBC3X2U2

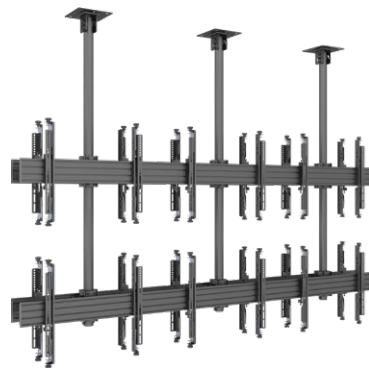

MBC3X3U





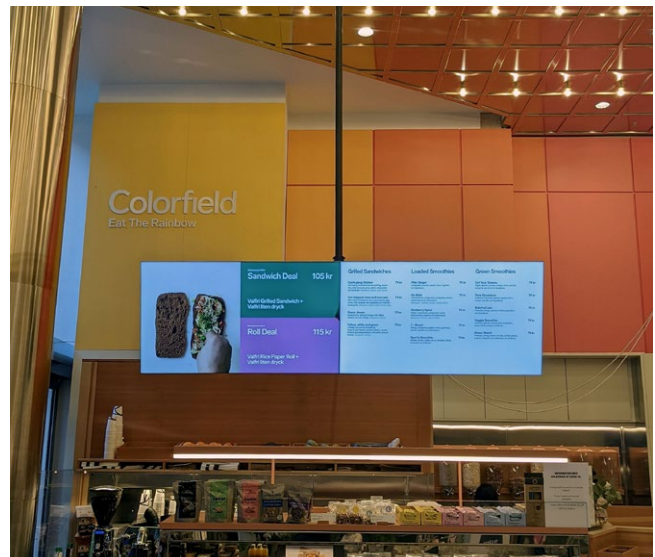



Pro Series creates magic results

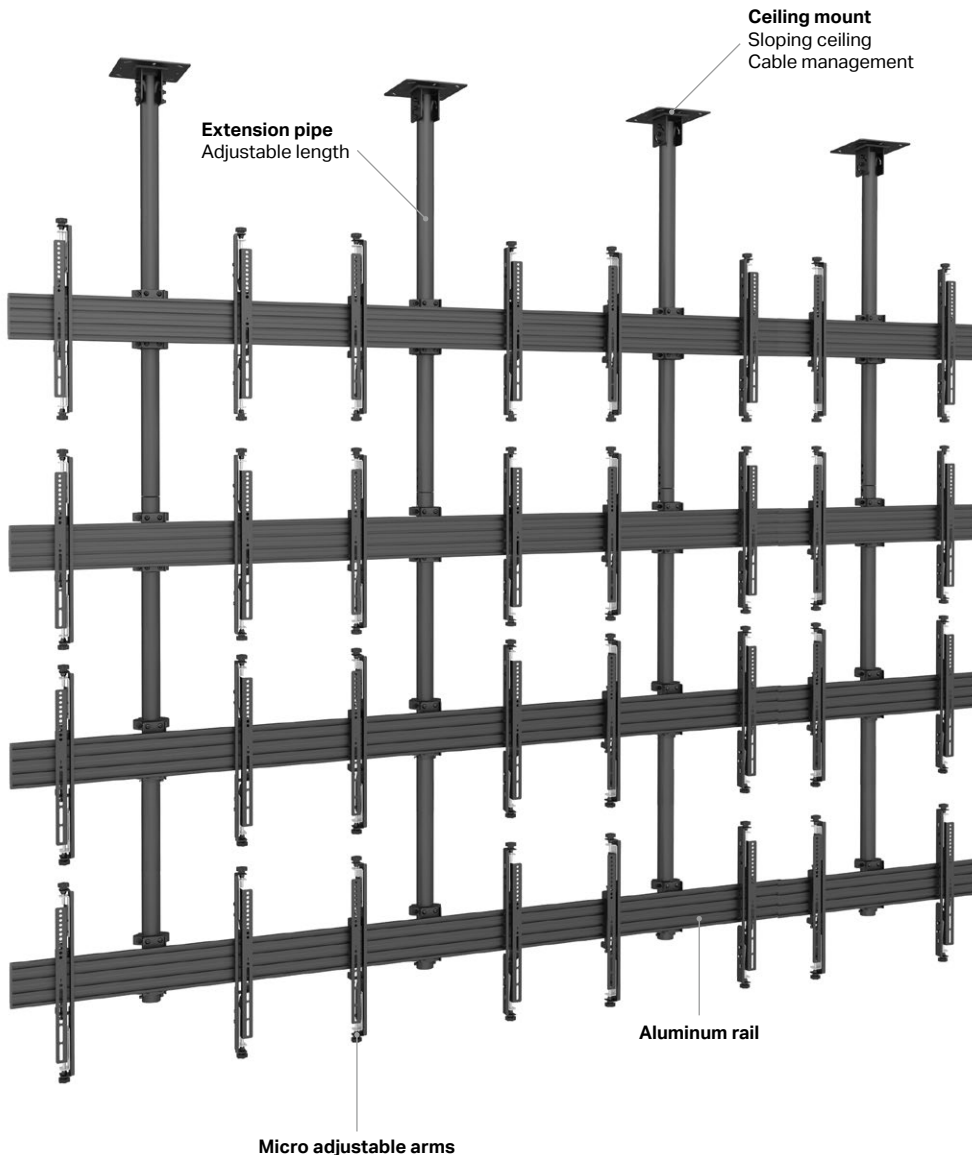

Model name:	MBC3X2U	MBC3X2U2	MBC3X3U
Recommended screen size:	46"-65"	46"-65"	46"-65"
VESA® & non-VESA fixings:	VESA400 ,40cm	VESA400 ,40cm	VESA400 ,40cm
EAN:	7350073733569	7350073733606	7350073733576
Max load:	30kg (Per screen)	30kg (Per screen)	30kg (Per screen)
Bracket type:	Tilt	Tilt	Tilt (Fixed optional)
Landscape/portrait:	Yes	Yes	Yes
Pole length:	80 cm up to 300 cm	80 cm up to 300 cm	80 cm up to 300 cm
Colour (VESA arms):	Black	Black	Black
Colour (horizontal rail):	Black (Silver optional)	Black (Silver optional)	Black (Silver optional)
Colour (poles and ceiling mount):	Black	Black	Black
Warranty:	5 years	5 years	5 years
Accessories:	Cover plates	---	---

MBC4X4





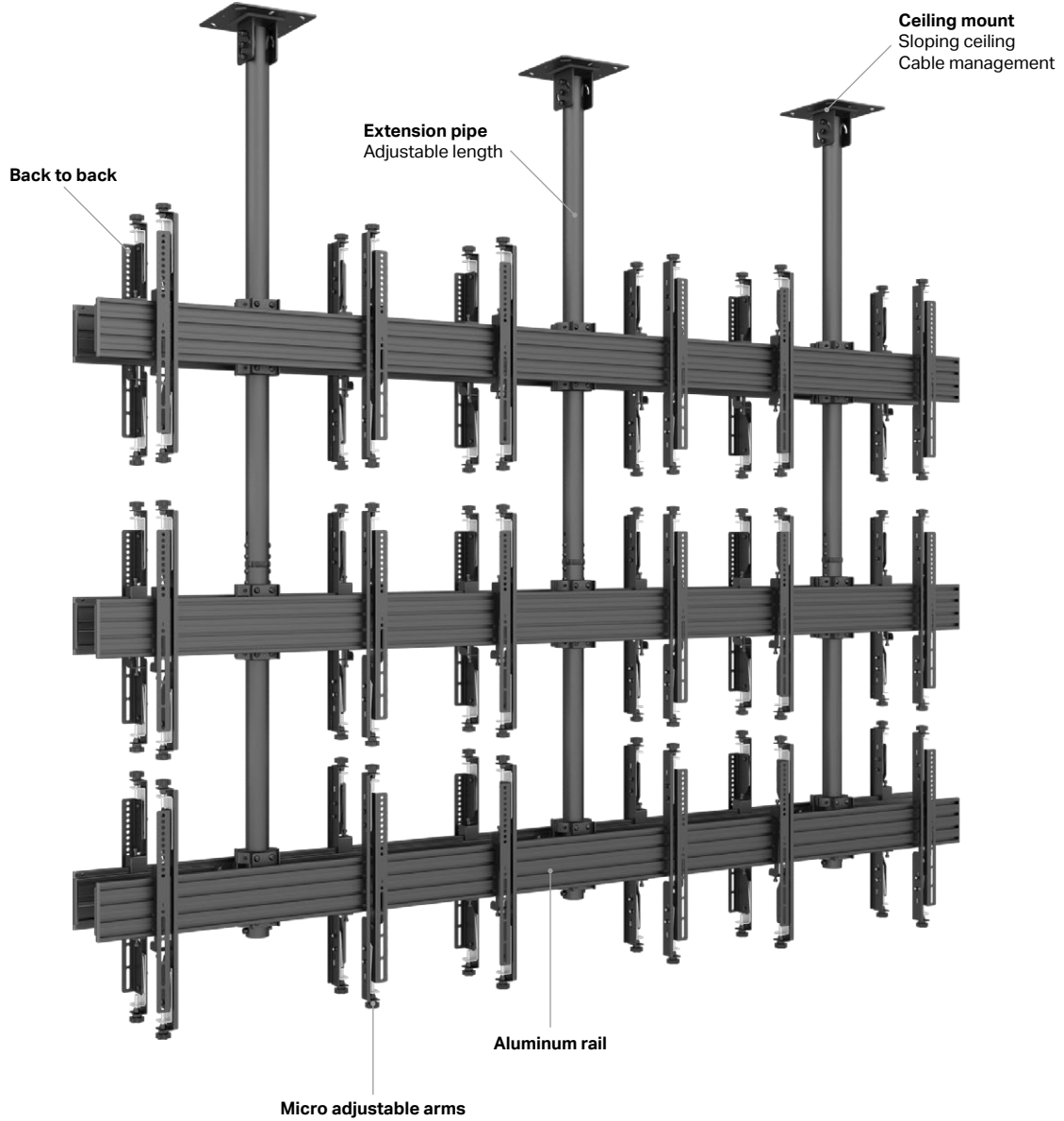

-   
 Back to back optional
-   
 Cable management
-   
 Landscape and portrait
-   
 Max load tested 5x
-   
 Micro adjustable

<b>Recommended screen size:</b>	46"-65"
<b>VESA® &amp; non-VESA fixings:</b>	VESA400 ,40cm
<b>EAN:</b>	7350073737864
<b>Max load:</b>	30kg (Per screen)
<b>Bracket type:</b>	Micro-Adjustable Arms
<b>Landscape/portrait:</b>	Yes
<b>Pole length:</b>	80 cm up to 300 cm
<b>Colour (VESA arms):</b>	Black
<b>Colour (horizontal rail):</b>	Black (Silver optional)
<b>Colour (poles and ceiling mount):</b>	Black
<b>Warranty:</b>	5 years

MBC4X4U2



-   
 Back to back optional
-   
 Cable management
-   
 Landscape and portrait
-   
 Max load tested 5x
-   
 Micro adjustable

<b>Recommended screen size:</b>	46"-65"
<b>VESA® &amp; non-VESA fixings:</b>	VESA400 ,40cm
<b>EAN:</b>	7350073733613
<b>Max load:</b>	30kg (Per screen)
<b>Bracket type:</b>	Micro-Adjustable Arms
<b>Landscape/portrait:</b>	Yes
<b>Pole length:</b>	80 cm up to 300 cm
<b>Colour (VESA arms):</b>	Black
<b>Colour (horizontal rail):</b>	Black (Silver optional)
<b>Colour (poles and ceiling mount):</b>	Black
<b>Warranty:</b>	5 years

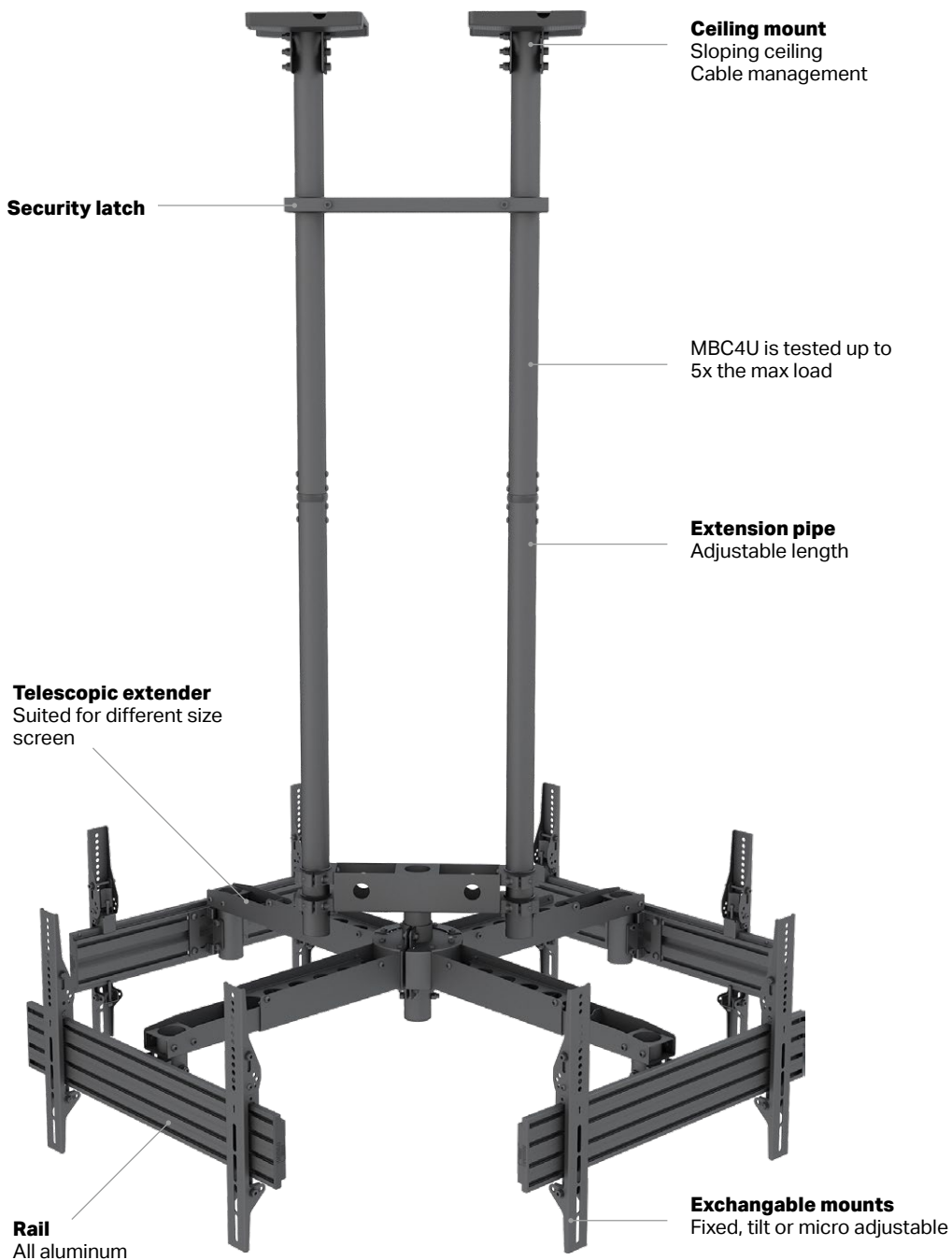

Pro Series tested for 5 times the max load



Selected models are TUV approved



Design plate cover ceiling installation



**MBC3U**



**MBC4U**



**MBC3UHD**



**MBC2P4U**



	<b>MBC3U</b>	<b>MBC4U</b>	<b>MBC3UHD</b>	<b>MBC2P4U</b>
<b>Model name:</b>	MBC3U	MBC4U	MBC3UHD	MBC2P4U
<b>Recommended screen size:</b>	32"-65"	32"-65"	50"-75"	50"-75"
<b>VESA® &amp; non-VESA fixings:</b>	VESA400 ,40cm	VESA400 ,40cm	VESA400 ,40cm	VESA400 ,40cm
<b>EAN:</b>	7350073733521	7350073733538	7350073738861	7350073738878
<b>Max load:</b>	30kg (Per screen)	30kg (Per screen)	30kg (Per screen)	30kg (Per screen)
<b>Bracket type:</b>	Tilt	Tilt	Tilt	Tilt
<b>Landscape/portrait:</b>	Yes	Yes	Yes	Yes
<b>Pole length:</b>	80 cm up to 300 cm	80 cm up to 300 cm	80 cm up to 300 cm	80 cm up to 300 cm
<b>Colour (VESA arms):</b>	Black	Black	Black	Black
<b>Colour (horizontal rail):</b>	Black (Silver optional)	Black (Silver optional)	Black (Silver optional)	Black (Silver optional)
<b>Telescopic:</b>	355-424mm	510-735mm	393-498mm	577-862mm
<b>Warranty:</b>	5 years	5 years	5 years	5 years
<b>Accessories:</b>	Cover plates	Cover plates	Cover plates	Cover plates







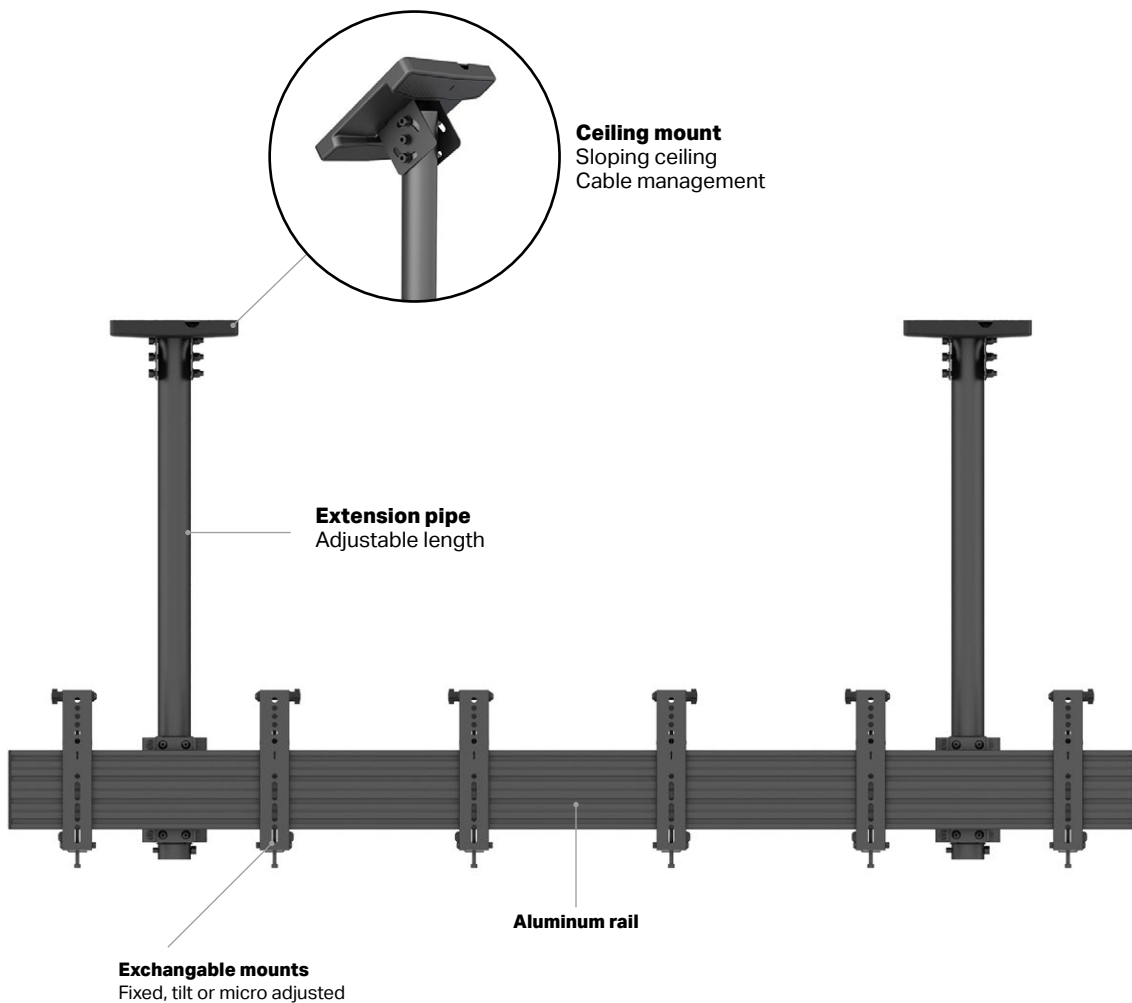

## Pro Series Menu Boards Mounts

Great for installers and digital signage installations. Our ceiling mounted solutions make it possible to construct single, dual or video walls in prominent locations where

walls aren't available. Comes in a variety of arrangements. Our Ceilingmounts are designed to deliver a simple solution for any digital signage installations involving multiple commercial

displays 32"-100". Perfect for many commercial installations the space saving design ensures the very best installer experience.



-   
 Back to back optional
-   
 Cable management
-   
 Landscape and portrait
-   
 Max load tested 5x
-   
 Micro adjustable



Multiple color options

*Flexible menu boards. Starting at 1U builds up to 10U's side by side, landscape or portrait.*

**MBC1X1U VESA 200**



**MBC3X1U VESA 200**

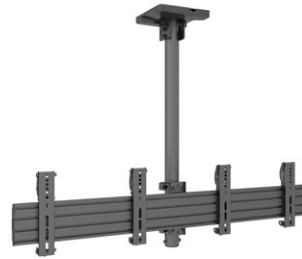

**MBC4X1U VESA 200**

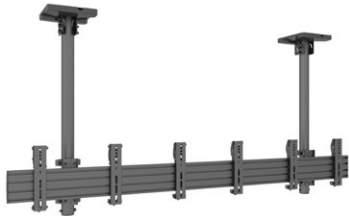

**MBC4X1U VESA 200**

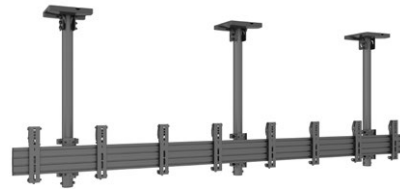

**MBC1X1U**

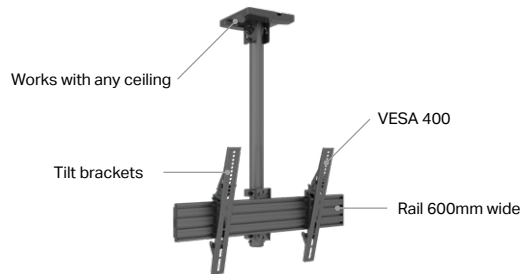

	<b>MBC1X1U VESA 200</b>	<b>MBC3X1U VESA 200</b>	<b>MBC4X1U VESA 200</b>	<b>MBC4X1UP</b>
<b>Model name:</b>	MBC1X1U VESA 200	MBC3X1U VESA 200	MBC4X1U VESA 200	MBC4X1UP
<b>Recommended screen size:</b>	24"-43"	32"-42"	32"-42"	32" - 65"
<b>VESA® &amp; non-VESA fixings:</b>	VESA200 ,20cm	VESA200 ,20cm	VESA200 ,20cm	VESA400 ,40cm
<b>EAN:</b>	7350105212321	7350073735662	7350073735679	7350073734931
<b>Max load:</b>	30kg	30kg (Per screen)	30kg (Per screen)	30kg (Per screen)
<b>Bracket type:</b>	Tilt (Fixed optional)	Tilt (Fixed optional)	Tilt (Fixed optional)	Tilt (Fixed optional)
<b>Landscape/portrait:</b>	Yes	Yes	Yes	Portrait
<b>Pole length:</b>	80 cm up to 150 cm	80 cm up to 150 cm	80 cm up to 150 cm	80 cm up to 150 cm
<b>Colour (VESA arms):</b>	Black	Black	Black	Black
<b>Colour (horizontal rail):</b>	Black (Silver optional)	Black (Silver optional)	Black (Silver optional)	Black (Silver optional)
<b>Colour (poles and ceiling mount):</b>	Black	Black	Black	Black
<b>Warranty:</b>	5 years	5 years	5 years	5 years
<b>Accessories:</b>	Cover plates	Cover plates	Cover plates	Cover plates



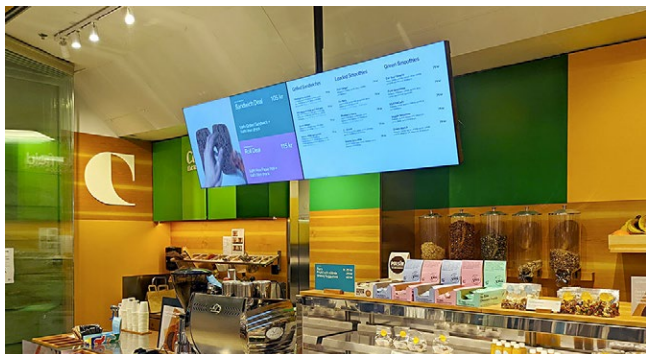

MBC2X1U with Dual Displays Landscape

**MBC2X1U**



**MBC3X1U**

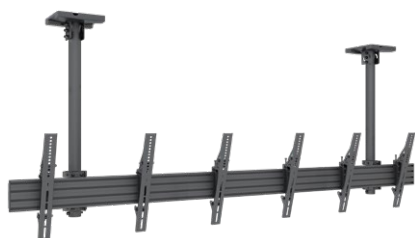

**MBC4X1U**



**MBC5X1U**



Model name:	MBC1X1U	MBC2X1U	MBC3X1U	MBC4X1U	MBC5X1U
Recommended screen size:	32"~65"	32" - 65"	32" - 65"	32" - 65"	32" - 65"
VESA® & non-VESA fixings:	VESA400,40cm	VESA400,40cm	VESA400,40cm	VESA400,40cm	VESA400,40cm
EAN:	7350105212338	7350073733460	7350073734924	7350073733484	TBD
Max load:	30kg (Per screen)	30kg (Per screen)	30kg (Per screen)	30kg (Per screen)	30kg (Per screen)
Bracket type:	Tilt (Fixed optional)	Tilt (Fixed optional)	Tilt (Fixed optional)	Tilt (Fixed optional)	Tilt (Fixed optional)
Landscape/portrait:	Yes	Landscape	Portrait	Landscape	Landscape
Pole length:	58 cm up to 150 cm	80 cm up to 150 cm	80 cm up to 150 cm	80 cm up to 150 cm	80 cm up to 150 cm
Colour (VESA arms):	Black	Black	Black	Black	Black
Colour (horizontal rail):	Black (Silver optional)	Black (Silver optional)	Black (Silver optional)	Black (Silver optional)	Black (Silver optional)
Colour (poles and ceiling mount):	Black	Black	Black	Black	Black
Warranty:	5 years	5 years	5 years	5 years	5 years
Accessories:	Cover plates	Cover plates	Cover plates	Cover plates	Cover plates

**MBC5X1UP VESA 200**



**MBC3X1UP**

For portrait add a set of brackets



**MBC4X1UP**

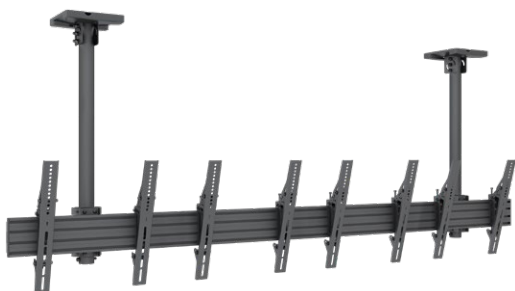

**MBC5X1UP**

7350105215070 M Menu Board Mount Pro MBC5X1UP



	<b>MBC5X1UP</b>	<b>MBC3X1U</b>	<b>MBC4X1UP</b>	<b>MBC5X1UP</b>
<b>Model name:</b>	MBC5X1UP	MBC3X1U	MBC4X1UP	MBC5X1UP
<b>Recommended screen size:</b>	32" - 65"	32" - 65"	32" - 65"	32" - 65"
<b>VESA® &amp; non-VESA fixings:</b>	VESA400 ,40cm	VESA400 ,40cm	VESA400 ,40cm	VESA400 ,40cm
<b>EAN:</b>	735010521 5070	7350073733477	7350073734931	7350105215070
<b>Max load:</b>	30kg (Per screen)	30kg (Per screen)	30kg (Per screen)	30kg (Per screen)
<b>Bracket type:</b>	Tilt (Fixed optional)	Tilt (Fixed optional)	Tilt (Fixed optional)	Tilt (Fixed optional)
<b>Landscape/portrait:</b>	Portrait	Landscape	Portrait	Portrait
<b>Pole length:</b>	80 cm up to 150 cm	80 cm up to 150 cm	80 cm up to 150 cm	80 cm up to 150 cm
<b>Colour (VESA arms):</b>	Black	Black	Black	Black
<b>Colour (horizontal rail):</b>	Black	Black	Black	Black
<b>Colour (poles and ceiling mount):</b>	Black	Black	Black	Black
<b>Warranty:</b>	5 years	5 years	5 years	5 years
<b>Accessories:</b>	Cover plates	Cover plates	Cover plates	Cover plates

**MBW1U Tilt 200**



**MBW2U Tilt 200**



**MBW3U Tilt 200**



**MBW2X1U**



**MBC3X1U**



**MBC3X1UP**



**MBC4X1UP**



Model name:	MBW1U Tilt 200	MBW2U Tilt 200	MBW3U Tilt 200	MBW2X1U	MBC3X1U	MBC3X1UP	MBC4X1UP
Recommended screen size:	24"-43"	24"-43"	24"-43"	32" - 65"	32" - 65"	32" - 65"	32" - 65"
VESA® & non-VESA fixings:	VESA200 ,20cm	VESA200 ,20cm	VESA200 ,20cm	VESA400 ,40cm	VESA400 ,40cm	VESA400 ,40cm	VESA400 ,40cm
EAN:	7350073737024	7350073737031	7350073737048	7350073734061	7350073734078	7350073734061 +7350073733743	7350073734078 +7350073733743
Max load:	30kg	30kg	30kg	30kg (Per screen)	30kg (Per screen)	30kg (Per screen)	30kg (Per screen)
Bracket type:	Tilt (Fixed optional)	Tilt (Fixed optional)	Tilt (Fixed optional)	Tilt (Fixed optional)	Tilt (Fixed optional)	Tilt (Fixed optional)	Tilt (Fixed optional)
Landscape/portrait:	Yes	Yes	Yes	Yes	Yes	Yes	Yes
Pole length:	80 cm up to 150 cm	80 cm up to 150 cm	80 cm up to 150 cm	80 cm up to 150 cm	80 cm up to 150 cm	80 cm up to 150 cm	80 cm up to 150 cm
Colour (VESA arms):	Black	Black	Black	Black	Black	Black	Black
Colour (horizontal rail):	Black	Black	Black	Black	Black	Black	Black
Colour (poles and ceiling mount):	Black	Black	Black	Black	Black	Black	Black
Warranty:	5 years	5 years	5 years	5 years	5 years	5 years	5 years
Accessories:	Cover plates	Cover plates	Cover plates	Cover plates	Cover plates	Cover plates	Cover plates



Design cone cover floor and ceiling mount



Selected models are TUV approved



Pro Series tested for 5 times the max load

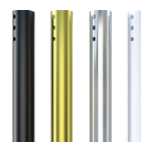

Change color of the poles

## Pro Series Floor to Ceiling Mounts Solutions

Our floor to ceiling solutions makes it possible to construct menu boards in prominent locations where walls aren't available. An aesthetic solution that adds stability to locations

where the ceiling or wall aren't able to support an installation. In store Digital Signage is one of the fastest growing sector of the POS market. Our unique floor to ceiling mounts

solutions are both dynamic and flexible and often becomes an immediate focal point with holding a display with modern looks and eye catching clean appearance.

**New model:**  
MBFC1UD: 735007373 7734  
(As shown on picture)

**MBFC1U**



**MBFC1U Brass**



**MBFC1U Chrome**



**MBFC1U White**



	<b>MBFC1U</b>	<b>MBFC1U Brass</b>	<b>MBFC1U Chrome</b>	<b>MBFC1U White</b>
<b>Model name:</b>	<b>MBFC1U</b>	<b>MBFC1U Brass</b>	<b>MBFC1U Chrome</b>	<b>MBFC1U White</b>
<b>Recommended screen size:</b>	32" - 65"	32" - 65"	32" - 65"	32" - 65"
<b>VESA® &amp; non-VESA fixings:</b>	VESA400 ,40cm	VESA400 ,40cm	VESA400 ,40cm	VESA400 ,40cm
<b>EAN:</b>	7350073733620	7350073735709	7350073735693	7350073735686
<b>Max load:</b>	30kg (Per screen)	30kg (Per screen)	30kg (Per screen)	30kg (Per screen)
<b>Bracket type:</b>	Fixed	Fixed	Fixed	Fixed
<b>Landscape/portrait:</b>	Yes	Yes	Yes	Yes
<b>Pole length:</b>	150 cm up to 300 cm	150 cm up to 300 cm	150 cm up to 300 cm	150 cm up to 300 cm
<b>Colour (VESA arms):</b>	Black	Black	Black	Black
<b>Colour (horizontal rail):</b>	Black (Silver optional)	Black (Silver optional)	Black (Silver optional)	Black (Silver optional)
<b>Colour (poles and ceiling mount):</b>	Black	Black	Black	Black
<b>Warranty:</b>	5 years	5 years	5 years	5 years
<b>Accessories:</b>	Cover plates	Cover plates	Cover plates	Cover plates



- Bar/ Restaurant
- Conference room
- Guest Room
- Gym/ Spa
- Lobby
- Reception/ Desk
- Health Care Room

# Pro Series Hospitality products

**MBFC1UD**

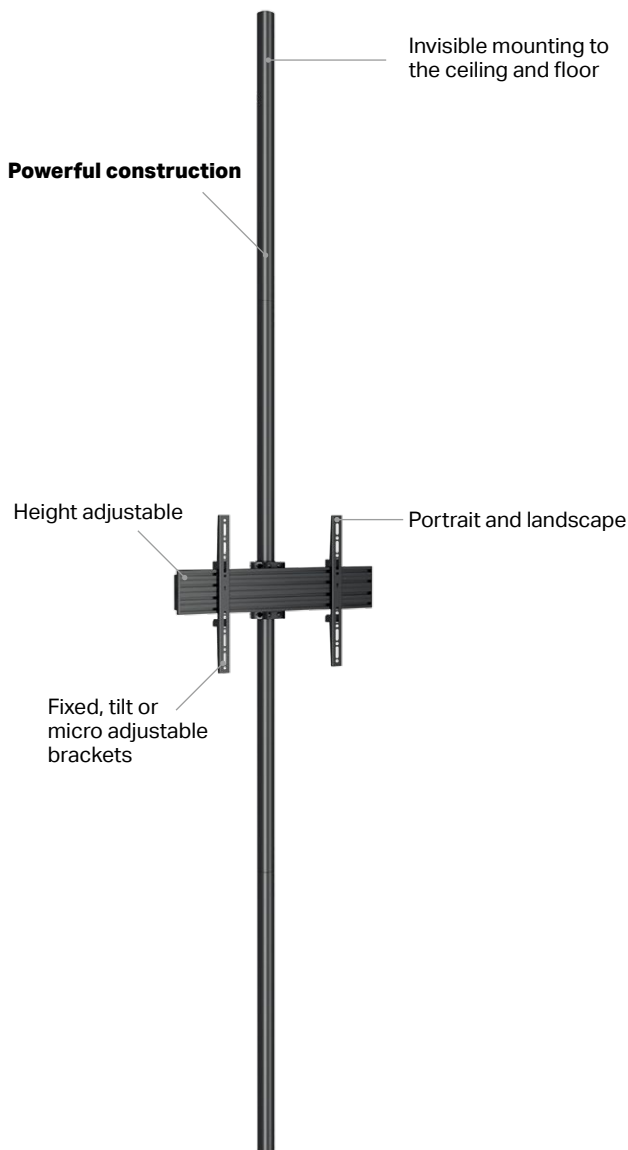

**Highlights:**

- . A professional, flexible and modular product
- . Includes VESA adapters for compatibility up to VESA 600x400
- . Integrated cable management throughout the entire solution
- . Power click install for an easy, fast and safe installation
- . Portrait or landscape position of screen possible
- . Hardware kit included

With the rapid change in A/V solutions its important to utilize hardware and services to enable its full value. Hotels, Restaurants, Bars or Sports arenas. Always keep your guests happy.

<b>Model:</b>	<b>MBFC1UD</b>
<b>EAN:</b>	7350073737734
<b>For screen size:</b>	40"-65"
<b>Type:</b>	Single Side MBFC1U
<b>Universal &amp; VESA standard:</b>	100x100,200x200,300x300,400x400
<b>Material:</b>	Steel, Aluminium
<b>Color:</b>	Black
<b>Surface Finish:</b>	Powder coating
<b>Weight:</b>	13 kg
<b>Measurements</b>	49x17.4x300 cm
<b>Max Load:</b>	30 kg per screen
<b>Pillar length:</b>	3000 mm from ceiling to VESA plate center
<b>Cable Management:</b>	Yes
<b>Options:</b>	Extension pipes : 0.8m, 1.5m, 3.0m
<b>Certifications:</b>	CE
<b>Warranty:</b>	5 years

**MBFC2U**

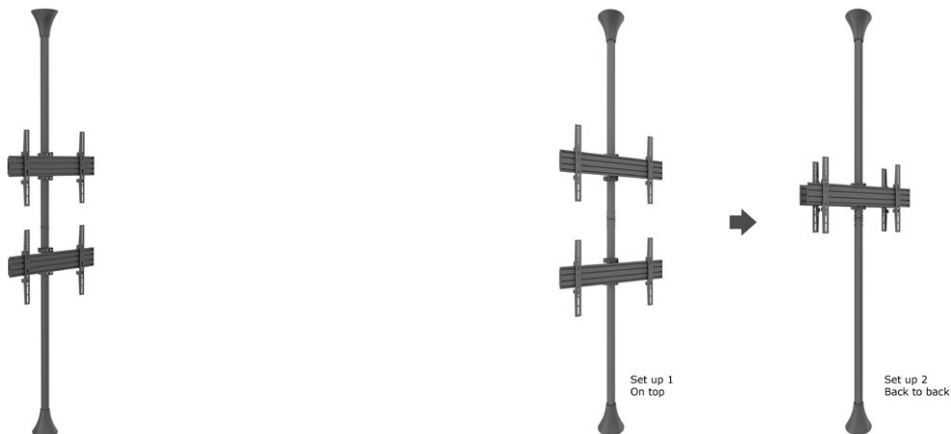

**MBFC2U Brass**

**MBFC2U Chrome**

**MBFC2U White**



	<b>MBFC1U</b>	<b>MBFC1U Brass</b>	<b>MBFC1U Chrome</b>	<b>MBFC1U White</b>
<b>Model name:</b>	<b>MBFC1U</b>	<b>MBFC1U Brass</b>	<b>MBFC1U Chrome</b>	<b>MBFC1U White</b>
<b>Recommended screen size:</b>	32" - 65"	32" - 65"	32" - 65"	32" - 65"
<b>VESA® &amp; non-VESA fixings:</b>	VESA400 ,40cm	VESA400 ,40cm	VESA400 ,40cm	VESA400 ,40cm
<b>EAN:</b>	7350073733637	7350073735730	7350073735723	7350073735716
<b>Max load:</b>	30kg (Per screen)	30kg (Per screen)	30kg (Per screen)	30kg (Per screen)
<b>Bracket type:</b>	Fixed	Fixed	Fixed	Fixed
<b>Landscape/portrait:</b>	Yes	Yes	Yes	Yes
<b>Pole length:</b>	150 cm up to 300 cm	150 cm up to 300 cm	150 cm up to 300 cm	150 cm up to 300 cm
<b>Colour (VESA arms):</b>	Black	Black	Black	Black
<b>Colour (horizontal rail):</b>	Black (Silver optional)	Black (Silver optional)	Black (Silver optional)	Black (Silver optional)
<b>Colour (poles and ceiling mount):</b>	Black	Black	Black	Black
<b>Warranty:</b>	5 years	5 years	5 years	5 years
<b>Accessories:</b>	Cover plates	Cover plates	Cover plates	Cover plates



**MBFC3U**

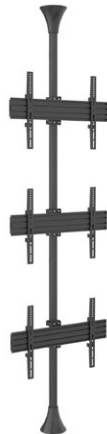

**MBFC3U Brass**



**MBFC3U Chrome**



**MBFC3U White**



	<b>MBFC3U</b>	<b>MBFC3U Brass</b>	<b>MBFC3U Chrome</b>	<b>MBFC3U White</b>
<b>Model name:</b>	MBFC3U	MBFC3U Brass	MBFC3U Chrome	MBFC3U White
<b>Recommended screen size:</b>	32" - 65"	32" - 65"	32" - 65"	32" - 65"
<b>VESA® &amp; non-VESA fixings:</b>	VESA400,40cm	VESA400,40cm	VESA400,40cm	VESA400,40cm
<b>EAN:</b>	7350073733644	7350073735761	7350073735754	7350073735747
<b>Max load:</b>	30kg (Per screen)	30kg (Per screen)	30kg (Per screen)	30kg (Per screen)
<b>Bracket type:</b>	Fixed	Fixed	Fixed	Fixed
<b>Landscape/portrait:</b>	Yes	Yes	Yes	Yes
<b>Pole length:</b>	150 cm up to 300 cm	150 cm up to 300 cm	150 cm up to 300 cm	150 cm up to 300 cm
<b>Colour (VESA arms):</b>	Black	Black	Black	Black
<b>Colour (horizontal rail):</b>	Black (Silver optional)	Black (Silver optional)	Black (Silver optional)	Black (Silver optional)
<b>Colour (poles and ceiling mount):</b>	Black	Black	Black	Black
<b>Warranty:</b>	5 years	5 years	5 years	5 years
<b>Accessories:</b>	Cover plates	Cover plates	Cover plates	Cover plates

**MBFC1X2U2**



For back to back add items per piece :

- 7350073733668 Pole Clamp
- 7350073733866 Single Rail
- 7350073733736 Fixed arms(40cm)

**MBFC1X3U2**



For back to back add items per piece :

- 7350073733668 Pole Clamp
- 7350073733866 Single Rail
- 7350073733736 Fixed arms(40cm)

**MBFC2X3U**



**MBFC3X3U**

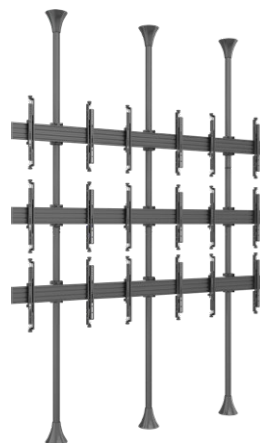

	<b>MBFC1X2U2</b>	<b>MBFC1X3U2</b>	<b>MBFC2X3U</b>	<b>MBFC3X3U</b>
<b>Model name:</b>	<b>MBFC1X2U2</b>	<b>MBFC1X3U2</b>	<b>MBFC2X3U</b>	<b>MBFC3X3U</b>
<b>Recommended screen size:</b>	32" - 65"	32" - 65"	32" - 65"	32" - 65"
<b>VESA® &amp; non-VESA fixings:</b>	VESA400 ,40cm	VESA400 ,40cm	VESA400 ,40cm	VESA400 ,40cm
<b>EAN:</b>	7350073734962	7350073734979	7350073734986	7350073734933
<b>Max load:</b>	30kg (Per screen)	30kg (Per screen)	30kg (Per screen)	30kg (Per screen)
<b>Bracket type:</b>	Fixed	Fixed	Micro-Adjustable Arms	Micro-Adjustable Arms
<b>Landscape/portrait:</b>	Yes	Yes	Yes	Yes
<b>Pole length:</b>	150 cm up to 300 cm	150 cm up to 300 cm	150 cm up to 300 cm	150 cm up to 300 cm
<b>Colour (VESA arms):</b>	Black	Black	Black	Black
<b>Colour (horizontal rail):</b>	Black (Silver optional)	Black (Silver optional)	Black (Silver optional)	Black (Silver optional)
<b>Colour (poles and ceiling mount):</b>	Black/ Brass/ Chrome/ White	Black/ Brass/ Chrome/ White	Black/ Brass/ Chrome/ White	Black/ Brass/ Chrome/ White
<b>Warranty:</b>	5 years	5 years	5 years	5 years
<b>Accessories:</b>	Cover plates	Cover plates	Cover plates	Cover plates

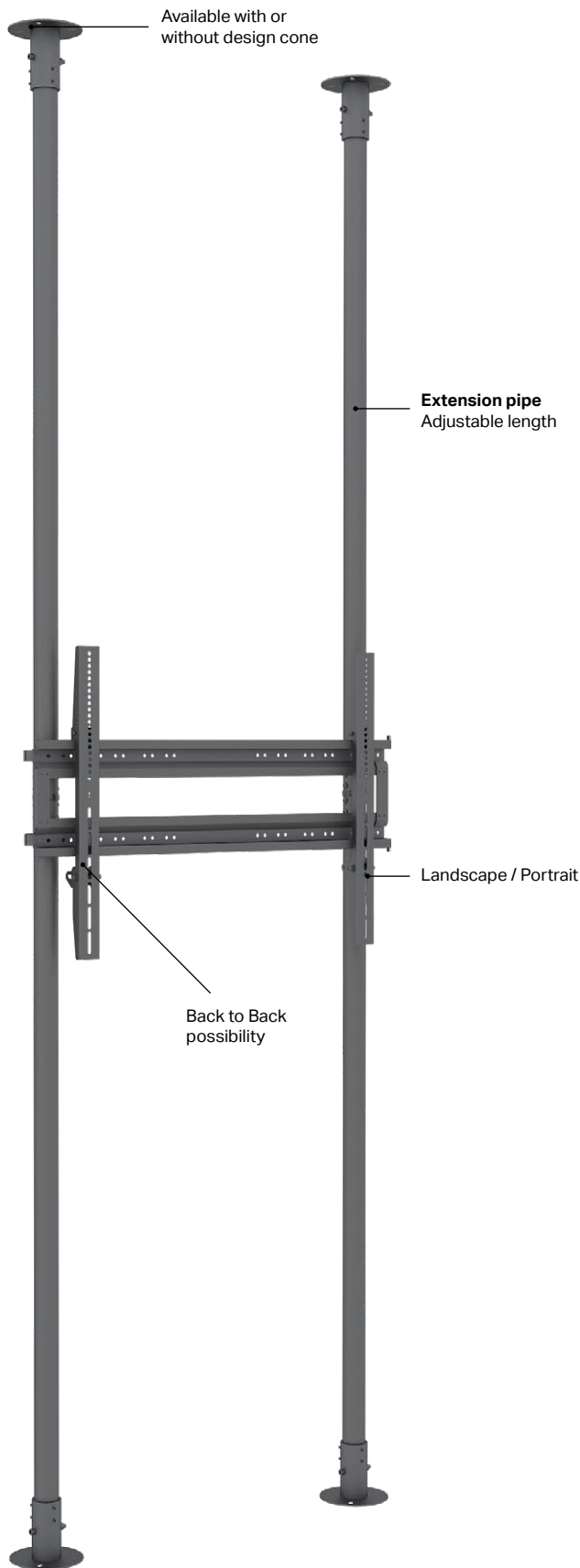

**New!**

## Floor to Ceiling Mounts Pro

In store Digital Signage is one of the fastest growing sector of the POS market. Our unique floor to ceiling mounts solutions are both dynamic and flexible and often becomes an immediate focal point with holding a display with modern looks and eye catching clean appearance.

**New model:**

MBFC1UD: 735007373 7932  
(As shown on picture)

### Add extra brackets:

**Pole bracket 800x600**



EAN: 7350105210310

**Pole bracket 600x900**



EAN: 7350105210310

**MBFC1UHD**



Single landscape

**MBFC2UHD**



Back to Back possibility

**MBFC1UPHD**



Single portrait

**MBFC2UPD**



Back to Back possibility

	<b>MBFC1UHD</b>	<b>MBFC2UHD</b>	<b>MBFC1UPHD</b>	<b>MBFC2UPHD</b>
<b>Model name:</b>	<b>MBFC1UHD</b>	<b>MBFC2UHD</b>	<b>MBFC1UPHD</b>	<b>MBFC2UPHD</b>
<b>Recommended screen size:</b>	50" - 90"	50" - 90"	50" - 90"	50" - 90"
<b>VESA® &amp; non-VESA fixings:</b>	VESA800 ,80cm	VESA800 ,80cm	VESA900 ,90cm	VESA900 ,90cm
<b>EAN:</b>	7350073737932	7350073737949	7350073737956	7350073737963
<b>Max load:</b>	80kg (Per screen)	80kg (Per screen)	80kg (Per screen)	80kg (Per screen)
<b>Bracket type:</b>	Pole bracket 800X600	Pole bracket 800X600	Pole bracket 600X900	Pole bracket 600X900
<b>Landscape/portrait:</b>	Landscape	Landscape	Portrait	Portrait
<b>Pole length:</b>	310 cm	310 cm	310 cm	310 cm
<b>Colour (VESA arms):</b>	Black	Black	Black	Black
<b>Colour (horizontal rail):</b>	Black (Silver optional)	Black (Silver optional)	Black (Silver optional)	Black (Silver optional)
<b>Colour (poles and ceiling mount):</b>	Black	Black	Black	Black
<b>Warranty:</b>	5 years	5 years	5 years	5 years
<b>Accessories:</b>	Yes (optional)	Yes (optional)	Yes (optional)	Yes (optional)

## Monitor Mount

### FIXED VERSION

10mm height adj.



### TILT VERSION

10mm height adj.



10mm height adj.

Rotation  
360°

VESA  
75x75 to  
100x100mm

Tilt -12° ~ +12°

EAN: 7350073736300

EAN: 7350073736294

### M Pro Series

## VESA Flexarm Pro 400

VESA 400 EAN: 7350073736331

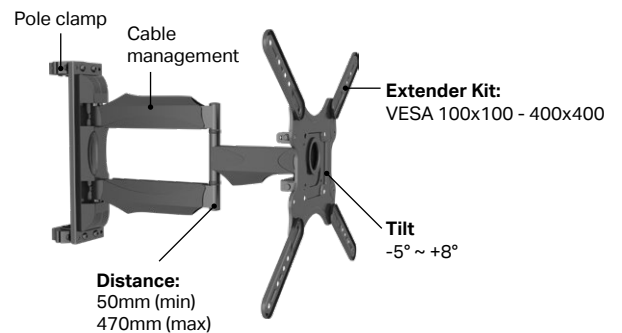

### M Pro Series

## VESA Flexarm Pro 600

VESA 600 EAN: 7350105212499

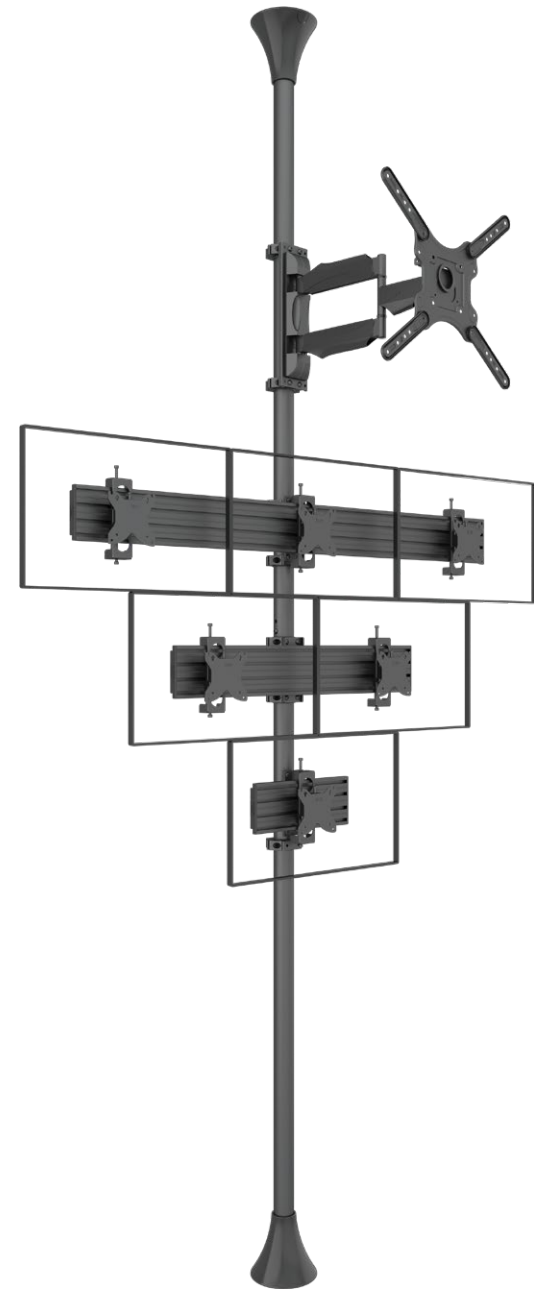
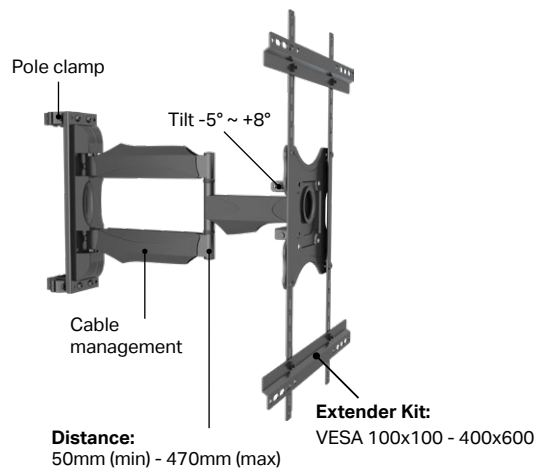

## Monitor holders, pole brackets, monitor arms and flex arms.

The line up of M Pro Series Pole Brackets was designed to make it simple to add a display small or large and create tailored installations with the possibility to mix both computer displays with digital signage displays in any possible way imagined.

With the M Pro Series Pole line of brackets it includes a variety of flexible and innovative solutions. From installing a single computer display to a row of computer displays all fitted to the Pro Series 50mm poles.

**Floor to ceiling (for monitors)**

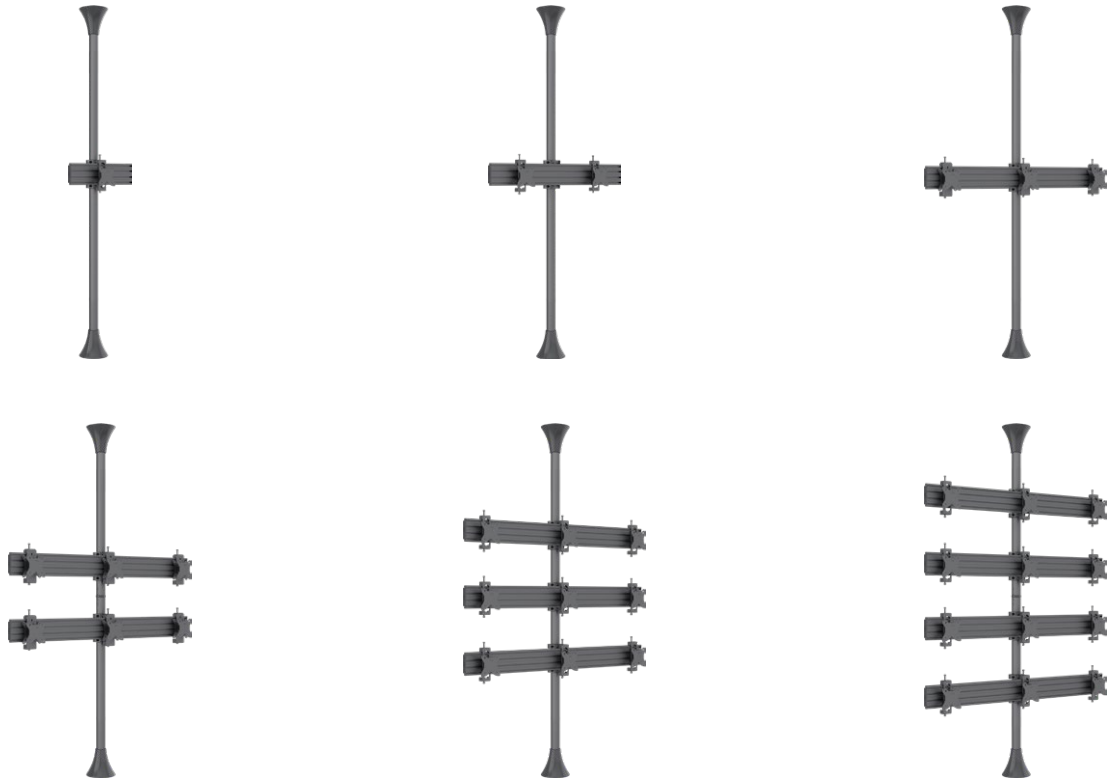

**Ceiling mount (for monitors)**



**Wall mount (for monitors)**



**MBFC1F VESA 200**

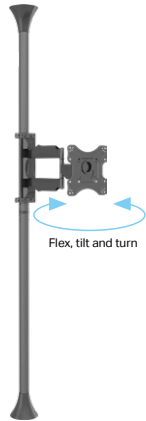

**MBFC1F**



**MBFC1FP**



**MBC1F VESA 200**



**MBC1F**



**MBC1FP**



<b>Model name:</b>	<b>MBFC1F VESA 200</b>	<b>MBFC1F</b>	<b>MBFC1FP</b>	<b>MBC1F VESA 200</b>	<b>MBC1F</b>	<b>MBC1FP</b>
<b>Recommended screen size:</b>	17"-42"	42"-55"	50"-70"	17"-42"	42"-55"	50"-70"
<b>VESA® &amp; non-VESA fixings:</b>	VESA200 ,20cm	VESA400 ,40cm	VESA600 ,60cm	VESA200 ,20cm	VESA400 ,40cm	VESA600 ,60cm
<b>EAN:</b>	7350073736393	7350073736409	7350105212505	7350073736416	7350073736423	7350105212512
<b>Max load:</b>	35kg (Per screen)	35kg (Per screen)	35kg (Per screen)	35kg (Per screen)	35kg (Per screen)	35kg (Per screen)
<b>Bracket type:</b>	Tilt	Tilt	Tilt	Tilt	Tilt	Tilt
<b>Landscape/portrait:</b>	Yes	Yes	Yes	Yes	Yes	Yes
<b>Pole length:</b>	580 cm up to 300 cm	580 cm up to 300 cm	580 cm up to 300 cm	580 cm up to 300 cm	580 cm up to 300 cm	580 cm up to 300 cm
<b>Colour (VESA arms):</b>	Black	Black	Black	Black	Black	Black
<b>Colour (horizontal rail):</b>	Black (Silver optional)	Black (Silver optional)	Black (Silver optional)	Black (Silver optional)	Black (Silver optional)	Black (Silver optional)
<b>Colour (poles and ceiling mount):</b>	Black/ Brass/Chrome/ White	Black/ Brass/Chrome/ White	Black/ Brass/Chrome/ White	Black/ Brass/Chrome/ White	Black/ Brass/Chrome/ White	Black/ Brass/Chrome/White
<b>Warranty:</b>	5 years	5 years	5 years	5 years	5 years	5 years
<b>Accessories:</b>	Cover plates	Cover plates	Cover plates	Cover plates	Cover plates	Cover plates



## Pro Series Floor to wall mount

The M Floor to Wall Mount creates a rock steady screen display solution aimed for the retail store, mall or any other public area. 50mm black, brass or chrome tubes can be

tailored to fit the environment the unit is positioned in. Mount screens with tilt or fixed displays. Place them side by side and/or above each other.



**MBFW1U**



**MBFW2U**

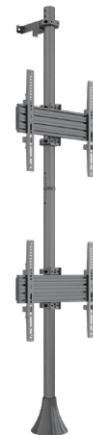

**MBFW3U**



**MBFW3U2U**

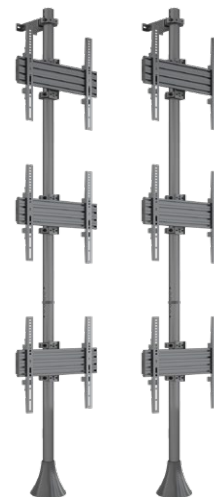

	<b>MBFW1U</b>	<b>MBFW2U</b>	<b>MBFW3U</b>	<b>MBFW3U2U</b>
<b>Model name:</b>	<b>MBFW1U</b>	<b>MBFW2U</b>	<b>MBFW3U</b>	<b>MBFW3U2U</b>
<b>Recommended screen size:</b>	32" - 65"	32" - 65"	32" - 65"	32" - 65"
<b>VESA® &amp; non-VESA fixings:</b>	VESA400 ,40cm	VESA400 ,40cm	VESA400 ,40cm	VESA400 ,40cm
<b>EAN:</b>	7350105214141	7350105214158	7350105214165	7350105214165 x2
<b>Max load:</b>	30kg (Per screen)	30kg (Per screen)	30kg (Per screen)	30kg (Per screen)
<b>Bracket type:</b>	Fixed	Fixed	Fixed	Fixed
<b>Landscape/portrait:</b>	Yes	Yes	Yes	Yes
<b>Pole length:</b>	150 cm up to 300 cm	150 cm up to 300 cm	150 cm up to 300 cm	150 cm up to 300 cm
<b>Colour (VESA arms):</b>	Black	Black	Black	Black
<b>Colour (horizontal rail):</b>	Black (Silver optional)	Black (Silver optional)	Black (Silver optional)	Black (Silver optional)
<b>Colour (poles and ceiling mount):</b>	Black/ Brass/Chrome/ White	Black/ Brass/Chrome/ White	Black/ Brass/Chrome/ White	Black/ Brass/Chrome/ White
<b>Warranty:</b>	5 years	5 years	5 years	5 years
<b>Accessories:</b>	Cover plates	Cover plates	Cover plates	Cover plates



## Pro Series

# Wall mounted solutions

Our Pro Series Wallmounts can be used as menu boards or signage wallmounts. They offer a perfect display positioning and flexible adjustments. The single horizontal extrusion with

optional push in pop out and depth adjustment aligns the displays very quick even on irregular mounting surfaces and allows easy access behind the displays for servicing.

# Build Pro Wallmount video walls

For screen in a row the Pro Series now can offer you a simple way to get perfect display positioning and a choice of bracket and adjustment solutions that works after a set standard. Ensuring the very best installer experience a

single aluminum extrusion rail is used with either fixed, tilt or push in pop out brackets that aligns the screens quick and efficiently.

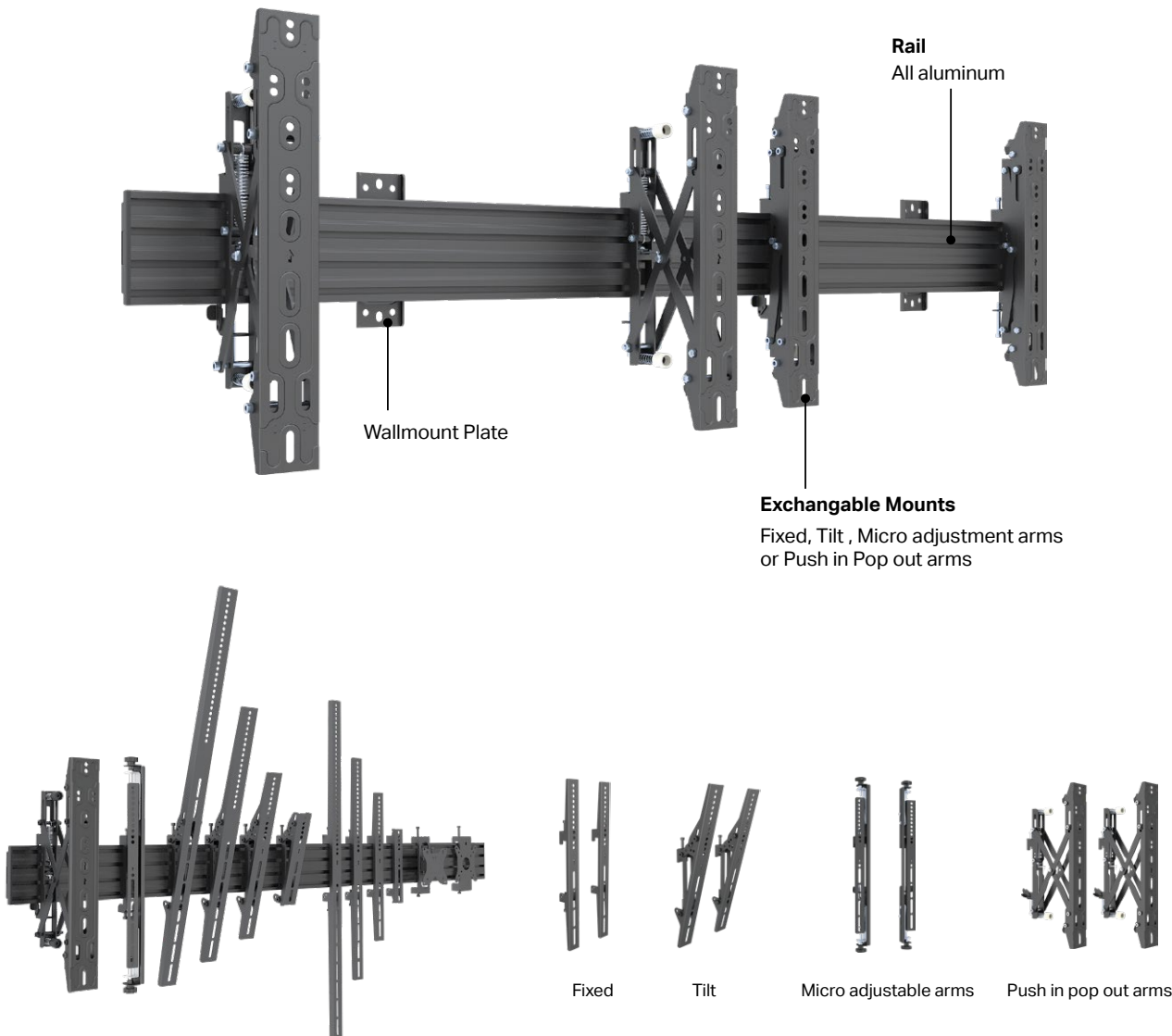

## A wide variety of arms:

- Push in pop-out:** 400mm
- Tilt:** 200/400/600/900mm
- Fixed:** 200/400/600/900mm
- Micro adjustable:** 400/ 600mm

**MBW1U 48cm**



**MBW2U**



**MBW1U 68cm**



**MBW3U**



Model name:	MBW1U 48cm (Black)	MBW2U (Black)	MBW1U 68cm (Black)	MBW3U (Black)
Recommended screen size:	40" - 65"	40" - 65"	40" - 65"	40" - 65"
VESA® & non-VESA fixings:	VESA400 ,40cm	VESA400 ,40cm	VESA400 ,40cm	VESA400 ,40cm
EAN:	7350073735105	7350073734122	7350073734115	7350073734139
Max load:	35kg	30kg (Per screen)	35kg	30kg (Per screen)
Bracket type:	Push in pop out	Push in pop out	Push in pop out	Push in pop out
Landscape/portrait:	Yes	Yes	Yes	Yes
Wall distance:	9.6cm to 22.3cm	9.6cm to 22.3cm	9.6cm to 22.3cm	9.6cm to 22.3cm
Colour (VESA arms):	Black	Black	Black	Black
Colour (horizontal rail):	Black (Silver optional)	Black (Silver optional)	Black (Silver optional)	Black (Silver optional)
Warranty:	5 years	5 years	5 years	5 years

**MBW2UX2**

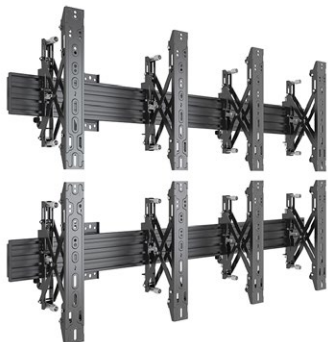

**MBW2UX3**

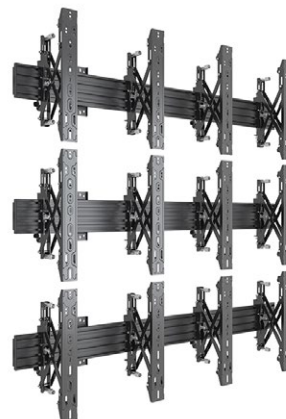

**MBW3X2U**

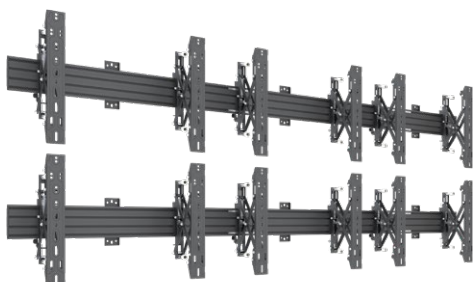

**MBW3X3U**

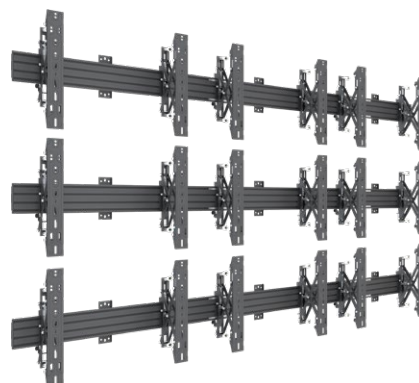

	<b>MBW2UX2 Push In Pop Out</b>	<b>MBW2UX3 Push In Pop Out</b>	<b>MBW3X2U</b>	<b>MBW3X3U</b>
<b>Recommended screen size:</b>	40" - 65"	40" - 65"	40" - 65"	40" - 65"
<b>VESA® &amp; non-VESA fixings:</b>	VESA400 ,40cm	VESA400 ,40cm	VESA 400 ,40cm	VESA 400 ,40cm
<b>EAN:</b>	7350105212628	7350105212635	7350073735006	7350073735013
<b>Max load:</b>	30kg (Per screen)	30kg (Per screen)	30kg (Per screen)	30kg (Per screen)
<b>Bracket type:</b>	Push in pop out	Push in pop out	Push in pop out	Push in pop out
<b>Landscape/portrait:</b>	Yes	Yes	Yes	Yes
<b>Wall distance:</b>	9.6cm to 22.3cm	9.6cm to 22.3cm	9.6cm to 22.3cm	9.6cm to 22.3cm
<b>Colour (VESA arms):</b>	Black	Black	Black	Black
<b>Colour (horizontal rail):</b>	Black (Silver optional)	Black (Silver optional)	Black (Silver optional)	Black (Silver optional)
<b>Warranty:</b>	5 years	5 years	5 years	5 years

**MBW2X1UP**

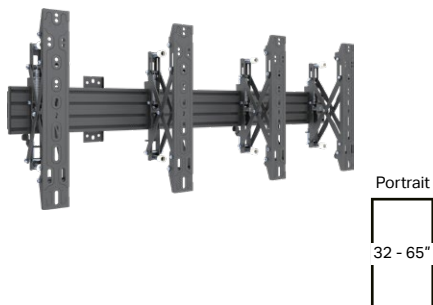

**MBW3X1UP**

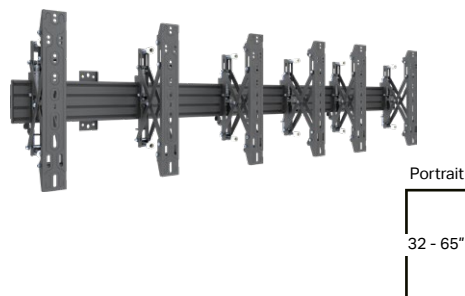

**MBW3X2UP**

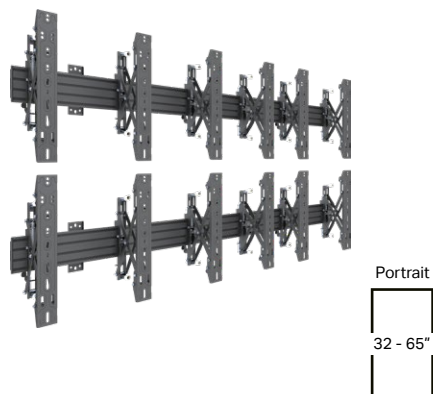

**MBW3X3UP**

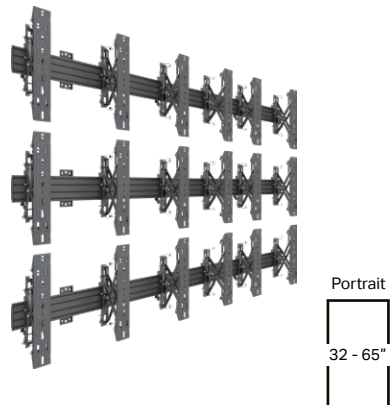

	<b>MBW2X1UP</b>	<b>MBW3X1UP</b>	<b>MBW3X2UP</b>	<b>MBW3X3UP</b>
<b>Model name:</b>	<b>MBW2X1UP</b>	<b>MBW3X1UP</b>	<b>MBW3X2UP</b>	<b>MBW3X3UP</b>
<b>Recommended screen size:</b>	40" - 65"	40" - 65"	40" - 65"	40" - 65"
<b>VESA® &amp; non-VESA fixings:</b>	VESA400 ,40cm	VESA400 ,40cm	VESA400 ,40cm	VESA400 ,40cm
<b>EAN:</b>	7350073735020	7350073735037	7350073735044	7350073735051
<b>Max load:</b>	30kg (Per screen)	30kg (Per screen)	30kg (Per screen)	30kg (Per screen)
<b>Bracket type:</b>	Push in pop out	Push in pop out	Push in pop out	Push in pop out
<b>Landscape/portrait:</b>	Portrait	Portrait	Portrait	Portrait
<b>Wall distance:</b>	9.6cm to 22.3cm	9.6cm to 22.3cm	9.6cm to 22.3cm	9.6cm to 22.3cm
<b>Colour (VESA arms):</b>	Black	Black	Black	Black
<b>Colour (horizontal rail):</b>	Black (Silver optional)	Black (Silver optional)	Black (Silver optional)	Black (Silver optional)
<b>Warranty:</b>	5 years	5 years	5 years	5 years

# Pro Series range of Universal Interface Arms

## Fixed



M Pro Series  
Fixed Arms 200mm



M Pro Series  
Fixed Arms 400mm



M Pro Series  
Fixed Arms 600mm



M Pro Series  
Fixed Arms 900mm

<b>EAN:</b>	7350073733903	7350073733736	7350073733750	7350073733774
<b>Material:</b>	Steel	Steel	Steel	Steel
<b>Weight:</b>	1.5 kg (pcs)	2.2 kg (2pcs)	3 kg (2pcs)	5 kg (2pcs)
<b>Size:</b>	230x35x33 mm	430x35x33 mm	630x35x33 mm	930x35x30 mm
<b>Max load:</b>	30 kg / screen	30 kg / screen	30 kg / screen	30 kg / screen

## Tilt



M Pro Series  
Tilt Arms 200mm



M Pro Series  
Tilt Arms 400mm



M Pro Series  
Tilt Arms 600mm



M Pro Series  
Tilt Arms 900mm

<b>EAN:</b>	7350073733910	7350073733743	7350073733767	7350073733781
<b>Material:</b>	Steel	Steel, aluminum	Steel	Steel
<b>Weight:</b>	3 kg (pcs)	3.5 kg (pcs)	5 kg (2pcs)	6.5 kg (2pcs)
<b>Size:</b>	230x68.5x39 mm	430x68.5x39 mm	630x68.5x39 mm	930x68.5x39 mm
<b>Max load:</b>	30 kg / screen	30 kg / screen	30 kg / screen	30 kg / screen

## Push in Pop out



M Pro Series  
M Push in Pop out  
VESA 400



M Pro Series  
M Push in Pop out Arms  
600 mm



M Pro Series  
Micro-Adjustable Arms  
400mm



M Pro Series  
Micro-Adjustable Arms  
600mm

<b>EAN:</b>	7350073734726	7350105210464	7350073733798	7350105210457
<b>Material:</b>	Steel	Steel	Steel	Steel
<b>Weight:</b>	4.5 kg (pcs)	4.5 kg (pcs)	5 kg (pcs)	3.5 + 4.3 kg (2 pcs)
<b>Size:</b>	455x165x80 mm	950x110x88 mm	543x49x47 mm	655x120x72 mm
<b>Max load:</b>	30 kg / screen	30 kg / screen	30 kg / screen	30 kg / screen

## Micro adjustable



## Pro Series Wallmounts with micro adjustable

With the built in fine tune adjustments each of the M Wallmount Pro Micro Adjustable Black can be adjusted individually to match "its neighbouring screens". With its built in simple to reach knobs, the screens can be adjusted in depth, side and height. What before could take hours for an installer to measure and reinstall, is now fixed in a matter of minutes, Truly an

installers dream come true. Designed with our Scandinavian heritage in mind. Providing a clean Nordic look each part and detail serves its purpose. The result is a sleek Nordic solution emphasizing quality and function. Used in a variety of environments this ceiling mount is truly versatile and is made of the highest quality materials.

### Easy-access to your after-service

Our Micro adjustable wall-mounts also creates easy-access to a display to quick and safe serviceability for sensitive screens with mm precision. This is often one of the major

functions needed when building a video wall mounting solution or when integrating a single screen into the wall.

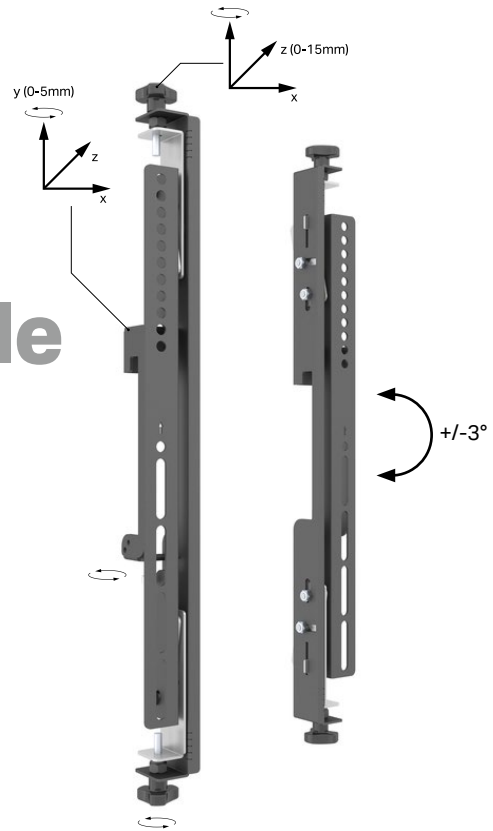

#### Portrait installations

VESA extender kits  
EAN: 7350073734733

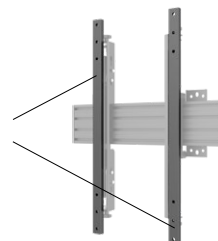



**MBW1U 400 (Micro Adjustable)**



**MBW2U (Micro Adjustable)**



**MBW3U (Micro Adjustable)**

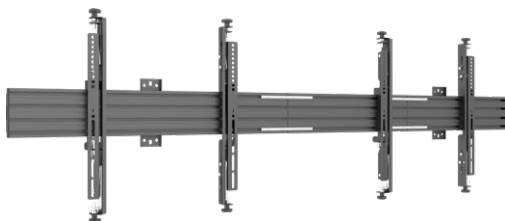

**MBW3U (Micro Adjustable)**

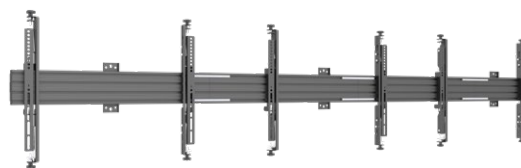

	<b>MBW1U 400 (Micro Adjustable)</b>	<b>MBW1U (Micro Adjustable)</b>	<b>MBW2U (Micro Adjustable)</b>	<b>MBW3U (Micro Adjustable)</b>
<b>Model name:</b>	MBW1U 400 (Micro Adjustable)	MBW1U (Micro Adjustable)	MBW2U (Micro Adjustable)	MBW3U (Micro Adjustable)
<b>Recommended screen size:</b>	43" - 65"	43" - 65"	43" - 65"	43" - 65"
<b>VESA® &amp; non-VESA fixings:</b>	VESA400 ,40cm	VESA400 ,40cm	VESA400 ,40cm	VESA400 ,40cm
<b>EAN:</b>	7350105214080	7350105210624	7350105210631	7350105210648
<b>Max load:</b>	45kg	45kg	30kg (Per screen)	30kg (Per screen)
<b>Bracket type:</b>	Micro Adjustable	Micro Adjustable	Micro Adjustable	Micro Adjustable
<b>Landscape/portrait:</b>	Yes	Yes	Yes	Yes
<b>Wall distance:</b>	58mm to 73mm	58mm to 73mm	58mm to 73mm	58mm to 73mm
<b>Colour (VESA arms):</b>	Black (Silver optional)	Black (Silver optional)	Black (Silver optional)	Black (Silver optional)
<b>Colour (horizontal rail):</b>	Black (Silver optional)	Black (Silver optional)	Black (Silver optional)	Black (Silver optional)
<b>Warranty:</b>	5 years	5 years	5 years	5 years

**MBW1U Fixed 200**



**MBW2U Fixed 200**

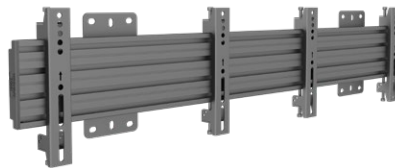

**MBW3U Fixed 200**

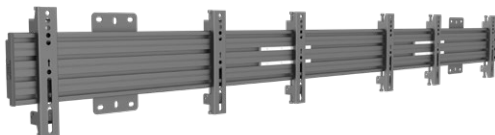

**MBW1U Tilt 200**



**MBW2U Tilt 200**



**MBW3U Tilt 200**



Model name:	MBW1U Fixed 200	MBW2U Fixed 200	MBW3U Fixed 200	MBW1U Tilt 200	MBW2U Tilt	MBW3U Tilt
Recommended screen size:	17" - 42"	27" - 42"	27" - 42"	17" - 42"	40" - 65"	40" - 65"
VESA® & non-VESA fixings:	VESA200 ,20cm	VESA200 ,20cm	VESA200 ,20cm	VESA200 ,20cm	VESA400 ,40cm	VESA400 ,40cm
EAN:	7350073736997	7350073737031	7350073737048	7350073737024	7350073734061	7350073734078
Max load:	30kg	30kg (Per screen)	30kg (Per screen)	30kg (Per screen)	30kg (Per screen)	30kg (Per screen)
Bracket type:	Fixed (Tilt optional)	Fixed (Tilt optional)	Fixed (Tilt optional)	Tilt (Fixed optional)	Tilt	Tilt
Landscape/portrait:	Yes	Yes	Yes	Yes	Yes	Yes
Wall distance:	31.5mm	31.5mm	31.5mm	47.5mm	56cm	56cm
Colour (VESA arms):	Black	Black	Black	Black	Black	Black
Colour (horizontal rail):	Black / Silver	Black / Silver	Black / Silver	Black / Silver	Black (Silver optional)	Black (Silver optional)
Warranty:	5 years	5 years	5 years	5 years	5 years	5 years

**MBSTH1U 400x200 Fixed**

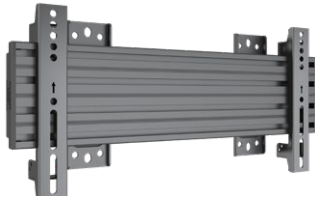

**MBSTH1U 600x200 Fixed**

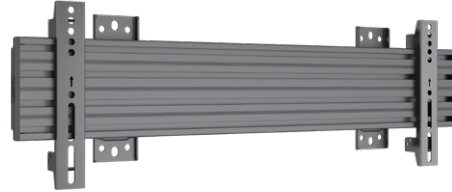

**MBW1U Fixed (48cm)**



**MBW1U Fixed (68cm)**

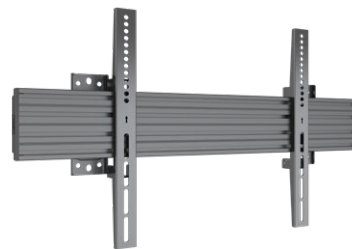

**MBW1U Tilt (48cm)**



**MBW1U Tilt (68cm)**



Model name:	MBSTH1U 400x200 Fixed	MBSTH1U 600x200 Fixed	MBW1U Fixed (48cm)	MBW1U Fixed (68cm)	MBW1U Tilt (48cm)	MBW1U Tilt (68cm)
Recommended screen size:	40"-100"	40"-100"	40" - 65"	40" - 75"	40" - 65"	40" - 75"
VESA® & non-VESA fixings:	VESA200 ,20cm	VESA200 ,20cm	VESA400 ,40cm	VESA400 ,40cm	VESA400 ,40cm	VESA400 ,40cm
EAN:	7350073737994	7350073734306	7350105214059	7350073733996	7350105214073	7350073734054
Max load:	80kg	80kg	80kg	80kg	80kg	80kg
Bracket type:	Fixed	Fixed	Fixed	Fixed	Tilt	Tilt
Landscape/portrait:	Portrait	Landscape	Yes	Yes	Yes	Yes
Wall distance:	40 cm	40 cm	40cm	40cm	56cm	56cm
Colour (VESA arms):	Black	Black	Black	Black	Black	Black
Colour (horizontal rail):	Black (Silver optional)	Black (Silver optional)	Black (Silver optional)	Black (Silver optional)	Black (Silver optional)	Black (Silver optional)
Warranty:	5 years	5 years	5 years	5 years	5 years	5 years

**MBW1U 1000 Micro Adjustable**

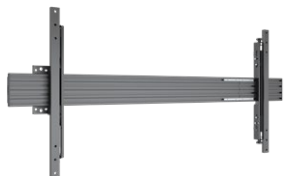

**MBW1U 1000 Fixed**

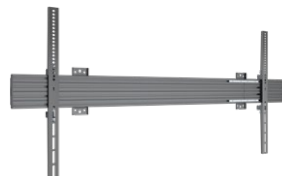

**MBW1U 1000 Tilt**

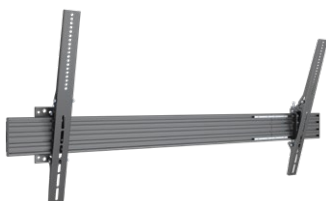

**MBW2U Tilt**



**MBW3U Tilt**



**MBW2U Fixed**

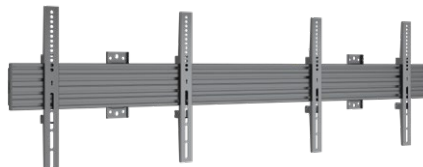

Model name:	MBW1U 1000 Micro Adjustable	MBW1U 1000 Fixed	MBW1U 1000 Tilt	MBW2U Tilt 200	MBW3U Tilt 200	MBW2U Fixed
Recommended screen size:	46"-80"	65"-120"	65"-120"	27" - 42"	27" - 42"	40" - 65"
VESA® & non-VESA fixings:	VESA600,60cm	VESA600,60cm	VESA600,60cm	VESA200,20cm	VESA200,20cm	VESA400,40cm
EAN:	7350105214943	7350105214967	7350105214950	7350073737031	7350073737048	7350073734009
Max load:	70kg	70kg	70kg	30kg (Per screen)	30kg (Per screen)	30kg (Per screen)
Bracket type:	Micro Adjustable	Fixed	Tilt	Tilt (Fixed optional)	Tilt (Fixed optional)	Fixed
Landscape/portrait:	Landscape	Landscape	Landscape	Yes	Yes	Yes
Wall distance:	58mm to 73mm	40cm	56cm	47.5mm	47.5mm	40cm
Colour (VESA arms):	Black	Black	Black	Black	Black	Black
Colour (horizontal rail):	Black (Silver optional)	Black (Silver optional)	Black (Silver optional)	Black / Silver	Black / Silver	Black (Silver optional)
Warranty:	5 years	5 years	5 years	5 years	5 years	5 years

**MBW3U Fixed**



**MBSTH1UP 200x400 Fixed**

**MBSTH1UP 200x600 Fixed**

**MBW1UP 400x900 Fixed**

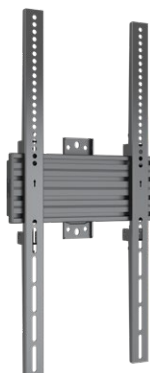
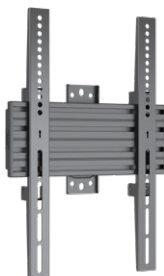

Model name:	MBW3U Fixed	MBSTH1UP 200x400 Fixed	MBSTH1UP 200x600 Fixed	MBW1UP 400x900 Fixed
Rec. screen size:	40" - 65"	40"-100"	40"-100"	40"-100"
VESA® & non-VESA fixings:	VESA400 ,40cm	VESA400 ,40cm	VESA600 ,60cm	VESA900 ,90cm
EAN:	7350073734016	7350073738007	7350073734313	7350073736942
Max load:	30kg (Per screen)	45kg	45kg	90kg
Bracket type:	Fixed	Fixed	Fixed	Fixed
Landscape/portrait:	Yes	Portrait	Yes	Yes
Wall distance:	40cm	40 cm	40 cm	40 cm
Colour (VESA arms):	Black	Black	Black	Black
Colour (horizontal rail):	Black (Silver optional)	Black (Silver optional)	Black (Silver optional)	Black (Silver optional)
Warranty:	5 years	5 years	5 years	5 years



**New!**



## Pro Series wallmounts with media storage

Multibrackets Pro Series solution for integrating a storage tray behind the display. Our M Pro Series Media Storage panel is a component storage slide out panel that facilitates easy access and

concealed mounting of AV equipment behind displays. Now AV equipment can be accessed without the need to remove the display. This will simplify accessibility and after service to the equipment by

simply slide the storage panel out. Now it's up to the installer of the decide to best position where to store AV equipment behind the display.

**MBW1U Media Storage**

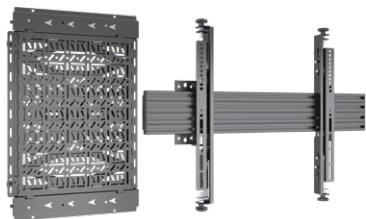

**MBW2U Media Storage**

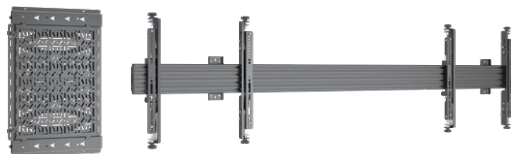

**MBW3U Media Storage**



**Media Storage Slide Panel**

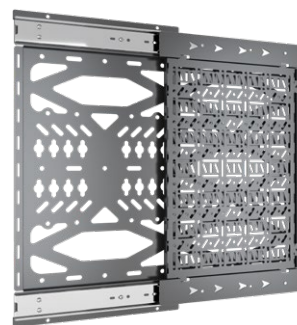

	<b>MBW1U Media Storage</b>	<b>MBW2U Media Storage</b>	<b>MBW3U Media Storage</b>	<b>Media Storage Slide Panel</b>
<b>Model name:</b>	<b>MBW1U Media Storage</b>	<b>MBW2U Media Storage</b>	<b>MBW3U Media Storage</b>	<b>Media Storage Slide Panel</b>
<b>Recommended screen size:</b>	65"-120"	46"-65"	46"-65"	---
<b>VESA® &amp; non-VESA fixings:</b>	VESA400,40cm	VESA400,40cm	VESA400,40cm	---
<b>EAN:</b>	7350105214332	7350105214349	7350105214356	7350105213847
<b>Max load:</b>	45kg	30kg (Per screen)	30kg (Per screen)	---
<b>Bracket type:</b>	Micro Adjustable	Micro Adjustable	Micro Adjustable	---
<b>Landscape/portrait:</b>	Landscape	Landscape	Landscape	Yes
<b>Wall distance:</b>	58mm to 73mm	58mm to 73mm	58mm to 73mm	---
<b>Colour (VESA arms):</b>	Black	Black	Black	Black
<b>Colour (horizontal rail):</b>	Black (Silver optional)	Black (Silver optional)	Black (Silver optional)	---
<b>Warranty:</b>	5 years	5 years	5 years	5 years



## Pro Series Wallmounts From Wall / Wall to Wall

### Inform with high visibility

In the need of solutions to mount displays in a perpendicular position to a wall? The M Pro Series From Wall and Wall to Wall models are our innovative interior designed Pro Series solutions that offers high

visibility in open areas such as hallways, concourses, aisles and office spaces. The bracket mounts vertically so that the display is presented perpendicular to walls or between two walls. The clean and simple

Scandinavian design has a durable construction and is very easy to install, a complete set of hardware is included. The M Pro Series From Wall and Wall to Wall series is a single or double sided solution.

This digital signage installation makes it easy to keep moving crowds informed and this type of fixture is an ideal way to display high visibility wayfinding or directional information in high traffic areas.







## Pro Series Collaboration Video conference

With proper videoconferencing you can expand your collaboration efforts. Use video conferencing to meet face-to-face over distance, helping to build trust and speed decision mak-

ing. You will also reduce travel costs. To be able to work from anywhere, interact with peers around the world, and attend online training sessions over video. With Multibrackets Pro

Series Collaboration solutions you will simplify video conference for your meetingrooms, offices and optimize communication with people anytime, anywhere.

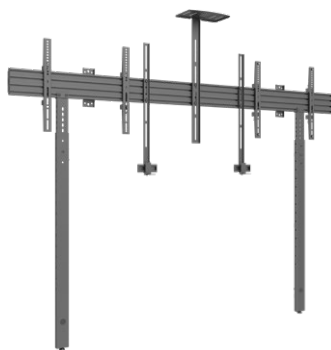

Max length 1705mm



Min length 1025mm

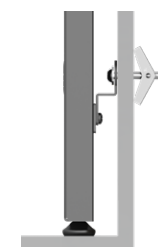

Gypsum Wall Expansion Nails

**Can be used with or without supportive legs**

**Collaboration MBW1U**



**Collaboration Side by Side 65"**



**Collaboration Side by Side 75"**

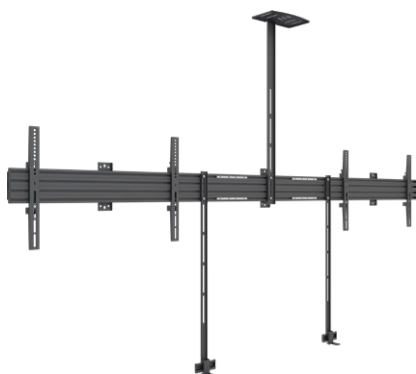

**Collaboration Side by Side 90"**

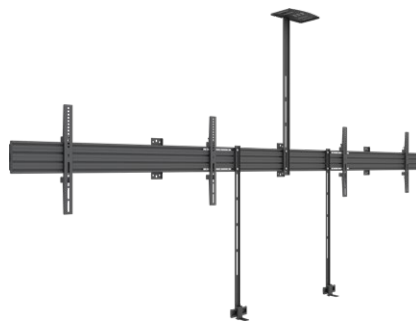

Model name:	Collaboration MBW1U	Collaboration Side by Side 65"	Collaboration Side by Side 75"	Collaboration Side by Side 90"
Recommended screen size:	32" - 75"	32" - 65"	32" - 75"	32" - 90"
VESA® & non-VESA fixings:	VESA400,40cm	VESA400,40cm	VESA400,40cm	VESA400,40cm
EAN:	7350105212840	7350073736621	7350073738915	7350073738922
Max load:	70kg	30kg (Per screen)	70kg (Per screen)	70kg (Per screen)
Bracket type:	Fixed	Fixed	Fixed	Fixed
Landscape/portrait:	Landscape	Yes	Yes	Yes
Wall distance:	40cm	40cm	40cm	40cm
Colour (VESA arms):	Black	Black	Black	Black
Colour (horizontal rail):	Black (Silver optional)	Black (Silver optional)	Black (Silver optional)	Black (Silver optional)
Warranty:	5 years	5 years	5 years	5 years

**Collaboration MBW1U with Floor support**



**Collaboration Side by Side 65" with Floor support**

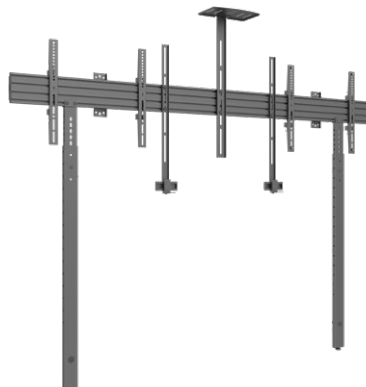

**Collaboration Side by Side 75" with Floor support**

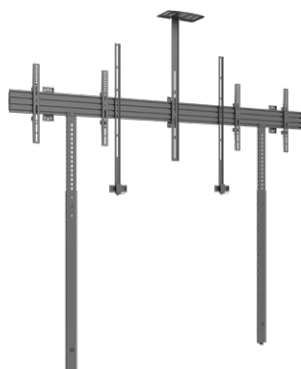

**Collaboration Side by Side 90" with Floor support**

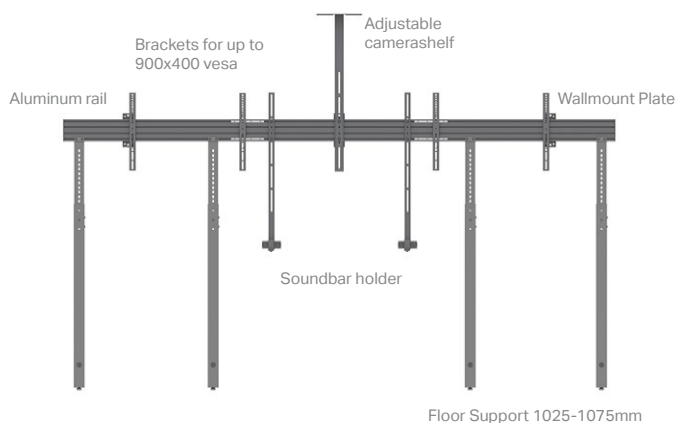

Model name:	MBW1U with Floor support	SBS 65" with Floor support	SBS 75" with Floor support	SBS 90" with Floor support
Recommended screen size:	32" - 75"	32" - 65"	32" - 75"	32" - 90"
VESA® & non-VESA fixings:	VESA400 ,40cm	VESA400 ,40cm	VESA400 ,40cm	VESA400 ,40cm
EAN:	7350105213960	7350105213977	7350105213984	7350105213991
Max load:	70kg	30kg (Per screen)	70kg (Per screen)	70kg (Per screen)
Bracket type:	Fixed	Fixed	Fixed	Fixed
Landscape/portrait:	Landscape	Yes	Yes	Yes
Floor support:	40cm	40cm	40cm	40cm
Wall distance:	1025-1705mm	1025-1705mm	1025-1705mm	1025-1705mm
Colour (VESA arms):	Black	Black	Black	Black
Colour (horizontal rail):	Black (Silver optional)	Black (Silver optional)	Black (Silver optional)	Black (Silver optional)
Warranty:	5 years	5 years	5 years	5 years

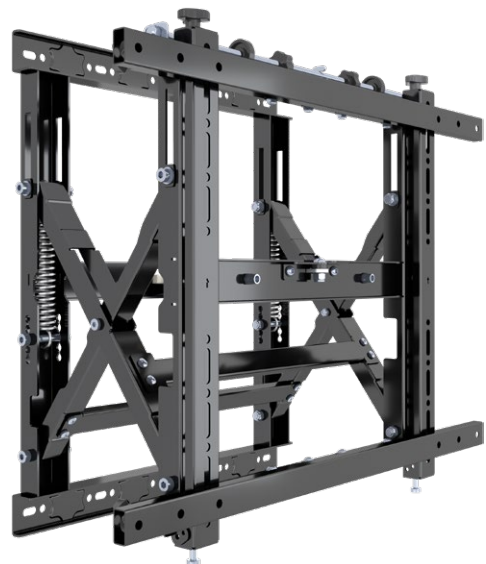

## Public video wall Mount Push HD

The M Public Video Wall Mount Push HD might just be one of the markets most innovative and easy to install video wall mounts available. With numerous post installation possibili-

ties and a tailored pantograph alignment system this might be the most easy to use, yet most powerful video wall mount system you have ever seen.

**Video Wall Mount Push HD**

**Video Wall Mount Push HD Max 90kg**

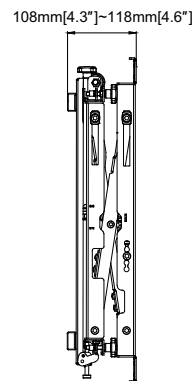
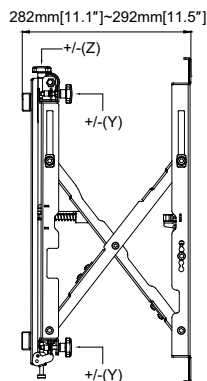
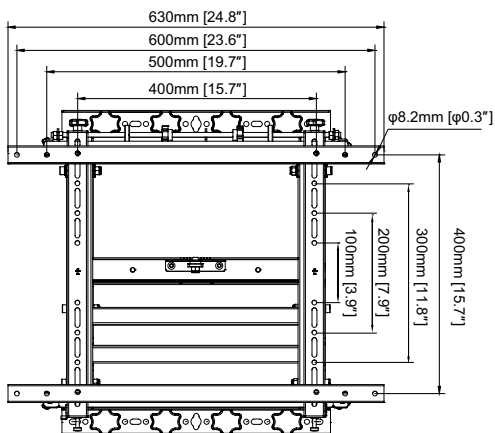
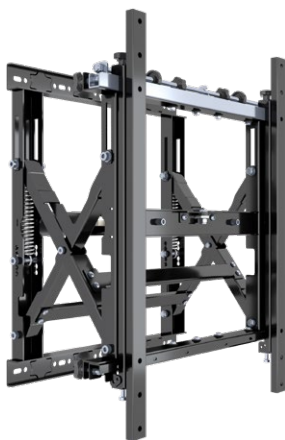

	<b>Video Wall Mount Push HD</b>	<b>Video Wall Mount Push HD Max 90kg</b>
<b>Model name:</b>	Video Wall Mount Push HD	Video Wall Mount Push HD Max 90kg
<b>Recommended screen size:</b>	43-70"	46"-110"
<b>VESA® &amp; non-VESA fixings:</b>	VESA600, 60cm	VESA900, 90cm
<b>EAN:</b>	7350073730568	7350073731749
<b>Max load:</b>	70kg	90kg
<b>Bracket type:</b>	Fixed	Fixed
<b>Landscape/portrait:</b>	Yes	Yes
<b>Wall distance:</b>	108-292mm	110-295mm
<b>Colour:</b>	Black	Black
<b>Size in mm:</b>	630x544cm	930x544cm
<b>Warranty:</b>	5 years	5 years



Made  
in EU

Hergestellt nach europäischen  
Qualitätsstandards

## No measuring, no guessing, no mistakes

# Public videowall mounts

Video walls should be easy to configure, quick to install, and easy to maintain. Introducing the Multibrackets range of full service Video Wall Mounts. Create any configuration imaginable, but leave the tedious calculations to the custom

wall plate spacers. Just install the first mount. Then use the custom wall plate spacers to perfectly place each additional mount on the wall. It couldn't be simpler.



**M Public Video Wall Mount Glide HD**



**M Public Video Wall Mount Push HD**



**Adjustment:**  
Numerous post  
installation possibilities

**M Public Video Wall Mount Push HD Max 90kg**



**M Public Video Wall Mount Push SD 150Kg Max**



**Powerful VESA Extenderkits available**  
From 600mm to 1200mm

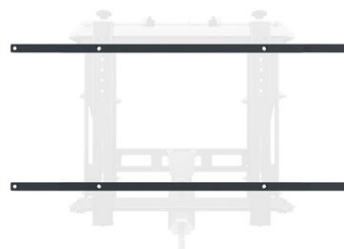

Model name:	M Public Video Wall Mount Glide HD	M Public Video Wall Mount Push HD	M Public Video Wall Mount Push HD Max 90kg	M Public Video Wall Mount Push SD 150kg Max
For screen size:	40-70"	40-70"	40-70"	50-110"
EAN:	7350073735792	7350073730568	7350073731749	7350073734818
VESA:	200x200,300x200,300x300,400x200,400x400	200x200,300x200,300x300,400x200,400x400	200x200,300x200,300x300,400x200,400x400	200x200,300x200,300x300,400x200,400x400
By adapterkit:	600x400 and 800x400	600x400 and 800x400	Up to 900x600	Up to 900x600
Size in mm:	760x460	760x460	760x460	760x460
Max load:	35kg	50kg	90kg	150kg
Weight:	12kg	12kg	14kg	14kg

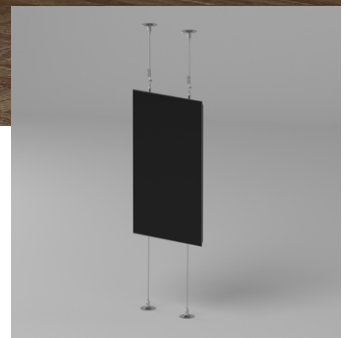

## Pro Series

# Wire combinations

### Elegant and minimal

Make a strong design statement with these spectacular wire based mounts. Now you can hang your screen in wires using the Pro Series wire based system. All parts utilized is the standard Pro Series items but

you also add the wires to hang the screen in position. Use single screen or back to back installations. Treat your clients stores to a visual make over with these elegant and minimal wire based combinations.

Designed to combine style with functionality, these displays can easily set up in most stores with a major wow factor.

- Up to 600mm height
- Back to back

**Wire 3000**



**Wire 6000**

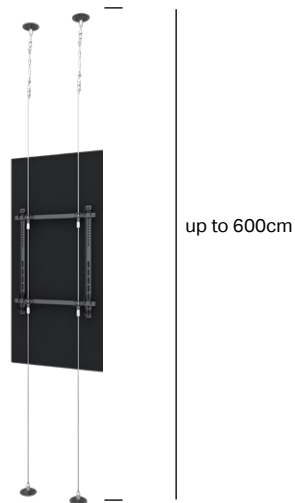

**Wire 3000 B2B**



**Wire 6000 B2B**

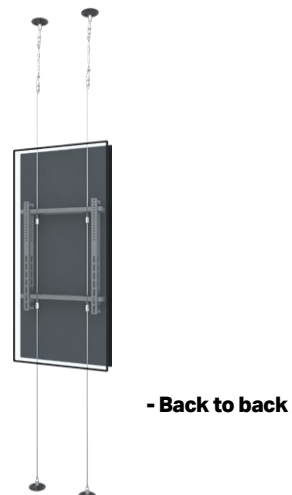

Model name:	Wire 3000	Wire 6000	Wire 3000 B2B	Wire 6000 B2B
Recommended screen size:	40"-65"	40"-65"	40"-65"	40"-65"
VESA® & non-VESA fixings:	VESA600 ,60cm	VESA600 ,60cm	VESA600 ,60cm	VESA600 ,60cm
EAN:	7350073736959	7350073736966	7350073737055	7350073737062
Max load:	30kg	30kg	30kg (Per screen)	30kg (Per screen)
Bracket type:	Fixed	Fixed	Fixed	Fixed
Landscape/portrait:	Portrait	Portrait	Portrait	Portrait
Wire length:	300cm	600cm	300cm	600cm
Colour (VESA arms):	Black	Black	Black	Black
Colour (wire):	Chrome	Chrome	Chrome	Chrome
Warranty:	5 years	5 years	5 years	5 years



## Pro Series Floorstands Single Pole

The new range of Pro Series single pole flat panel floorstands are designed to provide the ideal display viewing placement and match the décor of any environment. Ideal for public areas like stores, training rooms, lobbies, classrooms,

auditoriums, or exhibition halls. As with all Pro series products a full line-up of accessories offering tailor possibilities functionality to meet your specific requirements. Internal cable management hides the AV cabling, showing a clean look.







**Single Pole Floormount**

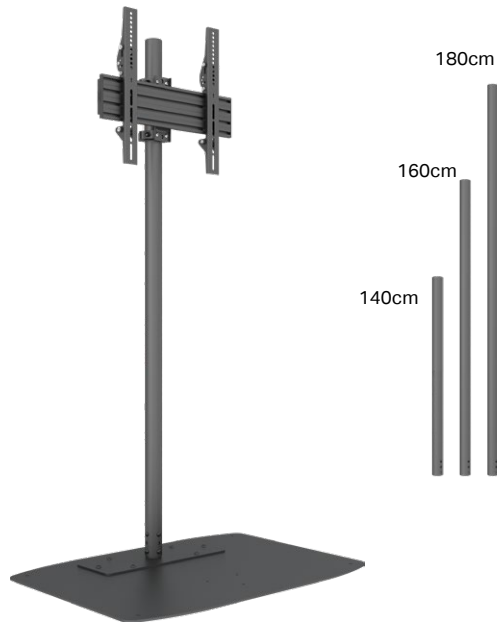

**Single Pole Floorbase**



**Colors:**

-  Black
-  Chrome
-  White
-  Brass
-  Tailored

	<b>M Single Pole Floormount Pro 32"-65"</b>	<b>M Single Pole Floorbase Pro 32"-65"</b>
<b>EAN:</b>	Black: 7350073738939	Black: 7350073738946
<b>Color:</b>	Black	Black
<b>Optional colour:</b>	Chrome, White, Brass, Tailored	Chrome, White, Brass, Tailored
<b>Color:</b>	Black / Chrome / White	Black / Chrome / White
<b>For screen size:</b>	32"-65"	Steel, Aluminium, Plastic
<b>Universal &amp; VESA standard:</b>	100x100 200x200 300x300 400x400	100x100 200x200 300x300 400x400
<b>Material:</b>	Steel, Aluminium, Plastic	Steel, Aluminium, Plastic
<b>Surface Finish:</b>	Powder coating	Powder coating
<b>Weight:</b>	11 kg	25 kg 11 kg
<b>Measurements</b>	160*18*15 cm	90x62x4 & 160x18x15 cm
<b>Max Load:</b>	50 kg per screen	50 kg per screen
<b>Height:</b>	10 mm height adjustment	10 mm height adjustment
<b>Tilt:</b>	-6°~+15°	-6°~+15°
<b>Warranty:</b>	5 years	5 years



## Pro Series Floorstands Dual Pole

The Dual Pole range of Pro Series floorstands designed to support one or two large size screens mounted back-to-back in either landscape or portrait. Simple to install, clean and attractive design, yet very robust and functional the Dual Pole series is ideal for a wide variety of applications and settings. Designed to provide the ideal display viewing placement and match the décor of any environ-

ment. Ideal for public areas like stores, training rooms, lobbies, classrooms, auditoriums, or exhibition halls. As with all Pro series products a full line-up of accessories offering tailor possibilities functionality to meet your specific requirements. Internal cable management hides the AV cabling, showing a clean look.



**M Dual Pole Floormount Pro 65"-90"**

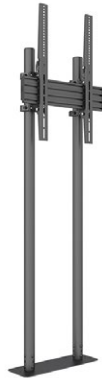

**M Dual Pole Floorbase Pro 65"-90"**



**M Dual Pole Floormount Pro B2B 65"-90"**



**M Dual Pole Floorbase Pro B2B 65"-90"**



	<b>M Dual Pole Floormount Pro</b>	<b>M Dual Pole Floorbase Pro</b>	<b>M Dual Pole Floormount Pro B2B</b>	<b>M Dual Pole Floorbase Pro B2B</b>
<b>EAN:</b>	7350073738953	7350073738960	7350073738977	7350073738984
<b>Color:</b>	Black	Black	Black	Black
<b>Optional colour:</b>	Chrome, White, Brass, Tailored	Chrome, White, Brass, Tailored	Chrome, White, Brass, Tailored	Chrome, White, Brass, Tailored
<b>For screen size:</b>	65"-90"	65"-90"	65"-90"	65"-90"
<b>Universal &amp; VESA standard:</b>	100x100 200x200 300x300 400x400 400x600	100x100 200x200 300x300 400x400 400x600	100x100 200x200 300x300 400x400 400x600	100x100 200x200 300x300 400x400 400x600
<b>Material:</b>	Steel, Aluminium, Plastic	Steel, Aluminium, Plastic	Steel, Aluminium, Plastic	Steel, Aluminium, Plastic
<b>Surface Finish:</b>	Powder coating	Powder coating	Powder coating	Powder coating
<b>Weight:</b>	15.7 kg	15.7 kg & 25 kg	21 kg	21KG&25 kg
<b>Measurements</b>	160*18*15 cm	160*18*15 & 90*62*4 cm	160*18*15 cm	160*18*15 & 90*62*4 cm
<b>Max Load:</b>	75 kg per screen	75 kg per screen	75 kg per screen	75 kg per screen
<b>Height:</b>	10 mm height adjustment	10 mm height adjustment	10 mm height adjustment	10 mm height adjustment
<b>Tilt:</b>	-6°~+15°	-6°~+15°	-6°~+15°	-6°~+15°
<b>Warranty:</b>	5 years	5 years	5 years	5 years



**New!**

**Pro Series**

# Floorstands

**Triple & Quad**

With the unique modular set up the Pro Series range of floorstand´s designed to support one, two, three or more screens mounted in most ways imaginable in either landscape or portrait. Simple to install, clean and attractive design, yet very robust and functional the Dual Pole series is ideal for a wide variety of applications and settings. Designed to provide the ideal display viewing placement

and match the décor of any environment. Ideal for public areas like stores, training rooms, lobbies, classrooms, auditoriums, or exhibition halls. As with all Pro series products a full line-up of accessories offering tailor possibilities functionality to meet your specific requirements. Internal cable management hides the AV cabling, showing a clean look.





**Triple Pro MBF3U**

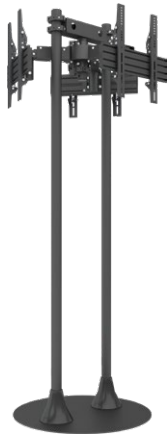

**Triple Pro AddOn MBF3U**



**Quad Pro MBF4U**

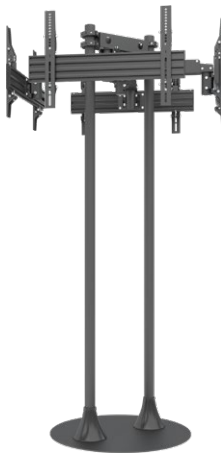

**Quad Pro AddOn MBF4U**

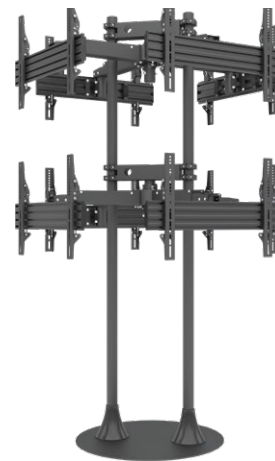

	<b>Triple Pro MBF3U</b>	<b>Triple Pro AddOn MBF3U</b>	<b>Quad Pro MBF4U</b>	<b>Quad Pro AddOn MBF4U</b>
<b>Model name:</b>	Triple Pro MBF3U	Triple Pro AddOn MBF3U	Quad Pro MBF4U	Quad Pro AddOn MBF4U
<b>Recommended screen size:</b>	32"-65"	32"-65"	32"-65"	32"-65"
<b>VESA® &amp; non-VESA fixings:</b>	VESA400 ,40cm	VESA400 ,40cm	VESA400 ,40cm	VESA400 ,40cm
<b>EAN:</b>	7350073737697	7350073737703	7350073737710	7350073737727
<b>Max load:</b>	30kg Per screen	30kg Per screen	30kg Per screen	30kg Per screen
<b>Bracket type:</b>	Tilt	Tilt	Tilt	Tilt
<b>Landscape/portrait:</b>	Yes	Landscape	Yes	Landscape
<b>Pole height (cm):</b>	200cm	200cm	200cm	200cm
<b>Colour (VESA arms):</b>	Black	Black	Black	Black
<b>Optional colour:</b>	Chrome, White, Brass, Tailored	Chrome, White, Brass, Tailored	Chrome, White, Brass, Tailored	Chrome, White, Brass, Tailored
<b>Warranty:</b>	5 years	5 years	5 years	5 years
<b>Accessories:</b>	Cover plate	Cover plate	Cover plate	Cover plate

New!

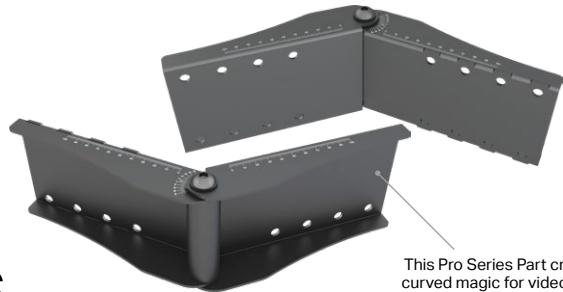
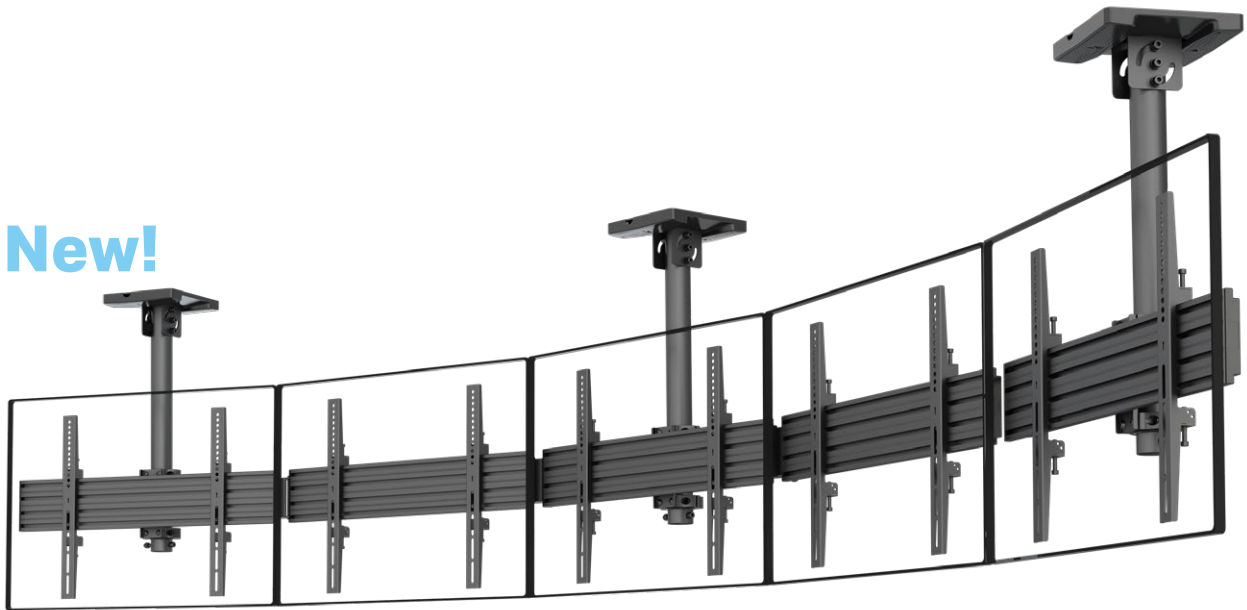

This Pro Series Part creates curved magic for videowalls.

# Pro Series Curved solutions

## Create tailored installations with Pro Series

Create tailored installations with the possibility to mix both computer displays with digital signage displays. The M Pro Series Pole line of brackets offers a variety of flexible solutions with tilt and turn

possibilities. Start utilizing our clean and simple Scandinavian designed brackets with durable construction and easy installation. A complete set of hardware is always included.

### Highlights:

- Works with most screens the market has to offer
- Fast & accurate assembly & installation
- Simple access & quick rear service

#### Curved screen rail joiner

EAN: 7350073736348

Turn: -45° ~ +45°

Distance adj.: 0 ~ 200 mm

## Popular models:



Ceiling mount

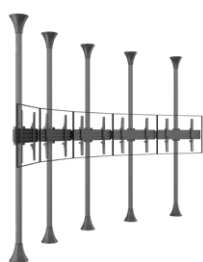

Floor to ceiling

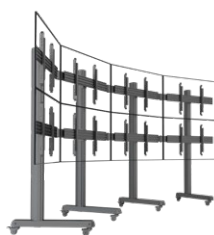

Wheelbase

**Multibrackets Pro Series™ - Video Wall Mounting System**

# Freestanding video walls

## Construct video walls in prominent locations

Pro Series Video Wall Mounting Systems handles both landscape or portrait arrangements of displays to fit any application. There are multiple screen array configurations possible, and its flexible just build and add after time or as your needs change. Most displays between 32" to 65" can be used. Set the height based on the 180/270/300cm

high columns made out of highest-grade aluminum. Its easy to change height and it is possible to set or reset height to provide a great viewing angle for both a sitting and a standing audiences. A movable wheelbase or floor based directly on the ground makes these video walls optimal for presentations, trade shows, stores or office entrances.

This is a perfect solution for customers who need a mobile or stationary presentation system for VTC, digital signage applications, and more. With the right combination of durability and serviceability, these videowalls provide a standardized and cost-efficient solution designed to fit most applications or environments.

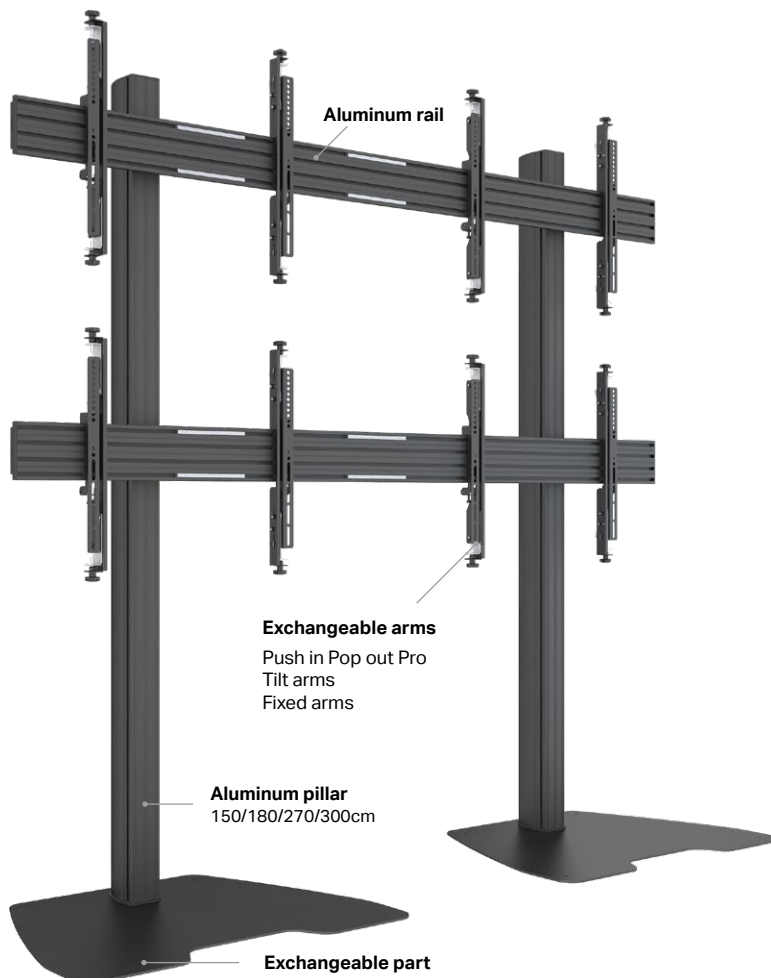

## Flexible & robust

Add or delete displays anytime or per occasion. M Pro Series freestanding videowalls allows videowall to be moved into any application. The high quality construction makes the line perfect for rental or short term pop up installations. Create a permanent bolt down solution when a wall isn't available. Possibility to align displays with independent height, depth and lateral shift adjustments.

**Highlights:**

- **Floorbase, floormount or wheelbase**
- **Permanent bolt-down possible**
- **Integrated cable management**
- **Change design after new needs occur**

# Pro Series Floorstands Free standing

## Create your own video wall and interact with the consumer

Multibrackets takes video wall carts to a new level. Designed with the unique Pro Series modularity, any video wall cart configuration allows the user to create a flawless video walls with a wide variety of screens. These Video Wall Carts offers an multiple-point micro-adjustment arms to create a seamless

alignment without the need of tools. With lockable casters, the cart becomes secure for safe and easy movement over various flooring surfaces. Designed for a quick set-up and tear down. Built in cable management creates a sleek appearance for any application.

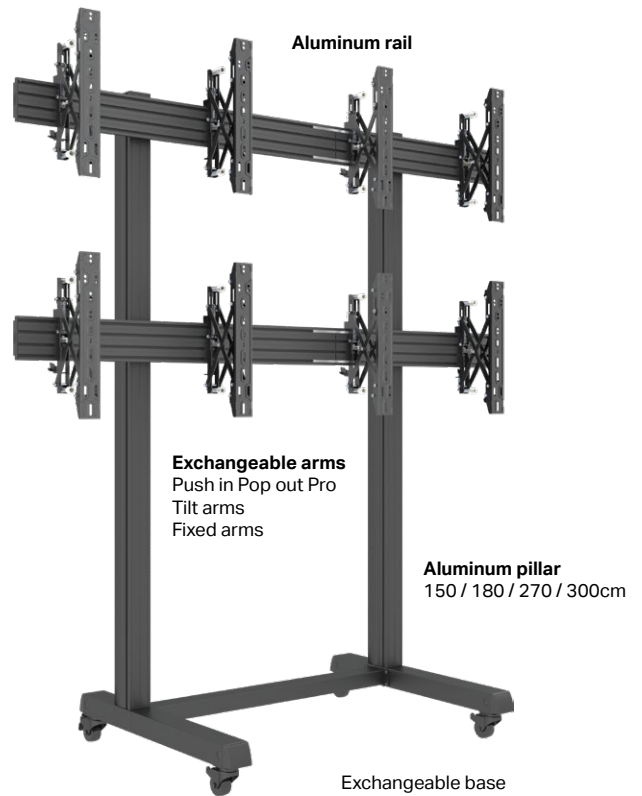

### M Pro Series Video Wall Stand



2x2



3x2

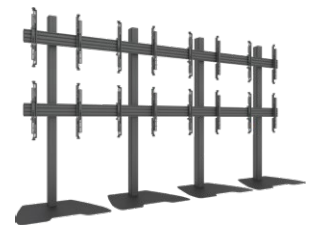

4x2



3x3

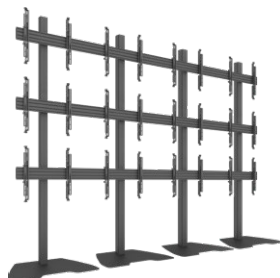

4x3

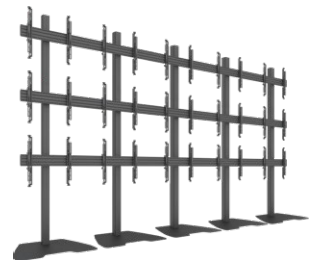

5x3

M Pro Series Floormount Column



**2x2**

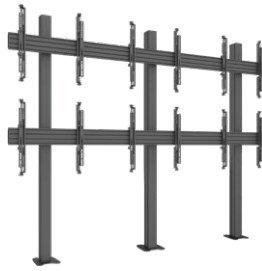

**3x2**

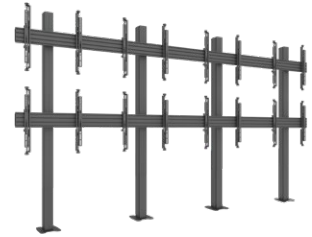

**4x2**



**3x3**

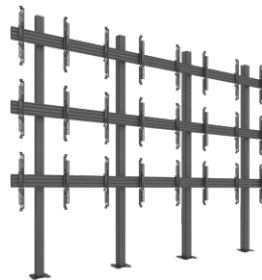

**4x3**

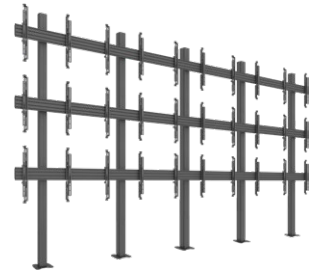

**5x3**

M Pro Series Video Wall



**2x2**



**3x2**



**4x2**



**3x3**



**4x3**

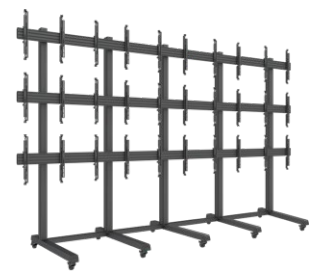

**5x3**

**MBFC1U 150cm**

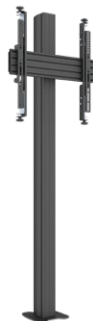

**MBFC1U 180cm**

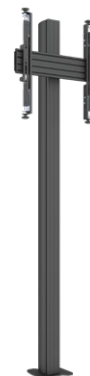

**MBFC1U 270cm**

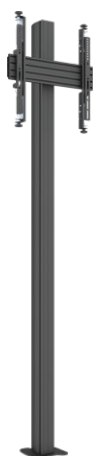

**MBFMC3x1U**



	<b>MBFC1U 150cm</b>	<b>MBFC1U 180cm</b>	<b>MBFC1U 270cm</b>	<b>MBFMC3x1U</b>
<b>Model name:</b>	<b>MBFC1U 150cm</b>	<b>MBFC1U 180cm</b>	<b>MBFC1U 270cm</b>	<b>MBFMC3x1U</b>
<b>Recommended screen size:</b>	43" - 50"	43" - 65"	43" - 65"	43" - 65"
<b>VESA® &amp; non-VESA fixings:</b>	VESA400 ,40cm	VESA400 ,40cm	VESA400 ,40cm	VESA400 ,40cm
<b>EAN:</b>	7350105210280	7350105210297	7350105210303	7350105214622
<b>Max load:</b>	30kg (Per screen)	30kg (Per screen)	30kg (Per screen)	30kg (Per screen)
<b>Bracket type:</b>	Micro Adjustable	Micro Adjustable	Micro Adjustable	Micro Adjustable
<b>Landscape/portrait:</b>	Yes	Yes	Yes	Yes
<b>Pillar length:</b>	150 cm	180 cm	270 cm	180/270cm
<b>Colour (VESA arms):</b>	Black	Black	Black	Black
<b>Colour (horizontal rail):</b>	Black (Silver optional)	Black (Silver optional)	Black (Silver optional)	Black (Silver optional)
<b>Colour (pillar):</b>	Black	Black	Black	Black
<b>Warranty:</b>	5 years	5 years	5 years	5 years

**MBFC2U 180cm**



**MBFC2U 270cm**



**MBFC3U 270cm**



**MBFMC3x3U**

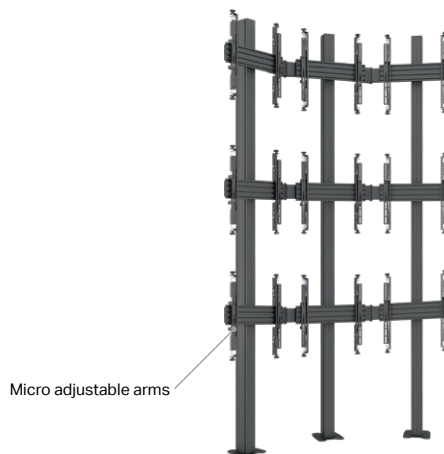

	<b>MBC2U 180cm</b>	<b>MBC2U 270cm</b>	<b>MBC3U 270cm</b>	<b>MBFMC3x3U</b>
<b>Model name:</b>	<b>MBC2U 180cm</b>	<b>MBC2U 270cm</b>	<b>MBC3U 270cm</b>	<b>MBFMC3x3U</b>
<b>Recommended screen size:</b>	43" - 65"	43" - 65"	43" - 65"	43" - 65"
<b>VESA® &amp; non-VESA fixings:</b>	VESA400 ,40cm	VESA400 ,40cm	VESA400 ,40cm	VESA400 ,40cm
<b>EAN:</b>	7350105210310	7350105210327	7350105210334	7350105214646
<b>Max load:</b>	30kg (Per screen)	30kg (Per screen)	30kg (Per screen)	30kg (Per screen)
<b>Bracket type:</b>	Micro Adjustable	Micro Adjustable	Micro Adjustable	Micro Adjustable
<b>Landscape/portrait:</b>	Landscape	Landscape	Landscape	Landscape
<b>Pillar length:</b>	Landscape / Portrait	80 cm up to 150 cm	80 cm up to 150 cm	80 cm up to 150 cm
<b>Colour (VESA arms):</b>	Black	Black	Black	Black
<b>Colour (horizontal rail):</b>	Black (Silver optional)	Black (Silver optional)	Black (Silver optional)	Black (Silver optional)
<b>Colour (pillar):</b>	Black	Black	Black	Black
<b>Warranty:</b>	5 years	5 years	5 years	5 years

**MBFMC3x1U**



**MBFMC3x2U**

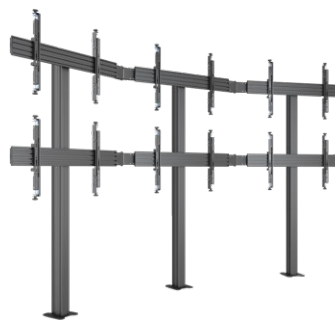

**MBFMC3x3U**

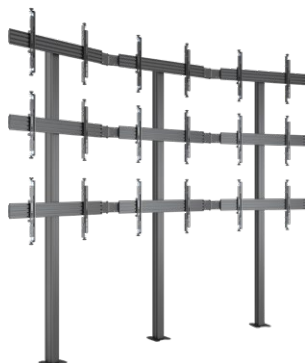

**MBFMC6x3U**



	<b>MBFMC3x1U</b>	<b>MBFMC3x2U</b>	<b>MBFMC3x3U</b>	<b>MBFMC6x3U</b>
<b>Model name:</b>	MBFMC3x1U	MBFMC3x2U	MBFMC3x3U	MBFMC6x3U
<b>Recommended screen size:</b>	43" - 65"	43" - 65"	43" - 65"	43" - 65"
<b>VESA® &amp; non-VESA fixings:</b>	VESA400 ,40cm	VESA400 ,40cm	VESA400 ,40cm	VESA400 ,40cm
<b>EAN:</b>	7350105214622	7350105214639	7350105214646	7350105214653
<b>Max load:</b>	30kg (Per screen)	30kg (Per screen)	30kg (Per screen)	30kg (Per screen)
<b>Bracket type:</b>	Micro Adjustable	Micro Adjustable	Micro Adjustable	Micro Adjustable
<b>Landscape/portrait:</b>	Landscape	Landscape	Landscape	Landscape
<b>Pillar length:</b>	80 cm up to 150 cm	80 cm up to 150 cm	80 cm up to 150 cm	80 cm up to 150 cm
<b>Colour (VESA arms):</b>	Black	Black	Black	Black
<b>Colour (horizontal rail):</b>	Black (Silver optional)	Black (Silver optional)	Black (Silver optional)	Black (Silver optional)
<b>Colour (pillar):</b>	Black	Black	Black	Black
<b>Warranty:</b>	5 years	5 years	5 years	5 years



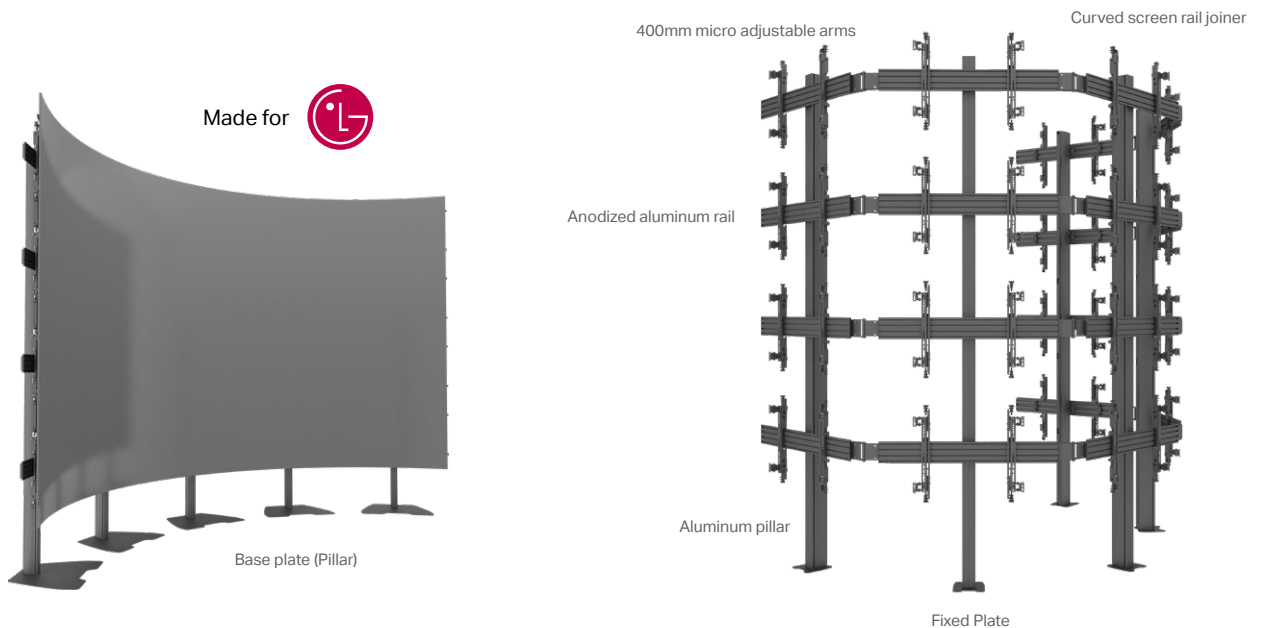



## Pro Series

# Communication Stations

### M Floorstand Pro MBF1U 150 & MBF1U 180

Introducing the M Floorstand Pro MBF1U 150 a flat panel TV cart that was designed to include all of the features you may need, making it perfect for any application. Mobility, appealing design, display height adjustment, pre-assembled base and safety certifications ensure quick assembly while providing a ridged, but attractive and structured that fits into any decor.



#### Highlights:

- Mobile and ultra flexible
- Integrated cable management
- All parts provides rigidity, stability and quick assembly
- Textured black powder coat finish
- Universal and extendable mounting up to VESA 1000x900mm
- If your needs change reconfigure your floorstand
- 5-year warranty

# All modular

Configure or reconfigure after your current or future needs.  
Our Pro Series Floorstands can change with you as your needs change.

## Example configurations

**MBF1U without shelf**

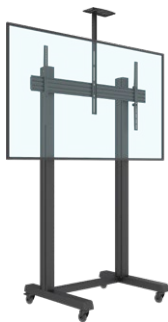

**MBF1U with soundbar mount**

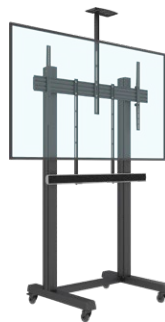

**MBFSC-Single**



**MBFSC 150cm**



**MBFSC 180cm**

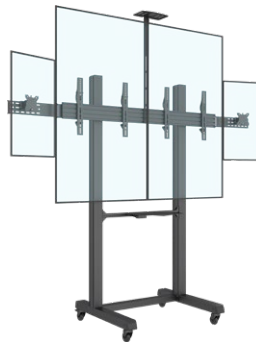

Model name:	MBF1U without shelf	MBF1U with soundbar mount	MBFSC-Single	MBFSC 150cm	MBFSC 180cm
Recommended screen size:	48" - 55", 24" - 27"	75"~100"	55" - 65", 27" - 32"	48" - 55", 24" - 27"	55" - 65", 27" - 32"
VESA® & non-VESA fixings:	1000x600mm	1000x600mm	100x100-400x400, 75x75-100x100mm	100x100-400x400, 75x75-100x100mm	100x100-400x400, 75x75-100x100mm
EAN:	---	---	---	---	---
Max load:	90kg	90kg	45kg, 8kg	45kg, 8kg (Per screen)	45kg, 15kg (Per screen)
Bracket type:	Fixed	Fixed	Tilt	Tilt	Tilt
Landscape/portrait:	Yes	Yes			Yes
Pillar length:	150/180cm	150/180cm	150cm	150cm	180cm
Colour (VESA arms):	Black	Black	Black	Black	Black
Colour (horizontal rail):	Black	Black	Black	Black	Black
Colour (pillar & legs):	Black	Black	Black	Black	Black
Warranty:	5 years	5 years	5 years	5 years	5 years



Customized for:



**New!**

# Pro Series Floorstands Monitors

Multibrackets Pro Series M Floorstand mount for LED display, steel, 1m height, 1 screens, VESA 75x75, 100x100, screen size: 7"-30". The new professional Pro Series A/V line from Multibrackets was designed with the installer in mind. Modular, easy to

configure, quick to install, and simple to maintain. Working closely with installers we created a range with close to unlimited flexibility. This model the M Floorstand Pro is no exception. The product provides the versatility and flexibility demanded by installers.



M Pro Series Single Pole Floorbase



M Pro Series Single Pole Floorbase B2B



Kiosk Black 15"-32"

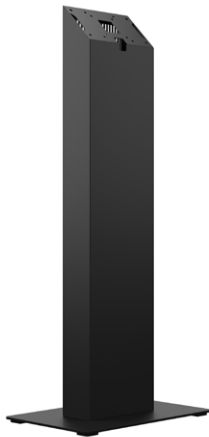

Kiosk White 15"-32"

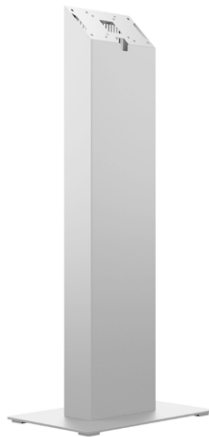

Kiosk VESA adapter



Model name:	M Pro Series Single Pole Floorbase	M Pro Series Single Pole Floorbase B2B	M Pro Series Kiosk Black 15"-32"	M Pro Series Kiosk White 15"-32"	M Pro Series Kiosk VESA adapter
Recommended screen size:	10"-30"	10"-30"	15"-32"	15"-32"	15"-32"
VESA® & non-VESA fixings:	75x75, 100x100cm	75x75, 100x100cm	75x75, 100x100, 200x100	75x75, 100x100, 200x100	200x200, 300x300, 400x400
EAN:	7350105210549	7350105213069	7350105215179	7350105215186	735010521593
Max load:	10 kg	10 kg/screen	20 kg	20 kg	20 kg
Bracket type:	Tilt	Tilt	Fixed	Fixed	Fixed
Floormount:	Yes	Yes	Yes	Yes	-
Floorstand:	Yes (floorbase included)	Yes (floorbase included)	Yes (floorbase included)	Yes (floorbase included)	-
Landscape/portrait:	Yes	Yes	Yes	Yes	Yes
Pole height (cm):	1000mm	1000mm	450x300x1045mm	450x300x1045mm	-
Colour:	Black	Black	Black	White	Black
Warranty:	5 years	5 years	5 years	5 years	5 years

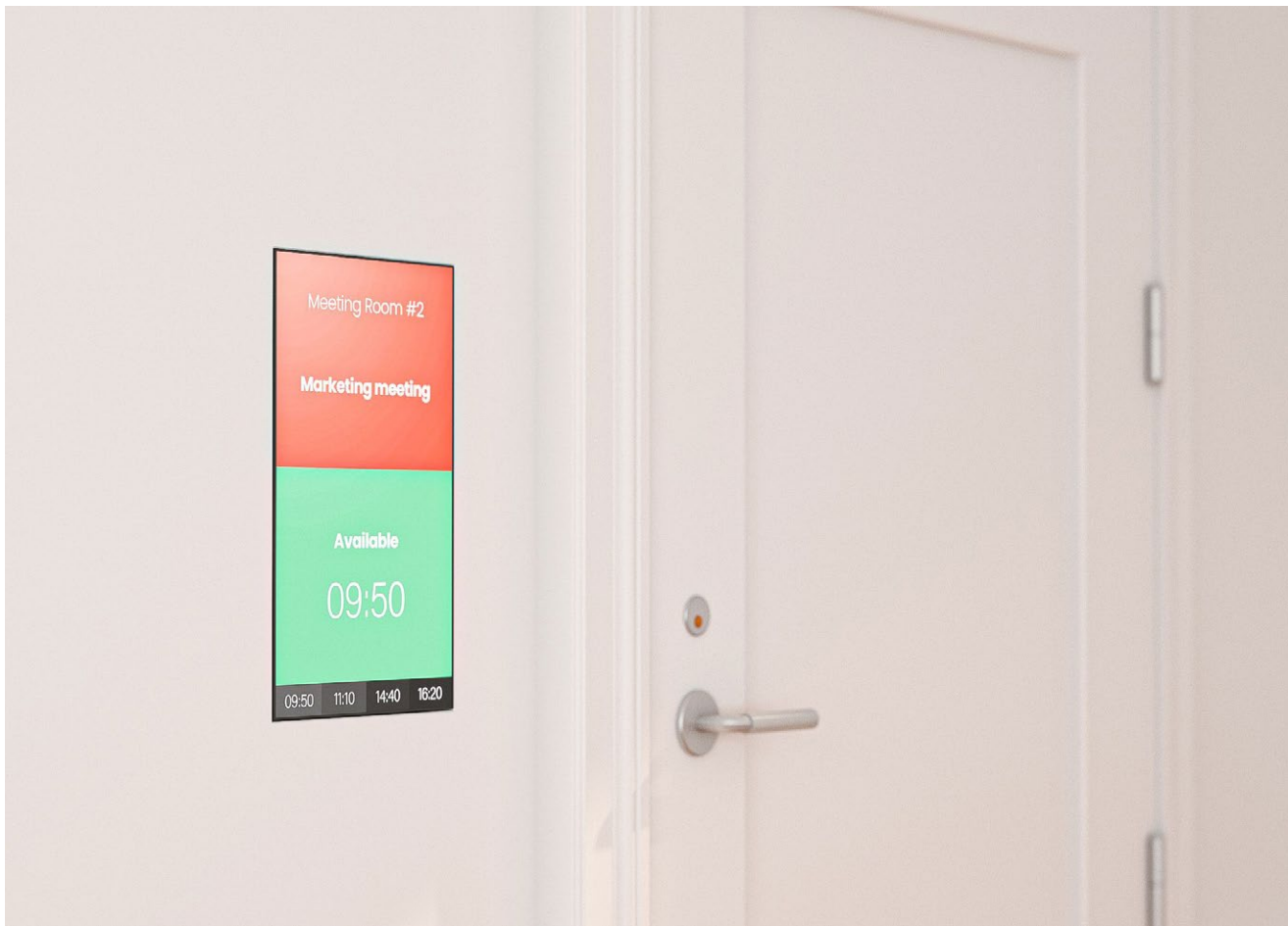

## Pro Series 10"-24" enclosures

**Simplify small size signage installations with a thin and easy-to-install enclosure.**

Experience the elegance of Multibrackets new indoor enclosures designed to support the latest LED displays. With an ingenious design these enclosures have a wide range of applications making them easy to install and maintain.

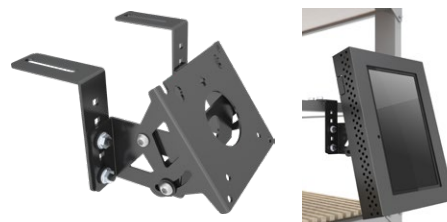

### M Pro Series Shelf Mount 75x75 100x100

<b>EAN:</b>	7350073739417
<b>VESA standard:</b>	75x75, 100x100mm
<b>Tilt:</b>	45°
<b>Weight:</b>	2kg
<b>Max Load:</b>	10 kg
<b>Measurements:</b>	17.5x13.4x14.6cm
<b>Material:</b>	Steel
<b>Surface Finish:</b>	Powder coating
<b>Colour:</b>	Black
<b>Warranty:</b>	5 years

### M Pro Series

## Shelf Mount 75x75 100x100

Spur customer engagement and stimulate extra purchases. Spotlight your merchandise, both in-store and in-storefront, to capture customers' attention. Create a signage installation on shelves and other areas

where a 10" or 13" display does the job. Mount the display via the standard VESA 75 or 100 mounting pattern or use an enclosure and mount the screen on or under the shelf.

M Pro Series Enclosure ELO 10"



elo

M Pro Series Enclosure Cisco Touch 10" White

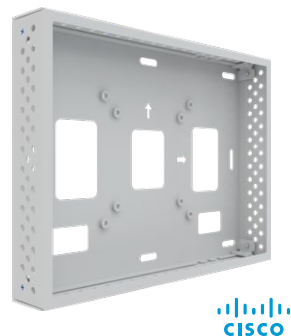

cisco

M Pro Series Enclosure QB13R & QB13R-T

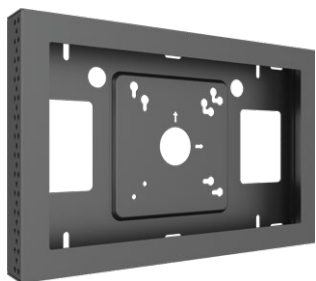

- Black
- White

SAMSUNG

M Pro Series Enclosure LG22SM3G

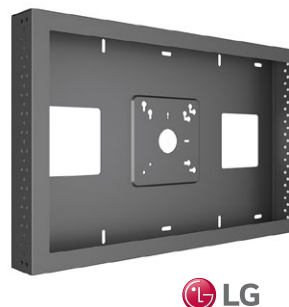

- Black
- White

LG

M Pro Series Enclosure QB24R & QB24R-T

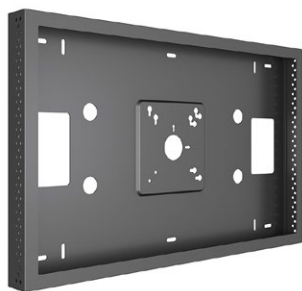

- Black
- White

SAMSUNG

Anti theft



	M Pro Series Enclosure ELO 10"	M Pro Series Enclosure Cisco Touch 10"	M Pro Series Enclosure QB13R & QB13R-T	M Pro Series Enclosure LG22SM3G	M Pro Series Enclosure QB24R & QB24R-T
<b>EAN:</b>	7350073739400	7350105210488	Black: 7350073738519 White: 7350073738908	Black: 7350105211041 White: 7350105211058	Black: 7350105211386 White: 7350105211393
<b>VESA standard:</b>	75x75 mm	100x100mm	100x100mm	100x100 mm	100x100 mm
<b>Installation:</b>	ELO 10" screen	Cisco CTS-CTRL-DV10	Samsung QB13R & QB13R-T	LG 22" 22SM3G	Samsung QB24R or QB24R-T
<b>Weight:</b>	2.0 kg	0.9kg	2kg	3,2 kg	3,5 kg
<b>Max Load:</b>	5 kg	5 kg	10 kg	10 kg	10 kg
<b>Measurements:</b>	320x242x52 mm	30.1x23.2x5cm	39.2x26.2x5cm	590 x 380 x 65 mm	615 x 385 x 48 mm
<b>Material:</b>	Steel	Steel	Steel	Steel	Steel
<b>Surface Finish:</b>	Powder coating	Powder coating	Powder coating	Powder coating	Powder coating
<b>Colour:</b>	Black	White	Black / White	Black / White	Black / White
<b>Warranty:</b>	5 years	5 years	5 years	5 years	5 years



# M Pro Series Enclosures









## Pro Series Enclosures

Wallmounts / Ceiling mounts / Floor to ceiling / Wire / Floorstands & mounts



### A selection of our enclosures and totems

Create a minimalistic look and choose to mount in both Portrait or Landscape position. Multibrackets® enclosures are one of the most versatile to date. Choose between screen sizes and colors. These enclosures include after adjustment possibilities and can be used for most brands of signage displays on the market. With a

smart thermal management, this solution can fit more brands as well as creating thermal management second to none. These clean styled black Pro Series Enclosures brings new flexibility to the digital signage enclosure market while maintaining a sleek aesthetic to complement a variety of environments. A depth

adjustable exterior frame allows for a variety of displays to be used. Reversible hinges help avoid installation and service obstructions, and the exclusive design. Unparalleled service and maintenance access. Integrated passive cooling vents with active thermal management options. Tamperproof security

hardware protects technology investments. Blends in perfectly in most environments. Added its ingenious design makes many smart options available right away or after time, mounting solutions with wire function, floor to ceiling or floor stand and ceiling mounting is available.

## B2B Enclosures

Ceiling mounts / Floor mounts / Floor to ceiling

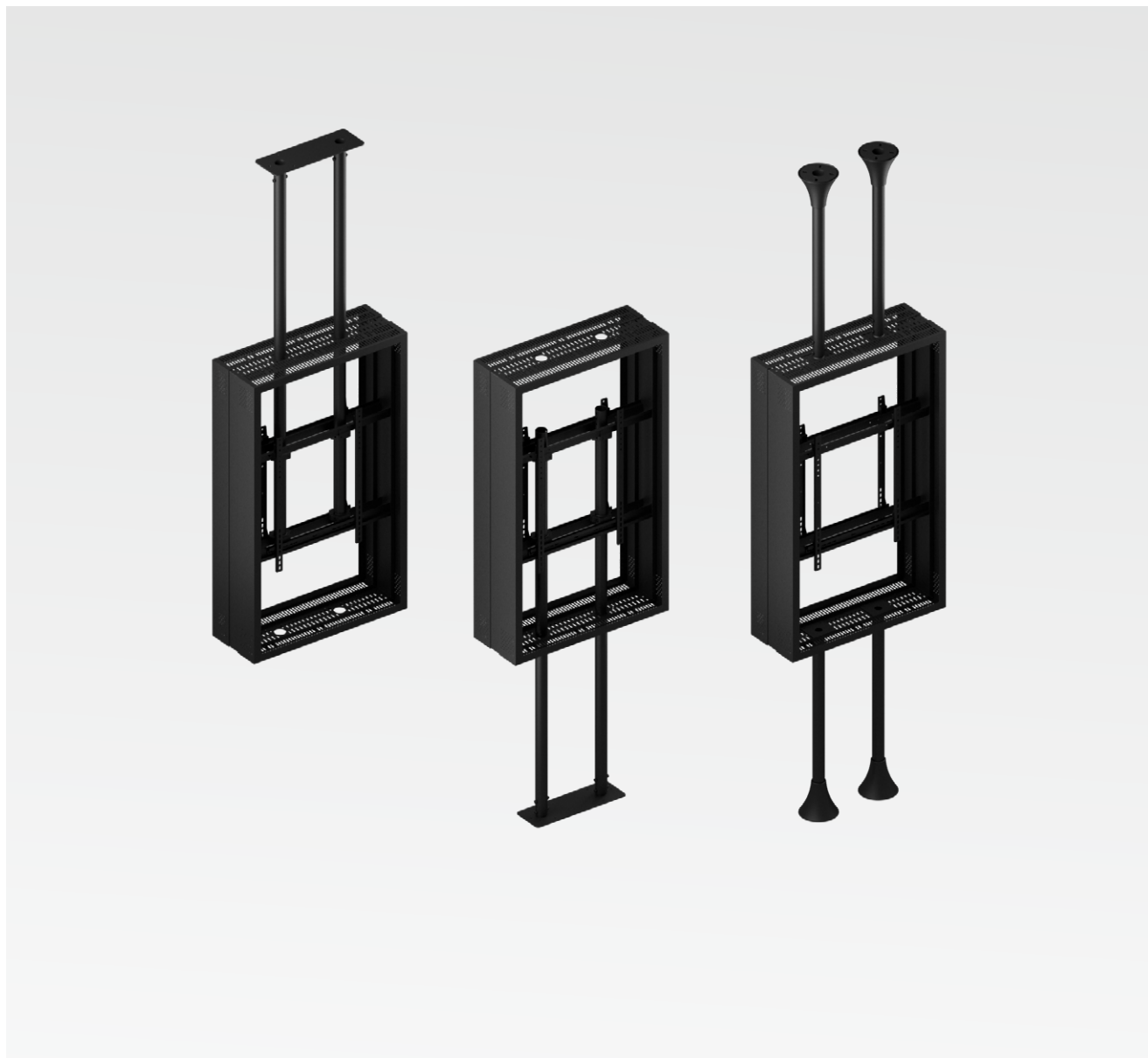

M U L T I B R A C K E T S

### Pro Series Back to Back Enclosures

Ideal for retail and quick service restaurants, Multibrackets floor-to-ceiling wire mount system is a sleek solution that maximizes aesthetics while minimizing footprint. The MBFCW2U+ supports both portrait and landscape orientations, with the option to add a back-to-back displays. Wire floor to ceiling range is 6 meters. Designed to

make a sleek and well-designed almost invisible impression this mount allows companies to create a platform for eye catching content delivery. Still this wire based system is both discreet but powerful. Coming from the Pro Series range these wire based products are installer friendly. This mount is suspend-

ed on high tensile steel wire, which is a highly secure and stable foundation for displays up to 65" (max weight 25kg). There is the ability to position the screen at any point along the cable length, plus the choice of having the display in either landscape or portrait position Our M Pro Series Wire based system

will make an incredibly versatile solution that can be adapted to suit a wide range of both retail and commercial applications.



# Pro Series LED solutions

## Supporting all major brands and mounting solutions

### Inspired by AV installers

Multibrackets is committed to respond to industry needs. In cooperation with installers and display makers Multibrackets offers a complete line of Pro Series LED mounting solutions. Innovative features and recognized for delivering quality products that are both easy

to install and maintain, all at a fair TCO. With decades of audio-visual experience, our commitment to the create cutting-edge technology and Pro Series solutions has elevated us to become one of the industry's most innovative AV mounts manufacturer. Our Pro

Series LED solutions focus on high quality design, aesthetic results all at a good economy. Our team of LED professionals include everything from mechanical engineers to project managers, all working in close cooperation with our partners and their installers.

### Highlights:

- . Simple installation
- . Cable management
- . Lightweight aluminum
- . Seamless result

### Exclusive LED design for:

**SAMSUNG**

**LG**

**PHILIPS**



# SAMSUNG

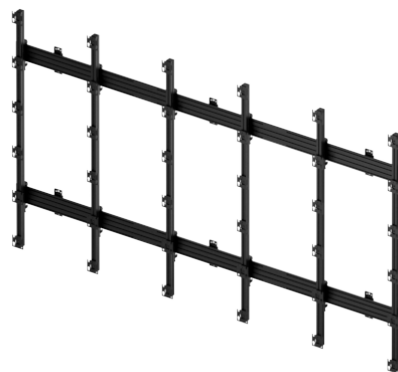

Image courtesy of Samsung Corp

## M Pro Series LED Customized for SAMSUNG

### IER / IEA / IFR Series

Samsung, the largest in the display industry, is a self-described manufacturer of LED Signage built for businesses. With Samsung, you can find the perfect display solution for all businesses. Capture everyone's attention with stunning images from LED Signage.



M Pro Series LED:	SAMSUNG - IER	SAMSUNG - IEA	SAMSUNG - IFR
Non Vesa Fixing:	Tailor made	Tailor made	Tailor made
EAN:	TBD	TBD	TBD
Max Load:	Tailor made for SAMSUNG IER/IEA/IFR Series	Tailor made for SAMSUNG IER/IEA/IFR Series	Tailor made for SAMSUNG IER/IEA/IFR Series
Bracket type:	Fixed	Fixed	Fixed
Landscape / Portrait:	Yes	Yes	Yes
Quick install:	Yes	Yes	Yes
Warranty:	5 years	5 years	5 years



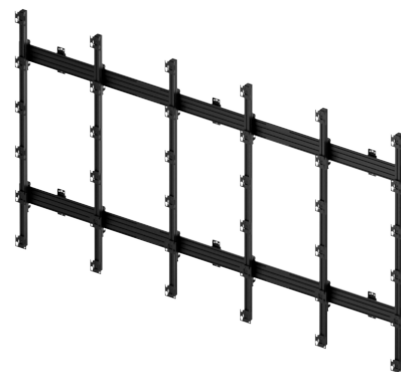

Image courtesy of LG Corp

**M Pro Series LED Customized for LG**

**LAS / LAE / LAE-Q / LAC Series**

For a long time, LG Electronics has focused on developing new innovations in display technology. In LED technology, this is no exception. With a wide range of LED products, you can be sure that there is an LG solution that suits your needs.



M Pro Series LED:	LG - LAS	LG - LAE	LG - LAE-Q	LG - LAC
Non Vesa Fixing:	Tailor made	Tailor made	Tailor made	Tailor made
EAN:	TBD	TBD	TBD	TBD
Max Load:	Tailor made for SAMSUNG IER/IEA/IFR Series	Tailor made for SAMSUNG IER/IEA/IFR Series	Tailor made for SAMSUNG IER/IEA/IFR Series	Tailor made for SAMSUNG IER/IEA/IFR Series
Bracket type:	Fixed	Fixed	Fixed	Fixed
Landscape / Portrait:	Yes	Yes	Yes	Yes
Quick install:	Yes	Yes	Yes	Yes
Warranty:	5 years	5 years	5 years	5 years

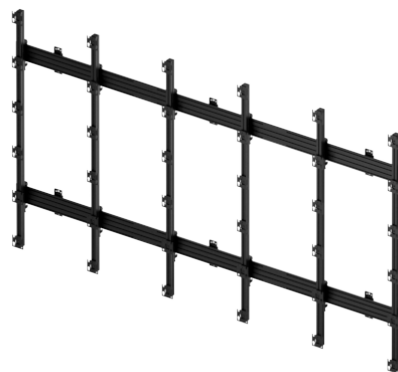

Image courtesy of SHARP-NEC

**M Pro Series LED Customized for SHARP / NEC**

**E / FE / FA Series**

The impressive line up of Sharp/ NEC direct view indoor LED displays provide crystal clear images for the ultimate bezel-free visual experience. Vivid high bright images are viewable in superb clarity from any viewing distance and angle to ensure your message is received with the greatest impact.



M Pro Series LED:	SHARP/NEC - E	SHARP/NEC - FE	SHARP/NEC - FA
<b>Non Vesa Fixing:</b>	Tailor made	Tailor made	Tailor made
<b>EAN:</b>	TBD	TBD	TBD
<b>Max Load:</b>	Tailor made for SHARP / NEC	Tailor made for SHARP / NEC	Tailor made for SHARP / NEC
<b>Bracket type:</b>	Fixed	Fixed	Fixed
<b>Landscape / Portrait:</b>	Yes	Yes	Yes
<b>Quick install:</b>	Yes	Yes	Yes
<b>Warranty:</b>	5 years	5 years	5 years

# PHILIPS



Image courtesy of PHILIPS

## M Pro Series LED Customized for PHILIPS

### 6000/7000/8000/9000 Series

#### Direct view LED displays from Philips.

Experience total creative freedom with limitless Philips direct view LED displays, allowing you to combine as many displays as you like to form custom shapes of any size.

Engineering the future of direct view LED displays, brings Philips trusted quality, proven efficiency and total versatility together with global support.

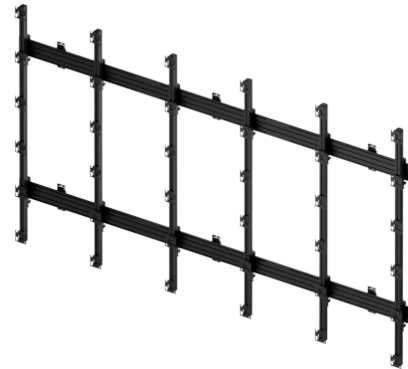

M Pro Series LED:	PHILIPS - 6000	PHILIPS - 7000	PHILIPS - 8000	PHILIPS - 9000
<b>Non Vesa Fixing:</b>	Tailor made	Tailor made	Tailor made	Tailor made
<b>EAN:</b>	TBD	TBD	TBD	TBD
<b>Max Load:</b>	Tailor made for PHILIPS	Tailor made for PHILIPS	Tailor made for PHILIPS	Tailor made for PHILIPS
<b>Bracket type:</b>	Fixed	Fixed	Fixed	Fixed
<b>Landscape / Portrait:</b>	Yes	Yes	Yes	Yes
<b>Quick install:</b>	Yes	Yes	Yes	Yes
<b>Warranty:</b>	5 years	5 years	5 years	5 years



Image courtesy of LG Corp

## Customized for LG® 110UM5J High Brightness & Slim Design

### M Wallmount Pro LG 110UM5J Tilt Black

Being slim, a closer installation to the wall is advised. Additionally, this increases the screen's immersive experience and provides a sophisticated design,

improving the installed-space's décor. The M Wallmount Pro LG 110UM5J Tilt matches this with a slim to wall solution.

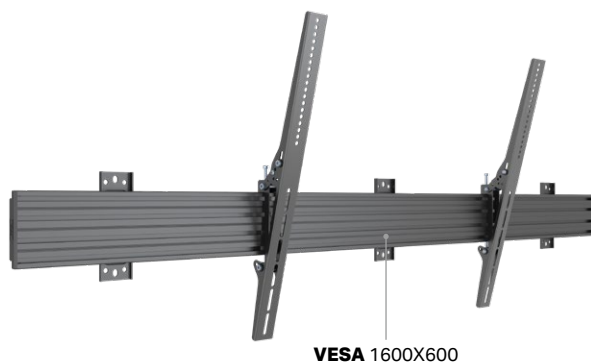

VESA 1600X600

<b>Model name:</b>	M Wallmount Pro LG 110UM5J Tilt Black
<b>EAN:</b>	7350105213298
<b>VESA standard:</b>	Max 1600x600mm
<b>Installation:</b>	for LG 110UM5J
<b>Weight:</b>	9 kg
<b>Max load:</b>	80 kg
<b>Measurements:</b>	39.2x26.2x5cm
<b>Material:</b>	Steel, aluminum
<b>Surface finish:</b>	Powder coating
<b>Colour:</b>	Black
<b>Warranty:</b>	5 years



# Customized for LG® 86BH5F-B Ultra-Stretch

## M Wallmount Pro MBSTH1U

This is our innovative - ready to be installed Single-Display Wallmount. This mount is suited for Ultra-Stretch Digital Signage screens like LG's.

With Multibrackets Pro Series you carry bracket solutions for most stretched displays on the market. Expand your digital signage installations and business limits with stretched monitor displays. Now you can present

information, advertisements and branding in a new way, shape and form with stretched displays and our brackets distinctively our brackets diinctively versatile.

### VESA:

600x400, 600x200, 400x600, 200x600

### Highlights:

- A flexible system product ideal for video walls and menuboard
- Includes VESA adapters for compatibility up to VESA 200x600 / 600x200
- Module based aluminum rails creates desirable length without cuing
- Integrated cable management throughout the entire solution
- Power click install for an easy, fast and safe installation
- Dual wallplates included
- Portrait or landscape position of screen possible
- Hardware kit included

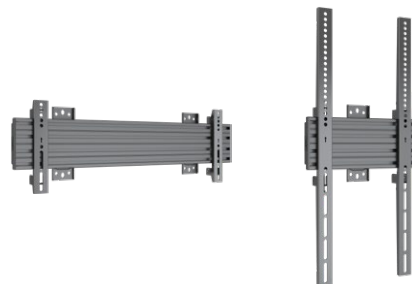

Model name:	MBSTH1U 600x200 Fixed	MBSTH1UP 200x600 Fixed
Recommended screen size:	40" - 100" stretched	40" - 100" stretched
VESA® & non-VESA fixings:	VESA 200x600mm	VESA 600x200mm
EAN:	7350073734306	7350073734313
Max load:	80kg	45kg
Bracket type:	Fixed	Fixed
Landscape/portrait:	Landscape	Portrait
Wall distance:	40 cm	40 cm
Colour (VESA arms):	Black	Black
Colour (Horizontal rail):	Black (Silver optional)	Black (Silver optional)
Warranty:	5 years	5 years



Design plate cover ceiling installation



Selected models are TUV approved



Pro Series tested for 5 times the max load

**New!**

**Customized for LG®  
86BH5F-M**

# Quad Ceiling Mount

**M Ceiling Mount Pro MBC4UHD**

The new professional Pro Series A/V line from Multi-brackets was designed with the installer in mind. Modular, easy to configure, quick to install,

and simple to maintain. Working closely with installers we created a range with close to unlimited flexibility.





Image courtesy of Samsung Corp

## Customized for Samsung® Samsung SH37F

# Ultra-Stretch

## M Wallmount Pro MBSTH1U

The new professional Pro Series A/V line from Multi-brackets was designed with the installer in mind. Modular, easy to configure, quick to install,

and simple to maintain. Working closely with installers we created a range with close to unlimited flexibility.

### Highlights:

- A flexible system product ideal for video walls and menuboards
- Includes VESA adapters for compatibility up to VESA 400x200 / 200x400
- Module based aluminum rails creates desired
- Integrated cable management throughout the entire solution
- Power click install for an easy, fast and safe installation
- Dual wallplates included
- Portrait or landscape position of screen possible
- Hardware kit included

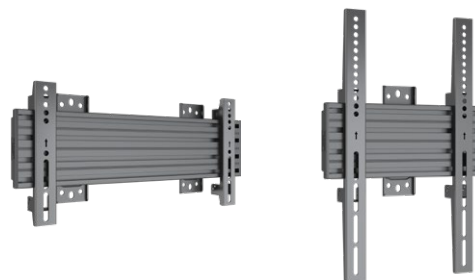

	Model name: MBSTH1U 400x200 Fixed	MBSTH1UP 200x400 Fixed
Recommended screen size:	SH37F(37")	SH37F(37")
VESA® & non-VESA fixings:	VESA 400x200mm	VESA 200x400mm
EAN:	7350073737994	7350073738007
Max load:	80 kg	45 kg
Bracket type:	Fixed	Fixed
Landscape/portrait:	Yes	Portrait
Wall distance:	40 cm	40 cm
Colour (VESA arms):	Black	Black
Colour (Horizontal rail):	Black (Silver optional)	Black (Silver optional)
Warranty:	5 years	5 years



Image courtesy of Samsung Corp

## Promote storefront content

Customized for

**Samsung®**

**OM55N-D / OM46N-D**

### Highlights:

- Ceilingmounts and floormounts dedicated to present bright content on a dual-display
- Modernizes and saves store space with its flexible design, offers more room to market your brand or products
- Dedicated side mounting points compatible with Samsung OMND back-to-back display models
- Highest level of finish to any client branding, bespoke colors available on request
- Semi Concealed hardware for sleek & stylish aesthetics
- A standalone floor base is optional
- Durable design, Multibrackets well known quality of materials and production process
- Complete hardware kit included



## MB Pro Series OM55N-D



**Floormount Pro**  
OM55N-D



**Floorbase Pro**  
OM55N-D



**Wheelbase Pro**  
OM55N-D



**Ceilingmount Pro**  
OM55N-D



**Ceilingmount  
with extension kit**  
Pro OM55N-D



**Wiremount Pro**  
OM55N-D

## MB Pro Series OM46N-D



**Floormount Pro**  
OM46N-D



**Floorbase Pro**  
OM46N-D



**Wheelbase Pro**  
OM46N-D



**Ceilingmount Pro**  
OM46N-D



**Ceilingmount  
with extension kit**  
Pro OM46N-D



**Wiremount Pro**  
OM46N-D

**PRO SERIES**

**Customized** for specific brands and models



Image courtesy of BenQ Corp



BH2801 / BH3801

**Ideal for Point of Sale marketing**

Together with BenQ's Bar Type Displays, this makes an ideal for point-of-sale marketing. For the narrowest spaces, such as on front of shelves, BH2401 (63\*9 cm) and BH3501 (90\*9 cm) are perfect fits.

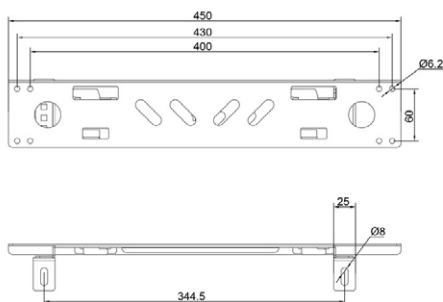

	Ceiling Mount Pro BH2401	Ceiling Mount Pro BH2801
<b>Model name</b>	Ceiling Mount Pro BH2401	Ceiling Mount Pro BH2801
<b>Recommended Screen Size</b>	BENQ BH2401 and BH3501	BENQ BH2801 and BH3801
<b>Article Nr / EAN</b>	7350073737499	7350073737505
<b>Max Load</b>	15kg	15kg
<b>Bracket Type</b>	Fixed	Fixed
<b>Landscape / Portrait</b>	Yes	Yes

M Pro Series for Samsung OH46/55/75 displays

# Outdoor

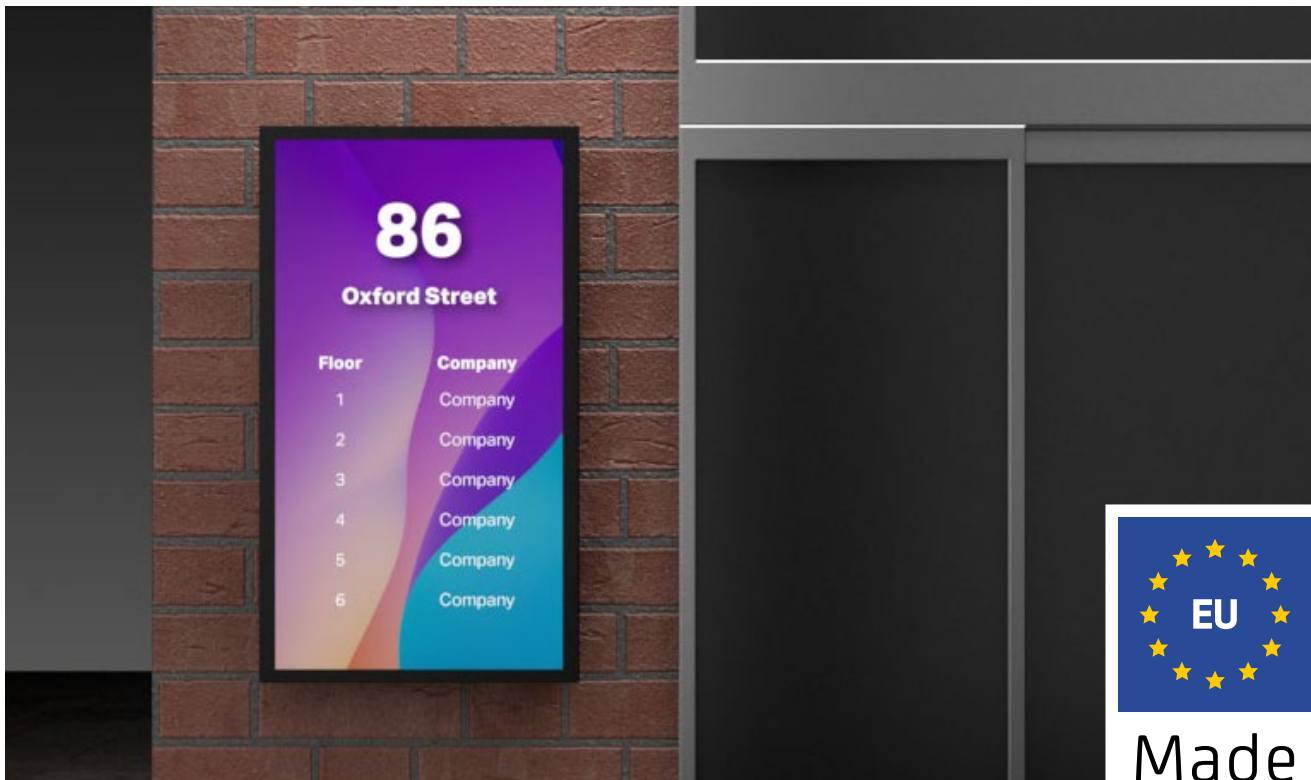

Made in EU

Hergestellt nach europäischen Qualitätsstandards

## Integrate displays outdoors with wallmounted elegance & safety.

Tailored for Samsung OHF 46", OHF and OHA 55" and OHF 75" outdoor wall mounts with anti-corrosion treatment. The outdoor OHF Series is conveniently and easily installed, designed and operated with a thin, all-in-one solution, which comes in a package which includes ingress protection, anti-reflection technology, an embedded power box, vandalism protection and a highly efficient cooling system.

Multibrackets range of tailored OHF Pro Series mounts are a perfect fit. Use the same mount for both landscape and portrait installations.

Choose portrait or landscape mode

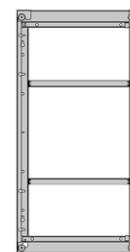

	M Wallmount Pro OH46F/B	M Wallmount Pro OH55F/B/A-S	M Wallmount Pro OH075
For screen size:	46"	55"	75"
VESA standard:	995x500	1186x560	Customized for OH75F
EAN:	7350105214745	7350105214752	7350105215339
Size in cm:	125 x 65 x 9	106 x 59 x 9	200x100x20
Weight:	12.5 kg	10.5 kg	16 kg
Colour:	Black	Black	Black
Warranty:	5 years	5 years	5 years

**PRO SERIES**

**PHILIPS**

32BDL-4050D / 49BDL-4050D  
49BDL-4050D

# Customized

for specific brands and models



Extension Pipe  
Adjustable length



Extender Kit

# Get full product attention

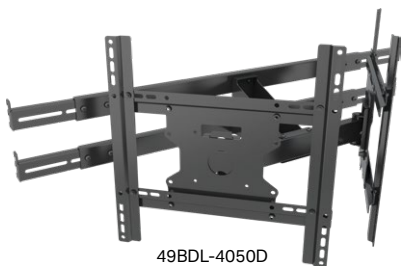
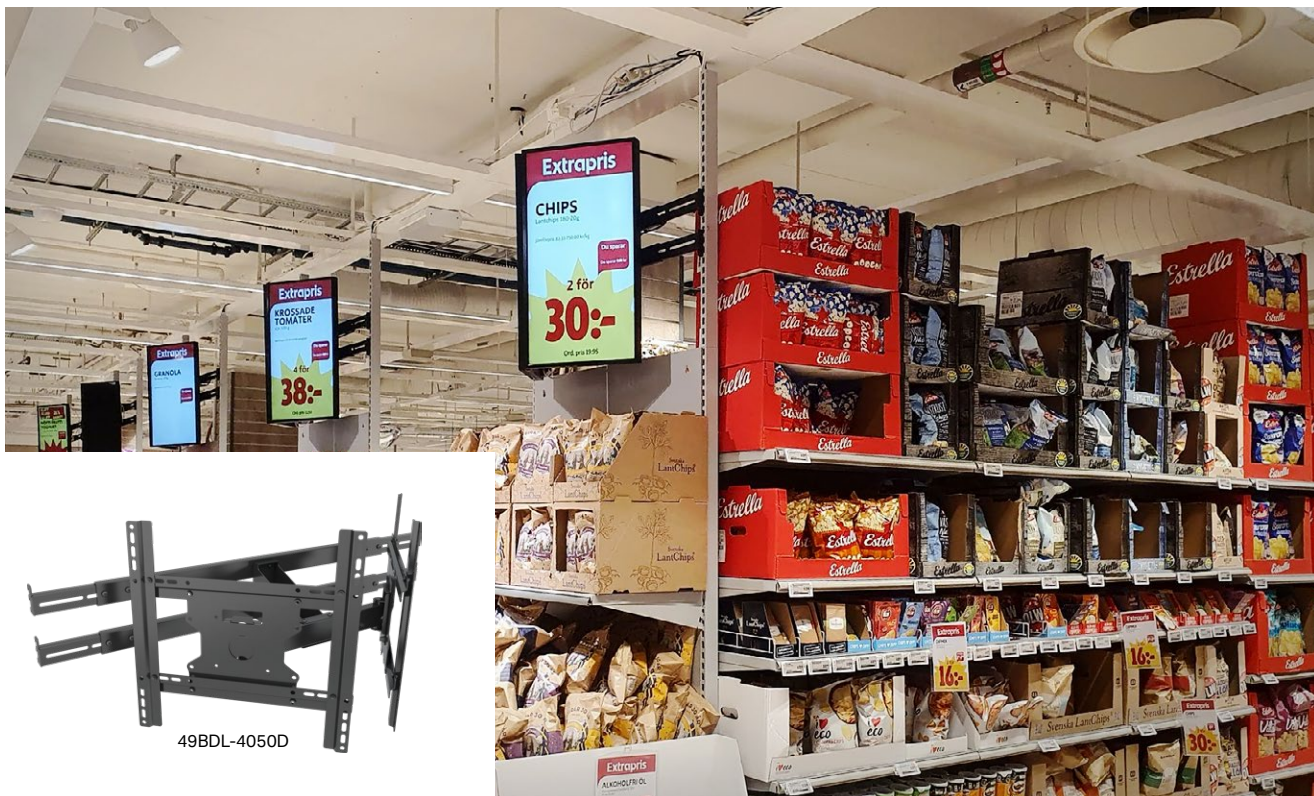

49BDL-4050D

M Ceiling Mount Pro Dual 32BDL-4050D



M Ceiling Mount Pro Triple 32BDL-4050D



M Ceiling Mount Pro Dual 49BDL-4050D

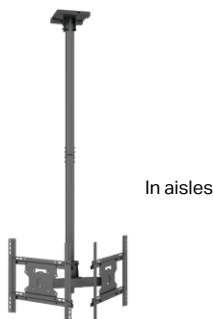

M Ceiling Mount Pro Triple 49BDL-4050D



Dual 32BDL-4050D

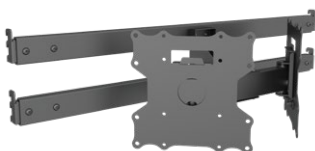

Dual 49BDL-4050D



Designed for in store shelf systems

Model name:	Dual 32BDL-4050D	Triple 32BDL-4050D	Dual 32BDL-4050D	Dual 49BDL-4050D	Dual 32BDL-4050D	Dual 49BDL-4050D
Rec. Screen Size:	32"	32"	49"	49"	32"	49"
VESA® & non-VESA fixings:	VESA 200x200mm	VESA 200x200mm	VESA 400x400mm	VESA 400x400mm	VESA 200x200mm	VESA 400x400mm
EAN:	7350073737543	7350073737550	7350073737574	7350073737581	7350073737567	7350073737598
Max Load:	30kg (Per screen)	30kg (Per screen)	30kg (Per screen)	30kg (Per screen)	30kg (Per screen)	30kg (Per screen)
Bracket Type:	Fixed	Fixed	Fixed	Fixed	Fixed	Fixed
Pole length:	80 - 150 cm	80 - 150 cm	80 - 150 cm	80 - 150 cm	---	---
Landscape / portrait:	---	---	---	---	Yes	Yes
Colour:	Black	Black	Black	Black	Black	Black
Warranty:	5 years	5 years	5 years	5 years	5 years	5 years
Accessories:	Cover plate	Cover plate	Cover plate	Cover plate	---	---

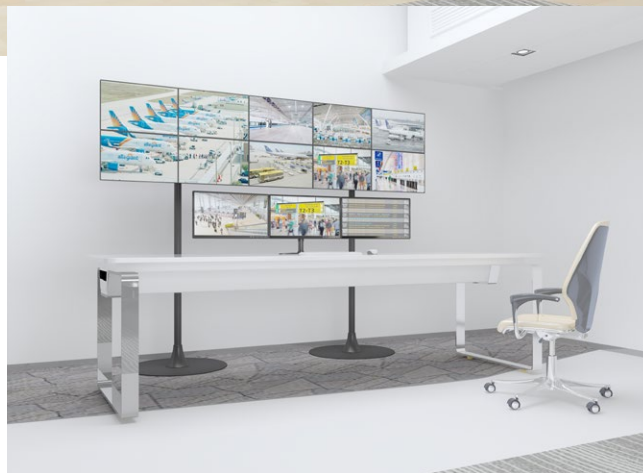

## Pro Series Control rooms

### Multiscreen display and monitor mounting for control rooms

Multibrackets Pro Series acts as the perfect multiscreen holder or control room, studios and other situations where a large amount of displays are needed in a confined space. Pro Series offers an elegant solution for complementary large monitors in the control room environment.

“Pro Series lets you mix solutions, displays and monitors”

### Highlights:

- Same mounting rail and system is being used
- Cable management keeps all cables in order
- Wide range of VESA handles all displays
- Easy to change design and outlook after time
- Industrial quality productrange

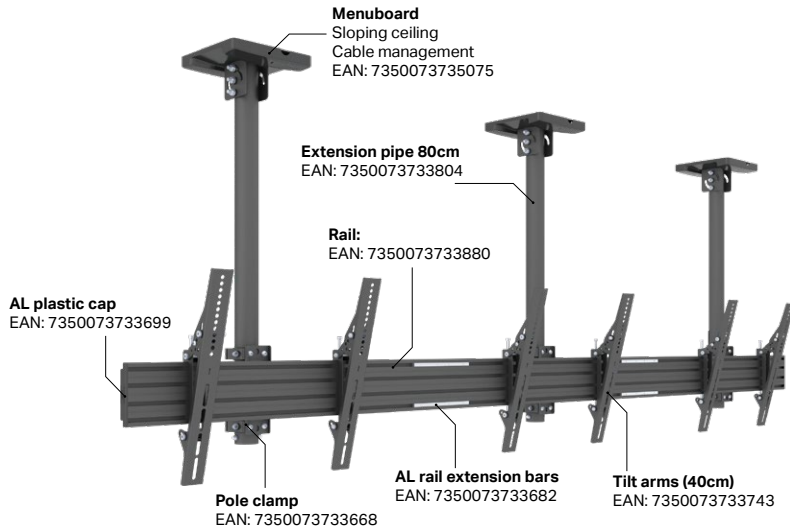

## Pro Series Ceilingmounts

Our ceilingmount solutions are designed to handle both monitors and displays, mixed. This way you can create any type of combination you need for your installation. Any flexible monitor or display can use the Pro Series Ceilingmount Flexarms.

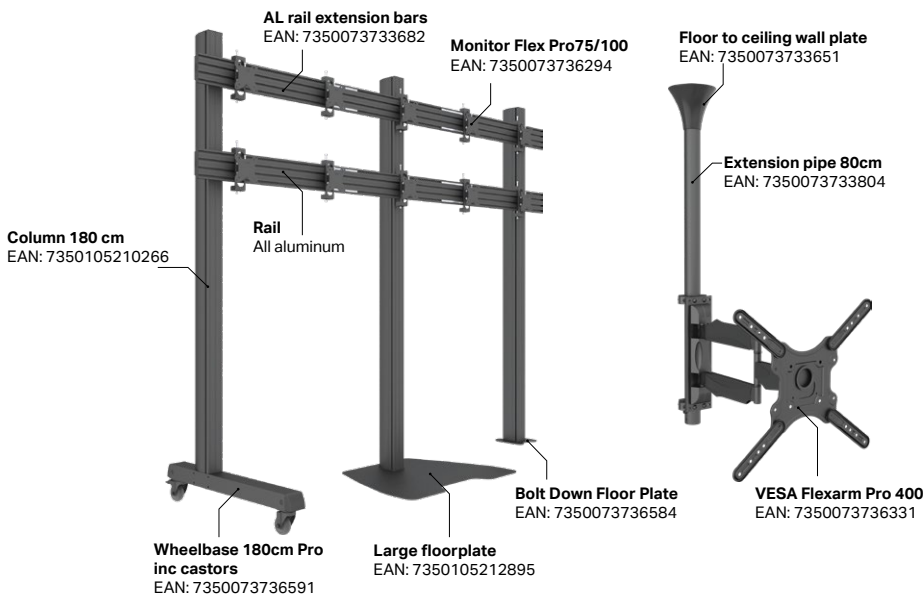

## Pro Series Video/ Monitorwall

These videowalls use the unique Multibrackets Pro Series rail system. This system can handle anything from VESA 50 which are often found on smaller size monitors up to VESA 1000x600 used by large size displays. Combine large displays with monitors. Your imagination sets the limit.

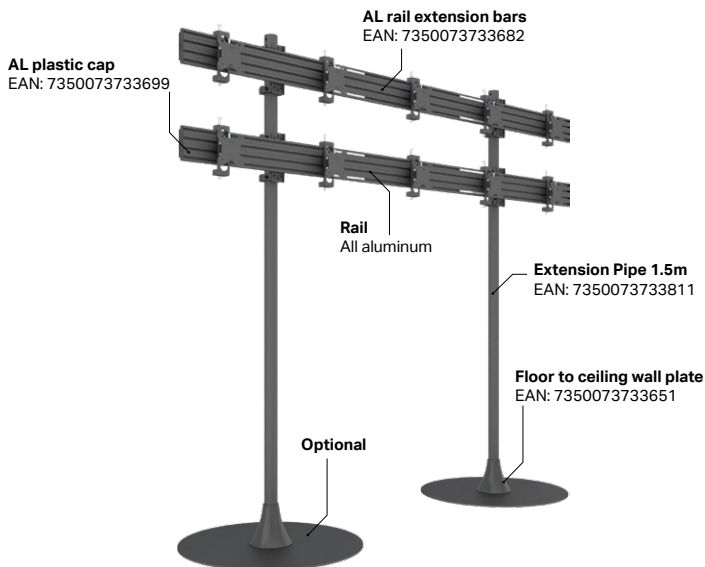

## Pro Series Monitorstands

If you plan to have a higher resolution monitorwall the Pro Series solves that as well. The railsystem uses monitormounts fixed or tilt and can then adopt close to any monitor on the markets. So wheter its small size 27" monitors or the new wide screen format monitors these monitorstands will solve your request.



# Pro Series M Wallmount Column

## M Pro Series - Wallmount Column & Column Dual

Innovative - ready to be installed Single or Dual-Display Wallmount on a column. A mounting system which enables you to mount displays on columns without drilling. This is a perfect indoor solution for mounting digital signage displays onto round columns.

These products offer safe and easy installation in landscape and portrait mounting. Ideal for stadiums, arenas, stores and anywhere else column-based mounting is preferred and provides a solution for attaching digital signage displays to various diameter columns.



	M Wallmount Column	M Wallmount Column Dual
<b>Model name:</b>	M Wallmount Column	M Wallmount Column Dual
<b>EAN:</b>	7350073738458	7350105213076
<b>For screen size:</b>	32"-65"	32"-65"
<b>Type:</b>	Single Side MBW1U	Double Side MBW1U
<b>VESA standard:</b>	VESA400,40cm	VESA400,40cm
<b>Material:</b>	Steel, Aluminium	Steel, Aluminium
<b>Max Load:</b>	35 kg (Per screen)	35 kg (Per screen)
<b>Tilt:</b>	Yes, -6~15°	Yes, -6~15°
<b>Warranty:</b>	5 years	5 years



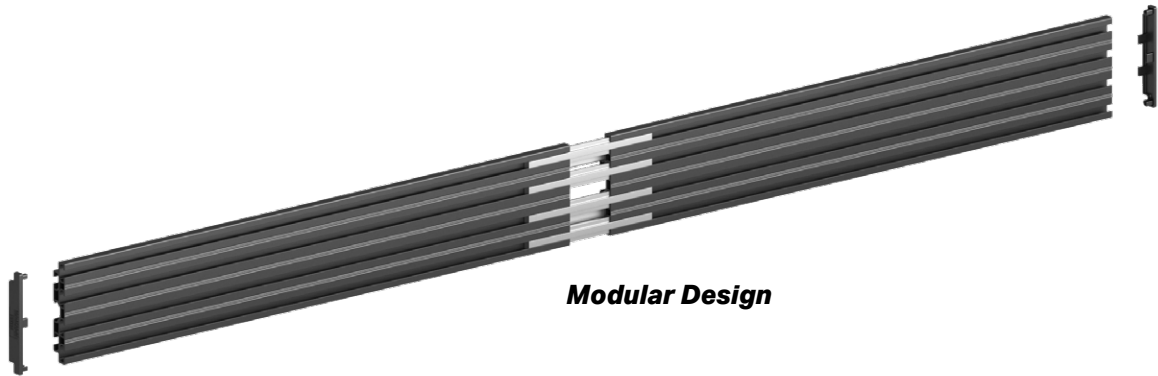

**Accessories:**



Cable Management



Rail Extension



Rail Stopper



Rail End Cover

**PRO SERIES**

# M Pro Series Rails

## Function and freedom for the installer

The Pro Series horizontal mounting rails are the central component of any Pro Series product whether it be wall-mount menuboard or a single screen ceilingmount. Made from high grade aluminium, the rail itself is sturdy yet lightweight and is designed to support a variety of interface arms and mounts, allowing monitors, screens and other AV equipment to be fitted onto the rail. The Pro Series Railsystem is versatile.

Our Rails are available in packaged solutions of lengths, 28cm, 48cm, 68cm, 100cm, 196cm, 348cm. It can be mounted on Pro Series columns, poles and wallbrackets. The Rails can be cut to shorter lengths as required or joined together using extension kits to reach the right length for your installation.

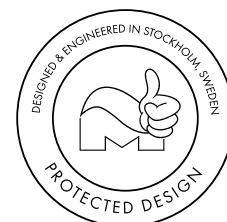
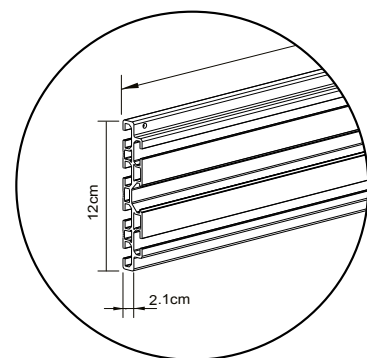

Single AL rail 28cm (black)



**EAN:** 7350073735082  
**Length:** 28cm  
**Colour:** Black  
**Material:** Aluminum  
**Warranty:** 5 years

Single AL rail 48cm (black)

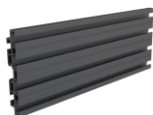

**EAN:** 7350073735082  
**Length:** 48cm  
**Colour:** Black  
**Material:** Aluminum  
**Warranty:** 5 years

Single AL rail 68cm (black)

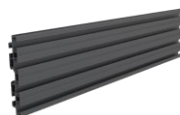

**EAN:** 7350073733866  
**Length:** 68cm  
**Colour:** Black  
**Material:** Aluminum  
**Warranty:** 5 years

Single AL rail 100cm (black)



**EAN:** 7350073738021  
**Length:** 100cm  
**Colour:** Silver  
**Material:** Aluminum  
**Warranty:** 5 years

Dual Screen Rail 196cm

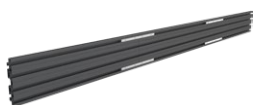

**EAN:** 7350073733873  
**Length:** 196cm  
**Colour:** Black  
**Material:** Aluminum  
**Warranty:** 5 years

Triple Screen Rail 348cm

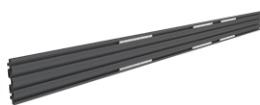

**EAN:** 7350073733880  
**Length:** 348cm  
**Colour:** Black  
**Material:** Aluminum  
**Warranty:** 5 years

Rail Extension



**EAN:** 7350073733682  
**Length:** ---  
**Colour:** Silver  
**Material:** Steel  
**Warranty:** 5 years

Rail Extension Black



**EAN:** 7350073736867  
**Length:** ---  
**Colour:** Black  
**Material:** Steel  
**Warranty:** 5 years

Rail End Cover



**EAN:** 7350073733699  
**Colour:** Black  
**Material:** Plastic  
**Warranty:** 5 years

Media Storage Slide Panel



**EAN:** 7350105213847  
**Colour:** Black  
**Material:** Steel  
**Warranty:** 5 years

Curved Screen Rail Joiner



**EAN:** 7350073736348  
**Colour:** Black  
**Material:** Steel (SPCC Graded)  
**Warranty:** 5 years

Cable Management Clip



**EAN:** 7350073737482  
**Colour:** Black  
**Material:** Plastic  
**Warranty:** 5 years

Rail Stopper



**EAN:** 7350073737321  
**VESA® & non-VESA fixings:** ---  
**Max load:** ---  
**Bracket type:** ---  
**Colour:** Silver  
**Material:** Steel  
**Warranty:** 5 years

Fixed Arms 20cm



**EAN:** 7350073733903  
**VESA200 ,20cm**  
**Max load:** 30kg  
**Bracket type:** Fixed  
**Colour:** Black  
**Material:** Steel (SPCC Graded)  
**Warranty:** 5 years

Fixed Arms 40cm



**EAN:** 7350073733866  
**Colour:** Black  
**Max load:** 30kg  
**Bracket type:** Fixed  
**Colour:** Black  
**Material:** Steel (SPCC Graded)  
**Warranty:** 5 years

Fixed Arms 60cm



**EAN:** 7350073733705  
**Colour:** Black  
**Max load:** 30kg  
**Bracket type:** Fixed  
**Colour:** Black  
**Material:** Steel (SPCC Graded)  
**Warranty:** 5 years

**Fixed Arms 90cm**



**EAN:** 7350073733774

**Tilt Arms 20cm**



**EAN:** 7350073733910

**Tilt Arms 40cm**



**EAN:** 7350073733743

**Tilt Arms 60cm**



**EAN:** 7350073733767

**VESA® & non-VESA fixings:**

VESA900 ,90cm

VESA200 ,20cm

Black

Black

**Max load:**

30kg

30kg

30kg

30kg

**Bracket type:**

Fixed

Tilt

Tilt

Tilt

**Colour:**

Black

Black

Black

Black

**Material:**

Steel (SPCC Graded)

Steel (SPCC Graded)

Steel (SPCC Graded)

Steel (SPCC Graded)

**Warranty:**

5 years

5 years

5 years

5 years

**Tilt Arms 90cm**



**EAN:** 7350073733774

**M Push in Pop out VESA 400**



**EAN:** 7350073734726

**M Push in Pop out VESA 600**



**EAN:** 7350105210464

**Extender kit 600**



**EAN:** 7350073734733

**VESA® & non-VESA fixings:**

VESA900 ,90cm

VESA400 ,40cm

Black

Black

**Max load:**

30kg

30kg

30kg

---

**Bracket type:**

Fixed

Push in Pop out arms

Push in Pop out arms

---

**Colour:**

Black

Black

Black

Black

**Material:**

Steel (SPCC Graded)

Steel (SPCC Graded)

Steel (SPCC Graded)

Steel (SPCC Graded)

**Warranty:**

5 years

5 years

5 years

5 years

**40cm Micro-Adjustable Arms**



**EAN:** 7350073733798

**60cm Micro-Adjustable Arms**



**EAN:** 7350105210457

**M Monitor Fixed Pro 50/75/100**



**EAN:** 7350073736300

**M Monitor Flex Pro 50/75/100**



**EAN:** 7350073736294

**VESA® & non-VESA fixings:**

VESA400 ,40cm

VESA400 ,40cm

50x50, 75x75, 100x100

50x50, 75x75, 100x100

**Max load:**

30kg

30kg

15kg

15kg

**Bracket type:**

Micro-Adjustable Arms

Push in Pop out arms

Fixed

Tilt

**Colour:**

Black

Black

Black

Black

**Material:**

Steel (SPCC Graded)

Steel (SPCC Graded)

Steel (SPCC Graded)

Steel (SPCC Graded)

**Warranty:**

5 years

5 years

5 years

5 years

**VESA Flexarm Pro 400**



**EAN:** 7350073736331

**VESA Flexarm Pro Portrait**



**EAN:** 7350105212499

**Dual Pole bracket 600X900**



**EAN:** 7350073738854

**Dual Pole bracket 800X600**



**EAN:** 7350073738847

**VESA® & non-VESA fixings:**

400x400mm

600x400mm

600X900mm

800x600mm

**Colour:**

Black

Black

Black

Black

**Material:**

Steel (SPCC Graded)

Steel (SPCC Graded)

Steel (SPCC Graded)

Steel (SPCC Graded)

**Wallmount Plate Slim Small**



**EAN:** 7350073736980  
**Colour:** Black  
**Material:** Steel (SPCC Graded)  
**Warranty:** 5 years

**Wallmount Plate Small**



**EAN:** 7350073734184  
**Colour:** Black  
**Material:** Steel (SPCC Graded)  
**Warranty:** 5 years

**Wallmount Plate Large**

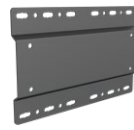

**EAN:** 7350073733675  
**Colour:** Black  
**Material:** Steel (SPCC Graded)  
**Warranty:** 5 years

**Pole Clamp Plate**



**EAN:** 7350073736119  
**Colour:** Black  
**Material:** Steel (SPCC Graded)  
**Warranty:** 5 years

**Single display plate from wall**

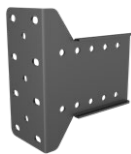

**EAN:** 7350073737338  
**Colour:** Black  
**Material:** Steel (SPCC Graded)  
**Warranty:** 5 years

**B2b display plate from wall**



**EAN:** 7350073737345  
**Colour:** Silver  
**Material:** Steel (SPCC Graded)  
**Warranty:** 5 years

**Ceiling Plate HD**



**EAN:** 7350073734696  
**Colour:** Black  
**Material:** Steel (SPCC Graded)  
**Warranty:** 5 years

**Ceiling Plate with Cover Black**



**EAN:** 7350073735075  
**Colour:** Black  
**Material:** Steel (SPCC Graded)  
**Warranty:** 5 years

**Ceiling Plate with Cover White**



**EAN:** 7350073739028  
**Colour:** White  
**Material:** Steel (SPCC Graded)  
**Warranty:** 5 years

**I-Beam Clamp**



**EAN:** 7350073736386  
**Colour:** Black  
**Material:** Steel (SPCC Graded)  
**Warranty:** 5 years

**Connecting plate**



**EAN:** 7350073736973  
**Colour:** Black  
**Material:** Steel (SPCC Graded)  
**Warranty:** 5 years

**Dual bracket V-shape 32"-43"**



**EAN:** 7350105212475  
**Colour:** Black  
**Material:** Steel (SPCC Graded)  
**Warranty:** 5 years

**Dual bracket V-shape 46"-65"**



**EAN:** 7350105212482  
**Colour:** Black  
**Material:** Steel (SPCC Graded)  
**Warranty:** 5 years

**Extension Pipe 0.8m Black**



**EAN:** 7350073733804  
**Colour:** Black  
**Material:** Steel (SPCC Graded)  
**Warranty:** 5 years

**Extension Pipe 1.5m Black**







**EAN:** 7350073733811  
**Colour:** Black  
**Material:** Steel (SPCC Graded)  
**Warranty:** 5 years

**Extension Pipe 3m Black**



**EAN:** 7350073733828  
**Colour:** Black  
**Material:** Steel (SPCC Graded)  
**Warranty:** 5 years

	Extension Pipe 0.8m White	Extension Pipe 1.5m White	Extension Pipe 3m White	Chrome Extension Pipe 3m
				
<b>EAN:</b>	7350073736140	7350073736157	7350073736164	7350073733835
<b>Colour:</b>	White	White	White	Chrome
<b>Material:</b>	Steel (SPCC Graded)	Steel (SPCC Graded)	Steel (SPCC Graded)	Steel (SPCC Graded)
<b>Warranty:</b>	5 years	5 years	5 years	5 years

	Brass Extension Pipe 3m	External Pipe Cover Brass	External Pipe Cover Black	External Pipe Cover White
				
<b>EAN:</b>	7350073733842	7350073736225	7350073734221	7350073736201
<b>Colour:</b>	Brass	Brass	Black	White
<b>Material:</b>	Steel (SPCC Graded)	Plastic	Plastic	Plastic
<b>Warranty:</b>	5 years	5 years	5 years	5 years

	External Pipe Cover Chrome	Floor To Ceiling Plate Black	Floor To Ceiling Plate Brass	Internal Pole Joiner
				
<b>EAN:</b>	7350073736218	7350073733651	7350073736195	7350073734191
<b>Colour:</b>	White	Black	Brass	Chrome
<b>Material:</b>	Plastic	Plastic+Steel (SPCC Graded)	Plastic+Steel (SPCC Graded)	Plastic+Steel (SPCC Graded)
<b>Warranty:</b>	5 years	5 years	5 years	5 years

	Floor To Ceiling Plate White	Inner Ceiling Plate Cover Black	Extension Pipe 1.5m Black	Internal Pole Joiner
				
<b>EAN:</b>	7350073733859	7350073736270	7350073736287	7350073734191
<b>Colour:</b>	Black	Black	Black	Chrome
<b>Material:</b>	Plastic+Steel (SPCC Graded)	Plastic	Plastic	Steel (SPCC Graded)
<b>Warranty:</b>	5 years	5 years	5 years	5 years

**Pole Clamp**



**EAN:** 7350073733668  
**Colour:** Black  
**Material:** Steel (SPCC Graded)  
**Warranty:** 5 years

**Dual Pole Clamp**



**EAN:** 7350073735068  
**Colour:** Black  
**Material:** Steel (SPCC Graded)  
**Warranty:** 5 years

**Pole Clamp Wall Bracket**



**EAN:** 7350073734177  
**Colour:** Black  
**Material:** Steel (SPCC Graded)  
**Warranty:** 5 years

**Pole Drill Fixture**



**EAN:** 7350073734214  
**Colour:** Black  
**Material:** Steel (SPCC Graded)  
**Warranty:** 5 years

**Truss Clamp 45-51 mm**



**EAN:** 7350073734320  
**Colour:** Black  
**Material:** Steel (SPCC Graded)  
**Warranty:** 5 years

**Wheelbase 180cm Pro inc castors**



**EAN:** 7350073736591  
**Colour:** Black  
**Material:** Aluminum +Steel(SPCC Graded)  
**Warranty:** 5 years

**Wheelbase 270cm Pro inc castors**



**EAN:** 7350073736607  
**Colour:** Black  
**Material:** Aluminum +Steel(SPCC Graded)  
**Warranty:** 5 years

**Wheelbase 300cm Pro inc castors**



**EAN:** 7350073736614  
**Colour:** Black  
**Material:** Aluminum +Steel(SPCC Graded)  
**Warranty:** 5 years

**Large Floorplate - column 150cm**



**EAN:** 7350105212925  
**Colour:** Black  
**Material:** Aluminum +Steel(SPCC Graded)  
**Warranty:** 5 years

**Large Floorplate - column 180cm**



**EAN:** 7350105212932  
**Colour:** Black  
**Material:** Aluminum +Steel(SPCC Graded)  
**Warranty:** 5 years

**Large Floorplate - column 270cm**



**EAN:** 7350105212949  
**Colour:** Black  
**Material:** Aluminum +Steel(SPCC Graded)  
**Warranty:** 5 years

**Large Floorplate - column 300cm**

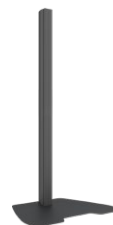

**EAN:** 7350105212956  
**Colour:** Black  
**Material:** Aluminum +Steel(SPCC Graded)  
**Warranty:** 5 years

**Column 150cm**



**EAN:** 7350105210259  
**Colour:** Black  
**Material:** Aluminum  
**Warranty:** 5 years

**Column 180cm**



**EAN:** 7350105210266  
**Colour:** Black  
**Material:** Aluminum  
**Warranty:** 5 years

**Column 270cm**



**EAN:** 7350105210273  
**Colour:** Black  
**Material:** Aluminum  
**Warranty:** 5 years

**Column 300cm**



**EAN:** 7350105212550  
**Colour:** Black  
**Material:** Aluminum  
**Warranty:** 5 years

**Bolt Down Floor Plate**

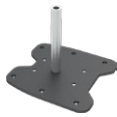

<b>EAN:</b>	7350073736584
<b>Colour:</b>	Black
<b>Material:</b>	Steel (SPCC Graded)
<b>Warranty:</b>	5 years

**Base Plate**



<b>EAN:</b>	7350073736447
<b>Colour:</b>	Black
<b>Material:</b>	Steel (SPCC Graded)
<b>Warranty:</b>	5 years

**Large Floorplate**



<b>EAN:</b>	7350105212895
<b>Colour:</b>	Black
<b>Material:</b>	Steel (SPCC Graded)
<b>Warranty:</b>	5 years

**Bolt Down Pole Plate**



<b>EAN:</b>	7350105210471
<b>Colour:</b>	Black
<b>Material:</b>	Steel (SPCC Graded)
<b>Warranty:</b>	5 years

**Camera Shelf**



<b>EAN:</b>	7350073736638
<b>Colour:</b>	Black
<b>Material:</b>	Steel (SPCC Graded)
<b>Warranty:</b>	5 years

**Soundbar Holder**



<b>EAN:</b>	7350073736645
<b>Colour:</b>	Black
<b>Material:</b>	Steel (SPCC Graded)
<b>Warranty:</b>	5 years

**AV Shelf**



<b>EAN:</b>	7350073736430
<b>Colour:</b>	Black
<b>Material:</b>	Steel (SPCC Graded)
<b>Warranty:</b>	5 years

**Curved Display Distance**

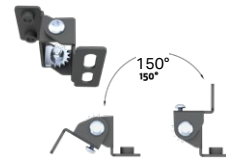

<b>EAN:</b>	7350105212284
<b>Colour:</b>	Black
<b>Material:</b>	Steel (SPCC Graded)
<b>Warranty:</b>	5 years

**Wheelbase Supportbar 750mm**



<b>EAN:</b>	7350105213045
<b>Colour:</b>	Black
<b>Material:</b>	Steel (SPCC Graded)
<b>Warranty:</b>	5 years

**Wheelbase Supportbar 1200mm**



<b>EAN:</b>	7350105213052
<b>Colour:</b>	Black
<b>Material:</b>	Steel (SPCC Graded)
<b>Warranty:</b>	5 years

**Pole Clamp Ring**



<b>EAN:</b>	7350105213571
<b>Colour:</b>	Black
<b>Material:</b>	Plastic+Steel (SPCC Graded)
<b>Warranty:</b>	5 years

**Floor Support 1025-1075mm Black**



<b>EAN:</b>	7350105213540
<b>Colour:</b>	Black
<b>Material:</b>	Plastic+Steel (SPCC Graded)
<b>Warranty:</b>	5 years

**Ceiling Plate w. Weight Balance**



<b>EAN:</b>	7350105213649
<b>Colour:</b>	Black
<b>Material:</b>	Steel (SPCC Graded)
<b>Warranty:</b>	5 years

**Anti-theft Mini**



<b>EAN:</b>	7350022735033
<b>Colour:</b>	Chrome
<b>Material:</b>	Steel (SPCC Graded)
<b>Warranty:</b>	5 years

**Anti Theft Screws Pack M8**



<b>EAN:</b>	7350105214318
<b>Colour:</b>	Chrome
<b>Material:</b>	Steel (SPCC Graded)
<b>Warranty:</b>	5 years

**Anti Theft Screws Pack M5 M6**



<b>EAN:</b>	7350105214325
<b>Colour:</b>	Chrome
<b>Material:</b>	Steel (SPCC Graded)
<b>Warranty:</b>	5 years

**Adjustable Feet Pro**



<b>EAN:</b>	7350073736577
<b>Colour:</b>	Black
<b>Material:</b>	Plastic+Steel (SPCC Graded)
<b>Warranty:</b>	5 years



## **Multibrackets Europe AB**

Phone: +46(0)8- 615 04 00 Mail: [support@multibrackets.com](mailto:support@multibrackets.com)

Postal address: Döbelnsgatan 21, 11th floor SE-111 40 Stockholm Sweden

