



OPEN Industry Standard, Flexible Architecture

GREEN Less Heat, Less Power Consumption

STABLE Robust Design, Quality Parts

Stable and
Reliable Solution

Server/Workstation
Motherboard

X570D4U
X570D4U-2L2T
X570D4U-2L2T/BCM

User Manual

English

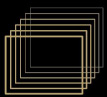

Version 1.0

Published September 2022

Copyright©2022 ASRock Rack INC. All rights reserved.

Copyright Notice:

No part of this documentation may be reproduced, transcribed, transmitted, or translated in any language, in any form or by any means, except duplication of documentation by the purchaser for backup purpose, without written consent of ASRock Rack Inc.

Products and corporate names appearing in this documentation may or may not be registered trademarks or copyrights of their respective companies, and are used only for identification or explanation and to the owners' benefit, without intent to infringe.

Disclaimer:

Specifications and information contained in this documentation are furnished for informational use only and subject to change without notice, and should not be constructed as a commitment by ASRock Rack. ASRock Rack assumes no responsibility for any errors or omissions that may appear in this documentation.

With respect to the contents of this documentation, ASRock Rack does not provide warranty of any kind, either expressed or implied, including but not limited to the implied warranties or conditions of merchantability or fitness for a particular purpose.

In no event shall ASRock Rack, its directors, officers, employees, or agents be liable for any indirect, special, incidental, or consequential damages (including damages for loss of profits, loss of business, loss of data, interruption of business and the like), even if ASRock Rack has been advised of the possibility of such damages arising from any defect or error in the documentation or product.



This device complies with Part 15 of the FCC Rules. Operation is subject to the following two conditions:

- (1) this device may not cause harmful interference, and
- (2) this device must accept any interference received, including interference that may cause undesired operation.

This equipment has been tested and found to comply with the limits for a Class B digital device, pursuant to part 15 of the FCC Rules. These limits are designed to provide reasonable protection against harmful interference in a residential installation. This equipment generates, uses and can radiate radio frequency energy and, if not installed and used in accordance with the instructions, may cause harmful interference to radio communications. However, there is no guarantee that interference will not occur in a particular installation. If this equipment does cause harmful interference to radio or television reception, which can be determined by turning the equipment off and on, the user is encouraged to try to correct the interference by one or more of the following measures:

- Reorient or relocate the receiving antenna.
- Increase the separation between the equipment and receiver.
- Connect the equipment into an outlet on a circuit different from that to which the receiver is connected.
- Consult the dealer or an experienced radio/TV technician for help.

The terms HDMI® and HDMI High-Definition Multimedia Interface, and the HDMI logo are trademarks or registered trademarks of HDMI Licensing LLC in the United States and other countries.



CALIFORNIA, USA ONLY

The Lithium battery adopted on this motherboard contains Perchlorate, a toxic substance controlled in Perchlorate Best Management Practices (BMP) regulations passed by the California Legislature. When you discard the Lithium battery in California, USA, please follow the related regulations in advance.

“Perchlorate Material-special handling may apply, see www.dtsc.ca.gov/hazardouswaste/perchlorate”

AUSTRALIA ONLY

Our goods come with guarantees that cannot be excluded under the Australian Consumer Law. You are entitled to a replacement or refund for a major failure and compensation for any other reasonably foreseeable loss or damage caused by our goods. You are also entitled to have the goods repaired or replaced if the goods fail to be of acceptable quality and the failure does not amount to a major failure. If you require assistance please call ASRock Rack Tel : +886-2-55599600 ext.123 (Standard International call charges apply)



ASRock Rack INC. hereby declares that this device is in compliance with the essential requirements and other relevant provisions of related UKCA Directives. Full text of UKCA declaration of conformity is available at: <http://www.asrockrack.com>



ASRock Rack INC. hereby declares that this device is in compliance with the essential requirements and other relevant provisions of related Directives. Full text of EU declaration of conformity is available at: <http://www.asrockrack.com>

ASRock Rack follows the green design concept to design and manufacture our products, and makes sure that each stage of the product life cycle of ASRock Rack product is in line with global environmental regulations. In addition, ASRock Rack disclose the relevant information based on regulation requirements.

Please refer to <https://www.asrockrack.com/general/about.asp?cat=Responsibility> for information disclosure based on regulation requirements ASRock Rack is complied with:



DO NOT throw the motherboard in municipal waste. This product has been designed to enable proper reuse of parts and recycling. This symbol of the crossed out wheeled bin indicates that the product (electrical and electronic equipment) should not be placed in municipal waste. Check local regulations for disposal of electronic products.

Contents

Chapter 1 Introduction	1
1.1 Package Contents	1
1.2 Specifications	2
1.3 Unique Features	6
1.4 Motherboard Layout	7
1.5 Onboard LED Indicators	10
1.6 I/O Panel	12
1.7 Block Diagram	14
Chapter 2 Installation	17
2.1 Screw Holes	17
2.2 Pre-installation Precautions	17
2.3 Installing the CPU	18
2.4 Installing the CPU Fan and Heatsink	20
2.5 Installing Memory Modules (DIMM)	23
2.6 Expansion Slots (PCI Express Slots)	25
2.7 Jumpers Setup	27
2.8 Onboard Headers and Connectors	29
2.9 Dr. Debug	35
2.10 Unit Identification purpose LED/Switch	41
2.11 M.2 SSD Module Installation Guide (M2_1)	42
2.12 M.2 SSD Module Installation Guide (M2_2)	44
Chapter 3 UEFI Setup Utility	46
3.1 Introduction	46

3.1.1	UEFI Menu Bar	46
3.1.2	Navigation Keys	47
3.2	Main Screen	48
3.3	Advanced Screen	49
3.3.1	CPU Configuration	50
3.3.2	Chipset Configuration	51
3.3.3	Storage Configuration	53
3.3.4	ACPI Configuration	54
3.3.5	USB Configuration	55
3.3.6	Super IO Configuration	56
3.3.7	H/W Monitor	57
3.3.8	RAM Disk Configuration	58
3.3.9	Tls Auth Configuration	59
3.3.10	AMD PBS	60
3.3.11	AMD Overclocking	63
3.3.12	AMD CBS	64
3.3.13	Instant Flash	65
3.4	Server Mgmt	66
3.4.1	System Event Log	67
3.4.2	BMC Network Configuration	68
3.4.3	BMC Tools	70
3.5	Security	71
3.5.1	Key Management	72
3.6	Boot Screen	75

3.6.1	CSM Parameters	77
3.7	Exit Screen	79
Chapter 4 Software Support		80
4.1	Install Operating System	80
4.2	Support CD Information	80
4.2.1	Running The Support CD	80
4.2.2	Drivers Menu	80
4.2.3	Utilities Menu	80
4.2.4	Contact Information	80
Chapter 5 Troubleshooting		81
5.1	Troubleshooting Procedures	81
5.2	Technical Support Procedures	83
5.3	Returning Merchandise for Service	83

Chapter 1 Introduction

Thank you for purchasing ASRock Rack **X570D4U / X570D4U-2L2T / X570D4U-2L2T/BCM** motherboard, a reliable motherboard produced under ASRock Rack's consistently stringent quality control. It delivers excellent performance with robust design conforming to ASRock Rack's commitment to quality and endurance.

In this manual, chapter 1 and 2 contains introduction of the motherboard and step-by-step guide to the hardware installation. Chapter 3 and 4 contains the configuration guide to BIOS setup and information of the Software Support.



Because the motherboard specifications and the BIOS software might be updated, the content of this manual will be subject to change without notice. In case any modifications of this manual occur, the updated version will be available on ASRock Rack website without further notice. You may find the latest memory and CPU support lists on ASRock Rack website as well. ASRock Rack's Website: www.ASRockRack.com

*If you require technical support related to this motherboard, please visit our website for specific information about the model you are using.
<http://www.asrockrack.com/support/>*

1.1 Package Contents

- ASRock Rack X570D4U / X570D4U-2L2T / X570D4U-2L2T/BCM Motherboard (micro-ATX Form Factor: 9.6-in x 9.6-in, 24.4 cm x 24.4 cm)
- Quick Installation Guide
- 1 x I/O Shield
- 1 x SATA3 Cable (60cm)
- 2 x Screws for M.2 Sockets



If any items are missing or appear damaged, contact your authorized dealer.



The diagrams in this documentation are for reference only. The actual product may vary with models.

1.2 Specifications

X570D4U X570D4U-2L2T X570D4U-2L2T/BCM	
Physical Status	
Form Factor	Micro-ATX
Dimension	9.6" x 9.6" (244 mm x 244 mm)
Processor System	
CPU	AMD Ryzen™ 5000, 4000 and 3000 G-Series Desktop Processors with Radeon™ Graphics AMD Ryzen™ 5000 and 3000 Series Desktop Processors AMD Ryzen™ PRO 5000, 4000 and 3000 Series Desktop Processors
Socket	1 Socket AM4 (PGA 1331)
Thermal Design Power (TDP)	105W
Chipset	AMD X570
System Memory	
Supported DIMM Quantity	4 DIMM slots (2DPC)
Supported Type	DDR4 288-pin ECC*/non-ECC UDIMM
Max. Capacity per DIMM	32GB
Max. DIMM Frequency	3200 MHz**
Voltage	1.2V
Note	*For AMD Ryzen™ Desktop Processors with Radeon Graphics, ECC support is only with Processors with PRO technologies. **AMD Ryzen™ 3000 G-Series Desktop Processors with Radeon™ Graphics support up to 2666 MHz
Expansion Slot	
SLOT6	PCIe4.0 x16 [CPU]
SLOT5	PCIe4.0 x1 [FCH]
SLOT4	PCIe4.0 x8 [CPU]
Note	-SLOT6 auto-switch to PCIe4.0 x8 when SLOT4 occupied -SLOT6 supports PCIe3.0 only when installing AMD Ryzen™ 5000, 4000 G-Series Desktop Processors with Radeon™ Graphics -SLOT6 supports PCIe3.0 x8 only when installing AMD Ryzen™ 3000 G-Series Desktop Processors with Radeon™ Graphics -SLOT5 supports PCIe3.0 only when installing AMD Ryzen™ 5000, 4000 and 3000 G-Series Desktop Processors with Radeon™ Graphics -SLOT4 supports PCIe3.0 only when installing AMD Ryzen™ 5000, 4000 G-Series Desktop Processors with Radeon™ Graphics -SLOT4 will not function when installing AMD Ryzen™ 3000 G-Series Desktop Processors with Radeon™ Graphics"

Other PCIe Expansion Connectors	
M.2 slot	1 M-key (PCIe4.0 x4 or SATA 6Gb/s); support 22110/2280/2260/2242 form factor [CPU] 1 M-key (PCIe4.0 x4 or SATA 6Gb/s); support 2280/2260/2242 form factor [FCH]
Note	-M.2 supports PCIe3.0 only when installing AMD Ryzen™ 5000, 4000 and 3000 G-Series Desktop Processors with Radeon™ Graphics
SATA/SAS Storage	
FCH Built-in Storage	AMD X570 (Up to 10 SATA 6Gb/s): 7 SATA 7-pin, 1 SATA DOM, 2 M.2
Ethernet	
Additional Ethernet Controller	X570D4U: Intel® i210: 2 RJ45 (1GbE) X570D4U-2L2T: Intel® X550-AT2: 2 RJ45 (10GbE) Intel® i210: 2 RJ45 (1GbE) X570D4U-2L2T/BCM: Broadcom BCM57416: 2 RJ45 (10GbE) Intel® i210: 2 RJ45 (1GbE)
USB	
Controller/Hub	AMD X570
Connectors/headers	External: 2 Type-A (USB3.2 Gen2) Internal: 1 header (19-pin, 2 USB3.2 Gen1)
Graphics	
Controller	ASPEED AST2500: 1 DB15 (VGA), 1 (15-pin) header AMD Ryzen™ desktop processors with Radeon™ Graphics: 1 HDMI
Security	
TPM	1 (17-pin, LPC), 1 (13-pin, SPI)
Rear I/O	
UID button/LED	1 UID button w/ LED
Video output	1 DB15 (VGA), 1 HDMI
Serial port	1 DB9 (COM)
USB	2 Type-A (USB3.2 Gen2)
RJ45	X570D4U: 2 RJ45 (1GbE), 1 dedicated IPMI X570D4U-2L2T / X570D4U-2L2T/BCM: 2 RJ45 (10GbE), 2 RJ45 (1GbE), 1 dedicated IPMI
Note:	-HDMI is only supported by AMD Ryzen™ with Radeon™ Graphics Processors

Hardware Monitor	
Temperature	CPU, FCH, DDR, MB, Card Side, LAN Temperature sensing
Fan	Fan Tachometer Quiet Fan (Allow Chassis Fan Speed Auto-Adjust by CPU Temperature) Fan Multi-Speed Control"
Voltage	3VSB, 5VSB, VCPU, VSOC, VCCM, APU VDDP, PM VDD CLDO, PM VDDCR S5, PM VDDCR, BAT, 3V, 5V, 12V
Server Management	
BMC Controller	ASPEED AST2500: IPMI2.0 with iKVM and vMedia support
IPMI Dedicated GLAN	1 Realtek RTL8211E for dedicated management GLAN
System BIOS	
BIOS type	32MB AMI UEFI Legal BIOS
Features	Plug and Play, ACPI 2.0 compliance wake up events, SMBIOS 2.8, ASRock Rack instant flash
Internal Connectors/Headers	
PSU connector	1 (24-pin, ATX main power), 1 (8-pin, ATX 12V)
Auxiliary panel header	1 (includes chassis intrusion, location button & LED, front LAN LED, system fault, and BMC alert)
System panel header	1 (RST, PWRBTN, HDDLED, PWRLED)
LAN3/LAN4 LED header	X570D4U: N/A X570D4U-2L2T / X570D4U-2L2T/BCM: 1
VGA header	1
Speaker header	1 (4-pin)
Fan header	3 (6-pin), 3 (4-pin)
Thermal sensor header	1
Buzzer	1
TPM header	1 (17-pin, LPC), 1 (13-pin, SPI)
SMBus header	1
PMbus header	1
IPMB header	1
Clear CMOS	1 (contact pads)
LED Indicators	
Standby Power LED	1 (5VSB)
80 debug port LED	1
Fan Fail LED	6
BMC Heartbeat LED	1

Support OS	
OS	<p>Microsoft® Windows®: Windows 10 (64 bit)</p> <p>Linux®: - Ubuntu 18.04 (64 bit) - RedHat Enterprise Linux Server 8.1 (64bit)</p> <p><i>* Please refer to our website for the latest OS support list. * The Linux system doesn't support Raid mode. * Supports UEFI BOOT only.</i></p>
Enviroment	
Operating temperature	10 - 35°C (50 - 95 degF)
Non-operating temperature	-40 - 70°C (-40 - 158degF)

NOTE: Please refer to our website for the latest specifications.



This motherboard supports Wake from on Board LAN. To use this function, please make sure that the "Wake on Magic Packet from power off state" is enabled in Device Manager > Intel® Ethernet Connection > Power Management. And the "PCI Devices Power On" is enabled in UEFI SETUP UTILITY > Advanced > ACPI Configuration. After that, onboard LAN3&4 can wake up S5 under OS.



If you install Intel® LAN utility or Marvell SATA utility, this motherboard may fail Windows® Hardware Quality Lab (WHQL) certification tests. If you install the drivers only, it will pass the WHQL tests.

1.3 Unique Features

ASRock Rack Instant Flash is a BIOS flash utility embedded in Flash ROM. This convenient BIOS update tool allows you to update system BIOS without entering operating systems first like MS-DOS or Windows. With this utility, you can press the <F6> key during the POST or the <F2> key to enter into the BIOS setup menu to access ASRock Rack Instant Flash. Just launch this tool and save the new BIOS file to your USB flash drive, floppy disk or hard drive, then you can update your BIOS only in a few clicks without preparing an additional floppy diskette or other complicated flash utility. Please be noted that the USB flash drive or hard drive must use FAT32/16/12 file system.

1.4 Motherboard Layout

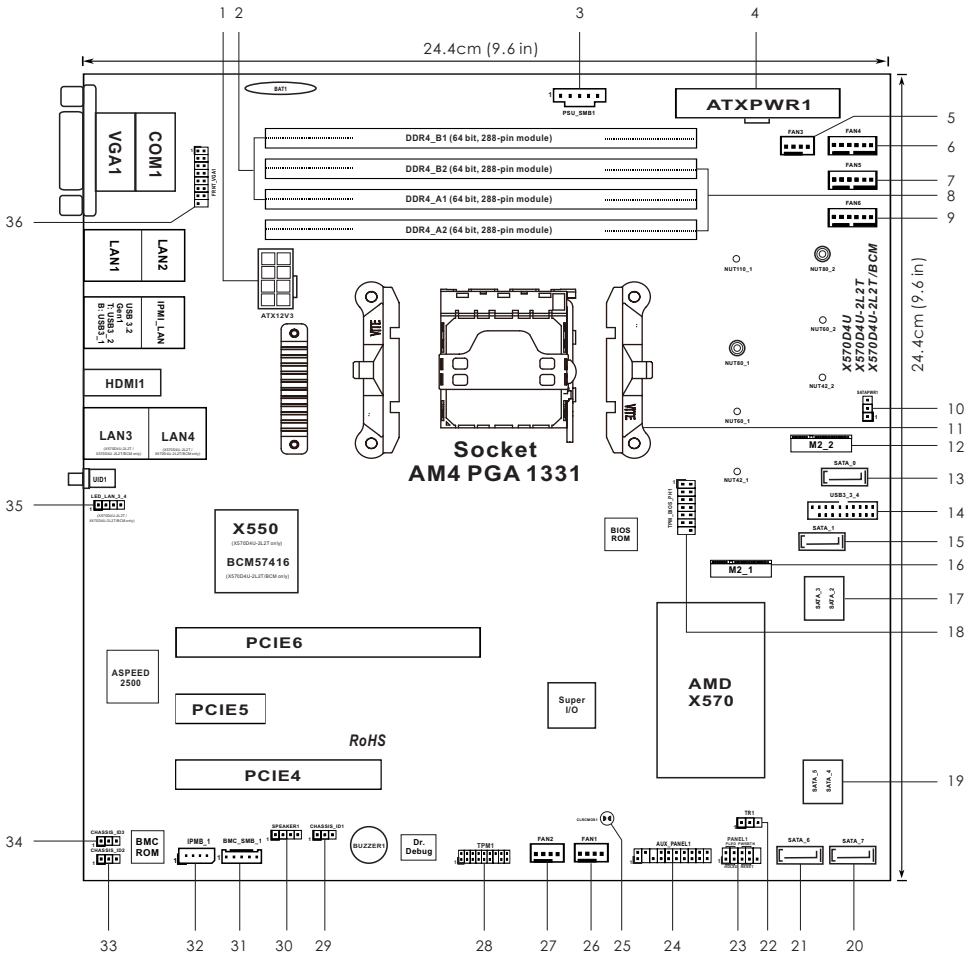

No.	Description
1	ATX 12V Power Connector (ATX12V3)
2	2 x 288-pin DDR4 DIMM Slots (DDR4_A1, DDR4_B1, Blue)*
3	PSU SMBus Header (PSU_SMB1)
4	ATX Power Connector (ATXPWR1)
5	System Fan Connector (4-pin) (FAN3)
6	System Fan Connector (6-pin) (FAN4)
7	System Fan Connector (6-pin) (FAN5)
8	2 x 288-pin DDR4 DIMM Slots (DDR4_A2, DDR4_B2, White)*
9	System Fan Connector (6-pin) (FAN6)
10	SATA DOM Power Connector (SATAPWR1)
11	AM4 PGA 1331 Socket
12	M.2 Socket (M2_2) (Type 2242 / 2260 / 2280) [from FCH]
13	SATA3 DOM Connector (SATA_0), Red
14	USB 3.2 Gen1 Header (USB3_3_4)
15	SATA3 Connector (SATA_1)
16	M.2 Socket (M2_1) (Type 2242 / 2260 / 2280 / 22110) [from CPU]
17	SATA3 Connector (SATA_3)(Upper), SATA3 Connector (SATA_2)(Lower)
18	TPM-SPI Header (TPM_BIOS_PH1)
19	SATA3 Connector (SATA_5)(Upper), SATA3 Connector (SATA_4)(Lower)
20	SATA3 Connector (SATA_7)
21	SATA3 Connector (SATA_6)
22	Thermal Sensor Header (TR1)
23	System Panel Header (PANEL1)
24	Auxiliary Panel Header (AUX_PANEL1)
25	Clear CMOS Pad (CLRMOSE1)
26	System Fan Connector (4-pin) (FAN1)
27	System Fan Connector (4-pin) (FAN2)
28	TPM Header (TPM1)
29	Chassis ID1 Jumper (CHASSIS_ID1) <i>(Reserved for BOM option)</i>
30	Speaker Header (SPEAKER1)
31	BMC SMBus Header (BMC_SMB_1)
32	Intelligent Platform Management Bus Header (IPMB_1)
33	Chassis ID2 Jumper (CHASSIS_ID2) <i>(Reserved for BOM option)</i>

No.	Description
34	Chassis ID3 Jumper (CHASSIS_ID3) <i>(Reserved for BOM option)</i>
35	Front LAN LED Connector (LED_LAN_3_4) <i>(X570D4U-2L2T / X570D4U-2L2T/BCM only)</i>
36	Front VGA Header (FRNT_VGA1)

**For DIMM installation and configuration instructions, please see p.21 (Installation of Memory Modules (DIMM)) for more details.*

1.5 Onboard LED Indicators

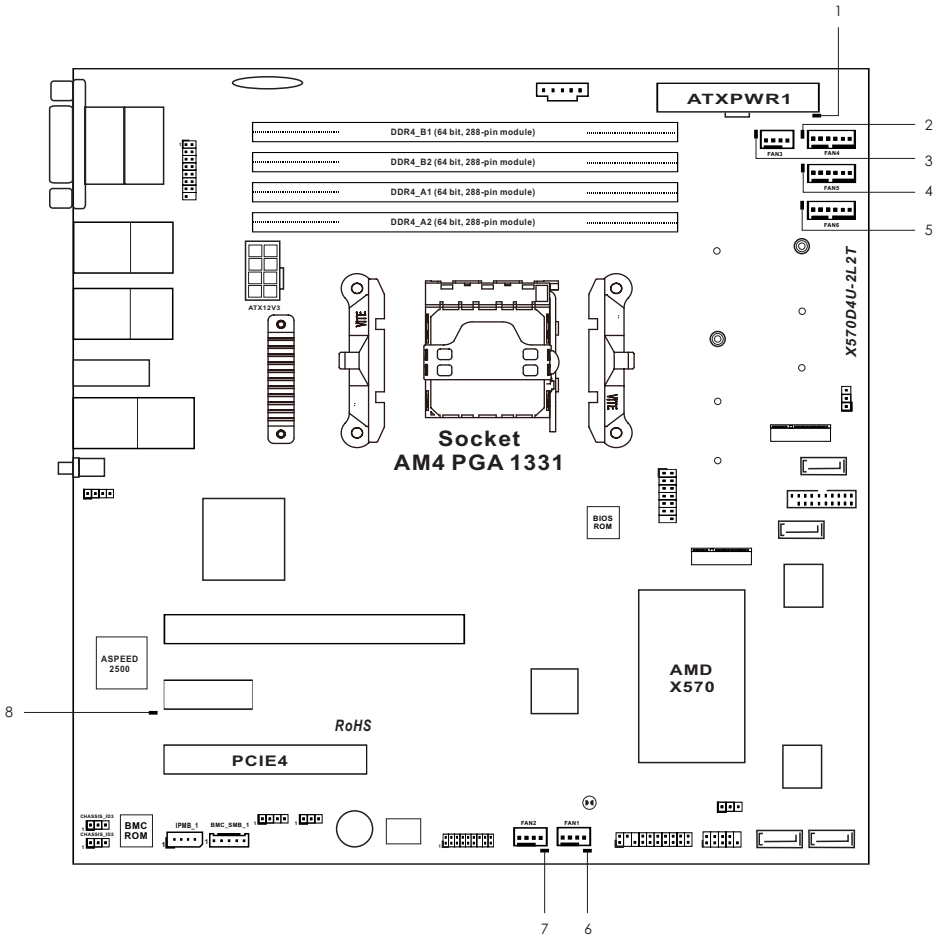

No.	Item	Status	Description
1	SB_PWR1	Green	STB PWR ready
2	FAN_LED3	Amber	FAN3 failed
3	FAN_LED4	Amber	FAN4 failed
4	FAN_LED5	Amber	FAN5 failed
5	FAN_LED6	Amber	FAN6 failed
6	FAN_LED1	Amber	FAN1 failed
7	FAN_LED2	Amber	FAN2 failed
8	BMC_LED1	Green	BMC heartbeat LED

1.6 I/O Panel

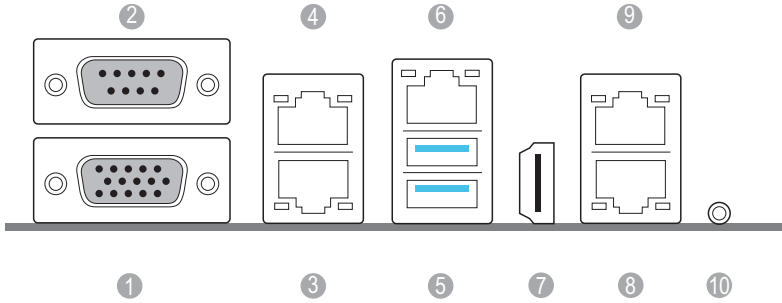

No.	Description	No.	Description
1	VGA Port (VGA1)	6	LAN RJ-45 Port (IPMI_LAN1)*
2	Serial Port (COM1)	7	HDMI Port
3	1G LAN RJ-45 Port (LAN1)	8	10G LAN RJ-45 Port (LAN3)** <i>(X570D4U-2L2T / X570D4U-2L2T/BCM only)</i>
4	1G LAN RJ-45 Port (LAN2)	9	10G LAN RJ-45 Port (LAN4)** <i>(X570D4U-2L2T / X570D4U-2L2T/BCM only)</i>
5	USB 3.2 Gen2 Ports (USB3_1_2)	10	UID Switch (UID1)

*There are two LED next to the LAN port. Please refer to the table below for the LAN port LED indications.

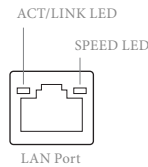

Dedicated IPMI LAN Port LED Indications

Activity / Link LED		Speed LED	
Status	Description	Status	Description
Off	No Link	Off	10M bps connection or no link
Blinking Yellow	Data Activity	Yellow	100M bps connection
On	Link	Green	1Gbps connection

**There are two LEDs on each LAN port. Please refer to the table below for the LAN port LED indications.

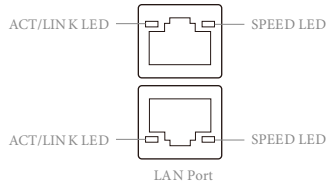

10G LAN Port (LAN3, LAN4) LED Indications (*X570D4U-2L2T / X570D4U-2L2T/BCM only*)

Activity / Link LED		Speed LED	
Status	Description	Status	Description
Off	No Link	Off	10M/100Mbps connection or no link
Blinking Yellow	Data Activity	Orange	1Gbps connection
On	Link	Green	10Gbps connection

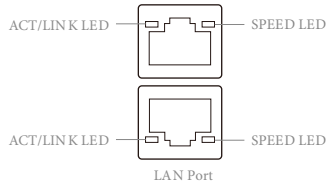

1G LAN Port (LAN1, LAN2) LED Indications

Activity / Link LED		Speed LED	
Status	Description	Status	Description
Off	No Link	Off	10Mbps connection or no link
Blinking Orange	Data Activity	Yellow	100Mbps connection
On	Link	Green	1Gbps connection

1.7 Block Diagram

X570D4U:

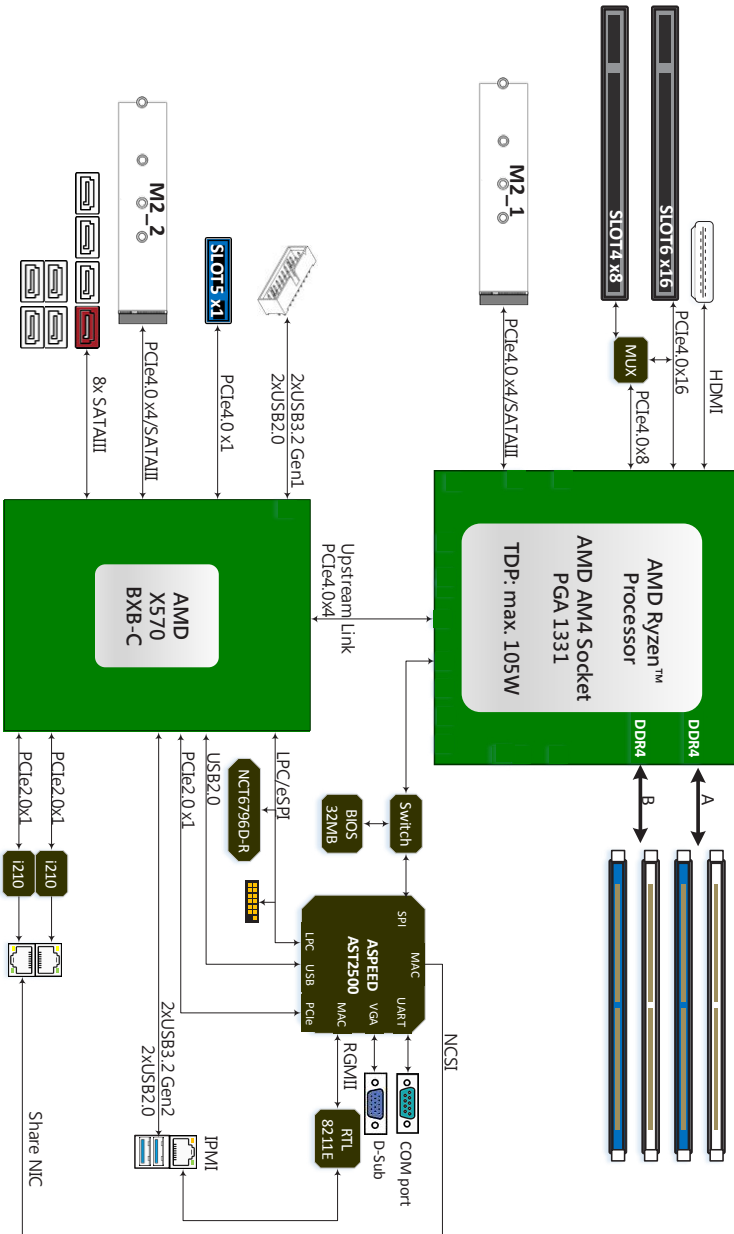

X570D4U-2L2T:

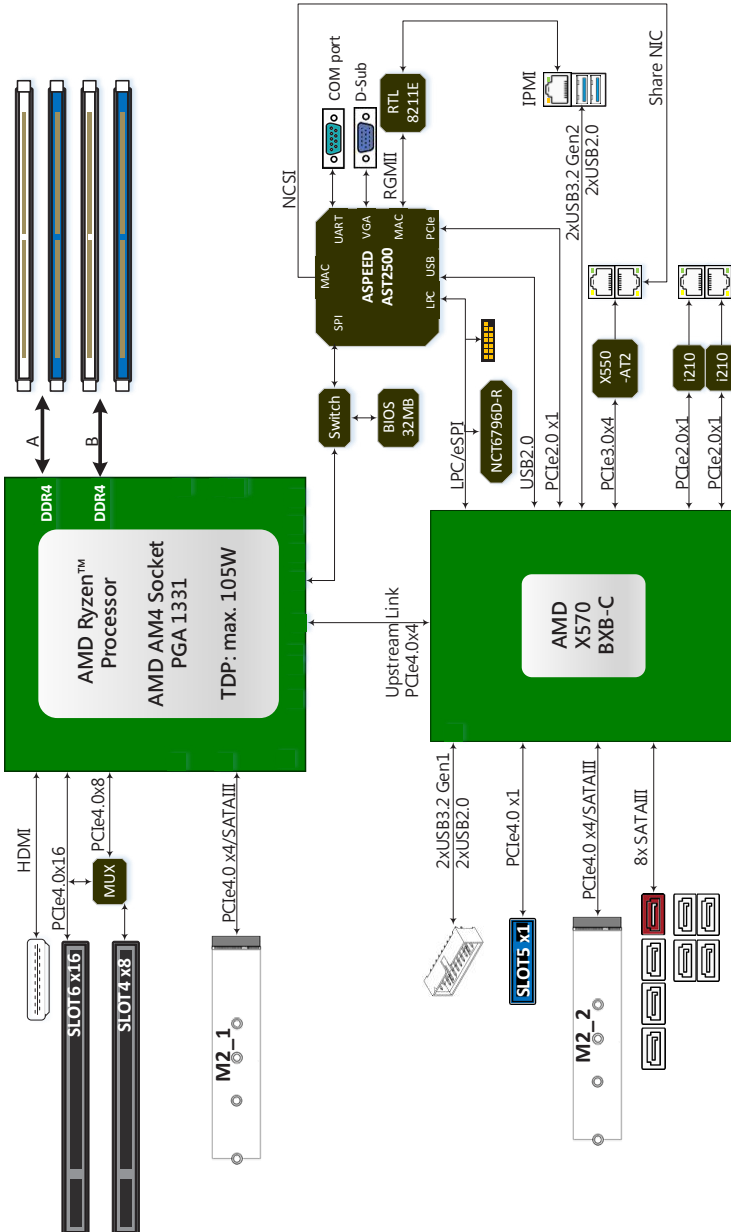

X570D4U-2L2T/BCM

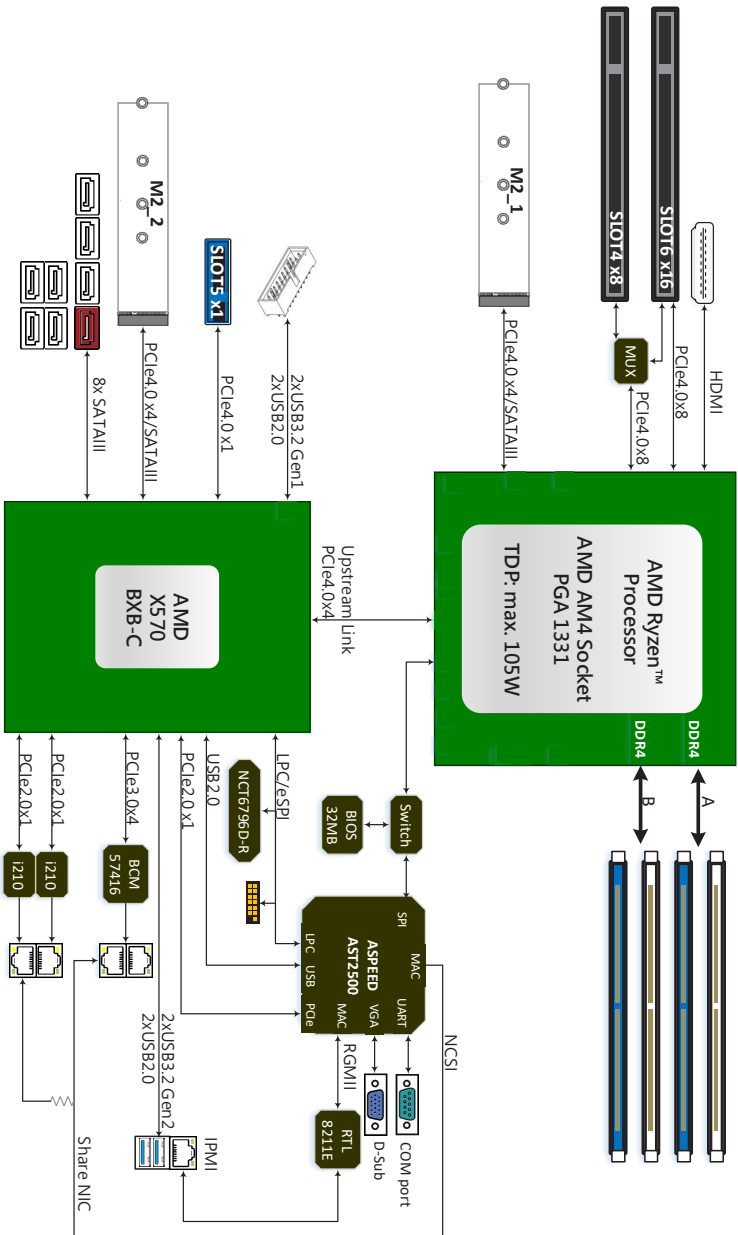

Chapter 2 Installation

This is a micro-ATX form factor (9.6" x 9.6", 24.4 cm x 24.4 cm) motherboard. Before you install the motherboard, study the configuration of your chassis to ensure that the motherboard fits into it.



Make sure to unplug the power cord before installing or removing the motherboard. Failure to do so may cause physical injuries to you and damages to motherboard components.

2.1 Screw Holes

Place screws into the holes indicated by circles to secure the motherboard to the chassis.



Attention! Before installing this motherboard, be sure to unscrew and remove the standoffs at the marked location, under the motherboard, from the chassis, in order to avoid electrical short circuit and damage to your motherboard.



Do not over-tighten the screws! Doing so may damage the motherboard.

2.2 Pre-installation Precautions

Take note of the following precautions before you install motherboard components or change any motherboard settings.

1. Unplug the power cord from the wall socket before touching any components.
2. To avoid damaging the motherboard's components due to static electricity, NEVER place your motherboard directly on the carpet or the like. Also remember to use a grounded wrist strap or touch a safety grounded object before you handle the components.
3. Hold components by the edges and do not touch the ICs.
4. Whenever you uninstall any component, place it on a grounded anti-static pad or in the bag that comes with the component.
5. When placing screws into the screw holes to secure the motherboard to the chassis, please do not over-tighten the screws! Doing so may damage the motherboard.



Before you install or remove any component, ensure that the power is switched off or the power cord is detached from the power supply. Failure to do so may cause severe damage to the motherboard, peripherals, and/or components.

2.3 Installing the CPU



Unplug all power cables before installing the CPU.

1

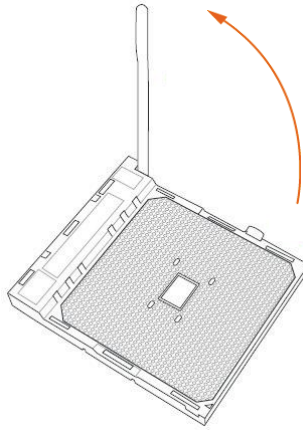

2

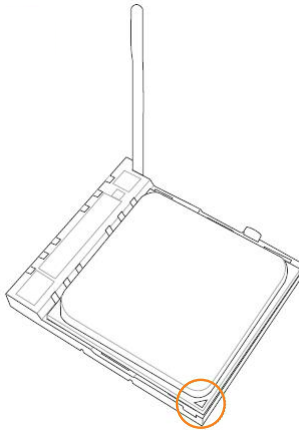

3



2.4 Installing the CPU Fan and Heatsink

After you install the CPU into this motherboard, it is necessary to install a larger heatsink and cooling fan to dissipate heat. You also need to spray thermal grease between the CPU and the heatsink to improve heat dissipation. Make sure that the CPU and the heatsink are securely fastened and in good contact with each other.



*Please be aware of the maximum dimensions of the heatsink to be used is 116 * 83.65mm.*



1. Please turn off the power or remove the power cord before changing a CPU or heat-sink.
2. Please turn off the power or remove the power cord when overheating occurs with the Renoir processor.

Installing the CPU Box Cooler SR1

1

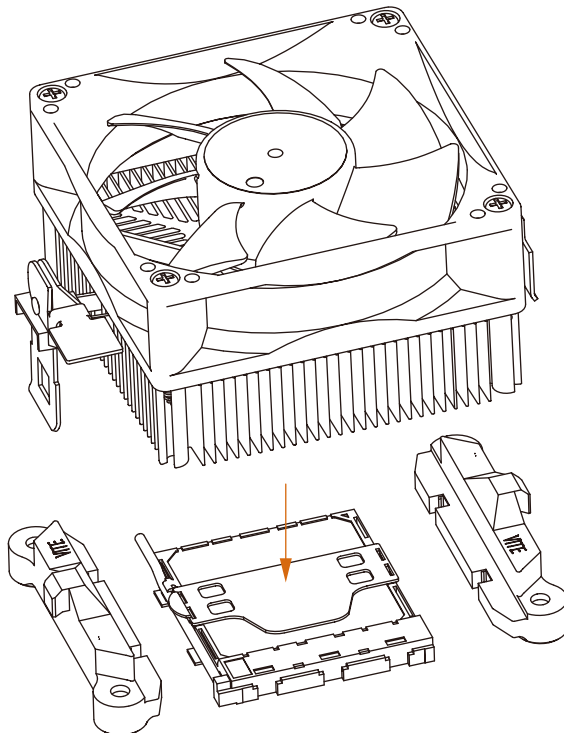

2

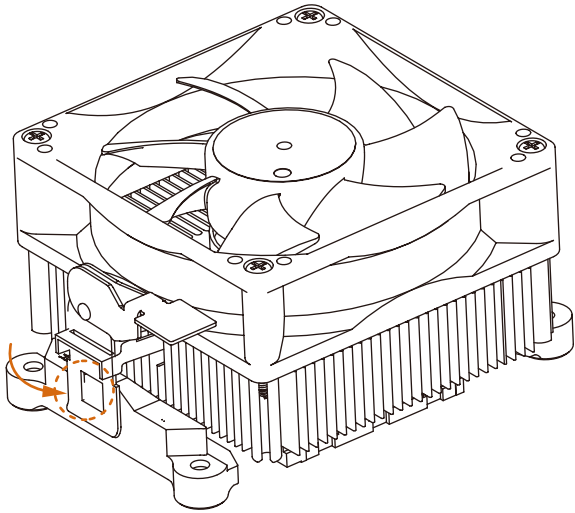

3

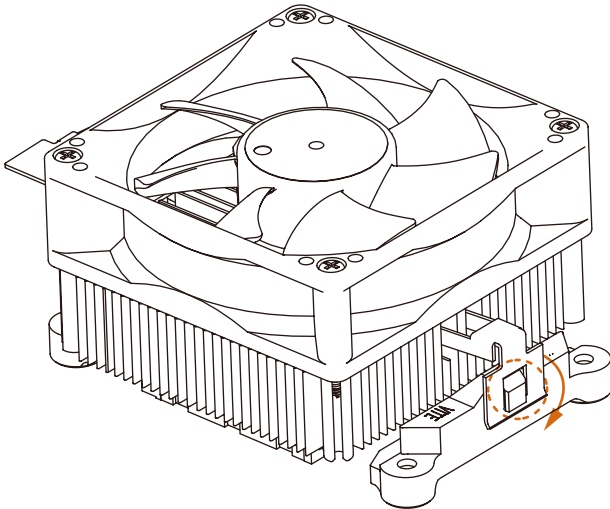

4

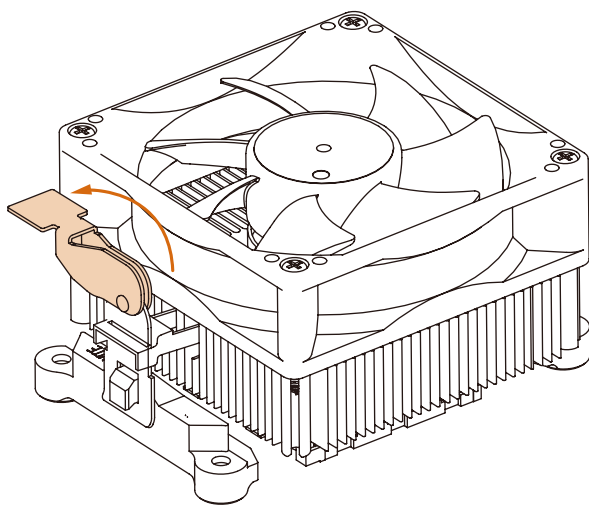

2.5 Installing Memory Modules (DIMM)

This motherboard provides four 288-pin DDR4 (Double Data Rate 4) DIMM slots, and supports Dual Channel Memory Technology.



1. For dual channel configuration, you always need to install identical (the same brand, speed, size and chip-type) DDR4 DIMM pairs.
2. It is unable to activate Dual Channel Memory Technology with only one or three memory module installed.
3. It is not allowed to install a DDR, DDR2 or DDR3 memory module into a DDR4 slot; otherwise, this motherboard and DIMM may be damaged.

DDR4 DIMM Maximum Frequency Support

U-DIMM Memory Slot				Picasso	Matisse	Renoir	Vermeer
A2	A1	B2	B1	Freq (Mhz)	Freq (Mhz)	Freq (Mhz)	Freq (Mhz)
-	SR	-	-	2666	3200	3200	3200
-	DR	-	-	2400	3200	3200	3200
-	SR	-	SR	2666	3200	3200	3200
-	DR	-	DR	2400	3200	3200	3200
SR	SR	SR	SR	2133	2933	2933	2933
DR	DR	DR	DR	1866	2666	2666	2666

1

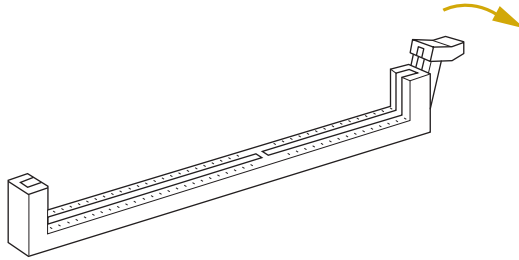

2

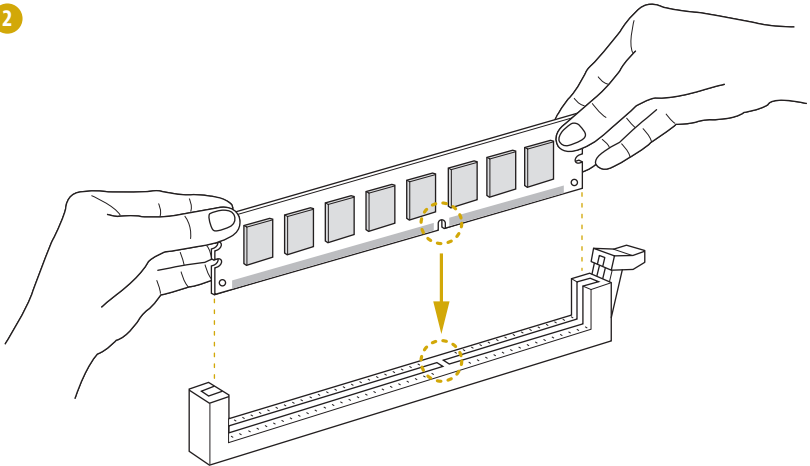

3

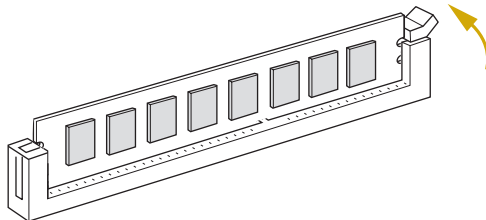

The DIMM only fits in one correct orientation. It will cause permanent damage to the motherboard and the DIMM if you force the DIMM into the slot at incorrect orientation.

2.6 Expansion Slots (PCI Express Slots)

There are 3 PCI Express slots on this motherboard.

PCIe slot:

Matisse:

PCIE4 (PCIe 4.0 x8 slot, from CPU) is used for PCI Express x8 lane width cards.

PCIE5 (PCIe 4.0 x1 slot, from Premium) is used for PCI Express x1 lane width cards.

PCIE6 (PCIe 4.0 x16 slot, from CPU) is used for PCI Express x16 lane width cards.

Slot	Generation	Mechanical	Electrical	Source
PCIE6	4.0	x16	x16	CPU
PCIE5	4.0	x1	x1	Premium
PCIE4	4.0	x8	x8	CPU

PCIe Slot Configurations

	PCIE4	PCIE6
Single PCIe Card	N/A	x16
Two PCIe Cards	x8	x8

Picasso:

PCIE4 is not supported.

PCIE5 (PCIe 3.0 x1 slot, from Premium) is used for PCI Express x1 lane width cards.

PCIE6 (PCIe 3.0 x16 slot, from CPU) is used for PCI Express x8 lane width cards.

Slot	Generation	Mechanical	Electrical	Source
PCIE6	3.0	x16	x8	CPU
PCIE5	3.0	x1	x1	Premium
PCIE4	N/A	x8	N/A	N/A

Installing an expansion card

- Step 1. Before installing an expansion card, please make sure that the power supply is switched off or the power cord is unplugged. Please read the documentation of the expansion card and make necessary hardware settings for the card before you start the installation.
- Step 2. Remove the system unit cover (if your motherboard is already installed in a chassis).
- Step 3. Remove the bracket facing the slot that you intend to use. Keep the screws for later use.
- Step 4. Align the card connector with the slot and press firmly until the card is completely seated on the slot.
- Step 5. Fasten the card to the chassis with screws.
- Step 6. Replace the system cover.

2.7 Jumpers Setup

The illustration shows how jumpers are setup. When the jumper cap is placed on the pins, the jumper is “Short”. If no jumper cap is placed on the pins, the jumper is “Open”. The illustration shows a 3-pin jumper whose pin1 and pin2 are “Short” when a jumper cap is placed on these 2 pins.

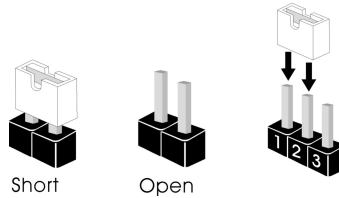

Reserved for BOM options:

Chassis ID1 Jumper
(3-pin CHASSIS_ID1)
(see p.7, No. 29)



Chassis ID2 Jumper
(3-pin CHASSIS_ID2)
(see p.7, No. 33)



Chassis ID3 Jumper
(3-pin CHASSIS_ID3)
(see p.7, No. 34)



Board Level SKU (Default)

Reserved for system level use

Reserved for BOM options:

Chassis ID1 Jumper
(3-pin CHASSIS_ID1)
(see p.7, No. 29)



Chassis ID2 Jumper
(3-pin CHASSIS_ID2)
(see p.7, No. 33)















Chassis ID3 Jumper
(3-pin CHASSIS_ID3)
(see p.7, No. 34)



Reserved for system level use

Reserved for system level use

<i>Reserved for BOM options:</i>		
Chassis ID1 Jumper (3-pin CHASSIS_ID1) (see p.7, No. 29)		
Chassis ID2 Jumper (3-pin CHASSIS_ID2) (see p.7, No. 33)		
Chassis ID3 Jumper (3-pin CHASSIS_ID3) (see p.7, No. 34)	Reserved for system level use	Reserved for system level use

<i>Reserved for BOM options:</i>		
Chassis ID1 Jumper (3-pin CHASSIS_ID1) (see p.7, No. 29)		
Chassis ID2 Jumper (3-pin CHASSIS_ID2) (see p.7, No. 33)		
Chassis ID3 Jumper (3-pin CHASSIS_ID3) (see p.7, No. 34)	Reserved for system level use	Reserved for system level use

2.8 Onboard Headers and Connectors



Onboard headers and connectors are NOT jumpers. Do NOT place jumper caps over these headers and connectors. Placing jumper caps over the headers and connectors will cause permanent damage to the motherboard.

System Panel Header
(9-pin PANEL1)
(see p.7, No. 23)

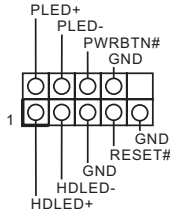

Connect the power switch, reset switch and system status indicator on the chassis to this header according to the pin assignments. Particularly note the positive and negative pins before connecting the cables.



PWRBTN (Power Switch):

Connect to the power switch on the chassis front panel. You may configure the way to turn off your system using the power switch.

RESET (Reset Switch):

Connect to the reset switch on the chassis front panel. Press the reset switch to restart the computer if the computer freezes and fails to perform a normal restart.

PLED (System Power LED):

Connect to the power status indicator on the chassis front panel. The LED is on when the system is operating. The LED is off when the system is in S4 sleep state or powered off (S5).

HDLED (Hard Drive Activity LED):

Connect to the hard drive activity LED on the chassis front panel. The LED is on when the hard drive is reading or writing data.

The front panel design may differ by chassis. A front panel module mainly consists of power switch, reset switch, power LED, hard drive activity LED, speaker and etc. When connecting your chassis front panel module to this header, make sure the wire assignments and the pin assignments are matched correctly.

Auxiliary Panel Header
(18-pin AUX_PANEL1)
(see p.7, No. 24)

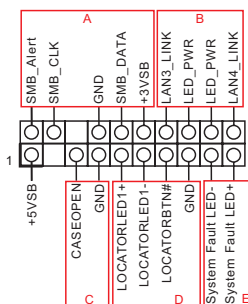

This header supports multiple functions on the front panel, including the front panel SMB, internet status indicator and chassis intrusion pin.



A. Front panel SMBus connecting pin (6-1 pin FPSMB)

This header allows you to connect SMBus (System Management Bus) equipment. It can be used for communication between peripheral equipment in the system, which has slower transmission rates, and power management equipment.

B. Internet status indicator (2-pin LAN3_LED, LAN4_LED)

These two 2-pin headers allow you to use the Gigabit internet indicator cable to connect to the LAN status indicator. When this indicator flickers, it means that the internet is properly connected.

C. Chassis intrusion pin (2-pin CHASSIS)

This header is provided for host computer chassis with chassis intrusion detection designs. In addition, it must also work with external detection equipment, such as a chassis intrusion detection sensor or a microswitch. When this function is activated, if any chassis component movement occurs, the sensor will immediately detect it and send a signal to this header, and the system will then record this chassis intrusion event. The default setting is set to the CASEOPEN and GND pin; this function is off.

D. Locator LED (4-pin LOCATOR)

This header is for the locator switch and LED on the front panel.

E. System Fault LED (2-pin LOCATOR)

This header is for the Fault LED on the system.

Serial ATA3 DOM Connector
(SATA_0)
(see p.7, No. 13)



The SATA3 DOM connector supports both a SATA DOM (Disk-On-Module) and a SATA data cable for internal storage device.

Serial ATA3 Connectors

Vertical:

- (SATA_0:
see p.7, No. 13)
- (SATA_1:
see p.7, No. 15)
- (SATA_6:
see p.7, No. 21)
- (SATA_7:
see p.7, No. 20)



These connectors support SATA data cables for internal storage devices with up to 6.0 Gb/s data transfer rate.

Right Angle:

- (SATA_2:
see p.7, No. 17)(Lower)
- (SATA_3:
see p.7, No. 17)(Upper)
- (SATA_4:
see p.7, No. 19)(Lower)
- (SATA_5:
see p.7, No. 19)(Upper)

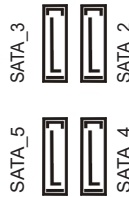

USB 3.2 Gen1 Header

- (19-pin USB3_3_4)
- (see p.7, No. 14)

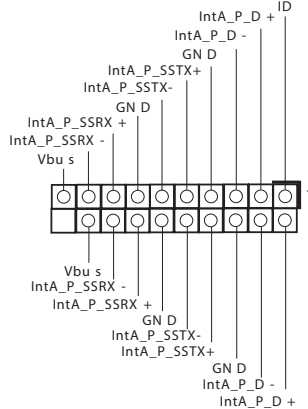

There is one USB 3.2 Gen1 header on this motherboard. This USB 3.2 Gen1 header can support two USB 3.2 Gen1 ports.

System Fan Connectors

- (4-pin FAN1)
(see p.7, No. 26)
- (4-pin FAN2)
(see p.7, No. 27)
- (4-pin FAN3)
(see p.7, No. 5)

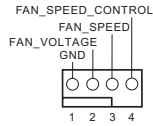

Please connect fan cables to the fan connectors and match the black wire to the ground pin. All fans support Fan Control.

- (6-pin FAN4)
(see p.7, No. 6)
- (6-pin FAN5)
(see p.7, No. 7)
- (6-pin FAN6)
(see p.7, No. 9)

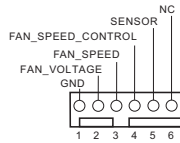

ATX Power Connector

- (24-pin ATXPWR1)
(see p.7, No. 4)

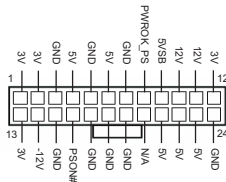

This motherboard provides a 24-pin ATX power connector. To use a 20-pin ATX power supply, please plug it along Pin 1 and Pin 13.

ATX 12V Power Connectors

- (8-pin ATX12V3)
(see p.7, No. 1)

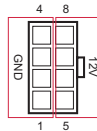

This motherboard provides one 8-pin ATX 12V power connector.

-
- TPM Header
(17-pin TPM1)
(see p.7, No. 28)

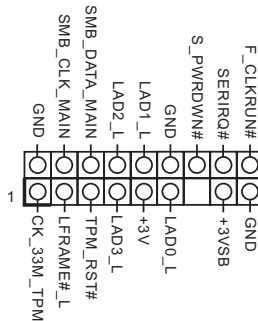

This connector supports Trusted Platform Module (TPM) system, which can securely store keys, digital certificates, passwords, and data. A TPM system also helps enhance network security, protects digital identities, and ensures platform integrity.

PSU SMBus Header
(5-pin PSU_SMB1)
(see p.7, No. 3)

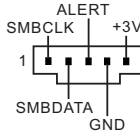

PSU SMBus monitors the status of the power supply, fan and system temperature.

Intelligent Platform
Management Bus Header
(4-pin IPMB_1)
(see p.7, No. 32)

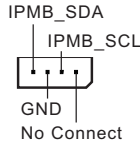

This 4-pin connector is used to provide a cabled base-board or front panel connection for value added features and 3rd-party add-in cards, such as Emergency Management cards, that provide management features using the IPMB.

Baseboard Management
Controller SMBus Header
(5-pin BMC_SMB_1)
(see p.7, No. 31)

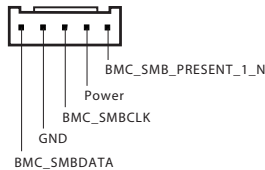

The header is used for the SMBUS devices.

Chassis Speaker Header
(4-pin SPEAKER1)
(see p.7, No. 30)

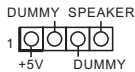

Please connect the chassis speaker to this header.

SATA DOM Power
Connector
(3-pin SATAPWR1)
(see p.7, No. 10)

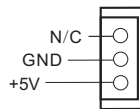

Please connect the power cable on the SATA DOM to this connector.

SPI TPM Header
(13-pin TPM_BIOS_PH1)
(see p.7, No. 18)

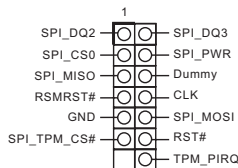

This connector supports SPI Trusted Platform Module (TPM) system, which can securely store keys, digital certificates, passwords, and data. A TPM system also helps enhance network security, protects digital identities, and ensures platform integrity.

Thermal Sensor Header
(3-pin TR1)
(see p.7, No. 22)

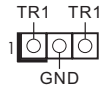

Please connect the thermal sensor cable to either pin 1-2 or pin 2-3 and the other end to the device which you wish to monitor its temperature.

Front VGA Header
(15-pin FRNT_VGA1)
(see p.7, No. 36)

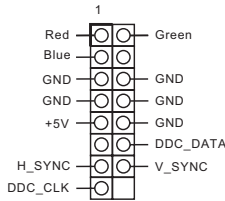

Please connect either end of VGA_2X8 cable to VGA header.

Front LAN LED
Connector
(LED_LAN_3_4)
(see p.7, No. 35)

*(X570D4U-2L2T /
X570D4U-2L2T/BCM only)*

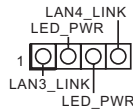

This 4-pin connector is used for the front LAN status indicator.

Clear CMOS Pad
(CLRCMOS1)
(see p.7, No. 25)



This allows you to clear the data in CMOS. To clear CMOS, take out the CMOS battery and short the Clear CMOS Pad.

2.9 Dr. Debug

Dr. Debug is used to provide code information, which makes troubleshooting even easier. Please see the diagrams below for reading the Dr. Debug codes.

Code	Description
0x10	PEI_CORE_STARTED
0x11	PEI_CAR_CPU_INIT
0x15	PEI_CAR_NB_INIT
0x19	PEI_CAR_SB_INIT
0x31	PEI_MEMORY_INSTALLED
0x32	PEI_CPU_INIT
0x33	PEI_CPU_CACHE_INIT
0x34	PEI_CPU_AP_INIT
0x35	PEI_CPU_BSP_SELECT
0x36	PEI_CPU_SMM_INIT
0x37	PEI_MEM_NB_INIT
0x3B	PEI_MEM_SB_INIT
0x4F	PEI_DXE_IPL_STARTED
0x60	DXE_CORE_STARTED
0x61	DXE_NVRAM_INIT
0x62	DXE_SBRUN_INIT

0x63	DXE_CPU_INIT
0x68	DXE_NB_HB_INIT
0x69	DXE_NB_INIT
0x6A	DXE_NB_SMM_INIT
0x70	DXE_SB_INIT
0x71	DXE_SB_SMM_INIT
0x72	DXE_SB_DEVICES_INIT
0x78	DXE_ACPI_INIT
0x79	DXE_CSM_INIT
0x90	DXE_BDS_STARTED
0x91	DXE_BDS_CONNECT_DRIVERS
0x92	DXE_PCI_BUS_BEGIN
0x93	DXE_PCI_BUS_HPC_INIT
0x94	DXE_PCI_BUS_ENUM
0x95	DXE_PCI_BUS_REQUEST_RESOURCES
0x96	DXE_PCI_BUS_ASSIGN_RESOURCES
0x97	DXE_CON_OUT_CONNECT
0x98	DXE_CON_IN_CONNECT

0x99	DXE_SIO_INIT
0x9A	DXE_USB_BEGIN
0x9B	DXE_USB_RESET
0x9C	DXE_USB_DETECT
0x9D	DXE_USB_ENABLE
0xA0	DXE_IDE_BEGIN
0xA1	DXE_IDE_RESET
0xA2	DXE_IDE_DETECT
0xA3	DXE_IDE_ENABLE
0xA4	DXE_SCSI_BEGIN
0xA5	DXE_SCSI_RESET
0xA6	DXE_SCSI_DETECT
0xA7	DXE_SCSI_ENABLE
0xA8	DXE_SETUP_VERIFYING_PASSWORD
0xA9	DXE_SETUP_START
0xAB	DXE_SETUP_INPUT_WAIT
0xAD	DXE_READY_TO_BOOT
0xAE	DXE_LEGACY_BOOT

0xAF	DXE_EXIT_BOOT_SERVICES
0xB0	RT_SET_VIRTUAL_ADDRESS_MAP_BEGIN
0xB1	RT_SET_VIRTUAL_ADDRESS_MAP_END
0xB2	DXE_LEGACY_OPROM_INIT
0xB3	DXE_RESET_SYSTEM
0xB4	DXE_USB_HOTPLUG
0xB5	DXE_PCI_BUS_HOTPLUG
0xB6	DXE_NVRAM_CLEANUP
0xB7	DXE_CONFIGURATION_RESET
0xF0	PEI_RECOVERY_AUTO
0xF1	PEI_RECOVERY_USER
0xF2	PEI_RECOVERY_STARTED
0xF3	PEI_RECOVERY_CAPSULE_FOUND
0xF4	PEI_RECOVERY_CAPSULE_LOADED
0xE0	PEI_S3_STARTED
0xE1	PEI_S3_BOOT_SCRIPT
0xE2	PEI_S3_VIDEO_REPOST

0xE3	PEI_S3_OS_WAKE
0x50	PEI_MEMORY_INVALID_TYPE
0x53	PEI_MEMORY_NOT_DETECTED
0x55	PEI_MEMORY_NOT_INSTALLED
0x57	PEI_CPU_MISMATCH
0x58	PEI_CPU_SELF_TEST_FAILED
0x59	PEI_CPU_NO_MICROCODE
0x5A	PEI_CPU_ERROR
0x5B	PEI_RESET_NOT_AVAILABLE
0xD0	DXE_CPU_ERROR
0xD1	DXE_NB_ERROR
0xD2	DXE_SB_ERROR
0xD3	DXE_ARCH_PROTOCOL_NOT_AVAILABLE
0xD4	DXE_PCI_BUS_OUT_OF_RESOURCES
0xD5	DXE_LEGACY_OPROM_NO_SPACE
0xD6	DXE_NO_CON_OUT
0xD7	DXE_NO_CON_IN

0xD8	DXE_INVALID_PASSWORD
0xD9	DXE_BOOT_OPTION_LOAD_ERROR
0xDA	DXE_BOOT_OPTION_FAILED
0xDB	DXE_FLASH_UPDATE_FAILED
0xDC	DXE_RESET_NOT_AVAILABLE
0xE8	PEI_MEMORY_S3_RESUME_FAILED
0xE9	PEI_S3_RESUME_PPI_NOT_FOUND
0xEA	PEI_S3_BOOT_SCRIPT_ERROR
0xEB	PEI_S3_OS_WAKE_ERROR

2.10 Unit Identification purpose LED/Switch

With the UID button, You are able to locate the server you're working on from behind a rack of servers.

Unit Identification
purpose LED/Switch
(UID1)



When the UID button on the front or rear panel is pressed, the front/rear UID blue LED indicator will be turned on. Press the UID button again to turn off the indicator.

2.11 M.2 SSD Module Installation Guide (M2_1)

The Ultra M.2 Socket (M2_1, Key M) supports type 2242/2260/2280/22110 SATA3 6.0 Gb/s module or a M.2 PCI Express module up to Gen4 x4 (16GT/s x4) (Matisse).

The Hyper M.2 Socket (M2_1, Key M) supports type 2242/2260/2280/22110 SATA3 6.0 Gb/s module or a M.2 PCI Express module up to Gen3 x4 (8GT/s x4) (Picasso).



The diagrams in this documentation are for reference only. The actual supported M.2 type varies per motherboard.

Installing the M.2 SSD Module

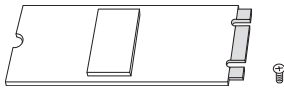

Step 1

Prepare a M.2 SSD module and the screw.

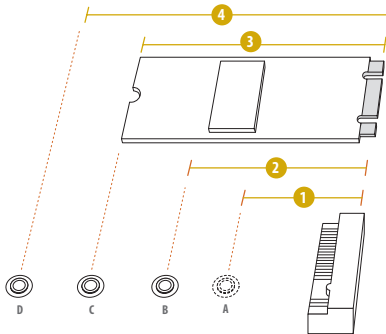

Step 2

Depending on the PCB type and length of your M.2 module, find the corresponding nut location to be used.

No.	1	2	3	4
Nut Location	A	B	C	D
PCB Length	4.2cm	6cm	8cm	10cm
Module Type	Type 2242	Type2260	Type 2280	Type 22110

Step 3

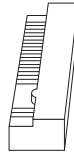
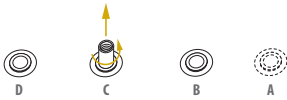

Move the standoff based on the module type and length. The standoff is placed at the nut location C by default. Skip Step 3 and 4 and go straight to Step 5 if you are going to use the default nut. Otherwise, release the standoff by hand.

Step 4



Peel off the yellow protective film on the nut to be used. Hand tighten the standoff into the desired nut location on the motherboard.

Step 5

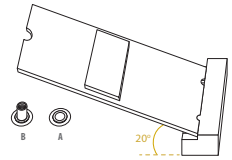
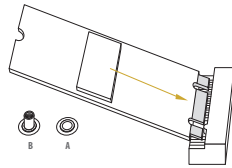

Align and gently insert the M.2 (NGFF) SSD module into the M.2 slot. Please be aware that the M.2 (NGFF) SSD module only fits in one orientation.

Step 6

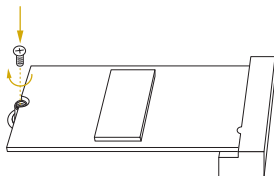

Tighten the screw with a screwdriver to secure the module into place. Please do not overtighten the screw as this might damage the module.

For the latest updates of M.2 SSD module support list, please visit our website for details:
<http://www.asrockrack.com>

2.12 M.2 SSD Module Installation Guide (M2_2)

The Ultra M.2 Socket (M2_2, Key M) supports type 2242/2260/2280 M.2 SATA3 6.0 Gb/s module or a M.2 PCI Express module up to Gen4 x4 (16GT/s x4-) (Matisse).

The Hyper M.2 Socket (M2_2, Key M) supports type 2242/2260/2280 M.2 SATA3 6.0 Gb/s module or a M.2 PCI Express module up to Gen3 x4 (8GT/s x4) (Picasso).



The diagrams in this documentation are for reference only. The actual supported M.2 type varies per motherboard.

Installing the M.2 SSD Module

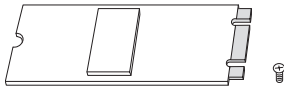

Step 1

Prepare a M.2 SSD module and the screw.

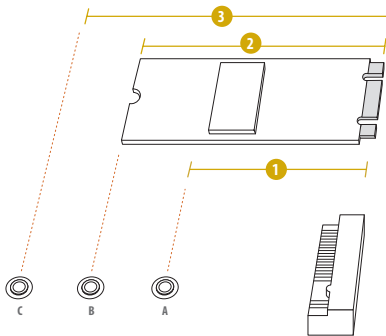

Step 2

Depending on the PCB type and length of your M.2 module, find the corresponding nut location to be used.

No.	1	2	3
Nut Location	A	B	C
PCB Length	4.2cm	6cm	8cm
Module Type	Type 2242	Type2260	Type 2280

Step 3

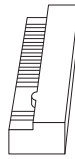

Move the standoff based on the module type and length. The standoff is placed at the nut location C by default. Skip Step 3 and 4 and go straight to Step 5 if you are going to use the default nut. Otherwise, release the standoff by hand.

Step 4

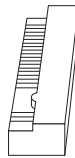

Peel off the yellow protective film on the nut to be used. Hand tighten the standoff into the desired nut location on the motherboard.

Step 5

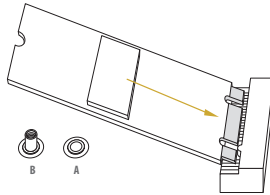

Align and gently insert the M.2 (NGFF) SSD module into the M.2 slot. Please be aware that the M.2 (NGFF) SSD module only fits in one orientation.

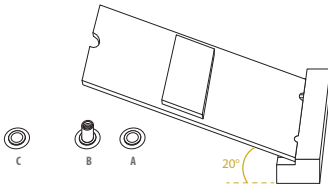

Step 6

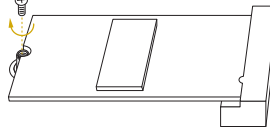

Tighten the screw with a screwdriver to secure the module into place. Please do not overtighten the screw as this might damage the module.

For the latest updates of M.2 SSD module support list, please visit our website for details:
<http://www.asrockrack.com>

Chapter 3 UEFI Setup Utility

3.1 Introduction

This section explains how to use the UEFI SETUP UTILITY to configure your system. The UEFI chip on the motherboard stores the UEFI SETUP UTILITY. You may run the UEFI SETUP UTILITY when you start up the computer. Please press <F2> or during the Power-On-Self-Test (POST) to enter the UEFI SETUP UTILITY; otherwise, POST will continue with its test routines.

If you wish to enter the UEFI SETUP UTILITY after POST, restart the system by pressing <Ctrl> + <Alt> + <Delete>, or by pressing the reset button on the system chassis. You may also restart by turning the system off and then back on.



Because the UEFI software is constantly being updated, the following UEFI setup screens and descriptions are for reference purpose only, and they may not exactly match what you see on your screen.

3.1.1 UEFI Menu Bar

The top of the screen has a menu bar with the following selections:

Item	Description
Main	To set up the system time/date information
Advanced	To set up the advanced UEFI features
Server Mgmt	To manage the server
Security	To set up the security features
Boot	To set up the default system device to locate and load the Operating System
Exit	To exit the current screen or the UEFI SETUP UTILITY

Use <←→> key or <→> key to choose among the selections on the menu bar, and then press <Enter> to get into the sub screen.

3.1.2 Navigation Keys

Please check the following table for the function description of each navigation key.

Navigation Key(s)	Function Description
← / →	Moves cursor left or right to select Screens
↑ / ↓	Moves cursor up or down to select items
+ / -	To change option for the selected items
<Tab>	Switch to next function
<Enter>	To bring up the selected screen
<PGUP>	Go to the previous page
<PGDN>	Go to the next page
<HOME>	Go to the top of the screen
<END>	Go to the bottom of the screen
<F1>	To display the General Help Screen
<F7>	Discard changes and exit the UEFI SETUP UTILITY
<F9>	Load optimal default values for all the settings
<F10>	Save changes and exit the UEFI SETUP UTILITY
<F12>	Print screen
<ESC>	Jump to the Exit Screen or exit the current screen

3.2 Main Screen

Once you enter the UEFI SETUP UTILITY, the Main screen will appear and display the system overview. The Main screen provides system overview information and allows you to set the system time and date.

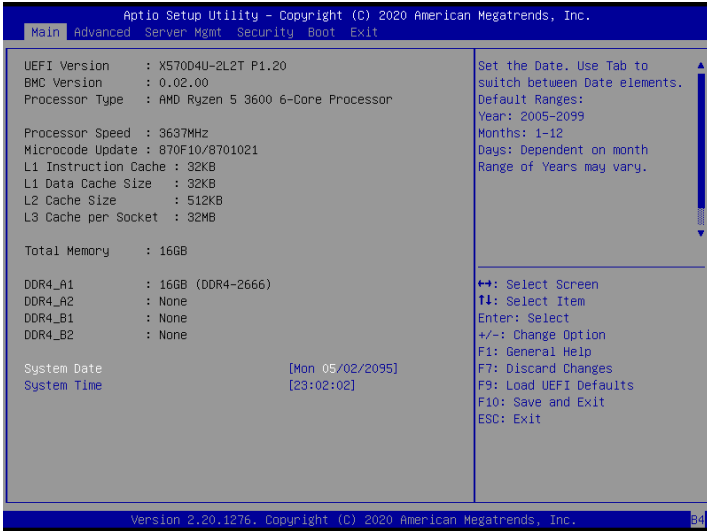

3.3 Advanced Screen

In this section, you may set the configurations for the following items: CPU Configuration, Chipset Configuration, Storage Configuration, ACPI Configuration, USB Configuration, Super IO Configuration, H/W Monitor, RAM Disk Configuration, Tls Auth Configuration, AMD PBS, AMD Overclocking, AMD CBS and Instant Flash.

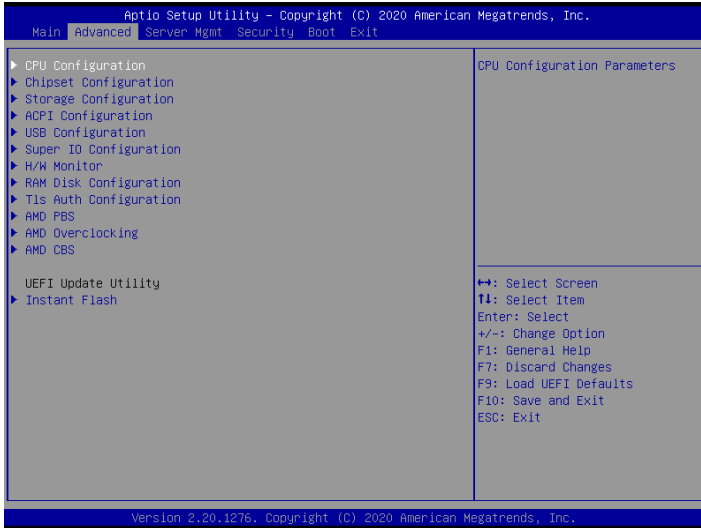

Setting wrong values in this section may cause the system to malfunction.

3.3.1 CPU Configuration

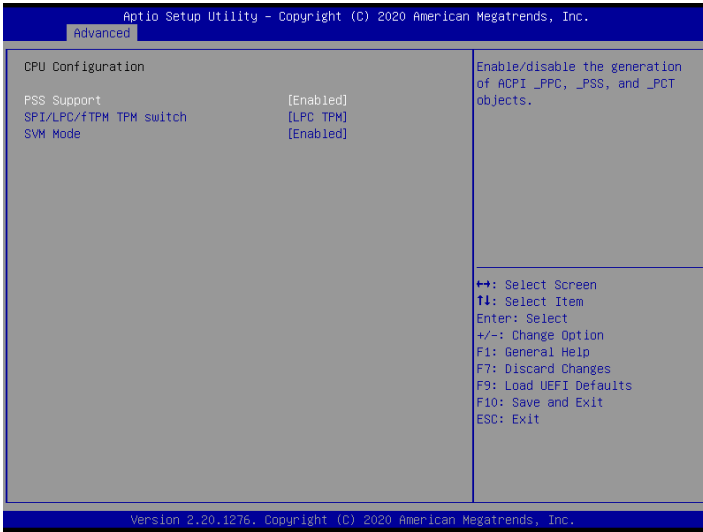

PSS Support

Enable/disable the generation of ACPI _PPC, _PSS, and _PCT objects.

SPI/LPC/fTPM TPM switch

To select. 0: AMD CPU fTPM. 1 - LPC TPM. 2 - SPI TPM

SVM Mode

Enable/disable CPU Virtualization.

3.3.2 Chipset Configuration



Above 4G Decoding

Globally Enables or Disables 64bit capable Devices to be Decoded in Above 4G Address Space (Only if System Supports 64 bit PCI Decoding).

SR-IOV Support

If system has SR-IOV capable PCIe Devices, this option Enables or Disables Single Root IO Virtualization Support.

Restore AC Power Loss

Select the power state after a power failure. If [Power Off] is selected, the power will remain off when the power recovers. If [Power On] is selected, the system will start to boot up when the power recovers.

Restore AC Power Current State

This allows you to restore AC Power Current State.

Onboard Debug Port LED

Enable or disable the onboard Dr. Debug LED.

Onboard X550 LAN1

To enable or disable Onabord LAN.

Onboard X550 LAN2

To enable or disable Onabord LAN.

3.3.3 Storage Configuration

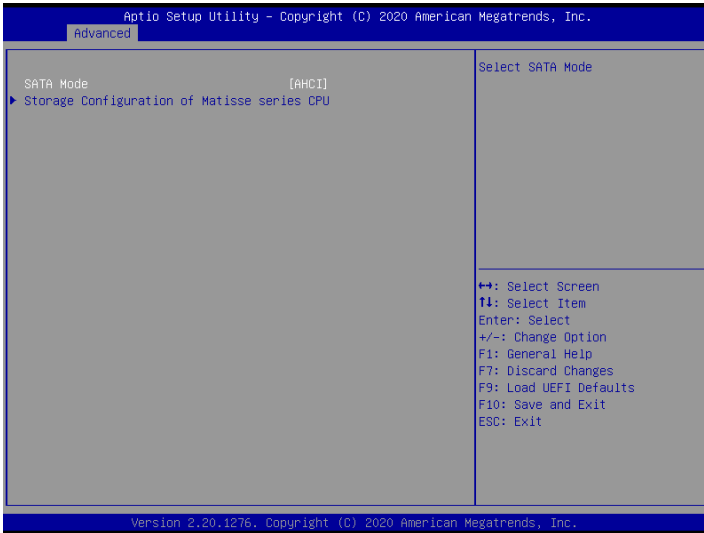

SATA Mode

Select SATA Mode.

Storage Configuration of Matisse series CPU

Configure storage devices of Matisse series CPU.

3.3.4 ACPI Configuration

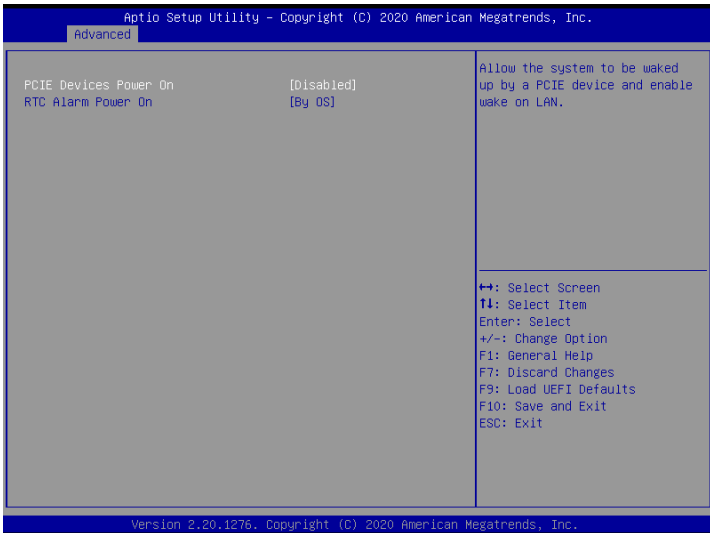

PCIE Devices Power On

Allow the system to be waked up by a PCIE device and enable wake on LAN.

RTC Alarm Power On

Allow the system to be waked up by the real time clock alarm. Set it to By OS to let it be handled by your operating system.

3.3.5 USB Configuration

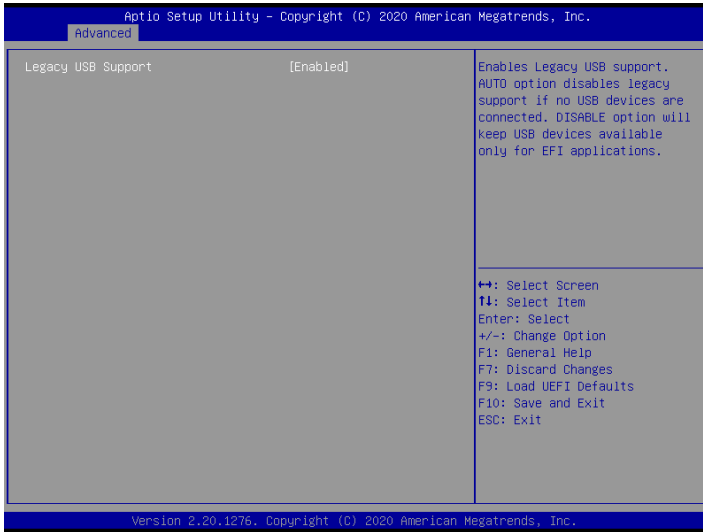

Legacy USB Support

Enables Legacy USB support. AUTO option disables legacy support if no USB devices are connected. DISABLE option will keep USB devices available only for EFI applications.

3.3.6 Super IO Configuration

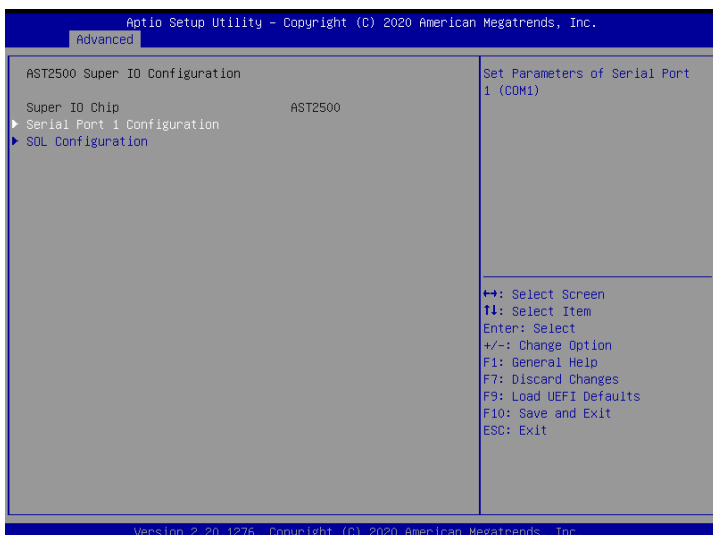

Serial Port 1 Configuration

Use this item to set parameters of Serial Port 1 (COM1).

Serial Port

Use this item to enable or disable the serial port.

Serial Port Address

Use this item to select an optimal setting for Super IO device.

SOL Configuration

Use this item to set parameters of SOL.

SOL Port

Use this item to enable or disable SOL Port.

Serial Port Address

Use this item to select an optimal setting for Super IO device.

3.3.7 H/W Monitor

In this section, it allows you to monitor the status of the hardware on your system, including the parameters of the CPU temperature, motherboard temperature, CPU fan speed, chassis fan speed, and the critical voltage.

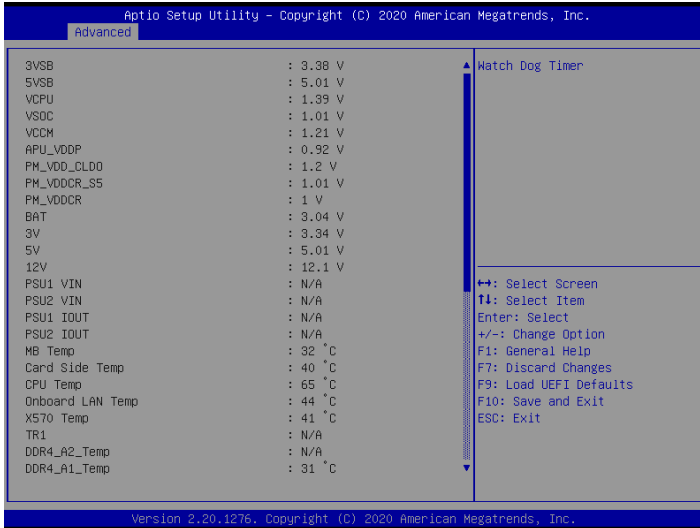

3.3.8 RAM Disk Configuration

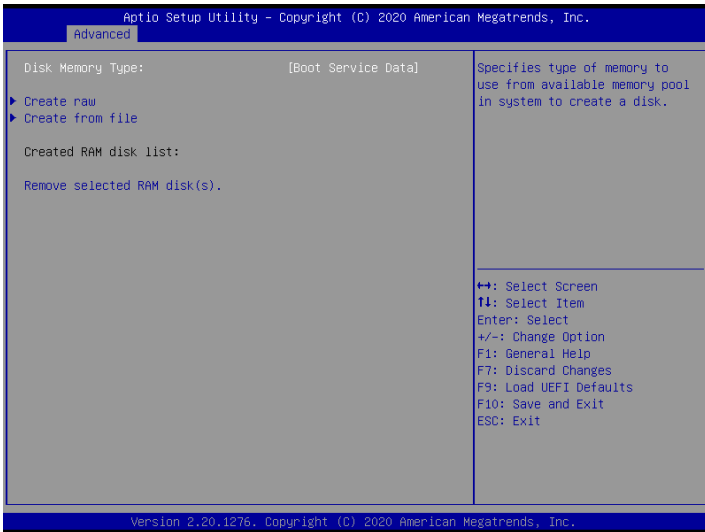

Disk Memory Type

Specifies type of memory to use from available memory pool in system to create a disk.

Create raw

Create a raw RAM disk.

Create from file

Create a RAM disk from a given file.

Remove selected RAM disk(s)

Remove selected RAM disk(s).

3.3.9 Tls Auth Configuration

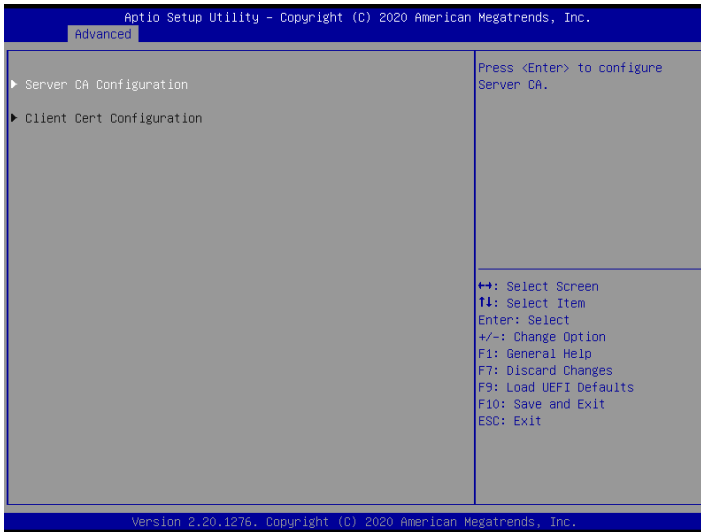

Server CA Configuration

Press <Enter> to configure Server CA.

Client Cert Configuration

Enroll Cert

Press <Enter> to enroll cert.

Delete Cert

Press <Enter> to delete cert.

3.3.10 AMD PBS

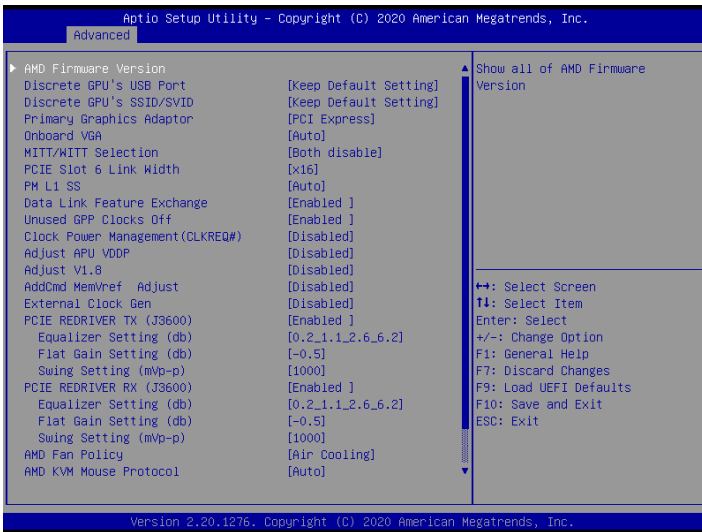

AMD Firmware Version

Show all of AMD Firmware Version.

Discrete GPU's USB Port

Disable Discrete GPU's USB Port or keep default setting

Discrete GPU's SSID/SVID

Program Discrete GPU's SSID/SVID depends on Hybridgraphics setting.

Primary Graphics Adaptor

Select Internal/External Graphics.

Onboard VGA

To Enable or Disable Onboard VGA.

MITT/WITT Selection

Use this item to configure MITT/WITT Selection.

PCIe Slot 6 Link Width

Configure Slot 6 Slot PCIe Lanes.

PM L1 SS

Enable for PM L1 SS and ASPM L1 SS.

Data Link Feature Exchange

Enable or Disable Data Link Feature Exchange, try to disable it if any Legacy Endpoint can not boot.

Unused GPP Clocks Off

Turn Unused GPP Clocks Off.

Clock Power Management (CLKREQ#)

Enable or disable CLKREQ#.

Adjust APU VDDP

Adjust APU VDDP, stepping is 2.5mV. $V_{ddp} = 1.05V \pm N * 2.5 \text{ mV}$, input rang is 0-127.

Adjust V1.8

Adjust V1.8, stepping is 1mV. $V_{1.8} = 1.8V \pm N * 1 \text{ mV}$, input rang is 0-127.

AddCmd MemVref Adjust

AddCmd MemVref Adjust, stepping is $VDDIO * (1/256)$. $MEM_VREF = VDDIO * (N / 256)$, input range is 1-255.

External Clock Gen

External Clock Freq [95-105]

PCIE REDRIVER TX (J3600)

PCIE REDRIVER TX (J3600) - U3608, U3601

Equalizer Setting (db)

EQ[2:0] are the selection pins for the equalization selection. It corresponds to @1.25GHz_@2.5GHz_@4GHz@8GHz in turn.

Flat Gain Setting (db)

FG[1:0] are the selection butts for the DC gain.

PCIE REDRIVER RX (J3600)

PCIE REDRIVER RX (J3600) - U3602, U3603

Equalizer Setting (db)

EQ[2:0] are the selection pins for the equalization selection. It corresponds to @1.25GHz_@2.5GHz_@4GHz@8GHz in turn.

Flat Gain Setting (db)

FG[1:0] are the selection bits for the DC gain.

Swing Setting (mVp-p)

SW[1:0] are the selection bits for the output swing value.

AMD Fan Policy

[Air Cooling] follow platform defined policy, [Water Cooling] force PWM 100%; Select [Fan Control] to [Manual] in CBS will override this option.

AMD KVM Mouse Protocol

Switch KVM Mouse Protocol between Absolut/Simple.

NVMe RAID mode

Enable or disable NVMe RAID mode. Please setting the 'PCIe/GFX Lanes Configuration' item according to the RAID configuration.

M.2 NVMe/SATA Switch (J3705-Slot2)

The signal are auto switched by HW detection.

M.2 NVMe/SATA Switch (J3706-Slot3)

The signal are auto switched by HW detection.

3.3.11 AMD Overclocking

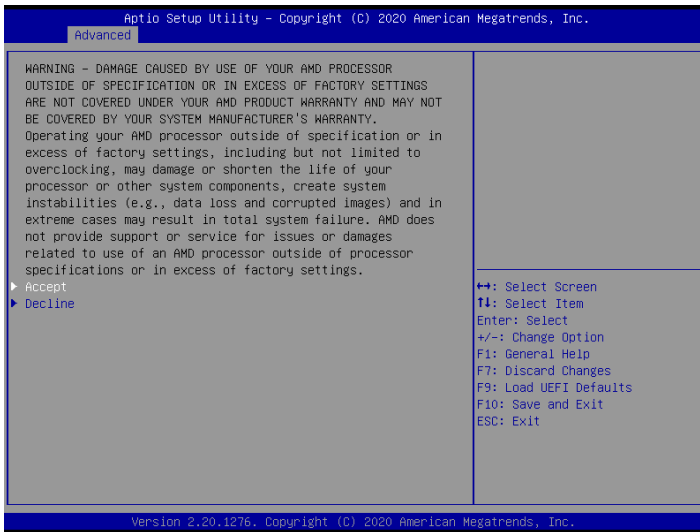

The AMD Overclocking menu accesses options for configuring CPU frequency and voltage.

3.3.12 AMD CBS

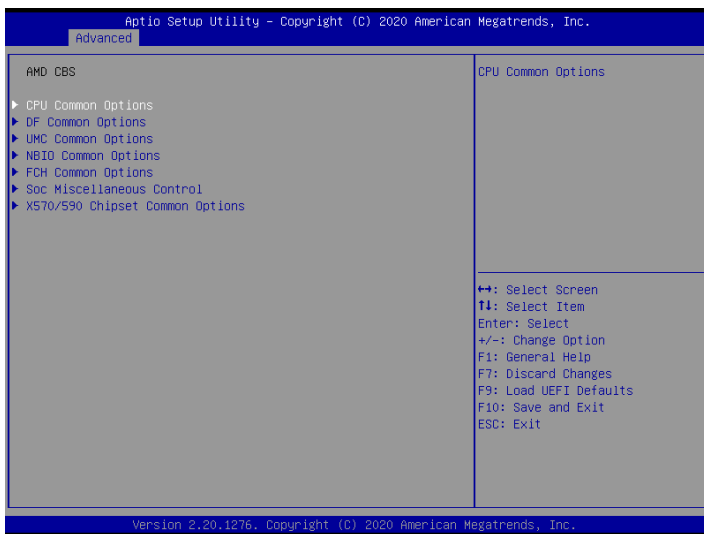

CPU Common Options

Use this item to configure CPU Common options.

DF Common Options

Use this item to configure DF Common options.

UMC Common Options

Use this item to configure UMC Common options.

NBIO Common Options

Use this item to configure NBIO Common options.

FCH Common Options

Use this item to configure FCH Common options.

Soc Miscellaneous Control

Use this item to configure Soc Miscellaneous Control.

X570/590 Chipset Common Options

Use this item to configure X570/590 Chipset Common options.

3.3.13 Instant Flash

Instant Flash is a UEFI flash utility embedded in Flash ROM. This convenient UEFI update tool allows you to update system UEFI without entering operating systems first like MS-DOS or Windows[®]. Just save the new UEFI file to your USB flash drive, floppy disk or hard drive and launch this tool, then you can update your UEFI only in a few clicks without preparing an additional floppy diskette or other complicated flash utility. Please be noted that the USB flash drive or hard drive must use FAT32/16/12 file system. If you execute Instant Flash utility, the utility will show the UEFI files and their respective information. Select the proper UEFI file to update your UEFI, and reboot your system after the UEFI update process is completed.

3.4 Server Mgmt

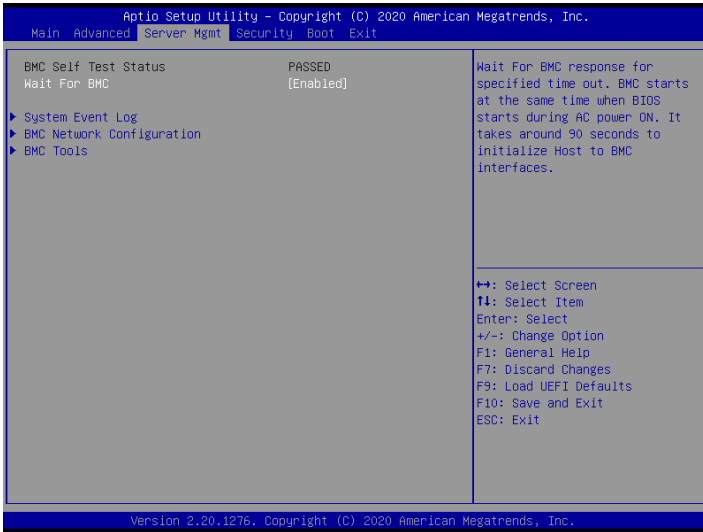

Wait For BMC

Wait For BMC response for specified time out. BMC starts at the same time when BIOS starts during AC power ON. It takes around 90 seconds to initialize Host to BMC interfaces.

3.4.1 System Event Log

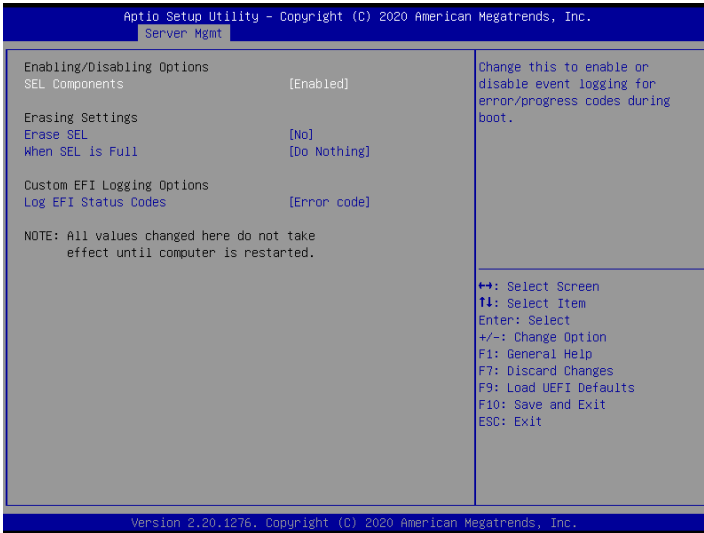

SEL Components

Change this to enable or disable event logging for error/progress codes during boot.

Erase SEL

Use this to choose options for erasing SEL.

When SEL is Full

Use this to choose options for reactions to a full SEL.

Log EFI Status Codes

Use this item to disable the logging of EFI Status Codes or log only error code or only progress code or both.

3.4.2 BMC Network Configuration



BMC Out of Band Access

Enabled/Disabled BMC Out of band Access.

Manual Setting IPMI LAN

If [No] is selected, the IP address is assigned by DHCP. If you prefer using a static IP address, toggle to [Yes], and the changes take effect after the system reboots. The default value is [No].

Configuration Address Source

Select to configure BMC network parameters statically or dynamically (by BIOS or BMC). Configuration options: [Static] and [DHCP].

Static: Manually enter the IP Address, Subnet Mask and Gateway Address in the BIOS for BMC LAN channel configuration.

DHCP: IP address, Subnet Mask and Gateway Address are automatically assigned by the network's DHCP server.



When [DHCP] or [Static] is selected, do NOT modify the BMC network settings on the IPMI web page.



The default login information for the IPMI web interface is:

Username: admin

Password: admin

For more instructions on how to set up remote control environment and use the IPMI management platform, please refer to the IPMI Configuration User Guide or go to the Support website at: <http://www.asrockrack.com/support/faq.asp>

VLAN

Enabled/Disabled Virtual Local Area Network.

If [Enabled] is selected, configure the items below.

IPV6 Support

Enabled/Disable LAN1 IPV6 Support.

Manual Setting IPMI LAN(IPV6)

Select to configure LAN channel parameters statically or dynamically(by BIOS or BMC).

Unspecified option will not modify any BMC network parameters during BIOS phase.

IPV6 Index

IPV6 Index - Set Selector for Static IP, range 0 to 15.

3.4.3 BMC Tools

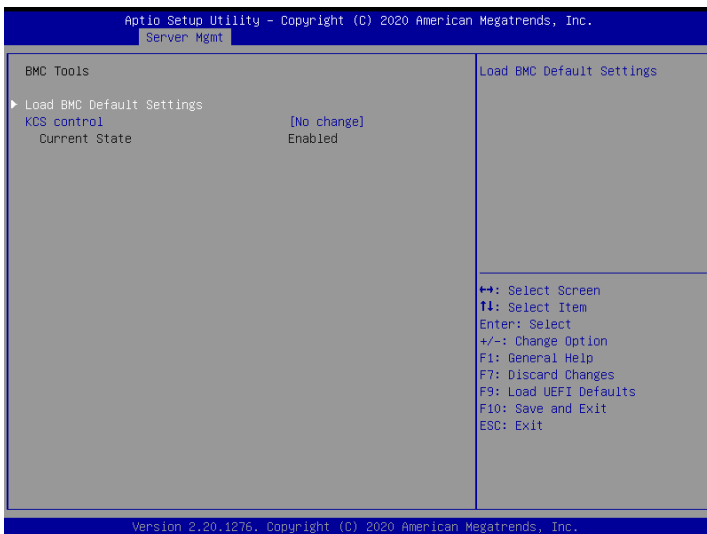

Load BMC Default Settings

Use this item to Load BMC Default Settings

KCS Control

Select this KCS interface state after POST end. If [Enabled] is selected, the BMC will remain KCS interface after POST stage. If [Disabled] is selected, the BMC will disable KCS interface after POST stage

3.5 Security

In this section, you may set or change the supervisor/user password for the system. For the user password, you may also clear it.

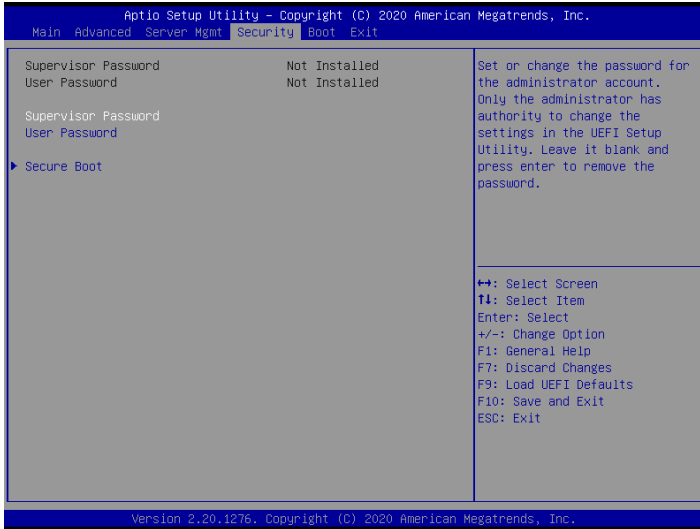

Supervisor Password

Set or change the password for the administrator account. Only the administrator has authority to change the settings in the UEFI Setup Utility. Leave it blank and press enter to remove the password.

User Password

Set or change the password for the user account. Users are unable to change the settings in the UEFI Setup Utility. Leave it blank and press enter to remove the password.

Secure Boot

Use this to enable or disable Secure Boot Control. The default value is [Disabled]. Enable to support Windows 8 or later versions Secure Boot.

Secure Boot Mode

Secure Boot mode selector: Standard/Custom. In Custom mode Secure Boot Variables can be configured without authentication.

3.5.1 Key Management

In this section, expert users can modify Secure Boot Policy variables without full authentication.

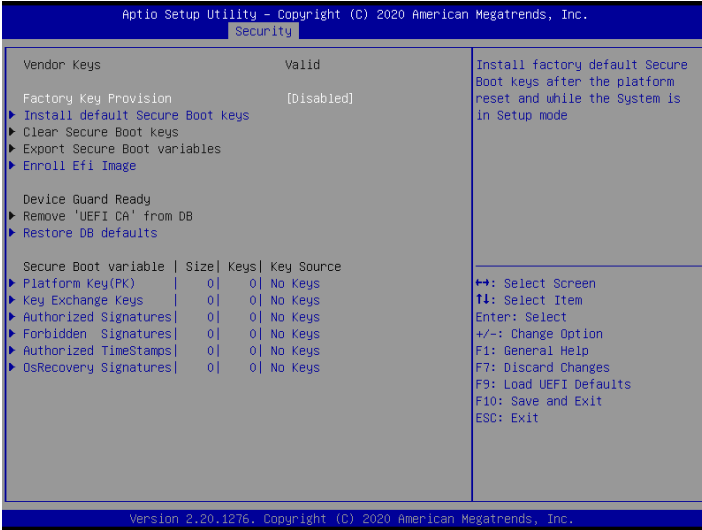

Factory Key Provision

Allow to provision factory default Secure Boot keys when System is in Setup Mode.

Install Default Secure Boot Keys

Please install default secure boot keys if it's the first time you use secure boot.

Enroll Efi Image

Allow the image to run in Secure Boot mode. Enroll SHA256 hash of the binary into Authorized Signature Database (db).

Restore DB Defaults

Restore DB variable to factory defaults.

Platform Key(PK)

Enroll Factory Defaults or load certificates from a file:

1. Public Key Certificate:

- a) EFI_SIGNATURE_LIST
- b) EFI_CERT_X509 (DER)

- c) EFI_CERT_RSA2048 (bin)
 - d) EFI_CERT_SHAXXX
2. Authenticated UEFI Variable
 3. EFI PE/COFF Image(SHA256)

Key Source: Default, External, Mixed

Key Exchange Keys

Enroll Factory Defaults or load certificates from a file:

1. Public Key Certificate:
 - a) EFI_SIGNATURE_LIST
 - b) EFI_CERT_X509 (DER)
 - c) EFI_CERT_RSA2048 (bin)
 - d) EFI_CERT_SHAXXX
2. Authenticated UEFI Variable
3. EFI PE/COFF Image(SHA256)

Key Source: Default, External, Mixed

Authorized Signatures

Enroll Factory Defaults or load certificates from a file:

1. Public Key Certificate:
 - a) EFI_SIGNATURE_LIST
 - b) EFI_CERT_X509 (DER)
 - c) EFI_CERT_RSA2048 (bin)
 - d) EFI_CERT_SHAXXX
2. Authenticated UEFI Variable
3. EFI PE/COFF Image(SHA256)

Key Source: Default, External, Mixed

Forbidden Signatures

Enroll Factory Defaults or load certificates from a file:

1. Public Key Certificate:

- a) EFI_SIGNATURE_LIST
 - b) EFI_CERT_X509 (DER)
 - c) EFI_CERT_RSA2048 (bin)
 - d) EFI_CERT_SHAXXX
2. Authenticated UEFI Variable
 3. EFI PE/COFF Image(SHA256)

Key Source: Default, External, Mixed

Authorized TimeStamps

Enroll Factory Defaults or load certificates from a file:

1. Public Key Certificate:
 - a) EFI_SIGNATURE_LIST
 - b) EFI_CERT_X509 (DER)
 - c) EFI_CERT_RSA2048 (bin)
 - d) EFI_CERT_SHAXXX
2. Authenticated UEFI Variable
3. EFI PE/COFF Image(SHA256)

Key Source: Default, External, Mixed

OsRecovery Signatures

Enroll Factory Defaults or load certificates from a file:

1. Public Key Certificate:
 - a) EFI_SIGNATURE_LIST
 - b) EFI_CERT_X509 (DER)
 - c) EFI_CERT_RSA2048 (bin)
 - d) EFI_CERT_SHAXXX
2. Authenticated UEFI Variable
3. EFI PE/COFF Image(SHA256)

Key Source: Default, External, Mixed

3.6 Boot Screen

In this section, it will display the available devices on your system for you to configure the boot settings and the boot priority.

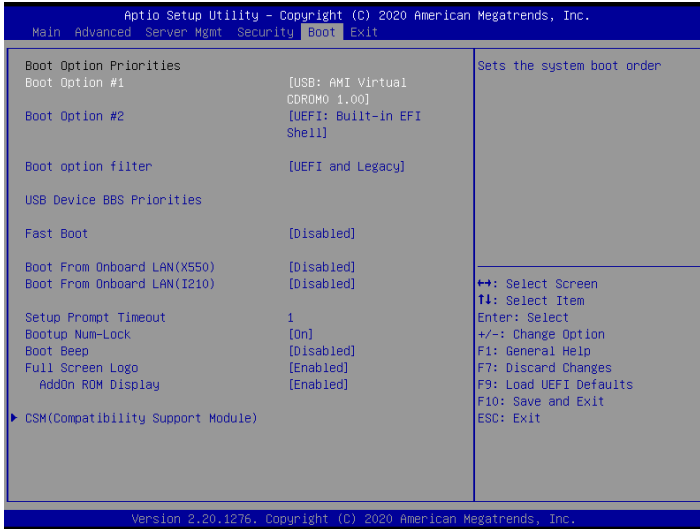

Boot Option #1

Use this item to set the system boot order.

Boot Option #2

Use this item to set the system boot order.

Boot Option Filter

This option controls Legacy/UEFI ROMs priority.

USB Device BBS Priorities

Set the order of the legacy devices in this group.

Fast Boot

Enables/Disables fast boot which skips memory training and attempts to boot using last known good configuration.

Boot From Onboard LAN(X550)

Use this item to enable or disable the Boot From Onboard LAN feature.

Boot From Onboard LAN(I210)

Use this item to enable or disable the Boot From Onboard LAN feature.

Setup Prompt Timeout

Configure the number of seconds to wait for the UEFI setup utility.

Bootup Num-Lock

If this item is set to [On], it will automatically activate the Numeric Lock function after boot-up.

Boot Beep

Select whether the Boot Beep should be turned on or off when the system boots up. Please note that a buzzer is needed.

Full Screen Logo

Use this item to enable or disable OEM Logo. The default value is [Enabled].

AddOn ROM Display

Use this option to adjust AddOn ROM Display. If you enable the option “Full Screen Logo” but you want to see the AddOn ROM information when the system boots, please select [Enabled]. Configuration options: [Enabled] and [Disabled]. The default value is [Enabled].

3.6.1 CSM Parameters

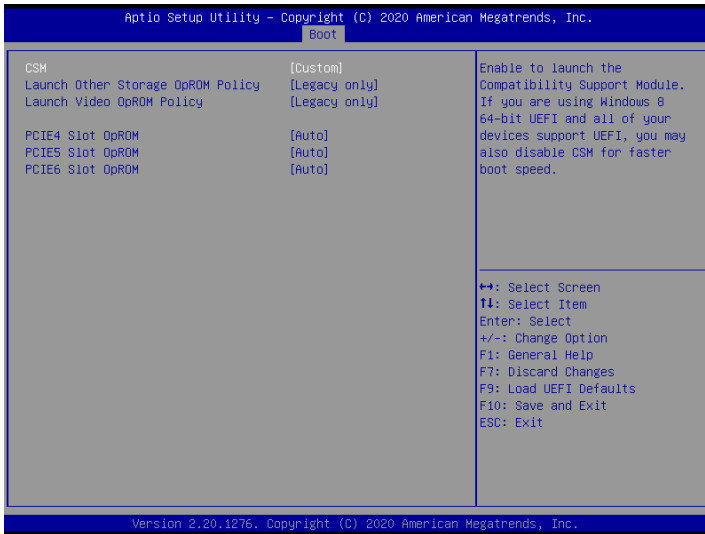

CSM

Enable to launch the Compatibility Support Module. Please do not disable unless you're running a WHCK test. If you are using Windows Server 2012 R2 or later versions 64-bit UEFI and all of your devices support UEFI, you may also disable CSM for faster boot speed.

Launch Other Storage OpROM Policy

Select UEFI only to run those that support UEFI option ROM only. Select Legacy only to run those that support legacy option ROM only. Select Do not launch to not execute both legacy and UEFI option ROM.

Launch Video OpROM Policy

Select UEFI only to run those that support UEFI option ROM only. Select Legacy only to run those that support legacy option ROM only. Select Do not launch to not execute both legacy and UEFI option ROM.

PCIe4 Slot OpROM

Use this item to select slot storage and Network Option ROM policy. In Auto option, the default is Disabled with NVMe device, but it is Legacy with other devices. (This item can't select Video Option ROM policy.)

PCIE5 Slot OpROM

Use this item to select slot storage and Network Option ROM policy. In Auto option, the default is Disabled with NVMe device, but it is Legacy with other devices. (This item can't select Video Option ROM policy.)

PCIE6 Slot OpROM

Use this item to select slot storage and Network Option ROM policy. In Auto option, the default is Disabled with NVMe device, but it is Legacy with other devices. (This item can't select Video Option ROM policy.)

3.7 Exit Screen

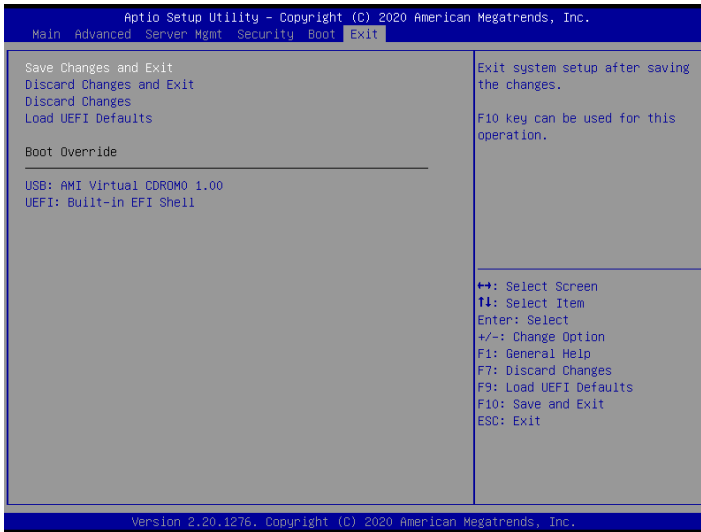

Save Changes and Exit

When you select this option, the following message “Save configuration changes and exit setup?” will pop-out. Press <F10> key or select [Yes] to save the changes and exit the UEFI SETUP UTILITY.

Discard Changes and Exit

When you select this option, the following message “Discard changes and exit setup?” will pop-out. Press <ESC> key or select [Yes] to exit the UEFI SETUP UTILITY without saving any changes.

Discard Changes

When you select this option, the following message “Discard changes?” will pop-out. Press <F7> key or select [Yes] to discard all changes.

Load UEFI Defaults

Load UEFI default values for all the setup questions. F9 key can be used for this operation.

Boot Override

These items displays the available devices. Select an item to start booting from the selected device.

Chapter 4 Software Support

After all the hardware has been installed, we suggest you go to our official website at <http://www.ASRockRack.com> and make sure if there are any new updates of the BIOS / BMC firmware for your motherboard.

4.1 Download and Install Operating System

This motherboard supports various Microsoft® Windows® Server / Linux compliant operating systems. Please download the operating system from your OS manufacturer. Please refer to your OS documentation for more instructions.

**Please download the Intel® SATA Floppy Image driver from the ASRock Rack's website (www.asrockrack.com) to your USB drive while installing OS in SATA RAID mode.*

4.2 Download and Install Software Drivers

This motherboard supports various Microsoft® Windows® compliant drivers. Please download the required drivers from our website at <http://www.ASRockRack.com>.

To download necessary drivers, go the product page, click on the "Download" tab, choose the operating system you use, and select the driver you need to be downloaded.

4.3 Contact Information

If you need to contact ASRock Rack or want to know more about ASRock Rack, welcome to visit ASRock Rack's website at <http://www.ASRockRack.com>; or you may contact your dealer for further information.

Chapter 5 Troubleshooting

5.1 Troubleshooting Procedures

Follow the procedures below to troubleshoot your system.



Always unplug the power cord before adding, removing or changing any hardware components. Failure to do so may cause physical injuries to you and damages to motherboard components.

1. Disconnect the power cable and check whether the PWR LED is off.
2. Unplug all cables, connectors and remove all add-on cards from the motherboard.
Make sure that the jumpers are set to default settings.
3. Confirm that there are no short circuits between the motherboard and the chassis.
4. Install a CPU and fan on the motherboard, then connect the chassis speaker and power LED.

If there is no power...

1. Confirm that there are no short circuits between the motherboard and the chassis.
2. Make sure that the jumpers are set to default settings.
3. Check the settings of the 115V/230V switch on the power supply.
4. Verify if the battery on the motherboard provides ~3VDC. Install a new battery if it does not.

If there is no video...

1. Try replugging the monitor cables and power cord.
2. Check for memory errors.

If there are memory errors...

1. Verify that the DIMM modules are properly seated in the slots.
2. Use recommended DDR4 ECC/UDIMMs.
3. If you have installed more than one DIMM modules, they should be identical with the same brand, speed, size and chip-type.
4. Try inserting different DIMM modules into different slots to identify faulty ones.
5. Check the settings of the 115V/230V switch on the power supply.

Unable to save system setup configurations...

1. Verify if the battery on the motherboard provides ~3VDC. Install a new battery if it does not.
2. Confirm whether your power supply provides adequate and stable power.

Other problems...

1. Try searching keywords related to your problem on ASRock Rack's FAQ page:
<http://www.asrockrack.com/support>

5.2 Technical Support Procedures

If you have tried the troubleshooting procedures mentioned above and the problems are still unsolved, please contact ASRock Rack's technical support with the following information:

1. Your contact information
2. Model name, BIOS version and problem type.
3. System configuration.
4. Problem description.

You may contact ASRock Rack's technical support at:
<http://www.asrockrack.com/support/tsd.asp>

5.3 Returning Merchandise for Service

For warranty service, the receipt or a copy of your invoice marked with the date of purchase is required. By calling your vendor or going to our RMA website (<http://event.asrockrack.com/tsd.asp>) you may obtain a Returned Merchandise Authorization (RMA) number.

The RMA number should be displayed on the outside of the shipping carton which is mailed prepaid or hand-carried when you return the motherboard to the manufacturer. Shipping and handling charges will be applied for all orders that must be mailed when service is complete.

This warranty does not cover damages incurred in shipping or from failure due to alteration, misuse, abuse or improper maintenance of products.

Contact your distributor first for any product related problems during the warranty period.

Contact Information

If you need to contact ASRock Rack or want to know more about ASRock Rack, you're welcome to visit ASRock Rack's website at <http://www.asrockrack.com>; or you may contact your dealer for further information. For technical questions, please submit a support request form at <https://event.asrockrack.com/tsd.asp>

ASRock Rack Incorporation

e-mail: ASRockRack_sales@asrockrack.com

ASRock Rack EUROPE B.V.

Bijsterhuizen 11-11
6546 AR Nijmegen
The Netherlands
Phone: +31-24-345-44-33

ASRock Rack America, Inc.

13848 Magnolia Ave, Chino, CA91710 U.S.A.
Phone: +1-909-590-8308
Fax: +1-909-590-1026