

> X100-4K

Lamp Free Smart Theater User Guide

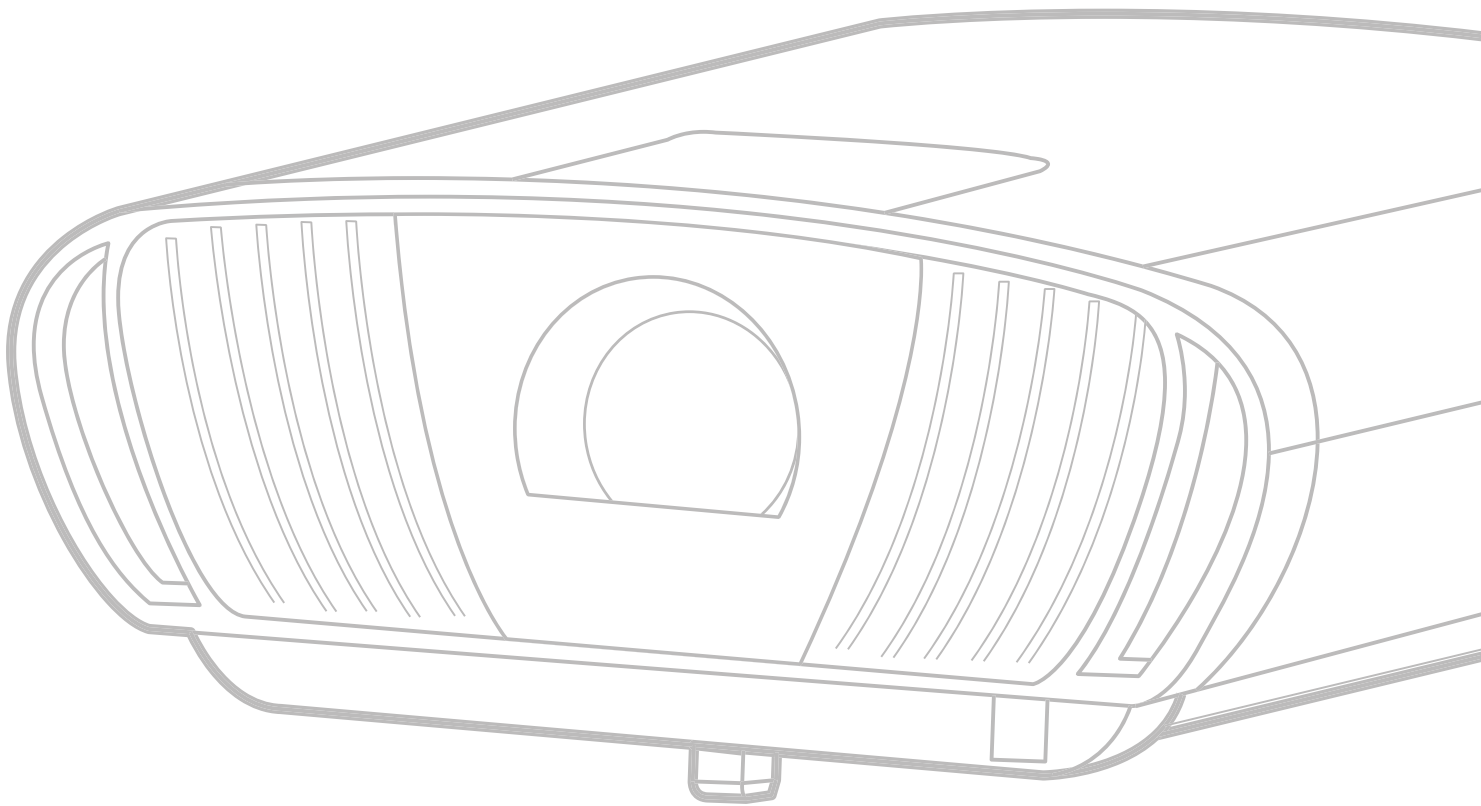

IMPORTANT: Please read this User Guide to obtain important information on installing and using your product in a safe manner, as well as registering your product for future service. Warranty information contained in this User Guide will describe your limited coverage from ViewSonic® Corporation, which is also found on our web site at <http://www.viewsonic.com> in English, or in specific languages using the Regional selection box in the upper right corner of our website. "Antes de operar su equipo lea cuidadosamente las instrucciones en este manual"

Model No. VS17739
P/N: X100-4K

Thank you for choosing ViewSonic®

As a world-leading provider of visual solutions, ViewSonic® is dedicated to exceeding the world's expectations for technological evolution, innovation, and simplicity. At ViewSonic®, we believe that our products have the potential to make a positive impact in the world, and we are confident that the ViewSonic® product you have chosen will serve you well.

Once again, thank you for choosing ViewSonic®!

> Safety Precautions

Please read the following **Safety Precautions** before you start using the projector.

- Keep this user guide in a safe place for later reference.
- Read all warnings and follow all instructions.
- Allow at least 20" (50 cm) clearance around the projector to ensure proper ventilation.
- Place the projector in a well-ventilated area. Do not place anything on the projector that prevents heat dissipation.
- Do not place the projector on an uneven or unstable surface. The projector may fall over, causing personal injury or projector malfunction.
- Do not use if the projector is tilted at an angle of more than 10° degrees left or right, nor at an angle of more than 15° degrees forwards or backwards.
- Do not look straight at the projector lens during operation. The intense light beam may damage your eyes.
- Always open the lens shutter or remove the lens cap when the projector lamp is on.
- Do not block the projection lens with any objects when the projector is under operation as this could cause objects to become heated and deformed or even cause a fire.
- The lamp becomes extremely hot during operation. Allow the projector to cool for approximately 45 minutes prior to removing the lamp assembly for replacement.
- Do not use lamps beyond the rated lamp life. Excessive use of lamps beyond the rated life could cause them to break on rare occasions.
- Never replace the lamp assembly or any electronic component unless the projector is unplugged.
- Do not attempt to disassemble the projector. There are dangerous high voltages inside which may cause death if you should come into contact with live parts.
- When moving the projector, be careful not to drop or bump the projector on anything.
- Do not place any heavy objects on the projector or connection cables.
- Do not stand the projector on end vertically. Doing so may cause the projector to fall over, causing personal injury or projector malfunction.
- Avoid exposing the projector to direct sunlight or other sources of sustained heat. Do not install near any heat sources such as radiators, heat registers, stoves, or other devices (including amplifiers) that may increase the temperature of the projector to dangerous levels.

- Do not place liquids near or on the projector. Liquids spilled into the projector may cause it to fail. If the projector does become wet, disconnect it from the power supply and call your local service center to have the projector serviced.
- When the projector is under operation, you may sense some heated air and odor from its ventilation grill. It is a normal operation and not a defect.
- Do not attempt to circumvent the safety provisions of the polarized or grounding-type plug. A polarized plug has two blades with one wider than the other. A grounding-type plug has two blades and a third grounding prong. The wide and third blade are provided for your safety. If the plug does not fit into your outlet, obtain an adapter and do not attempt to force the plug into the outlet.
- When connecting to a power outlet, DO NOT remove the grounding prong. Please ensure grounding prongs are NEVER REMOVED.
- Protect the power cord from being treaded upon or pinched, particularly at the plug, and at the point where it emerges from the projector.
- In some countries, the voltage is NOT stable. This projector is designed to operate safely within a voltage between 100 to 240 volts AC, but could fail if power cuts or surges of ± 10 volts occur. In areas where voltage may fluctuate or cut out, it is recommended that you connect your projector through a power stabilizer, surge protector, or uninterruptable power supply (UPS).
- If smoke, an abnormal noise, or a strange odor is present, immediately switch the projector off and call your dealer or ViewSonic®. It is dangerous to continue using the projector.
- Use only attachments/accessories specified by the manufacturer.
- Disconnect the power cord from the AC outlet if the projector is not being used for a long period of time.
- Refer all servicing to qualified service personnel.



CAUTION: Possibly hazardous optical radiation is emitted from this product. As with any bright light source, do not stare into the beam, RG2 IEC 62471-5:2015

> Safety Precautions - Ceiling Mounting

Please read the following **Safety Precautions** before you start using the projector.

If you intend to mount the projector on the ceiling, it is strongly recommended that you use a proper fitting projector ceiling mount kit and that you ensure it is securely and safely installed.

If you use an inappropriate projector ceiling mount kit, there is a safety risk that the projector may fall from the ceiling due to an improper attachment through the use of the wrong gauge or length screws.

You can purchase a projector ceiling mount kit from the place you purchased your projector.

> Contents

Safety Precautions.....	3
Introduction	9
Features.....	9
Package Contents	10
Product Overview	11
Projector - Controls and Functions.....	11
Lens Shift Cover.....	11
Keypad Cover	11
Connection Ports.....	12
Remote Control	13
Remote Control	14
Initial Setup.....	16
Choosing a Location - Projection Orientation.....	16
Projection Dimensions.....	17
Mounting the Projector	18
Making Connections.....	19
Connecting to Power	19
vRemote App	20
Connecting to External Devices	21
HDMI Connection	21
Audio Connection.....	22
USB and Network Connection	23
RS-232 Connection	24
Additional Connection Options	25
Wireless Screen Mirroring.....	26
Voice Control.....	27
Connecting to Networks.....	31
Wi-Fi Connection.....	31
Custom SSID	33
Wired LAN Connection.....	35

Using the Projector.....	36
Starting Up the Projector.....	36
First Time Activation.....	36
Preferred Language.....	36
Projection Orientation	37
Source Input	38
Selecting an Input Source	39
Adjusting the Projected Image	40
Adjusting the Projector's Height and Projection Angle	40
Fine-Tuning the Image Size and Clarity	40
Controlling the Projected Image	41
Shutting Down the Projector.....	42
Input Source Selected - On-Screen Display (OSD) Tree.....	43
Operating the Projector.....	58
Home Screen	58
Home Screen - On-Screen Display (OSD) Menu Tree	59
Menu Operations	64
Aptoide.....	64
Apps Center.....	65
File Management	67
Setting	71
Screen Mirroring	92
Appendix.....	95
Specifications.....	95
Timing Chart	97
IR Control Table	98
RS-232 Command Table	99
Glossary	109
Troubleshooting	112
Maintenance.....	113
General Precautions.....	113
Cleaning the Lens	113
Cleaning the Case	113
Storing the Projector	113
LED Indicators.....	114

Regulatory and Service Information 115

Compliance Information.....	115
FCC Compliance Statement.....	115
Industry Canada Statement.....	115
CE Conformity for European Countries.....	115
Declaration of RoHS2 Compliance.....	117
Indian Restriction of Hazardous Substances	118
Product Disposal at End of Product Life	118
Copyright Information	119
Customer Service	120
Limited Warranty	121
Mexico Limited Warranty.....	124

> Introduction

Combining stunning 4K resolution with smart streaming functionality, the ViewSonic® X100-4K is a dark room projector. With Wide H/V lens shift it is easy to install in the home. Additionally, it features multiple HDMI ports and rich connectivity allowing users to stream content from their favorite providers.

Features

- Central and Wide lens shift range is excellent for home cinema projection. Project a 100" screen from 2.65 meters.
- Compatible home automation system with LAN control smart technology. It's easy to control your smart home equipment.
- 12V trigger, Motorized Focus, and Screen Mirroring features.
- 16 GB internal storage (Max. 12 GB available for user storage).
- Various Color modes for different projection purposes.
- Multi-language On-Screen Display (OSD) menus.

Package Contents

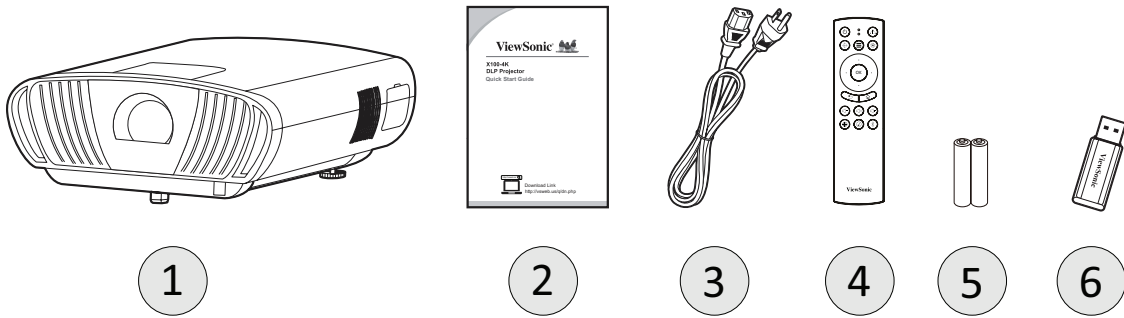

Item	Description
[1]	X100-4K Projector
[2]	Quick Start Guide
[3]	Power Cord
[4]	Remote Control
[5]	Batteries
[6]	Wi-Fi Dongle

NOTE: The power cord and remote control included in your package may vary depending on your country. Please contact your local reseller for more information.

Product Overview

Projector - Controls and Functions

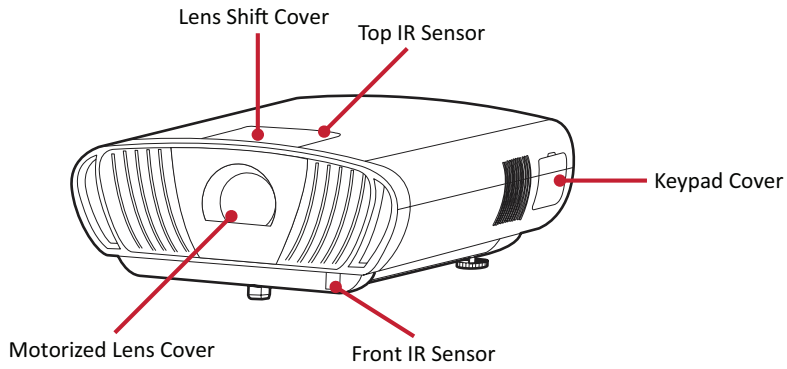

Lens Shift Cover

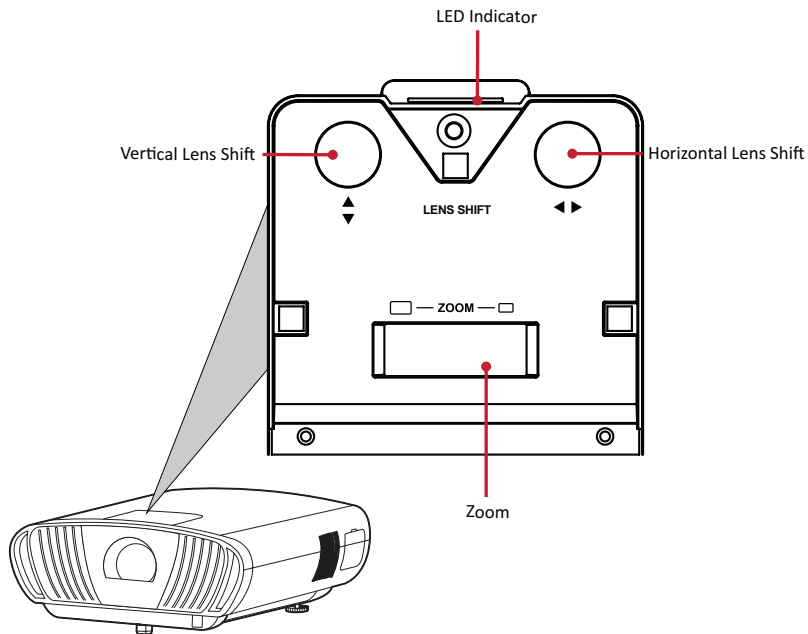

Keypad Cover

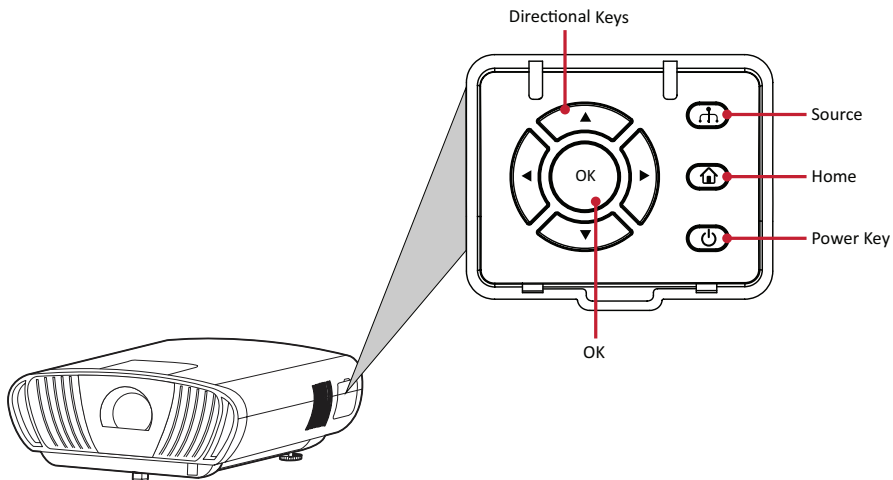

Connection Ports

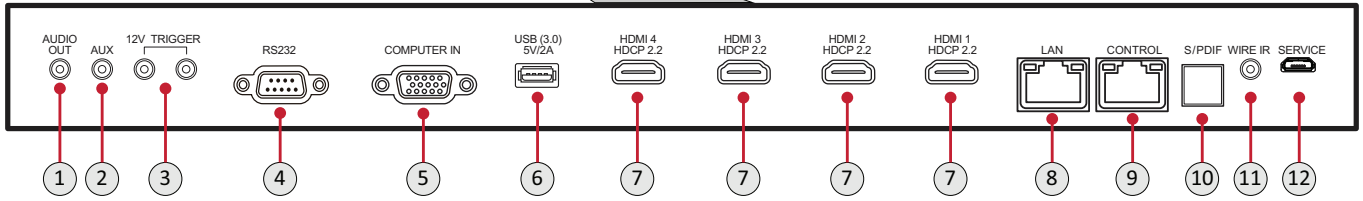
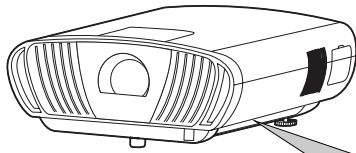

Port	Description
[1] AUDIO OUT (3.5 mm jack)	Audio signal output socket
[2] AUX (3.5 mm jack)	Audio signal input socket
[3] 12V Trigger	12V DC output terminal
[4] RS232	RS-232 control port
[5] COMPUTER IN	VGA signal input port
[6] USB (5V/2A Out)	USB 3.0 Type A port (USB Reader - FAT32)
[7] HDMI 1/2/3/4 ¹	HDMI port ²
[8] LAN	RJ45 LAN port
[9] CONTROL	Compatible home automation system
[10] S/PDIF	S/PDIF signal output socket
[11] WIRE IR	Connection port for IR sensor extender
[12] Service	For Firmware updates





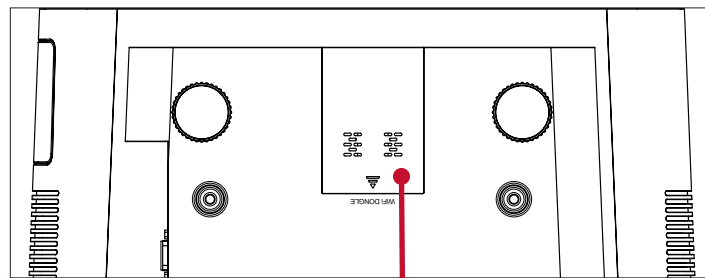









¹ Supports HDCP 2.0/HDMI 2.2.

² iPhone/iPad users will need to buy an additional adapter. To avoid compatibility issues, please use Apple authorized accessories.



USB 2.0 for Wi-Fi dongle





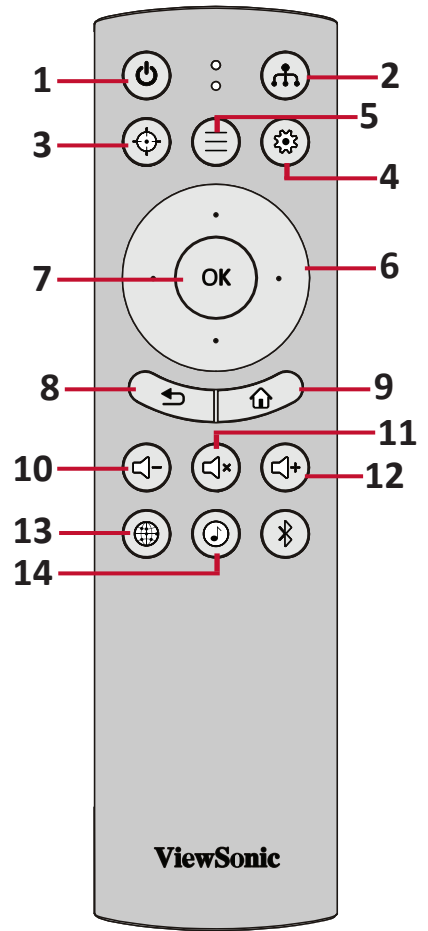



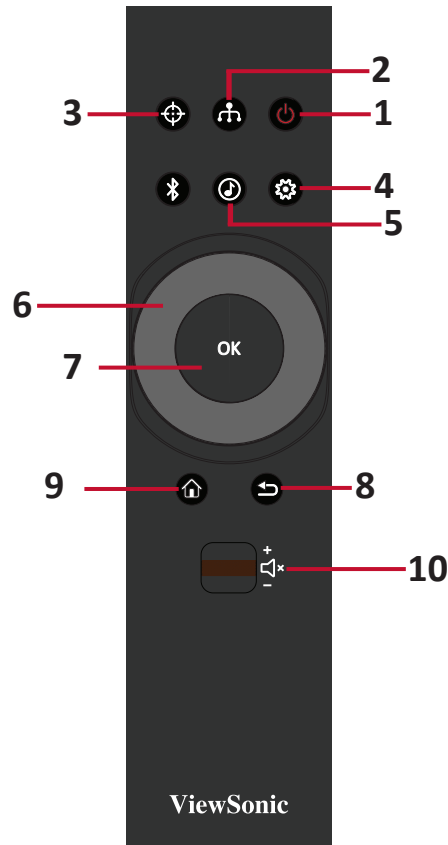

Remote Control

Button		Description
[1] Power		Turns the projector On or Off
[2] Source		Displays the input source selection bar.
[3] Focus		Manually adjust the image.
[4] Setting		Displays the Setting menu.
[5] App Menu		Displays the Application menu.
[6] Up/Down/Left/Right		Navigates and selects the desired menu items and makes adjustments.
[7] OK		Confirms the selection.
[8] Return		Returns to the previous screen.
[9] Home		Access the Home screen.
[10] Volume Down		Decrease the volume level.
[11] Mute		Mute/Unmute.
[12] Volume Up		Increase the volume level.
[13] Network Setting		Displays Network settings.
[14] Audio Mode		Displays the speaker settings.



Remote Control



Button		Description
[1] Power		Turns the projector On or Off
[2] Source		Displays the input source selection bar.
[3] Focus		Manually adjust the image.
[4] Setting		Displays the Settings menu.
[5] Audio Mode		Displays the speaker settings.
[6] Up/Down/Left/Right		Navigates and selects the desired menu items and makes adjustments.
[6] Shuttle Wheel Left/Right		
[7] OK		Confirms the selection.
[8] Return		Returns to the previous screen.
[9] Home		Access the Home menu.
[10] Volume Control		Increases/decreases the volume level or mutes/unmutes it.

Remote Control - Receiver Range

To ensure proper function of the remote control follow the steps below:

1. The remote control must be held at an angle within 30° perpendicular to the projector's IR remote control sensor(s).
2. The distance between the remote control and the sensor(s) should not exceed 8 m (26 ft.)

NOTE: Refer to the illustration for the location of the infrared (IR) remote control sensor(s).

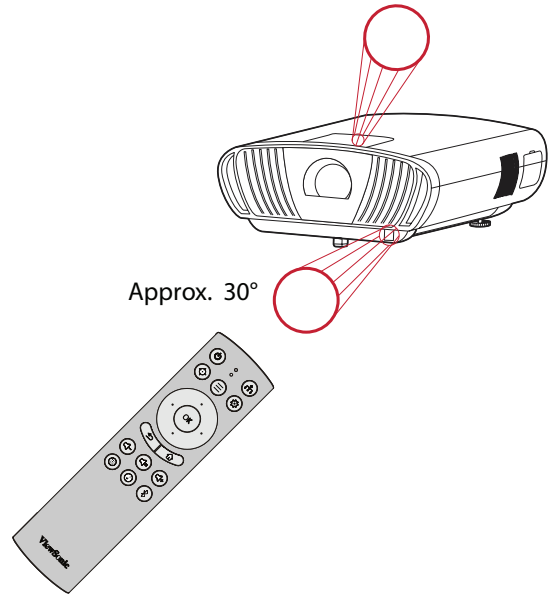

Remote Control - Replacing the Batteries

1. Remove the battery cover from the bottom of the remote control by pressing the finger grip and sliding it across.
2. Remove any existing batteries (if necessary) and install two AAA batteries.

NOTE: Observe the battery's polarities as indicated.

3. Replace the battery cover by aligning it with the base and pushing it back into position.

NOTE:

- Avoid leaving the remote control and batteries in excessive heat or a humid environment.
- Replace only with the same or equivalent type recommended by the battery manufacturer.
- If the batteries are drained or if you will not be using the remote control for an extended period of time, remove the batteries to avoid damage to the remote control.
- Dispose of the used batteries according to the manufacturer's instructions and local environment regulations for your region.

> Initial Setup

This section provides detailed instructions for the initial set up your projector.

Choosing a Location - Projection Orientation

Personal preference and room layout will decide the installation location. Consider the following:

- Size and position of your screen.
- Location of a suitable power outlet.
- Location and distance between the projector and other equipment.

The projector is designed to be installed in one of the following locations:

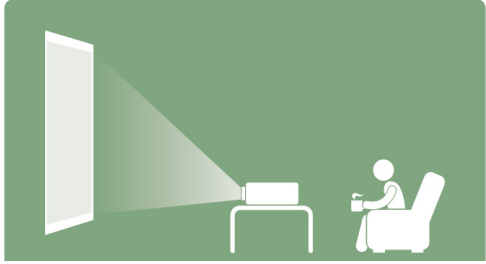
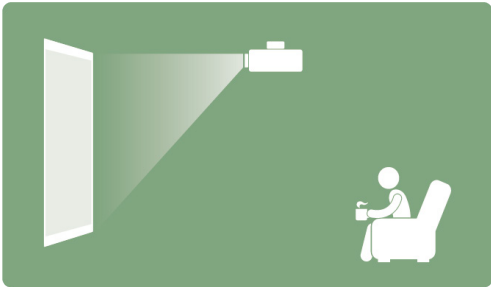
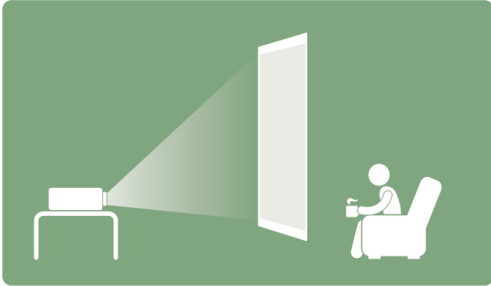
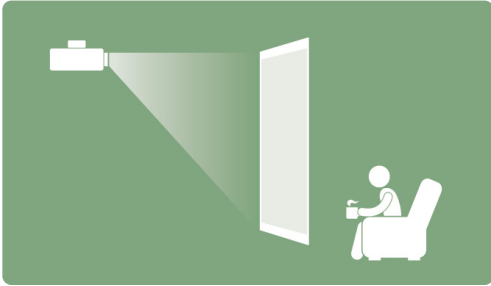
Location	
<p>Front Table</p> <p>The projector is placed near the floor in front of the screen.</p>	
<p>Front Ceiling</p> <p>The projector is suspended upside-down from the ceiling in front of the screen.</p>	
<p>Rear Table¹</p> <p>The projector is placed near the floor behind the screen.</p>	
<p>Rear Ceiling¹</p> <p>The projector is suspended upside-down from the ceiling behind the screen.</p>	

¹ A rear projection screen is required.

Projection Dimensions

- 16:9 Image on a 16:9 Screen

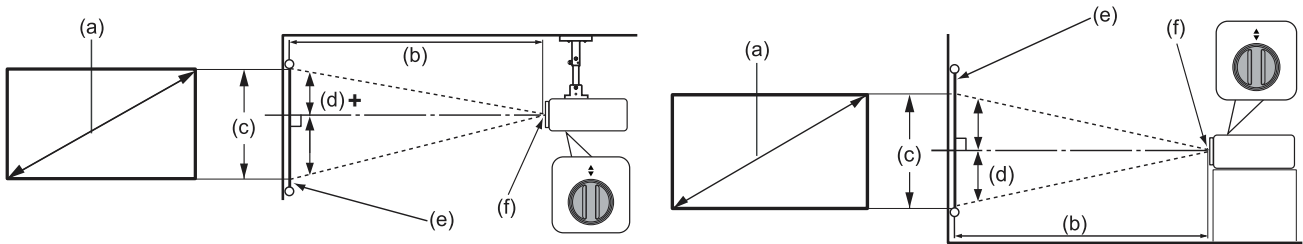

NOTE: (e) = Screen / (f) = Center of Lens

16:9 Image on a 16:9 Screen

(a) Screen Size		(b) Projection Distance				(c) Image Height		(d) Vertical Offset	
		Minimum		Maximum				Maximum	
in.	cm	in.	cm	in.	cm	in.	cm	in.	cm
40	101.6	41.84	106.3	50.29	127.5	19.61	49.8	12.75	32.4
60	152.4	62.75	159.4	75.3	191.3	29.42	74.7	19.12	48.6
70	177.8	73.21	186	87.85	223.2	34.32	87.2	22.31	56.7
80	203.2	83.67	212.5	100.41	255	39.22	99.6	25.49	64.8
90	228.6	94.13	239.1	113	286.9	44.12	112.1	28.68	72.8
100	254	104.59	265.7	125.51	318.8	49.03	124.5	31.87	80.9
120	304.8	125.51	318.8	150.61	382.5	58.83	149.4	38.24	97.1
150	381	156.88	398.5	188.26	478.2	73.54	186.8	47.8	121.4
200	508	209.18	531.3	251.01	637.6	98.05	249.1	63.73	161.9

NOTE: These figures are for reference purposes only. Please refer to the actual projector for the precise dimensions.

Mounting the Projector

NOTE: If you buy a third party mount, please use the correct screw size. Screw size can vary depending on the thickness of the mounting plate.

1. To ensure the most secure installation, please use a ViewSonic® wall or ceiling mount.
2. Ensure the screws used to attach the mount to the projector meet the following specifications:
 - Screw type: M6 x 8
 - Maximum Screw Length: 8 mm

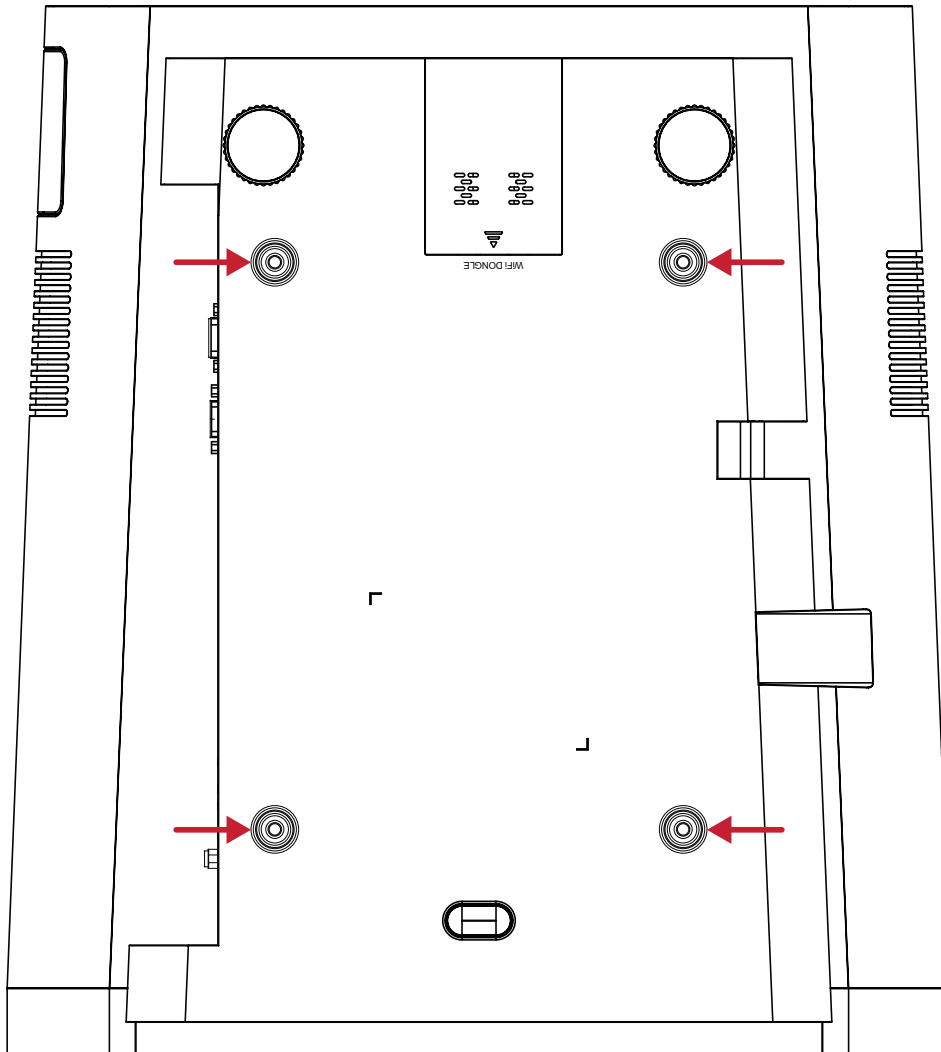

CAUTION:

- Avoid installing the projector near a heat source or air conditioner.
- Keep at least a 10 cm (3.9 in.) gap between the ceiling and the bottom of the projector.

> Making Connections

This section guides you on how to connect the projector with other equipment.

Connecting to Power

1. Connect the power cord to the AC IN jack at the rear of the projector.
2. Plug the power cord into a power outlet.

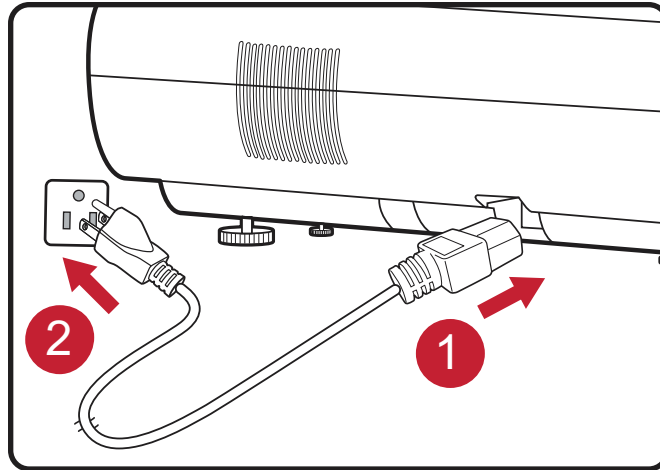

NOTE: When installing the projector, incorporate a readily accessible disconnect device in the fixed wiring, or connect the power plug to an easily accessible outlet near the unit. If a fault should occur during operation of the projector, use the disconnect device to switch off the power supply, or disconnect the power plug.

vRemote App

The vRemote App allows the user to control the projector via their personal mobile device. Users can change the input source, and mute/unmute or power on/off the projector.

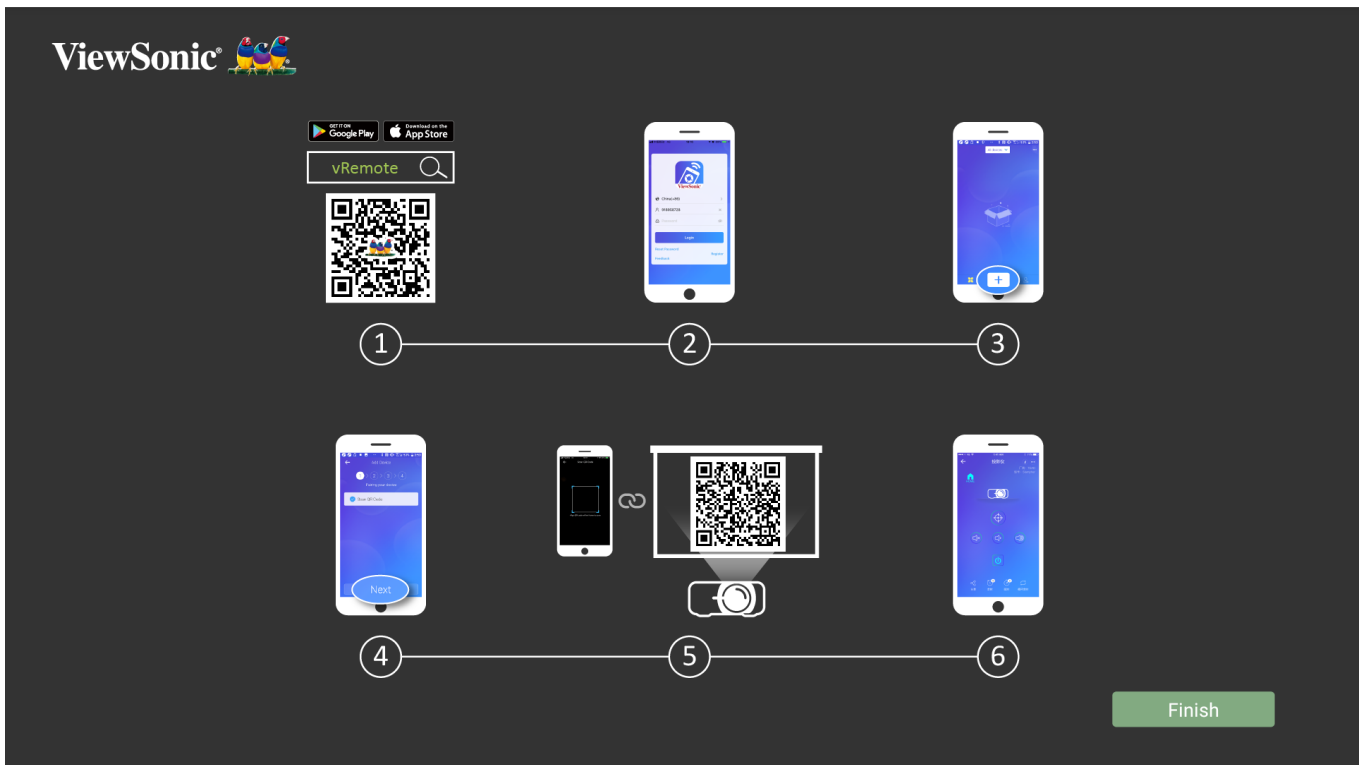

To use the vRemote App:

1. Download the App from Google Play or the Apple App Store and install it on your mobile device.
2. Enable, open, and login to the application.
3. Press the “Add Device” icon.
4. Press the “Next” icon.
5. Use the camera to scan the QR Code.
6. Now you are ready to control the projector.

Connecting to External Devices

HDMI Connection

Connect one end of an HDMI cable to the HDMI port of your video device. Then connect the other end of the cable to the **HDMI 1/2/3/4** port (each support HDCP 2.0/HDMI 2.2) of your projector.

NOTE: iPhone/iPad users will need to use an additional adapter.

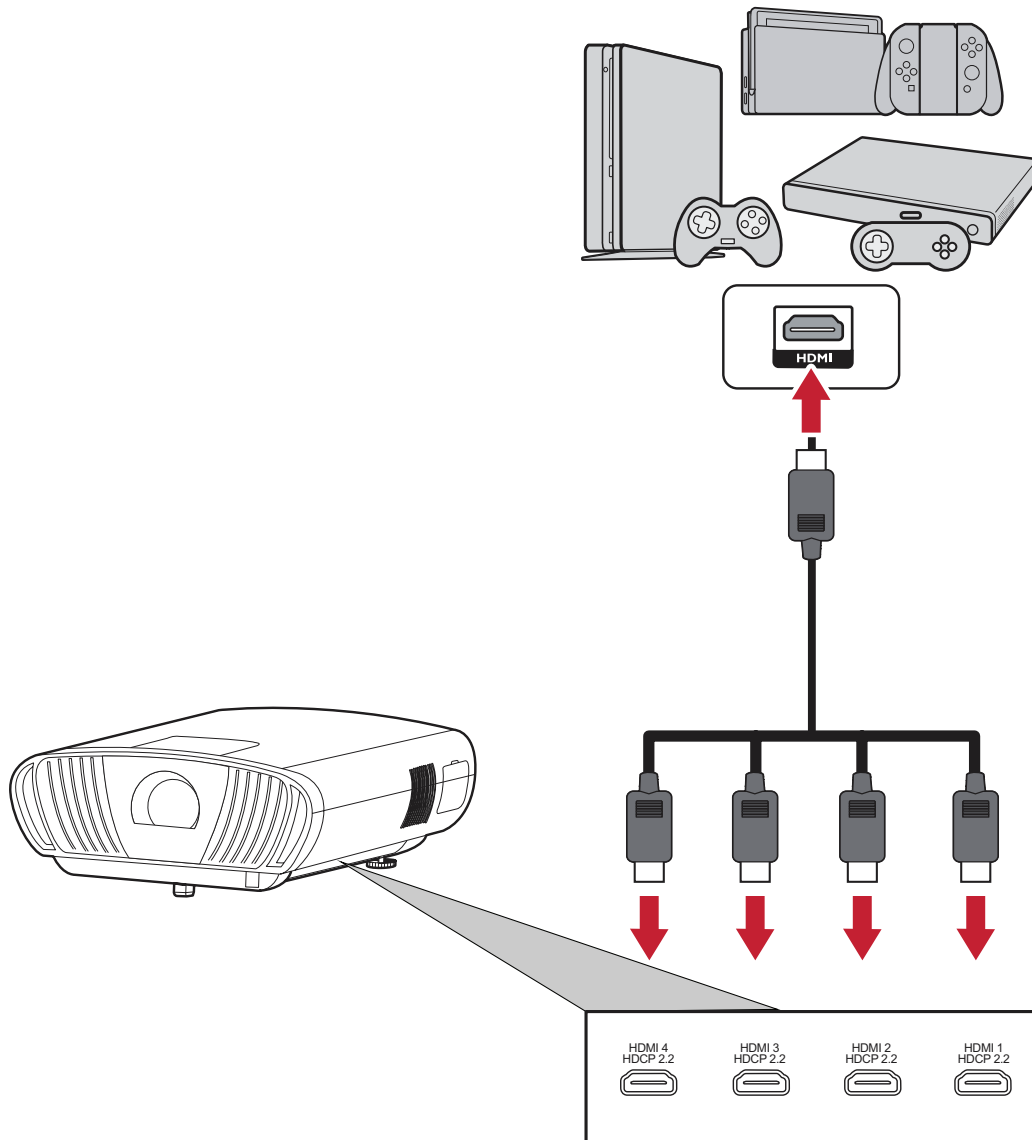

Audio Connection

You can connect to various external sound delivery devices via the **Audio Out**, **AUX** (Audio In), and **S/PDIF** ports.

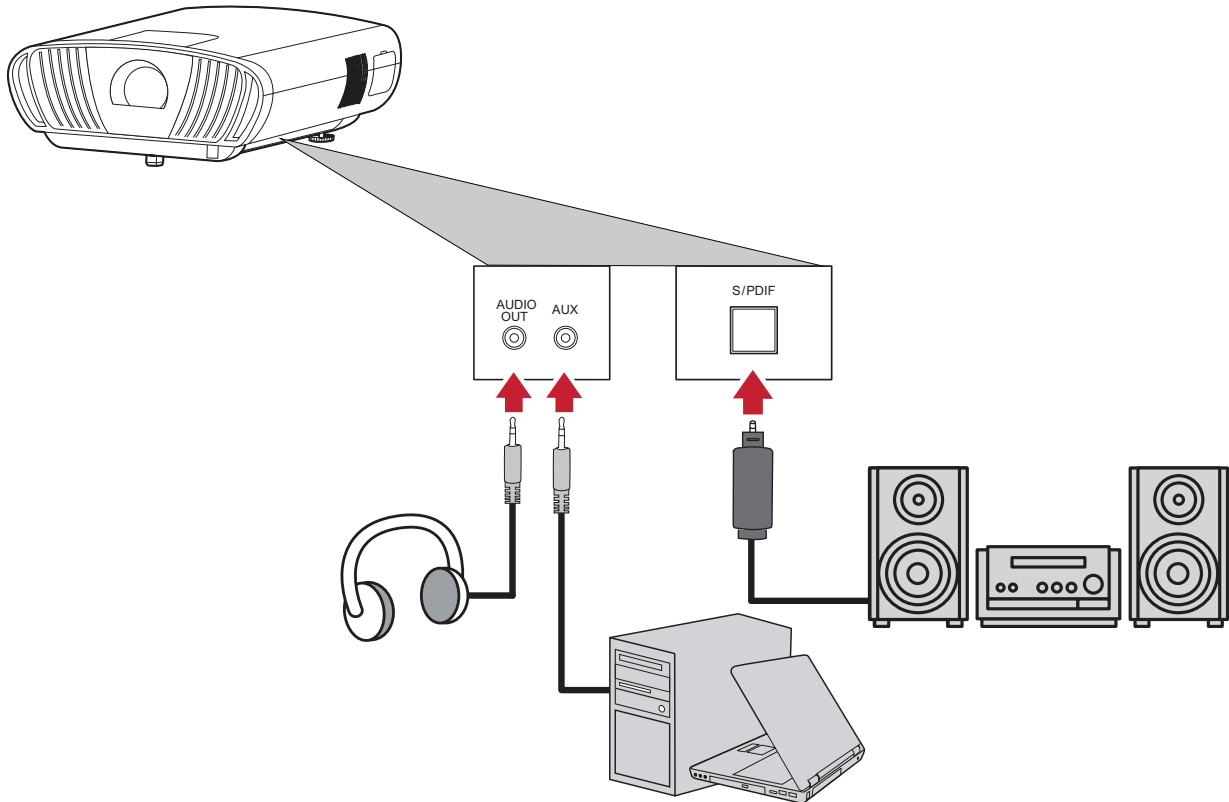

NOTE: AUX (Audio In) is available for VGA input only.

USB and Network Connection

Just like any PC, it is easy to connect various USB devices, dongles, and networking devices.

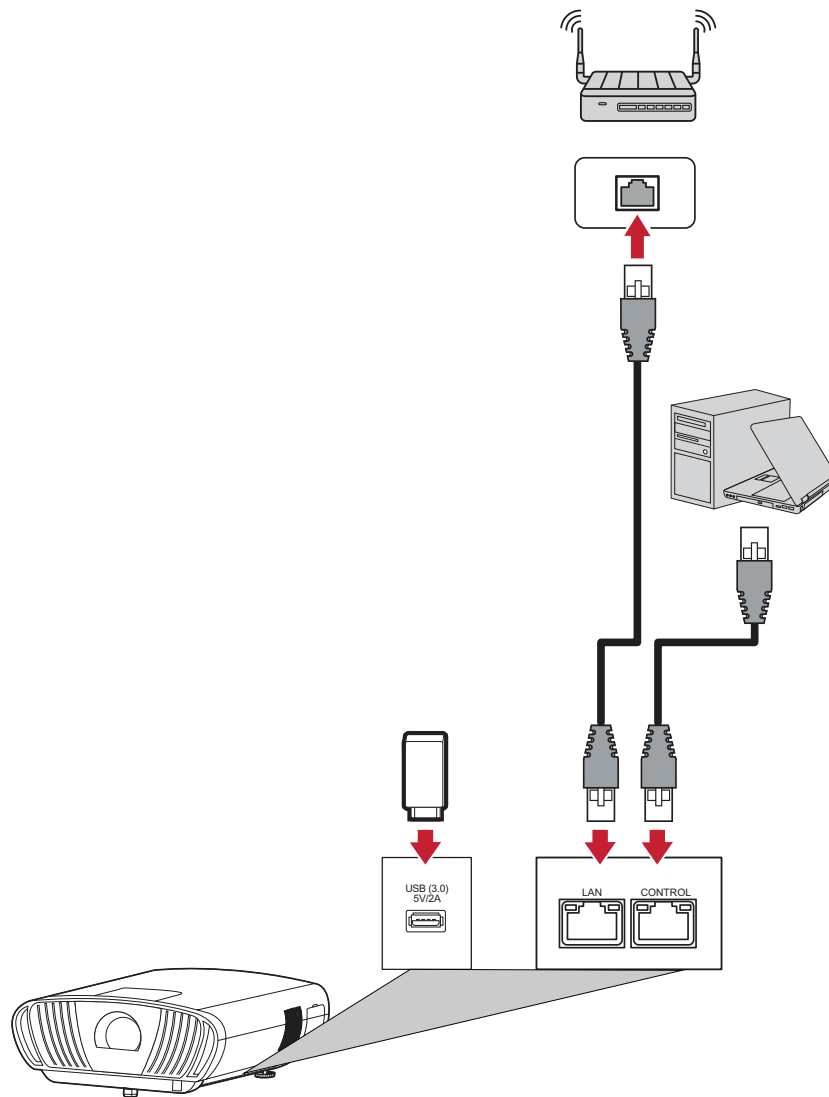

RS-232 Connection

When you use a RS-232 serial cable to connect your display to an external computer certain functions can be controlled remotely by the PC, including Power On/Off, Volume adjustment, Input select, Brightness, and more.

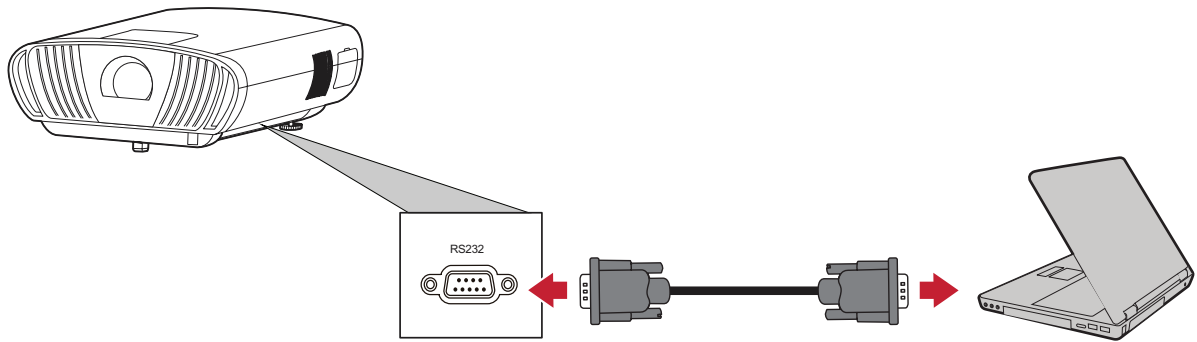

Additional Connection Options

The X100-4K also supports several additional and convenient connection options such as: 12V Trigger for screens and curtains, VGA for computer connection, and Wired IR for extending the IR receiver range.

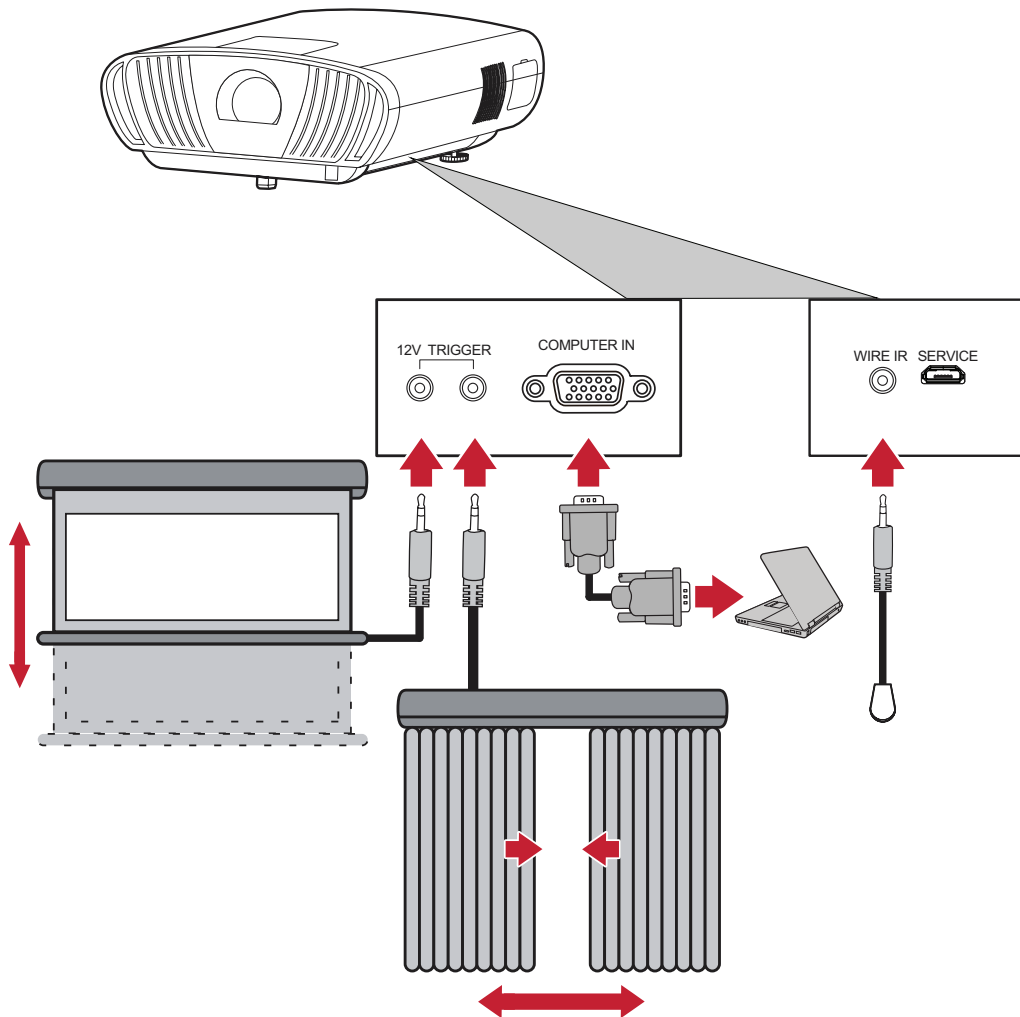

Wireless Screen Mirroring

Screen Mirroring provides a 5GHz Wi-Fi connection for users to mirror the screen on their personal device.

NOTE: Ensure your device is connected to the same network as the projector.



For iOS:

1. Access the drop down control menu.
2. Select the “Screen Mirroring” icon.
3. Choose “ViewSonic PJ-XXXX”.

For Android:

1. Download and install the “Google Home” application and open it.
2. Pull-to-refresh the app and wait for 30 seconds.
3. “ViewSonic PJ-XXXX” will now be visible, select it.

NOTE: Some Android devices support direct “Casting”. If your device does, go to the Casting feature and choose “ViewSonic PJ-XXX” from the list of available devices. You can also scan the FAQ QR code and follow the steps to directly cast your Android device.

Voice Control

The X100-4K projector is embedded with voice control technology, making projector control even easier. Voice Control allows the user to easily control the projector via Google Assistance or Alexa.

Alexa Voice Control

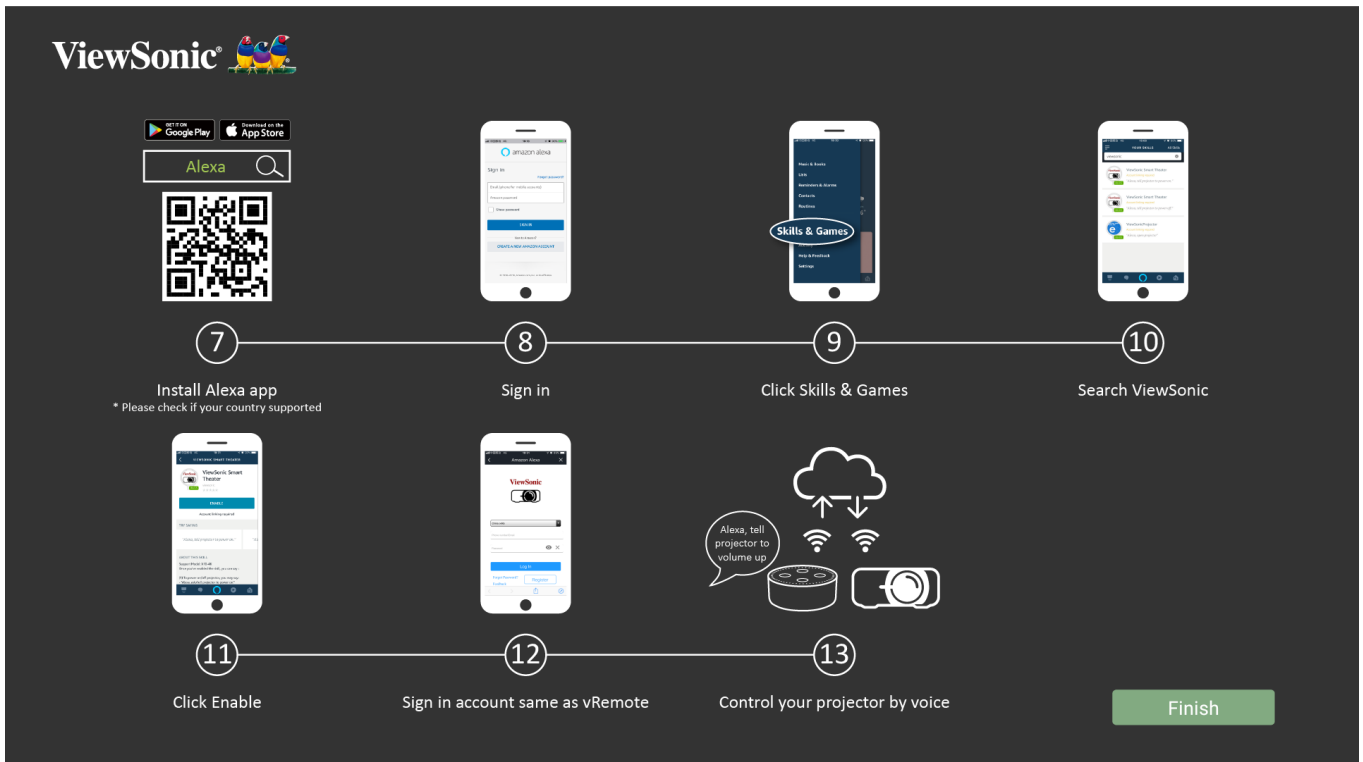

To enable Alexa Voice Control:

1. Ensure the vRemote App is installed and paired. Please refer to page 20, **steps 1-6.**

After installing and pairing the vRemote App:

7. Download the Alexa App from Google Play or the Apple App Store and install it on your mobile device.

8. Enable, open, and login to the application.

9. Select “Skills & Games” at the top-left bar.

10. Search for “ViewSonic” in “All Skills”.

NOTE: There are two skills, “ViewSonic Smart Theater” and “ViewSonic Advanced Smart Theater”.

11. Press the “Enable” icon.

12. Sign in with your vRemote App account.

13. Now you can control your projector by voice.

Alexa Voice Control Commands

ViewSonic Smart Theater

NOTE: The default name for [Device] is [My device12345]. However, please note “12345” is the device’s ID, and each device is different.

Command	Description
“Alexa, Turn On [Device].”	Power on the device
“Alexa, Turn Off [Device].”	Power off the device
“Alexa, Set volume of [Device] to [0~50].”	Adjust the Volume level
“Alexa, Mute [Device].”	Mute the Volume
“Alexa, Unmute [Device].”	Unmute the Volume
“Alexa, Change [Device] to HDMI [1/2/3/4] Input.”	Change the HDMI input source
“Alexa, set [Device] to HDMI [1/2/3/4] Input.”	Set the HDMI input source
“Alexa, set [Device] to Computer Input.”	Set the device to Computer input
“Alexa, set [Device] to Home Page.”	Go to the Home Screen

ViewSonic Advanced Smart Theater

Command	Description
“Alexa, Ask/Tell ViewSonic to Power On.”	Power on the device
“Alexa, Ask/Tell ViewSonic to Power Off.”	Power off the device
“Alexa, Ask/Tell ViewSonic to Volume Up.”	Increase the Volume level
“Alexa, Ask/Tell ViewSonic to Volume Down.”	Decrease the Volume level
“Alexa, Ask/Tell ViewSonic to Volume 0~50.”	Adjust the Volume level
“Alexa, Ask/Tell ViewSonic to Mute.”	Mute the Volume
“Alexa, Ask/Tell ViewSonic to Unmute.”	Unmute the Volume
“Alexa, Ask/Tell ViewSonic to HDMI 1.”	Set the HDMI input source
“Alexa, Ask/Tell ViewSonic to HDMI 2.”	Set the HDMI input source
“Alexa, Ask/Tell ViewSonic to HDMI 3”	Set the HDMI input source
“Alexa, Ask/Tell ViewSonic to HDMI 4”	Set the HDMI input source
“Alexa, Ask/Tell ViewSonic to Home.”	Go to the Home Screen
“Alexa, Ask/Tell ViewSonic to Computer.”	Set the device to Computer input

NOTE: ViewSonic Advanced Smart Theater is recommended as more commands are available.

Google Assistant Voice Control

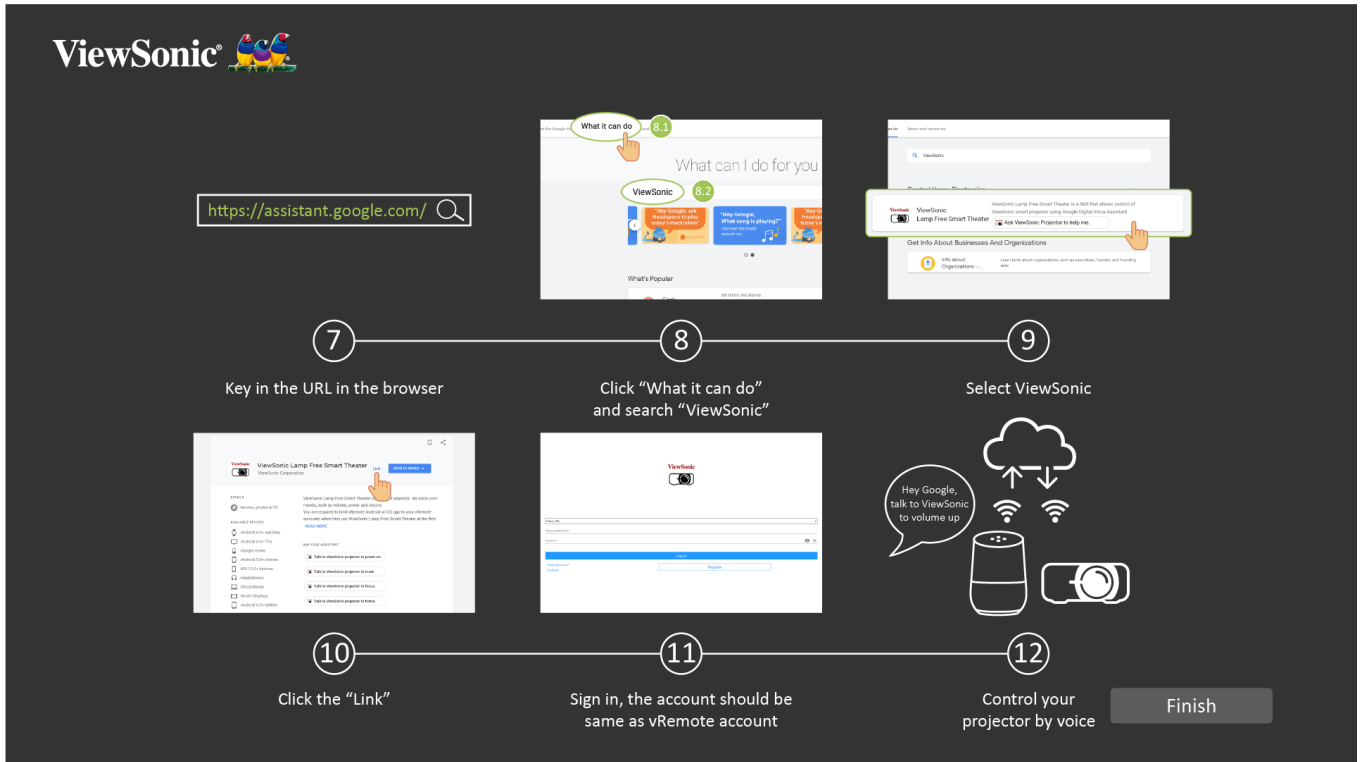

To enable Google Assistant Voice Control:

1. Ensure the vRemote App is installed and paired. Please refer to page 20, **steps 1-6.**

After installing and pairing the vRemote App:

7. Open your web browser and go to: <https://assistant.google.com>.

8. Click, "What it can do" and search for "ViewSonic".

9. Select "ViewSonic Lamp Free Smart Theater".

10. Click the "Link".

11. Sign in with your vRemote App account.

12. Now you can control your projector by voice.

Google Assistant Voice Control Commands

Command	Description
“Hey Google, talk to ViewSonic to Power On.”	Power on the device
“Hey Google, talk to ViewSonic to Power Off.”	Power off the device
“Hey Google, talk to ViewSonic to Volume Up.”	Increase the Volume level
“Hey Google, talk to ViewSonic to Volume Down.”	Decrease the Volume level
“Hey Google, talk to ViewSonic to set Volume to [0~50].”	Adjust the Volume level
“Hey Google, talk to ViewSonic to Mute.”	Mute the Volume
“Hey Google, talk to ViewSonic to Unmute.”	Unmute the Volume
“Hey Google, talk to ViewSonic to change input to [HDMI1/2/3/4].”	Set the HDMI input source
“Hey Google, talk to ViewSonic to change input to Computer.”	Set the Computer input source
“Hey Google, talk to ViewSonic to Home.”	Go to the Home Screen

Connecting to Networks

Wi-Fi Connection

A Wi-Fi dongle is an optional accessory for the X100-4K. You can follow the below steps to set the connection.

To connect to a Wi-Fi network:

1. Insert the Wi-Fi dongle into the projector's Wi-Fi dongle socket.
2. Go to: **Home > Settings > Network Settings > Wi-Fi**
3. Press **Left** or **Right** on the remote control to select **On**.



4. Available Wi-Fi networks will then be displayed. Select one of the available Wi-Fi networks.



5. If you connect to a secure Wi-Fi network, you must enter the password when prompted.



Custom SSID

1. Ensure the Wi-Fi dongle is plugged into the projector's Wi-Fi dongle socket.
2. Go to: **Home > Settings > Network Settings > Wi-Fi**
3. Press **Left** or **Right** on the remote control to select **On**.
4. From the available Wi-Fi networks list select **Others** and press **OK** on the remote control.



5. Enter the SSID and select the security level.



6. Enter the password when prompted.

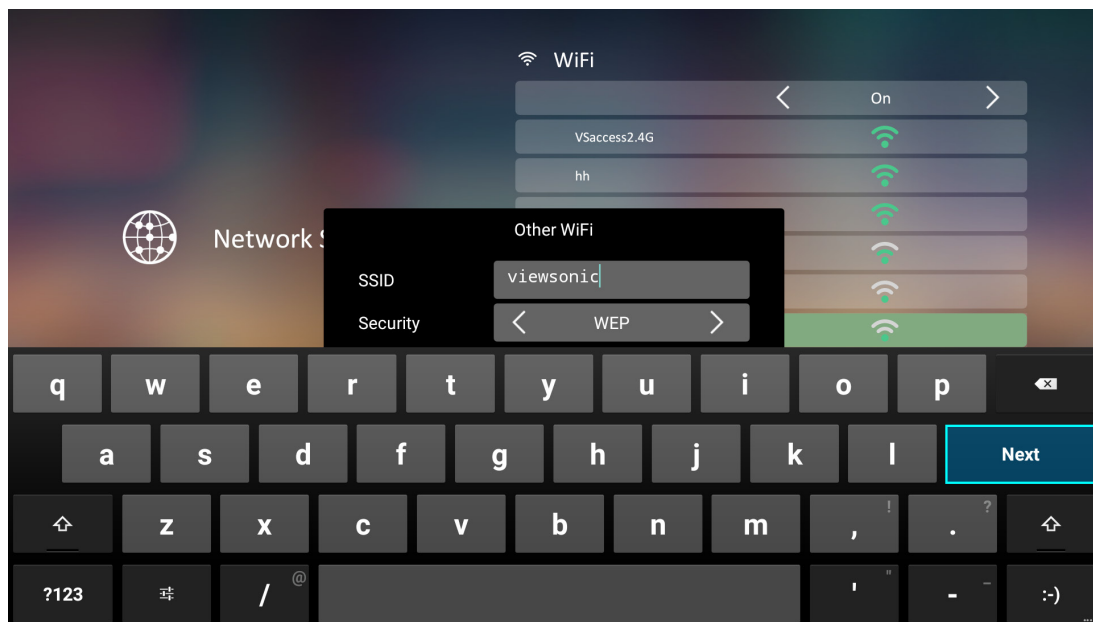

Wired LAN Connection

You can easily connect to wired Internet networks and customize the connection as well.

1. Plug the RJ45 cable into the **LAN** port of the projector, then ensure the other end is plugged into your wired Internet source.
2. Go to: **Home > Settings > Network Settings > Wired LAN Control**



3. You can Configure the IP automatically or manually. Choosing **Manual** will allow access to **IP Address, Subnet Mask, Default Gateway, and DNS Server.**

NOTE: It is recommended to let the system configure the network settings automatically by choosing **Automatic** for **Configure IP.**

> Using the Projector

Starting Up the Projector

1. Ensure the projector's power cord is properly connected to a power outlet.
2. Press the **Power** button to turn on the projector.

NOTE: The Status LED will be blue during startup.

First Time Activation

If the projector is activated for the first time, you will need to select your Preferred Language, Projection Orientation, Network Settings, and Source Input. Follow the on-screen instructions using the **OK** and **Up/Down/Left/Right** buttons on the remote control. When the Finish screen appears, this indicates the projector is ready to use.

Preferred Language

Select the desired language and press **OK** to confirm the selection.



Projection Orientation

Select the preferred projection orientation and press **OK** to confirm the selection.
For more information, see page 16.

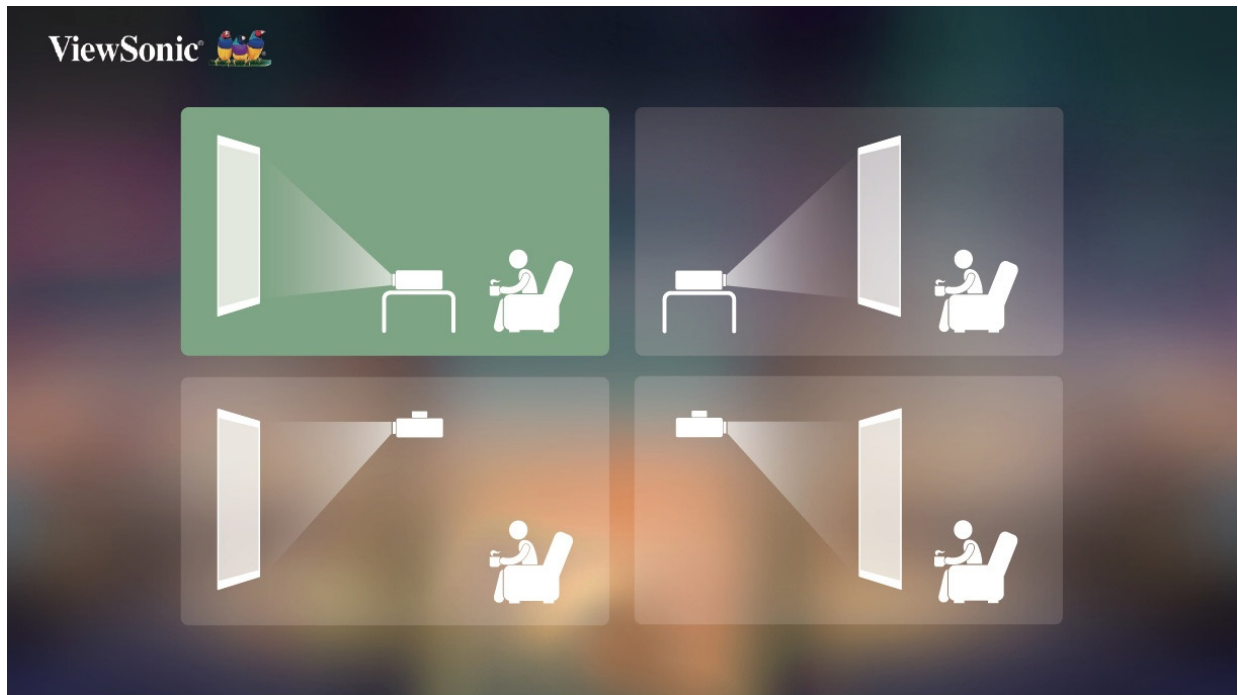

Source Input

Quickly access the **Source Input** menu by pressing the **Down** button on the remote control when at the **Home Screen**. Additionally, you can press the **Source** button on the remote control. For more information, see page 39.



Selecting an Input Source

The projector can be connected to multiple devices at the same time. However, it can only display one full screen at a time.

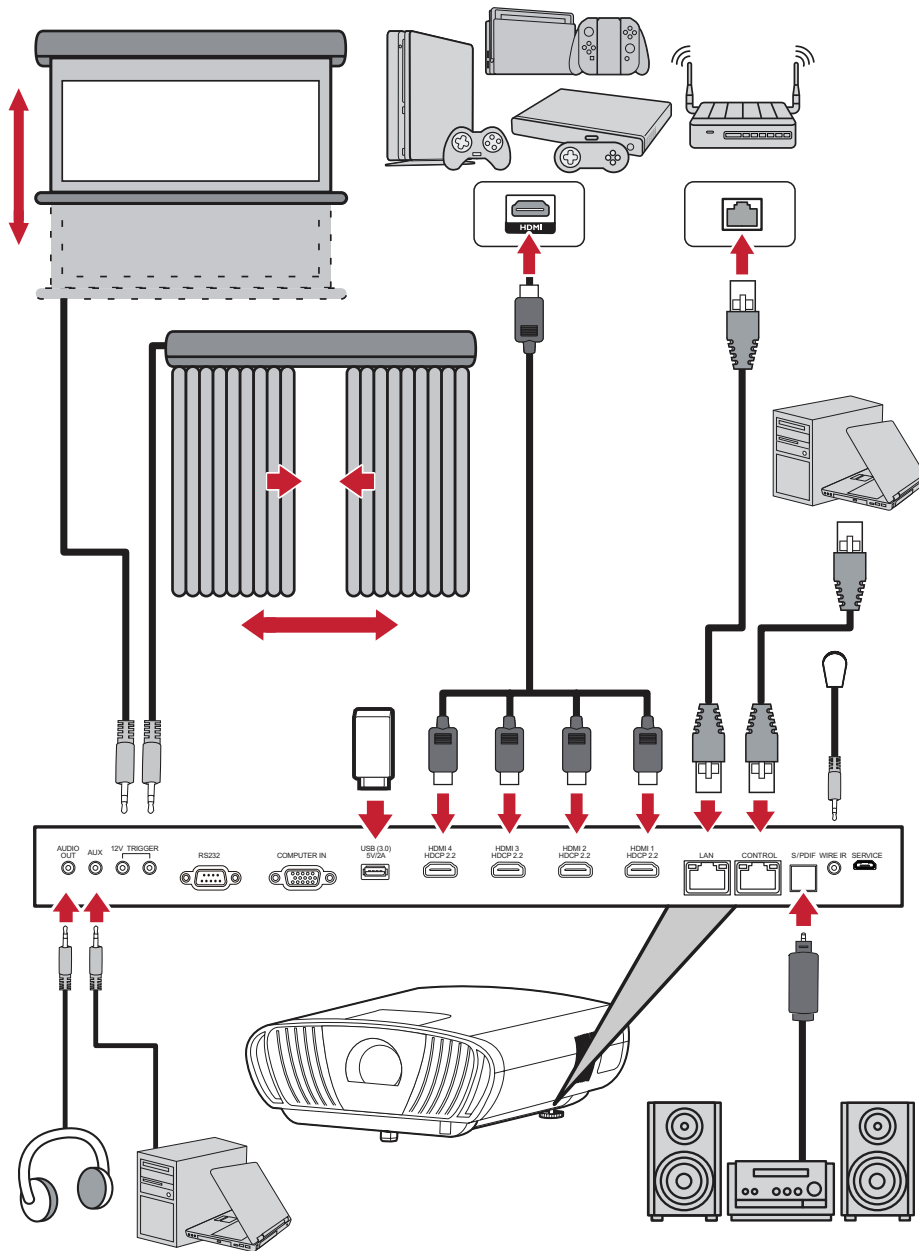

The projector will automatically search for input sources. If multiple sources are connected, press the **Source** button on the remote control to select the desired input, or press the **Down** button when at the **Home Screen** until the source list is displayed.

NOTE: Ensure the connected sources are also turned on.

Adjusting the Projected Image

Adjusting the Projector's Height and Projection Angle

The projector is equipped with two (2) adjuster feet. Adjusting the feet will change the projector's height and the vertical projection angle.

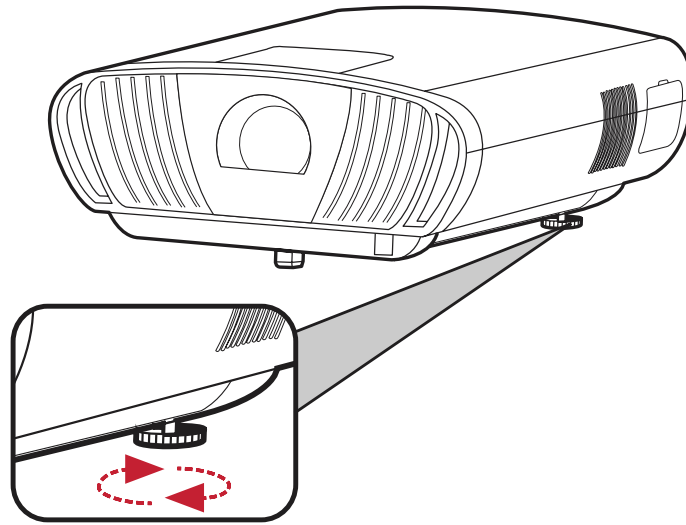

Fine-Tuning the Image Size and Clarity

To adjust the projected image to the size that you need, rotate the **Zoom ring**.

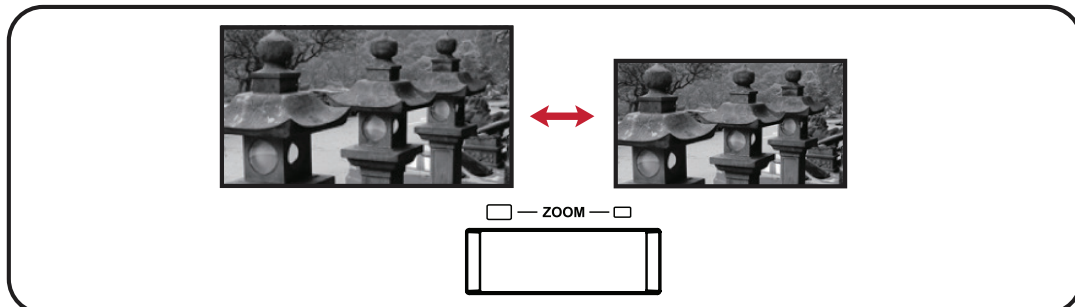

You can also improve the clarity of the image by pressing the **Focus** button, then using the Left and Right buttons on the remote control.

Controlling the Projected Image

By using the **Lens Shift Knobs** on the projector, you can adjust the vertical lens shift by +65% or the horizontal lens shift by +/- 25%, which offers the convenience of not needing to physically move or interact with the projector. This is especially important when the projector is mounted to the ceiling.

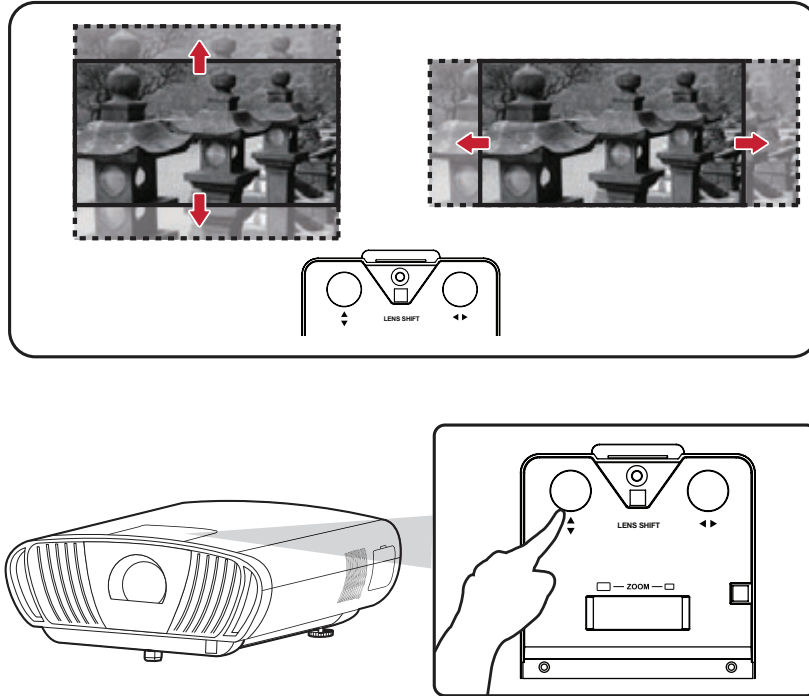

CAUTION: Do not rotate the lens shift knob any further when you hear the click sound. Overturning the knob may cause damage. Press down on the lens shift knob to rotate back.

Lens Shift Guideline

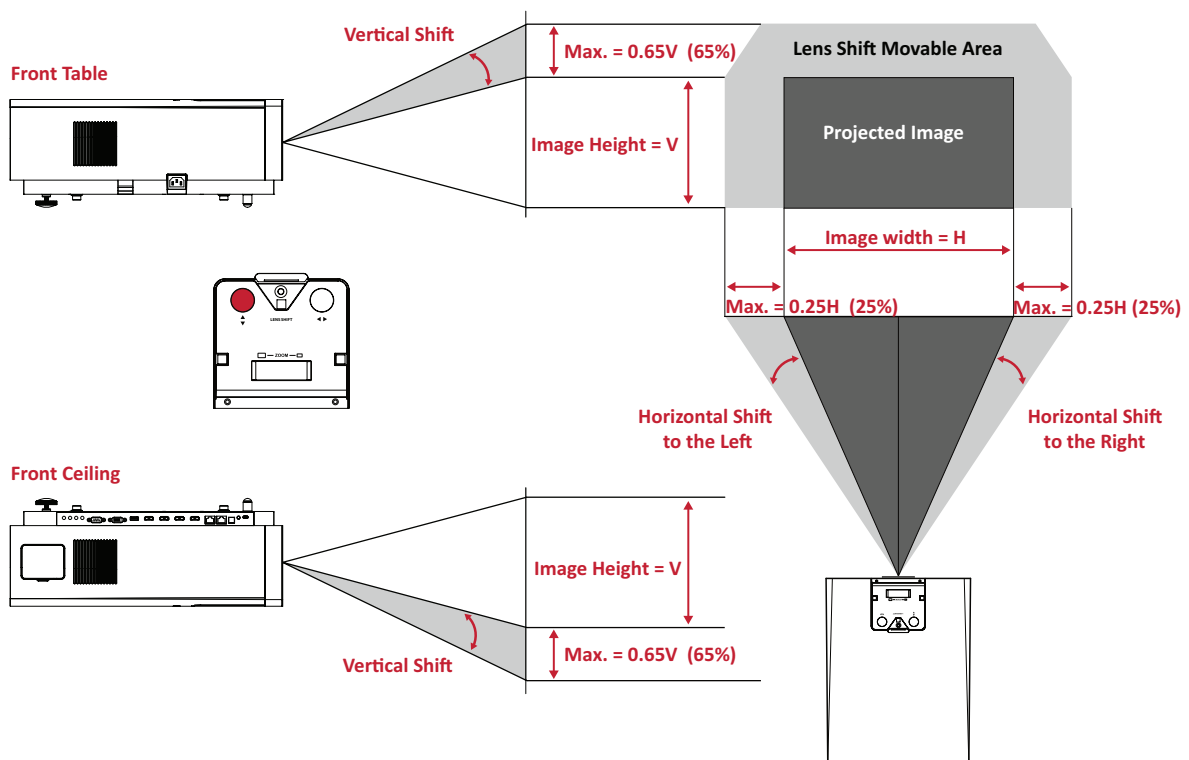

Shutting Down the Projector

1. Press the **Power** button on the projector or remote control and the following message will appear:

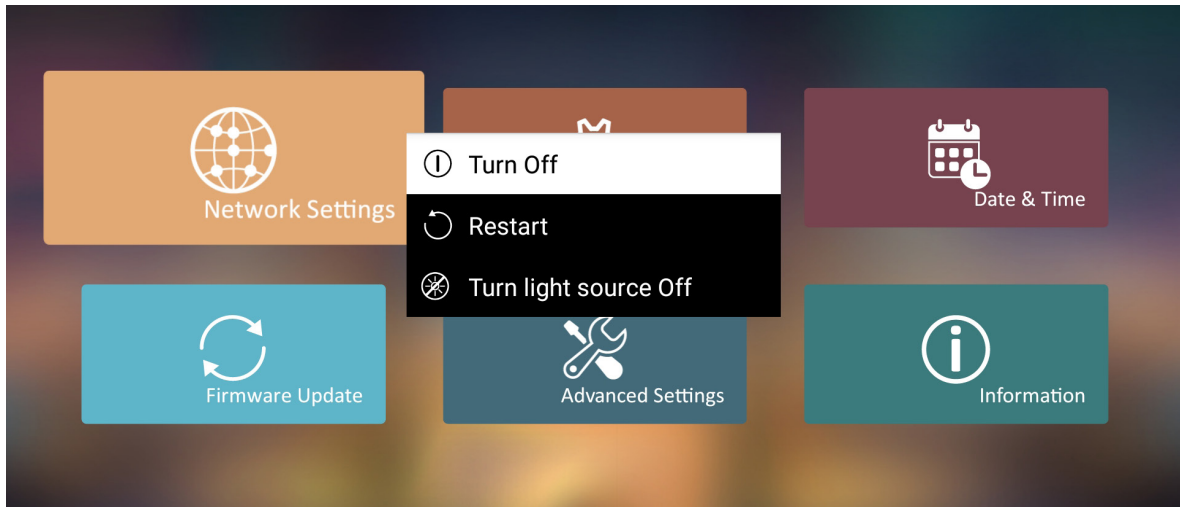

2. Press the **Up/Down** buttons on the remote control to select **Turn Off** and press **OK** on the remote control.
3. The Status LED will turn solid red once turned off.

NOTE: When pressing **Power** on the remote control, you can choose from three options: Turn Off, Restart, and Turn light source Off.

Input Source Selected - On-Screen Display (OSD) Tree

After your input source is selected, you can adjust the **Image Setting** and **Advanced** menus.

Main Menu	Sub-menu	Menu Option		
Image Setting	Color Mode	Brightest		
		TV		
		Movie		
		Gaming		
		User 1		
		User 2		
		ISF Day		
		ISF Night		
	Brightness	(-/+ , 0~100)		
	Contrast	(-/+ , -50~50)		
	Color Temp	6500K		
		7500K		
		9300K		
		User	Red Gain	(-/+ , 0~199)
			Green Gain	(-/+ , 0~199)
			Blue Gain	(-/+ , 0~199)
			Red Offset	(-/+ , 0~199)
	Green Offset		(-/+ , 0~199)	
	Blue Offset	(-/+ , 0~199)		
	Tint	(-/+ , -99~99)		
	Saturation	(-/+ , 0~199)		
	Sharpness	(-/+ , 0~31)		
	Gamma	1.8		
2.0				
2.2				
2.35				
2.5				
sRGB				
Cubic				

Main Menu	Sub-menu	Menu Option		
Image Setting	Color Management	Primary Color	Red	
			Green	
			Blue	
			Cyan	
			Magenta	
			Yellow	
		Hue	(-/+ , -99~99)	
		Saturation	(-/+ , 0~199)	
		Gain	(-/+ , 0~195)	
		Phase		
		Vertical Position		
		Horizontal Position		
		ISF Setting	Off	
			On	
		ISF Mode	Enable	
			Disable	
		Light Source Level	Full	
			Eco	
			Dynamic Black 1	
			Dynamic Black 2	
	Reset ISF Current Color Calibration	Ok		
		Cancel		
	Test Pattern	Ok		
	Reset Current Color Settings	Ok		
		Cancel		

Main Menu	Sub-menu	Menu Option	
Advanced	Aspect Ratio	Auto	
		4:3	
		16:9	
		16:10	
		2.35:1	
		Anamorphic	
		Native	
	HDR	Auto	
		SDR	
	EOTF	Low	
		Mid	
		High	
	Frame Interpolation	Low	
		Mid	
		High	
		Off	

Main Menu	Sub-menu	Menu Option		
Advanced	HDMI Range	Auto		
		Full		
		Limited		
	3D Settings	3D Sync	Auto	
			Off	
		3D Sync Invert	Disable	
			Invert	
	harman/kardon	Audio Mode	Movie	
			Music	
			User	
		100Hz		
		500Hz		
		1500Hz		
		5000Hz		
		10000Hz		
		Audio Volume	(-/+ , 0~50)	
		Mute	Off	
			On	
		S/PDIF	Off	
			On	
	Information	Source		
		Resolution		
		3D Format		
HDR				

Image Setting Menu

To access the **Image Setting** menu:

1. Press **Setting** on the remote control.

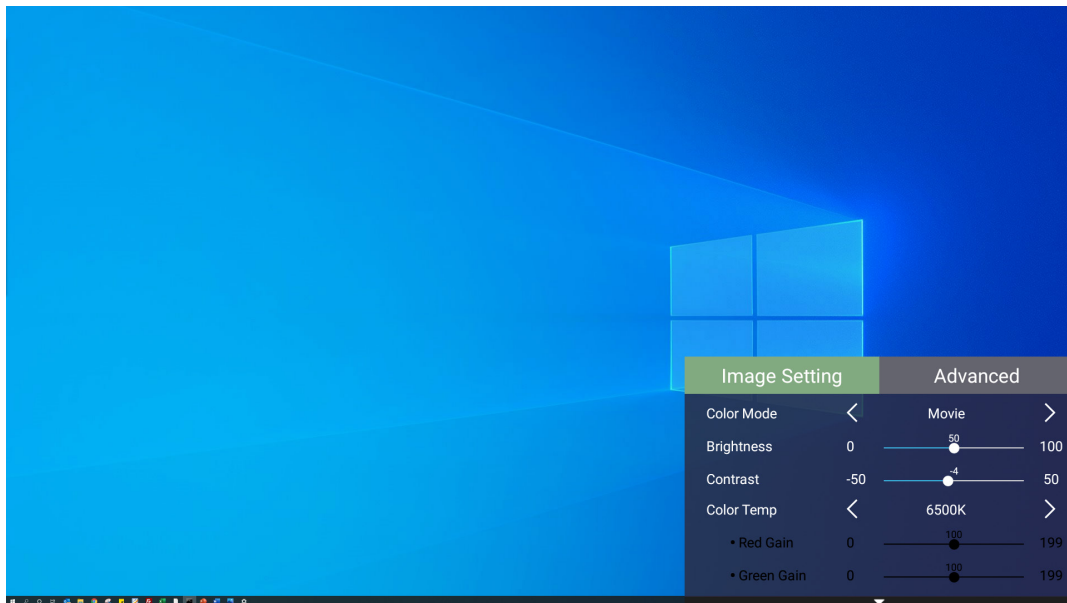

2. Use the **Up/Down** buttons to select a menu.

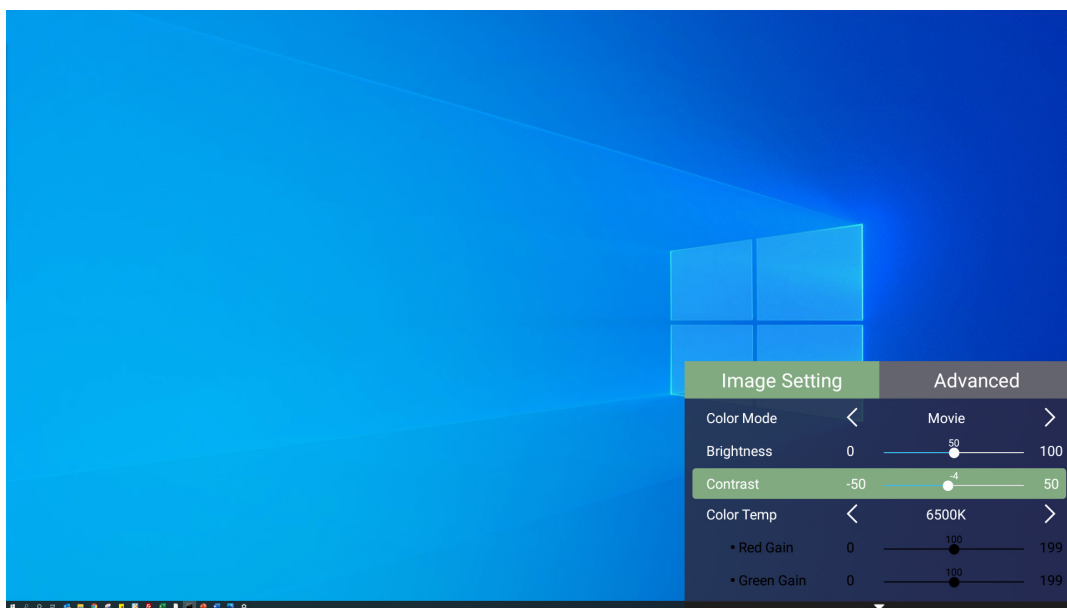

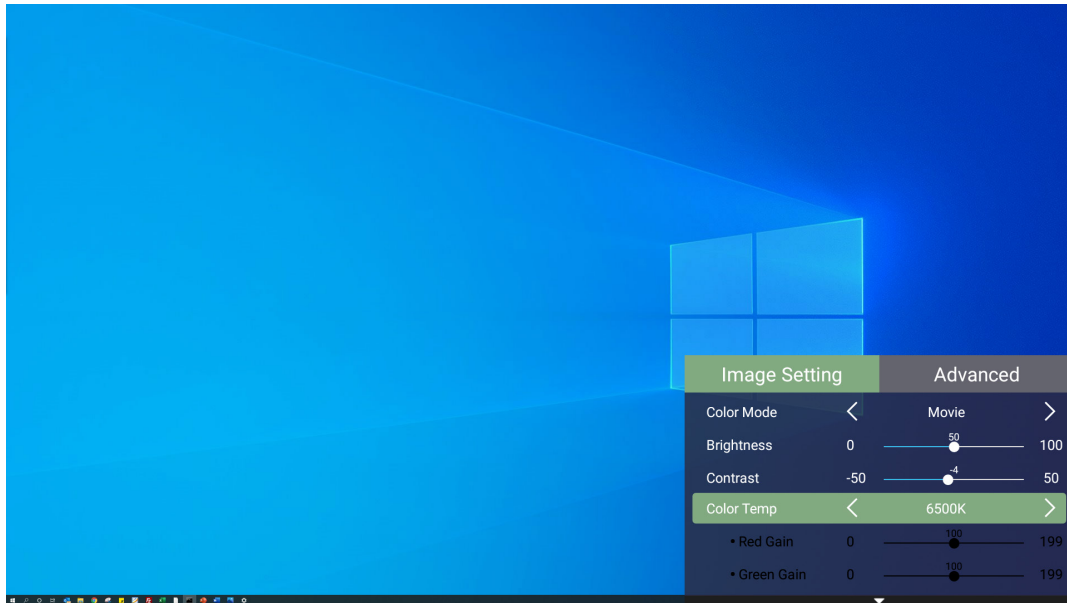



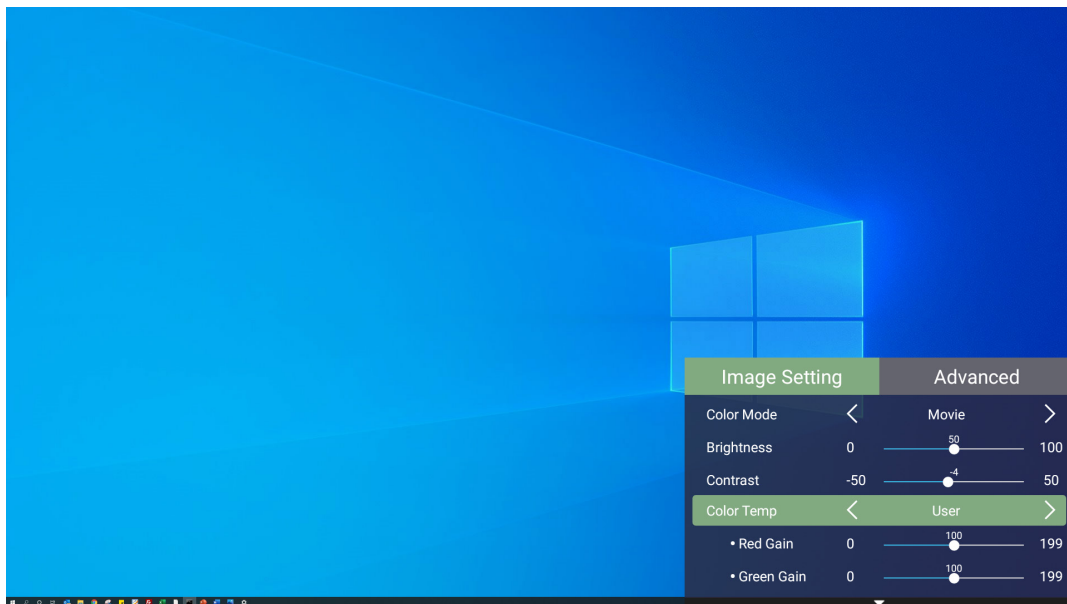

3. Then use the **Left/Right** buttons to enter the sub-menu(s) and/or adjust the settings.



4. Press the **Return** button to go to the previous menu or exit.

Menu Option	Description
Color Mode	<p>The projector is preset with several predefined picture modes so that you can choose one to suit your operating environment and input signal.</p> <p><u>Brightest</u> Maximizes the brightness of the projected image. This mode is suitable for environments where extra-high brightness is required, i.e. well-lit rooms.</p> <p><u>TV</u> Optimized for viewing sports in well-lit environments.</p> <p><u>Gaming</u> Designed for playing video games.</p> <p><u>Movie</u> Appropriate for colorful movies, video clips from digital cameras, or DVs through the PC input. Best for low-light environments.</p> <p><u>User 1/User 2</u> Recalls the customized user settings.</p> <p><u>ISF Day/ISF Night</u> The X100-4K provides the calibration tools to allow ISF-certified technicians to provide on-site tuning of Day and Night modes to fit each user's requirement in bright and dark environments.</p>
Brightness	<p>The higher the value, the brighter the image. Lower values will result in a darker image.</p> <div style="display: flex; justify-content: space-around; align-items: flex-end;"> <div style="text-align: center;">  <p>██████████ -30</p> </div> <div style="text-align: center;">  <p>██████████ 50</p> </div> <div style="text-align: center;">  <p>██████████ +80</p> </div> </div>

Menu Option	Description
Contrast	<p>Use this to set the peak white level after you have previously adjusted the Brightness setting to suit your selected input and viewing environment.</p> <div style="text-align: center;">  </div>
Color Temp	<p>Select the color temperature setting.</p> <ul style="list-style-type: none"> • 6500K: Maintains normal white coloring. • 7500K: A higher, cooler color temperature than 6500K. • 9300K: The highest color temperature; makes the image appear the most bluish-white. • User Color: Adjust red, green, and blue values as desired.
Tint	<p>The higher the value, the more greenish the picture becomes. The lower the value, the more reddish the picture becomes.</p>
Saturation	<p>Refers to the amount of that color in a video picture. Lower settings produce less saturated colors; in fact, a setting of “0” removes that color from the image entirely. If the saturation is too high, that color will be overpowering and unrealistic.</p>
Sharpness	<p>A high value results in a sharper picture; a low value softens the picture.</p>
Gamma	<p>Reflects the relationship between input source and picture brightness.</p>

Menu Option	Description
Color Management	<p>Only in permanent installations with controlled lighting levels such as: boardrooms, lecture halls, or home theaters should Color Management be considered.</p> <div data-bbox="676 331 1246 869" data-label="Diagram"> </div> <p>Color Management provides fine color control adjustment to allow for more accurate color reproduction, should you require it.</p> <p>If you have purchased a test disc, which contains various color test patterns and can be used to test the color presentation on monitors, TVs, projectors, etc., you can project any image from the disc on the screen and enter the Color Management menu to make adjustments.</p>
Phase	<p>Adjusts the clock phase to reduce image distortion.</p> <p>NOTE: This function is only available when a PC input signal is selected.</p>
Position	<p>Adjust the position of the projected image.</p> <p>NOTE:</p> <ul style="list-style-type: none"> • This function is only available when a PC input signal is selected. • The adjustment range may vary under different timings.
ISF Setting	<p>Enable the ISF menu for ISF customized image calibration. If requested, the <u>ISF Passcode</u> is: Up, Down, Up, Down, Left, Right.</p>
ISF Mode	<p>Enable/disable “ISF Day/ISF Night” from the color mode menu.</p>

Menu Option	Description
Light Source Level	Select the suitable power consumption of the LED.
Reset ISF Current Color Calibration	Return the calibration settings to their default values.
Test Pattern	Test the color presentation of the projector.
Reset Current Color Settings	Return current color settings to their default values.

Advanced Setting Menu

To access the **Advanced** menu:

1. Press **Setting** on the remote control.

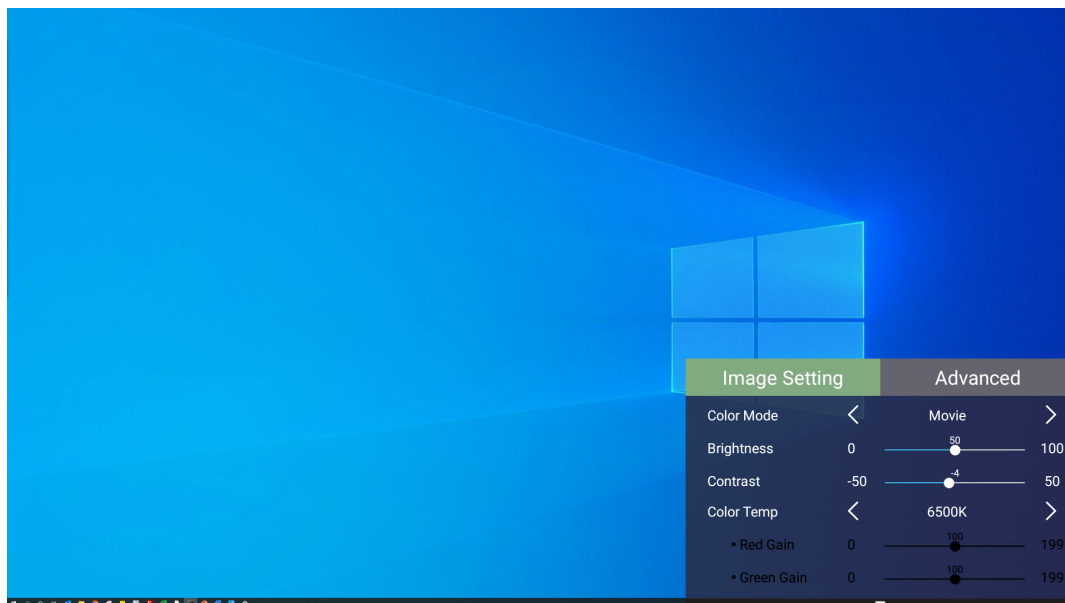

2. Press the **Right** button to access the **Advanced** menu.

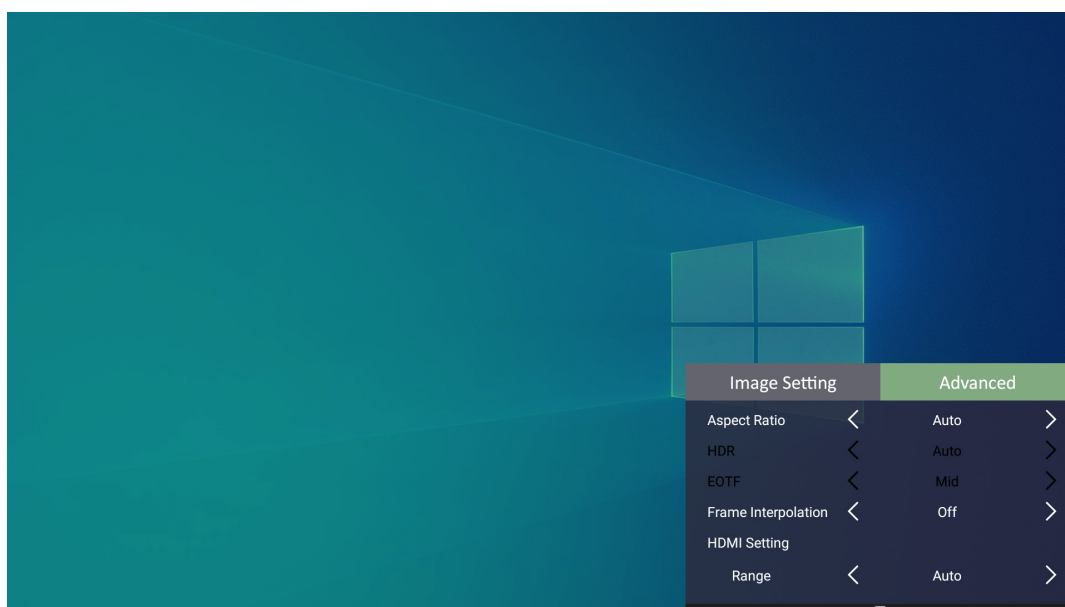

3. Use the **Up/Down** buttons to select a menu.

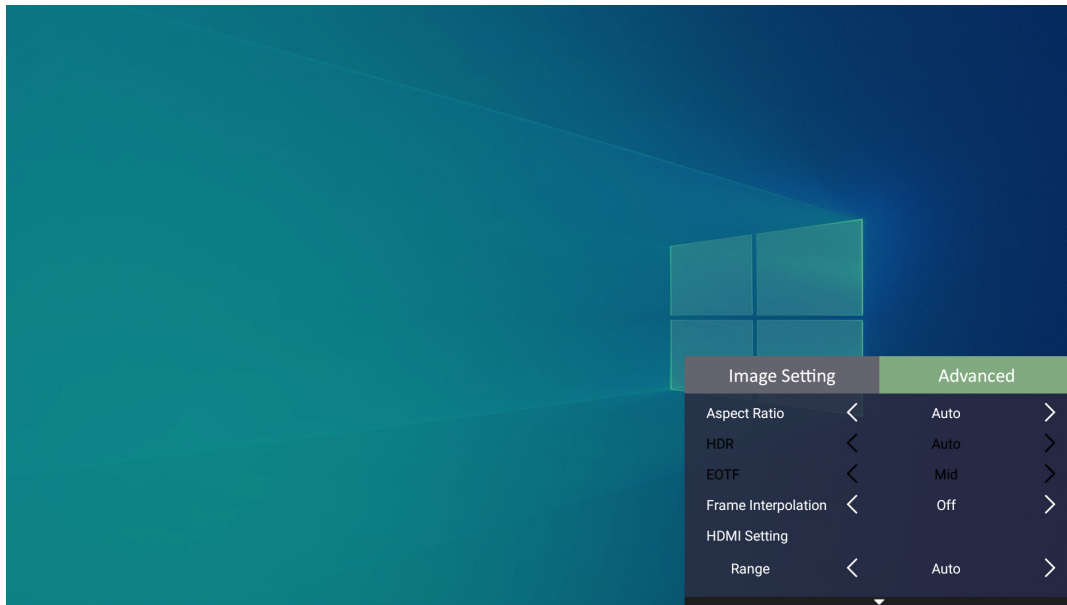

4. Then use the **Left/Right** buttons to enter the sub-menu(s) and/or adjust the settings.

5. Press the **Return** button to go to the previous menu or exit.

Menu Option	Description
Aspect Ratio	<p>The Aspect Ratio is the ratio of the image width to the image height. With the advent of digital signal processing, digital display devices, like this projector, can dynamically stretch and scale the image output to a different aspect than that of the image input signal.</p> <p>NOTE: Only supports HDMI/Computer signal input.</p> <p><u>Auto</u> Scales an image proportionally to fit the projector's native resolution in its horizontal width. This is suitable for the incoming image which is neither 4:3 nor 16:9 and you want to make the most use of the screen without altering the image's aspect ratio.</p> <p><u>4:3</u> Scales an image so that it is displayed in the center of the screen with a 4:3 aspect ratio. This is most suitable for 4:3 images like computer monitors, standard definition TV, and 4:3 aspect DVD movies, as it displays them without aspect alteration.</p> <p><u>16:9</u> Scales an image so that it is displayed in the center of the screen with a 16:9 aspect ratio. This is most suitable for images which are already in a 16:9 aspect, like high definition TV.</p> <p><u>16:10</u> Scales an image so that it is displayed in the center of the screen with a 16:10 aspect ratio. This is most suitable for images which are already in a 16:10 aspect.</p>

Menu Option	Description
Aspect Ratio	<p><u>Native</u> Projects the image as its original resolution and resizes it to fit within the display area. For input signals with lower resolutions, the projected image will be displayed in its original size.</p> <p><u>2.35:1</u> Scales a 2.35:1 aspect image so that it fills the screen.</p> <p><u>Anamorphic</u> Scales an image so that it is displayed in the center of the screen with a 2.40:1 aspect ratio.</p>
HDR	<p>The projector supports HDR imaging. It can automatically detect the dynamic range of the source from the HDMI 1/2/3/4 ports, and optimize settings to reproduce contents under a wide range of light conditions.</p>
EOTF	<p>Automatically adjusts the brightness levels of your image according to the input source. You can also manually select a brightness level to display better picture quality.</p> <p>NOTE: This function is not available when SDR is selected in the HDR menu.</p>
Frame Interpolation	<p>Smooths the picture quality of high speed moving objects. This is especially for users who enjoy fast paced sporting events.</p>
HDMI Settings	<p><u>Range</u> Select a suitable color range according to the color range setting of the connected output device.</p> <ul style="list-style-type: none"> • Full: Sets the color range from 0~255. • Limited: Sets the color range from 15~235 • Auto: Sets the projector to detect the range of the input signal automatically.

Menu Option	Description
3D Settings	<p>Enables you to enjoy 3D movies, videos, and sporting events in a more realistic way by presenting the depth of the images while wearing 3D glasses. For Blu Ray 3D.</p> <p><u>3D Sync</u> Adjust and choose from: Auto or Off.</p> <p><u>3D Sync Invert</u> Allows for correction if the 3D image depth is inversed.</p>
harman/kardon	Adjust the audio settings.
Information	Shows Input Source, Resolution, 3D format, and HDR.

> Operating the Projector

This section will introduce the **Home Screen** and its menus.

Home Screen

The **Home Screen** is displayed every time you start the projector. To navigate the **Home Screen**, simply use the directional buttons on the remote control. You can return to the main **Home Screen** at any time by pressing the **Home** button on the remote control, regardless of what page you are on.

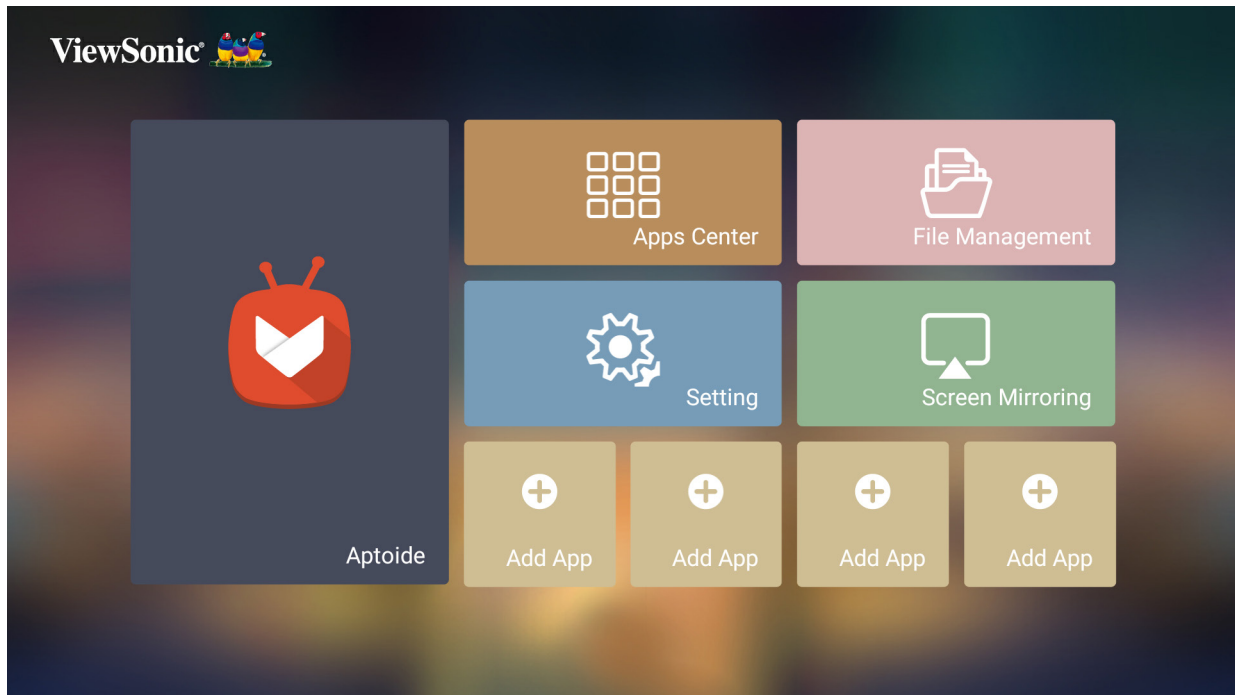

Menu	Description
Aptoide	Use to download common, popular Apps.
Apps Center	Access and view all the applications you have installed.
File Management	Provides a user interface to manage files and folders.
Setting	Manage various categories such as: Network settings, Basic and Advanced settings, Date & Time, Firmware update, and System Information.
Screen Mirroring	Mirror your personal device's screen through the projector.
Add App	Select your favorite Apps and add them to the Home Screen .

Home Screen - On-Screen Display (OSD) Menu Tree

Main Menu	Sub-menu	Menu Option				
Aptoid						
Apps Center						
File Management						
Settings	Network Settings	WiFi	Off			
			On	SSID:		
				Configure IP		
				IP Address		
				Subnet Mask		
				Default Gateway		
				DNS Server		
				Others		
		Wired LAN	Configure IP	Automatic		
				Manual		
			IP Address	xxx.xxx.xxx.xxx		
			Subnet Mask	xxx.xxx.xxx.xxx		
			Default Gateway	xxx.xxx.xxx.xxx		
			DNS Server	xxx.xxx.xxx.xxx		
			Wired LAN Control	Configure IP	Automatic	
					Manual	
		IP Address		xxx.xxx.xxx.xxx		
		Subnet Mask		xxx.xxx.xxx.xxx		
		DNS Server		xxx.xxx.xxx.xxx		
		Standby LAN Control	Off			
On						

Main Menu	Sub-menu	Menu Option	
Settings	Basic Settings	Language	English
			French
			German
			Italian
			Spanish
			Russian
			繁體中文
			簡體中文
			日本語
			韓語
			Swedish
			Dutch
			Turkish
			Czech
			Portuguese
			Thai
			Polish
			Finnish
			Arabic
			Indonesian
		Hindi	
		Vietnam	
		Greek	
		Projector Projection	Front Table
			Front Ceiling
			Rear Table
			Rear Ceiling
		Keystone	(-/+ , -40~40)
		Focus	Ok
		Test Pattern	Ok
		Standby Voice Control	Off
On			

Main Menu	Sub-menu	Menu Option			
Settings	Date & Time	Automatic Date & Time	Off		
			On		
		Date			
		Time			
		Time Zone			
		Time Format	12 hours		
	24 hours				
	Firmware Upgrade	Software Update Online			
		Software Update By USB			
		OTA Reminder	Disable		
			Enable		
	Software Version				
	Advanced Settings	Power On Source	Home		
			HDMI 1		
			HDMI 2		
			HDMI 3		
			HDMI 4		
			Computer In		
		Power On Ring Tone	Off		
			On		
		Auto Power On	CEC	Disable	
				Enable	
		Smart Energy	Auto Power Off	Disable	
				10 minutes	
20 minutes					
30 minutes					

Main Menu	Sub-menu	Menu Option		
Settings	Advanced Settings	Smart Energy	Sleep Timer	Disable
				30 minutes
				1 hour
				2 hours
				3 hours
				4 hours
				8 hours
				12 hours
			Power Saving	Enable
		Disable		
		harman/kardon	Audio Mode	Movie
				Music
				User
			100Hz	
			500Hz	
			1500Hz	
			5000Hz	
			10000Hz	
	Audio Volume		(-/+ , 0~50)	
	Mute		Off	
			On	
	S/PDIF		Off	
			On	
	Light Source Level	Full		
		Eco		
		Dynamic Black 1		
		Dynamic Black 2		
	High Altitude Mode	Off		
		On		
	RS-232 Control	Off		
		On		
	Reset Settings	Yes		
Cancel				
Reset To Factory Default	Yes			
	Cancel			

Main Menu	Sub-menu	Menu Option	
Settings	Information	Light Source Hours	
		System Version	
		Memory Information	
		Network Mac Address	
		Wired LAN Control Mac Address	
		WiFi Mac Address	
		Serial Number	
Screen Mirroring			
Add App			
Add App			
Add App			
Add App			

Menu Operations

Aptoide

The projector is pre-loaded with the Aptoide store, which allows users to download and install different Apps.

1. Select: **Home > Aptoide.**



2. Use the direction buttons to navigate the menu options. When you find your preferred App, press the **OK** button to install it.

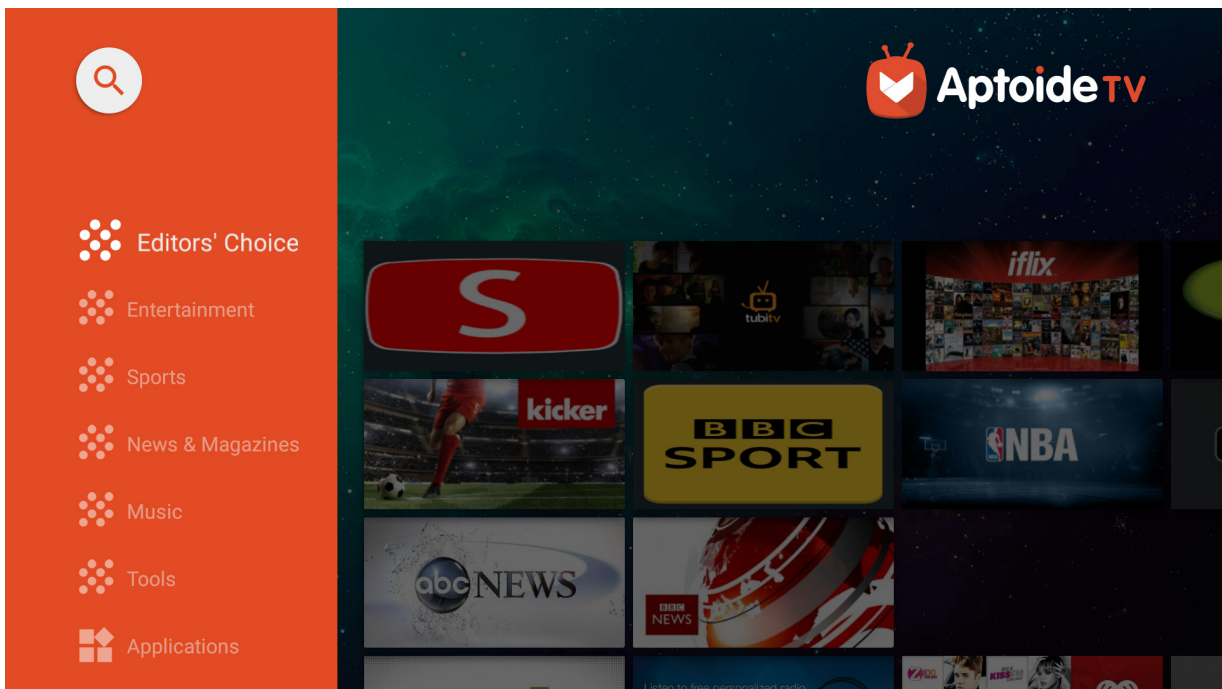

NOTE: Users can install third-party Apps by .apk file in **File Management**. However, some third-party Apps may have compatibility issues. Additionally, some Apps may be Region-Specific and/or require a keyboard and mouse.

Apps Center

View, launch, and uninstall Apps.

1. To view your Apps, select: **Home > Apps Center**.

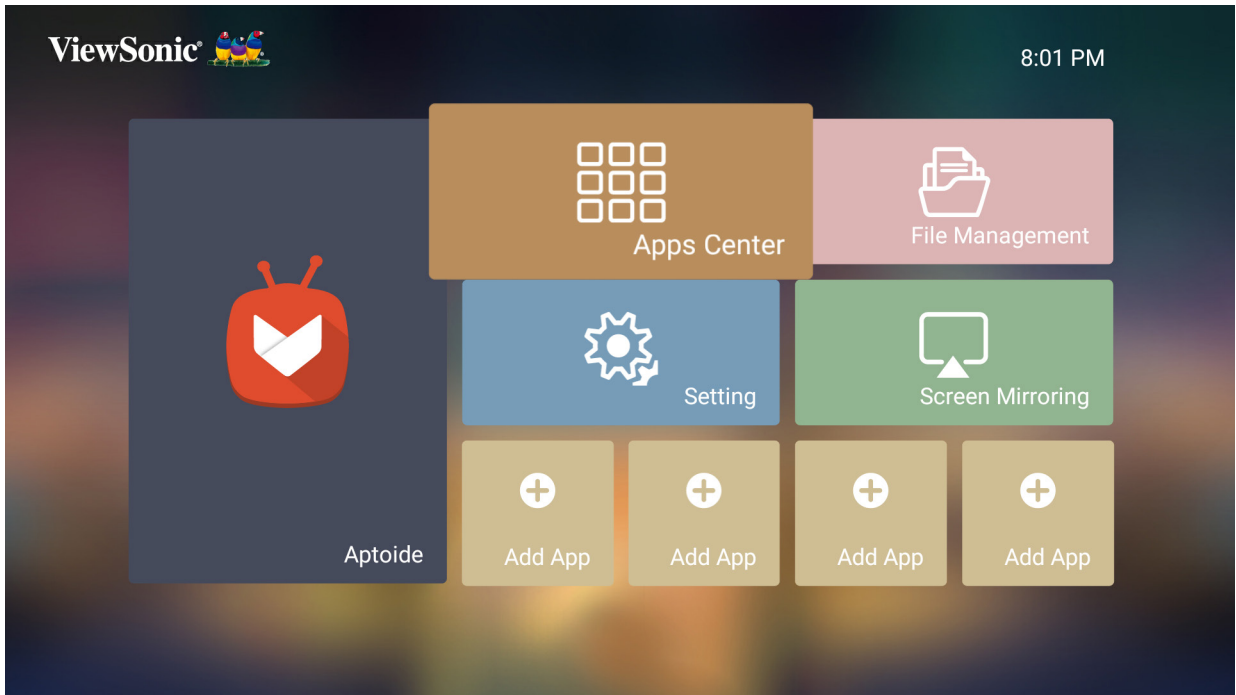

2. Use the direction buttons to select the desired App. Then press **OK** on the remote control to launch the App.

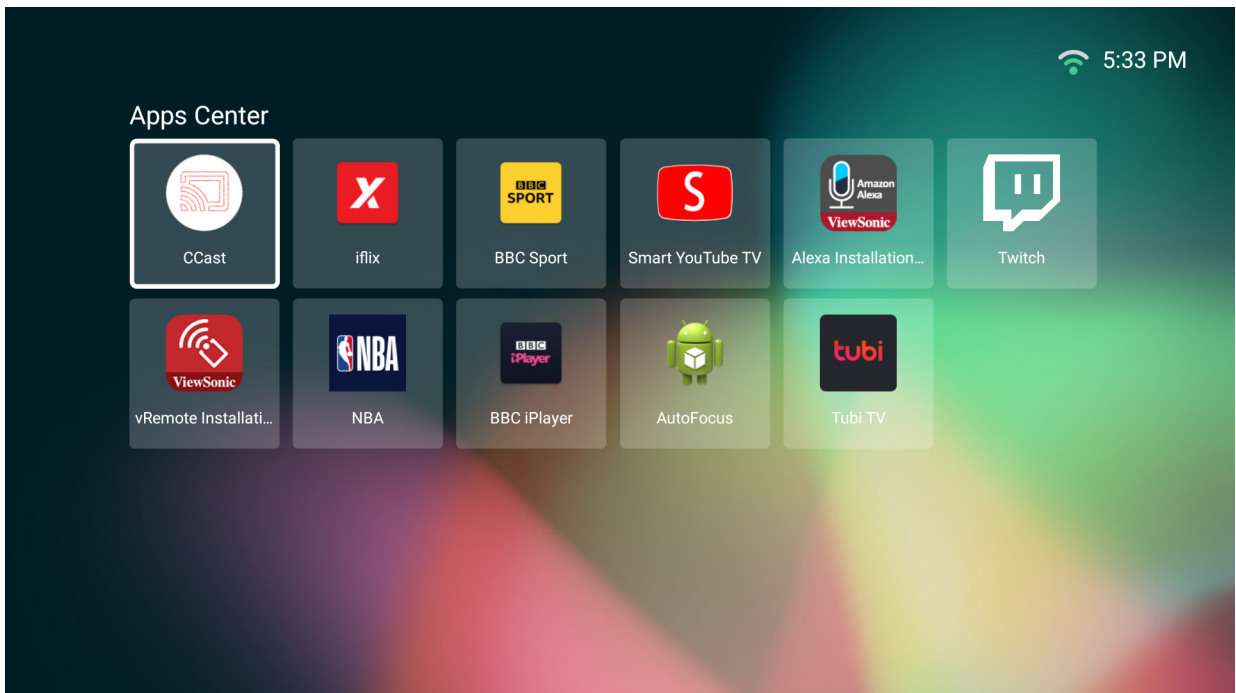

NOTE: Press the **Home** button on the remote control to return to the **Home Screen** at anytime.

To Uninstall Apps

1. Open the **Apps Center** by selecting: **Home > Apps Center**.
2. Use the directional buttons to select the desired App.
3. Press and hold **OK** on the remote control for three (3) seconds. The below dialogue box will appear:

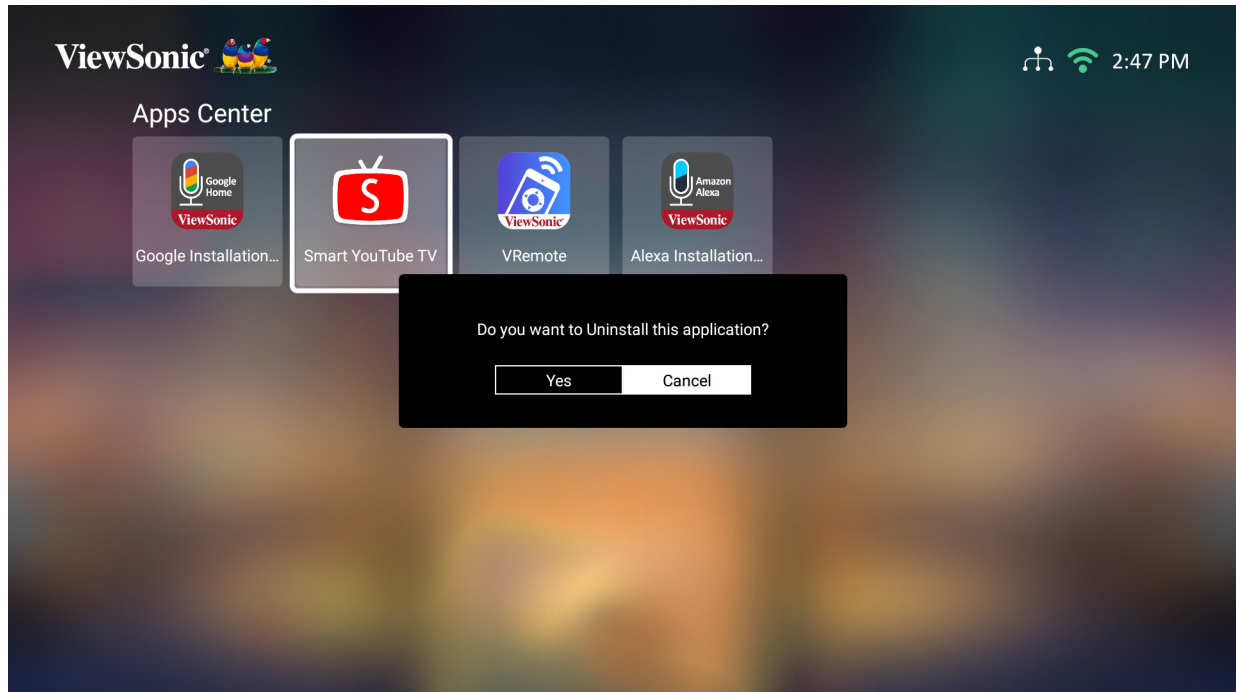

4. Select **OK** to uninstall the App.

NOTE: Press the **Home** button on the remote control to return to the **Home Screen** at anytime.

File Management

Easily manage files and folders.

1. Select: **Home > File Management.**

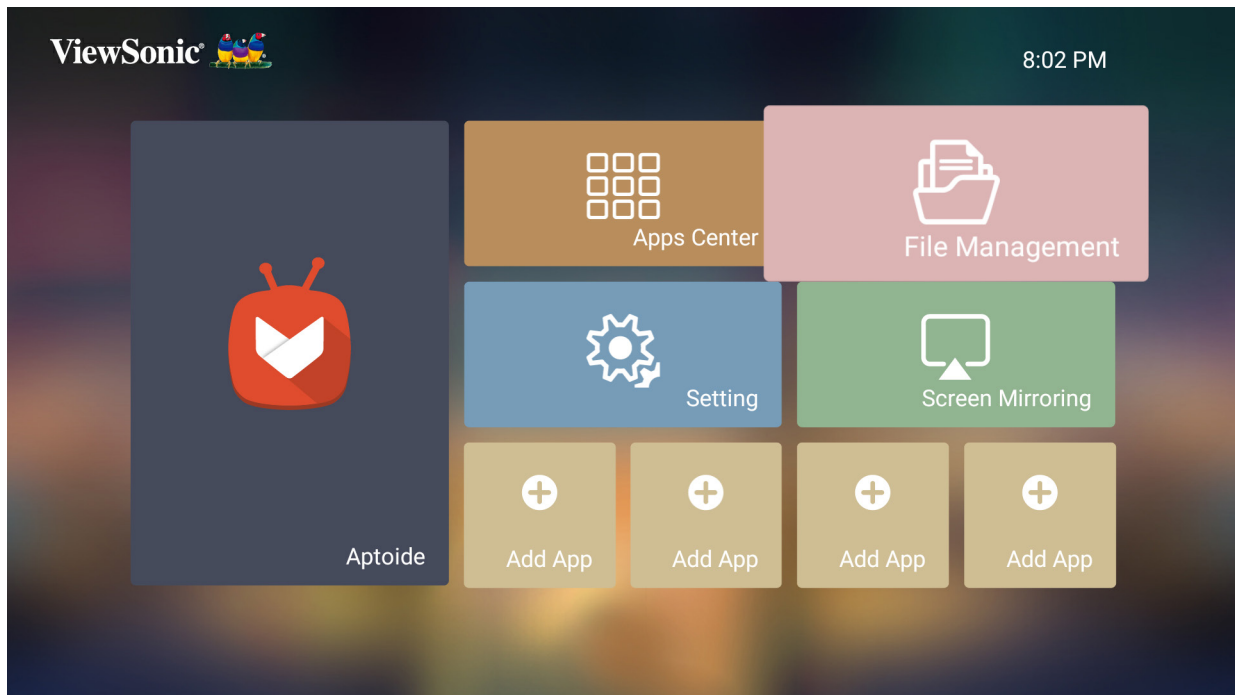

2. Select a device on the source list: USB, Local Storage, etc. Use the direction buttons to select the desired file. Then press **OK** on the remote control to open the selected file.

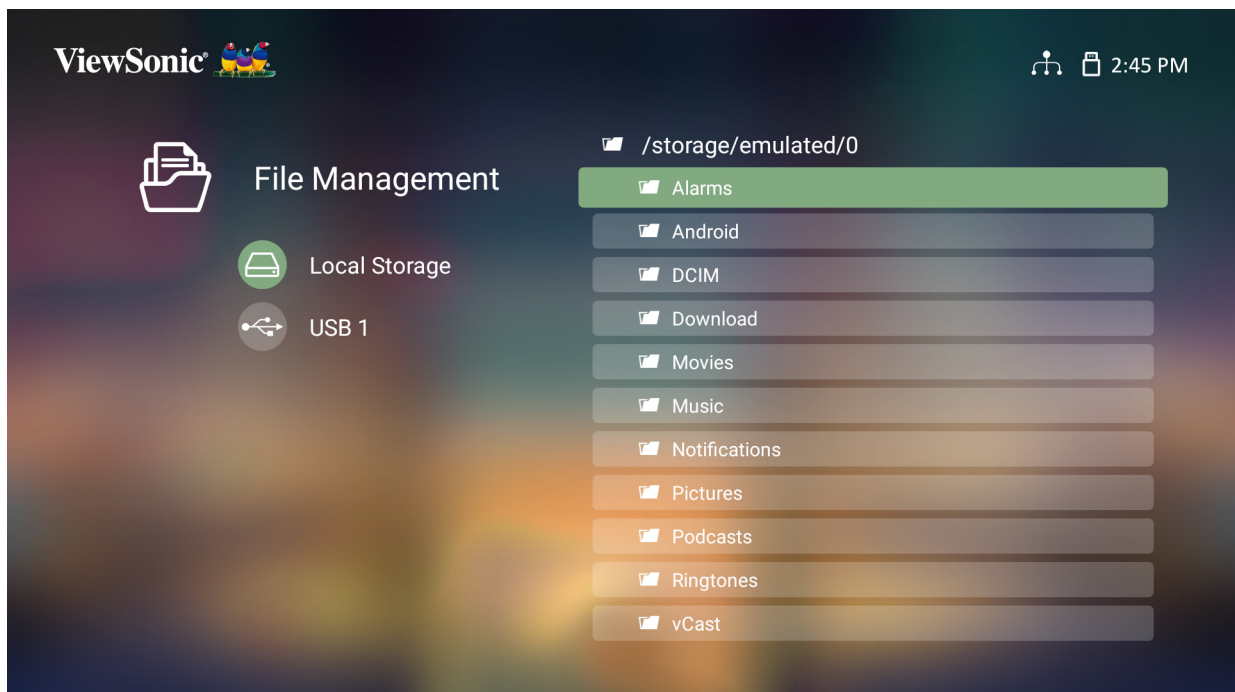

3. Press the **Return** button to go to a previous a level.

NOTE: Press the **Home** button on the remote control to return to the **Home Screen** at anytime.

How to Edit a File

1. While in **File Management**, press and hold the **OK** button for three (3) seconds.
2. A check box will appear at the front of each file. Use the direction buttons and press **OK** to select one or more files.

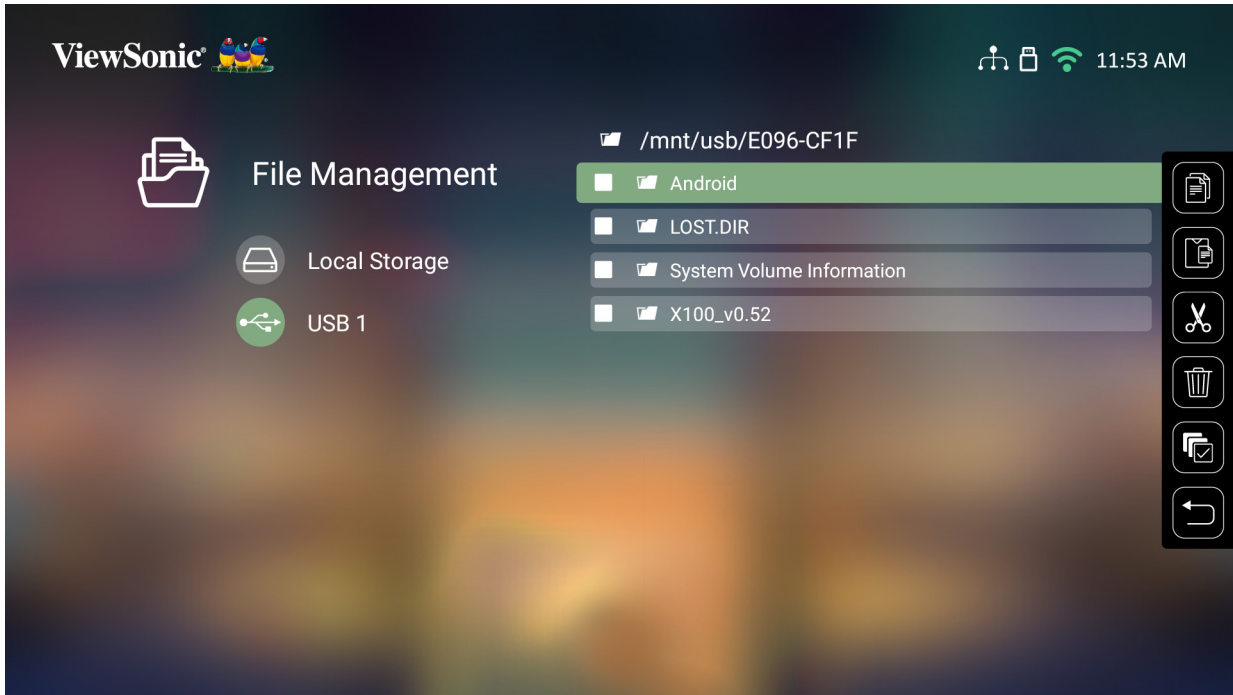



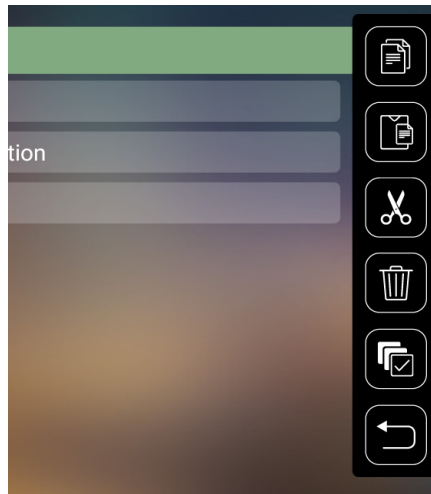



















3. By pressing the **Right** button, Copy, Paste, Cut, Delete, Select All, and Return boxes will be displayed.



4. Select your desired action and press **OK** to execute.
5. If you are Copying or Cutting, select your destination folder to complete the process.

How to Use Control Bar Buttons

The Control Bar buttons will appear on screen if a video, music, or photo file are selected to be opened.

Picture		Video		Music	
	Back		Back		Back
	Play		Rewind		Play
	Next		Play		Pause
	Zoom in		Pause		Next
	Zoom out		Fast Forward		Shuffle
	Rotate (left)		Next		Repeat All
	Rotate (right)				Repeat One
					Play List
					Information

Tips for Using USB

When using USB for reading and/or storage please keep in mind the following:

1. Some USB storage devices may not be compatible.
2. If you use an USB extension cable, the USB device may not recognize the USB.
3. Only use USB storage devices formatted with Windows FAT32 or NTFS file system.
4. Larger files will need extra time to load.
5. Data on USB storage devices may be damaged or lost. Back up important files.

Supported File Formats

Supported Office formats:

	Item	Indicators
Document viewing function	doc/docx	Able to open and read documents in doc/docx
	xls/xlsx	Able to open and read documents in xls/xlsx
	ppt/pptx	Able to open and read documents in ppt/pptx
	Pdf	Able to open and read documents in pdf
Supporting Interface Language	Supporting Interface 44 languages	English, Simplified Chinese, Chinese (TW), Chinese (HK), Spanish (LA), French (EU), PT (EU), PT (BR), German, Russian, Italian, Swedish, Spanish (EU), Korean, Arabic, Farsi, Serbian, Bosnian, Macedonian, Bulgarian, Ukrainian, Greek, Norwegian, Danish, Czech, Hungarian, Slovak, Polish, Romanian, Finnish, Estonian, Latvian, Lithuanian, British English, Slovenian, Croatian, Turkish, Vietnamese, Bahasa Indonesia, Dutch, Malay, Thai, Hindi, Hebrew, Burmese, Catalan.

Supported Multimedia formats:

Extension	Codec	
.xvid	Video	Xvid, H.264, H.265
.avi	Audio	MP3
.mp4 .m4v .mov	Video	H.264, H.265/MPEG 4
.mkv	Video	H.264, H.265
.ts	Video	H.264, H.265, MPEG2
.trp .tp .mts .m2ts	Audio	MP3
.vob	Video	MPEG1, MPEG2
	Audio	DVD-LPCM
.mpg	Video	MPEG1

NOTE: The AAC audio format is not supported.

Setting

Under **Setting** you can adjust Network, Basic, and Advanced Settings, Date & Time, Firmware Update, and view Information.

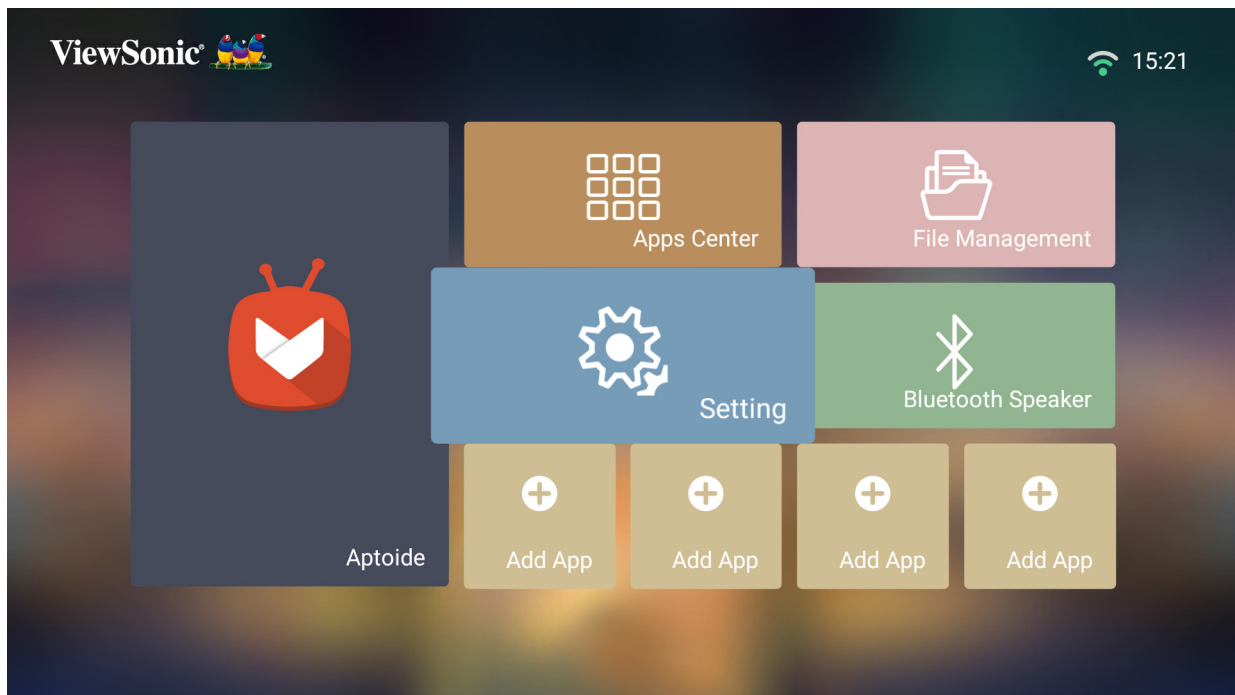

Network Settings

1. Select: **Home > Setting > Network Settings.**

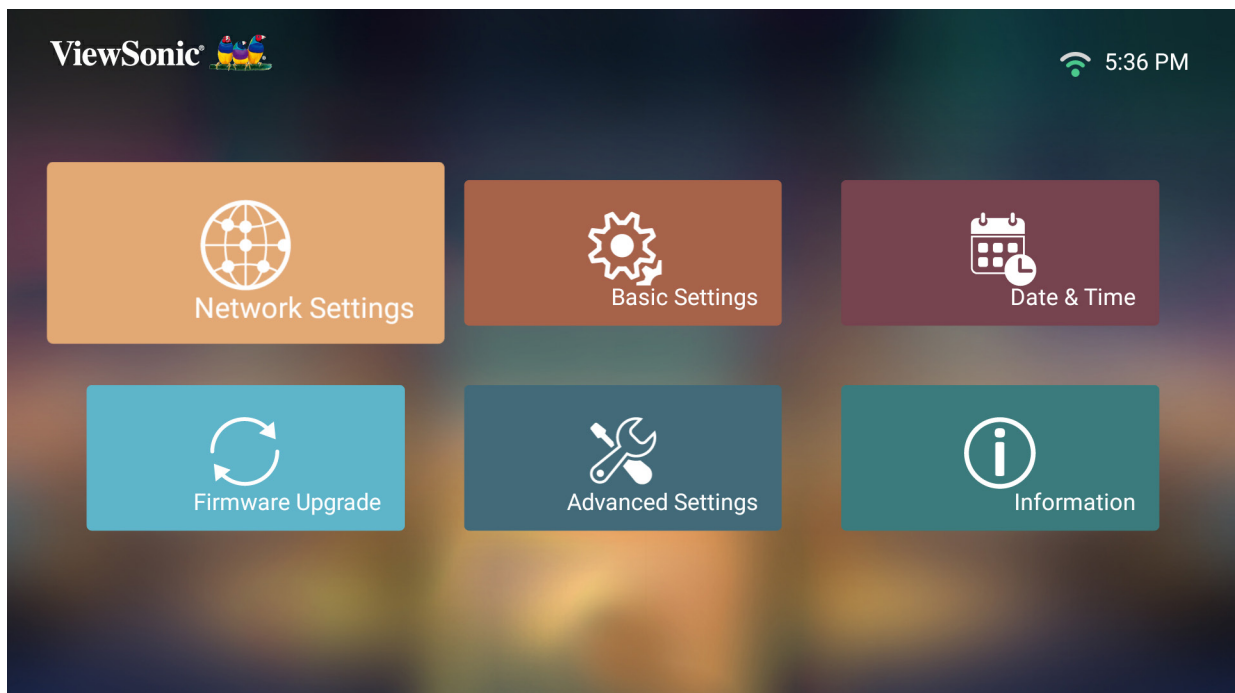

2. Choose from one of the available options: Wi-Fi or Wired LAN.



3. To setup a Wireless or Wired LAN Connection, see “Connecting to Networks” on page 31page 31.

Controlling the Projector through a LAN Environment

The projector supports Crestron® software. With the correct settings in the LAN Control Settings menu, you can manage the projector from a computer using a web browser when the computer and projector are properly connected to the same local area network.

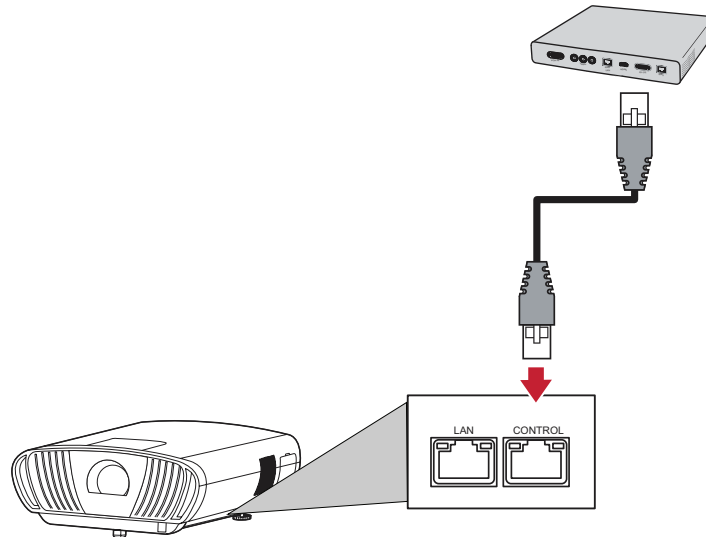

Configuring the LAN Control Settings

If you are in an **Automatic** IP environment:

1. Take a RJ45 cable and connect one end to the RJ45 **Control** port of the projector, and the other end to your network.
2. Go to: **Setting > Network Settings > Wired LAN Control**.
3. Select **Configure IP** and ensure it is set to **Automatic**.
4. Wait for 15-20 seconds, then re-enter **LAN Settings**. Now, the projector's IP Address, Subnet Mask, Default Gateway, and DNS Server settings will be displayed.
5. Make note of the IP Address displayed in the Projector IP Address row.

NOTE:

- If the Projector IP Address still does not appear, contact your network administrator.
- If the RJ45 cables are not properly connected, the Projector IP Address, Subnet Mask, Default Gateway, and DNS Server will display 0.0.0.0. Ensure the cables are properly connected and try the above steps again.
- If you need to connect to the projector in its Standby Mode, set **Standby LAN Control** to **On** in the **Network Settings** menu.

If you are in a **Manual** Static IP environment:

1. Take a RJ45 cable and connect one end to the RJ45 **Control** port of the projector, and the other end to your network.
2. Go to: **Setting > Network Settings > Wired LAN Control**.
3. Highlight **LAN Settings** and select **Manual IP**.
4. Contact your ITS administrator for information on the Projector IP Address, Subnet Mask, Default Gateway, and DNS Server.
5. Using the directional buttons, select the item you want to modify, and press Left/Right to enter the value.
6. To save, select **Apply** and press **Enter**.

NOTE: If the RJ45 cables are not properly connected, the Projector IP Address, Subnet Mask, Default Gateway, and DNS Server will display 0.0.0.0. Ensure the cables are properly connected and try the above steps again.

Controlling the Projector through a Web Browser

Once you have the correct IP Address for the projector and the projector is On or in Standby Mode, you can use any computer that is on the same local area network to control the projector.

NOTE:

- If you are using Microsoft Internet Explorer, make sure it is version 7.0 or higher.
- The screenshots are for reference only, and may differ from the actual design.
- Please pay attention to the limitation of input length (including space and other punctuation keys) in the list below:

Category Item		Input Length	Maximum Number of Characters
Network Settings	Network	DHCP/Manual	(N/A)
		IP Address	XXX.XXX.XXX.XXX
		Subnet Mask	XXX.XXX.XXX.XXX
		Gateway	XXX.XXX.XXX.XXX
		DNS Server	XXX.XXX.XXX.XXX
	Password	Administrator	(N/A)
		New Password	4
		Confirm Password	4
	SNMP	SysLocation	22
		SysName	22
SysContact		22	
Email Alert	Email Setting	To	40
		Cc	40
		Subject	40
		From	40
	SMTP Setting	Server	30
		User Name	21
Password		14	

Category Item		Input Length	Maximum Number of Characters
Email Alert	Alert Condition	Fan Error	(N/A)
		Light Source Error	(N/A)
		Over Temperature	(N/A)
		Submit	(N/A)
		Issue Test Mail	(N/A)

1. Enter the address of the projector in the address bar of your browser and press **Enter**.



2. The main page of the Network Control will load:

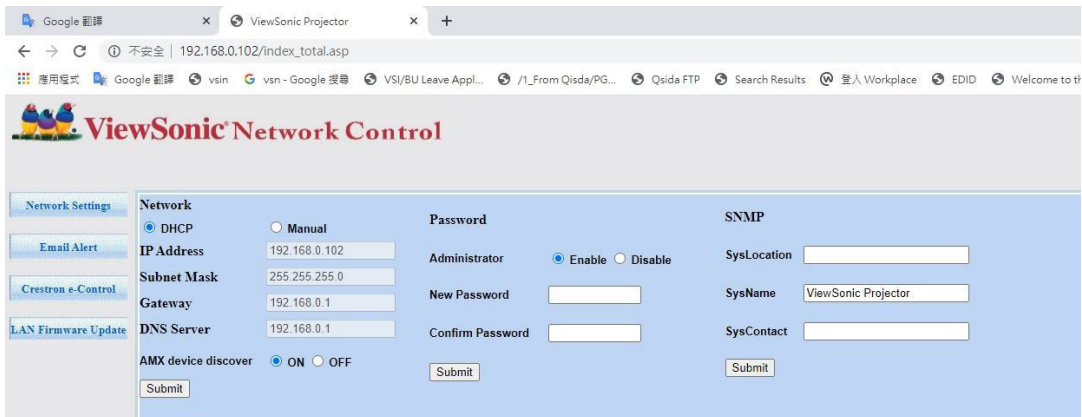

NOTE: Accessing the Network Settings, Email Alert page, or Projector/LAN Firmware update page requires the Administrator’s password. The default password is **0000**.

3. This page allows you to make adjustments to the SNMP settings.
4. If your projector is connected to a network which supports Simple Mail Transfer Protocol (SMTP), you can configure it to alert you via email on significant events.
5. The Crestron (e-Control)[®] page displays the Crestron e-Control user interface.

About Crestron e-Control®

The Crestron e-Control® page provides a variety of virtual keys to control the projector or adjust the projected pictures.

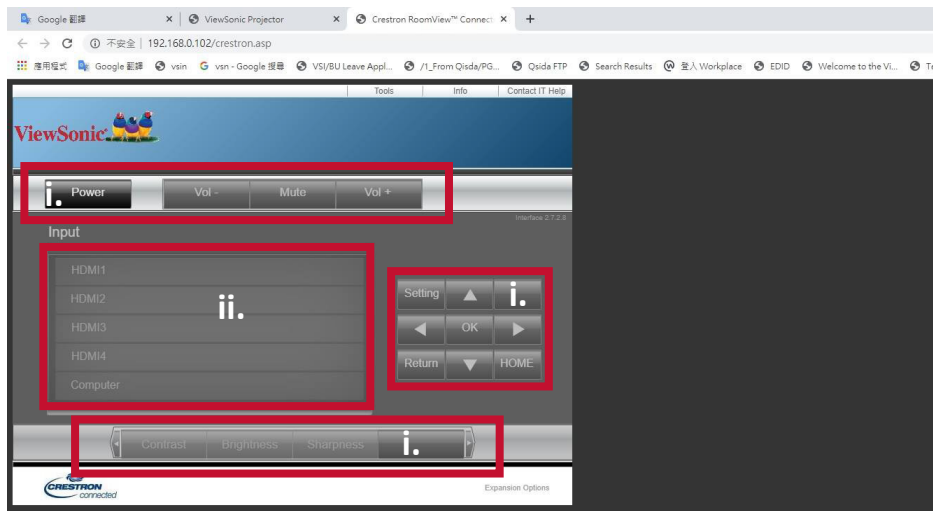

i. These buttons function the same as the ones on the OSD Menu or remote control.

ii. To switch between input signals, click on the desired signal.

NOTE:

- The source list varies according to the connections available on the projector.
- When you use the projector control panel or remote control to change the OSD Menu settings, it may take a while for the web browser to synchronize these changes with the projector.

The **Tools** page allows you to manage the projector, configure the LAN control settings, and secure access to remote network operations on the projector.

The screenshot shows a web browser window with the URL 192.168.0.102/crestron.asp. The page title is "ViewSonic Projector" and it has a navigation menu with "Tools", "Info", and "Contact IT Help". The main content area is divided into several sections, each with a "Send" button:

- i. Crestron Control:** IP Address (255.255.255.255), IP ID (7), Port (41794).
- ii. Projector:** Projector Name (X100-4K), Comment, Assigned To (ViewSonic Projector).
- iii. LAN Control:** DHCP (Enabled), IP Address (192.168.0.102), Subnet Mask (255.255.255.0), Default Gateway (192.168.0.1), DNS Server (192.168.0.1).
- iv. User Password:** Enabled checkbox, New Password, Confirm.
- v. Admin Password:** Enabled checkbox, New Password, Confirm.

At the bottom center, there is an "Exit" button labeled **vi.**

i. This section is only used with the Crestron Control System. Please contact Crestron or refer to its user manual for setup information.

ii. Name the projector, keep track of its location, and the person in charge of it.

iii. Adjust the LAN Control Settings.

iv. Once set, access to the remote network operation on the projector will be password protected.

v. Once set, access to the **Tools** page will be password protected.

NOTE:

- To prevent errors, only input the English alphabet and digits on the **Tools** page.
- After making the adjustments, press the **Send** button and the data will be saved for the projector.

vi. Press **Exit** to go back to the Remote Network Operation page.

Please pay attention to the limitation of input length (including space and other punctuation keys) in the list below:

Category Item	Input Length	Maximum Number of Characters
Crestron Control	IP Address	16
	IP ID	4
	Port	5
Projector	Projector Name	22
	Comment	32
	Assigned To	22
Network Configuration	DHCP (Enabled)	(N/A)
	IP Address	16
	Subnet Mask	16
	Default Gateway	16
	DNS Server	16
User Password	Enabled	(N/A)
	New Password	15
	Confirm	15
Admin Password	Enabled	(N/A)
	New Password	15
	Confirm	15

The **Info** page displays the information and status of the projector.



For more information, visit: <http://www.crestron.com>.

Basic Settings

1. Select: **Home** > **Setting** > **Basic Settings**.

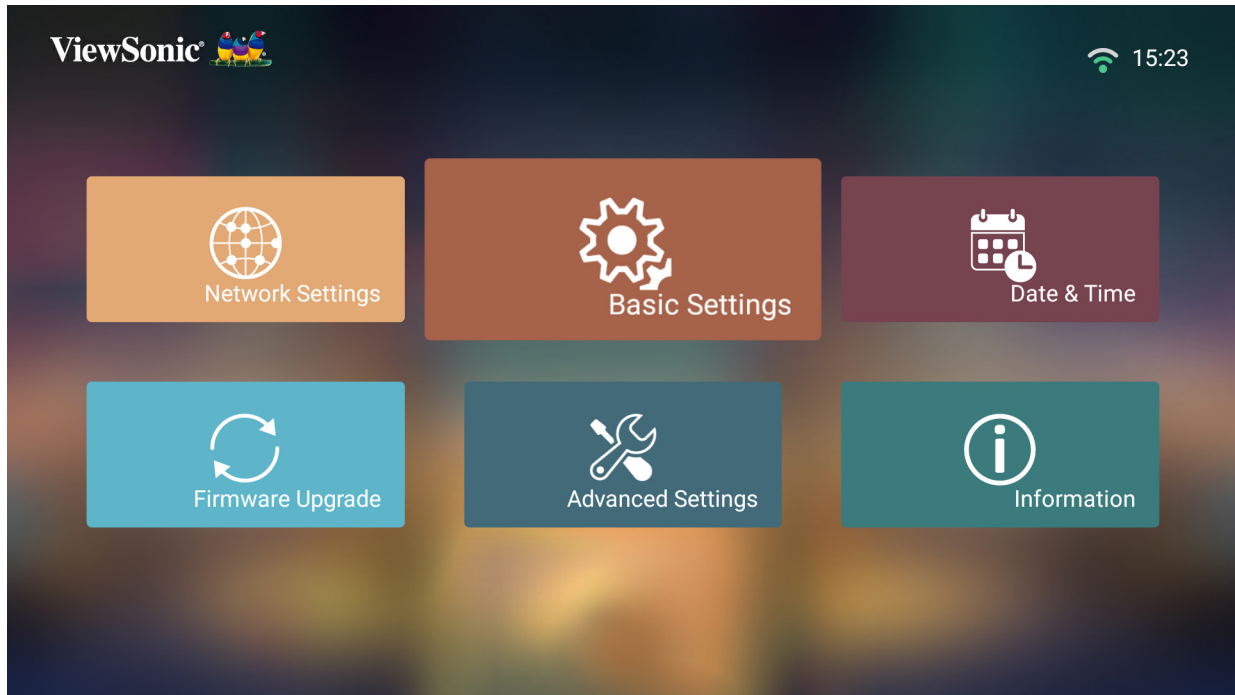

2. Use the **Up** and **Down** buttons to select the desired option and press **OK**. Then use the **Left** and **Right** buttons to make adjustments or selections.

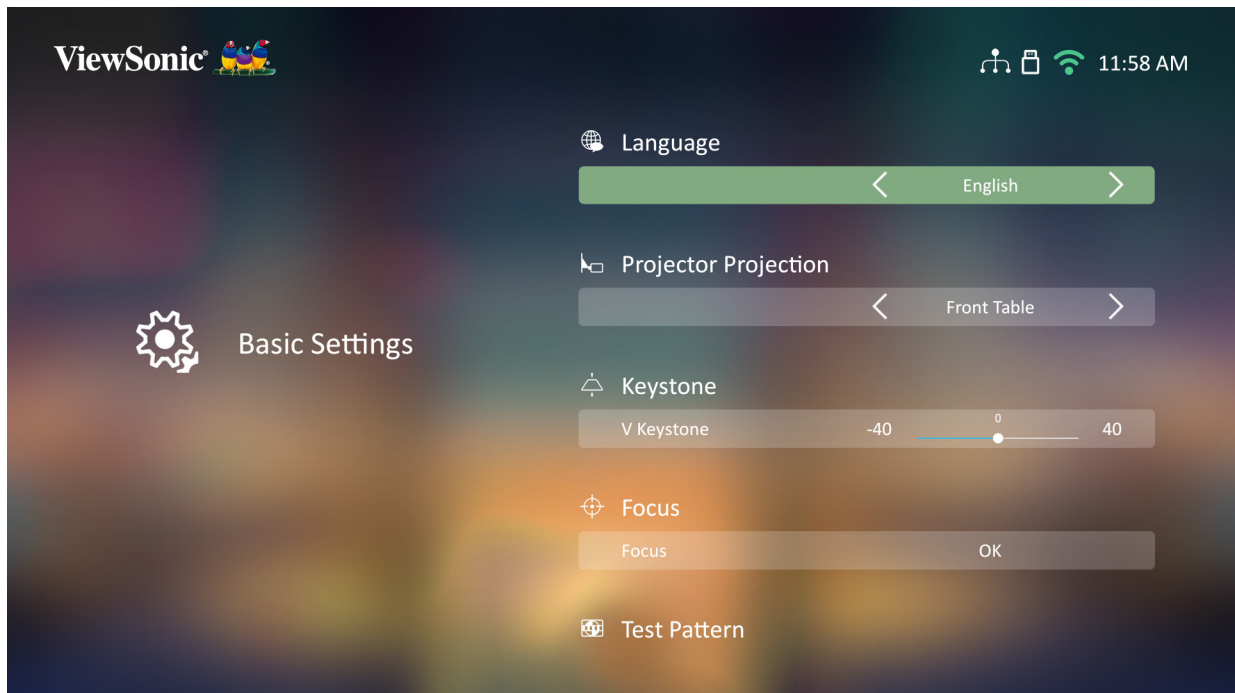

3. To return to a previous menu press the **Return** button.

Menu	Description
Language	Select your desired language.
Projector Position	Select the preferred projection position.
Keystone	Adjust trapezoidal screen image distortion. Keystone can be adjusted manually from -40 to 40.
Focus	Adjust the focus of the screen image. Use the Directional buttons on the remote control to adjust the focus.
Test Pattern	Test the color presentation of the projector.
Standby Voice Control	Allows the user to power on the projector with voice control. <u>On</u> The projector can be turned on in Standby mode. <u>Off</u> The projector cannot be turned on in Standby mode.

Date & Time

Adjust Date, Time, Time Zone, and Time Format.

NOTE: The time is displayed in the top-right corner after connecting to the Internet.

1. Select: **Home > Setting > Date & Time.**

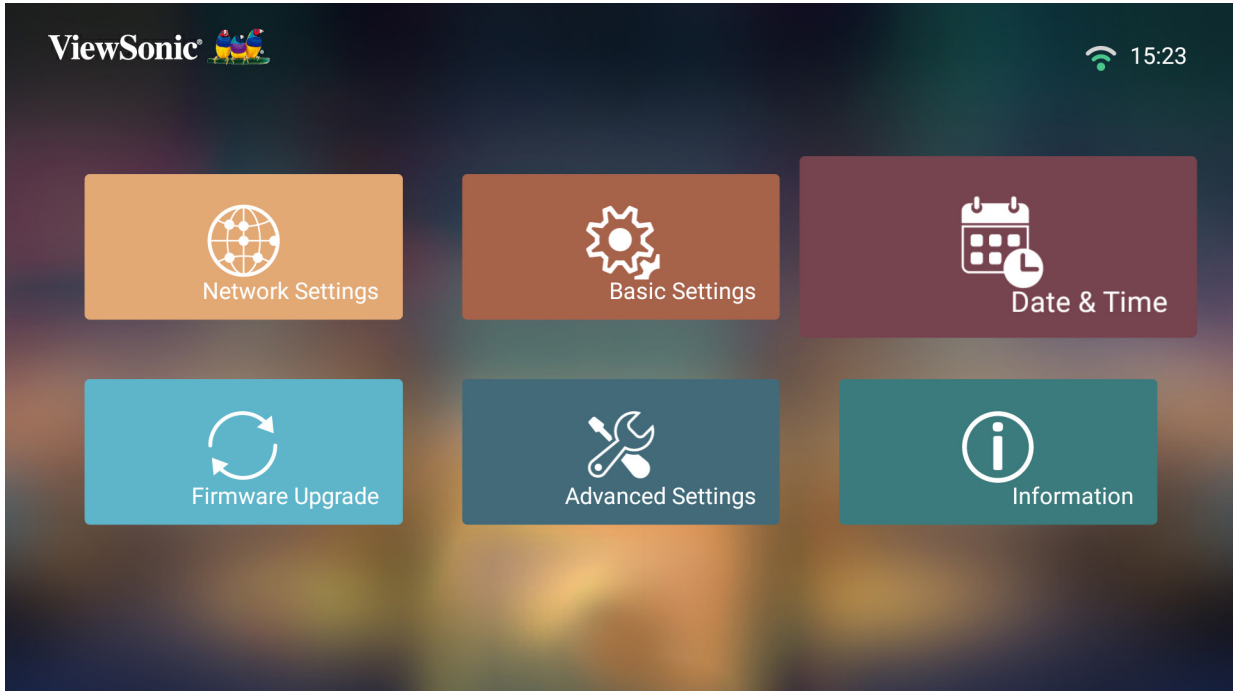

2. Use the **Up** and **Down** buttons to select the desired option and press **OK**. Then use the **Left** and **Right** buttons to make adjustments or selections.

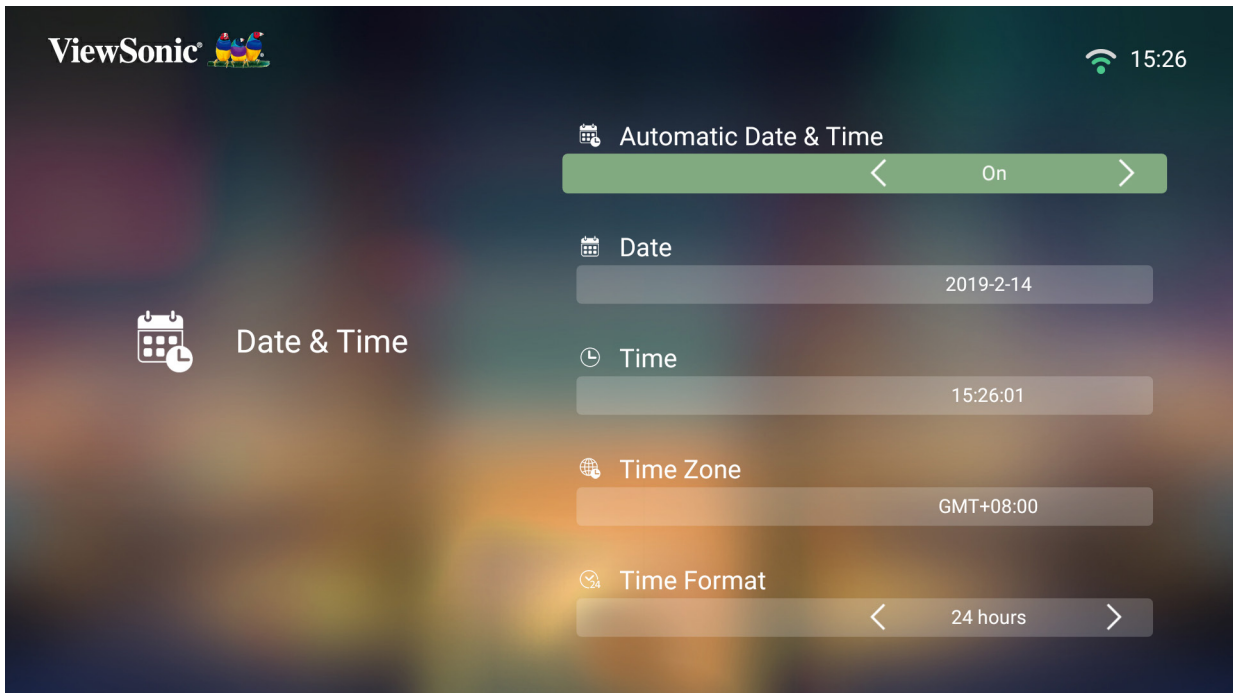

Menu	Description
Automatic Date & Time	Users can synchronize the date and time automatically after connecting to the Internet. <u>On</u> Turn on synchronization. <u>Off</u> Turn off synchronization.
Time Zone	Select your desired location.
Time Format	Select a different display time format. <u>12 Hours</u> 12-hour clock. <u>24 Hours</u> 24-hour clock.

Firmware Upgrade

Users can update the firmware by internet or USB, and check the version number.

NOTE: Do not unplug the power cord, USB, or disconnect from the Internet during the upgrading process.

1. Before entering the **Firmware Upgrade** menu, ensure the projector is connected to the Internet.
2. To enter the menu, select: **Home > Setting > Firmware Upgrade**.

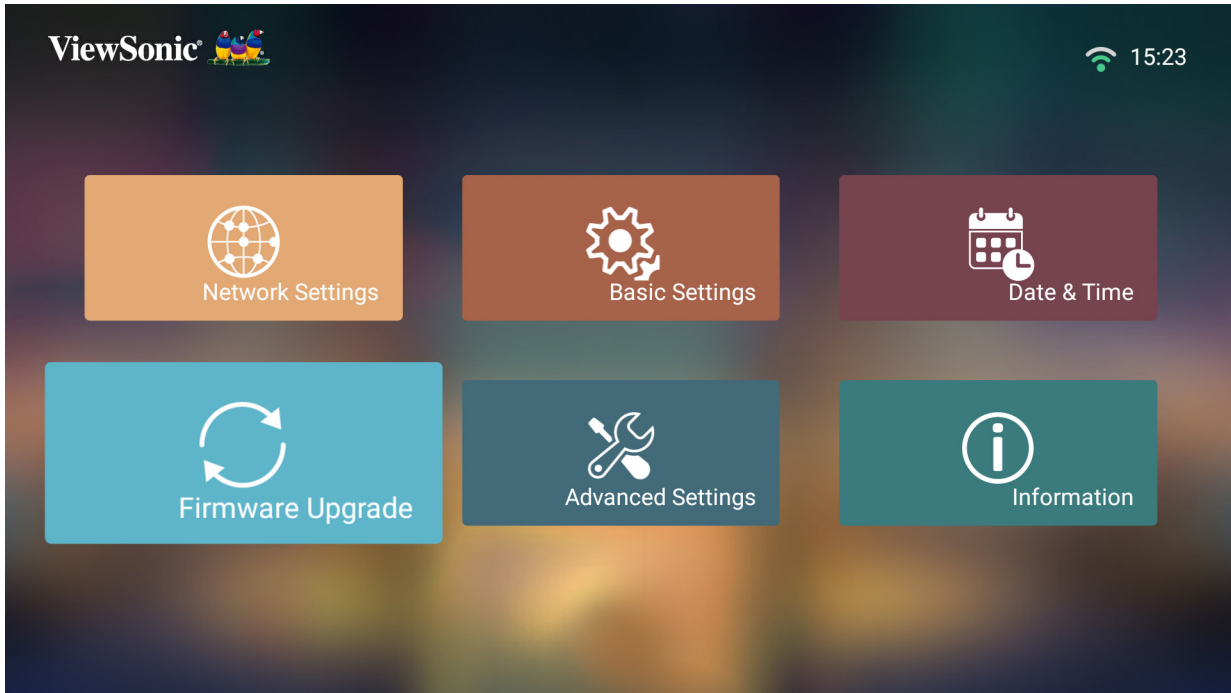

Firmware Update Online

1. Go to: **Home > Setting > Firmware Upgrade > Software Update Online**.



2. Select **Enter** by pressing **OK** on the remote control.
3. The system will check the ViewSonic website (OTA) and display the below dialog message if their is new Firmware.



4. After selecting **Yes**, a progress bar will appear as the update process begins.

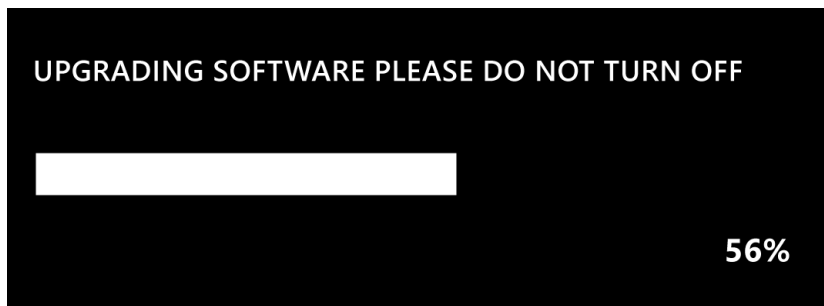

5. After reaching 100% the projector will restart. The whole process will take about 10 minutes.
6. After updating the Firmware, it will take a few minutes to restart the projector.

Firmware Update by USB with FAT32 Format

NOTE: NTFS format, read only.

1. Download the latest version from the ViewSonic website and copy the file to a USB device.
2. Plug the USB into the projector, then go to: **Home > Setting > Firmware Upgrade > Software Update By USB.**
3. Select **Enter** by pressing **OK** on the remote control.
4. The system will detect the Firmware version and display the above dialog message.
5. After selecting **Yes**, a progress bar will appear as the update process begins.
6. After reaching 100% the projector will restart. The whole process will take about 10 minutes.
7. After updating the Firmware, it will take a few minutes to restart the projector.

Advanced Settings

1. Select: **Home > Setting > Advanced Settings.**

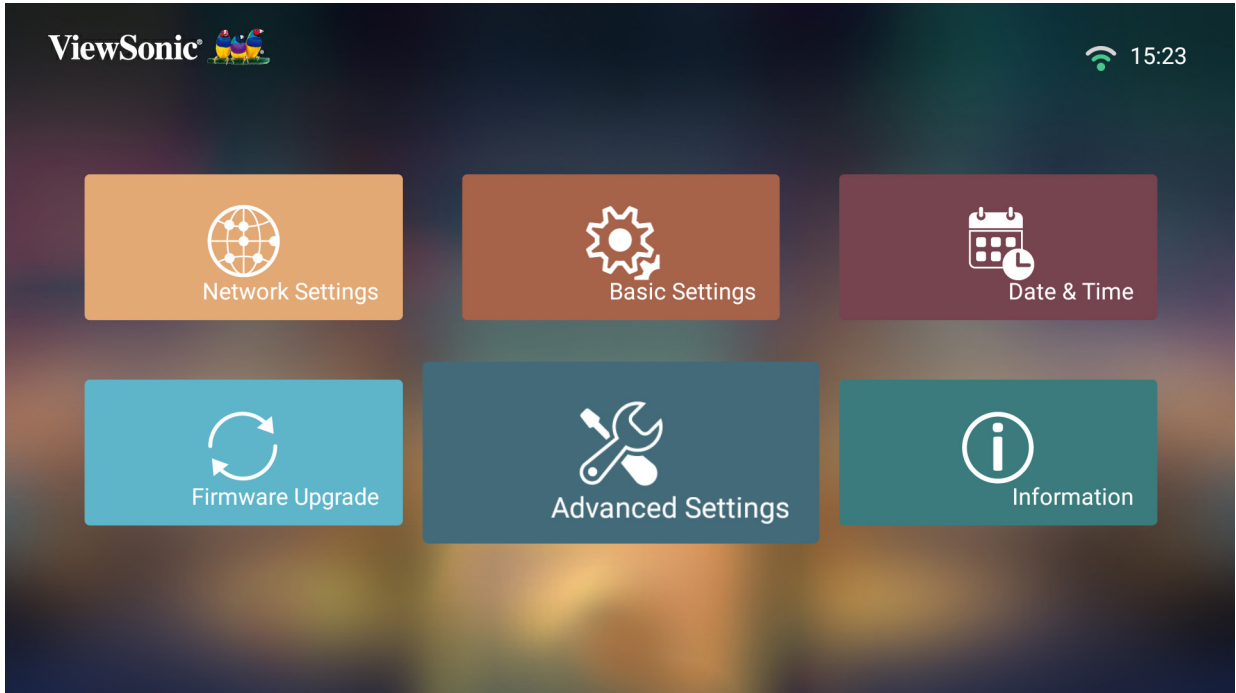

2. Use the **Up** and **Down** buttons to select the desired option and press **OK**. Then use the **Left** and **Right** buttons to make adjustments or selections.

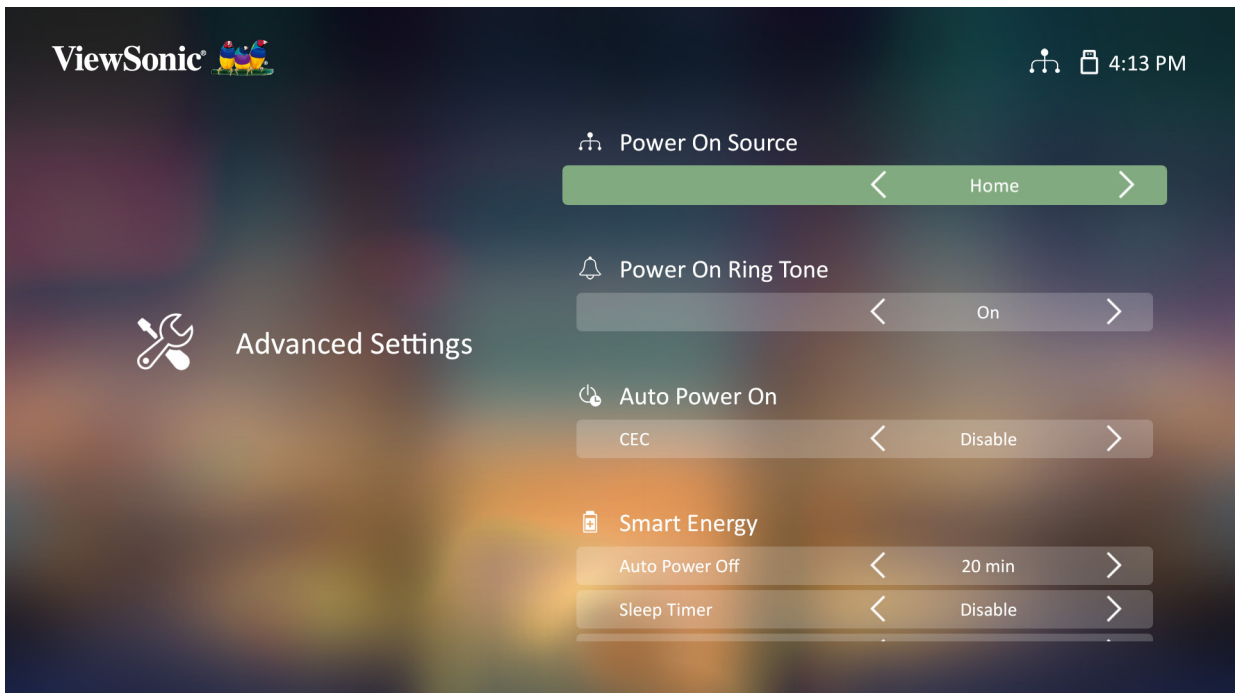

3. To return to a previous menu press the **Return** button.

Menu	Description
Power On Source	Allows the user to enter the desired source directly after turning on the projector.
Power On Ring Tone	Enable or disable the power on ring tone.
Auto Power On	<p><u>CEC</u></p> <p>This projector supports CEC (Consumer Electronics Control) function for synchronized power on/off operation via HDMI connection. That is, if a device that also supports CEC function is connected to the HDMI input of the projector, when the projector's power is turned off, the power of the connected device will also be turned off automatically. When the power of the connected device is turned on, the projector's power will be turned on automatically.</p> <p>NOTE: Ensure both the projector's and the connected device's CEC function are turned on.</p>
Smart Energy	<p><u>Auto Power Off</u></p> <p>The projector can turn off automatically after a set period of time once no input source is detected.</p> <p><u>Sleep Timer</u></p> <p>Turn off automatically after a set period of time.</p> <p><u>Power Saving</u></p> <p>Lower power consumption if no input source is detected after five (5) minutes.</p>

Menu	Description
harmon/kardon	<p>Audio Mode</p> <ul style="list-style-type: none"> • Movie: Default audio mode. • Music: Tuned for music playback. • User: Allows the user to customize the audio equalizer. <p>NOTE: In Custom mode, 100Hz, 500Hz, 1500Hz, 5000Hz, and 10000Hz can be selected.</p>  <p>Audio Volume Adjust the volume from 0 to 50.</p> <p>Mute Mute or unmute the volume.</p> <p>S/PDIF Select for audio output via the S/PDIF port.</p>
Light Source Level	<p>Select the suitable power consumption of the LED.</p> <p>Full 100%</p> <p>Eco 70%</p> <p>Dynamic Black 1/Dynamic Black 2</p>

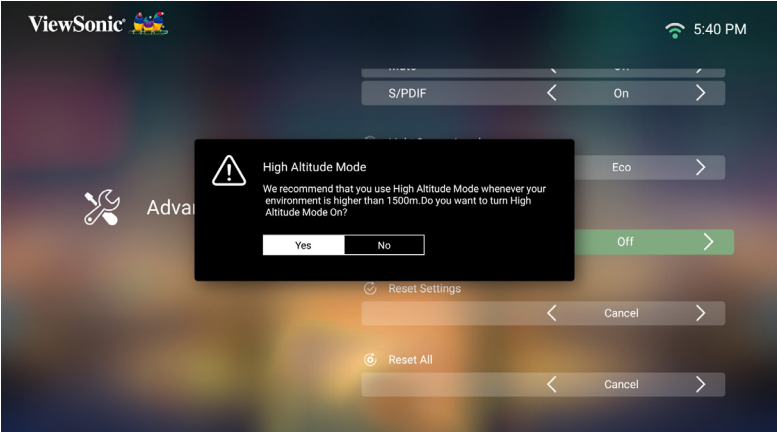
Menu	Description
High Altitude Mode	<p>It is recommended that you use High Altitude Mode when your environment is between 1,500-3,000 m above sea level, and a temperature between 5°C-25°C.</p>  <p>NOTE: If you use this projector under other extreme conditions excluding the above, it may display auto shut-down symptoms, which is designed to protect your projector from over-heating. In cases like this, you should switch to High Altitude Mode to solve these symptoms. However, this is not to state that this projector can operate under any and all harsh or extreme conditions.</p>
RS-232 Control	Enable/disable control through RS-232.
Reset Settings	<p>Reset the Settings to default.</p> <p>NOTE: Language, High Altitude Mode, Projector Position, Network Settings, All installed Apps in the Apps Center, Add App, ISF Mode, Keystone settings, and Light Source Hours will remain unchanged.</p>
Reset to Factory Default	<p>Factory reset.</p> <p>NOTE: Light Source Hours will remain unchanged.</p>

Information

1. Select: **Home** > **Setting** > **Information**.

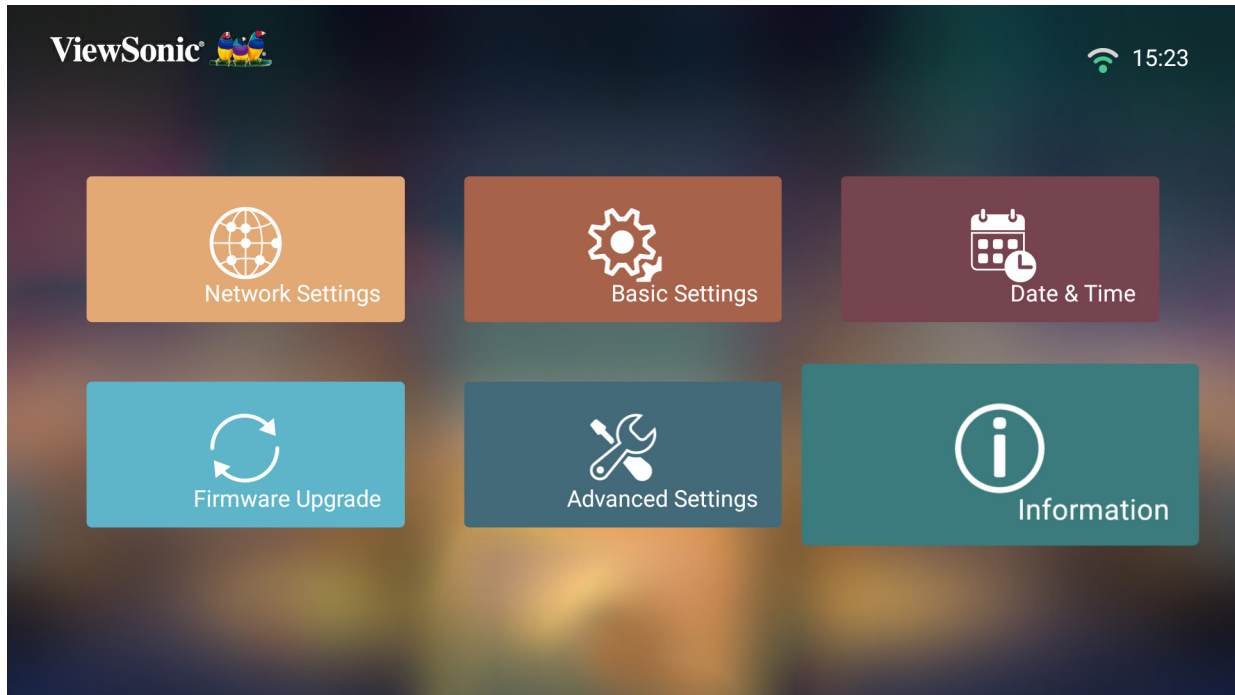

2. View system status and information.



NOTE: Press the **Home** button on the remote control to return to the **Home Screen** at anytime.

Screen Mirroring

Mirror your personal device's screen.

NOTE: Ensure your device is connected to the same network as the projector.

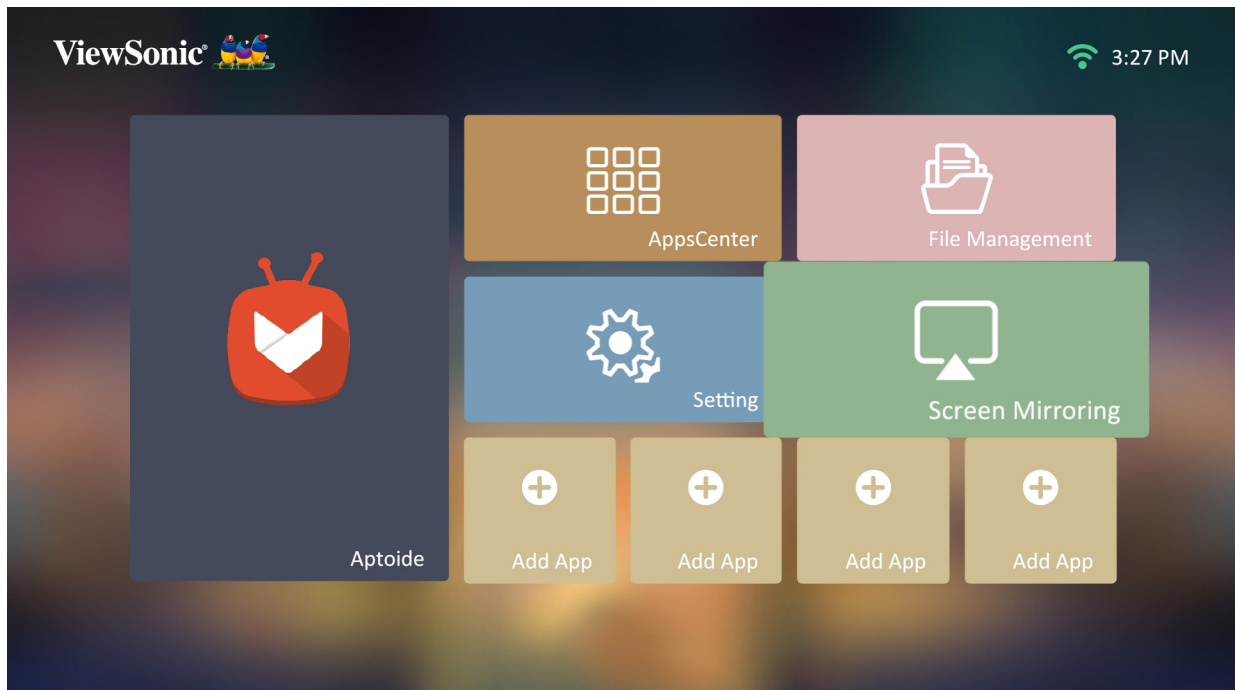

Adding Apps

Add your favorite Apps to the **Home Screen**.

1. From the **Home Screen**, select **Add App** and then press **OK** on the remote control.

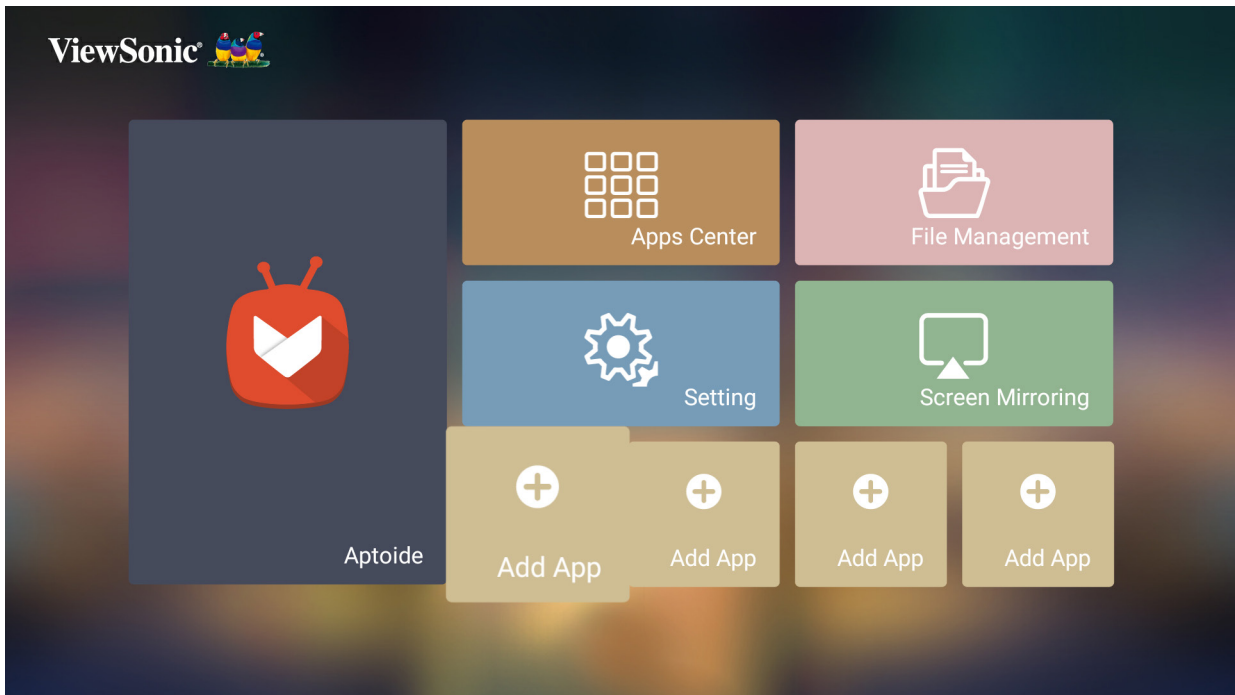

2. Use the directional buttons to select the desired App and press **OK**.

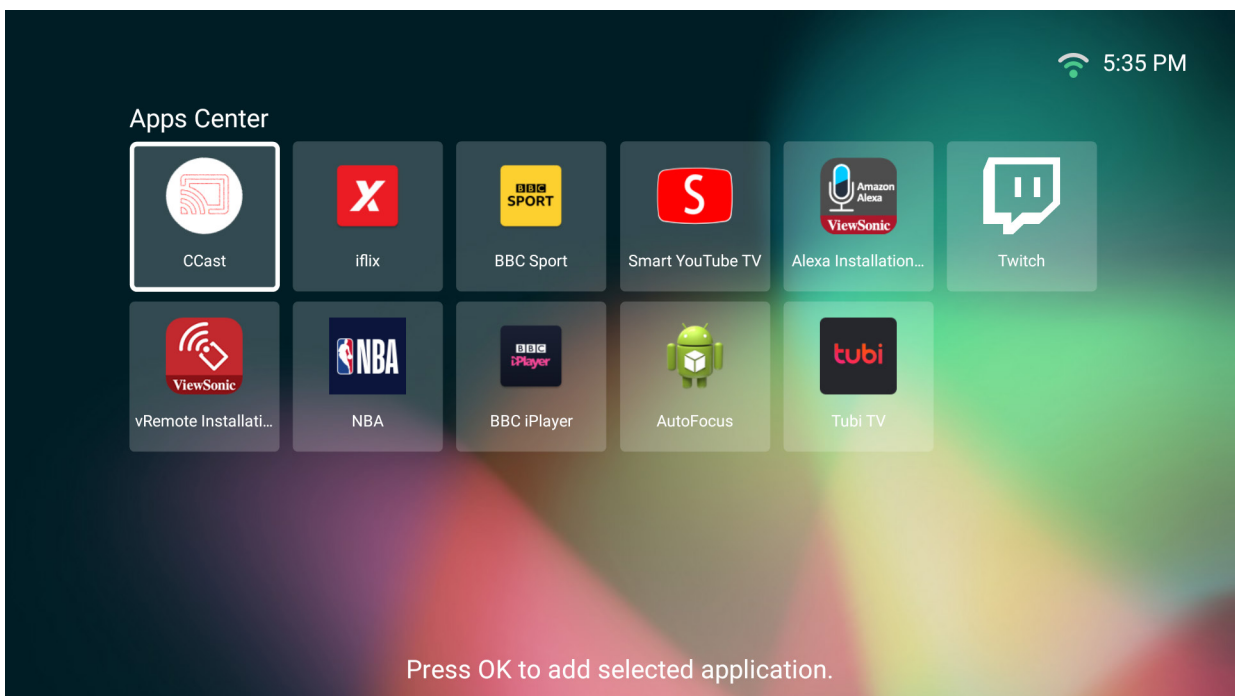

3. Now your favorite App will appear on the Home Screen.

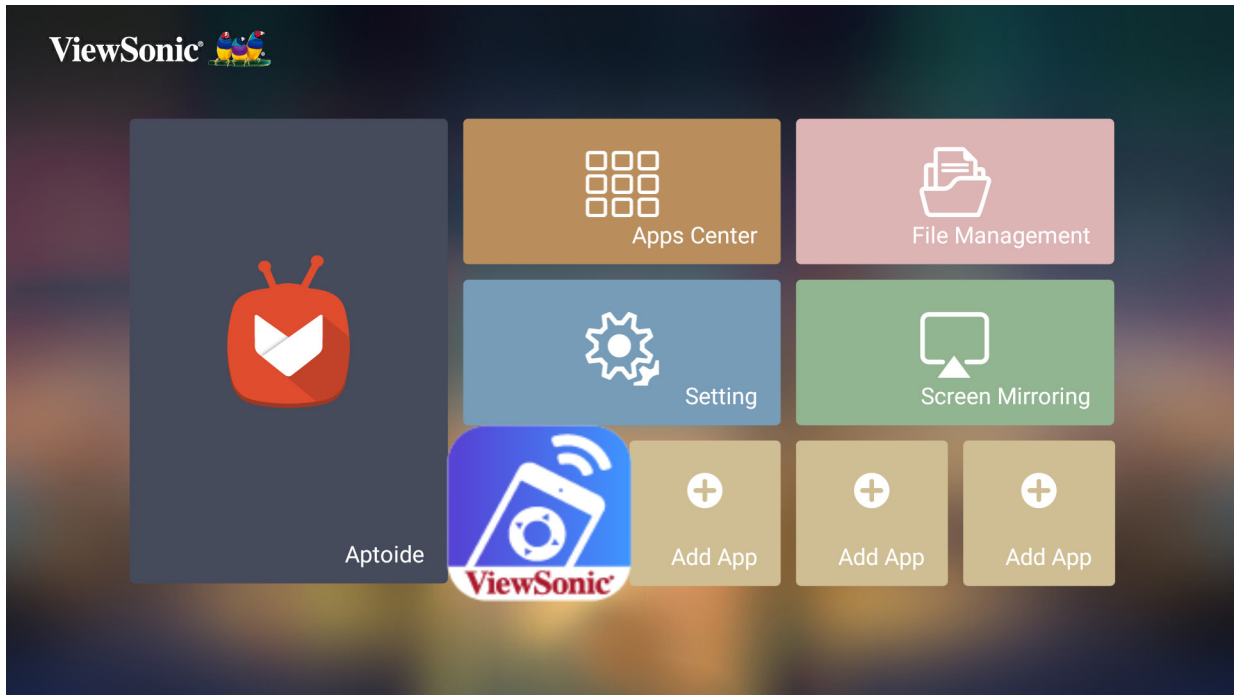

Delete Apps From the Home Screen

1. From the **Home Screen**, select the App you want to delete and press and hold **OK** for three (3) seconds.
2. The message, “Do you want to Delete this application from My Favorites?” will appear.

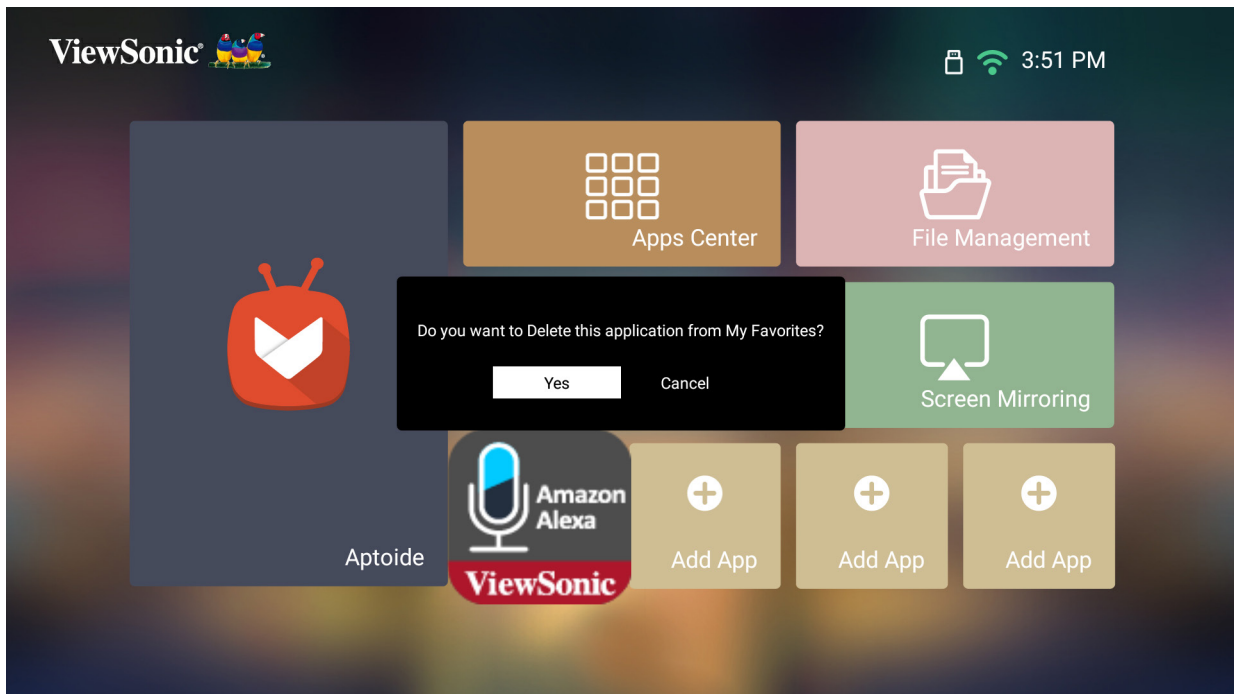

3. Select **Yes**, and press **OK** to delete the App.

> Appendix

Specifications

Item	Category	Specifications
Projector	Type	0.47" 4K-UHD, LED
	Display Size	40"~200"
	Throw Distance	1.06-6.37 m (100"@2.65 m)
	Lens	F=1.8-1.825, f=12.62-15.13 mm
	Optical Zoom	1.2x
	Lens Shift Range	H: +/- 25%; V:+65%
	Lamp Type	RGBB LED
	Light Source Life (Normal)	up to 30,000 hours
	Display Color	1.07 Billion Colors
	Keystone	-/+ 40 (Vertical)
Input Signal	HDMI	f _h : 30K~97KHz, f _v :24~120Hz,
Resolution	Native	3840 x 2160
	Support	VGA (640 x 480) to 4K (3840 x 2160)
Local Storage	Total	16 GB
	Available	12 GB
Input	Aux (3.5 mm)	1
	HDMI	4 (HDMI 2.0, HDCP 1.4/2.2)
	USB Type A	2 (USB 3.0 Reader x 1; USB 2.0 Reader x 1)
	RJ45 Input	2
	Wi-Fi Input	1 (5G)
Output	Audio-Out (3.5 mm)	1
	S/PDIF	1
	Speaker	20W Cube x 2
	USB Type A (Power)	2 (USB 3.0, 5V/2A; USB 2.0, 5V/900mA)
Power Adapter ¹	Input Voltage	DC IN 100-240V, 50/60 Hz (auto switch)
Operating Conditions	Temperature	0°C to 40°C (32°F to 104°F)
	Humidity	0% to 90% (non-condensing)
Dimensions	Physical (W x H x D)	416 x 183 x 463 mm (16.37" x 7.20" x 18.23")
Weight	Physical	7.7 kg (16.96 lbs)
Power Consumption	On	170W (Typical)
	Off	< 0.5W (Standby)

¹ Please use the power adapter from ViewSonic® or an authorized source only.

Projector Dimensions

416 mm (W) x 183 mm (H) x 463 mm(D)

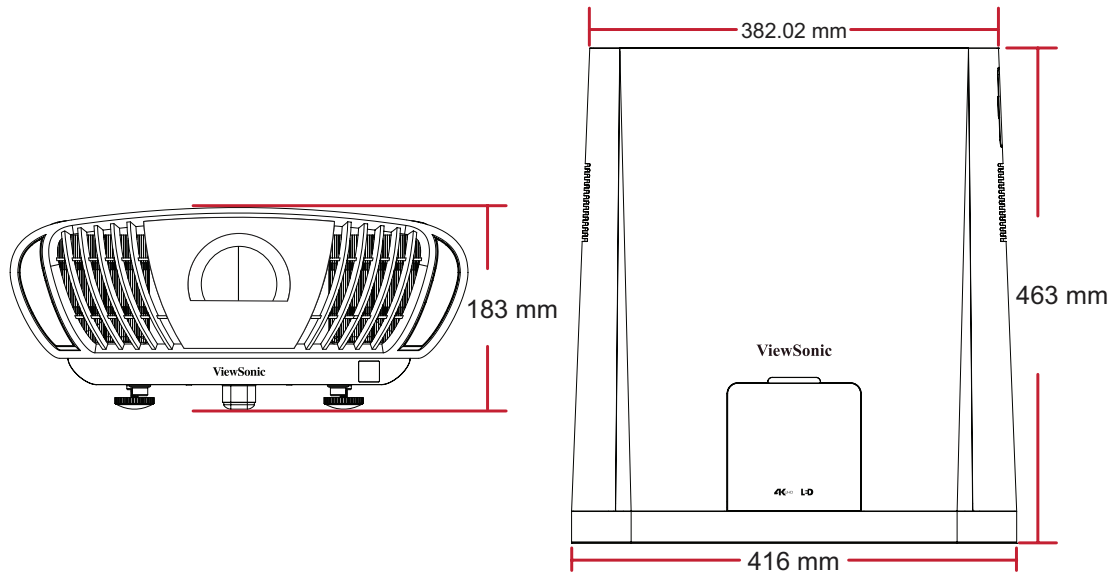

Timing Chart

HDMI Timing

Timing	Resolution (dots)	Refresh Rate (Hz)
SDTV (480i)	720 x 480	60
SDTV (480p)	720 x 480	60
SDTV (576i)	720 x 576	50
SDTV (576p)	720 x 576	50
HDTV (720p)	1280 x 720	50 / 60
HDTV (1080P)	1920 x 1080	24 / 25 / 30 / 50 / 60
HDTV (1080i)	1920 x 1080	50 / 60
UHDTV (4K)	3840x2160	24 / 25 / 30 / 50 / 60
VGA	640 x 480	59 / 67 / 72 / 75 / 85
720 x 400	720 x 400	70
SVGA	800 x 600	56 / 60 / 72 / 75 / 85 / 120
832x624	832x624	75
XGA	1024 x 768	60 / 70 / 75 / 85
1024x576	1024x576	60
XGA+	1152 x 864	75
1152x870	1152x870	75
WXGA	1280 x 768	60 / 75 / 85
WXGA	1280 x 800	60 / 75 / 85
SVGA	1280 x 1024	60 / 75 / 85
1280 x 720	1280 x 720	120
1280 x 960	1280 x 960	60 / 85
HD	1360 x 768	60
WXGA+	1440 x 900	60 / 75 / 85
1400X1050	1400X1050	60
1600x1200	1600x1200	60
WSXGA+	1680x1050	60
WUXGA	1920 x 1200	60

IR Control Table

Function	Address		Code	Inverse
	Byte 1	Byte 2	Byte 3	Byte 4
Power On/Off	83	F4	17	E8
Home	83	F4	16	E9
Focus	83	F4	92	6D
Source	83	F4	40	BF
Setting	83	F4	30	CF
Up	83	F4	0B	F4
Down	83	F4	0C	F3
Left	83	F4	0E	F1
Right	83	F4	0F	F0
OK	83	F4	15	EA
Bluetooth	83	F4	A2	5D
Return	83	F4	28	D7
Mute	83	F4	14	EB
Volume +	83	F4	82	7D
Volume -	83	F4	83	7C
Audio Mode	83	F4	9E	61

RS-232 Command Table

Function	Status	Action	Command
Power	Write	ON	0x06 0x14 0x00 0x04 0x00 0x34 0x11 0x00 0x00 0x5D
		OFF	0x06 0x14 0x00 0x04 0x00 0x34 0x11 0x01 0x00 0x5E
	Read	Status (Note 7)	0x07 0x14 0x00 0x05 0x00 0x34 0x00 0x00 0x11 0x00 0x5E
High Altitude Mode	Write	OFF	0x06 0x14 0x00 0x04 0x00 0x34 0x11 0x0C 0x00 0x69
		ON	0x06 0x14 0x00 0x04 0x00 0x34 0x11 0x0C 0x01 0x6A
	Read	Status	0x07 0x14 0x00 0x05 0x00 0x34 0x00 0x00 0x11 0x0C 0x6A
Light source mode	Write	Normal	0x06 0x14 0x00 0x04 0x00 0x34 0x11 0x10 0x00 0x6D
		Eco	0x06 0x14 0x00 0x04 0x00 0x34 0x11 0x10 0x01 0x6E
		Dynamic Black 1	0x06 0x14 0x00 0x04 0x00 0x34 0x11 0x10 0x09 0x76
		Dynamic Black 2	0x06 0x14 0x00 0x04 0x00 0x34 0x11 0x10 0x0A 0x77
	Read	Status	0x07 0x14 0x00 0x05 0x00 0x34 0x00 0x00 0x11 0x10 0x6E
Projector Position	Write	Front Table	0x06 0x14 0x00 0x04 0x00 0x34 0x12 0x00 0x00 0x5E
		Rear Table	0x06 0x14 0x00 0x04 0x00 0x34 0x12 0x00 0x01 0x5F
		Rear Ceiling	0x06 0x14 0x00 0x04 0x00 0x34 0x12 0x00 0x02 0x60
		Front Ceiling	0x06 0x14 0x00 0x04 0x00 0x34 0x12 0x00 0x03 0x61
	Read	Status	0x07 0x14 0x00 0x05 0x00 0x34 0x00 0x00 0x12 0x00 0x5F

Function	Status	Action	Command
3D Sync	Write	OFF	0x06 0x14 0x00 0x04 0x00 0x34 0x12 0x20 0x00 0x7E
		Auto	0x06 0x14 0x00 0x04 0x00 0x34 0x12 0x20 0x01 0x7F
		Frame Sequential	0x06 0x14 0x00 0x04 0x00 0x34 0x12 0x20 0x02 0x80
		Top Bottom	0x06 0x14 0x00 0x04 0x00 0x34 0x12 0x20 0x04 0x82
	Side by Side	0x06 0x14 0x00 0x04 0x00 0x34 0x12 0x20 0x05 0x83	
	Read	Status	0x07 0x14 0x00 0x05 0x00 0x34 0x00 0x00 0x12 0x20 0x7F
3D Sync Invert	Write	OFF	0x06 0x14 0x00 0x04 0x00 0x34 0x12 0x21 0x00 0x7F
		ON	0x06 0x14 0x00 0x04 0x00 0x34 0x12 0x21 0x01 0x80
	Read	Status	0x07 0x14 0x00 0x05 0x00 0x34 0x00 0x00 0x12 0x21 0x80
Contrast	Write	Decrease	0x06 0x14 0x00 0x04 0x00 0x34 0x12 0x02 0x00 0x60
		Increase	0x06 0x14 0x00 0x04 0x00 0x34 0x12 0x02 0x01 0x61
	Read	Get Volume	0x07 0x14 0x00 0x05 0x00 0x34 0x00 0x00 0x12 0x02 0x61
Brightness	Write	Decrease	0x06 0x14 0x00 0x04 0x00 0x34 0x12 0x03 0x00 0x61
		Increase	0x06 0x14 0x00 0x04 0x00 0x34 0x12 0x03 0x01 0x62
	Read	Get Volume	0x07 0x14 0x00 0x05 0x00 0x34 0x00 0x00 0x12 0x03 0x62

Function	Status	Action	Command
Aspect ratio	Write	Auto	0x06 0x14 0x00 0x04 0x00 0x34 0x12 0x04 0x00 0x62
		4:3	0x06 0x14 0x00 0x04 0x00 0x34 0x12 0x04 0x02 0x64
		16:9	0x06 0x14 0x00 0x04 0x00 0x34 0x12 0x04 0x03 0x65
		16:10	0x06 0x14 0x00 0x04 0x00 0x34 0x12 0x04 0x04 0x66
		2.35:1	0x06 0x14 0x00 0x04 0x00 0x34 0x12 0x04 0x07 0x69
		Panorama	0x06 0x14 0x00 0x04 0x00 0x34 0x12 0x04 0x08 0x6A
	Native	0x06 0x14 0x00 0x04 0x00 0x34 0x12 0x04 0x09 0x6B	
	Read	Get Volume	0x07 0x14 0x00 0x05 0x00 0x34 0x00 0x00 0x12 0x04 0x63
Horizontal position	Write	Shift Right	0x06 0x14 0x00 0x04 0x00 0x34 0x12 0x06 0x01 0x65
		Shift Left	0x06 0x14 0x00 0x04 0x00 0x34 0x12 0x06 0x00 0x64
	Read	Get Valume	0x07 0x14 0x00 0x05 0x00 0x34 0x00 0x00 0x12 0x06 0x65
Vertical position	Write	Shift Up	0x06 0x14 0x00 0x04 0x00 0x34 0x12 0x07 0x00 0x65
		Shift Down	0x06 0x14 0x00 0x04 0x00 0x34 0x12 0x07 0x01 0x66
	Read	Get Valume	0x07 0x14 0x00 0x05 0x00 0x34 0x00 0x00 0x12 0x07 0x66
Color temperature	Write	6500 K	0x06 0x14 0x00 0x04 0x00 0x34 0x12 0x08 0x01 0x67
		7500 K	0x06 0x14 0x00 0x04 0x00 0x34 0x12 0x08 0x02 0x68
		9300 K	0x06 0x14 0x00 0x04 0x00 0x34 0x12 0x08 0x04 0x6A
		User	
	Read	Status	0x07 0x14 0x00 0x05 0x00 0x34 0x00 0x00 0x12 0x08 0x67
Color temperature - Red gain	Write	Decrease	0x06 0x14 0x00 0x05 0x00 0x34 0x12 0x3A 0x00 0x00 0x99
		Increase	0x06 0x14 0x00 0x05 0x00 0x34 0x12 0x3A 0x00 0x01 0x9A
	Read	Get Valume	0x07 0x14 0x00 0x05 0x00 0x34 0x00 0x00 0x12 0x3B 0x9A

Function	Status	Action	Command
Color temperature - Green gain	Write	Decrease	0x06 0x14 0x00 0x05 0x00 0x34 0x12 0x3A 0x01 0x00 0x9A
		Increase	0x06 0x14 0x00 0x05 0x00 0x34 0x12 0x3A 0x01 0x01 0x9B
	Read	Get Volume	0x07 0x14 0x00 0x05 0x00 0x34 0x00 0x00 0x12 0x3C 0x9B
Color temperature - Blue gain	Write	Decrease	0x06 0x14 0x00 0x05 0x00 0x34 0x12 0x3A 0x02 0x00 0x9B
		Increase	0x06 0x14 0x00 0x05 0x00 0x34 0x12 0x3A 0x02 0x01 0x9C
	Read	Get Volume	0x07 0x14 0x00 0x05 0x00 0x34 0x00 0x00 0x12 0x3D 0x9C
Color temperature - Red offset	Write	Decrease	0x06 0x14 0x00 0x05 0x00 0x34 0x12 0x3E 0x00 0x00 0x9
		Increase	0x06 0x14 0x00 0x05 0x00 0x34 0x12 0x3E 0x00 0x01 0x9E
	Read	Get Volume	0x07 0x14 0x00 0x05 0x00 0x34 0x00 0x00 0x12 0x3F 0x9E
Color temperature - Green offset	Write	Decrease	0x06 0x14 0x00 0x05 0x00 0x34 0x12 0x3E 0x01 0x00 0x9E
		Increase	0x06 0x14 0x00 0x05 0x00 0x34 0x12 0x3E 0x01 0x01 0x9F
	Read	Get Volume	0x07 0x14 0x00 0x05 0x00 0x34 0x00 0x00 0x12 0x40 0x9F
Color temperature - Blue offset	Write	Decrease	0x06 0x14 0x00 0x05 0x00 0x34 0x12 0x3E 0x02 0x00 0x9F
		Increase	0x06 0x14 0x00 0x05 0x00 0x34 0x12 0x3E 0x02 0x01 0xA0
	Read	Get Volume	0x07 0x14 0x00 0x05 0x00 0x34 0x00 0x00 0x12 0x41 0xA0
Vertical Keystone	Write	Decrease	0x06 0x14 0x00 0x04 0x00 0x34 0x12 0x0A 0x00 0x68
		Increase	0x06 0x14 0x00 0x04 0x00 0x34 0x12 0x0A 0x01 0x69
	Read	Get Volume	0x07 0x14 0x00 0x05 0x00 0x34 0x00 0x00 0x12 0x0A 0x69

Function	Status	Action	Command
Color Mode	Write	Brightest	0x06 0x14 0x00 0x04 0x00 0x34 0x12 0x0B 0x00 0x69
		TV	0x06 0x14 0x00 0x04 0x00 0x34 0x12 0x0B 0x1A 0x83
		Movie	0x06 0x14 0x00 0x04 0x00 0x34 0x12 0x0B 0x01 0x6A
		Gaming	0x06 0x14 0x00 0x04 0x00 0x34 0x12 0x0B 0x12 0x7B
		ISF Day	0x06 0x14 0x00 0x04 0x00 0x34 0x12 0x0B 0x16 0x7F
		ISF Night	0x06 0x14 0x00 0x04 0x00 0x34 0x12 0x0B 0x17 0x80
		User1	0x06 0x14 0x00 0x04 0x00 0x34 0x12 0x0B 0x18 0x81
		User2	0x06 0x14 0x00 0x04 0x00 0x34 0x12 0x0B 0x19 0x82
	Read	Get Volume	0x07 0x14 0x00 0x05 0x00 0x34 0x00 0x00 0x05 0xCA 0x1C
Gamma	Write	1.8	0x02 0x14 0x00 0x04 0x00 0x34 0x05 0xCA 0x00 0x1B
		2	0x02 0x14 0x00 0x04 0x00 0x34 0x05 0xCA 0x01 0x1C
		2.2	0x02 0x14 0x00 0x04 0x00 0x34 0x05 0xCA 0x02 0x1D
		2.35	0x02 0x14 0x00 0x04 0x00 0x34 0x05 0xCA 0x03 0x1E
		2.5	0x02 0x14 0x00 0x04 0x00 0x34 0x05 0xCA 0x04 0x1F
		sRGB	0x02 0x14 0x00 0x04 0x00 0x34 0x05 0xCA 0x05 0x20
		Cubic	0x02 0x14 0x00 0x04 0x00 0x34 0x05 0xCA 0x06 0x21
	Read	Status	0x07 0x14 0x00 0x05 0x00 0x34 0x00 0x00 0x12 0x0B 0x6A
Reset current color settings	Write	Reset	0x06 0x14 0x00 0x04 0x00 0x34 0x11 0x2A 0x00 0x87
ISF mode	Write	ON	0x06 0x14 0x00 0x04 0x00 0x34 0x12 0x38 0x01 0x97
		OFF	0x06 0x14 0x00 0x04 0x00 0x34 0x12 0x38 0x00 0x96
	Read	Status	0x07 0x14 0x00 0x05 0x00 0x34 0x00 0x00 0x12 0x38 0x97

Function	Status	Action	Command
HDR	Write	Auto	0x06 0x14 0x00 0x04 0x00 0x34 0x12 0x39 0x00 0x97
		SDR	0x06 0x14 0x00 0x04 0x00 0x34 0x12 0x39 0x01 0x98
	Read	Status	0x07 0x14 0x00 0x05 0x00 0x34 0x00 0x00 0x11 0x2C 0x8A
EOTF	Write	Low	0x06 0x14 0x00 0x04 0x00 0x34 0x11 0x2C 0x00 0x89
		Mid	0x06 0x14 0x00 0x04 0x00 0x34 0x11 0x2C 0x01 0x8A
		High	0x06 0x14 0x00 0x04 0x00 0x34 0x11 0x2C 0x02 0x8B
	Read	Status	0x07 0x14 0x00 0x05 0x00 0x34 0x00 0x00 0x11 0x2D 0x8B
Frame Interpolation	Write	Low	0x06 0x14 0x00 0x04 0x00 0x34 0x11 0x2D 0x00 0x8A
		Mid	0x06 0x14 0x00 0x04 0x00 0x34 0x11 0x2D 0x01 0x8B
		High	0x06 0x14 0x00 0x04 0x00 0x34 0x11 0x2D 0x02 0x8C
	Read	Status	0x07 0x14 0x00 0x05 0x00 0x34 0x00 0x00 0x12 0x39 0x98
Primary Color	Write	R	0x06 0x14 0x00 0x04 0x00 0x34 0x12 0x10 0x00 0x6E
		G	0x06 0x14 0x00 0x04 0x00 0x34 0x12 0x10 0x01 0x6F
		B	0x06 0x14 0x00 0x04 0x00 0x34 0x12 0x10 0x02 0x70
		C	0x06 0x14 0x00 0x04 0x00 0x34 0x12 0x10 0x03 0x71
		M	0x06 0x14 0x00 0x04 0x00 0x34 0x12 0x10 0x04 0x72
		Y	0x06 0x14 0x00 0x04 0x00 0x34 0x12 0x10 0x05 0x73
	Read	Status	0x07 0x14 0x00 0x05 0x00 0x34 0x00 0x00 0x12 0x10 0x6F
Hue	Write	Decrease	0x06 0x14 0x00 0x04 0x00 0x34 0x12 0x11 0x00 0x6F
		Increase	0x06 0x14 0x00 0x04 0x00 0x34 0x12 0x11 0x01 0x70
	Read	Get Volume	0x07 0x14 0x00 0x05 0x00 0x34 0x00 0x00 0x12 0x11 0x70

Function	Status	Action	Command
Saturation	Write	Decrease	0x06 0x14 0x00 0x04 0x00 0x34 0x12 0x12 0x00 0x70
		Increase	0x06 0x14 0x00 0x04 0x00 0x34 0x12 0x12 0x01 0x71
	Read	Get Volume	0x07 0x14 0x00 0x05 0x00 0x34 0x00 0x00 0x12 0x12 0x71
Gain	Write	Decrease	0x06 0x14 0x00 0x04 0x00 0x34 0x12 0x13 0x00 0x71
		Increase	0x06 0x14 0x00 0x04 0x00 0x34 0x12 0x13 0x01 0x72
	Read	Get Valume	0x07 0x14 0x00 0x05 0x00 0x34 0x00 0x00 0x12 0x13 0x72
Sharpness	Write	Decrease	0x06 0x14 0x00 0x04 0x00 0x34 0x12 0x0E 0x00 0x6C
		Increase	0x06 0x14 0x00 0x04 0x00 0x34 0x12 0x0E 0x01 0x6D
	Read	Get Valume	0x07 0x14 0x00 0x05 0x00 0x34 0x00 0x00 0x12 0x0E 0x6D
Source input	Write	Comp. 1	0x06 0x14 0x00 0x04 0x00 0x34 0x13 0x01 0x00 0x60
		HDMI 1	0x06 0x14 0x00 0x04 0x00 0x34 0x13 0x01 0x03 0x63
		HDMI 2	0x06 0x14 0x00 0x04 0x00 0x34 0x13 0x01 0x07 0x67
		HDMI 3	0x06 0x14 0x00 0x04 0x00 0x34 0x13 0x01 0x09 0x69
		HDMI 4	0x06 0x14 0x00 0x04 0x00 0x34 0x13 0x01 0x0e 0x6e
		USB1	0x06 0x14 0x00 0x04 0x00 0x34 0x13 0x01 0x1D 0x7D
		USB2	0x06 0x14 0x00 0x04 0x00 0x34 0x13 0x01 0x1E 0x7E
Audio Mode	Read	Get Valume	0x07 0x14 0x00 0x05 0x00 0x34 0x00 0x00 0x14 0x05 0x66
	Write	Movie	0x06 0x14 0x00 0x04 0x00 0x34 0x14 0x05 0x04 0x69
		Music	0x06 0x14 0x00 0x04 0x00 0x34 0x14 0x05 0x05 0x6A
		User	0x06 0x14 0x00 0x04 0x00 0x34 0x14 0x05 0x06 0x6B

Function	Status	Action	Command
S/PDIF	Write	On	0x06 0x14 0x00 0x04 0x00 0x34 0x14 0x05 0x07 0x6C
		Off	0x06 0x14 0x00 0x04 0x00 0x34 0x14 0x05 0x08 0x6D
	Read	Status	0x07 0x14 0x00 0x05 0x00 0x34 0x00 0x00 0x13 0x01 0x61
Mute	Write	On	0x06 0x14 0x00 0x04 0x00 0x34 0x14 0x00 0x01 0x61
		Off	0x06 0x14 0x00 0x04 0x00 0x34 0x14 0x00 0x00 0x60
	Read	Status	0x07 0x14 0x00 0x05 0x00 0x34 0x00 0x00 0x14 0x00 0x61
Volume	Write	Decrease	0x06 0x14 0x00 0x04 0x00 0x34 0x14 0x02 0x00 0x62
		Increase	0x06 0x14 0x00 0x04 0x00 0x34 0x14 0x01 0x00 0x61
		Set Value	0x06 0x14 0x00 0x04 0x00 0x34 0x13 0x2A 0x11 0x9A
	Read	Get Volume	0x07 0x14 0x00 0x05 0x00 0x34 0x00 0x00 0x14 0x03 0x64
Language	Write	English	0x06 0x14 0x00 0x04 0x00 0x34 0x15 0x00 0x00 0x61
		Français	0x06 0x14 0x00 0x04 0x00 0x34 0x15 0x00 0x01 0x62
		Deutsch	0x06 0x14 0x00 0x04 0x00 0x34 0x15 0x00 0x02 0x63
		Italiano	0x06 0x14 0x00 0x04 0x00 0x34 0x15 0x00 0x03 0x64
		Español	0x06 0x14 0x00 0x04 0x00 0x34 0x15 0x00 0x04 0x65
		РУССКИЙ	0x06 0x14 0x00 0x04 0x00 0x34 0x15 0x00 0x05 0x66
		繁體中文	0x06 0x14 0x00 0x04 0x00 0x34 0x15 0x00 0x06 0x67
		简体中文	0x06 0x14 0x00 0x04 0x00 0x34 0x15 0x00 0x07 0x68
		日本語	0x06 0x14 0x00 0x04 0x00 0x34 0x15 0x00 0x08 0x69
		한국어	0x06 0x14 0x00 0x04 0x00 0x34 0x15 0x00 0x09 0x6A
		Swedish	0x06 0x14 0x00 0x04 0x00 0x34 0x15 0x00 0x0a 0x6B

Function	Status	Action	Command
Language	Write	Dutch	0x06 0x14 0x00 0x04 0x00 0x34 0x15 0x00 0x0b 0x6C
		Turkish	0x06 0x14 0x00 0x04 0x00 0x34 0x15 0x00 0x0c 0x6D
		Czech	0x06 0x14 0x00 0x04 0x00 0x34 0x15 0x00 0x0d 0x6E
		Portugese	0x06 0x14 0x00 0x04 0x00 0x34 0x15 0x00 0x0e 0x6F
		Thai	0x06 0x14 0x00 0x04 0x00 0x34 0x15 0x00 0x0f 0x70
		Polish	0x06 0x14 0x00 0x04 0x00 0x34 0x15 0x00 0x10 0x71
		Finnish	0x06 0x14 0x00 0x04 0x00 0x34 0x15 0x00 0x11 0x72
		Arabic	0x06 0x14 0x00 0x04 0x00 0x34 0x15 0x00 0x12 0x73
		Indonesia	0x06 0x14 0x00 0x04 0x00 0x34 0x15 0x00 0x13 0x74
		Hindi	0x06 0x14 0x00 0x04 0x00 0x34 0x15 0x00 0x14 0x75
		Vietnamese	0x06 0x14 0x00 0x04 0x00 0x34 0x15 0x00 0x15 0x76
		Greek	0x06 0x14 0x00 0x04 0x00 0x34 0x15 0x00 0x16 0x77
		Read	Get Volume
HDMI Range	Write	Full (Enhanced)	0x06 0x14 0x00 0x04 0x00 0x34 0x11 0x29 0x00 0x86
		Limited (Normal)	0x06 0x14 0x00 0x04 0x00 0x34 0x11 0x29 0x01 0x87
		Auto	0x06 0x14 0x00 0x04 0x00 0x34 0x11 0x29 0x02 0x88
	Read	Status	0x07 0x14 0x00 0x05 0x00 0x34 0x00 0x00 0x11 0x29 0x87
CEC	Write	OFF	0x06 0x14 0x00 0x04 0x00 0x34 0x11 0x2B 0x00 0x88
		ON	0x06 0x14 0x00 0x04 0x00 0x34 0x11 0x2B 0x01 0x89
	Read	Status	0x07 0x14 0x00 0x05 0x00 0x34 0x00 0x00 0x11 0x2B 0x89

Function	Status	Action	Command
Remote Key	Write	Menu/ Setting	0x02 0x14 0x00 0x04 0x00 0x34 0x02 0x04 0x0F 0x61
		Exit	0x02 0x14 0x00 0x04 0x00 0x34 0x02 0x04 0x13 0x65
		Top	0x02 0x14 0x00 0x04 0x00 0x34 0x02 0x04 0x0B 0x5D
		Bottom	0x02 0x14 0x00 0x04 0x00 0x34 0x02 0x04 0x0C 0x5E
		Left	0x02 0x14 0x00 0x04 0x00 0x34 0x02 0x04 0x0D 0x5F
		Right	0x02 0x14 0x00 0x04 0x00 0x34 0x02 0x04 0x0E 0x60
		Source	0x02 0x14 0x00 0x04 0x00 0x34 0x02 0x04 0x04 0x56
		Enter	0x02 0x14 0x00 0x04 0x00 0x34 0x02 0x04 0x15 0x67
		Home	0x06 0x14 0x00 0x04 0x00 0x34 0x11 0x35 0x00 0x92

Glossary

This section describes the standard glossary of terms used in all projector models. All terms are listed in alphabetical order.

NOTE: Some terms may not be applicable to your projector.

A Aspect Ratio

Refers to the ratio of the image width to the image height.

B Brightest Mode

Maximizes the brightness of the projected image. This mode is ideal for environments where extra-high brightness is required, such as using the projector in well lit rooms.

Brightness

Adjusts brightness levels of the screen image

C CEC (Consumer Electronics Control)

Synchronizes power on/off operation via HDMI connection. That is, if a device that also supports CEC function is connected to the HDMI input of the projector, when the projector's power is turned off, the power of the connected device will also be turned off automatically. When the power of the connected device is turned on, the projector's power will be turned on automatically.

Color

Adjusts the color saturation.

Color Temp

Allows users to select specific color temperature settings to further customize their viewing experience.

Contrast

Adjusts the difference between the image background (black level) and the foreground (white level).

D Dynamic Black

This feature gives more depth to your image by smoothly adjusting the light and signal output to create a stunning high contrast ratio. Bright scenes appear crisp and clear, while dark scenes remain detailed with deep blacks and exceptional light and shade detail.

F Focus

Manually improve the clarity of the projected image.

G Gamma

Allows the user to manually select the greyscale curve of the projector.

H HDMI Range

Allows the user to select HDMI greyscale range between 0~255 (full range) , 16~235 (limited range) or Auto by the signal type detected.

HDR (High-Dynamic Range)

Keeps the brightness level and enhances details on the dark level.

High Altitude Mode

Optional mode for users who live in an environment between 1,500 m and 3,000 m above sea level, and the temperature is between 5° C and 25° C.

Activating it will improve projector cooling and performance.

I Information

Displays the timing mode (video signal input), the projector model number, the serial number, and the ViewSonic® website URL.

Input Select

Toggles between the various input options that are available for the projector.

K Keystone
The distortion of an image caused by projecting it onto an angled surface.

L Light Source Level
Use Normal or Eco mode to adjust the brightness level and power consumption.

M Movie Mode
A Picture Mode appropriate for playing colorful movies, video clips from digital cameras, or DVs through the PC input. Best for a low light environment.

S Sharpness
Adjusts the picture quality.

Troubleshooting

This section describes some common problems that you may experience when using the projector.

Problem or Issue	Possible Solutions
The projector does not turn on	<ul style="list-style-type: none">• Ensure the power cord is properly attached to the projector and to the power outlet.• If the cooling process has not completed, please wait until it has finished then try to turn on the projector again.• If the above does not work, try another power outlet or another electrical device with the same power outlet.
There is no picture	<ul style="list-style-type: none">• Ensure the video source cable is connected properly, and that the video source is turned on.• If the input source is not selected automatically, select the correct source with the Source key on either the projector or the remote control.
The image is blurred	<ul style="list-style-type: none">• Adjusting focus with the remote control will help correctly focus the projection lens.• Ensure the projector and screen are aligned properly. If necessary, adjust the height of the projector as well as the projection angle and direction.
The remote control does not work	<ul style="list-style-type: none">• Ensure there are no obstacles between the remote control and projector; and that they are within 8 m (26 ft) of each other.• The batteries may be out of power, please check and replace if necessary.

Maintenance

General Precautions

- Make sure the projector is turned off and the power cable is unplugged from the power outlet.
- Never remove any parts from the projector. Contact ViewSonic® or a reseller when any part of the projector needs replacing.
- Never spray or pour any liquid directly onto the case.
- Handle the projector with care, as a darker-colored projector, if scuffed, may show marks more clearly than a lighter-colored projector.

Cleaning the Lens

- Use a canister of compressed air to remove dust.
- If the lens is still not clean, use lens-cleaning paper or moisten a soft cloth with lens cleaner and gently wipe the surface.

CAUTION: Never rub the lens with abrasive materials.

Cleaning the Case

- Use a soft, lint-free, dry cloth to remove dirt or dust.
- If the case is still not clean, apply a small amount of non-ammonia, non-alcohol based, mild non-abrasive detergent onto a clean, soft, lint-free cloth, then wipe the surface.

CAUTION: Never use wax, alcohol, benzene, thinner, or other chemical detergents.

Storing the Projector

If you intend to store the projector for an extended period of time:

- Ensure the temperature and humidity of the storage area are within the recommend range.
- Retract the adjuster foot completely.
- Remove the batteries from the remote control.
- Pack the projector in its original packaging or equivalent.

Disclaimer

- ViewSonic® does not recommend the use of any ammonia or alcohol-based cleaners on the lens or case. Some chemical cleaners have been reported to damage the lens and/or case of the projector.
- ViewSonic® will not be liable for damage resulting from use of any ammonia or alcohol-based cleaners.

LED Indicators

Light	Status and Description
	
Power	
Red	Stand-by mode (5 sec.) (< 0.5W)
Blue	Powering up
Blue	Normal operation

> Regulatory and Service Information

Compliance Information

This section addresses all connected requirements and statements regarding regulations. Confirmed corresponding applications shall refer to nameplate labels and relevant markings on the unit.

FCC Compliance Statement

This device complies with part 15 of FCC Rules. Operation is subject to the following two conditions: (1) this device may not cause harmful interference, and (2) this device must accept any interference received, including interference that may cause undesired operation. This equipment has been tested and found to comply with the limits for a Class B digital device, pursuant to part 15 of the FCC Rules.

These limits are designed to provide reasonable protection against harmful interference in a residential installation. This equipment generates, uses, and can radiate radio frequency energy, and if not installed and used in accordance with the instructions, may cause harmful interference to radio communications. However, there is no guarantee that interference will not occur in a particular installation. If this equipment does cause harmful interference to radio or television reception, which can be determined by turning the equipment off and on, the user is encouraged to try to correct the interference by one or more of the following measures:

- Reorient or relocate the receiving antenna.
- Increase the separation between the equipment and receiver.
- Connect the equipment into an outlet on a circuit different from that to which the receiver is connected.
- Consult the dealer or an experienced radio/TV technician for help.

Warning: You are cautioned that changes or modifications not expressly approved by the party responsible for compliance could void your authority to operate the equipment.

Industry Canada Statement

CAN ICES-003(B) / NMB-003(B)

CE Conformity for European Countries

 The device complies with the EMC Directive 2014/30/EU and Low Voltage Directive 2014/35/EU. and Radio Equipment Directive 2014/53/EU.

The following information is only for EU-member states:

The mark shown to the right is in compliance with the Waste Electrical and Electronic Equipment Directive 2012/19/EU (WEEE). The mark indicates the requirement NOT to dispose of the equipment as unsorted municipal waste, but use the return and collection systems according to local law.



Declaration of RoHS2 Compliance

This product has been designed and manufactured in compliance with Directive 2011/65/EU of the European Parliament and the Council on restriction of the use of certain hazardous substances in electrical and electronic equipment (RoHS2 Directive) and is deemed to comply with the maximum concentration values issued by the European Technical Adaptation Committee (TAC) as shown below:

Substance	Proposed Maximum Concentration	Actual Concentration
Lead (Pb)	0.1%	< 0.1%
Mercury (Hg)	0.1%	< 0.1%
Cadmium (Cd)	0.01%	< 0.01%
Hexavalent Chromium (Cr6 ⁺)	0.1%	< 0.1%
Polybrominated biphenyls (PBB)	0.1%	< 0.1%
Polybrominated diphenyl ethers (PBDE)	0.1%	< 0.1%
Bis (2-ethylhexyl) phthalate (DEHP)	0.1%	< 0.1%
Butyl benzyl phthalate (BBP)	0.1%	< 0.1%
Dibutyl phthalate (DBP)	0.1%	< 0.1%
Diisobutyl phthalate (DIBP)	0.1%	< 0.1%

Certain components of products as stated above are exempted under the Annex III of the RoHS2 Directives as noted below. Examples of exempted components are:

- Mercury in cold cathode fluorescent lamps and external electrode fluorescent lamps (CCFL and EEFL) for special purposes not exceeding (per lamp):
 - » Short length (500 mm): maximum 3.5 mg per lamp.
 - » Medium length (> 500 mm and 1,500 mm): maximum 5 mg per lamp.
 - » Long length (> 1,500 mm): maximum 13 mg per lamp.
- Lead in glass of cathode ray tubes.
- Lead in glass of fluorescent tubes not exceeding 0.2% by weight.
- Lead as an alloying element in aluminum containing up to 0.4% lead by weight.
- Copper alloy containing up to 4% lead by weight.
- Lead in high melting temperature type solders (i.e. lead-based alloys containing 85% by weight or more lead).
- Electrical and electronic components containing lead in a glass or ceramic other than dielectric ceramic in capacitors, e.g. piezoelectronic devices, or in a glass or ceramic matrix compound.

Indian Restriction of Hazardous Substances

Restriction on Hazardous Substances statement (India). This product complies with the “India E-waste Rule 2011” and prohibits use of lead, mercury, hexavalent chromium, polybrominated biphenyls or polybrominated diphenyl ethers in concentrations exceeding 0.1 weight % and 0.01 weight % for cadmium, except for the exemptions set in Schedule 2 of the Rule.

Product Disposal at End of Product Life

ViewSonic® respects the environment and is committed to working and living green. Thank you for being part of Smarter, Greener Computing. Please visit the ViewSonic® website to learn more.

USA & Canada:

<http://www.viewsonic.com/company/green/recycle-program/>

Europe:

<http://www.viewsoniceurope.com/eu/support/call-desk/>

Taiwan:

<https://recycle.epa.gov.tw/>

Copyright Information

Copyright© ViewSonic® Corporation, 2021. All rights reserved.

Macintosh and Power Macintosh are registered trademarks of Apple Inc.

Microsoft, Windows, and the Windows logo are registered trademarks of Microsoft Corporation in the United States and other countries.

ViewSonic®, the three birds logo, OnView, ViewMatch, and ViewMeter are registered trademarks of ViewSonic® Corporation.

VESA is a registered trademark of the Video Electronics Standards Association. DPMS, DisplayPort, and DDC are trademarks of VESA.

ENERGY STAR® is a registered trademark of the U.S. Environmental Protection Agency (EPA).

As an ENERGY STAR® partner, ViewSonic® Corporation has determined that this product meets the ENERGY STAR® guidelines for energy efficiency.

Disclaimer: ViewSonic® Corporation shall not be liable for technical or editorial errors or omissions contained herein; nor for incidental or consequential damages resulting from furnishing this material, or the performance or use of this product.

In the interest of continuing product improvement, ViewSonic® Corporation reserves the right to change product specifications without notice. Information in this document may change without notice.

No part of this document may be copied, reproduced, or transmitted by any means, for any purpose without prior written permission from ViewSonic® Corporation.

Customer Service

For technical support or product service, see the table below or contact your reseller.

NOTE: You will need the product's serial number.

Country/ Region	Website	Country/ Region	Website
Asia Pacific & Africa			
Australia	www.viewsonic.com/au/	Bangladesh	www.viewsonic.com/bd/
中国 (China)	www.viewsonic.com.cn	香港 (繁體中文)	www.viewsonic.com/hk/
Hong Kong (English)	www.viewsonic.com/hk-en/	India	www.viewsonic.com/in/
Indonesia	www.viewsonic.com/id/	Israel	www.viewsonic.com/il/
日本 (Japan)	www.viewsonic.com/jp/	Korea	www.viewsonic.com/kr/
Malaysia	www.viewsonic.com/my/	Middle East	www.viewsonic.com/me/
Myanmar	www.viewsonic.com/mm/	Nepal	www.viewsonic.com/np/
New Zealand	www.viewsonic.com/nz/	Pakistan	www.viewsonic.com/pk/
Philippines	www.viewsonic.com/ph/	Singapore	www.viewsonic.com/sg/
臺灣 (Taiwan)	www.viewsonic.com/tw/	ประเทศไทย	www.viewsonic.com/th/
Việt Nam	www.viewsonic.com/vn/	South Africa & Mauritius	www.viewsonic.com/za/
Americas			
United States	www.viewsonic.com/us	Canada	www.viewsonic.com/us
Latin America	www.viewsonic.com/la		
Europe			
Europe	www.viewsonic.com/eu/	France	www.viewsonic.com/fr/
Deutschland	www.viewsonic.com/de/	Қазақстан	www.viewsonic.com/kz/
Россия	www.viewsonic.com/ru/	España	www.viewsonic.com/es/
Türkiye	www.viewsonic.com/tr/	Україна	www.viewsonic.com/ua/
United Kingdom	www.viewsonic.com/uk/		

Limited Warranty

ViewSonic® Projector

What the warranty covers:

ViewSonic® warrants its products to be free from defects in material and workmanship, under normal use, during the warranty period. If a product proves to be defective in material or workmanship during the warranty period, ViewSonic® will, at its sole option, repair or replace the product with a like product. Replacement product or parts may include remanufactured or refurbished parts or components.

Limited Three (3) year General Warranty:

Subject to the more limited one (1) year warranty set out below, North and South America: Three (3) years warranty for all parts excluding the lamp, three (3) years for labor, and one (1) year for the original lamp from the date of the first consumer purchase.

Other regions or countries: Please check with your local dealer or local ViewSonic® office for the warranty information.

Limited One (1) year Heavy Usage Warranty:

Under heavy usage settings, where a projector's use includes more than fourteen (14) hours average daily usage, North and South America: One (1) year warranty for all parts excluding the lamp, one (1) year for labor, and ninety (90) days for the original lamp from the date of the first consumer purchase; Europe: One (1) year warranty for all parts excluding the lamp, one (1) year for labor, and ninety (90) days for the original lamp from the date of the first consumer purchase. Other regions or countries: Please check with your local dealer or local ViewSonic® office for the warranty information. Lamp warranty subject to terms and conditions, verification and approval. Applies to manufacturer's installed lamp only. All accessory lamps purchased separately are warranted for 90 days.

Who the warranty protects:

This warranty is valid only for the first consumer purchaser.

What the warranty does not cover:

1. Any product on which the serial number has been defaced, modified, or removed.
2. Damage, deterioration, or malfunction resulting from:
 - » Accident, misuse, neglect, fire, water, lightning, or other acts of nature, unauthorized product modification, or failure to follow instructions supplied with the product.
 - » Operation outside of product specifications.
 - » Operation of the product for other than the normal intended use or not under normal conditions.
 - » Repair or attempted repair by anyone not authorized by ViewSonic®.
 - » Any damage of the product due to shipment.
 - » Removal or installation of the product.
 - » Causes external to the product, such as electric power fluctuations or failure.
 - » Use of supplies or parts not meeting Viewsonic's specifications.
 - » Normal wear and tear.
 - » Any other cause which does not relate to a product defect.
3. Removal, installation, and set-up service charges.

How to get service:

1. For information about receiving service under warranty, contact ViewSonic® Customer Support (Please refer to the "Customer Support" page). You will need to provide your product's serial number.
2. To obtain warranted service, you will be required to provide: (a) the original dated sales slip, (b) your name, (c) your address, (d) a description of the problem, and (e) the serial number of the product.
3. Take or ship the product, freight prepaid, in the original container to an authorized ViewSonic® service center or ViewSonic®.
4. For additional information or the name of the nearest ViewSonic® service center, contact ViewSonic®.

Limitation of implied warranties:

There are no warranties, express or implied, which extend beyond the description contained herein including the implied warranty of merchantability and fitness for a particular purpose.

Exclusion of damages:

ViewSonic's liability is limited to the cost of repair or replacement of the product. ViewSonic® shall not be liable for:

1. Damage to other property caused by any defects in the product, damages based upon inconvenience, loss of use of the product, loss of time, loss of profits, loss of business opportunity, loss of goodwill, interference with business relationships, or other commercial loss, even if advised of the possibility of such damages.
2. Any other damages, whether incidental, consequential or otherwise.
3. Any claim against the customer by any other party.

Effect of state law:

This warranty gives you specific legal rights, and you may also have other rights which vary from local authority. Some local governments do not allow limitations on implied warranties and/or do not allow the exclusion of incidental or consequential damages, so the above limitations and exclusions may not apply to you.

Sales outside the U.S.A. and Canada:

For warranty information and service on ViewSonic® products sold outside of the U.S.A. and Canada, contact ViewSonic® or your local ViewSonic® dealer.

The warranty period for this product in mainland China (Hong Kong, Macao, and Taiwan Excluded) is subject to the terms and conditions of the Maintenance Guarantee Card.

For users in Europe and Russia, full details of warranty provided can be found at: <http://www.viewsonic.com/eu/> under "Support/Warranty Information".

Mexico Limited Warranty

ViewSonic® Projector

What the warranty covers:

ViewSonic® warrants its products to be free from defects in material and workmanship, under normal use, during the warranty period. If a product proves to be defective in material or workmanship during the warranty period, ViewSonic® will, at its sole option, repair or replace the product with a like product. Replacement product or parts may include remanufactured or refurbished parts or components & accessories.

How long the warranty is effective:

3 years for all parts excluding the lamp, 3 years for labor, 1 year for the original lamp from the date of the first consumer purchase.

Lamp warranty subject to terms and conditions, verification and approval. Applies to manufacturer's installed lamp only.

All accessory lamps purchased separately are warranted for 90 days.

Who the warranty protects:

This warranty is valid only for the first consumer purchaser.

What the warranty excludes and does not cover:

1. Any product on which the serial number has been defaced, modified or removed.
2. Damage, deterioration, or malfunction resulting from:
 - » Accident, misuse, neglect, fire, water, lightning, or other acts of nature, unauthorized product modification, unauthorized attempted repair, or failure to follow instructions supplied with the product.
 - » Any damage of the product due to shipment.
 - » Causes external to the product, such as electrical power fluctuations or failure.
 - » Use of supplies or parts not meeting ViewSonic®'s specifications.
 - » Normal wear and tear.
 - » Any other cause which does not relate to a product defect.
3. Any product exhibiting a condition commonly known as "image burn-in" which results when a static image is displayed on the product for an extended period of time.
4. Removal, installation, insurance, and set-up service charges.

How to get service:

For information about receiving service under warranty, contact ViewSonic® Customer Support (Please refer to the attached “Customer Service” page). You will need to provide your product’s serial number, so please record the product information in the space provided below on your purchase for your future use. Please retain your receipt of proof of purchase to support your warranty claim.

For Your Records

Product Name: _____ Model Number: _____

Document Number: _____ Serial Number: _____

Purchase Date: _____ Extended Warranty Purchase? _____ (Y/N)

If so, what date does warranty expire? _____

1. To obtain warranty service, you will be required to provide (a) the original dated sales slip, (b) your name, (c) your address, (d) a description of the problem, and (e) the serial number of the product.
2. Take or ship the product, in the original container packaging, to an authorized ViewSonic® service center.
3. Round trip transportation costs for in-warranty products will be paid by ViewSonic®.

Limitation of implied warranties:

There are no warranties, express or implied, which extend beyond the description contained herein including the implied warranty of merchantability and fitness for a particular purpose.

Exclusion of damages:

ViewSonic®’s liability is limited to the cost of repair or replacement of the product. ViewSonic® shall not be liable for:

1. Damage to other property caused by any defects in the product, damages based upon inconvenience, loss of use of the product, loss of time, loss of profits, loss of business opportunity, loss of goodwill, interference with business relationships, or other commercial loss, even if advised of the possibility of such damages.
2. Any other damages, whether incidental, consequential or otherwise.
3. Any claim against the customer by any other party.
4. Repair or attempted repair by anyone not authorized by ViewSonic®.

Contact Information for Sales & Authorized Service (Centro Autorizado de Servicio) within Mexico:	
Name, address, of manufacturer and importers: México, Av. de la Palma #8 Piso 2 Despacho 203, Corporativo Interpalmas, Col. San Fernando Huixquilucan, Estado de México Tel: (55) 3605-1099 http://www.viewsonic.com/la/soporte/index.htm	
NÚMERO GRATIS DE ASISTENCIA TÉCNICA PARA TODO MÉXICO: 001.866.823.2004	
Hermosillo: Distribuciones y Servicios Computacionales SA de CV. Calle Juárez 284 local 2 Col. Bugambilias C.P: 83140 Tel: 01-66-22-14-9005 E-Mail: disc2@hmo.megared.net.mx	Villahermosa: Compumantenimientos Garantizados, S.A. de C.V. AV. GREGORIO MENDEZ #1504 COL, FLORIDA C.P. 86040 Tel: 01 (993) 3 52 00 47 / 3522074 / 3 52 20 09 E-Mail: compumantenimientos@prodigy.net.mx
Puebla, Pue. (Matriz): RENTA Y DATOS, S.A. DE C.V. Domicilio: 29 SUR 721 COL. LA PAZ 72160 PUEBLA, PUE. Tel: 01(52).222.891.55.77 CON 10 LINEAS E-Mail: datos@puebla.megared.net.mx	Veracruz, Ver.: CONEXION Y DESARROLLO, S.A DE C.V. Av. Americas # 419 ENTRE PINZÓN Y ALVARADO Fracc. Reforma C.P. 91919 Tel: 01-22-91-00-31-67 E-Mail: gacosta@qplus.com.mx
Chihuahua: Soluciones Globales en Computación C. Magisterio # 3321 Col. Magisterial Chihuahua, Chih. Tel: 4136954 E-Mail: Cefeo@soluglobales.com	Cuernavaca: Compusupport de Cuernavaca SA de CV Francisco Leyva # 178 Col. Miguel Hidalgo C.P. 62040, Cuernavaca Morelos Tel: 01 777 3180579 / 01 777 3124014 E-Mail: aquevedo@compusupportcva.com
Distrito Federal: QPLUS, S.A. de C.V. Av. Coyoacán 931 Col. Del Valle 03100, México, D.F. Tel: 01(52)55-50-00-27-35 E-Mail : gacosta@qplus.com.mx	Guadalajara, Jal.: SERVICRECE, S.A. de C.V. Av. Niños Héroes # 2281 Col. Arcos Sur, Sector Juárez 44170, Guadalajara, Jalisco Tel: 01(52)33-36-15-15-43 E-Mail: mmiranda@servicrece.com
Guerrero Acapulco: GS Computación (Grupo Sesicomp) Progreso #6-A, Colo Centro 39300 Acapulco, Guerrero Tel: 744-48-32627	Monterrey: Global Product Services Mar Caribe # 1987, Esquina con Golfo Pérsico Fracc. Bernardo Reyes, CP 64280 Monterrey N.L. México Tel: 8129-5103 E-Mail: aydeem@gps1.com.mx
MERIDA: ELECTROSER Av Reforma No. 403Gx39 y 41 Mérida, Yucatán, México CP97000 Tel: (52) 999-925-1916 E-Mail: rrrb@sureste.com	Oaxaca, Oax.: CENTRO DE DISTRIBUCION Y SERVICIO, S.A. de C.V. Murguía # 708 P.A., Col. Centro, 68000, Oaxaca Tel: 01(52)95-15-15-22-22 Fax: 01(52)95-15-13-67-00 E-Mail: gpotai2001@hotmail.com
Tijuana: STD Av Ferrocarril Sonora #3780 L-C Col 20 de Noviembre Tijuana, Mexico	FOR USA SUPPORT: ViewSonic® Corporation 381 Brea Canyon Road, Walnut, CA. 91789 USA Tel: 800-688-6688 E-Mail: http://www.viewsonic.com



ViewSonic®
See the difference®