



User Manual

DU6098Z

DU6198Z

DU6298Z

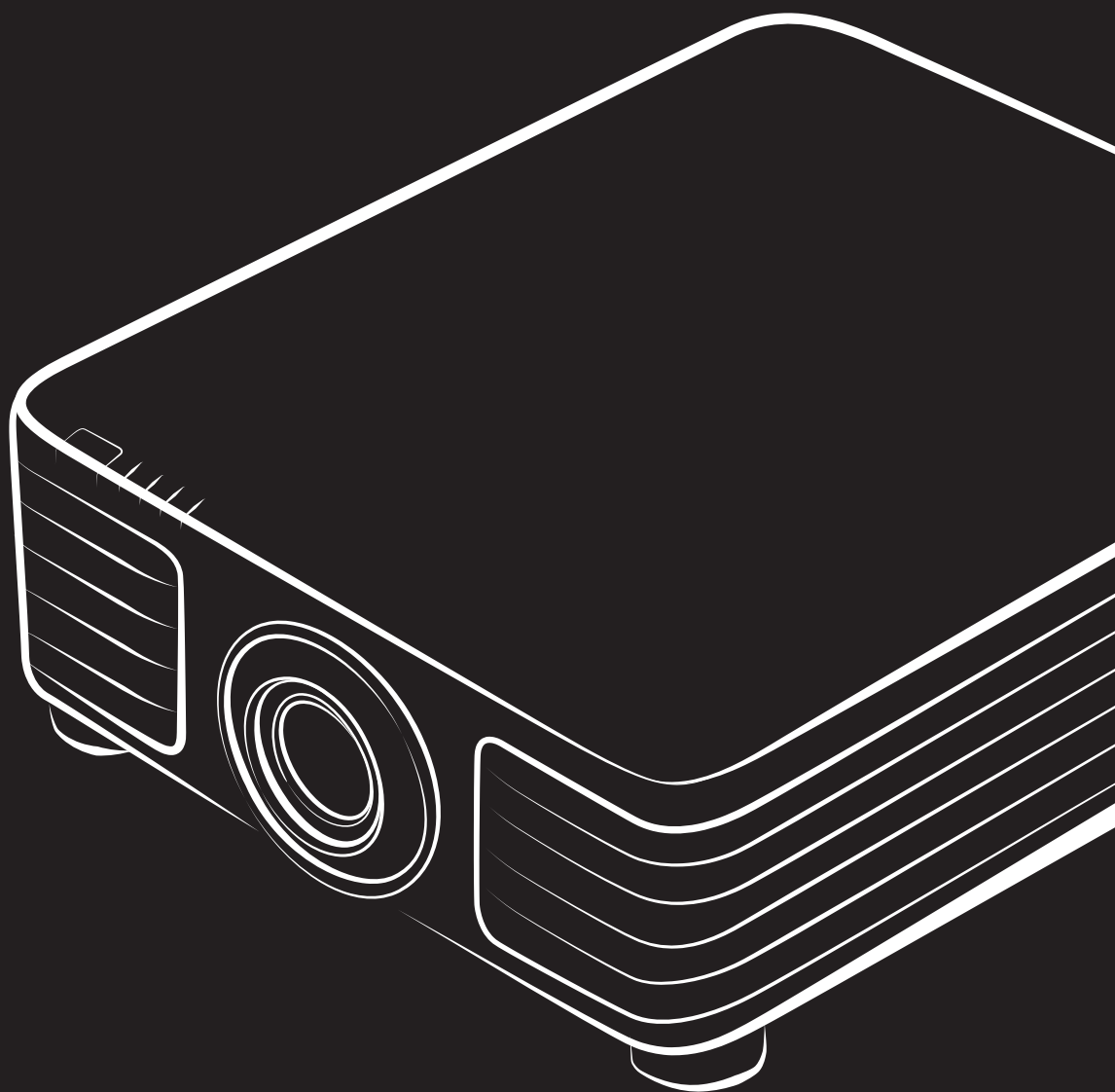

Copyright

This publication, including all photographs, illustrations and software, is protected under international copyright laws, with all rights reserved. Neither this manual, nor any of the material contained herein, may be reproduced without written consent of the author.

© Copyright 2020

Disclaimer

The information in this document is subject to change without notice. The manufacturer makes no representations or warranties with respect to the contents hereof and specifically disclaims any implied warranties of merchantability or fitness for any particular purpose. The manufacturer reserves the right to revise this publication and to make changes from time to time in the content hereof without obligation of the manufacturer to notify any person of such revision or changes.

Trademark Recognition



Kensington is a U.S. registered trademark of ACCO Brand Corporation with issued registrations and pending applications in other countries throughout the world.



HDMI, the HDMI Logo, and High-Definition Multimedia Interface are trademarks or registered trademarks of HDMI Licensing LLC in the United States and other countries.



HDBaseT™ and the HDBaseT Alliance logo are trademarks of the HDBaseT Alliance.

All other product names used in this manual are the properties of their respective owners and are acknowledged.

Important Safety Information



Important:

It is strongly recommended that you read this section carefully before using the projector. These safety and usage instructions will ensure that you enjoy many years of safe use of the projector. Keep this manual for future reference.

Symbols Used

Warning symbols are used on the unit and in this manual to alert you of hazardous situations.

The following styles are used in this manual to alert you to important information.

Note:

Provides additional information on the topic at hand.



Important:

Provides additional information that should not be overlooked.



Caution:

Alerts you to situations that may damage the unit.



Warning:

Alerts you to situations that may damage the unit, create a hazardous environment, or cause personal injury.

Note:

As with any bright light source, do not stare into the beam, RG2 IEC 62471-5:2015

Throughout this manual, component parts and items in the OSD menus are denoted in bold font as in this example:

“Push the **Menu** button on the remote control to open the **Main** menu.”

General Safety Information

- Do not open the unit case. There are no user-serviceable parts in the unit. For servicing, contact qualified service personnel.
- Follow all warnings and cautions in this manual and on the unit case.
- To avoid damage to eyes, do not look into the lens when the light source is on.
- Do not place the unit on an unstable surface, cart, or stand.
- Avoid using the system near water, in direct sunlight, or near a heating device.
- Do not place heavy objects such as books or bags on the unit.

Notice

This product is intended for the adults who have the ability to operate this machine.

Please write down your projector model number and serial number and keep the information for maintenance purposes in the future. Should the equipment be lost or stolen, the information could also be used for the police report.

Model number:

Serial number:

LASER WARNING



This symbol indicates that there is a potential hazard of eye exposure to laser radiation unless the instructions are closely followed.

CLASS 3R LASER PRODUCT



This Laser Product is designated as Class 3R during all procedures of operation. **LASER LIGHT - AVOID DIRECT EYE EXPOSURE.**

Do not point laser or allow laser light to be directed or reflected toward other people or reflective objects .

Direct or scattered light can be hazardous to eyes and skin.



There is a potential hazard of eye exposure to laser radiation if the included instructions are not followed.

Caution – use of controls or adjustments or performance of procedures other than those specified herein may result in hazardous radiation exposure

Laser Parameters

Wavelength	449nm - 461nm (Blue)
Mode of operation	Pulsed, due to frame rate
Pulse width	1.34ms
Pulse repetition rate	120Hz
Maximum laser energy	0.698mJ
Total internal power	>100w
Apparent source size	>10mm, at lens stop
Divergence	>100 mili Radian

Product labels

Below drawing show the label's location

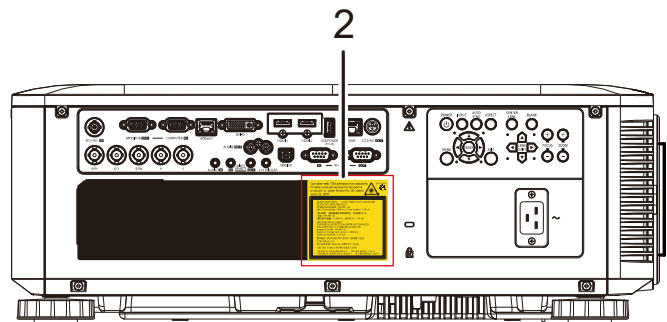
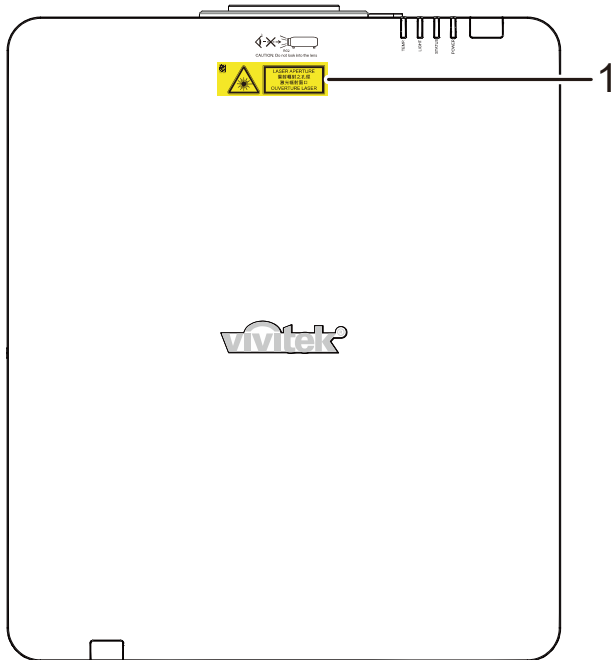

1. Hazard Warning Symbol and Aperture Label



2. Explanatory Label



Location of laser aperture

Below drawing is the laser aperture location. Be careful not to let the eye see the light directly.

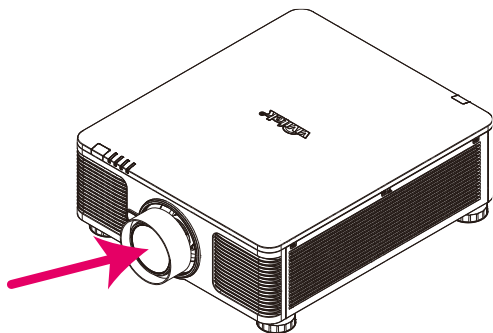

Laser aperture

Interlock switches

This machine has 2 (Top cover x 1, Lens x 1) Interlock switches to protect the laser light Leakage.

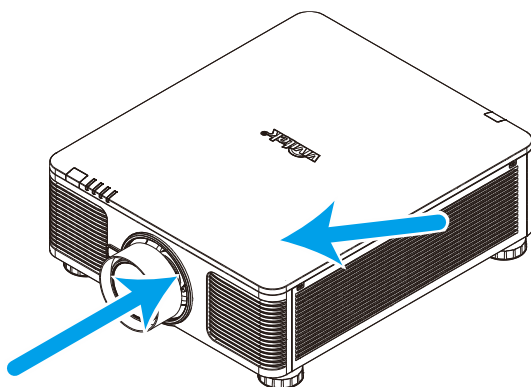

1. Will power-off the system individually when the top cover is removed.
2. Will power-off the system individually when the lens is removed or not install correctly.

Projector Installation Notice

- **There is no limitation angle for projector installation.**

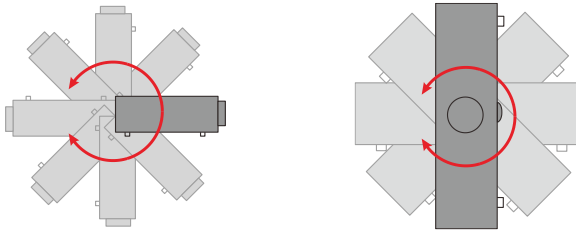

- Allow at least 50 cm clearance around the exhaust vent.

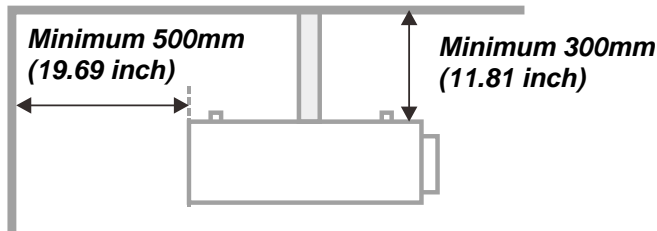
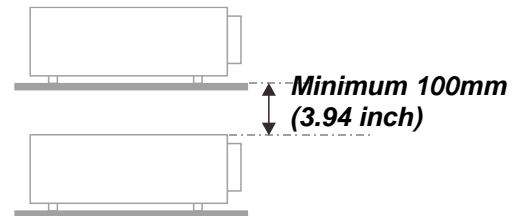
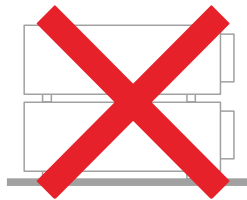
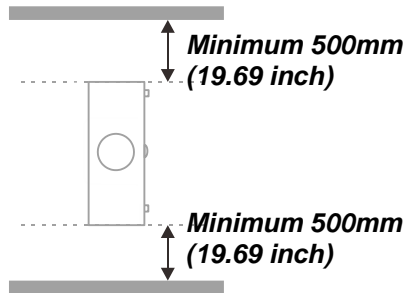
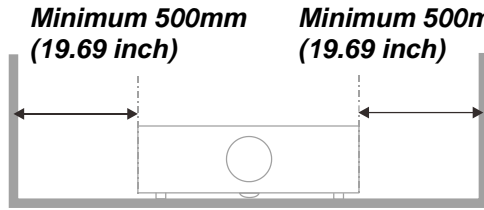
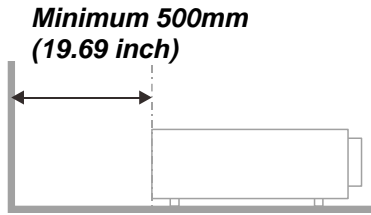

- Ensure that the intake vents do not recycle hot air from the exhaust vent.
- When operating the projector in an enclosed space, ensure that the surrounding air temperature within the enclosure does not exceed operation temperature while the projector is running, and the air intake and exhaust vents are unobstructed.
- All enclosures should pass a certified thermal evaluation to ensure that the projector does not recycle exhaust air, as this may cause the device to shutdown even if the enclosure temperature is within the acceptable operation temperature range.

Verify Installation Location

- To supply power, the 3-blade (with earthing lead) socket should be used to ensure proper grounding and equalized ground potential for all of the equipment in the Projector System.
- The power code provided with the Projector should be used. In case of any missing item, other qualified 3-blade (with earthing lead) power cord can be used as substitution; however, do not use 2-blade power cord.
- Verify if the voltage is stable, grounded properly and there is no electricity leakage.
- Measure total power consumption which should not higher the safety capacity and avoid safety issue and short circuit.
- Turn on Altitude Mode when located in high altitude areas
- The projector can only be installed upright or inverted.
- When installation the bracket, make sure the weight limit is not exceed and firmly secured.
- Avoid installing near air conditioner duct or subwoofer.
- Avoid installing at high temperature, insufficient cooling and heavy dust locations.
- Keep your product away from fluorescent lamps (>1 Meter) to avoid malfunction caused by IR interference
- The VGA IN connector should be connected to the VGA IN port. Note that it should be inserted tightly, with the screws on both sides securely fastened to ensure proper connection of the signal wire for achieving optimal display effect.
- The AUDIO IN connector should be connected to the AUDIO IN port and CANNOT be connected to AUDIO OUT or other ports like BNC, RCA; otherwise, it will lead to mute output and even DAMAGE the port.
- Install the projector above 200cm to avoid damage.
- The power cord and signal cable should be connected before power on the projector. During the projector starting and operating process, DO NOT insert or remove the signal cable or the power cord to avoid damaging the projector.

Cooling notes

Air outlet

- Make sure the air outlet is 50cm clear of any obstruction to ensure proper cooling.
- Air outlet location should not be in front of the lens of other projector to avoid causing illusions.
- Keep the outlet at least 100cm away from the inlets of other projectors
- The projector generates a massive amount of heat during use. The internal fan dissipates the heat of the projector when shutting down, and such process may continue for a certain period. After the project enters STANDBY MODE status, press the AC power button to turn off the projector and remove the power cord. DO NOT remove the power cord during the shutdown process, as it may cause damage to the projector. In the meantime, the delayed heat radiating will also affect the service life of the projector. The shutdown process may vary depending on the model used. Whatever the case may be, be sure to disconnect the power cord till after the projector enters the STANDBY status.

Air inlet

- Make sure there is no object blocking air input within 30 cm.
- Keep the inlet away from other heat sources
- Avoided heavy dust area

Power Safety

- Only use the supplied power cord.
- Do not place anything on the power cord. Place the power cord where it will not be in the way of foot traffic.
- Remove the batteries from the remote control when storing or not in use for a prolonged period.

Cleaning the Projector

- Unplug the power cord before cleaning. See [Cleaning the Projector](#) page 66.
- Allow the light source to cool for about one hour.

Regulatory Warnings

Before installing and using the projector, read the regulatory notices in the [Regulatory Compliance](#) on page 81.

Symbol Explanations



DISPOSAL: Do not use household or municipal waste collection services for disposal of electrical and electronic equipment. EU countries require the use of separate recycling collection services.

Special Care for Laser Beams!

Special care should be considered when DLP projectors and high power laser equipment are used in the same room as.

Direct or indirect hit of a laser beam on to the projector lens can severely damage the Digital Mirror Devices (DMD™).

Sun light Warning

Avoid using in direct sun light.

Sun light on the projector lens can severely damage the Digital Mirror Devices (DMD™).

Main Features

- *Compatible with all major video standards including NTSC, PAL, and SECAM.*
- *A high brightness rating allows for presentations in daylight or in lit rooms.*
- *Flexible setup allows for front, rear projections.*
- *Line-of-vision projections remain square, with advanced keystone correction for angled projections.*
- *Input source automatically detected.*
- *High brightness for projection in just about any environment.*
- *Supports resolutions up to WUXGA for clear and crisp images.*
- *DLP® and BrilliantColor™ technologies from Texas Instruments.*
- *Centered lens for easy installation.*
- *Horizontal and vertical lens shift.*
- *Network ready for integration and system administration via RJ45.*
- *Sealed engine to minimizing the impact of dust and smoke.*
- *Anti-theft security features include: Kensington security slot, security bar.*
- *Built-in HDBaseT receiver. HDBaseT™ interface with support for distribution of HD video, digital audio content RS232, RJ45 and IR function over standard CAT5e/6 LAN cable*
- *Advanced laser phosphor light engine for superior brightness and color uniformity*
- *Laser design deliveries up to 20,000 hours of operational time*

About this Manual

This manual is intended for end users and describes how to install and operate the DLP projector. Wherever possible, relevant information—such as an illustration and its description—has been kept on one page. This printer-friendly format is both for your convenience and to help save paper, thereby protecting the environment. It is suggested that you only print sections that are relevant to your needs.

Table of Contents

GETTING STARTED.....1

- PACKING CHECKLIST1
- VIEWS OF PROJECTOR PARTS.....2
 - Front-right View2
 - Top view3
 - Side view—IO.....4
 - Side view—On-Screen Display (OSD) buttons6
 - Bottom view8
- REMOTE CONTROL PARTS10
 - Set Control ID Number12
- REMOTE CONTROL OPERATING RANGE13
- PROJECTOR AND REMOTE CONTROL BUTTONS.....13

SETUP AND OPERATION.....14

- INSERTING THE REMOTE CONTROL BATTERIES14
- INSTALLING OR REMOVING THE OPTIONAL LENS.....15
 - Installing the New Lens15
 - Removing the Existing Lens From the Projector.....16
- STARTING AND SHUTTING DOWN THE PROJECTOR17
- SETTING AN ACCESS PASSWORD (SECURITY LOCK).....19
- ADJUSTING THE PROJECTOR LEVEL21
- ADJUSTING PROJECTED IMAGE POSITION USING LENS SHIFT22
- ADJUSTING THE ZOOM, FOCUS AND KEYSTONE.....23

ON-SCREEN DISPLAY (OSD) MENU SETTINGS.....24

- OSD MENU CONTROLS24
 - Navigating the OSD.....24
- SETTING THE OSD LANGUAGE.....25
- OSD MENU OVERVIEW.....26
- IMAGE MENU30
 - Computer Menu.....31
 - Advanced Feature32
 - White Balance33
 - Color Manager.....34
 - Dynamic Black Settings.....35
 - HDR Settings.....36
- SETTINGS 1 MENU.....37
 - Alignment.....38
 - Audio.....42
 - Advanced 1 Feature43
 - Advanced 2 Feature45
- SETTINGS 2 MENU.....46
 - Light Setting.....47
 - Status.....48
 - Advanced 1 Feature49
 - Advanced 2 Feature62

MAINTENANCE AND SECURITY66

- CLEANING THE PROJECTOR66
 - Cleaning the Lens.....66
 - Cleaning the Case.....66
- USING THE PHYSICAL LOCK67
 - Using the Kensington Security Slot.....67
 - Using the Security Bar Lock.....67

TROUBLESHOOTING68

- COMMON PROBLEMS AND SOLUTIONS68
- TIPS FOR TROUBLESHOOTING68
- LED ERROR MESSAGES69

IMAGE PROBLEMS	70
LIGHT SOURCE PROBLEMS	70
REMOTE CONTROL PROBLEMS.....	70
AUDIO PROBLEMS	71
HAVING THE PROJECTOR SERVICED	71
HDMI Q & A	72
SPECIFICATIONS.....	73
SPECIFICATIONS.....	73
PROJECTION DISTANCE VS. PROJECTION SIZE	75
Projection Distance and Size Table	75
TIMING MODE TABLE	77
Table of Supported Frequency.....	77
Table of Supported Frequency For 3D mode.....	79
PROJECTOR DIMENSIONS	80
REGULATORY COMPLIANCE	81
FCC WARNING	81
CANADA.....	81
SAFETY CERTIFICATIONS	81
APPENDIX I	82
COMMUNICATION PARAMETER SETUP	82

GETTING STARTED

Packing Checklist

Carefully unpack the projector and check that the following items are included:

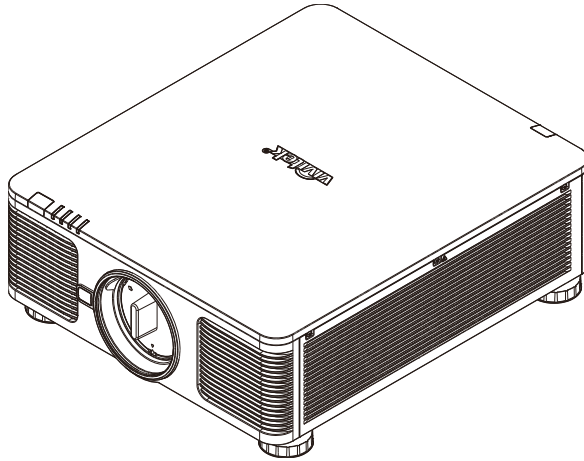

Projector



Remote Control
(Batteries Included)



Anti-theft Screw (M4)
(for Lens Installation)

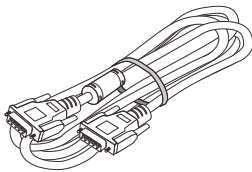

VGA Cable (1.8m)

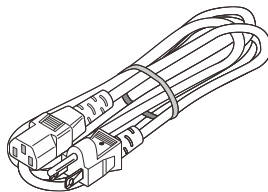

Power Cord (1.8m)

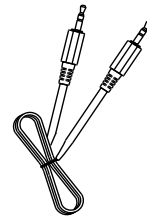

Wired Remote Cable



Safety Card



Warranty Card



Quick Start Guide

Contact your dealer immediately if any items are missing, appear damaged, or if the unit does not work. It is recommend that you keep the original packing material should you ever need to return the equipment for warranty service.



Caution:
Avoid using the projector in dusty environments.

Views of Projector Parts

Front-right View

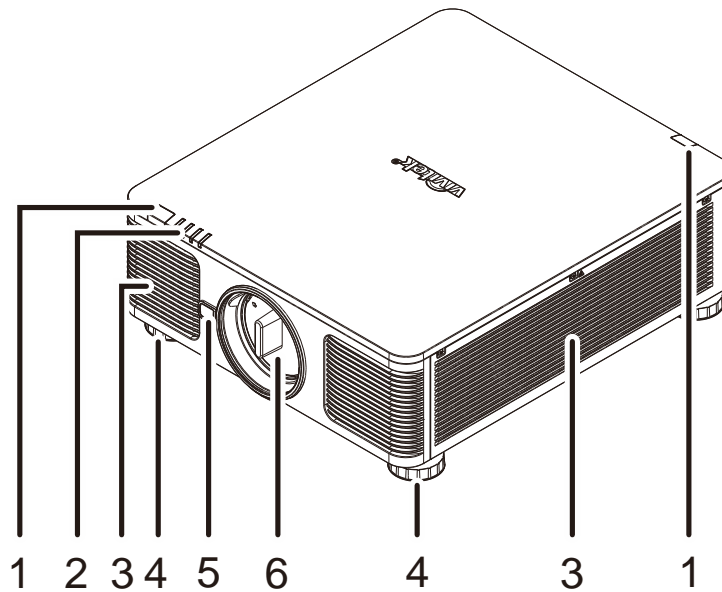

ITEM	LABEL	DESCRIPTION	SEE PAGE:
1.	IR Receiver	Receives IR signal from remote control.	9
2.	LEDs	Displays the projector status.	3
3.	Vent	Cool air intake.	
4.	Tilt Adjuster	Rotate adjuster lever to adjust angle position.	21
5.	Lens Release Button	For release Lens.	16
6.	Anti-dust cap	Anti-dust cap	



Important:

Ventilation openings on the projector allow for good air circulation, which keeps the projector light source cool. Do not obstruct any of the ventilation openings.

Top view

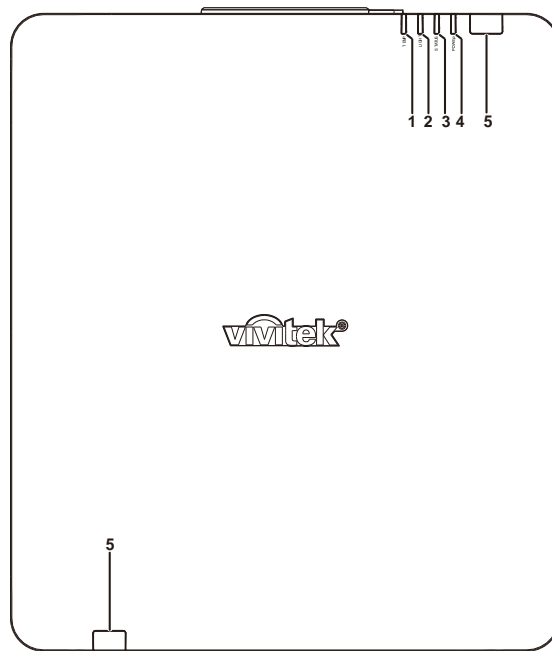

ITEM	LABEL	DESCRIPTION	SEE PAGE:
1.	TEMP LED	Display the thermal status.	69
2.	LIGHT LED	Display the light source status.	69
3.	STATUS LED	Display the warning message.	69
4.	POWER LED	Display the power on/off sequence status.	69
5.	IR Receiver	Receives IR signal from remote control.	9

Side view—IO

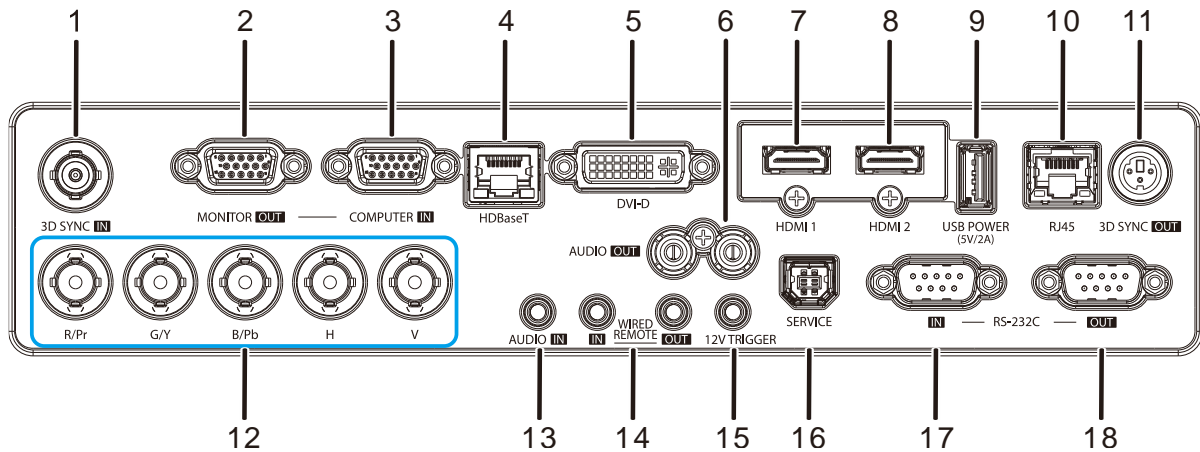

ITEM	LABEL	DESCRIPTION	SEE PAGE:
1.	3D-SYNC IN	Connect 3D-sync in cable from a computer or an enabled device.	
2.	MONITOR OUT	Connect an RGB cable to a display.	
3.	COMPUTER IN	Connect an RGB cable from a computer or a video enabled device.	
4.	HDBaseT	Connect Cat5e/Cat6 cable from HDBaseT TX Box (VIDEO EXTENDER) for HDBaseT signal received. Note: HDBaseT cable suggest use cat6 type cable.	
5.	DVI-D	Connect the DVI CABLE to display.	
6.	AUDIO OUT L/R	Connect an AUDIO cable for audio loop through.	
7.	HDMI 1	Connect the HDMI cable from an HDMI device.	
8.	HDMI 2	Connect the HDMI cable from an HDMI device.	
9.	USB POWER (5V/2A)	Connect a USB cable for USB host. Note: Support 5V/2A output as long as the projector Power On.	
10.	RJ45	Connect a LAN cable from Ethernet.	
11.	3D-SYNC OUT	Connect 3D IR glasses receiver unit.	
12.	BNC	Connect a BNC cable from a computer.	
13.	AUDIO IN	Connect an AUDIO cable from the audio device.	
14.	WIRE REMOTE IN / OUT	Connect the wire remote from remote control to the projector for wire remote control. Connect "WIRE REMOTE OUT" to another projector (same model) "WIRE REMOTE IN" for serial control.	
15.	12V TRIGGER	When connected to the screen through a commercially available cable, the screen deploys automatically on start up of the projector. The screen retracts when the projector is powered off (see notes below).	
16.	SERVICE	For service personnel only.	
17.	RS-232C IN	Connects RS-232 serial port cable for remote control.	
18.	RS-232C OUT	Connects to another projector (same model) for RS-232 control.	

Note:

- *To use this feature, you must plug in the connector before turn on/off the projector.*
- *Screen controllers are supplied and supported by screen manufacturers.*
- *Do not use this jack for anything other than intended use.*



Warning:

As a safety precaution, disconnect all power to the projector and connecting devices before making connections.

Side view—On-Screen Display (OSD) buttons

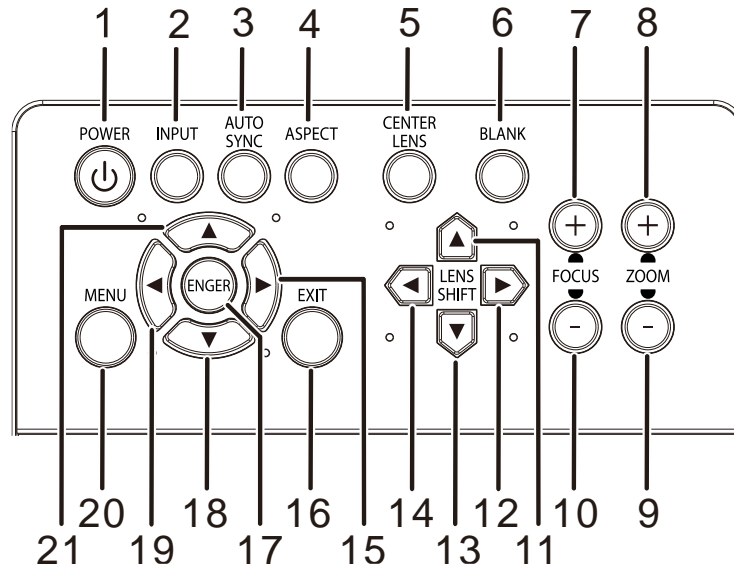

ITEM	LABEL	DESCRIPTION	SEE PAGE:
1.	POWER	Turn the projector on or off.	17
2.	INPUT	Enter the Source menu.	
3.	AUTO SYNC	Auto adjustment for frequency, phase, and position.	
4.	ASPECT	Displays the ASPECT RATIO selections.	
5.	CENTER LENS	To center the lens and calibrate the parameter of lens shift. Note: The lens position needs to be calibrated for the accurate lens shift operation after installing the lens. Please center the lens every time after the lens is mounted.	
6.	BLANK	Makes the screen blank	24
7.	FOCUS+	Focuses the projected image	24
8.	ZOOM+	Zoom in the projected image.	24
9.	ZOOM-	Zoom out the projected image.	24
10.	FOCUS-	Focuses the projected image	24
11.	LENS SHIFT ▲	Adjusts the image position vertically.	
12.	LENS SHIFT ►	Adjusts the image position horizontally.	
13.	LENS SHIFT ▼	Adjusts the image position vertically.	
14.	LENS SHIFT ◀	Adjusts the image position horizontally.	
15.	►	Navigates and changes settings in the OSD. Quick Menu – For Horizontal Keystone.	24
16.	EXIT	Return to previous OSD menu or exit the OSD menu.	24
17.	ENTER	Enter or confirm highlighted OSD menu item.	24
18.	▼	Navigates and changes settings in the OSD. Quick Menu – For Vertical Keystone.	24

ITEM	LABEL	DESCRIPTION	SEE PAGE:
19.	◀	Navigates and changes settings in the OSD. Quick Menu – For Horizontal Keystone.	24
20.	MENU	Opens and exits OSD menus.	24
21.	▲	Navigates and changes settings in the OSD. Quick Menu – For Vertical Keystone.	24

Bottom view

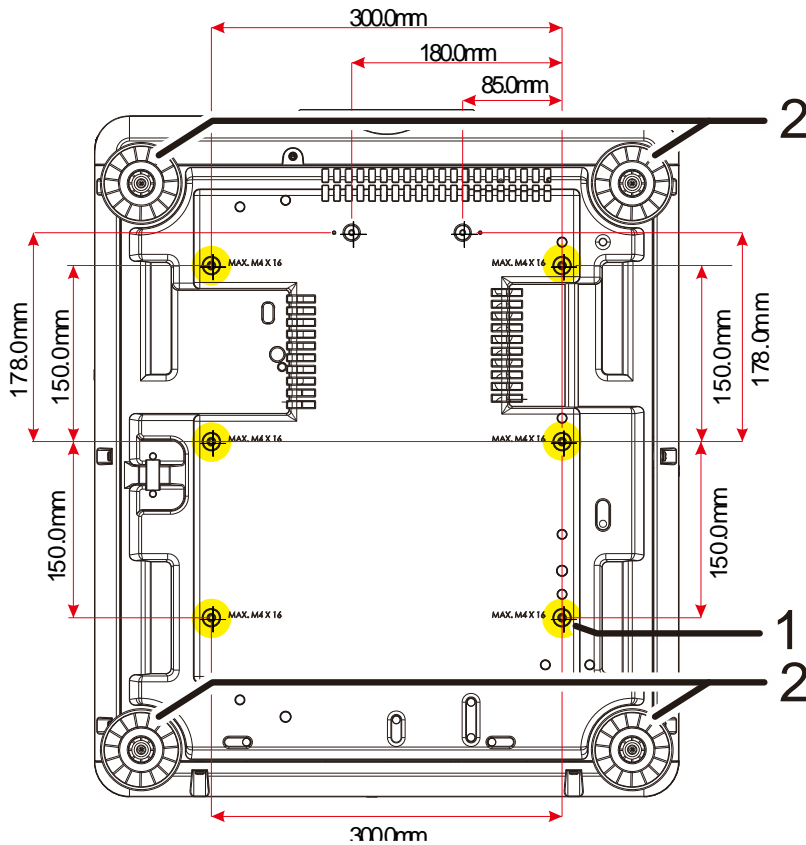

ITEM	LABEL	DESCRIPTION	SEE PAGE:
1.	Ceiling Mount Holes	Contact your dealer for information on mounting the projector on a ceiling.	
2.	Tilt Adjustor	Rotate adjuster lever to adjust angle position.	21

Note:

When installing, ensure that you use only UL Listed ceiling mounts.

For ceiling installations, use approved mounting hardware and M4 screws with a maximum screw depth of 16mm (0.63 inch).

The construction of the ceiling mount must be of a suitable shape and strength. The ceiling mount load capacity must exceed the weight of the installed equipment, and as an additional precaution be capable of withstanding three times the weight of the equipment over a period of 60 seconds.

Reference drawings for stand

Please hire an installation service provider (for a fee) for the design and manufacture of a customized stand to be used for portrait projection. Please ensure that the design complies with the following conditions:

- Use the 6 screw holes at the back of the projector to secure it to the stand.
Screw hole center dimension: 300 × 300 (pitch = 150) mm
Screw hole dimension on the projector: M4 with the maximum depth 16 mm
- Horizontal adjustment mechanism (for example, bolts and nuts in 4 places)
- Please design the stand so that it does not easily topple over.

The drawing showing the dimensional requirements is not an actual stand design drawing.

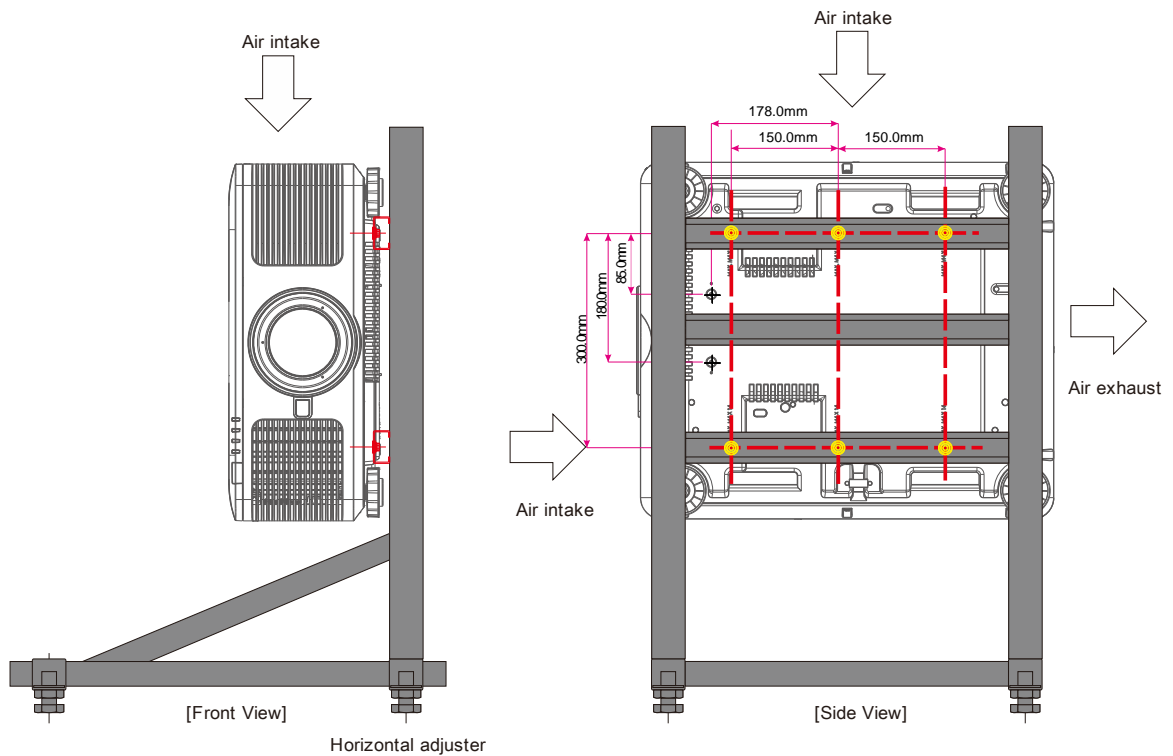

Remote Control Parts

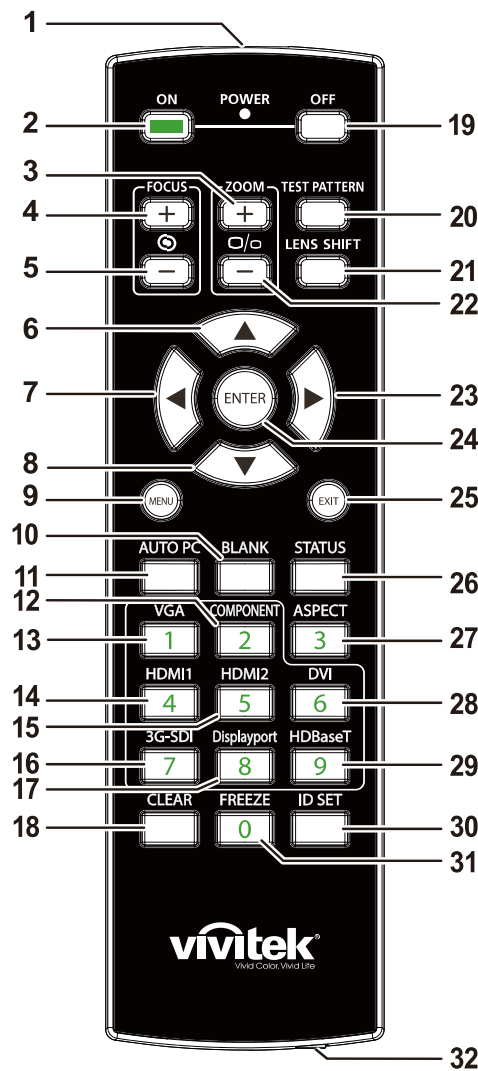

Important:

1. Avoid using the projector with bright fluorescent lighting turned on. Certain high-frequency fluorescent lights can disrupt remote control operation.
2. Be sure nothing obstructs the path between the remote control and the projector. If the path between the remote control and the projector is obstructed, you can bounce the signal off certain reflective surfaces such as projector screens.
3. The buttons and keys on the projector have the same functions as the corresponding buttons on the remote control. This user's manual describes the functions based on the remote control.

ITEM	LABEL	DESCRIPTION	SEE PAGE:
1.	IR Transmitter	Transmits signals to projector.	
2.	ON	Turns the projector on.	17
3.	ZOOM +	Zoom in the projected image.	
4.	FOCUS +	Adjust the focus of the projected image.	
5.	FOCUS -	Adjust the focus of the projected image.	
6.	▲	Navigates and changes settings in the OSD. Quick Menu – For Vertical Keystone.	24
7.	◀	Navigates and changes settings in the OSD. Quick Menu – For Horizontal Keystone.	24
8.	▼	Navigates and changes settings in the OSD. Quick Menu – For Vertical Keystone.	24
9.	MENU	Opens the OSD.	24
10.	BLANK	Makes the screen blank.	
11.	AUTO PC	To execute signal source auto synchronization	24
12.	COMPONENT	Select Component as the input source.	
13.	VGA	Select VGA as the input source.	
14.	HDMI1	Select HDMI 1 as the input source.	
15.	HDMI2	Select HDMI 2 as the input source.	
16.	3G-SDI	Select 3G-SD as the input source.	
17.	DisplayPort	Select DisplayPort as the input source.	
18.	CLEAR	Erase the set ID number of the remote control.	
19.	OFF	Turns the projector off.	17
20.	TEST PATTERN	Use the button to show the test pattern. Press this button again to switch to the next pattern. Press the EXIT button to return to the projected image.	
21.	LENS SHIFT	Use the button to move the lens right or left.	
22.	ZOOM -	Zoom out the projected image.	23
23.	▶	Navigates and changes settings in the OSD. Quick Menu – For Horizontal Keystone.	24
24.	ENTER	Enters and confirms settings in the OSD.	24
25.	EXIT	Return to last OSD page.	
26.	STATUS	Opens the OSD Status menu (the menu only opens when an input device is detected).	
27.	ASPECT	To display aspect ratio options.	
28.	DVI	Select DVI-D as the input source.	
29.	HDBaseT	Select HDBaseT as the input source.	
30.	ID SET	Set up ID number for remote control.	
31.	Freeze	Freezes/unfreezes the on-screen picture.	
32.	Wired Jack	Connect wire remote to the projector.	

Set Control ID Number

Select Control ID Number option then press Enter button, use the ► button to increase the number or the ◀ button to decrease the number. This option is available when Projector ID Control is turned on.

Set the identification number of remote control

Press and hold ID SET button on the remote control around 5 seconds, Power LED indicator is flashing red periodically. Press two digits to set desired ID number, each pressing shall be leisurely. Power LED will flash on time when the remote control is confirmed the setting.

Press and Hold ID SET button around 5 seconds



Power LED is flashing

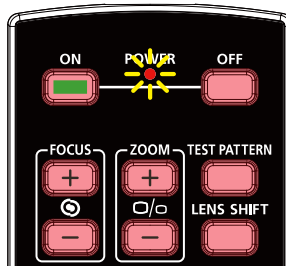

Press two digits for ID number

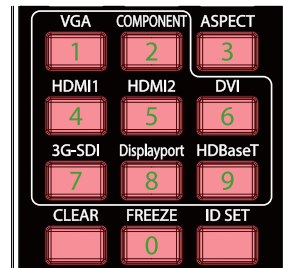

Note:

Setting the identification number will overwrite the ID number you had set. You can set the ID number directly if you would like to give a new ID number for the remote control.

Erase the identification number of the remote control

The set ID number is overwritten if new ID number is set, you can press ID SET and CLEAR button to erase ID number of the remote control.

Press ID SET and CLEAR buttons simultaneously

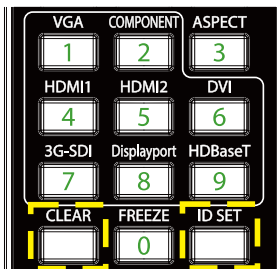

The backlight of the buttons is flashing one time



Remote Control Operating Range

The remote control uses infrared transmission to control the projector. It is not necessary to point the remote directly at the projector. Provided you are not holding the remote perpendicular to the sides or the rear of the projector, the remote will function well within a radius of about 10 meters (25 feet) and 15 degrees above or below the projector level. If the projector does not respond to the remote control, move a little closer.

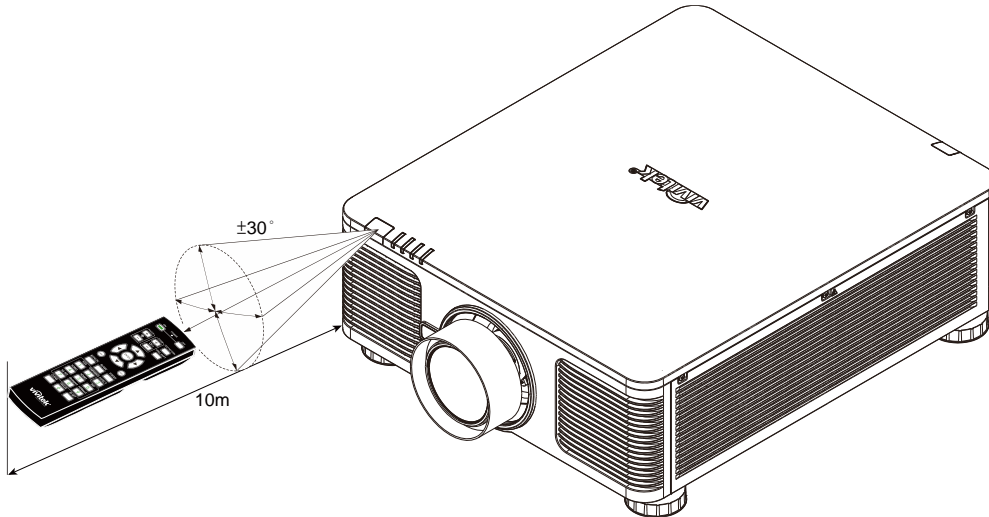

Projector and Remote Control Buttons

The projector can be operated using the remote control or the buttons on the top of the projector. All operations can be carried out with the remote control; however, the buttons on the projector are limited in use.

Inserting the Remote Control Batteries

1. Remove the battery compartment cover by sliding the cover in the direction of the arrow.

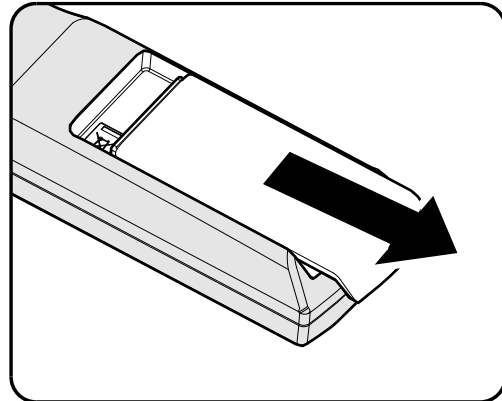

2. Insert the battery with the positive side facing up.

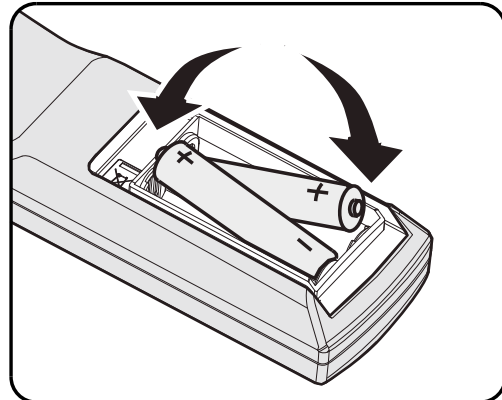

3. Replace the cover.

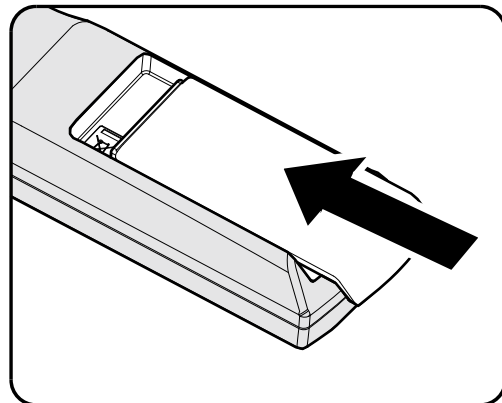

Caution:

1. Only use AA batteries (Alkaline batteries are recommended).
2. Dispose of used batteries according to local ordinance regulations.
3. Remove the batteries when not using the projector for prolonged periods.

Installing or Removing the Optional Lens



Caution:

- Do not shake or place excessive pressure on the projector or the lens components as the projector and lens components contain precision parts.
- Before removing or installing the lens, be sure to turn off the projector, wait until the cooling fans stop, and turn off the main power switch.
- Do not touch the lens surface when removing or installing the lens.
- Keep fingerprints, dust or oil off the lens surface.
- Do not scratch the lens surface.
- Work on a level surface with a soft cloth under it to avoid scratching.
- If you remove and store the lens, attach the lens cap to the projector to keep off dust and dirt.

Installing the New Lens

1. If the Lens cover is installed, pull the edge of the lens cover with one hand (①), so that the lens cover can be removed easily with the other hand (②).

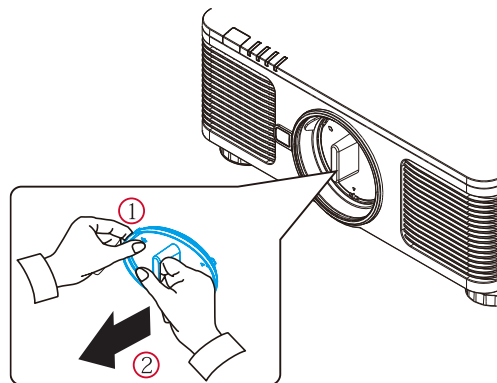

2. Align the flange and correctly position as shown in the picture.

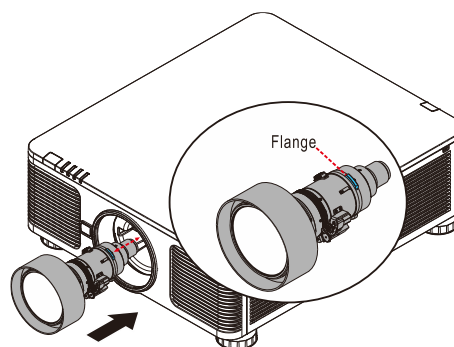

3. Rotate the lens clockwise until you feel it click into place.

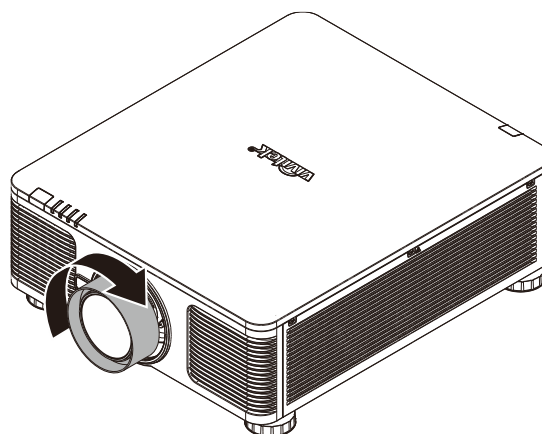

Removing the Existing Lens From the Projector

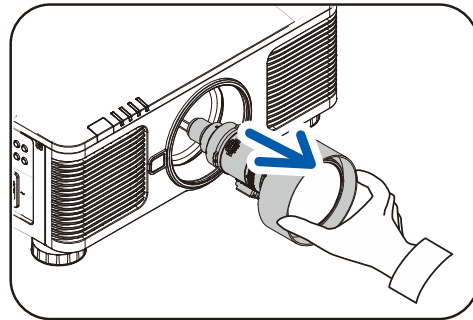
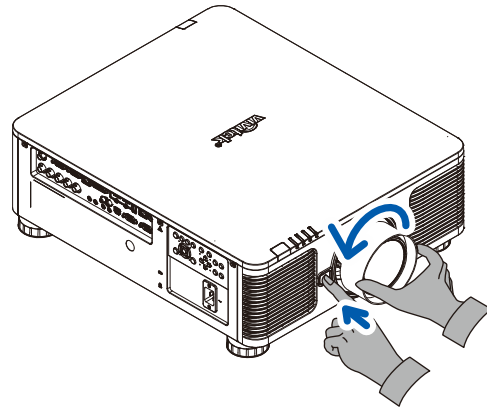

- 1.** Push the LENS RELEASE button to the unlock position.
- 2.** Grasp the lens.
- 3.** Rotate the lens counterclockwise. The existing lens will be disengaged.
- 4.** Pull out the existing lens slowly.

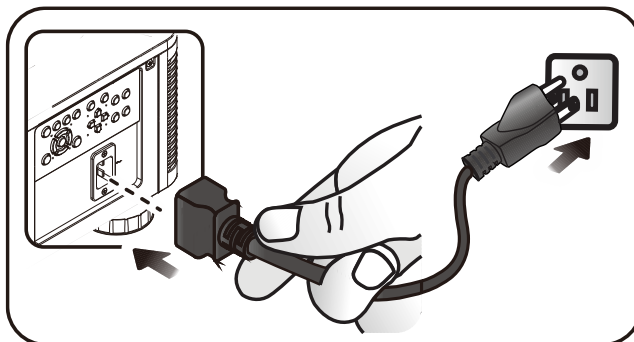

Starting and Shutting down the Projector

1. Securely connect the power cord and signal cable. When connected, the power led will flash green to solid green.



2. Turn on the light source by pressing “” button on the projector or “” on the remote control.

The PWR LED will now flash green. The startup screen will display in approximately 30 seconds. The first time you use the projector, you can select your preferred language from quick menu after the startup screen display. (See [Setting the OSD Language](#) on page 25)

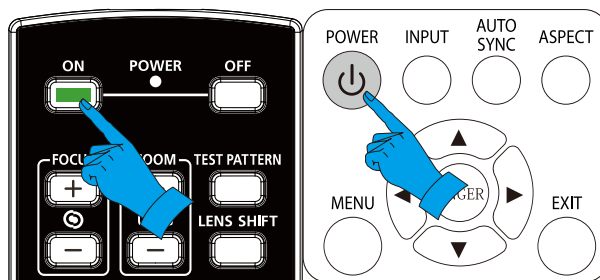

See [Setting an Access Password \(Security Lock\)](#) on page 19 if security lock is enabled.



3. If more than one input device is connected, press the **SOURCE** button and use ▲▼ to scroll among devices.

(Component is supported through the RGB to Component adapter.)

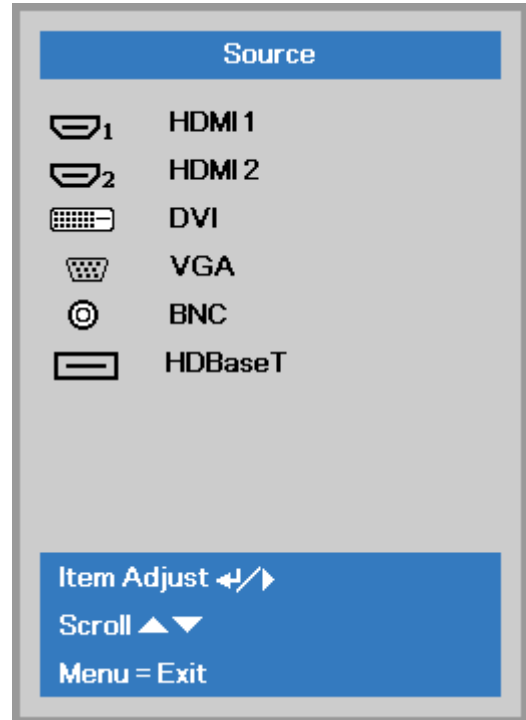

- HDMI 1: High-Definition Multimedia Interface compatible
- HDMI 2: High-Definition Multimedia Interface
- DVI: DVI
- VGA: Analog RGB
DVD input YCbCr/ YPbPr, or HDTV input YPbPr via D-sub connector
- BNC: Analog RGB
- HDBaseT: Digital Video through the HDBaseT transmitter

Note:

It is recommended to use a certified TX box (VIDEO EXTENDER) – Rextron (EVBMN-110L38) for the HDBaseT function and there is no guarantee of full response when other brands of TX box are used.. Using a single HDBaseT CAT5e/6 cable, the projector supports an HDBaseT connection distances to 100m/328ft.

4. When the “Power Off? /Press **Power** again” message appears, press the **POWER** button. The projector turns off.

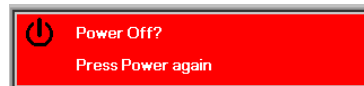

Caution:

Do not unplug the power cord until the **POWER LED** stops flashing – indicating the projector has cooled down.

Setting an Access Password (Security Lock)

You can use the four (arrow) buttons to set a password and prevent unauthorized use of the projector. When enabled, the password must be entered after you power on the projector. (See *Navigating the OSD* on page 24 and *Setting the OSD Language* on page 25 for help on using OSD menus.)



Important:

Keep the password in a safe place. Without the password, you will not be able to use the projector. If you lose the password, contact your reseller for information on clearing the password.

1. Press the **MENU** button to open the OSD menu.

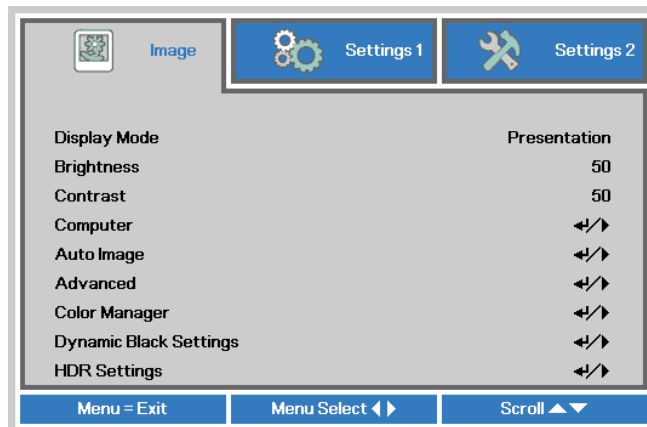

2. Press the cursor **◀▶** button to move to the **Settings 1** menu, press the cursor **▲▼** button to select **Advanced 1**.

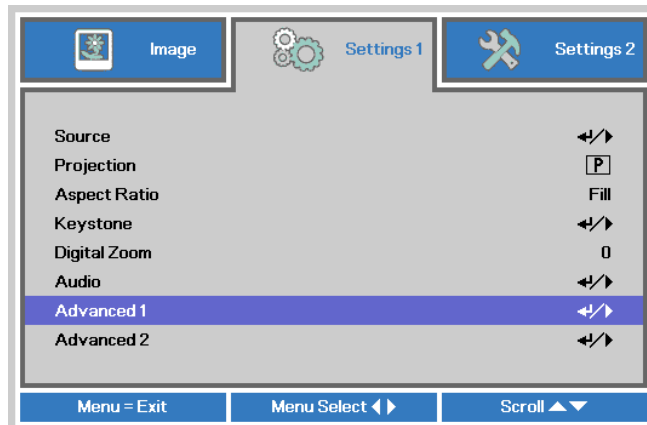

3. Press **↵** (Enter) / **▶** to enter the **Advanced 1** sub menu. Press the cursor **▲▼** button to select **Security Lock**.

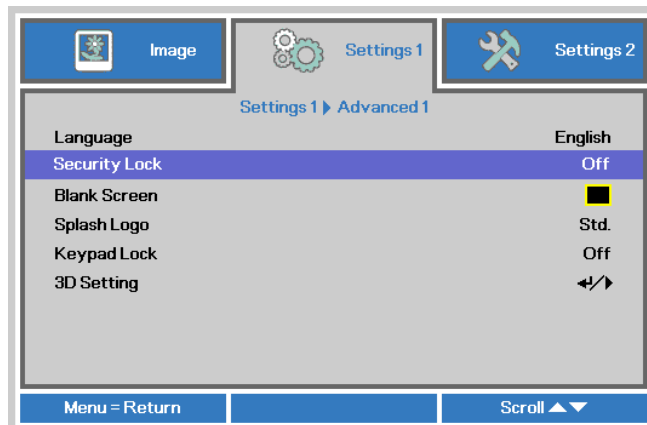

4. Press the cursor **◀▶** button to enter and enable or disable security lock function.

A password dialog box automatically appears.

5. You can use the cursor buttons ▲▼◀▶ either on keypad or IR remote control for password entry. You can use any combination including the same arrow five times, but not less than five.

Press the cursor buttons in any order to set the password. Push the **MENU** button to exit the dialog box.

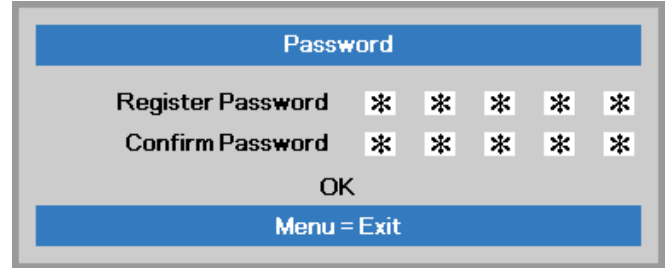
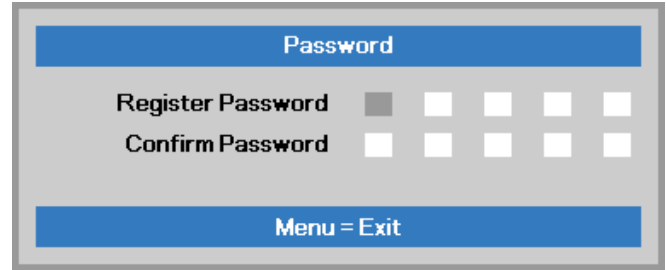

6. The password confirm menu appears when user presses the power-on key in case the **Security Lock** is enabled. Enter the password in the order you set it at step 5. In case you forget the password, please contact the service center. The service center will validate the owner and help reset the password.

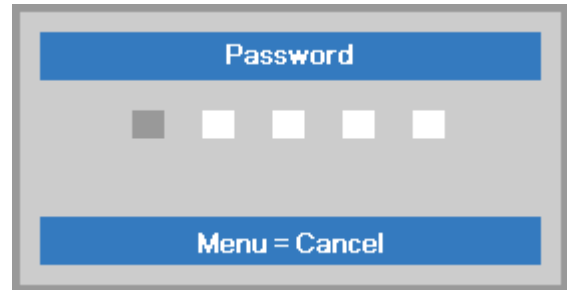

Adjusting the Projector Level

Take note of the following when setting up the projector:

- *The projector table or stand should be level and sturdy.*
- *Position the projector so that it is perpendicular to the screen.*
- *Ensure the cables are in a safe location. You could trip over them.*

1. To raise the level of the projector, twist the adjusters counter clockwise.

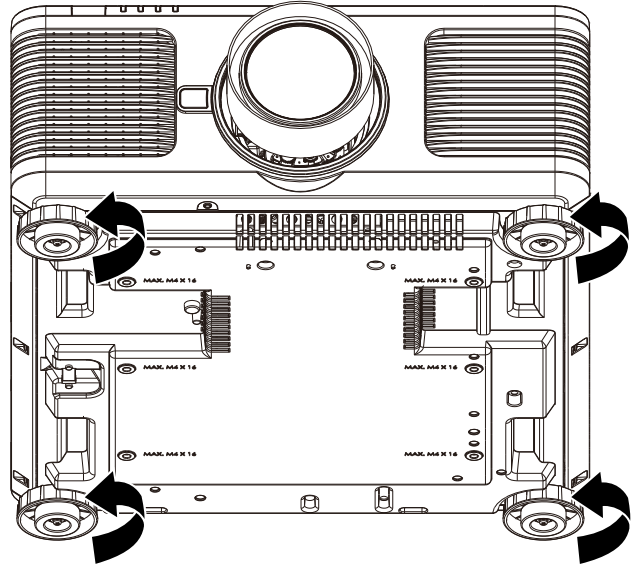

2. To lower the level of the projector, lift the projector and twist the adjusters clockwise.

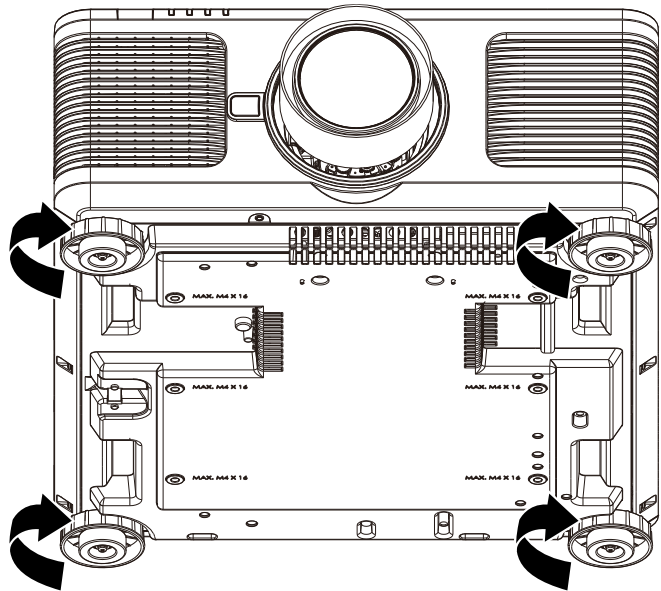

Adjusting Projected Image Position Using Lens Shift

The DU6098Z/DU6198Z/DU6298Z projector has the powered lens shift feature; the image can be shifted vertically or horizontally without moving the projector. The lens shift range is shown in the percentage of the image height and width, the maximum vertical shift range can be up to 55% of the image height and down to 15% of the image height, and maximum horizontal shift range is 5% of the image width to right and left. Please refer to below illustration.

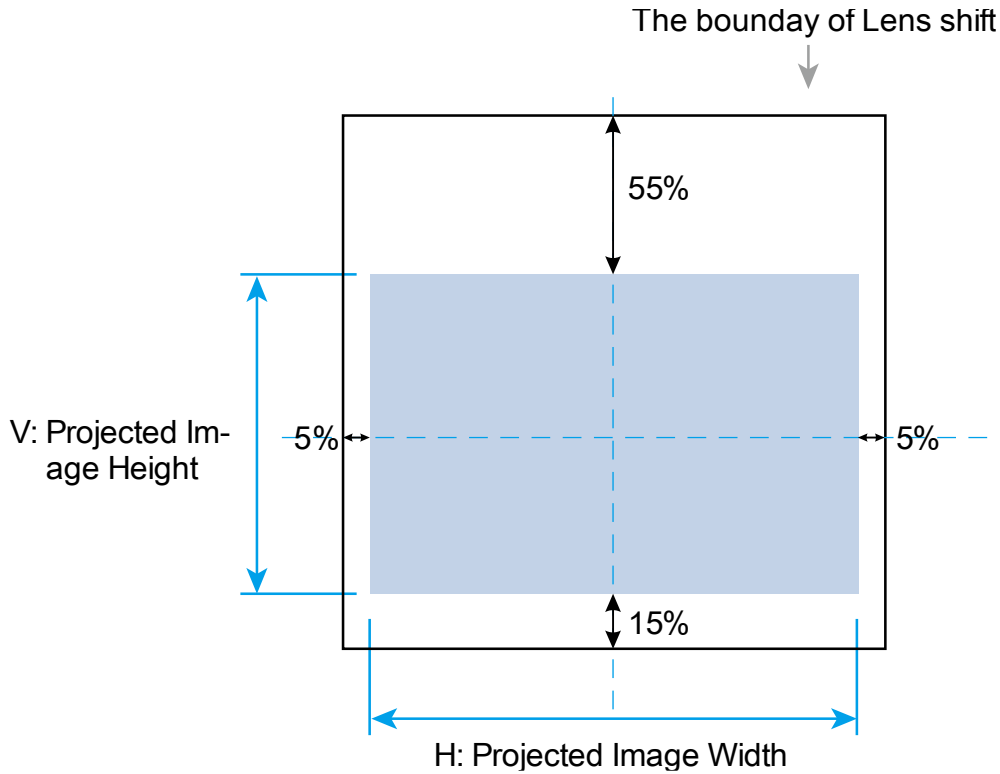

Note:

The projector is equipped with a safety switch inside the lens mount hole. The projection lens must be installed in the projector before turning on the power or the projection can't be started.

There is a Lens Lock function on OSD menu to disable lens control adjustment for avoiding possible misoperation after you finish the adjustment. Please make sure to disable the lock before performing the lens control.

Adjusting the Zoom, Focus and Keystone

1. The focus and zoom can be adjusted from the projector control panel or remote control. Refer to the following guides to adjust the focus and zoom manually.

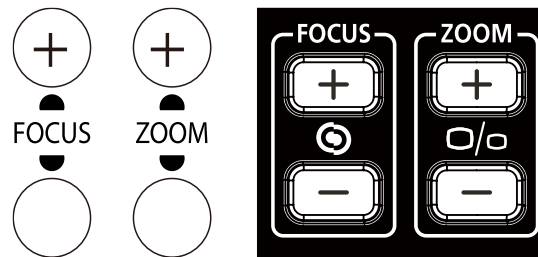

2. Press the Focus or Zoom button on the control key panel or remote control to adjust the focus or zoom effect using the increase and decrease buttons as required

3. Press the ▲/▼/◀/▶ buttons (on the projector or the remote control) to correct vertical or horizontal image-trapezoid.

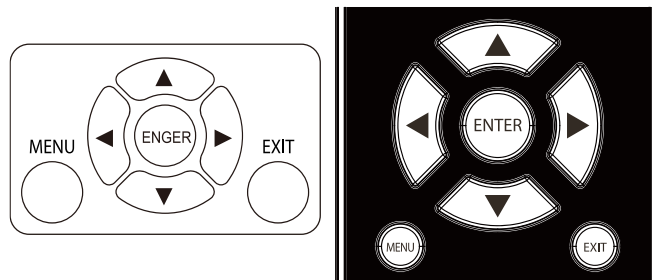

4. The keystone control appears on the display.
 Press ▲/▼ for V Keystone correcting image.
 Press ◀/▶ for H Keystone correcting image.

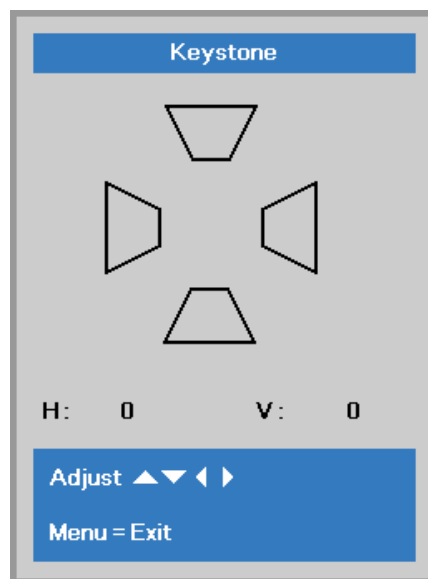

ON-SCREEN DISPLAY (OSD) MENU SETTINGS

OSD Menu Controls

The projector has an OSD that lets you make image adjustments and change various settings.

Navigating the OSD

You can use the remote control cursor buttons or the buttons on the projector to navigate and make changes to the OSD. The following illustration shows the corresponding buttons on the projector.

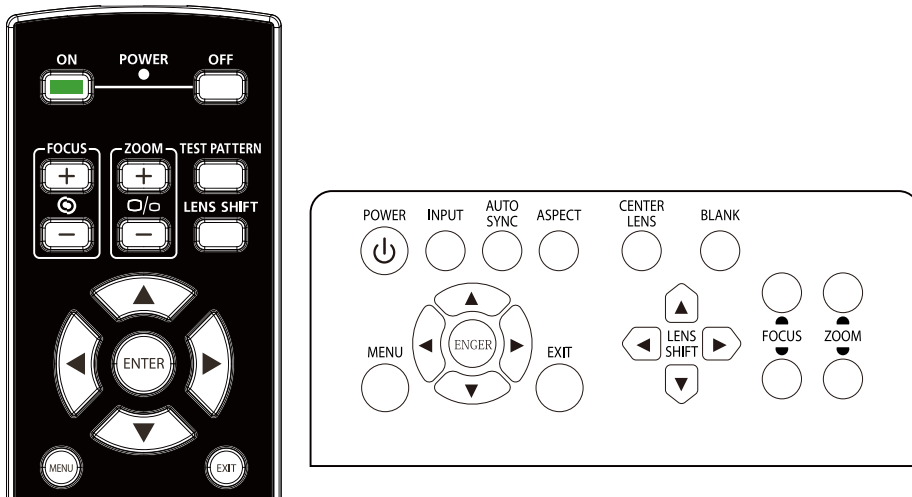

1. To enter the OSD, press the **MENU** button.
2. There are three menus. Press the cursor ◀ / ▶ buttons to move through the menus.
3. Press the cursor ▲ / ▼ buttons to move up and down in a menu.
4. Press the cursor ◀ / ▶ buttons to change values for settings.
5. Press the **MENU** button to close the OSD or leave a submenu. Press the **EXIT** button to return to the previous menu.

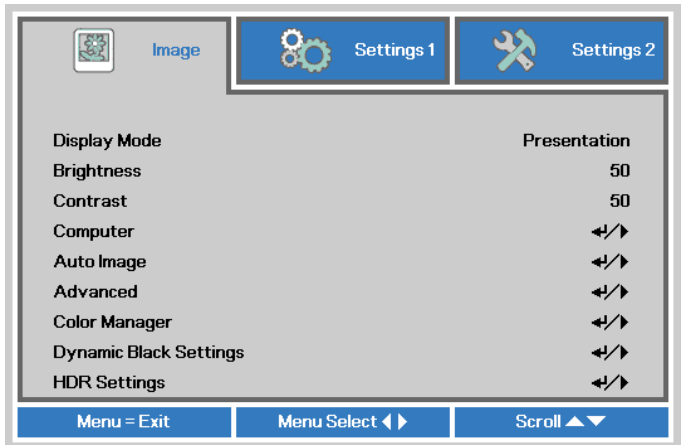

Note:
 Depending on the video source, not all items in the OSD are available. For example, the **Horizontal/Vertical Position** items in the **Computer** menu can only be modified when connected to a PC. Items that are not available cannot be accessed and are grayed out.

Setting the OSD Language

Set the OSD language to your preference before continuing.

1. Press the **MENU** button. Press the cursor ◀▶ button to navigate to **Settings 1**. Press the cursor ▲▼ button to move to the **Advanced 1** menu.

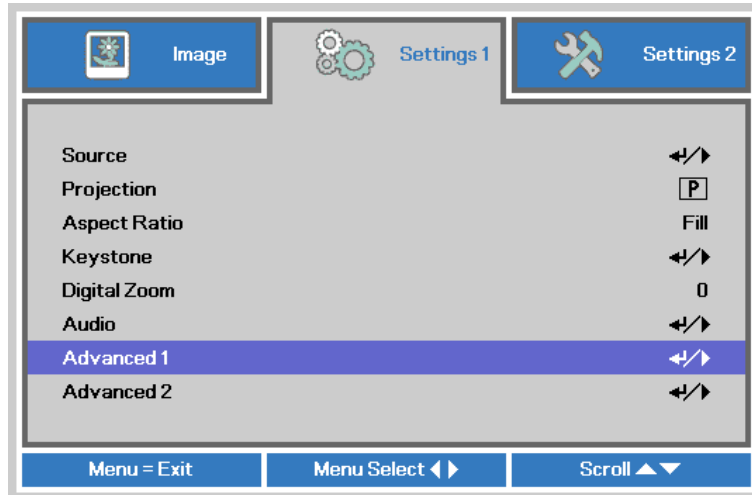

2. Press ◀ (Enter) / ▶ to enter the **Advanced 1** sub menu. Press the cursor ▲▼ button until **Language** is highlighted.

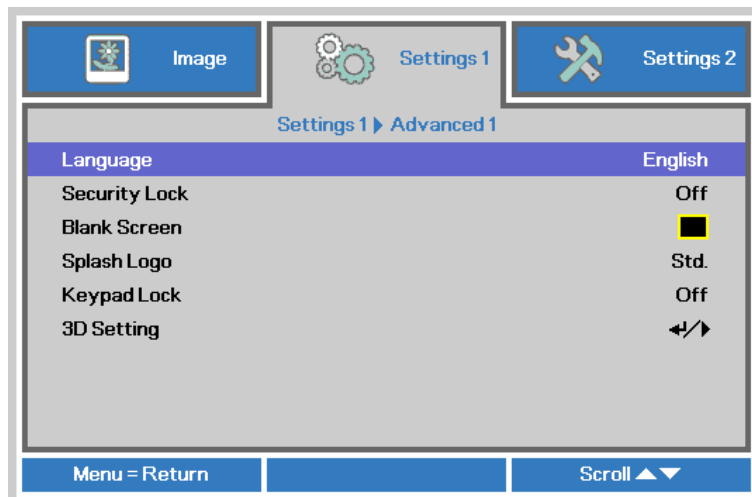

3. Press the cursor button until the language you want is highlighted.
4. Press the MENU button four times to close the OSD.

OSD Menu Overview

Use the following illustration to quickly find a setting or determine the range for a setting.

Main Menu	Sub Menu	Settings		
Image	Display Mode	Presentation, Bright, Game, Movie, Vivid, Blending, sRGB, DICOM SIM, User, User2		
	Brightness	0~100		
	Contrast	0~100		
	Computer	Horizontal Position	-5~5 (depend on Auto Sync)	
		Vertical Position	-5~5 (depend on Auto Sync)	
		Frequency	0~31	
		Tracking	-5~5	
		Auto Sync	On, Off	
	Auto Image			
	Advanced	Brilliant Color	0~10	
		Sharpness	0~31	
		Gamma	1.8, 2.0, 2.2, 2.4, B&W, Linear	
		Color Temperature	Warm, Normal, Cold	
		Video Saturation	0~100	
		Video Tint	0~100	
		White Balance	R Gain	0~200
			G Gain	0~200
			B Gain	0~200
			R Offset	-100~100
			G Offset	-100~100
	Color Manager	Red	Hue, Saturation, Gain 0~100	
		Green	Hue, Saturation, Gain 0~100	
		Blue	Hue, Saturation, Gain 0~100	
		Cyan	Hue, Saturation, Gain 0~100	
		Magenta	Hue, Saturation, Gain 0~100	
		Yellow	Hue, Saturation, Gain 0~100	
	Dynamic Black Settings	White	Red, Green, Blue 0~100	
Dynamic Black		Off, On		
HDR Settings	Light Off Timer	Disable, 0.5 Sec, 1 Sec, 2 Sec, 3 Sec, 4 Sec		
	HDR Control	Off, Auto, On		
	HDR Mode	PQ-L300, PQ-L400, PQ-L500, PQ-L600		

Main Menu	Sub Menu	Settings		
Settings 1	Source	Source reference Input Source Select (IR/Keypad)		
	Projection	Normal, Real, Ceiling, Real+Ceiling		
	Aspect Ratio	Fill, 4:3, 16:9, Letter Box, Native, 2.35:1		
	Alignment	Lens Lock	Off / On	
		Lens Control	Zoom, Focus, Shift control	
		Lens Type	non-UST, UST	
		Lens Memory	Memory1	Save, Load, Clear
			Memory2	Save, Load, Clear
			Memory3	Save, Load, Clear
			Memory4	Save, Load, Clear
			Memory5	Save, Load, Clear
			Memory6	Save, Load, Clear
			Memory7	Save, Load, Clear
			Memory8	Save, Load, Clear
		Center Lens		
		Keystone	H: -30 ~ +30 V: -30 ~ +30	
		4 Corner	Left-Top, Right-Top, Right-Bottom, Left-Bottom	
	Digital Zoom	-10~10		
	Audio	Volume	0~10	
		Mute	Off, On	
	Advanced 1	Language	English, Français, Deutsch, Español, Português, 简体中文, 繁體中文, Italiano, Norsk, Svenska, Nederlands, Русский, Polski, Suomi, Ελληνικά, 한국어, Magyar, Čeština, العربية, Türkçe, Việt, 日本語, ไทย, فارسی, עברית, Dansk, Fran. Can.	
		Security Lock	Off, On	
		Blank Screen	Blank, Red, Green, Blue, White	
		Splash Logo	Std., Black, Blue	
		Keypad Lock	Off, On	
		3D Setting	3D	Off, DLP-Link, IR
			3D Sync Invert	Off, On
3D Format			Frame Packing, Top/Bottom, Side-By-Side, Frame Sequential, Auto (3D Frame Packing HDMI source only)	
3D Sync Out delay			0~359	
3D Sync Input			Internal, External	
3D Sync Output			Internal, By pass	

Main Menu	Sub Menu	Settings
Settings 1	Advanced 2	Test Pattern None, RGB Ramps, Color Bars, Step Bars, CheckBoard, Grid, Horizontal lines, Vertical Lines, Diagonal Lines, Horizontal Ramp, Vertical Ramp, White, Red, Green, Blue, Black
		H Image Shift -50~50
		V Image Shift -50~50
Settings 2	Auto Source Off, On	
	No Signal Power Off 0~180	
	Auto Power On Off, On	
	Light Setting	Light Mode Normal, Eco, Eco Plus, Dimming, Extreme Dimming, Custom Light
		Custom Light 50~200
		Constant Brightness Off, On
	Reset All	
	Status	Model
		Active Source
		Video Information
		Light Hours
		Software Version
		Remote ID
		Serial Number
		Air Filter Hour Only show when "Air Filter" On
		Menu Position Center, Down, Up, Left, Right
		Translucent Menu 0%, 25%, 50%, 75%, 100%
	Advanced 1	Low Power Mode On, On By Lan, On By HDBaseT(*)
		Fan Speed Normal, High
		Light Info Normal, Eco, Eco Plus, Dimming, Extreme Dimming, Custom Light
Remote ID 0~99		
Network		Network State Connect, Disconnect
		DHCP On, Off
		IP Address 0~255, 0~255, 0~255. 0~255
		Subnet Mask 0~255, 0~255, 0~255. 0~255
		Gateway 0~255, 0~255, 0~255. 0~255
		DNS 0~255, 0~255, 0~255. 0~255
	Apply Ok / Cancel	
HDBaseT-IR/RS232	HDBaseT-IR/RS232 Off, On	
	Front IR On, Off	
	Rear IR On, Off	

Main Menu	Sub Menu	Settings		
Settings 2	Advanced 2	Sleep Timer	0~600	
		Source Filter	HDMI1	Disable, Enable
			HDMI2	Disable, Enable
			DVI	Disable, Enable
			VGA	Disable, Enable
			BNC	Disable, Enable
			HDBaseT	Disable, Enable
			Air Filter Timer	Air Filter Timer
		Air Filter Timer Reset		
		Color Space	Auto, RGB, YUV	
		Quantization Range	Auto, Full, Limited	
		HDMI EDID	Enhanced, Standard	
		Environment Status	T1~T5, Fan1~Fan13, Color Sensor Current, Color Sensor Target	

(*) If HDBaseT control set to On, Low power mode will set to "On by HDBaseT", and disable this function to select.

Image Menu



Attention !

All of display mode parameters when changed will be saved to user mode.

Press the **MENU** button to open the **OSD** menu. Press the cursor ◀▶ button to move to the **Image Menu**. Press the cursor ▲▼ button to move up and down in the **Image** menu. Press ◀▶ to enter and change values for settings.

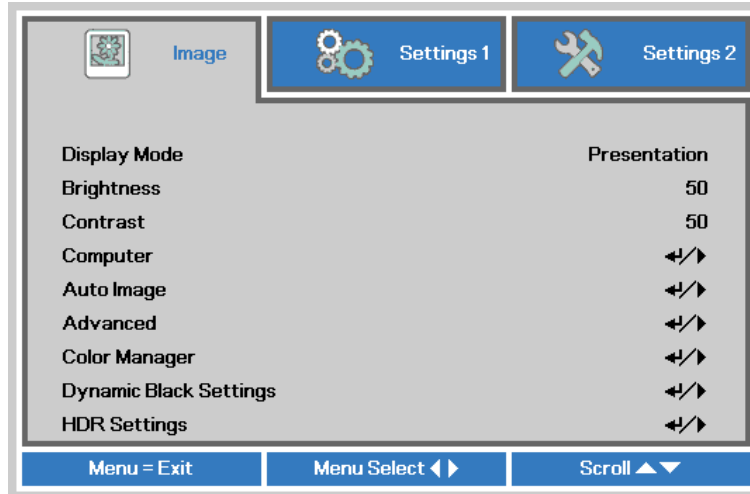

ITEM	DESCRIPTION
Display Mode	Press the cursor ◀▶ button to enter and set the Display Mode.
Brightness	Press the cursor ◀▶ button to enter and adjust the display brightness.
Contrast	Press the cursor ◀▶ button to enter and adjust the display contrast.
Computer	Press ◀ (Enter) / ▶ to enter the Computer menu. See Computer Menu on page 31.
Auto Image	Press ◀ (Enter) / ▶ to automatically adjustment for phase, tracking, size and position.
Advanced	Press ◀ (Enter) / ▶ to enter the Advanced menu. See Advanced Feature on page 32.
Color Manager	Press ◀ (Enter) / ▶ to enter the color manager menu. See page 34 for more information on Color Manager
Dynamic Black Settings	Press ◀ (Enter) / ▶ to enter the dynamic black settings menu. See page 35 for more information on Dynamic Black Settings
HDR Settings	Press ◀ (Enter) / ▶ to enter the HDR settings menu. See page 36 for more information on HDR Settings

Computer Menu

Press the **MENU** button to open the **OSD** menu. Press ◀▶ to move to the **Image** menu. Press ▲▼ to move to the **Computer** menu and then press **Enter** or ▶. Press ▲▼ to move up and down in the **Computer** menu.

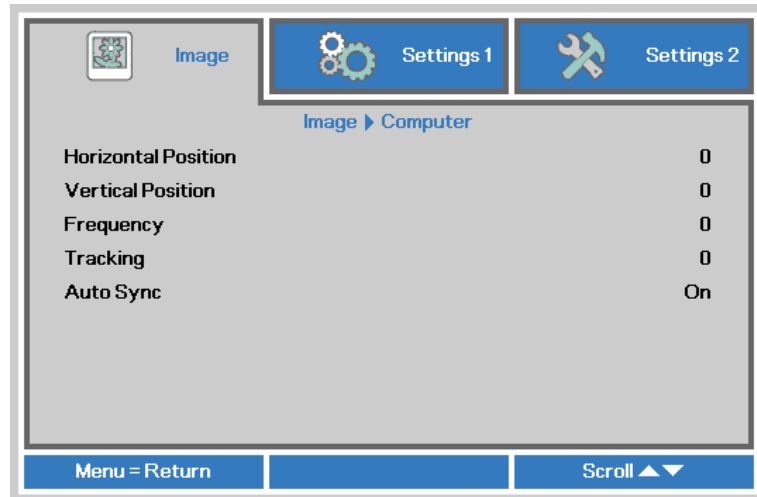

ITEM	DESCRIPTION
Horizontal Position	Press the cursor ◀▶ button to enter and adjust the display position to left or right.
Vertical Position	Press the cursor ◀▶ button to enter and adjust the display position to up or down.
Frequency	Press the cursor ◀▶ button to enter and adjust the A/D sampling clock.
Tracking	Press the cursor ◀▶ button to enter and adjust the A/D sampling dot.
Auto Sync	Press the cursor ◀▶ button to enter and adjust the Auto Sync Position to On or Off.

Advanced Feature

Press the **Menu** button to open the **OSD** menu. Press ◀▶ to move to the **Image** menu. Press ▼▲ to move to the **Advanced** menu and then press **Enter** or ▶. Press ▼▲ to move up and down in the **Advanced** menu.

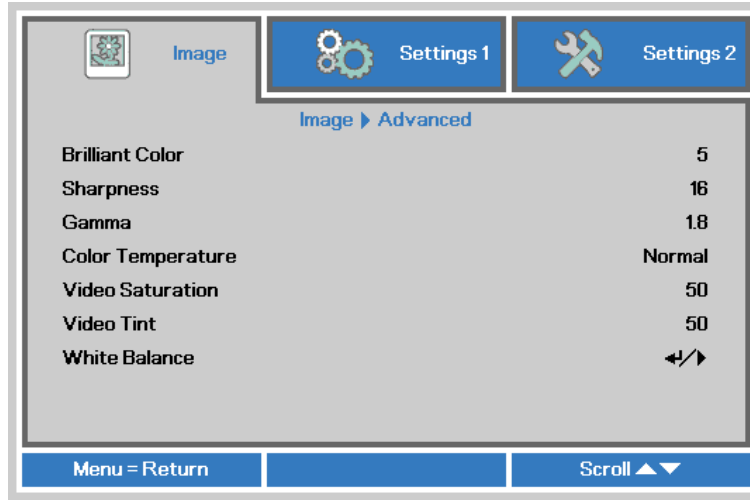

ITEM	DESCRIPTION
Brilliant Color	Press the cursor ◀▶ button to enter and adjust the Brilliant Color value.
Sharpness	Press the cursor ◀▶ button to enter and adjust the display sharpness.
Gamma	Press the cursor ◀▶ button to enter and adjust the gamma correction of the display.
Color Temperature	Press the cursor ◀▶ button to enter and adjust the color temperature.
Video Saturation	Press the cursor ◀▶ button to enter and adjust the video saturation.
Video Tint	Press the cursor ◀▶ button to enter and adjust the video tint/hue.
White Balance	Press the ENTER / ▶ button to enter the White Balance sub menu. See White Balance on page 33

White Balance

Press the **ENTER** button to enter the **White Balance** sub menu.

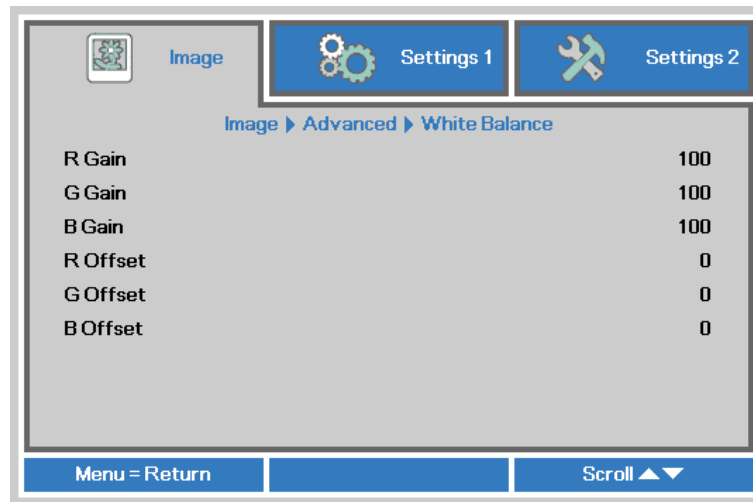

ITEM	DESCRIPTION
R Gain	Press the ◀▶ buttons to adjust the Red Gain.
G Gain	Press the ◀▶ buttons to adjust the Green Gain.
B Gain	Press the ◀▶ buttons to adjust the Blue Gain.
R Offset	Press the ◀▶ buttons to adjust the Red Offset.
G Offset	Press the ◀▶ buttons to adjust the Green Offset.
B Offset	Press the ◀▶ buttons to adjust the Blue Offset.

Color Manager

Press the **Menu** button to open the **OSD** menu. Press ◀▶ to move to the **Image** menu. Press ▼▲ to move to the **Color Manager** menu and then press **Enter** or ▶. Press ▼▲ to move up and down in the **Color Manager** menu.

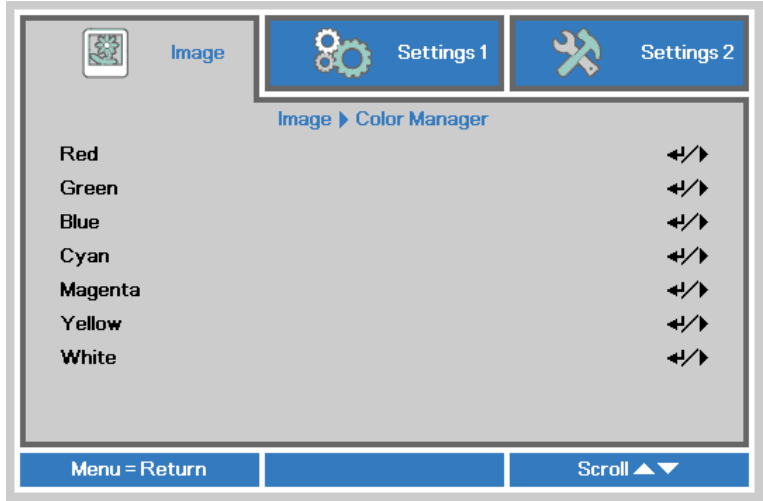

ITEM	DESCRIPTION
Red	Select to enter the Red Color Manager. Press the ◀▶ buttons to adjust the Hue, Saturation, and Gain.
Green	Select to enter the Green Color Manager. Press the ◀▶ buttons to adjust the Hue, Saturation, and Gain.
Blue	Select to enter the Blue Color Manager. Press the ◀▶ buttons to adjust the Hue, Saturation, and Gain.
Cyan	Select to enter the Cyan Color Manager. Press the ◀▶ buttons to adjust the Hue, Saturation, and Gain.
Magenta	Select to enter the Magenta Color Manager. Press the ◀▶ buttons to adjust the Hue, Saturation, and Gain.
Yellow	Select to enter the Yellow Color Manager. Press the ◀▶ buttons to adjust the Hue, Saturation, and Gain.
White	Select to enter the White Color Manager. Press the ◀▶ buttons to adjust the Red, Green, and Blue.

Dynamic Black Settings

Press the **Menu** button to open the **OSD** menu. Press ◀▶ to move to the **Image** menu. Press ▼▲ to move to the **Dynamic Black Settings** menu and then press **Enter** or ▶. Press ▼▲ to move up and down in the **Dynamic Black Settings** menu.

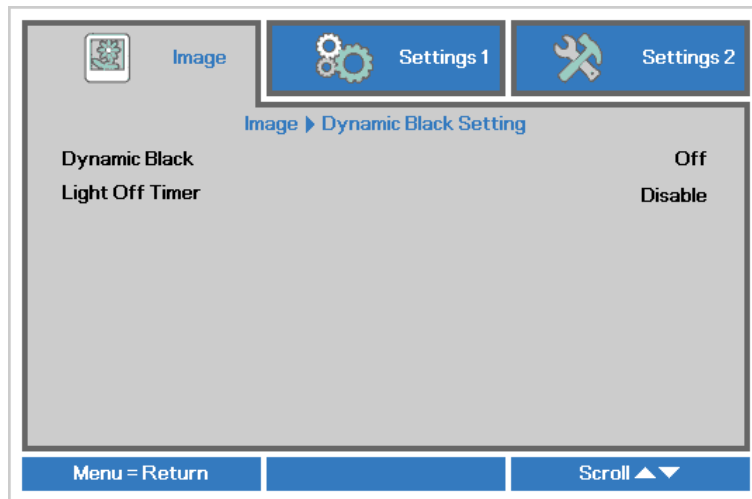

ITEM	DESCRIPTION
Dynamic Black	Select to enter the Dynamic Black under Normal mode and Eco mode Press the ◀▶ buttons to adjust On or Off
Light Off Timer	Select to enter the Light Off Timer Press the ◀▶ buttons to adjust Disable, 0.5 Sec, 1 Sec, 2 Sec, 3 Sec, 4 Sec

HDR Settings

Press the **Menu** button to open the **OSD** menu. Press ◀▶ to move to the **Image** menu. Press ▼▲ to move to the **HDR Settings** menu and then press **Enter** or ▶. Press ▼▲ to move up and down in the **HDR Settings** menu.

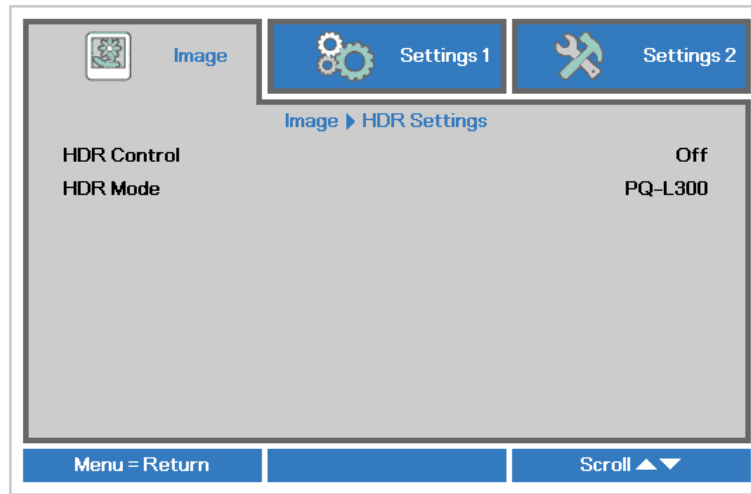

ITEM	DESCRIPTION
HDR Control	Select to enter the HDR Settings Press the ◀▶ buttons to adjust Off, Auto and On
HDR Mode	Select to enter the Light Off Timer Press the ◀▶ buttons to adjust PQ-L300, PQ-L400, PQ-L500, PQ-L600

Note:

If you want to enter HDR Settings, please make sure HDMI source is with HDR-10 or HLG.

Settings 1 Menu

Press the **MENU** button to open the **OSD** menu. Press the cursor **◀▶** button to move to the **Settings 1** menu. Press the cursor **▲▼** button to move up and down in the **Settings 1** menu. Press **◀▶** to enter and change values for settings.



ITEM	DESCRIPTION
Source	Press the cursor ◀▶ button to enter the Source menu. Reference input Source select (IR / Keypad).
Projection	Press the cursor ◀▶ button to enter and choose from four projection methods.
Aspect Ratio	Press the cursor ◀▶ button to enter and adjust the video aspect ratio.
Alignment	Press ↵ (Enter) / ▶ to enter the Alignment menu. See Alignment on page 38.
Digital Zoom	Press the cursor ◀▶ button to enter and adjust the Digital Zoom menu.
Audio	Press ↵ (Enter) / ▶ to enter the Audio menu. See Audio on page 42.
Advanced 1	Press ↵ (Enter) / ▶ to enter the Advanced 1 menu. See Advanced 1 Feature on page 43.
Advanced 2	Press ↵ (Enter) / ▶ to enter the Advanced 2 menu. See Advanced 2 Feature on page 45.

Alignment

Press the **Menu** button to open the **OSD** menu. Press ◀▶ to move to the **Settings 1** menu. Press ▼▲ to move to the **Alignment** menu and then press **Enter** or ▶. Press ▼▲ to move up and down in the **Alignment** menu.

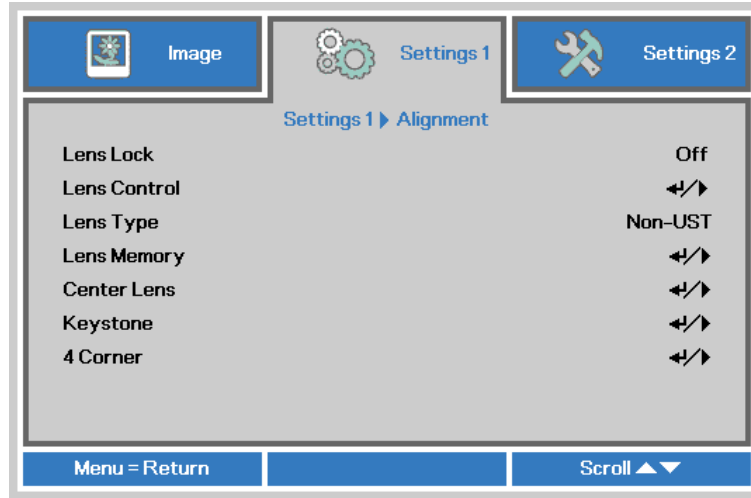

ITEM	DESCRIPTION
Lens Lock	Press the cursor ◀▶ button to enter and adjust the Lens Lock to On or Off.
Lens Control	Press ◀ (Enter) / ▶ to enter the Lens Control menu. See Lens Control on page 39.
Lens Type	Press the cursor ◀▶ button to enter and adjust the Lens Type.
Lens Memory	Press ◀ (Enter) / ▶ to enter the Lens Memory menu. See Lens Memory on page 40.
Center Lens	Press the cursor ◀▶ button to enter and adjust the Digital Zoom menu.
Keystone	Press ◀ (Enter) / ▶ to enter the keystone menu. See Keystone on page 41.
4 Corner	Press ◀ (Enter) / ▶ to enter the 4 Corner sub menu. See 4 Corner on page 41. Note: Without support when 3D mode activated.

Lens Control

Press ◀▶ to adjust Lens Focus. Press ▼▲ to adjust Lens Zoom. Press **Enter** to switch Lens Shift menu.

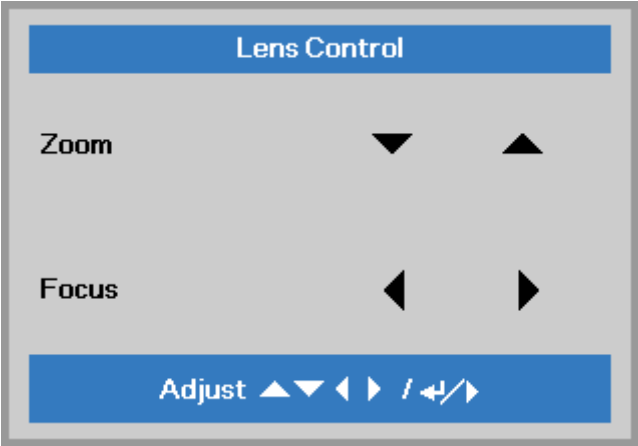

Lens Shift

Press ▼▲◀▶ to adjust Lens Shift. Press Enter to switch Lens Control menu.

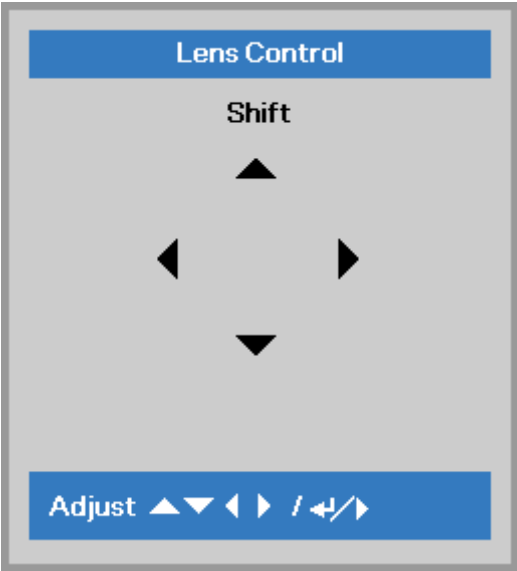

Lens Memory

Press **←** (Enter) / **→** to enter the **Lens Memory** sub menu. Press **▼** **▲** to select Memory 1~Memory 8 and adjust Lens Memory to Save, Load or Clear.

This projector supports Lens Position Memory (LPS). Up to 8 programmed lens positions can be stored in the projector's memory. You can load the stored memory settings to set up the lens position automatically.

Load Memory: Use the **▲** or **▼** button to select the desired memory setting then press ENTER button to execute the lens setting, the projector will adjust the Lens position automatically.

Save Memory: Use the **▲** or **▼** button to select the memory set for storing the setting then press ENTER button to confirm.

Clear Memory: Select the memory set to be cleared, then press ENTER button to confirm clearing memory set.

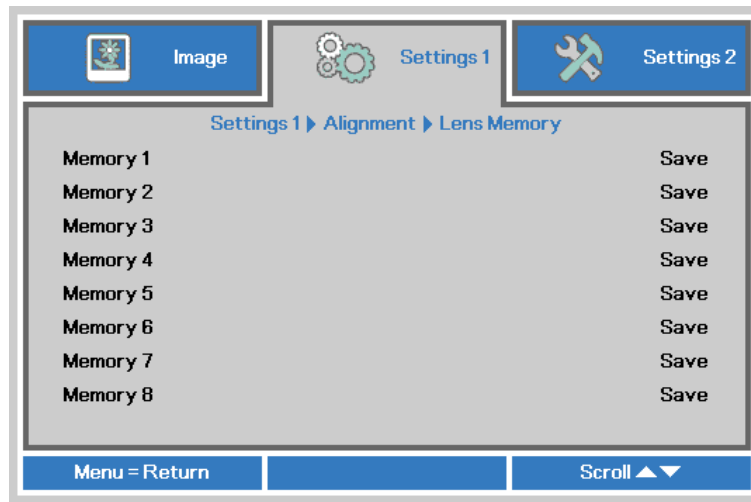

Keystone

Press **↵** (Enter) / **▶** to enter the **Keystone** sub menu. Press **▼** / **▲** to adjust vertical values from -30 to 30. Press **◀** / **▶** to adjust horizontal values from -25 to 25.

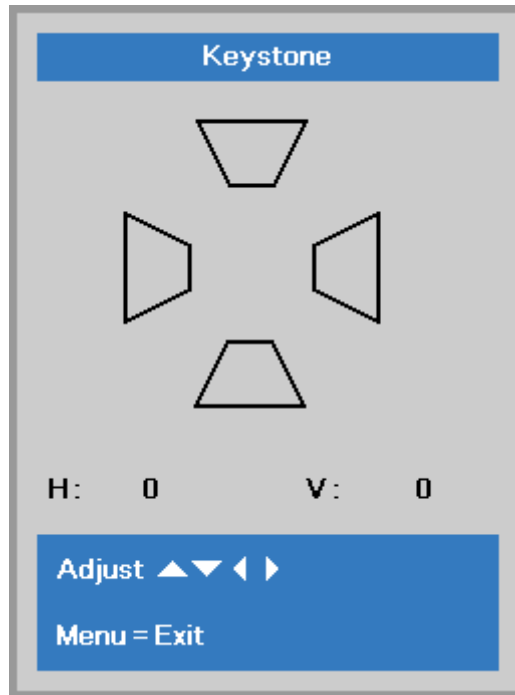

4 Corner

Press **↵** (Enter) / **▶** to enter the **4 Corner** sub menu.

1. Press the cursor **▲** / **▼** buttons to select a corner and press **ENTER**.

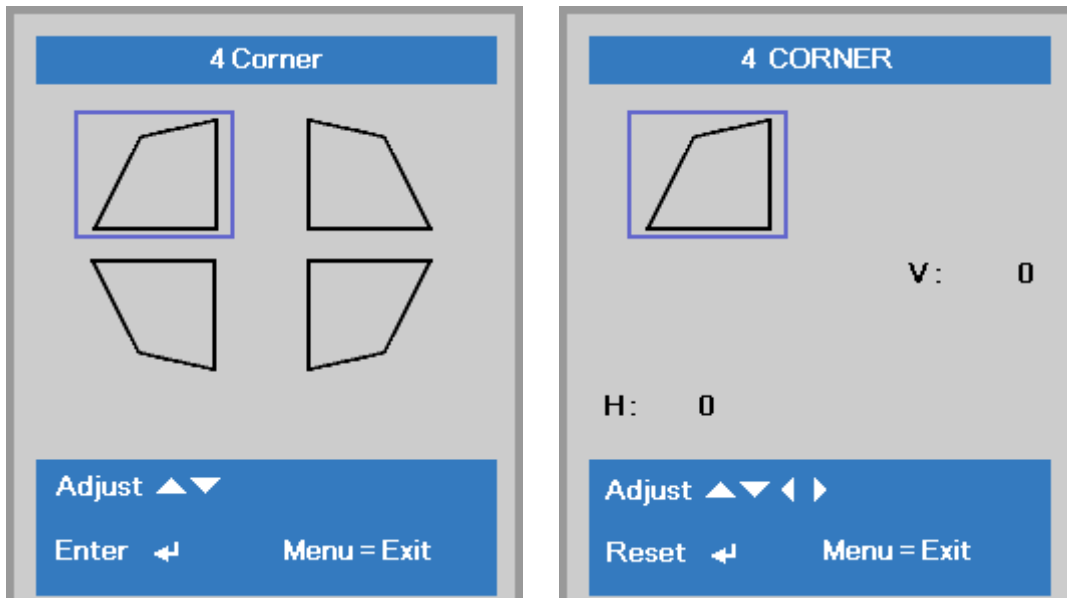

2. Press the cursor **▲** / **▼** buttons to adjust vertical and press the cursor **◀** / **▶** buttons to adjust horizontal.
3. Press **MENU** to save and Exit the settings.

Audio

Press the **Menu** button to open the **OSD** menu. Press ◀▶ to move to the **Settings 1** menu. Press ▼▲ to move to the **Audio** menu and then press **Enter** or ▶. Press ▼▲ to move up and down in the **Audio** menu.



ITEM	DESCRIPTION
Volume	Press the cursor ◀▶ button to enter and adjust the audio volume.
Mute	Press the cursor ◀▶ button to enter and turn on or off the speaker.

Advanced 1 Feature

Press the **Menu** button to open the **OSD** menu. Press ◀▶ to move to the **Settings 1** menu. Press ▲▼ to move to the **Advanced 1** menu and then press **Enter** or ▶. Press ▲▼ to move up and down in the **Advanced 1** menu. Press ◀▶ to enter and change values for setting.

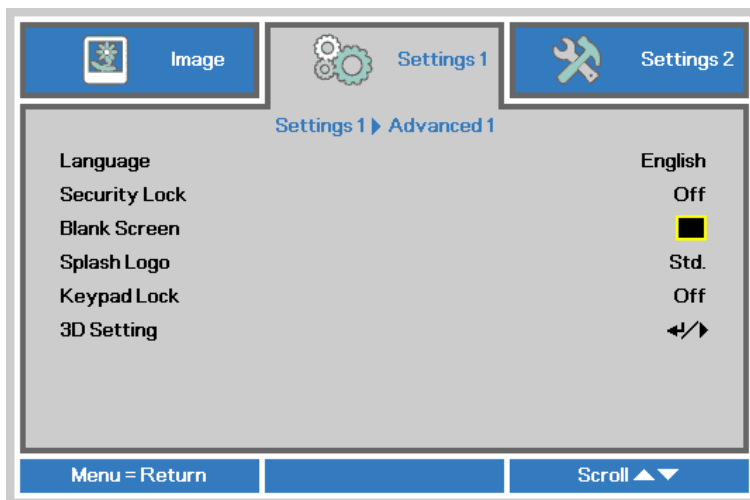

ITEM	DESCRIPTION
Language	Press the cursor ◀▶ button to enter and select a different localization Menu.
Security Lock	Press the cursor ◀▶ button to enter and enable or disable security lock function.
Blank Screen	Press the cursor ◀▶ button to enter and select different color to blank the screen.
Splash Logo	Press the cursor ◀▶ button to enter and enable or disable Splash Logo.
Keypad Lock	Press the cursor ◀▶ button to enter and enable or disable keys can be work on keypad. Note : Hold the cursor ▼ button on keypad for 5 seconds to unlock keypad
3D Setting	Press ◀ (Enter) / ▶ to enter the 3D menu. See page 44 for more information on 3D Setting .

Note:

To enjoy the 3D function, first enable the Play Movie in 3D setting found in your DVD device under the 3D Disc Menu.

3D Setting

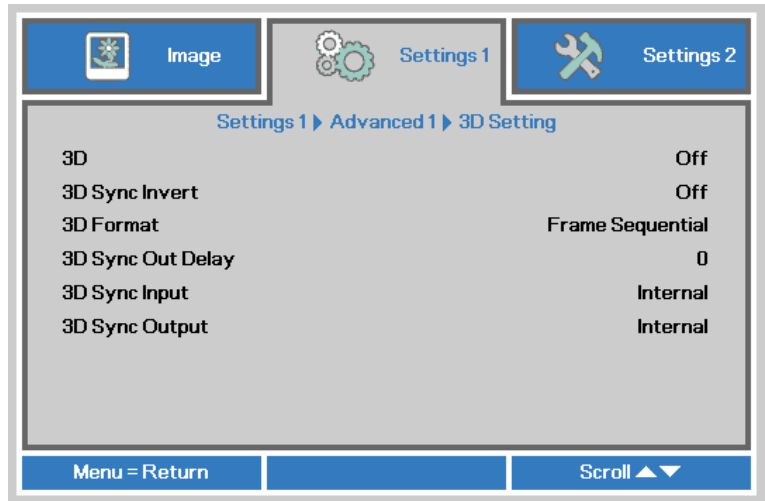

ITEM	DESCRIPTION
3D	Press the cursor ◀▶ button to enter and select different 3D mode.
3D Sync Invert	Press the cursor ◀▶ button to enter and enable or disable 3D Sync Invert.
3D Format	Press the cursor ◀▶ button to enter and select different 3D Format.
3D Sync Out Delay	Press the cursor ◀▶ button to adjust 3D sync out signal delay.
3D Sync Input	Detect internal or external 3D Sync input automatically
3D Sync Output	Press the cursor ◀▶ button to enter internal or by pass 3D Sync output

Note:

1. The 3D OSD menu item is gray if there is no appropriate 3D source. This is the default setting.
2. When the projector is connected to an appropriate 3D source, the 3D OSD menu item is enabled for selection.
3. Use 3D glasses to view a 3D image.
4. You need 3D content from a 3D DVD or 3D media file.
5. You need to enable the 3D source (some 3D DVD content may have a 3D on-off selection feature).
6. You need DLP link 3D or IR 3D shutter glasses. With IR 3D shutter glasses, you need to install a driver on your PC and connect a USB emitter.
7. The 3D mode of the OSD needs to match the type of glasses (DLP link or IR 3D).
8. Power on the glasses. Glasses normally have a power on -off switch. Each type of glasses has their own configuration instructions. Please follow the configuration instructions that come with your glasses to finish the setup process.
9. Passive 3D is not going to support thru 3D Sync In/Out.

Note:

Since different types of glass (DLP link or IR shutter glass) have their own setting instructions, Please follow the guide to finish the setup process.

Advanced 2 Feature

Press the **Menu** button to open the **OSD** menu. Press ◀▶ to move to the **Settings 1** menu. Press ▲▼ to move to the **Advanced 2** menu and then press **Enter** or ▶. Press ▲▼ to move up and down in the **Advanced 2** menu. Press ◀▶ to enter and change values for setting.

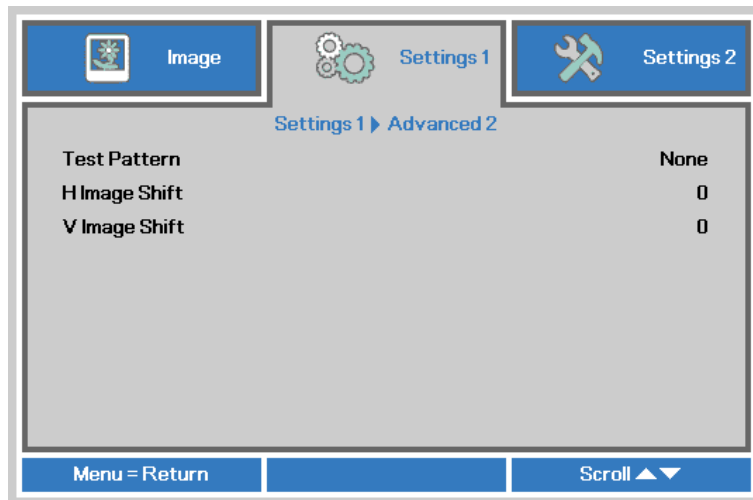

ITEM	DESCRIPTION
Test Pattern	Press the cursor ◀▶ button to enter and select internal test pattern.
H Image Shift	Press the cursor ◀▶ button to enter and set H Image Shift.
V Image Shift	Press the cursor ◀▶ button to enter and set V Image Shift.

Settings 2 Menu

Press the **MENU** button to open the **OSD** menu. Press the cursor ◀▶ button to move to the **Settings 2** menu. Press the cursor ▲▼ button to move up and down in the **Settings 2** menu.

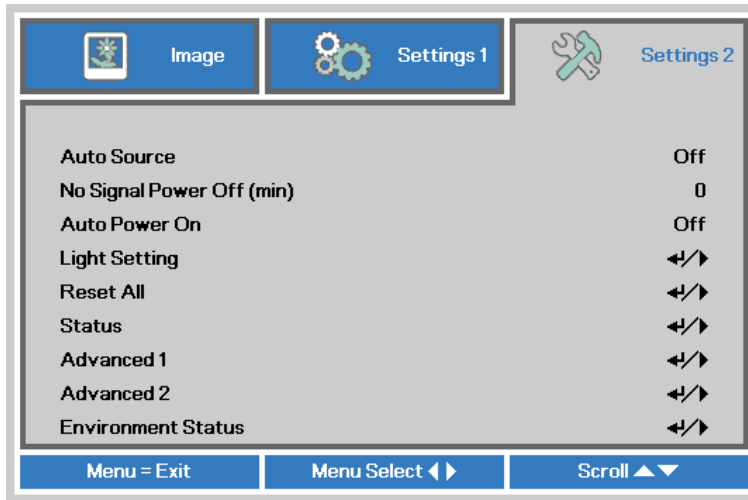

ITEM	DESCRIPTION
Auto Source	Press the cursor ◀▶ button to enter and enable or disable automatic source detection.
No Signal Power Off (min.)	Press the cursor ◀▶ button to enter and set automatic shutdown of Light source when no signal.
Auto Power On	Press the cursor ◀▶ button to enter and enable or disable automatic power On when AC power is supplied.
Light Setting	Press the cursor ◀▶ button to enter and select the Light mode, Custom Light or Constant Brightness. See page 47 for more information on Light Setting
Reset All	Press ◀ (Enter) / ▶ to reset all settings to default values.
Status	Press ◀ (Enter) / ▶ to enter the Status menu. See page Status 48 for more information on Status .
Advanced 1	Press ◀ (Enter) / ▶ to enter the Advanced 1 menu. See Advanced 1 Feature on page 49.
Advanced 2	Press ◀ (Enter) / ▶ to enter the Advanced 2 menu. See Advanced 2 Feature on page 62.
Environment Status	Press ◀ (Enter) / ▶ to enter the Environment Status menu. See Environment Status on page 64.

Light Setting

Press the cursor ▲ ▼ button to move up and down in the **Settings 2** menu. Select the **Light Setting** menu and press **Enter** or ► to enter.



ITEM	DESCRIPTION
Light Mode	Press the cursor ◀▶ button to select Normal, Eco, Eco Plus, Dimming, Extreme Dimming
Custom Light	Press the cursor ◀▶ button to enter and set Custom Light.
Constant Brightness	Press the cursor ◀▶ button to enter and enable or disable Constant Brightness.

Note :

Extreme Dimming: Saving 50% light source power consumption by blank screen (press BLANK button)
When Light Mode set to Custom Light, Custom Light function Enable.

Status

Press the cursor ▲▼ button to move up and down in the **Settings 2** menu. Select the **Status** menu and press **Enter** or ► to enter.

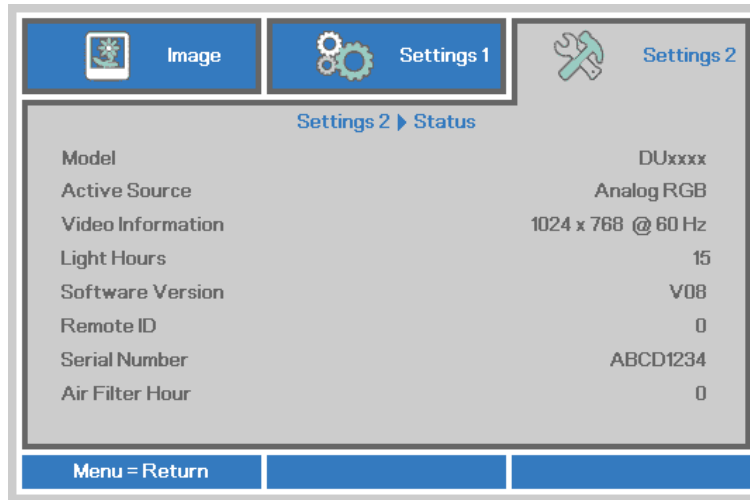

ITEM	DESCRIPTION
Model	Showing model name.
Active Source	Display the activated source.
Video Information	Displays resolution/video information for RGB source and color standard for Video source.
Light Hour	Light hour used information is displayed.
Software Version	Showing system software version.
Remote ID	Showing Remote Controller ID
Serial Number	Showing serial number of product.
Air Filter Hour	Displays the number of hours the air filter has been in use.

Advanced 1 Feature

Press the **Menu** button to open the **OSD** menu. Press ◀▶ to move to the **Settings 2** menu. Press ▲▼ to move to the **Advanced 1** menu and then press **Enter** or ▶. Press ▲▼ to move up and down in the **Advanced 1** menu. Press ◀▶ to enter and change values for setting.



ITEM	DESCRIPTION
Menu Position	Press the cursor ◀▶ button to enter and select different OSD location
Translucent Menu	Press the cursor ◀▶ button to enter and select OSD background translucent level
Low Power Mode	Press the cursor ◀▶ button to enter and turn Low Power Mode On or On By Lan
Fan Speed	Press the cursor ◀▶ button to enter and toggle between Normal and High fan speeds. Note: We recommend selecting high speed in high temperatures, high humidity, or high altitude (higher than 1500m/4921ft) areas
Light Info	Press ◀ (Enter) / ▶ to enter the Light Info menu to display the light hours for each light mode
Remote ID	Press the cursor ◀▶ buttons to select remote ID to fit the current remote ID settings
Network	Press ◀ (Enter) / ▶ to enter the Network menu. See page 50 for more information on Network .
HDBaseT-IR/RS232	Press ◀ (Enter) / ▶ to enter the HDBaseT Setting menu. See page 61 for more information on HDBaseT-IR/RS232

Note:

About "On By Lan", RJ45 will support to be waked up in this mode(Under 3W) but scalar won't.

Note:

1. Remoter with Default customer code will be available for any Remote ID setting on the OSD.
2. Status key will be available for any Remote ID setting on the OSD
3. IF users forget the current Remote ID setting, please press the Status key to call out the INFORMATION OSD to check the current Remote ID setting and then adjust the ID on the remoter to meet the OSD setting.
4. After adjusting Remote ID from OSD, only if the OSD Menu has been closed then the new ID value can be taken effected and memorized.
5. The setting value "Default" means ID 0 on the remoter.

Network

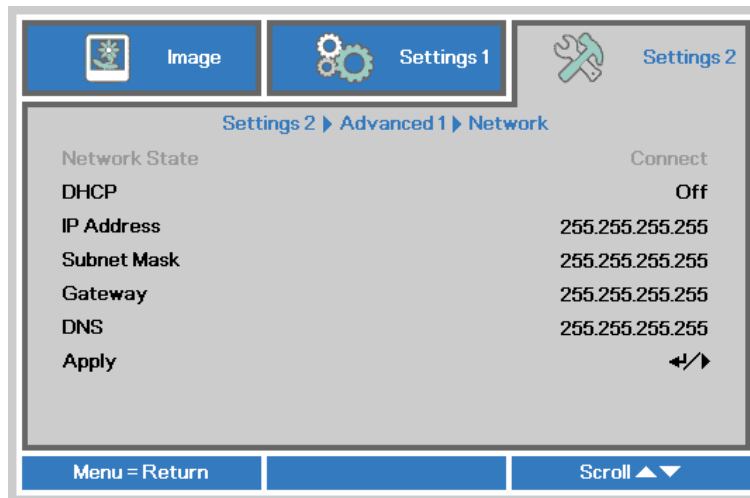

ITEM	DESCRIPTION
Network State	Displays the network connection status.
DHCP	Press ◀▶ to turn DHCP On or Off. Note: If you select DHCP Off, complete the IP Address, Subnet Mask, Gateway, and DNS fields.
IP Address	Enter a valid IP address if DHCP is turned off.
Subnet Mask	Enter a valid Subnet Mask if DHCP is turned off.
Gateway	Enter a valid Gateway address if DHCP is turned off.
DNS	Enter a valid DNS name if DHCP is turned off.
Apply	Press ◀ (Enter) / ▶ to confirm settings.

LAN_RJ45

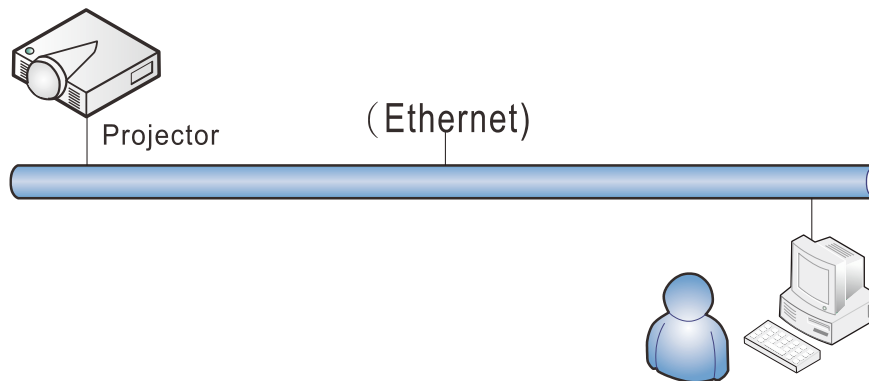

Wired LAN Terminal functionalities

Remote control and monitoring of a projector from a PC (or Laptop) via wired LAN is also possible. Compatibility with Crestron / AMX (Device Discovery) / Extron control boxes enables not only collective projector management on a network but also management from a control panel on a PC (or Laptop) browser screen.

- ★ Crestron is a registered trademark of Crestron Electronics, Inc. of the United States.
- ★ Extron is a registered trademark of Extron Electronics, Inc. of the United States.
- ★ AMX is a registered trademark of AMX LLC of the United States.
- ★ PJLink applied for trademark and logo registration in Japan, the United States of America, and other countries by JBMIA.

Supported External Devices

This projector is supported by the specified commands of the Crestron Electronics controller and related software (ex, RoomView ®).

<http://www.crestron.com/>

This projector is supported by AMX (Device Discovery).

<http://www.amx.com/>

This projector is compliant to support Extron device(s) for reference.

<http://www.extron.com/>

This projector supports all commands of PJLink Class1 (Version 1.00).

<http://pjlink.jbmia.or.jp/english/>

For more detail of information about the diverse types of external devices which can be connected to the LAN/RJ45 port and remote/control the projector, as well as the related control commands supporting for each external device, kindly please get contact with the Support-Service team directly.

LAN RJ45

1. Connect an RJ45 cable to RJ45 ports on the projector and the PC (Laptop).

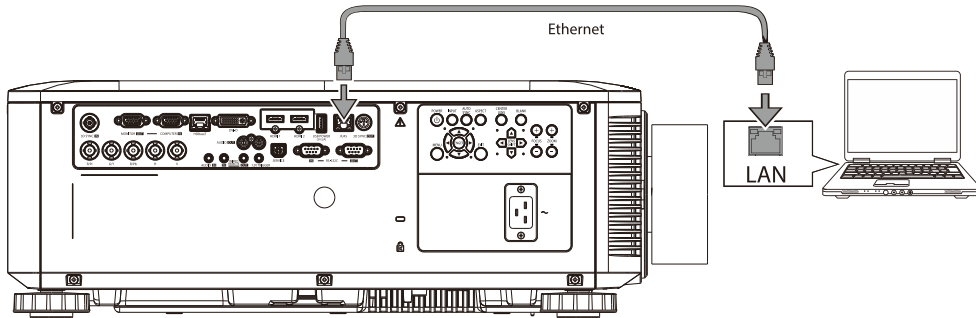

2. On the PC (Laptop), select **Start** → **Control Panel** → **Network and Internet**.

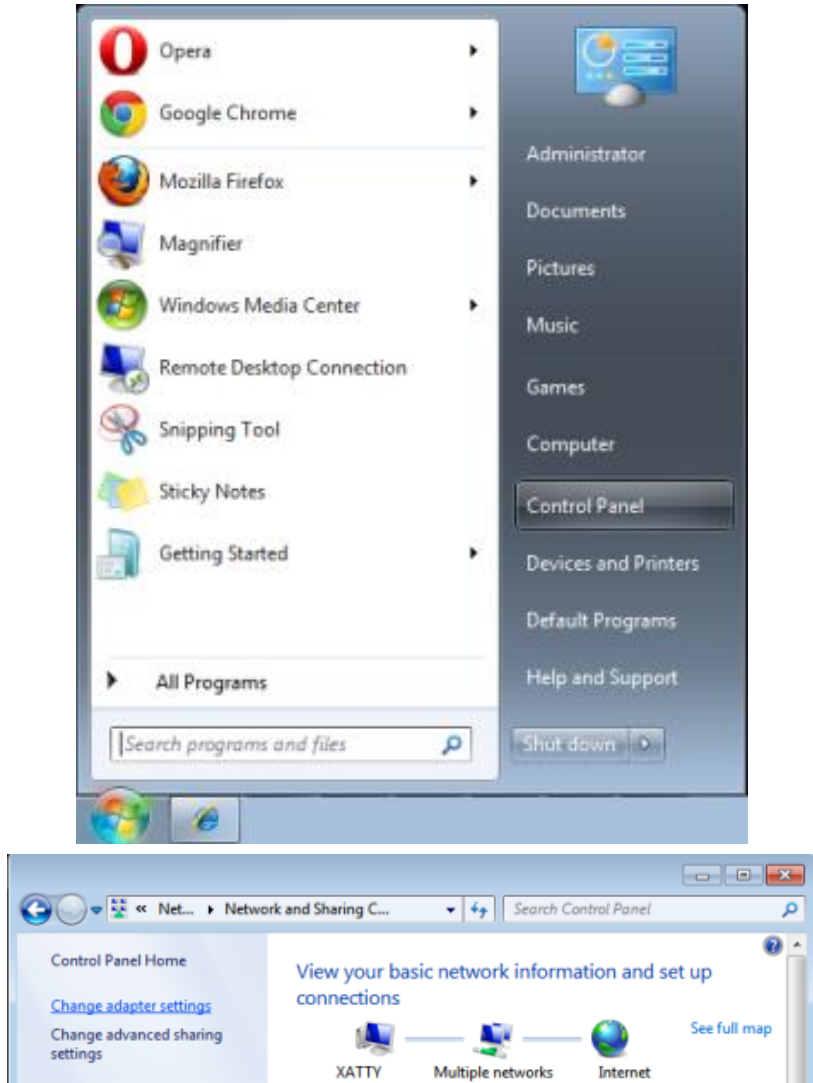

3. Right-click on **Local Area Connection**, and select **Properties**.

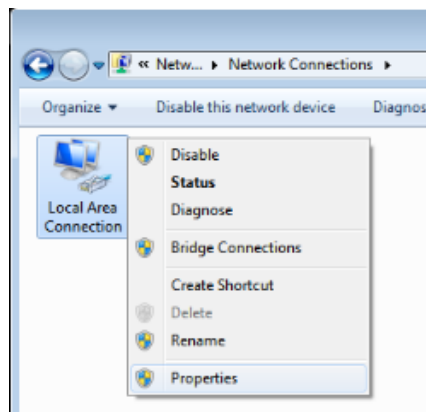

4. In the **Properties** window, select the **Networking** tab, and select **Internet Protocol (TCP/IP)**.
5. Click **Properties**.

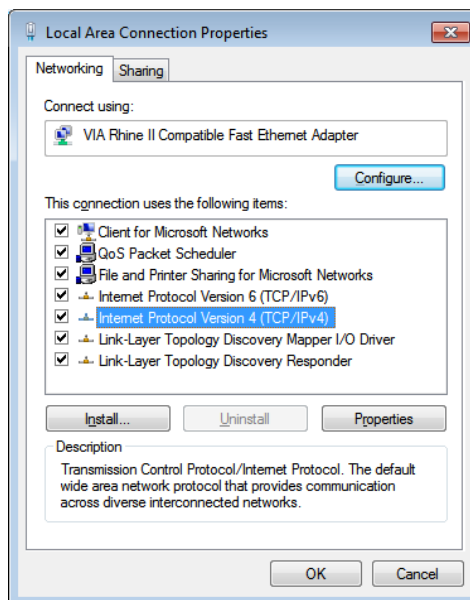

6. Click **Use the following IP address** and fill in the IP address and Subnet mask, then click **OK**.

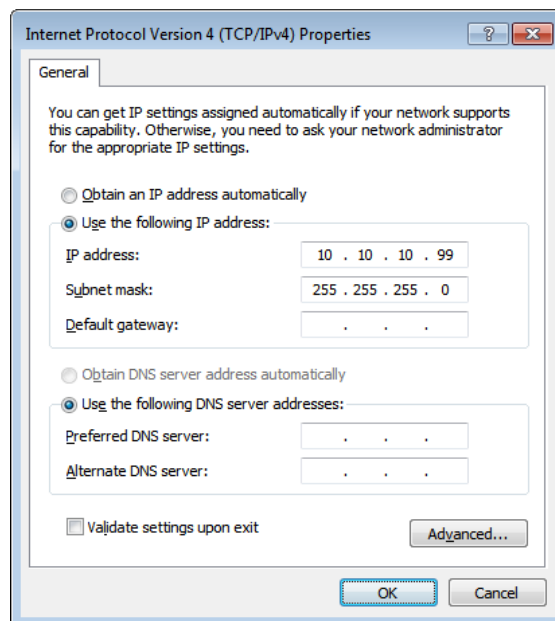

7. Press the **Menu** button on the projector.
8. Select **Settings2**→ **Advanced1** → **Network**
9. After getting into **Network**, input the following:
 - ▶ DHCP: Off
 - ▶ IP Address: 10.10.10.10
 - ▶ Subnet Mask: 255.255.255.0
 - ▶ Gateway: 0.0.0.0
 - ▶ DNS Server: 0.0.0.0
10. Press **↵** (Enter) / **▶** to confirm settings.
Open a web browser
(for example, Microsoft Internet Explorer with Adobe Flash Player 9.0 or higher).

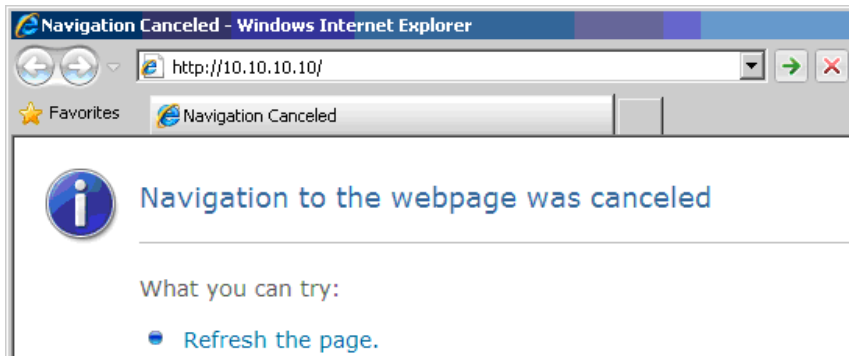

11. In the Address bar, input the IP address: 10.10.10.10.
12. Press **↵** (Enter) / **▶**.

The projector is setup for remote management. The LAN/RJ45 function displays as follows.

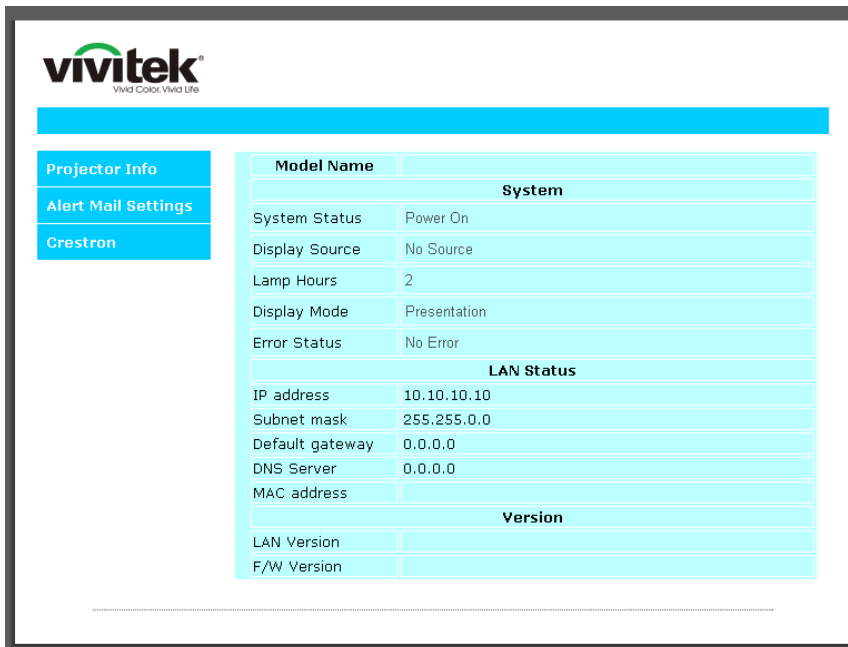



Expansion Options

Crestron Control IP Address <input type="text"/> IP ID <input type="text"/> Control Port <input type="text"/> <input type="button" value="Control Set"/>		Projector Projector Name <input type="text" value="PJ01"/> Location <input type="text" value="RM01"/> Assigned To <input type="text" value="Sir"/> <input type="button" value="Set"/> Network Config <input type="checkbox"/> DHCP Enabled IP Address <input type="text" value="10.10.10.10"/> Subnet Mask <input type="text" value="255.255.255.0"/> Default Gateway <input type="text" value="0.0.0.0"/> DNS Server <input type="text" value="0.0.0.0"/> <input type="button" value="Net Set"/>		User Password <input type="checkbox"/> Usr Enabled Password <input type="text"/> Confirmed <input type="text"/> <input type="button" value="Usr Set"/> Admin Password <input type="checkbox"/> Adm Enabled Password <input type="text"/> Confirmed <input type="text"/> <input type="button" value="Adm Set"/>	
<input type="button" value="Tools Exit"/>					

CATEGORY	ITEM	INPUT-LENGTH
Crestron Control	IP Address	15
	IP ID	3
	Port	5
Projector	Projector Name	10
	Location	10
	Assigned To	10
Network Configuration	DHCP (Enabled)	(N/A)
	IP Address	15
	Subnet Mask	15
	Default Gateway	15
	DNS Server	15
User Password	Enabled	(N/A)
	New Password	10
	Confirm	10
Admin Password	Enabled	(N/A)
	New Password	10
	Confirm	10

For more information, please visit <http://www.crestron.com>.

Preparing Email Alerts

1. Make sure that user can access the homepage of LAN RJ45 function by web browser (for ex-ample, Microsoft Internet Explorer v6.01/v8.0).
2. From the Homepage of LAN/RJ45, click **Alert Settings**.

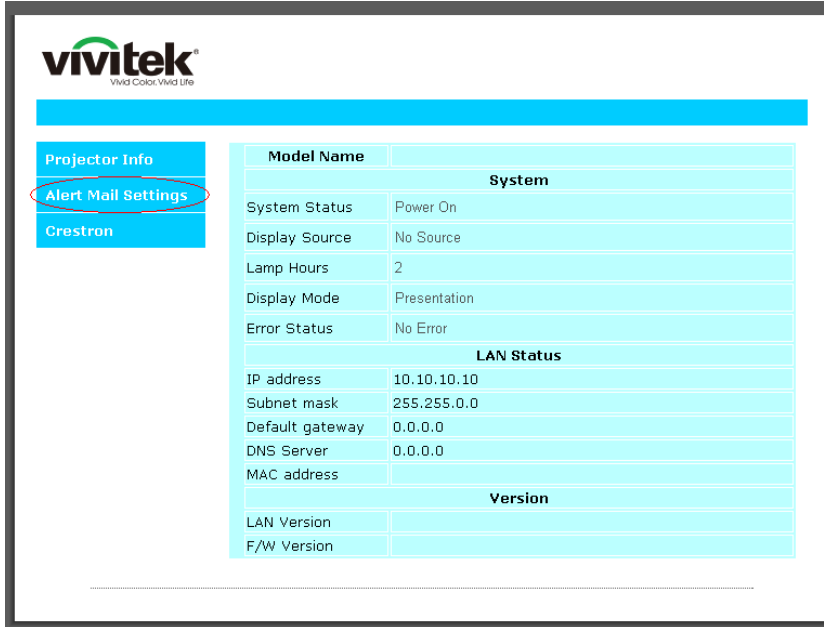

3. By default, these input boxes in **Alert Settings** are blank.



4. For Sending alert mail, input the following:

The **SMTP** field is the mail server for sending out email (SMTP protocol). This is a required field.

The **To** field is the recipient’s email address (for example, the projector administrator). This is a required field.

The **Cc** field sends a carbon copy of the alert to the specified email address. This is an optional field (for example, the projector administrator’s assistant).

The **From** field is the sender’s email address (for example, the projector administrator). This is a required field.

Select the alert conditions by checking the desired boxes.

The screenshot shows the 'Send E-Mail' configuration interface. On the left, a sidebar contains 'Projector Info', 'Alert Mail Settings', and 'Crestron'. The main content area is titled 'Send E-Mail' and includes the instruction: 'Enter the appropriate settings in the fields below: (Your SMTP server may not require a user name or password.)'. The form contains the following fields and options:

- SMTP Server:** mail.corp.com
- Port:** 25
- User Name:** Sender.US
- Password:** [Masked]
- From:** send@mail.corp.com
- To:** rcvr1@mail.corp.com
- CC:** rcvr2@mail.corp.com
- E-mail Alert Options:**
 - Fan lock:
 - Case Open:
 - Lamp Hours Over:
 - Weekly Report:
 - Over_Heat:
 - Lamp Fail:
 - Filter Hours Over:

Buttons for 'Mail Server Apply', 'Mail Address Apply', 'Alert Option Apply', and 'Send Test Mail' are also visible.

Note: Fill in all fields as specified. User can click **Send Test Mail** to test what setting is correct. For successful sending an e-mail alert, you must select alert conditions and enter a correct e-mail address.

RS232 by Telnet Function

Besides projector connected to RS232 interface with “Hyper-Terminal” communication by dedicated RS232 command control, there is alternative RS232 command control way, so called “RS232 by TELNET” for LAN/RJ45 interface.

Quick Start-Guide for “RS232 by TELNET”

Check and get the IP-Address on OSD of the projector.

Make sure that laptop/PC can access the web-page of the projector.

Make sure that “Windows Firewall” setting to be disabled in case of “TELNET” function filtering out by laptop/PC.

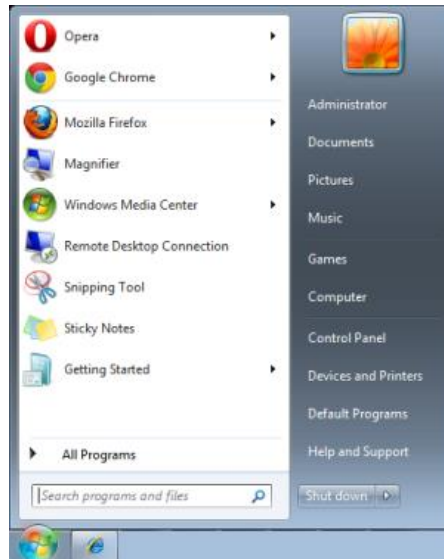

Start => All Programs => Accessories => Command Prompt

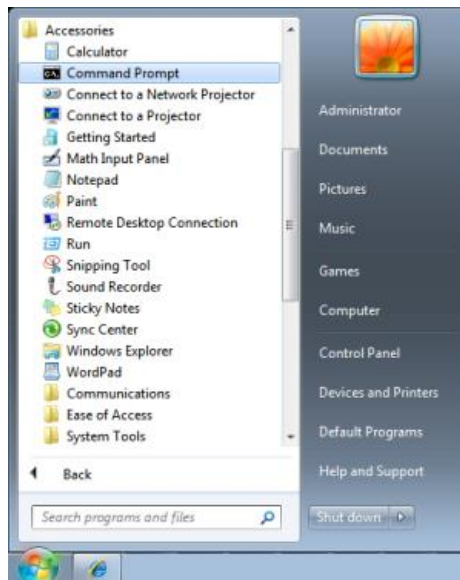

Input the command format like the below:

telnet ttt.xxx.yyy.zzz 7000 (“Enter” key pressed)

(**ttt.xxx.yyy.zzz**: IP-Address of the projector)

If Telnet-Connection ready, and user can have RS232 command input, then “Enter” key pressed, the RS232 command will be workable.

How to have TELNET enabled in Windows

By default installation for Windows, “TELNET” function is not included. But end-user can have it by way of “Turn Windows features On or Off” to be enabled.

Open “Control Panel” in Windows



Open “Programs”

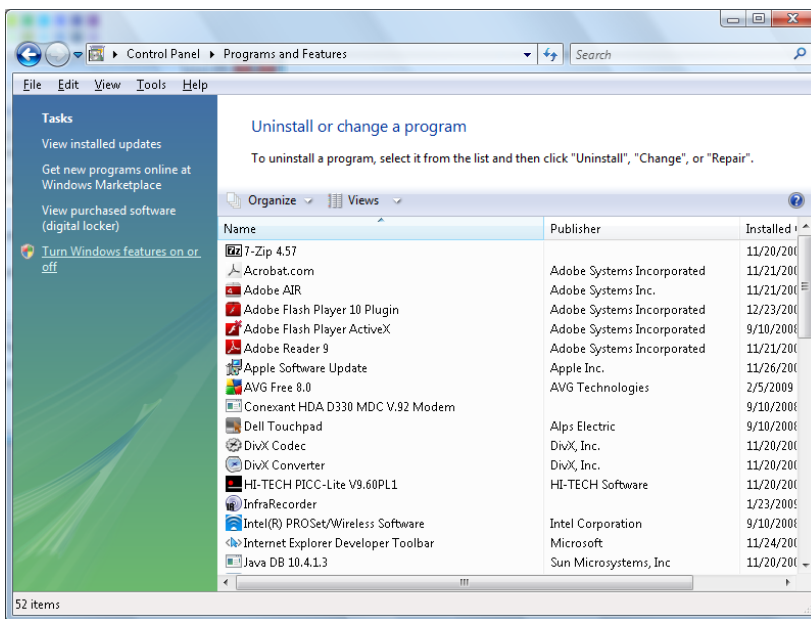

Select “Turn Windows features on or off” to open

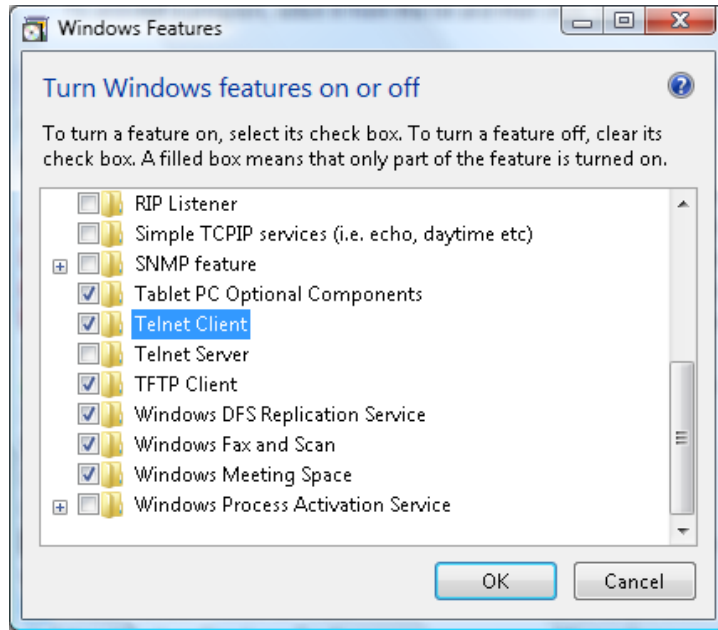

Have “Telnet Client” option checked, then press “OK” button.

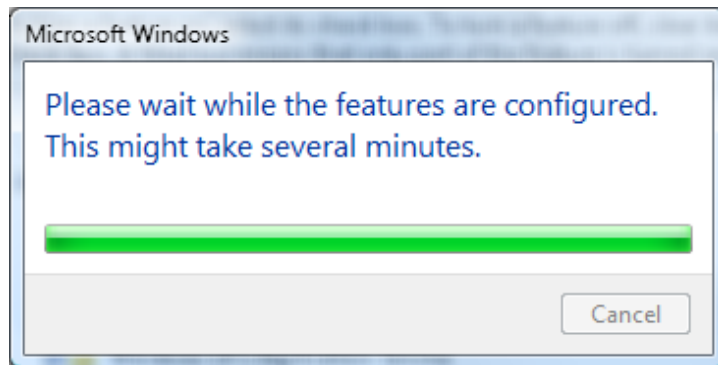

Specsheet for “RS232 by TELNET” :

1. Telnet: TCP
2. Telnet port: 7000
(for more detail, kindly please get contact with the service agent or team)
3. Telnet utility: Windows “TELNET.exe” (console mode)
4. Disconnection for RS232-by-Telnet control normally: Close Windows Telnet utility directly after TELNET connection ready
5. Limitation 1 for Telnet-Control: there is less than 50 bytes for successive network payload for Telnet-Control application.
Limitation 2 for Telnet-Control: there is less than 26 bytes for one complete RS232 command for Telnet-Control.
Limitation 3 for Telnet-Control: Minimum delay for next RS232 command must be more than 200 (ms).
(*, In Windows built-in “TELNET.exe” utility, “Enter” key pressed will have “Carriage-Return” and “New-Line” code.)

HDBaseT-IR/RS232

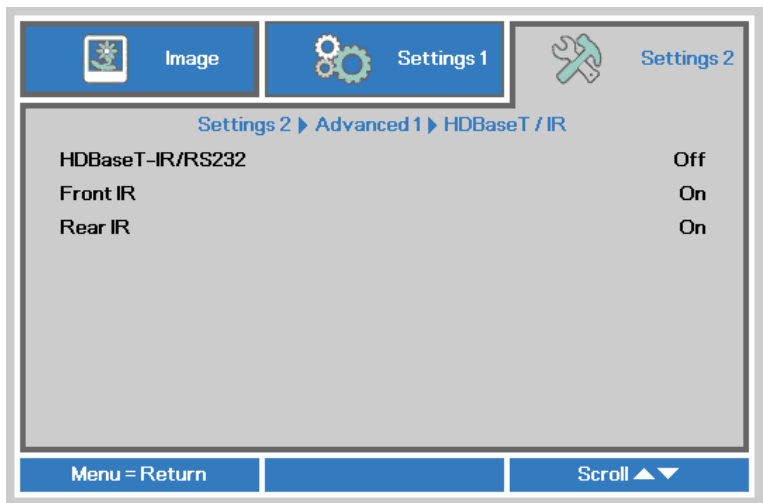

ITEM	DESCRIPTION
HDBaseT-IR/RS232	Press the cursor ◀▶ button to enter and enable or disable HDBaseT Control.
Front IR	Press the cursor ◀▶ button to enter and enable or disable Front IR.
Rear IR	Press the cursor ◀▶ button to enter and enable or disable Rear IR.

Note:

1. Enable **HDBaseT control** function when you desire to use HDBaseT TX box. (Remove RS232 and RJ45/LAN control function from Projector to HDBaseT TX box.) See HDBaseT control function table.
2. When HDBaseT enable, **Low Power Mode** will auto set to **On by HDBaseT**.
3. **HDBaseT control** is disabled when the HDBaseT TX box signal is cutoff.

HDBaseT control function table

Control Side	Function	Projector Mode			Remark
		Low Power Mode On(<0.5W)	Low Power Mode On by lan(<3W)	HDBaseT control Enable Low Power Mode On by HDBaseT(<6W)	
Projector	Front-IR(wireless)	O	O	O(Can disable by OSD)	
	Rear-IR(wireless)	O	O	O(Can disable by OSD)	
	RS-232	O	O	X	
	RJ45/LAN	X	O	X	
	Wired remote	O	O	O	
HDBaseT TX Box	HDBT-IR(wireless)	X	X	O	
	RS-232	X	X	O	
	RJ45/LAN	X	X	O	
	Wired remote	X	X	O	User can connect wired remote at HDBaseT TX side to get the wired function.

O : Enable X : Disable

Advanced 2 Feature

Press the **Menu** button to open the **OSD** menu. Press ◀▶ to move to the **Settings 2** menu. Press ▲▼ to move to the **Advanced 2** menu and then press **Enter** or ▶. Press ▲▼ to move up and down in the **Advanced 2** menu. Press ◀▶ to enter and change values for setting.

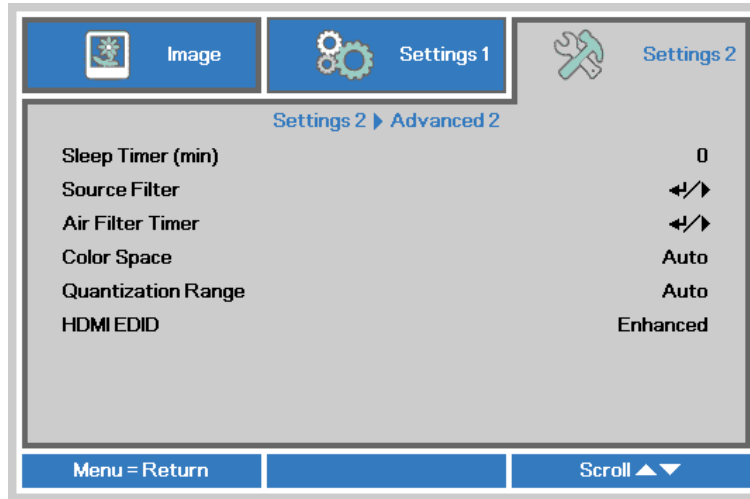

ITEM	DESCRIPTION
Sleep Timer	Press the cursor ◀▶ button to enter and set Sleep timer. The projector automatically turns off after the preset period of time.
Source Filter	Press ◀ (Enter) / ▶ to enter the Source Filter menu. See page 63 for more information on Source Filter .
Air Filter Timer	Press ◀ (Enter) / ▶ to enter the Air Filter Timer menu. See page 64 for more information on Air Filter Timer .
Color Space	Press the cursor ◀▶ button to enter and set the Color Space.
Quantization Range	Press the cursor ◀▶ button to enter and set the Quantization Range.
HDMI EDID	Press the cursor ◀▶ button to enter and select a different HDMI EDID.

Source Filter

Press the **ENTER** button to enter the **Source Filter** sub menu.



ITEM	DESCRIPTION
HDMI1	Press the cursor ◀▶ button to enter and enable or disable the HDMI1 source.
HDMI2	Press the cursor ◀▶ button to enter and enable or disable the HDMI2 source.
DVI	Press the cursor ◀▶ button to enter and enable or disable the DVI source.
VGA	Press the cursor ◀▶ button to enter and enable or disable the VGA source.
BNC	Press the cursor ◀▶ button to enter and enable or disable the BNC source.
HDBaseT	Press the cursor ◀▶ button to enter and enable or disable the HDBaseT source.

Air Filter Timer

Press the **ENTER** button to enter the **Air Filter Timer** sub menu.

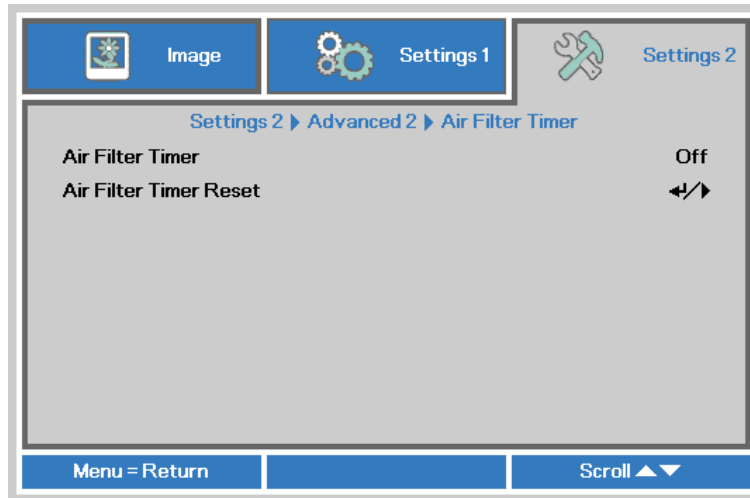

ITEM	DESCRIPTION
Air Filter Timer	Press the cursor ◀▶ button to enter and enable or disable the Air Filter Timer.
Air Filter Timer Reset	Press ◀ (Enter) / ▶ to reset air filter timer.

Environment Status

Press the **ENTER** button to enter the **Environment Status** sub menu.

Environment	
T1	26
T2	48
T3	50
T4	60
T5	61
Fan1	1300
Fan2	1300
Fan3	1300
Fan4	1300
Fan5	1300
Fan6	1500
Fan7	1500
Fan8	1500
Fan9	3000
Fan 10	1500
Fan 11	1500
Fan 12	1500
Fan 13	1500
Color Sensor Current	200
Color Sensor Target	201

Menu = Exit

Cleaning the Projector

Cleaning the projector to remove dust and grime will help ensure trouble-free operation.



Warning:

1. Be sure to turn off and unplug the projector at least 30 minutes before cleaning. Failure to do so could result in a severe burn.
2. Use only a dampened cloth when cleaning. Do not allow water to enter the ventilation openings on the projector.
3. If a little water gets into the projector interior while cleaning, leave unplugged in a well-ventilated room for several hours before using.
4. If a lot of water gets into the projector interior when cleaning, have the projector serviced.

Cleaning the Lens

You can purchase optic lens cleaner from most camera stores. Refer to the following to clean the projector lens.

1. Apply a little optic lens cleaner to a clean soft cloth. (Do not apply the cleaner directly to the lens.)
2. Lightly wipe the lens in a circular motion.



Caution:

1. Do not use abrasive cleaners or solvents.
2. To prevent discoloration or fading, avoid getting cleaner on the projector case.

Cleaning the Case

Refer to the following to clean the projector case.

1. Wipe off dust with a clean dampened cloth.
2. Moisten the cloth with warm water and mild detergent (such as used to wash dishes), and then wipe the case.
3. Rinse all detergent from the cloth and wipe the projector again.



Caution:

To prevent discoloration or fading of the case, do not use abrasive alcohol-based cleaners.

Using the Physical Lock

Using the Kensington Security Slot

If you are concerned about security, attach the projector to a permanent object with the Kensington slot and a security cable.

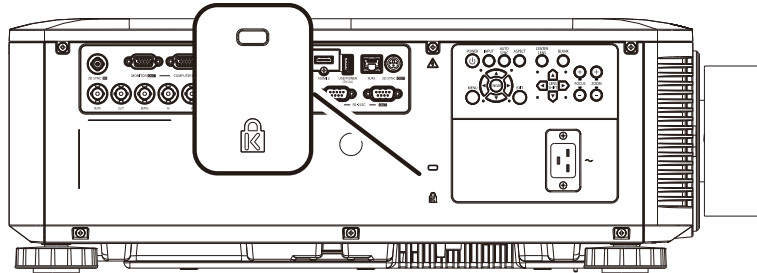

Note:

Contact your vendor for details on purchasing a suitable Kensington security cable.

The security lock corresponds to Kensington's MicroSaver Security System. If you have any comment, contact: Kensington, 2853 Campus Drive, San Mateo, CA 94403, U.S.A. Tel: 800-535-4242, <http://www.Kensington.com>.

Using the Security Bar Lock

In addition to the password protection function and the Kensington lock, the Security Bar Opening helps protect the projector from unauthorized use.

See the following picture.

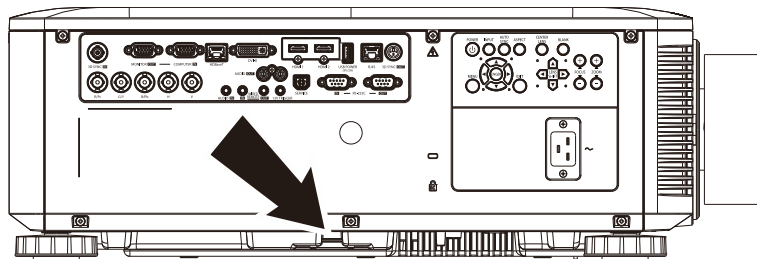

Common Problems and Solutions

These guidelines provide tips to deal with problems you may encounter while using the projector. If the problem remains unsolved, contact your dealer for assistance.

Often after time spent troubleshooting, the problem is traced to something as simple as a loose connection. Check the following before proceeding to the problem-specific solutions.

- *Use some other electrical device to confirm that the electrical outlet is working.*
- *Ensure the projector is turned on.*
- *Ensure all connections are securely attached.*
- *Ensure the attached device is turned on.*
- *Ensure a connected PC is not in suspending mode.*
- *Ensure a connected notebook computer is configured for an external display. (This is usually done by pressing an Fn-key combination on the notebook.)*

Tips for Troubleshooting

In each problem-specific section, try the steps in the order suggested. This may help you to solve the problem more quickly.

Try to pin point the problem and thus avoid replacing non-defective parts.

For example, if you replace batteries and the problem remains, put the original batteries back and go to the next step.

Keep a record of the steps you take when troubleshooting: The information may be useful when calling for technical support or for passing on to service personnel.

LED Error Messages

SYSTEM STATUS	POWER LED (GREEN)	STATUS LED (RED)	LIGHT LED (RED)	TEMP LED (RED)
Light Ready	ON	OFF	OFF	OFF
Start	Flashing	OFF	OFF	OFF
Cooling	Flashing	OFF	OFF	OFF
Over Temperature T1	OFF	OFF	1 blinks	ON
Over Temperature T2	OFF	OFF	2 blinks	ON
Over Temperature T3	OFF	OFF	3 blinks	ON
Over Temperature T4	OFF	OFF	4 blinks	ON
Over Temperature T5	OFF	OFF	5 blinks	ON
Thermal Break Sensor error	OFF	4 blinks	OFF	OFF
FAN1 error	OFF	6 blinks	1 blinks	OFF
FAN2 error	OFF	6 blinks	2 blinks	OFF
FAN3 error	OFF	6 blinks	3 blinks	OFF
FAN4 error	OFF	6 blinks	4 blinks	OFF
FAN5 error	OFF	6 blinks	5 blinks	OFF
FAN6 error	OFF	6 blinks	6 blinks	OFF
FAN7 error	OFF	6 blinks	7 blinks	OFF
FAN8 error	OFF	6 blinks	8 blinks	OFF
FAN9 error	OFF	6 blinks	9 blinks	OFF
FAN10 error	OFF	6 blinks	10 blinks	OFF
FAN11 error	OFF	6 blinks	11 blinks	OFF
FAN12 error	OFF	6 blinks	12 blinks	OFF
FAN13 error	OFF	6 blinks	13 blinks	OFF
1W MCU detects scaler stops working	OFF	2 blinks	OFF	OFF
Case Open	OFF	7 blinks	OFF	OFF
Lens Open	OFF	7 blinks	1 blinks	OFF
DMD error	OFF	8 blinks	OFF	OFF
Color wheel error	OFF	9 blinks	OFF	OFF
Phosphor wheel error	OFF	9 blinks	1 blinks	OFF
Laser Driver board Color wheel speed too low	OFF	4 blinks	2 blinks	OFF
Laser Driver board Phosphor wheel speed too low	OFF	4 blinks	3 blinks	OFF
Laser Driver board 54V error	OFF	4 blinks	4 blinks	OFF
Laser Driver board over temp	OFF	4 blinks	5 blinks	OFF
Laser Driver board SCI error	OFF	4 blinks	6 blinks	OFF
Laser Driver board initial fail	OFF	4 blinks	7 blinks	OFF

In the event of an error, please disconnect the AC power cord and wait for one (1) minute before restarting the projector. If the Power or Light source LEDs are still blinking or the Over Temp LED is lit, contact your service center.

Image Problems

Problem: No image appears on the screen

1. Verify the settings on your notebook or desktop PC.
2. Turn off all equipment and power up again in the correct order.

Problem: The image is blurred

1. Adjust the **Focus** on the projector.
2. Press the FOCUS+/FOCUS- button on the remote control or projector.
3. Ensure the projector-to-screen distance is within the specified range.
4. Check that the projector lens is clean.

Problem: The image is wider at the top or bottom (trapezoid effect)

1. Position the projector so it is as perpendicular to the screen as possible.
2. Use the ▲ ▼ ◀ ▶ button on the remote control or projector to correct the problem.

Problem: The image is reversed

Check the Projection setting on the Settings 1 menu of the OSD.

Problem: The image is streaked

1. Set the **Frequency** and **Tracking** settings on the **Image->Computer** menu of the OSD to the default settings.
2. To ensure the problem is not caused by a connected PC's video card, connect to another computer.

Problem: The image is flat with no contrast

Adjust the **Contrast** setting on the **Image** menu of the OSD.

Problem: The color of the projected image does not match the source image.

Adjust the **Color Temperature** and **Gamma** settings on the **Image->Advanced** menu of the OSD.

Light Source Problems

Problem: There is no light from the projector

1. Check that the power cable is securely connected.
2. Ensure the power source is good by testing with another electrical device.
3. Restart the projector in the correct order and check that the Power LED is on.

Remote Control Problems

Problem: The projector does not respond to the remote control

1. Direct the remote control towards remote sensor on the projector.
2. Ensure the path between remote and sensor is not obstructed.
3. Turn off any fluorescent lights in the room.
4. Check the battery polarity.
5. Replace the batteries.
6. Turn off other Infrared-enabled devices in the vicinity.
7. Have the remote control serviced.

Audio Problems

Problem: There is no sound

1. Adjust the volume on the remote control.
2. Adjust the volume of the audio source.
3. Check the audio cable connection.
4. Test the source audio output with other speakers.
5. Have the projector serviced.

Problem: The sound is distorted

1. Check the audio cable connection.
2. Test the source audio output with other speakers.
3. Have the projector serviced.

Having the Projector Serviced

If you are unable to solve the problem, you should have the projector serviced. Pack the projector in the original carton. Include a description of the problem and a checklist of the steps you took when trying to fix the problem: The information may be useful to service personnel. For servicing, return the projector to the place you purchased it.

HDMI Q & A

Q. What is the difference between a “Standard” HDMI cable and a “High-Speed” HDMI cable?

Recently, HDMI Licensing, LLC announced that cables would be tested as Standard or High-Speed cables.

• Standard (or “category 1”) HDMI cables have been tested to perform at speeds of 75Mhz or up to 2.25Gbps, which is the equivalent of a 720p/1080i signal.

• High Speed (or “category 2”) HDMI cables have been tested to perform at speeds of 340Mhz or up to 10.2Gbps, which is the highest bandwidth currently available over an HDMI cable and can successfully handle 1080p signals including those at increased color depths and/or increased refresh rates from the Source. High-Speed cables are also able to accommodate higher resolution displays, such as WQXGA cinema monitors (resolution of 2560 x 1600).

Q. How do I run HDMI cables longer than 10 meters?

There are many HDMI Adapters working on HDMI solutions that extend a cable’s effective distance from the typical 10 meter range to much longer lengths. These companies manufacture a variety of solutions that include active cables (active electronics built into cables that boost and extend the cable’s signal), repeaters, amplifiers as well as CAT5/6 and fiber solutions.

Q. How can I tell if a cable is an HDMI certified cable?

All HDMI products are required to be certified by the manufacturer as part of the HDMI Compliance Test Specification. However, there may be instances where cables bearing the HDMI logo are available but have not been properly tested. HDMI Licensing, LLC actively investigates these instances to ensure that the HDMI trademark is properly used in the market. We recommend that consumers buy their cables from a reputable source and a company that is trusted.

For more detail information check <http://www.hdmi.org/learningcenter/faq.aspx#49>

SPECIFICATIONS

Specifications

Model Name	DU6098Z	DU6198Z	DU6298Z
Display Type	0.67 WUXGA		
Resolution	WUXGA 1920x1200		
Keystone Correction	Vertical	±30° for ±30 steps	
	Horizontal	±30° for ±30 steps	
Projection Methods	Front, Rear, Desktop/Ceiling (Rear, Front)		
Data Compatibility	VGA, SVGA, XGA, SXGA, SXGA+, UXGA, WUXGA@60hz, Mac		
SDTV/EDTV/ HDTV	480i, 480p, 576i, 576p, 720p, 1080i, 1080p		
Video Compatibility	NTSC/ NTSC (M, 3.58/4.43 MHz), PAL (B,D,G,H,I,M,N), SECAM (B,D,G,K,K1,L)		
H-Sync	15.31 – 91.4kHz		
V-Sync	24 - 30Hz, 47 – 120 Hz		
Safety Certification	FCC-B, cUL, UL, CB, CE, CCC, KC, CU, BSMI and China CECP		
Environmental Operation Condition	0° ~ 40°C , 10~85%(No condensing)		
Environmental Storage Condition	-20° ~ 60°C, 5% to 95% (No condensation)		
Dimensions	580mm (W) x 500mm (D) x 211mm (H)		
AC Input	AC Universal 100 – 240, Typical @ 110VAC (100 – 240)/+/-10%		
Power Consumption	550W (Normal), 440W (Eco)	820W (Normal), 660W (Eco)	960W (Normal), 760W (Eco)
	<0.5W (Standby), <2W (on by Lan)		
Light Source	Laser Phosphor		
Input Terminals	VGA in x 1		
	DVI-D x 1		
	5 BNC (RGBHV) x 1		
	Mini-jack Stereo x 1		
	HDMI x 2		
	3D Sync in x 1 (3D VESA)		
	HDBaseT x 1 (100Mbps)		
Output Terminals	VGA x 1		
	Audio RCA (R/L) x 1		
	USB Type A for power support x 1		
	3D-Sync out x 1 (BNC)		

Control Terminals	RS-232 in x 1 (for serial in for control)
	RS-232 out x 1 (serial out for Pass thru Daisy Chain)
	RJ45 x 1 (10/100Mbps)
	Screen Trigger : DC Jack x 1 (DC12V 200mA output function)
	Wired Remote In x 1
	Wired Remote Out x 1
	USB Type B for service x 1
Security	Kensington Security Slot
	Security Bar

Lens	Throw Ratio	Zoom Ratio	Image Size (Diagonal)	Projection Distance
STD Lens (5050061100) VL906G/LNS-5SZ2	1.54~1.93	1.25	48.2~300"	2m~10m
Short Throw (5050063100) VL911G/LNS-5WZ2	0.77~1.1	1.42	42.3"~300"	1m~4.98m
Short Throw (5050063300) VL907G/LNS-5STZ	1.1~1.3	1.18	35.8" ~ 379.8"	1m~9m
Long Throw (5050063600) VL908G/LNS-5LZ3	1.93~2.9	1.5	32.1~481"	2.0m~20m
Semi Short Throw (5050063500) VL912G/LNS-5SZ12	1.25~1.60	1.28	39.1"~300"	1.35m~8.08m

Note: For questions regarding product specifications, please contact your local distributor.

Projection Distance vs. Projection Size

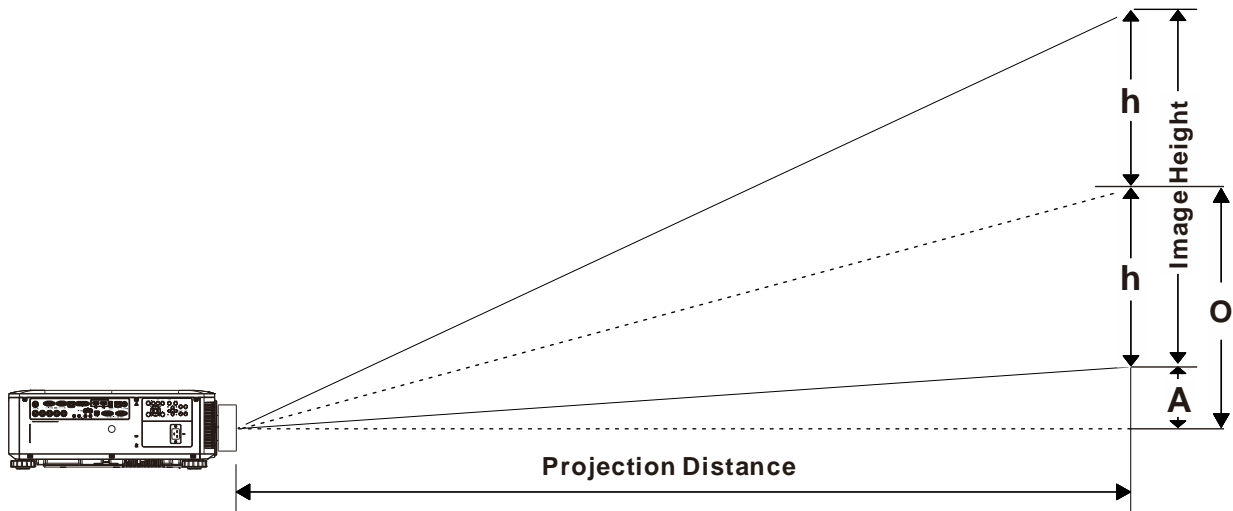

Projection Distance and Size Table

Short throw zoom projection lens: TR: 0.77~1.1; offset=55%

	TELE				WIDE			
Distance (m)	1.18	2.37	3.55	4.98	1.00	1.66	3.32	4.98
Diagonal (")	50	100	150	210	60	100	200	300
Image Width (mm)	1077	2154	3231	4523	1292	2154	4308	6462
Image Height (mm)	673	1346	2019	2827	808	1346	2692	4039
h (mm)	337	673	1010	1414	404	673	1346	2019
O(mm)	370	740	1111	1555	444	740	1481	2221
A (mm)	34	67	101	141	40	67	135	202

Semi Short throw projection lens: TR: 1.1 ~ 1.3; offset=55%

	TELE				WIDE			
Distance (m)	1.12	2.80	5.60	8.96	1.18	3.55	7.11	9.00
Diagonal (")	40	100	200	320	50	150	300	380
Image Width (mm)	862	2154	4308	6893	1077	3231	6462	8185
Image Height (mm)	538	1346	2692	4308	673	2019	4039	5116
h (mm)	269	673	1346	2154	337	1010	2019	2558
O (mm)	296	740	1481	2369	370	1111	2221	2814
A (mm)	27	67	135	215	34	101	202	256

Semi throw projection lens: TR: 1.25 ~ 1.6; offset=55%

	TELE				WIDE			
Distance (m)	1.38	3.45	5.17	7.93	1.35	2.69	5.38	8.08
Diagonal (")	40	100	150	230	50	100	200	300
Image Width (mm)	862	2154	3231	4954	1077	2154	4308	6462
Image Height (mm)	538	1346	2019	3096	673	1346	2692	4039
h (mm)	269	673	1010	1548	337	673	1346	2019
O(mm)	296	740	1111	1703	370	740	1481	2221
A (mm)	27	67	101	155	34	67	135	202

Semi throw projection lens: TR: 1.54 ~ 1.93; offset=55%

	TELE				WIDE			
Distance (m)	1.66	3.33	4.16	8.31	1.66	3.32	6.63	9.95
Diagonal (")	40	80	100	200	50	100	200	300(*)
Image Width (mm)	862	1723	2154	4308	1077	2154	4308	6462
Image Height (mm)	538	1077	1346	2692	673	1346	2692	4039
h (mm)	269	538	673	1346	337	673	1346	2019
O (mm)	296	592	740	1481	370	740	1481	2221
A (mm)	27	54	67	135	34	67	135	202

Note:
(*) Overdrive.

Long throw projection lens: TR: 1.93 ~ 2.9; offset=55%

	TELE				WIDE			
Distance (m)	2.5	6.25	12.49	18.74	2.08	6.24	12.47	18.71
Diagonal (")	40	100	200	300	50	150	300	450
Image Width (mm)	862	2154	4308	6462	1077	3231	6462	9693
Image Height (mm)	538	1346	2692	4039	673	2019	4039	6058
h (mm)	269	673	1346	2019	337	1010	2020	3029
O (mm)	296	740	1481	2221	370	1111	2222	3332
A (mm)	27	67	135	202	34	101	202	303

offset % = $O/(2 \times h) \times 100\%$
 $O=A+h$
 $h=(1/2) \times (\text{image height})$

Timing Mode Table

Table of Supported Frequency

The unit automatically determines PC signals to select the appropriate resolution. Some signals may require manual adjustment.

SIGNAL	RESOLUTION	H-SYNC (KHz)	V-SYNC (Hz)	COMPOSITE	COMPONENT	VGA/BNC (ANALOG)	DVI (DIGITAL)	HDMI (DIGITAL)	HDBASET (DIGITAL)
NTSC	—	15.734	60	○(3D:S)	—	—	—	—	—
PAL/SECAM	—	15.625	50	○	—	—	—	—	—
VESA	720 x 400	31.5	70.1	—	—	○	○	○	○
	640 x 480	31.5	60	—	—	○(3D:FS,TB,SBS)	○(3D:FS,TB,SBS)	○(3D:FS,TB,SBS)	○(3D:FS,TB,SBS)
	640 x 480	35	66.667	—	—	MAC13	MAC13	MAC13	MAC13
	640 x 480	37.86	72.8	—	—	—	○	○	○
	640 x 480	37.5	75	—	—	—	○	○	○
	640 x 480	43.3	85	—	—	—	○	○	○
	640 x 480	61.9	119.5	—	—	○(3D:FS)	○	○	○
	800 x 600	37.9	60.3	—	—	○(3D:FS,TB,SBS)	○(3D:FS,TB,SBS)	○(3D:FS,TB,SBS)	○(3D:FS,TB,SBS)
	800 x 600	46.9	75	—	—	—	○	○	○
	800 x 600	48.1	72.2	—	—	—	○	○	○
	800 x 600	53.7	85.1	—	—	—	○	○	○
	800 x 600	76.3	120	—	—	○(3D:FS)	○(3D:FS)	○(3D:FS)	○(3D:FS)
	832 x 624	49.722	74.546	—	—	MAC16	MAC16	MAC16	MAC16
	1024 x 768	48.4	60	—	—	○(3D:FS,TB,SBS)	○(3D:FS,TB,SBS)	○(3D:FS,TB,SBS)	○(3D:FS,TB,SBS)
	1024 x 768	56.5	70.1	—	—	—	○	○	○
	1024 x 768	60.241	75.02	—	—	MAC19	MAC19	MAC19	MAC19
	1024 x 768	60	75	—	—	—	○	○	○
	1024 x 768	68.7	85	—	—	—	○	○	○
	1024 x 768	97.6	120	—	—	○(3D:FS)	○(3D:FS)	○(3D:FS)	○(3D:FS)
	1152 x 870	68.68	75.06	—	—	MAC21	MAC21	MAC21	MAC21
	1280 x 720	45	60	—	—	○○(3D:FS,TB,SBS)	○(3D:FS,TB,SBS)	○(3D:FS,TB,SBS)	○(3D:FS,TB,SBS)
	1280 x 720	90	120	—	—	○(3D:FS)	○(3D:FS)	○(3D:FS)	○(3D:FS)
	1280 x 768 (Reduce Blanking)	47.4	60	—	—	○○(3D:FS,TB,SBS)	○(3D:FS,TB,SBS)	○(3D:FS,TB,SBS)	○(3D:FS,TB,SBS)
	1280 x 768	47.8	59.9	—	—	○○(3D:FS,TB,SBS)	○(3D:FS,TB,SBS)	○(3D:FS,TB,SBS)	○(3D:FS,TB,SBS)
	1280 x 800	49.7	59.8	—	—	○○(3D:FS,TB,SBS)	○(3D:FS,TB,SBS)	○(3D:FS,TB,SBS)	○(3D:FS,TB,SBS)
	1280 x 800	62.8	74.9	—	—	—	○	○	○
	1280 x 800	71.6	84.9	—	—	—	○	○	○
	1280 x 800	101.6	119.9	—	—	○(3D:FS)	○(3D:FS)	○(3D:FS)	○(3D:FS)
	1280 x 1024	64	60	—	—	○(3D:TB,SBS)	○(3D:TB,SBS)	○(3D:TB,SBS)	○(3D:TB,SBS)
	1280 x 1024	80	75	—	—	—	○	○	○
	1280 x 1024	91.1	85	—	—	—	○	○	○
	1280 x 960	60	60	—	—	○(3D:TB,SBS)	○(3D:TB,SBS)	○(3D:TB,SBS)	○(3D:TB,SBS)
	1280 x 960	85.9	85	—	—	—	○	○	○
	1400 x 1050	65.3	60	—	—	○(3D:TB,SBS)	○(3D:TB,SBS)	○(3D:TB,SBS)	○(3D:TB,SBS)
	1440 x 900	55.9	59.9	—	—	○(3D:TB,SBS)	○(3D:TB,SBS)	○(3D:TB,SBS)	○(3D:TB,SBS)
	1600 x 1200	75	60	—	—	○(3D:TB,SBS)	○(3D:TB,SBS)	○(3D:TB,SBS)	○(3D:TB,SBS)
	1680 x 1050 (Reduce Blanking)	64.67	59.88	—	—	○(3D:TB,SBS)	○(3D:TB,SBS)	○(3D:TB,SBS)	○(3D:TB,SBS)
	1680 x 1050	65.29	59.95	—	—	○(3D:TB,SBS)	○(3D:TB,SBS)	○(3D:TB,SBS)	○(3D:TB,SBS)
	1920 x 1080	67.5	60	—	—	—	○	○	○
	1920 x 1200 (Reduce Blanking)	74.038	59.95	—	—	○(3D:TB,SBS)	○(3D:TB,SBS)	○(3D:TB,SBS)	○(3D:TB,SBS)
	1600 x 1200	75	60	—	—	—	—	○	—
	1680 x 1050	64.7	59.9	—	—	—	—	○	—
1680 x 1050	65.3	60	—	—	—	—	○	—	
1920 x 1200	74.6	60	—	—	—	—	○	—	
3840 x 2160	53.946	23.976	—	—	—	—	○	○	
3840 x 2160	54	24	—	—	—	—	○	○	
3840 x 2160	56.25	25	—	—	—	—	○	○	
3840 x 2160	67.5	30	—	—	—	—	○	○	
3840 x 2160	112.5	50	—	—	—	—	○	○	
3840 x 2160	135	60	—	—	—	—	○	○	

DLP Projector—User's Manual

SIGNAL	RESOLUTION	H-SYNC (KHz)	V-SYNC (Hz)	COMPOSITE	COMPONENT	VGA/BNC (ANALOG)	DVI (DIGITAL)	HDMI (DIGITAL)	HDBASET (DIGITAL)
SDTV	480i	15.734	60	—	○	—	(3D:FS)	(3D:FS)	(3D:FS)
	576i	15.625	50	—	○	—	—	—	—
EDTV	576p	31.3	50	—	○	—	—	—	—
	480p	31.5	60	—	○	—	—	—	—
HDTV	720p	37.5	50	—	○	—	(3D:FP, TB)	(3D:FP, TB)	(3D:FP, TB)
	720p	45	60	—	○	—	(3D:FP, TB)	(3D:FP, TB)	(3D:FP, TB)
	1080i	33.8	60	—	○	—	(3D:SBS)	(3D:SBS)	(3D:SBS)
	1080i	28.1	50	—	○	—	(3D:SBS)	(3D:SBS)	(3D:SBS)
	1080p	27	24	—	○	—	(3D:FP, TB)	(3D:FP, TB)	(3D:FP, TB)
	1080p	28	25	—	○	—	—	—	—
	1080p	33.7	30	—	○	—	—	—	—
	1080p	56.3	50	—	○	—	—	—	—
	1080p	67.5	60	—	○	—	—	—	—

○ : Supported frequency

— : Not Supported frequency

FS=> Field Sequential

TB=> Top / Bottom

SBS=> Side-By-Side

FP=> Frame Packing

★The native resolution of the panel is 1280 x 800.

Resolution other than native resolution may be display with uneven size of text or line.

★The color of mean Displayable only. (4:3 only)

★The color of mean may have a little noise is acceptable

★HDTV timing main check tool is DVD player, VG828 is secondary

Table of Supported Frequency For 3D mode

The unit automatically determines PC signals to select the appropriate resolution. Some signals may require manual adjustment.

Input Signal for D-SUB/HDMI/DVI-D

SIGNAL	RESOLUTION	REFRESH RATE(Hz)
SVGA	800 X 600	60/120
XGA	1024 X 768	60/120
HDTV(720P)	1280 X 720	60/120
WXGA	1280 X 800	60/120

True 3D Video Compatibility table

Input Resolutions	HDMI 1.4a 3D Input	Input timing		
		1280 X 720P @ 50Hz	Top - and - Bottom	
		1280 X 720P @ 60Hz	Top - and - Bottom	
		1280 X 720P @ 50Hz	Frame packing	
		1280 X 720P @ 60Hz	Frame packing	
		1920 X 1080i @50 Hz	Side- by-Side (Half)	
		1920 X 1080i @60 Hz	Side- by-Side (Half)	
		1920 X 1080P @24 Hz	Top - and – Bottom	
		1920 X 1080P @24 Hz	Frame packing	
	HDMI 1.3	1920 x 1080i @ 50Hz 1920 x1080i @ 60Hz 1280 x 720P @50Hz 1280 x 720P @60Hz	Side-by-Side(Half)	SBS mode is on
		1920 x 1080i @ 50Hz 1920 x1080i @ 60Hz 1280 x 720P @50Hz 1280 x 720P @60Hz	Top-and-Bottom	TAB mode is on
		480i	HQFS	3D format is Frame sequential

Note:
3D glasses must be supported to 144Hz.

Projector Dimensions

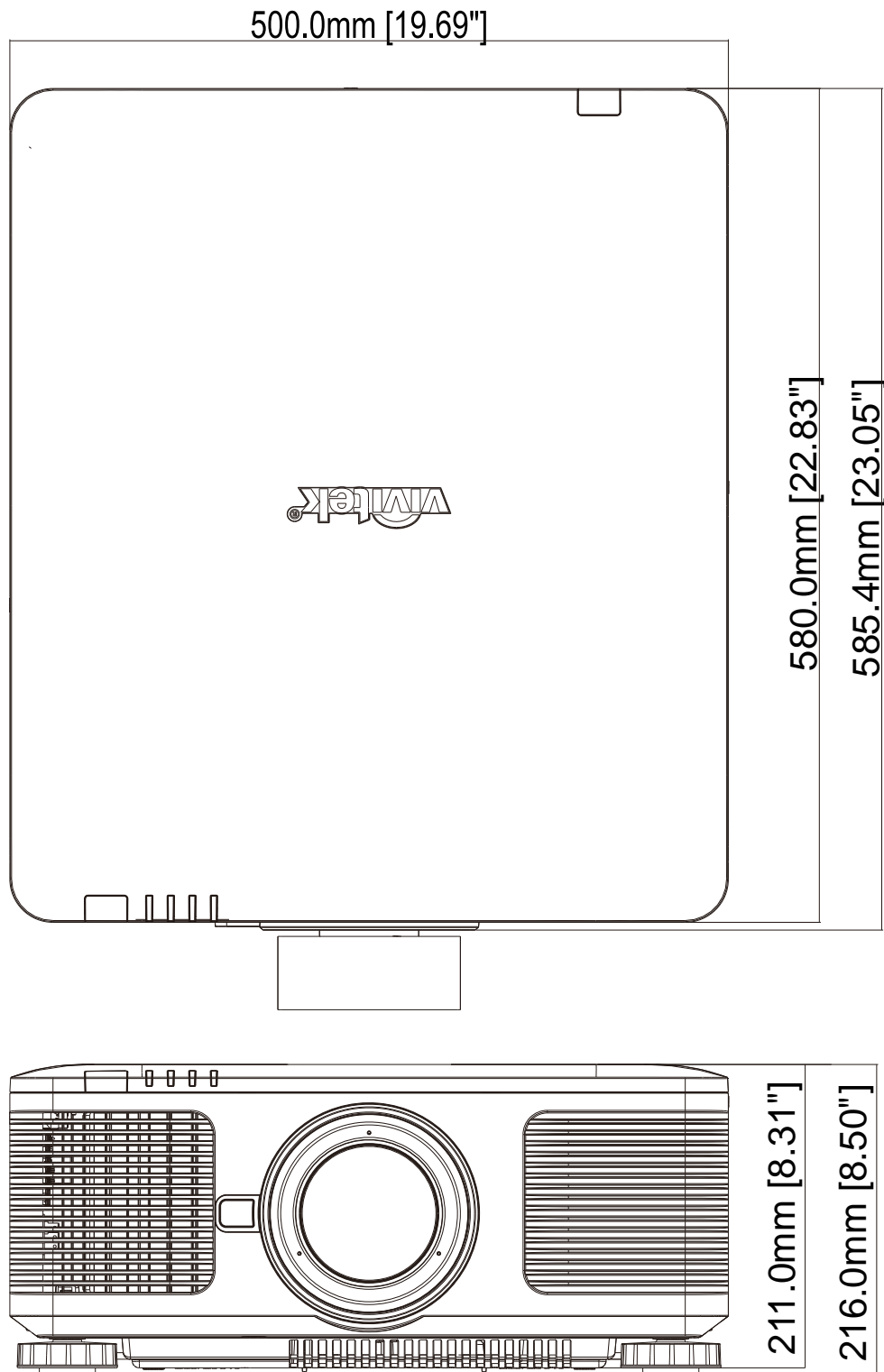

REGULATORY COMPLIANCE

FCC Warning

This equipment has been tested and found to comply with the limits for a Class B digital device pursuant to Part 15 of the FCC Rules. These limits are designed to provide reasonable protection against harmful interference when the equipment is operated in a commercial environment.

This equipment generates, uses, and can radiate radio frequency energy and, if not installed and used in accordance with the instruction manual, may cause harmful interference to radio communications. Operation of this equipment in a residential area is likely to cause harmful interference in which case the user will be required to correct the interference at his/her own expense.

Changes or modifications not expressly approved by the parties responsible for compliance could void the user's authority to operate the equipment.

Canada

This class B digital apparatus complies with Canadian ICES-003.

Safety Certifications

FCC-B, cUL, UL, CB, CE, CCC, KC, CU, BSMI and China CECP.

Communication parameter setup

You can use the serial control command to input commands for projector control or retrieve its operational data through Windows client terminal software

Item	Parameter:
Bit per Second	9600 bps
Data Bit	8-bit
Parity	None
Stop Bit	1
Flow Control	None

Operation commands

Operation command syntax

An operation command is prefixed by character "op", followed by control commands and settings separated by space blank [SP], and ended by carriage return pair "CR" and "ASCII hex 0D". Syntax of serial control commands:

op[SP]<operation command>[SP]<Setting Value>[CR]

op A constant indicating this is an operation command.

[SP] Indicate one blank space.

[CR] Indicate the command ending carriage return pair "CR" and "ASCII hex 0D".

Setting value Settings of operation command

Types of setup strings	Characters of settings	Description
Query current setup	?	Question mark "?" indicates querying current setup
Setup	= <settings>	Syntax: Symbol "=" suffixed with setup values
Increase setup order of adjustment items	+	Some settings are changed in steps. Symbol "+" indicates changing one step up
Decrease setup order of adjustment items	-	Some settings are changed in steps. Symbol "-" indicates changing one step down
Execute operation command	None	Certain operation commands execute after input without further setting or regulators.

Examples:

Control items	Input command row	Projector return message
Execute command	reset.all[CR]	RESET.ALL
Query current brightness	op bright ?[CR]	OP BRIGHT = 50
Set up brightness	op bright = 100[CR]	OP BRIGHT = 100
Brightness value + 1	op bright +[CR]	OP BRIGHT = "new value"
Brightness value - 1	op bright -[CR]	OP BRIGHT = "new value"
Out of range or not support	op bright = 200[CR]	OP BRIGHT = NA
Illegal command	op abright = 100[CR]	*Illegal format#

Note: When sending the multiple commands, make sure the return message of the last command is received before sending out the next one.

Function	Operation	Set	Get	Inc	Dec	EXE	Values
Auto Source	auto.src	V	V				0 = Off 1 = On
HDMI Color Space	color.space	V	V				0 : Auto 1 : RGB 2 : YUV
HDMI Range	hdmi.range	V	V				0 : Auto 1 : Full 2 : Limited
Video Saturation	video.saturation	V	V	V	V		0 ~ 100
Video Tint	video.tint	V	V	V	V		0 ~ 100
H Position	h.pos	V	V	V	V		-5 ~ +5 -100 ~ +100(Auto Sync Off)
V Position	v.pos	V	V	V	V		-5 ~ +5 -100 ~ +100(Auto Sync Off)
Phase	phase	V	V	V	V		0 ~ 31
clock	clock	V	V	V	V		-5 ~ +5
Auto Sync	auto.sync	V	V				0 : Off 1 : On
HDBaseT Control	hdbaset	V	V				0 : Off 1 : On
3D	threed	V	V				0 : Off 1 : DLP-Link 2 : IR
3D Sync Invert	threed.syncinvert	V	V				0 = Off 1 = On
3D Format	threed.format	V	V				0 : Frame Sequential 1 : Top / Bottom 2 : Side by side 3 : Frame Packing 4: Auto (FS Auto Detect)
3D Sync Out Delay	threed.syncdelay	V	V				0 ~ 359
3D Sync Input	threed.syncinput		V				0 : Internal 1 : External
3D Sync Output	threed.syncoutput	V	V				0 : Internal 1 : Bypass
Picture Mode	pic.mode	V	V				0:Presentation 1:Bright 2:Game 3:Movie 4: Vivid 5: Blending 6: sRGB 7:DICOM SIM 8:User 1 9: User 2 10: HDR
Brightness	bright	V	V	V	V		0 ~ 100
Contrast	contrast	V	V	V	V		0 ~ 100
HDR Control	hdr.control	V	V				0 : Off 1 : Auto 2 : On

Function	Operation	Set	Get	Inc	Dec	EXE	Values
HDR Mode	hdr.mode	V	V				0 : PQ-L300 1 : PQ-L400 2 : PQ-L500 3 : PQ-L600
Dynamic Black	dblack	V	V				0 = Off 1 = On
Projector Light (Light Off Timer)	projector.light	V	V				0 : Disable 1: 0.5 sec 2: 1 Sec 3: 2 Sec 4: 3 Sec 5: 4 Sec
HSG/Red Gain	hsg.r.gain	V	V	V	V		0 ~ 100
HSG/Green Gain	hsg.g.gain	V	V	V	V		0 ~ 100
HSG/Blue Gain	hsg.b.gain	V	V	V	V		0 ~ 100
HSG/Cyan Gain	hsg.c.gain	V	V	V	V		0 ~ 100
HSG/Magenta Gain	hsg.m.gain	V	V	V	V		0 ~ 100
HSG/Yellow Gain	hsg.y.gain	V	V	V	V		0 ~ 100
HSG/Red/Saturation	hsg.r.sat	V	V	V	V		0 ~ 100
HSG/Green/Saturation	hsg.g.sat	V	V	V	V		0 ~ 100
HSG/Blue/Saturation	hsg.b.sat	V	V	V	V		0 ~ 100
HSG/Cyan/Saturation	hsg.c.sat	V	V	V	V		0 ~ 100
HSG/Magenta/Saturation	hsg.m.sat	V	V	V	V		0 ~ 100
HSG/Yellow/Saturation	hsg.y.sat	V	V	V	V		0 ~ 100
HSG/Red/Hue	hsg.r.hue	V	V	V	V		0 ~ 100
HSG/Green/Hue	hsg.g.hue	V	V	V	V		0 ~ 100
HSG/Blue/Hue	hsg.b.hue	V	V	V	V		0 ~ 100
HSG/Cyan/Hue	hsg.c.hue	V	V	V	V		0 ~ 100
HSG/Magenta/Hue	hsg.m.hue	V	V	V	V		0 ~ 100
HSG/Yellow/Hue	hsg.y.hue	V	V	V	V		0 ~ 100
HSG/White/Red Gain	hsg.wr.gain	V	V	V	V		0 ~ 100
HSG/White/Green Gain	hsg.wg.gain	V	V	V	V		0 ~ 100
HSG/White/Blue Gain	hsg.wb.gain	V	V	V	V		0 ~ 100
Brilliant Color	bri.color	V	V	V	V		0 ~ 10
Sharpness	sharp	V	V	V	V		0 ~ 31
Gamma	gamma	V	V				0 = 1.8 1 = 2.0 2 = 2.2 3 = 2.4 4 = B&W 5 = Linear
Color Temperature	color.temp	V	V				0 = Warm 1 = Normal 2 = Cold
White Balance /Red Offset	red.offset	V	V	V	V		-100 ~ +100
White Balance /Green Offset	green.offset	V	V	V	V		-100 ~ +100
White Balance /Blue Offset	blue.offset	V	V	V	V		-100 ~ +100
White Balance /Red Gain	red.gain	V	V	V	V		0 ~ 200

Function	Operation	Set	Get	Inc	Dec	EXE	Values
White Balance /Green Gain	green.gain	V	V	V	V		0 ~ 200
White Balance /Blue Gain	blue.gain	V	V	V	V		0 ~ 200
Aspect Ratio	aspect	V	V				0 = Fill 1 = 4:3 2 = 16:9 3 = LetterBox 4 = Native 5 = 2.35:1
Digital Zoom	zoom	V	V	V	V		-10 ~ +10
V Keystone	v.keystone	V	V	V	V		-30 ~ +30
H Keystone	h.keystone	V	V	V	V		-30 ~ +30
H Image Shift	img.hshift	V	V	V	V		-50 ~ +50
V Image Shift	img.vshift	V	V	V	V		-50 ~ +50
4 Corner Top Left X	4corner.tlx	V	V	V	V		0 ~ +60
4 Corner Top Left Y	4corner.tly	V	V	V	V		0 ~ +60
4 Corner Top Right X	4corner.trx	V	V	V	V		0 ~ +60
4 Corner Top Right Y	4corner.try	V	V	V	V		0 ~ +60
4 Corner Bottom Left X	4corner.blx	V	V	V	V		0 ~ +60
4 Corner Bottom Left Y	4corner.bly	V	V	V	V		0 ~ +60
4 Corner Bottom Right X	4corner.brx	V	V	V	V		0 ~ +60
4 Corner Bottom Right y	4corner.bry	V	V	V	V		0 ~ +60
4 Corner Reset	4corner.reset					V	
Projection	projection	V	V				0 = Front 1 = Rear 2 = Ceiling 3 = Rear + Ceiling
Direct Power On (Auto power on)	direct.poweron	V	V				0 : Off 1 : On
Light Mode	light.mode	V	V				0: Normal (100%) 1: Eco (80%) 2: Eco Plus 3: Dimming 4: Extre Diming 5: Custom Light
Custom Light	custom.light	V	V	V	V		50 ~ 200
Fan Speed	fanspeed	V	V				0 = Normal 1 = High
IR Control	ir.control	V					0 : Both IR On 1 : Front IR On 2 : Rear IR On
Remote ID	remote.id	V	V				0 ~ 99
NetWork Status	net.status		V				0 : Disconnect 1 : Connected
NetWork / DHCP	net.dhcp	V	V				0 = Off 1 = On
NetWork / IP Address	net.ipaddr	V	V				<string>
NetWork / Subnet	net.subnet	V	V				<string>
NetWork / Gateway	net.gateway	V	V				<string>
NetWork / DNS	net.dns	V	V				<string>

Function	Operation	Set	Get	Inc	Dec	EXE	Values
NetWork Apply	net.apply	V					0 : Cancel 1 : OK
Standby Power	standby.power	V	V				1: On (0.5W) 2: On By Lan 3: On By HDBaseT
No Signal Power Off	nosignal.poweroff	V	V				0 ~ 36
Sleep Timer	sleep.timer	V	V				0 ~ 120
Volume	volume	V	V				0 ~ 10
Air Filter Hours	airfilter.hours		V				<string>
Air Filter Hour Reset	airfilter.reset					V	
Blank Screen Color	blankscreen.color	V	V				0 = Black 1 = Red 2 = Green 3 = Blue 4 = White
Logo	logo	V	V				0 = Std. 1 = Black 2 = Blue
MENU Position	menu.position	V	V				0 : Left 1 : Right 2 : Center 3 : Down 4 : Up
MENU Translucent	menu.trans	V	V				0 : Off 1 : 25% 2 : 50% 3: 75% 4: 100%
Keypad Lock	keypad.lock	V	V				0 : Off 1 : On
Security Lock	security.lock	V	V				1 : Up 2 : Down 3 : Left 4 : Right
Security Unlock	security.unlock	V					1 : Up 2 : Down 3 : Left 4 : Right

Function	Operation	Set	Get	Inc	Dec	EXE	Values
Language	lang	V	V				0 = English 1 = French 2 = German 3 = Spanish 4 = Portuguese 5 = Simplified Chinese 6 = Traditional Chinese 7 = Italian 8 = Norwegian 9 = Swedish 10 = Dutch 11 = Russian 12 = Polish 13 = Finnish 14 = Greek 15 = Korean 16 = Hungarian 17 = Czech 18 = Arabic 19 = Turkish 20 = Vietnamese 21 = Japanese 22 = Thai 23 = Farsi 24 = Hebrew 25 = Danish 26 = French Canadian
Reset All	reset.all					V	
Source Info	source.info		V				<string>
Light Hours 1	light1.hours		V				<string>
Light Hours 1 Reset	light1.reset					V	
Software Version	sw.ver		V				<string>
Serial Number	ser.no		V				<string>
Auto Image	auto.img					V	
Light 1 Status	light1.stat		V				0 = Off 1 = On
Model	model		V				<string>
Pixel Clock	pixel.clock		V				<string>
H Refresh Rate	h.refresh		V				<string>
V Refresh Rate	v.refresh		V				<string>
Blank	blank	V	V				0 = Off 1 = On
Power On	power.on					V	
Power Off	power.off					V	
Projector Status	status		V				0 : Reset 1 : Standby 2 : Active 3 : cooling 4: Warming 5: Power Up
Mute	mute	V	V				0 : Off 1 : On

Function	Operation	Set	Get	Inc	Dec	EXE	Values
Freeze	freeze	V	V				0 : Off 1 : On
Input Select	input.sel	V	V				1 :RGB 3: DVI 6: HDMI 1 7: BNC 9: HDMI 2 15: HDBaseT
Lens Lock	lens.lock	V	V				0: off, 1:on
Lens zoom in	zoom.in					V	
Lens zoom in 2	zoom.in.2					V	
Lens zoom in 3	zoom.in.3					V	
Lens zoom out	zoom.out					V	
Lens zoom out 2	zoom.out.2					V	
Lens zoom out 3	zoom.out.3					V	
Lens focus near	focus.near					V	
Lens focus near 2	focus.near.2					V	
Lens focus near 3	focus.near.3					V	
Lens focus far	focus.far					V	
Lens focus far 2	focus.far.2					V	
Lens focus far 3	focus.far.3					V	
Lens up	lens.up					V	
Lens up 2	lens.up.2					V	
Lens up 3	lens.up.3					V	
Lens down	lens.down					V	
Lens down 2	lens.down.2					V	
Lens down 3	lens.down.3					V	
Lens left	lens.left					V	
Lens left 2	lens.left.2					V	
Lens left 3	lens.left.3					V	
Lens right	lens.right					V	
Lens right 2	lens.right.2					V	
Lens right 3	lens.right.3					V	
Lens center	lens.center					V	
Lens type	lens.type	V	V				0 : non-UST
Lens load	lens.load	V					1 : UST
Lens save	lens.save	V					0 ~ 7
Lens clear	lens.clear	V					0 ~ 7