

SX-15G

Net Weight: 4.8kg(with stand)
4.4kg(w/o stand)

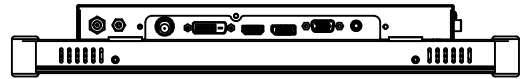
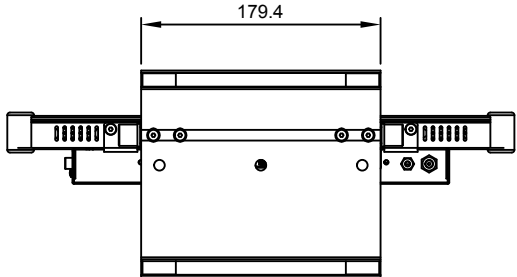
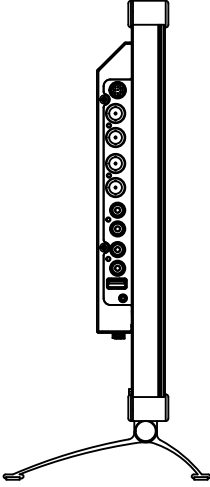
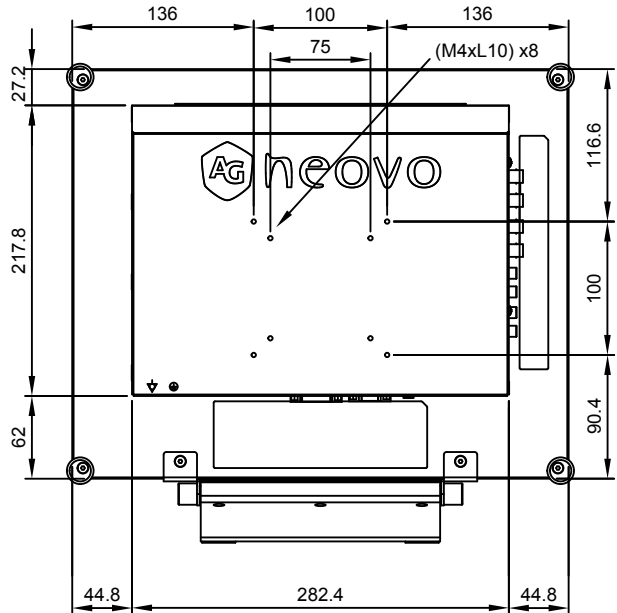
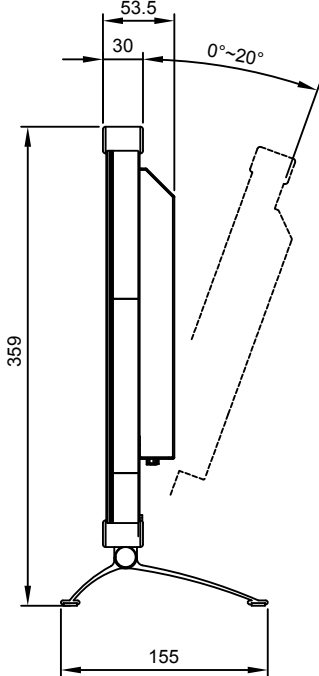
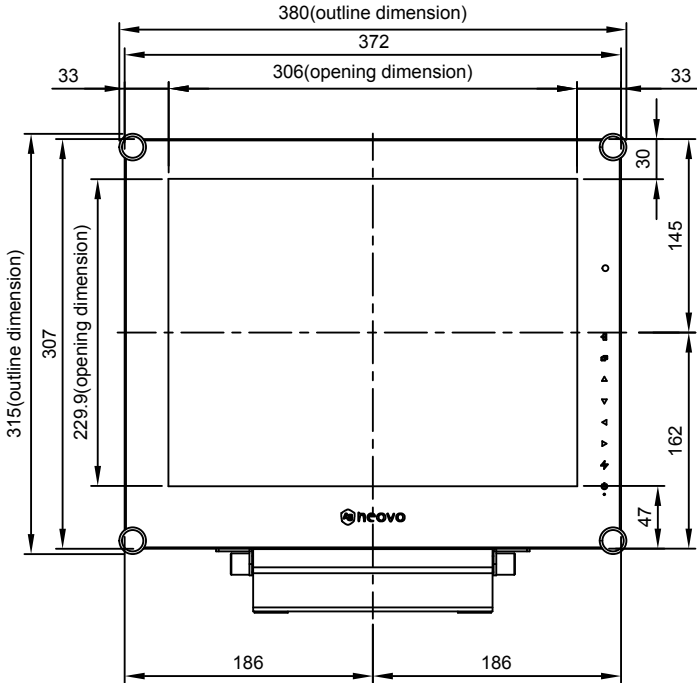
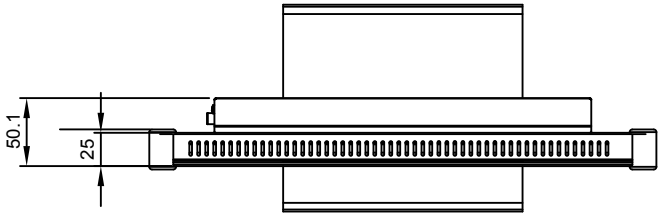

SPECIFICATIONS SUBJECT TO CHANGE WITHOUT NOTICE.

 www.agneovo.com	Model Name:
	SX-15G
<small>THIS DRAWING ON THIS PRINT AND INFORMATION BELONG WITH AG Neovo ANY REPRODUCTION IN PART OR WHOLE WITHOUT WRITTEN PERMISSION OF AG Neovo IS PROHIBITED.</small>	<small>P/C: SX5G00</small> <small>SCALE 1:1 UNITS mm v. 1.02</small>