

Projector

PA1004UL-W/PA1004UL-B PA804UL-W/PA804UL-B

User's Manual

Please visit our web site for User's Manual in the latest version.
https://www.sharp-nec-displays.com/dl/en/pj_manual/lineup.html

Model No. NP-PA1004UL-W/NP-PA1004UL-B/NP-PA804UL-W/NP-PA804UL-B
--

Table of Contents

Introduction	iv
Important Information	v
1. Check the product overview, supplied items and part names	1
1-1. Introduction to the Projector	1
1-2. What's in the Box?	4
1-3. Part Names of the Projector	6
1-4. Part Names of the Remote Control	10
2. Projecting an Image (Basic Operation)	16
2-1. Flow of Projecting an Image	16
2-2. Connecting Your Computer/Connecting the Power Cord	17
2-3. Turning on the Projector	20
2-4. Selecting a Source	23
2-5. Adjusting the Picture Size and Position	26
2-6. Adjusting a picture and sound	36
2-7. Turning off the Projector	37
2-8. After Use	38
3. Convenient Features	39
3-1. Turn off the light of the projector (LENS SHUTTER)	39
3-2. Turning Off the On-Screen Menu (On-Screen Mute)	39
3-3. Enlarging a Picture	40
3-4. Adjustment of luminance (brightness) and energy-saving effect	41
3-5. Correcting Horizontal and Vertical Keystone Distortion [CORNERSTONE]	45
3-6. Operation for the On-Screen Menu by a commercially available USB mouse	48
3-7. Preventing the Unauthorized Use of the Projector [SECURITY]	50
3-8. Projecting 3D videos	53
3-9. Controlling the Projector by Using an HTTP Browser	56
3-10. Storing Changes for Lens Shift, Zoom, and Focus [LENS MEMORY]	59

4. Multi-Screen Projection	66
4-1. Things that can be done using multi-screen projection	66
4-2. Using a single projector to project two types of videos at the same time [PIP/ PICTURE BY PICTURE]	67
4-3. Line up multiple projectors to display a high resolution image in a larger screen [TILING]	71
4-4. Adjust boundaries of a projected image [EDGE BLENDING]	74
5. Using On-Screen Menu	82
5-1. Using the Menus	82
5-2. Menu Elements	83
5-3. List of Menu Items	84
5-4. Menu Descriptions & Functions [INPUT]	92
5-5. Menu Descriptions & Functions [ADJUST]	96
5-6. Menu Descriptions & Functions [DISPLAY]	111
5-7. Menu Descriptions & Functions [SETUP]	123
5-8. Menu Descriptions & Functions [INFO.]	156
6. Connecting to Other Equipment	159
6-1. Connecting Your Computer	160
6-2. Connecting to a DVD player and other AV devices	164
6-3. Connecting to a HDBaseT transmission device (sold commercially)	166
6-4. Connecting several projectors	167
6-5. Connecting to a Wired LAN	168
7. Maintenance	169
7-1. Cleaning the Lens	169
7-2. Cleaning the Cabinet	170

8. Appendix	171
8-1. Throw distance and screen size	171
8-2. Compatible Input Signal List	177
8-3. Specifications	182
8-4. Cabinet Dimensions	186
8-5. Pin assignments and signal names of main connectors	187
8-6. Changing the Background Logo (Virtual Remote Tool)	190
8-7. Troubleshooting	191
8-8. PC Control Codes and Cable Connection	197
8-9. About the ASCII Control Command	199
8-10. List of Art-Net DMX parameters	201
8-11. Troubleshooting Check List	203
8-12. REGISTER YOUR PROJECTOR! (for residents in the United States, Canada, and Mexico)	205

Introduction

Thank you for purchasing the NEC projector.

This projector can be connected to computers, video devices, etc. to project images sharply onto a screen.

Please read this manual carefully before using your projector and keep the manual handy for future reference.

Read this user's manual if you have any doubts about operation or if you believe the projector may be faulty.

NOTES



- (1) The contents of this user's manual may not be reprinted in part or whole without permission.
- (2) The contents of this user's manual are subject to change without notice.
- (3) Great care has been taken in the preparation of this user's manual; however, should you notice any questionable points, errors or omissions, please contact us.
- (4) Notwithstanding article (3), NEC will not be responsible for any claims on loss of profit or other matters deemed to result from using the Projector.

Important Information









About the symbols

To ensure safe and proper use of the product, this manual uses a number of symbols to prevent injury to you and others as well as damage to property.

The symbols and their meanings are described below. Be sure to understand them thoroughly before reading this manual.





 WARNING	Failing to heed this symbol and handling the product erroneously could result in accidents leading to death or major injury.
 CAUTION	Failing to heed this symbol and handling the product erroneously could result in personal injury or damage to surrounding property.

Examples of symbols

	This symbol indicates you should be careful of electric shocks.
	This symbol indicates you should be careful of high temperatures.
	This symbol indicates something that must be prohibited.
	This symbol indicates something that must not be got wet.
	This symbol indicates you should not touch with wet hands.
	This symbol indicates something that must not be disassembled.
	This symbol indicates things you must do.
	This symbol indicates that the power cord should be unplugged from the power outlet.

Safety Cautions

WARNING

 <p>BE SURE TO DO</p>	<p>Installing the projector</p> <ul style="list-style-type: none"> This projector is an RG3 product. The projector is for professional use and must be installed in location where safety is assured. For this reason, be sure to consult your dealer as installation and attachment/detachment of the lens unit must be performed by a professional service personnel. Never try to install the projector by yourself. This may result in visual impairment etc.
 <p>BE SURE TO DO</p>  <p>PROHIBITION</p>  <p>HAZARDOUS VOLTAGE</p>	<p>Handling the power cord</p> <ul style="list-style-type: none"> Please use the power cord supplied with this projector. If the supplied power cord does not satisfy requirements of your country's safety standard, and voltage and current for your region, make sure to use the power cord that conforms to and satisfies them. <ul style="list-style-type: none"> The power cord you use must be approved by and comply with the safety standards of your country. Please refer to the page 184 about the power cord specification. For selecting an appropriate power cord, please check rated voltage for your region by yourself. The power cord included with this projector is exclusively for use with this projector. For safety, do not use it with other devices. Handle the power cord with care. Damaging the cord could lead to fire or electric shock. <ul style="list-style-type: none"> Do not place heavy objects on the cord. Do not place the cord under the projector. Do not cover the cord with a rug, etc. Do not scratch or modify the cord. Do not bend, twist or pull the cord with excessive force. Do not apply heat to the cord. <p>Should the cord be damaged (exposed core wires, broken wires, etc.), ask your dealer to replace it.</p> <ul style="list-style-type: none"> Do not touch the power plug should you hear thunder. Doing so could result in electric shock.

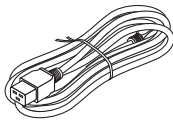

 **WARNING**

Installing the Projector



BE SURE TO DO

- This projector is designed to be used with a 100–240 V AC, 50/60 Hz power supply. Before using the projector, check that the power supply to which the projector is to be connected meets these requirements.
- Use a power outlet as the projector’s power supply. Do not connect the projector directly to electrical light wiring. Doing so is dangerous.
- When installing the projector at an angle, the separately sold option cover may be required for safety depending on the installation angle of the projector. (→ page xxv)



PROHIBITION

- Do not use in places such as those described below. Doing so could lead to fire or electric shock.
 - Shaky tables, inclined surfaces or other unstable places
 - Near heating appliances or places with heavy vibrations
 - Outdoors or humid or dusty places
 - Places exposed to oil smoke or steam
 - Near cooking appliances, humidifiers, etc.



DO NOT WET

- Do not use in places such as those described below where the projector could get wet. Doing so could lead to fire or electric shock.
 - Do not use in the rain or snow, on a seashore or waterfront, etc.
 - Do not use in a bathroom or shower room.
 - Do not place vases or potted plants on the projector.
 - Do not place cups, cosmetics or medicines on the projector.
 Should water, etc. get inside the projector, first turn off the projector’s power, then unplug the power cord from the power outlet and contact your dealer.



UNPLUG THE POWER CORD







- Do not insert or drop metal or combustible objects or other foreign materials into the projector from the vents. Doing so could lead to fire or electric shock. Be particularly careful if there are children in the home. Should a foreign object get inside the projector, first turn off the projector’s power, then unplug the power cord from the power outlet and contact your dealer.





UNPLUG THE POWER CORD





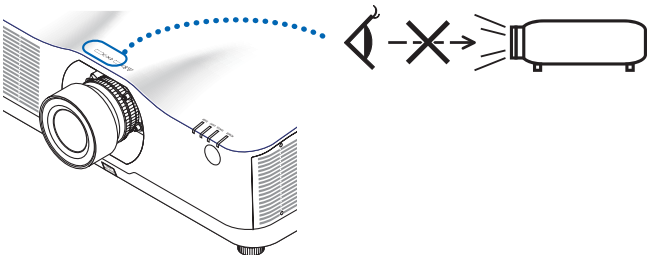

Unplug the power cord if the projector malfunctions.







- Should the projector emit smoke or strange odors or sounds, or if the projector has been dropped or the cabinet broken, turn off the projector’s power, then unplug the power cord from the power outlet. It may cause not only fire or electric shock but also serious damage to your eyesight or burns. Contact your dealer for repairs.
Never try to repair the projector on your own. Doing so is dangerous.





 WARNING	
 DO NOT DISASSEMBLE	<p>Do not disassemble the projector.</p> <ul style="list-style-type: none"> Do not remove or open the projector's cabinet. Also, do not modify the projector. There are high voltage areas in the projector. It may cause fire, electric shock, or laser light leakage, resulting in serious damage to your eyesight or burns. Have qualified service personnel perform inspection, adjustments and repairs of the interior.
 CAUTION	<p>Installing suspended from the ceiling</p> <ul style="list-style-type: none"> When installed suspended from the ceiling, etc. do not hang from the projector. The projector could drop and cause injury. When installing suspended from the ceiling, use a power outlet that is within reach so the power cord can be easily plugged and unplugged.
 PROHIBITION  CAUTION FOR HIGH TEMPERATURE	<p>Do not place objects in front of the lens while the projector is operating.</p> <ul style="list-style-type: none"> Do not leave the lens cap on the lens while the projector is operating. The lens cap could get hot and be warped. Do not place objects in front of the lens that obstruct the light while the projector is operating. The object could get hot and be broken or catch fire. The below pictogram indicated on the cabinet means the precaution for avoiding to place objects in front of the projector lens. <div style="text-align: center;">  </div>

⚠ WARNING

<p>PROHIBITION</p> 	<p>About the projector's light source</p> <ul style="list-style-type: none"> • No direct exposure to the beam shall be permitted, RG3 IEC/EN 62471-5:2015. Operators shall control access to the beam within the hazard distance and install the product at the height that will prevent exposures of spectators' eyes within the hazard distance. • Do not look into the projector's lens. Strong light that could damage your eyes is projected when the projector is operating. Be especially careful when children are around. • Do not look at the projected light using optical devices (magnifying glasses, reflectors, etc.). Doing so could result in vision impairment. • When turning on the power, operate from the side or rear of the projector (outside the hazard zone). Also, when turning on the power, make sure no one within the projection range is looking at the lens. • Do not allow children to operate the projector alone. When a child is operating the projector an adult should always be present and watch the child carefully. • The following graphic symbol indicating that looking into the projector is prohibited is displayed on top of the projector above the lens mounting unit. 
<p>PROHIBITION</p> 	<p>When cleaning the projector</p> <ul style="list-style-type: none"> • Do not use flammable gas sprays to remove dust from the lens, cabinet, etc. Doing so could lead to fire.
<p>PROHIBITION</p> 	<p>About option cover (separately sold)</p> <ul style="list-style-type: none"> • Do not put bundled cables in the option cover. Doing so may damage the power cord, resulting in a fire. • Do not hold the option cover while moving the projector or do not apply excessive force to the option cover. Doing so may damage the option cover, resulting in injury.

 CAUTION	
 BE SURE TO DO	<p>Connecting the power cord to earth</p> <ul style="list-style-type: none"> • This equipment is designed to be used in the condition of the power cord connected to earth. If the power cord is not connected to the earth, it may cause electric shock. Please make sure the power cord is earthed properly. Do not use a 2-core plug converter adapter.
 BE SURE TO DO  DO NOT TOUCH WITH WET HANDS  UNPLUG THE POWER CORD	<p>Handling the power cord</p> <ul style="list-style-type: none"> • When connecting the power cord to the projector's AC IN terminal, make sure the connector is fully and firmly inserted. Be sure to fix the power cord using the power cord stopper. Loose connection of the power cord could lead to fire or electric shock. • Do not connect or disconnect the power cord with wet hands. Doing so could result in electric shock. • When cleaning the projector, for safety purposes unplug the power cord from the power outlet beforehand. • When moving the projector, first be sure to turn off the power, unplug the power cord from the power outlet and check that all connection cables connecting the projector to other devices have been disconnected. • When planning not to use the projector for long periods of time, always unplug the power cord from the power outlet.
 PROHIBITION	<p>Do not use on networks subject to overvoltage.</p> <ul style="list-style-type: none"> • Connect the projector's Ethernet/HDBaseT port and LAN port to a network for which there is no risk of overvoltage being applied. Overvoltage applied to the Ethernet/HDBaseT or LAN port could result in electric shock.
 BE SURE TO DO	<p>Lens shift, focus and zoom operations</p> <ul style="list-style-type: none"> • When shifting the lens or adjusting the focus or zoom, do so from either behind or to the side of the projector. If adjustments are performed from the front, your eyes could be exposed to strong light and get injured. • Keep your hands away from the lens area when performing the lens shift operation. If not, your fingers could get caught in the gap between the cabinet and the lens.

 CAUTION	
 PROHIBITION	<p>Handling batteries</p> <ul style="list-style-type: none"> • Handle batteries with caution. Failure to do so could lead to fire, injury or contamination of the surroundings. <ul style="list-style-type: none"> - Do not short-circuit or take apart batteries or dispose of them in flames. - Do not use batteries other than those specified. - Do not use new batteries together with old ones. - When inserting batteries, pay attention to the polarities (+ and – directions), and be sure to insert them as indicated. • Contact your dealer or local authorities when disposing of batteries.
 PROHIBITION  CAUTION FOR HIGH TEMPERATURE	<p>About the vents</p> <ul style="list-style-type: none"> • Do not obstruct the projector's vents. Also, do not place such soft objects as paper or cloths underneath the projector. Doing so could lead to fire. Leave sufficient space between the place where the projector is installed and its surroundings. (→ page xxviii) • Do not touch the exhaust vent area while projecting or immediately after projecting images. The exhaust vent area may be hot at this time and touching it could cause burns.
 PROHIBITION	<p>Moving the projector</p> <ul style="list-style-type: none"> • For moving the projector, make sure you have at least two people. Attempting to move the projector alone could result in back pain or other injuries. • When moving the projector, do not hold the lens section. The focus ring could turn, causing the projector to drop and resulting in injury. Also, if you put your hand on the gap between the cabinet and the lens, the projector may be damaged, falling and causing injury. • When carrying the projector with the lens unit removed, do not touch the mounting area of the lens with your hands. Also, do not put your hand into the recess of the connection terminal. The projector could be damaged or fall down, resulting in injuries. • When moving the projector with the option cover attached, do not hold it by the option cover. The option cover could come lose and the main unit could fall down, causing injuries.
 BE SURE TO DO	<p>Inspecting the projector and cleaning the inside</p> <ul style="list-style-type: none"> • Consult with your dealer about once per year for cleaning of the inside of the projector. Dust could accumulate inside of the projector if it is not cleaned for extended periods of time, leading to fires or malfunction.

 CAUTION	
 BE SURE TO DO	<p>Attaching/detaching the lens</p> <ul style="list-style-type: none"> • Turn off the projector before attaching or detaching the lens unit. Failure to do so could result in visual impairment. Request your dealer to attach and detach the lens unit in the no entry area (HD).
 BE SURE TO DO	<p>Securing the lens unit with the fall prevention wire</p> <ul style="list-style-type: none"> • If the projector is going to be suspended from a ceiling or another high place, secure the lens unit using the fall prevention wire (sold separately). If the lens unit is not secured, it may fall down if it comes lose.
 BE SURE TO DO	<p>About viewing 3D pictures</p> <ul style="list-style-type: none"> • Before viewing, be sure to read health care precautions that may be found in the user's manual included with your 3D eyeglasses or your 3D compatible content such as Blu-ray Discs, video games, computer's video files and the like. • To avoid any adverse symptoms, heed the following: <ul style="list-style-type: none"> - Do not use 3D eyeglasses for viewing any material other than 3D images. - Allow a distance of 2 m/7 feet or greater between the screen and a user. Viewing 3D images from too close a distance can strain your eyes. - Avoid viewing 3D images for a prolonged period of time. Take a break of 15 minutes or longer after every hour of viewing. - If you or any member of your family has a history of light-sensitive seizures, consult a doctor before viewing 3D images. - While viewing 3D images, if you get sick such as nausea, dizziness, queasiness, headache, eyestrain, blurry vision, convulsions, and numbness, stop viewing them. If symptoms still persist, consult a doctor. • View 3D images from the front of the screen. Viewing from an angle may cause fatigue or eyestrain.

Laser Safety Caution

 **WARNING**

CLASS 1 LASER PRODUCT OF IEC 60825-1 THIRD EDITION

- The laser module is equipped in this product. Use of controls or adjustments of procedures other than those specified herein may result in hazardous radiation exposure.

 **WARNING**

RG3 PRODUCT OF IEC/EN 62471-5 FIRST EDITION

- No direct exposure to the beam shall be permitted, RG3 IEC/EN 62471-5:2015.
 - Operators shall control access to the beam within the hazard distance and install the product at the height that will prevent exposures of spectators' eyes within the hazard distance.
- This product is classified as Class 1 of IEC 60825-1 Third edition 2014-05 and RG3 of IEC/EN 62471-5 First edition.
Obey the laws and regulations of your country in relation to the installation and management of the device.
 - Outline of laser emitted from the built-in light module:
 - Wave length: 455 nm
 - Maximum power: 257 W (PA1004UL-W/PA1004UL-B), 229 W (PA804UL-W/PA804UL-B)
 - Radiation pattern from the protective housing:
 - Wave length: 455 nm
 - Maximum laser radiation output: 333 mW

Light Module

- A light module containing multiple laser diodes is equipped in the product as the light source.
- These laser diodes are sealed in the light module. No maintenance or service is required for the performance of the light module.
- End user is not allowed to replace the light module.
- Contact qualified distributor for light module replacement and further information.

Label Information

The caution and the explanatory labels are stuck on the below indicated positions.

Label 1

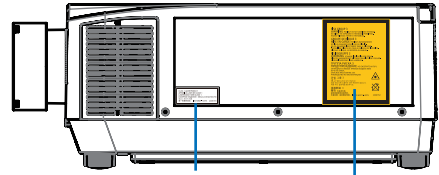

Label 1

Label 2

Label 2

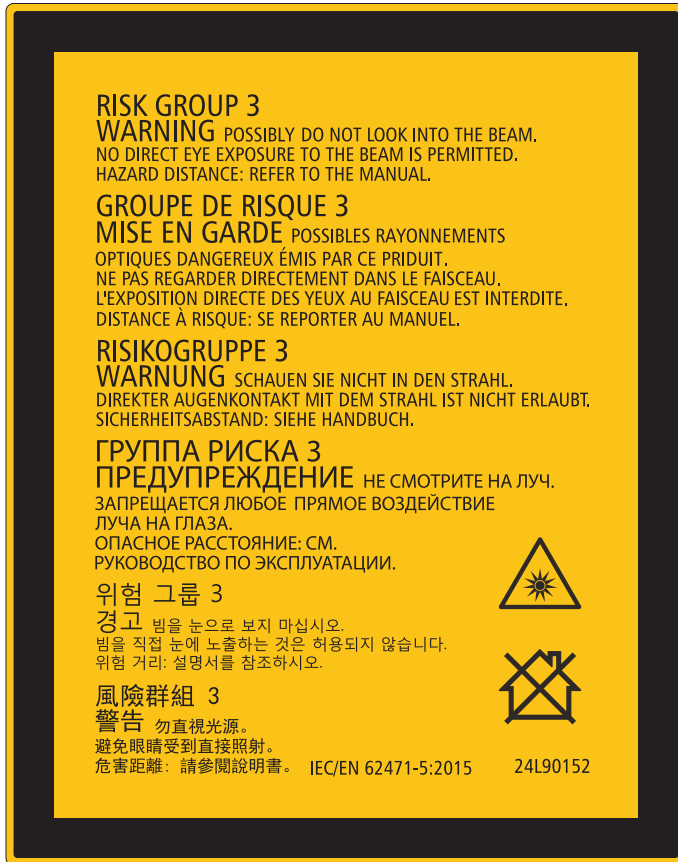

Laser light radiation range

The figure below shows the maximum radiation range of the laser light.

Horizontal angle (unit: degree)

Lens unit	Zoom	Lens position		
		Right most	Center (Reference value)	Left most
		HR	HC	HL
NP11FL		31.8	31.8	31.8
NP12ZL	Tele	27.4	18.0	27.4
	Wide	34.0	22.9	34.0
NP13ZL	Tele	15.1	9.6	15.1
	Wide	28.3	18.6	28.3
NP14ZL	Tele	9.6	6.0	9.6
	Wide	15.1	9.6	15.1
NP15ZL	Tele	6.4	4.0	6.4
	Wide	9.7	6.1	9.7
NP40ZL	Tele	31.7	23.8	31.7
	Wide	41.0	31.8	41.0
NP41ZL	Tele	13.0	9.4	13.0
	Wide	27.9	20.7	27.9
NP43ZL	Tele	6.8	4.9	6.8
	Wide	13.4	9.7	13.4

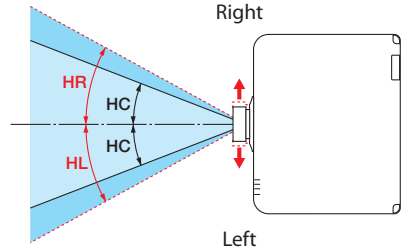

Vertical angle (unit: degree)

Lens unit	Zoom	Lens position		
		Upper most	Center (Reference value)	Lower most
		VU	VC	VD
NP11FL		21.2	21.2	21.2
NP12ZL	Tele	24.0	11.5	13.7
	Wide	30.1	14.8	17.6
NP13ZL	Tele	13.0	6.0	7.2
	Wide	24.8	11.9	14.1
NP14ZL	Tele	8.3	3.8	4.5
	Wide	13.1	6.0	7.2
NP15ZL	Tele	5.5	2.5	3.0
	Wide	8.4	3.8	4.6
NP40ZL	Tele	28.9	15.4	18.3
	Wide	37.8	21.2	24.9
NP41ZL	Tele	11.6	5.9	7.0
	Wide	25.3	13.3	15.8
NP43ZL	Tele	6.1	3.0	3.7
	Wide	12.0	6.1	7.3

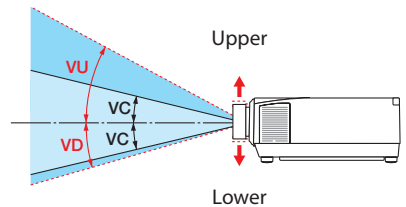

Horizontal angle (unit: degree)

Lens unit	Zoom	
	Tele	Wide
NP44ML	—	55.8

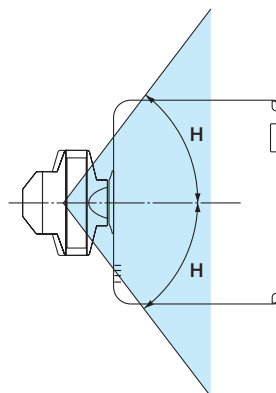

Vertical angle (unit: degree)

Lens unit	Zoom		
	Tele	V1	V2
NP44ML	—	10.7	24.6

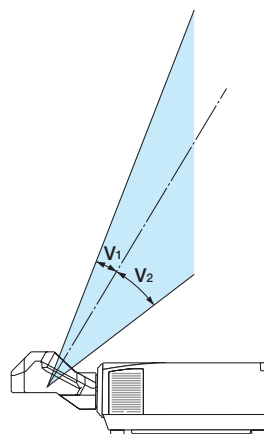

Hazard zone



- The below figure describes the radiation zone (hazard zone) of light emitted by the projector that is classified as Risk Group 3 (RG3) of IEC/EN 62471-5 First edition 2015.
- Observe the following precautions when installing the projector.
 - Install the projector to prevent the eyes of the spectators from being exposed to light in the hazard zone.
By providing a precautionary zone or physical barriers, it is possible to prevent human eyes from entering the hazard zone.
 - The manager of the projector (operator) must prevent spectators from entering the hazard zone.

About the hazard zone

Overhead view

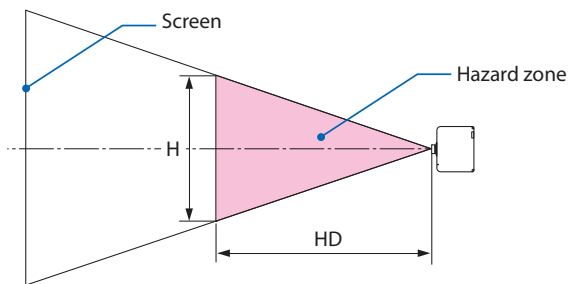

Side view

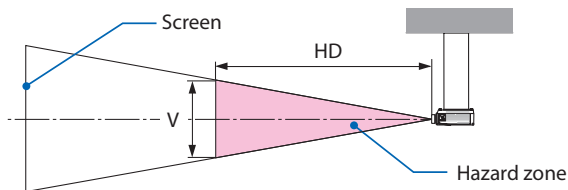

About the precautionary zone

When the manager of the projector (operator) cannot prevent spectators from entering the hazard zone such as in public facilities, it is recommended to secure a space of 1 m or more from the hazard zone as “the precautionary zone” for the safety of the spectators. When installing the projector overhead, it is recommended that the distance between the floor and the hazard zone be at least 3 m in the vertical direction.

**Applicable lens: NP11FL/NP12ZL/NP13ZL/NP14ZL/NP15ZL/NP40ZL/NP41ZL/
NP43ZL**

PA1004UL-W/PA1004UL-B

Lens		Hazard zone (m)		
		HD	H	V
NP11FL		0.3	0.41	0.26
NP12ZL	Wide	0.4	0.38	0.23
	Tele	0.5	0.35	0.22
NP13ZL	Wide	0.5	0.37	0.23
	Tele	1.5	0.52	0.33
NP14ZL	Wide	1.4	0.51	0.32
	Tele	2.5	0.55	0.35
NP15ZL	Wide	2.2	0.51	0.32
	Tele	3.1	0.46	0.29
NP40ZL	Wide	0.3	0.42	0.26
	Tele	0.5	0.48	0.30
NP41ZL	Wide	0.4	0.34	0.21
	Tele	1.5	0.51	0.32
NP43ZL	Wide	1.6	0.51	0.32
	Tele	2.9	0.47	0.30

PA804UL-W/PA804UL-B

Lens		Hazard zone (m)		
		HD	H	V
NP11FL		0.2	0.29	0.18
NP12ZL	Wide	0.2	0.21	0.13
	Tele	0.3	0.22	0.14
NP13ZL	Wide	0.3	0.24	0.15
	Tele	1.3	0.45	0.28
NP14ZL	Wide	1.1	0.41	0.26
	Tele	2.1	0.47	0.29
NP15ZL	Wide	1.8	0.43	0.27
	Tele	2.5	0.38	0.24
NP40ZL	Wide	0.2	0.30	0.19
	Tele	0.4	0.39	0.24
NP41ZL	Wide	0.3	0.26	0.16
	Tele	1.2	0.41	0.26
NP43ZL	Wide	1.3	0.43	0.27
	Tele	2.4	0.39	0.24

Applicable lens: NP44ML

PA1004UL-W/PA1004UL-B

Lens	Hazard zone (m)		
	HD	H	V
NP44ML	0.2	0.69	0.43

PA804UL-W/PA804UL-B

Lens	Hazard zone (m)		
	HD	H	V
NP44ML	0.2	0.69	0.43

**Installation example considering the precautionary zone
(For lens units other than NP44ML)**

① Floor or desktop installation example

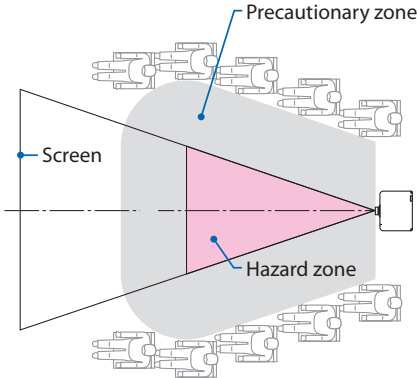

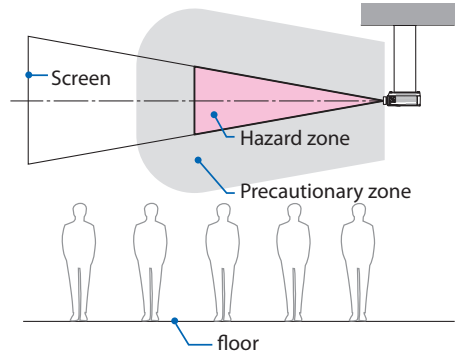

② Ceiling installation example

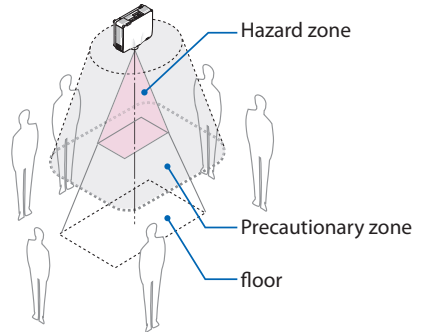
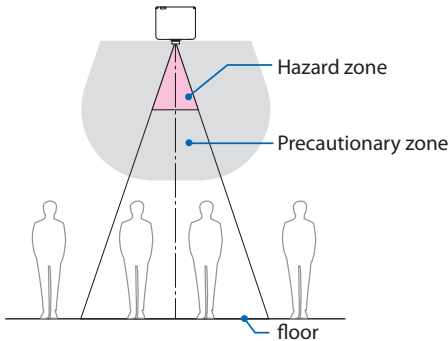

 CAUTION	<p>If it is expected that spectators will intrude into the hazard zone when installed on the ceiling (for example, if the distance between the floor and the precautionary zone is 2 m or less), it is necessary to prevent spectators from entering that area.</p>
--	---

③ Example of downward projection installed on the ceiling



 CAUTION	<p>If the precautionary zone between the floor and the hazard zone cannot be secured, it is necessary to prevent spectators from entering the area around the screen as shown in the figure on the right.</p>
--	---

* If using lens shift, please consider the shift of projected image according to the volume of lens shift. Installation example considering the precautionary zone (For lens units other than NP44ML)

**Installation example considering the precautionary zone
(For NP44ML)**

① Floor or desktop installation example

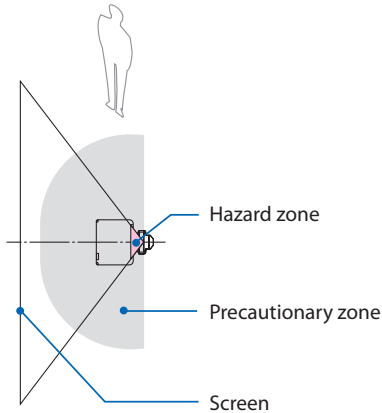

② Ceiling installation example

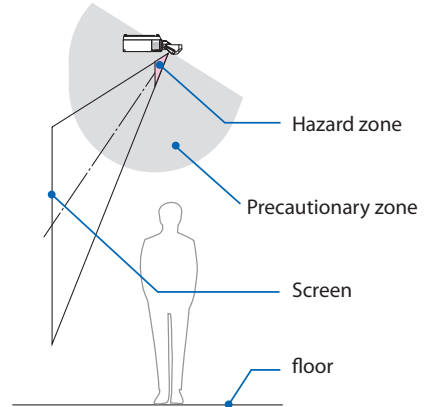

CAUTION

When installing the NP44ML, there is a risk of intrusion into the hazard zone and the precautionary zone when operating the buttons on the projector. For safety, it is recommended to use the remote control.



CAUTION

If the precautionary zone cannot be secured between the floor and the hazard zone, spectators must be restricted from entering the space between the projector and screen.

* The above figure is an example of a typical installation. It is also necessary to secure the precautionary zone when installing the projector at an angle.



Please follow all safety precautions.

Installing the projector

- This projector is an RG3 product. The projector is for professional use and must be installed in a location where safety is assured. For this reason, be sure to consult your dealer as installation and attachment/detachment of the lens unit must be performed by a professional service personnel. Never try to install the projector by yourself. This may result in visual impairment, etc.
- When planning the layout of the projector, make sure to follow the safety measures listed in the installation manual.
- In order to avoid danger, either install the device within easy reach of a wall outlet or provide a device like a breaker to disconnect power to the projector in emergency.
- Take safety measures to prevent human eyes from entering the hazard zone.
- Select an appropriate lens for the installation location and secure the safety zone set for each lens.

Ensure that appropriate safety measures have been taken when operating the projector, adjusting the light, etc.

- Check whether the appropriate safety zone for the installed lens has been adequately secured. Periodically check the zone and maintain a record of verifications.
- Educate the manager of the projector (operator) about safety before operating the projector.

Using the projector

- Instruct the manager of the projector (operator) to perform inspections (Including safety checks on light emitted by the projector) before powering the projector on.
- Instruct the manager of the projector (operator) to be able to control the projector whenever the projector is powered on in case of an emergency.
- Instruct the manager of the projector (operator) to keep the installation manual, user's manual and inspection records in an easy-to-reach place.
- Instruct them to determine whether the projector conforms to the standards of each country and region.

Cable information

Use shielded cables or cables attached ferrite cores so as not to interfere with radio and television reception.

For details, please refer to “5. Making Connections” in this user’s manual.

Notice Concerning Electromagnetic Interference (EMI)

WARNING:

Operation of this equipment in a residential environment could cause radio interference.

Disposing of your used product



In the European Union

EU-wide legislation as implemented in each Member State requires that used electrical and electronic products carrying the mark (left) must be disposed of separately from normal household waste. This includes projectors and their electrical accessories. When you dispose of such products, please follow the guidance of your local authority and/or ask the shop where you purchased the product.

After collecting the used products, they are reused and recycled in a proper way. This effort will help us reduce the wastes as well as the negative impact to the human health and the environment at the minimum level.

The mark on the electrical and electronic products only applies to the current European Union Member States.

Outside the European Union

If you wish to dispose of used electrical and electronic products outside the European union, please contact your local authority and ask for the correct method of disposal.



For EU: The crossed-out wheeled bin implies that used batteries should not be put to the general household waste! There is a separate collection system for used batteries, to allow proper treatment and recycling in accordance with legislation.

According the EU directive 2006/66/EC, the battery can't be disposed improperly. The battery shall be separated to collect by local service.

(for Germany only)

Machine Noise Information Regulation - 3. GPSGV,

The highest sound pressure level is less than 70 dB (A) in accordance with EN ISO 7779.

Information of the AUDIO OUT mini jack

The AUDIO OUT mini jack does not support earphone/headphone terminal.

Cautions for ensuring the projector's performance

- Do not install in places subject to vibrations or shocks.
If installed in places where the vibrations from power sources and the like are conveyed, or in vehicles or on vessels, etc. the projector could be affected by vibrations or shocks that may damage internal parts and lead to malfunction.
Install in a place not subject to vibrations or shocks.
- Do not install near high voltage power lines or power sources.
The projector may be affected by interference if it is installed near a high voltage power line or a power source.
- Do not install or store in such places as those described below. Doing so could lead to malfunction.
 - Places where strong magnetic fields are generated
 - Places where corrosive gases are generated
- If intense light like laser beams enters from the lens, it could lead to malfunction.
- Consult your dealer before using in places where much cigarette smoke or dust is present.
- Select [HIGH] in [FAN MODE] if you continue to use the projector for consecutive days.
- When the same still image is projected for a long period of time with a computer, etc. the pattern of the image may remain on the screen after the projection is stopped, but it will disappear after a while. This happens due to the properties of liquid crystal panels, and is not a malfunction. We recommend using a screensaver on the computer side.
- When using the projector at altitudes of about 5500 feet/1700 meters or higher, be sure to set the [FAN MODE] to [HIGH ALTITUDE]. If not, the inside of the projector may get hot, leading to malfunction.
- When the projector is used at high altitudes (places where the atmospheric pressure is low), it may be necessary to replace the optical parts sooner than usual.
- About moving the projector
 - Request your dealer to detach the lens unit once, and be sure to attach the lens cap so as not to scratch the lens. Also, attach a dust protective cap to the projector.
 - Do not subject the projector to vibrations or strong shocks.
The projector could be damaged otherwise.
- Do not use the tilt feet for purposes other than adjusting the projector's tilt.
Improper handling, such as carrying the projector by the tilt feet or using it leaned against a wall, could lead to malfunction.
- Do not touch the surface of the projection lens with bare hands.
Fingerprints or dirt on the surface of the projection lens will be enlarged and projected on the screen. Do not touch the surface of the projection lens.
- Do not unplug the power cord from the projector or the power outlet while projecting. Doing so could cause deterioration of the projector's AC IN terminal or power plug contact. To interrupt the AC power supply while images are being projected, use a power strip switch, a breaker, etc.
- About handling of the remote control
 - The remote control will not work if the projector's remote signal sensor or the remote control's signal transmitter is exposed to strong light or if there are obstacles between them that obstruct the signals.
 - Operate the remote control from within 20 meters from the projector, pointing it at the projector's remote signal sensor.
 - Do not drop the remote control or handle it improperly.

- Do not let water or other liquids get on the remote control. Should the remote control get wet, wipe it off immediately.
- Avoid using in hot and humid places as far as possible.
- When planning not to use the remote control for long periods of time, remove both batteries.
- Take measures to prevent external light from shining on the screen. Make sure only the light from the projector shines on the screen. The less external light on the screen, the higher the contrast and the more beautiful the images.
- About screens
Images will not be clear if there is dirt, scratches, discoloration, etc. on your screen. Handle the screen with care, protecting it from volatile substances, scratches and dirt.

Precautions when installing the projector at an angle

This projector can be installed universally in every angle. When installing the projector at the angles shown below, the separately sold option cover is required to be attached to the projector. Be sure to ask your dealer to attach the option cover.



WARNING

- For safety reasons, be sure to attach the option cover.
- Be sure to attach the option cover to the projector when the projector's power is turned on. This may result in fire.

Model name of option cover

NP13CV-W for PA1004UL-W/PA804UL-W
NP13CV-B for PA1004UL-B/PA804UL-B

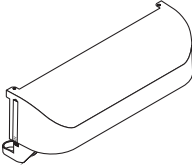
Two covers are packaged with the option cover NP13CV-W and NP13CV-B.

Option cover A: for attaching to the connection terminal area	
Option cover B: for attaching to the exhaust vent	

The drawings below show the installation angle required to attach the option cover A and B respectively.

- Both option cover A and B may need to be attached depending on the installation position of the projector.
- Whether the option cover needs to be attached in the current installation position can be checked on the [INFO.] screen of the on-screen menu (→ pages 157, 158).

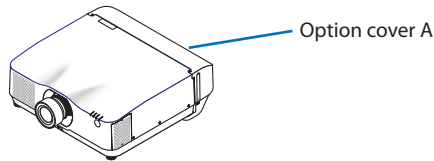
Installation angles required to attach the option cover A

In the direction of back and forth

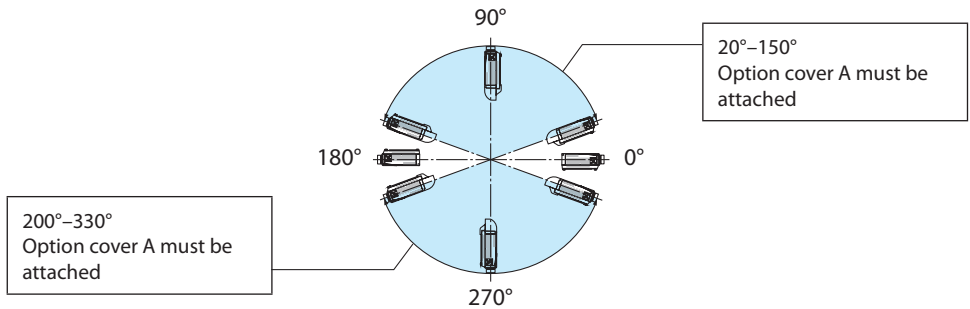

In the direction of left and right

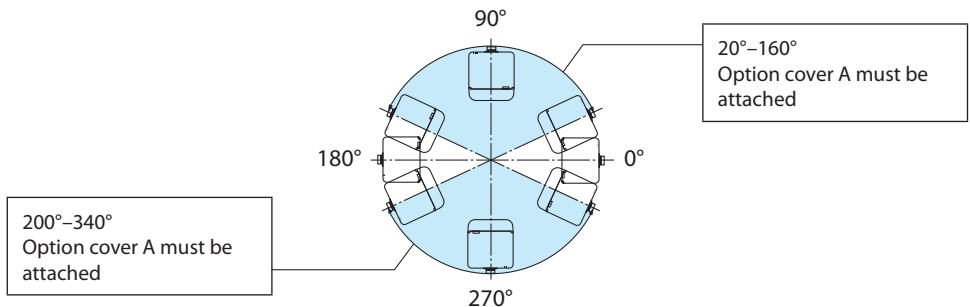
**NOTE:**

- The drawings show the image of installation angle as a reference. They are slightly different from the actual one.

Installation angles required to attach the option cover B

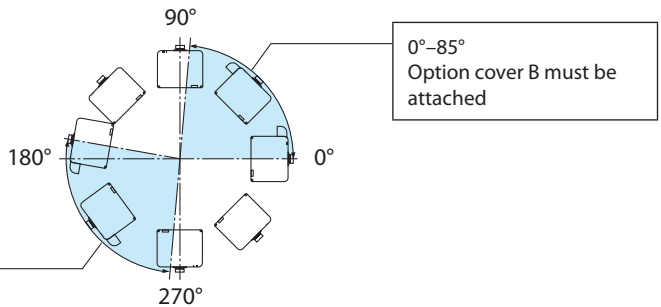
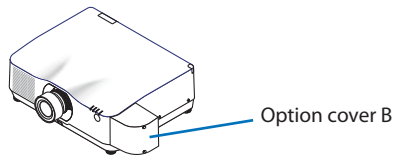

NOTE:

- The drawings show the image of installation angle as a reference. They are slightly different from the actual one.

Clearance for Installing the Projector

- When installing the projector, keep sufficient space around it, as described below. If not, the hot exhaust emitted from the projector may be taken back in. Also, make sure no wind from an air-conditioner hits the projector. The projector's heat control system may detect an abnormality (temperature error) and automatically shut off the power.

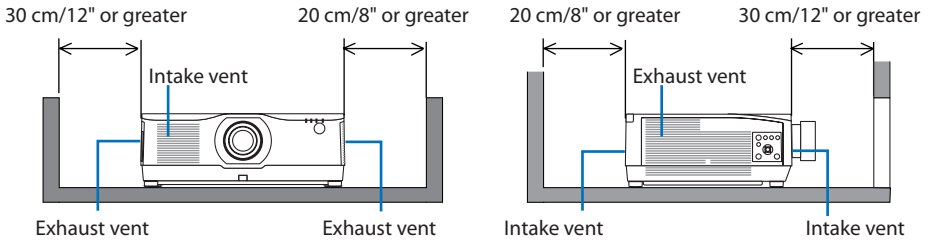

NOTE:

- In the above figure, it is assumed that there is sufficient space above the projector.
- When using multiple projectors together for multi-screen projection, provide sufficient space around the projectors for air intake and exhaust. When the intake and exhaust vents are obstructed, the temperature inside the projector will rise and this may result in a malfunction.

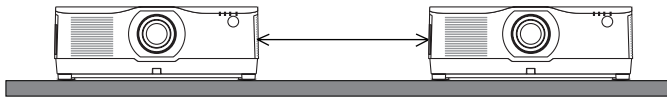

Precautions for Ceiling Installation

Do not install the projector in the following places. Attached substances such as oil, chemicals and moisture may cause deformation or cracks of the cabinet, corrosion of the metal parts, or malfunction.

- Outdoors and places with humid or dust
- Places exposed to oil smoke or steam
- Places where corrosive gases are generated

About Copyright of original projected pictures:

Please note that using this projector for the purpose of commercial gain or the attraction of public attention in a venue such as a coffee shop or hotel and employing compression or expansion of the screen image with the following functions may raise concern about the infringement of copyrights which are protected by copyright law.

[ASPECT RATIO], [KEystone], Magnifying feature and other similar features.

[AUTO POWER OFF] Function

The factory default setting for [AUTO POWER OFF] is 15 minutes. If no input signal is received and no operation is performed on the projector during 15 minutes, the projector is automatically powered off for saving the power consumption. In order to control the projector by an external device, set the [AUTO POWER OFF] to [OFF]. Please refer page 154 for details.

Trademarks

- NaViSet, ProAssist, and Virtual Remote are trademarks or registered trademarks of Sharp NEC Display Solutions, Ltd. in Japan, in the United State and other countries.
- Apple, Mac, iMac, and MacBook are trademarks of Apple Inc. registered in the U.S. and other countries.
- Microsoft, Windows, and PowerPoint are either a registered trademark or trademark of Microsoft Corporation in the United States and/or other countries.
- The terms HDMI and HDMI High-Definition Multimedia Interface, and the HDMI Logo are trademarks or registered trademarks of HDMI Licensing Administrator, Inc. in the United States and other countries.



- DisplayPort and DisplayPort Compliance Logo are trademarks owned by the Video Electronics Standards Association.



- HDBaseT™ is a trademark of HDBaseT Alliance.



- Trademark PJLink is a trademark applied for trademark rights in Japan, the United States of America and other countries and areas.
- Blu-ray is a trademark of Blu-ray Disc Association.
- CRESTRON and CRESTRON ROOMVIEW are trademarks or registered trademarks of Crestron Electronics, Inc. in the United States and other countries.
- Extron and XTP are registered trademarks of RGB Systems, Inc. in the United States.
- Ethernet is either a registered trademark or trademark of Fuji Xerox Co., Ltd.
- Art-Net is an Ethernet protocol invented by Artistic Licence.
Art-Net™ Designed by and Copyright Artistic Licence Holdings Ltd.
- Other product and company names mentioned in this user's manual may be the trademarks or registered trademarks of their respective holders.
- Virtual Remote Tool uses WinI2C/DDC library, © Nicomsoft Ltd.

1. Check the product overview, supplied items and part names

1-1. Introduction to the Projector

This section introduces you to your new projector and describes the features and controls.

General

- **Liquid crystal type high brightness/high resolution projector**

This projector has a display resolution of 1920 dots × 1200 lines (WUXGA) and an aspect ratio of 16:10. Select [BOOST] under [REF. LIGHT MODE] for a brighter screen.

Model	Brightness
PA1004UL-W/PA1004UL-B	NORMAL: 9000 lm BOOST: 10000 lm
PA804UL-W/PA804UL-B	NORMAL: 7500 lm BOOST: 8200 lm

When [BOOST] is selected, the cooling fan noise increases. The life of the optical components may also be shortened depending on the operating environment.

- **A proprietary sealed structure that achieves highly dust-proof performance**

Due to its excellent dust-proof performance, the projector is not equipped with a filter. Filter replacement is therefore unnecessary.

- **Silent design utilizing a sealed structure**

A silent design with no irritating fan noise even in a quiet conference room or classroom.

Light source • Brightness

- **A long-life laser diode is equipped in the light module**

The product can be operated at low cost because the laser light source can be used for a long time without requiring replacement or maintenance.

- **Brightness can be adjusted within a wide range**

Unlike with ordinary light sources, the brightness can be adjusted from 50 to 100% in 1% increments.

- **[CONSTANT BRIGHTNESS] mode**

Brightness normally decreases with use, but by selecting [CONSTANT BRIGHTNESS] mode, sensors inside the projector detect and automatically adjust the output, thereby maintaining constant brightness throughout the life of the light module.

However, if brightness output is set at the maximum, brightness will decrease with use.

Installation

- **Wide range of optional lenses selectable according to the place of installation**

This projector supports 9 types of optional lenses, providing a selection of lenses adapted to a variety of places of installation and projection methods.

Note that no lens is mounted upon shipment from the factory. Please purchase optional lenses separately.

1. Check the product overview, supplied items and part names

- **360 degree free projection**

This projector can be installed universally in every angle.

Note, however, that the separately sold option cover is required to be attached to the projector depending on the installation angle of the projector.

For controlling fine inclination, use the tilt foot. Install an appropriate metal and a stand that has enough strength to support the projector for controlling the installation angle.

Videos

- **Wide range of input/output terminals (HDMI, DisplayPort, HDBaseT, etc.)**

The projector is equipped with a variety of input/output terminals: HDMI (input × 2), DisplayPort, HDBaseT (input × 1, output × 1), computer (analog), etc.

The projector's HDMI input, DisplayPort input terminals and HDBaseT Ports support HDCP.

HDMI and HDBaseT support HDCP 2.2/1.4

DisplayPort supports HDCP 1.3

- **Simultaneous display of 2 images (PIP/PICTURE BY PICTURE)**

Two images can be projected simultaneously with a single projector.

There are two types of layouts for the two images: [PIP] in which a sub-picture is displayed on the main picture, and [PICTURE BY PICTURE] in which the main and sub pictures are displayed next to each other.

- **Multi-screen projection using multiple projectors**

This projector equips the HDBaseT IN/Ethernet and HDBaseT OUT/Ethernet ports. Multiple projectors in same brightness up to four units can be connected in a daisy chain by a LAN* cable via these terminals. A high quality picture is achieved by dividing and projecting high resolution videos among the various projectors.

Furthermore, the boundaries of the screens are smoothed using an edge blending function.

* Use a commercially available CAT 5e STP cable or one in a higher specification.

- **Seamless switch function for smoother screen changes when switching the signal**

When the input connector is switched, the image displayed before switching is held so that that the new image can be switched to without a break due to absence of a signal.

- **Supports HDMI 3D format**

This projector can be used to watch videos in 3D using commercially-available active shutter-type 3D eyewear and 3D emitters that support XPANDVISION 3D.

Network

- **Supports wired LAN**

Equips the LAN and HDBaseT/Ethernet (RJ-45) ports. Utilizing a wired LAN connected with these ports, it enables to control the projector by a computer.

1. Check the product overview, supplied items and part names

- **CRESTRON ROOMVIEW and Extron XTP compatibility**

The projector supports CRESTRON ROOMVIEW and Extron XTP, allowing multiple devices connected in the network to be managed and controlled from a computer. Moreover, it enables to output and control image via an Extron XTP transmitter connected with the projector.

- Compatible with our software applications (NaViSet Administrator 2, ProAssist, Virtual Remote Tool, etc.). The projector can be controlled from a computer connected via a wired LAN.

- NaViSet Administrator 2

You can monitor the status of the projector and control a variety of functions.

- ProAssist

Necessary adjustments can be made smoothly for multi-screen projection.

- Virtual Remote Tool

A virtual remote control is displayed on the computer screen to perform simple controls such as turning the projector on/off, switching signals, etc. It is also possible to change the background logo of the projector. (→ page 190)

Please visit our web site for downloading each software.

URL: <https://www.sharp-nec-displays.com/dl/en/index.html>

Energy-saving

- **Energy-saving design with a standby power consumption of 0.22 W (100-130 V AC) / 0.28 W (200-240 V AC)**

Selecting [ON] for [POWER-SAVING] from the menu can put the projector in power-saving mode.

When network is enabled: 0.8 W

When the network is disabled: 0.22 W (100-130 V AC)/0.28 W (200-240 V AC)

- **[LIGHT MODE] for low power consumption and “Carbon Meter” display**

The projector is equipped with an [REF. LIGHT MODE] for reducing power consumption during use. Furthermore, the power-saving effect when one option among [ECO1] and [ECO2] is set is converted into the amount of reductions of CO₂ emissions and this is indicated on the confirmation message displayed when the power is turned off and at [INFORMATION] on the on-screen menu (CARBON METER).

1. Check the product overview, supplied items and part names

1-2. What's in the Box?

Make sure your box contains everything listed. If any pieces are missing, contact your dealer. Please save the original box and packing materials if you ever need to ship your projector.

Projector

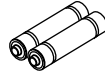
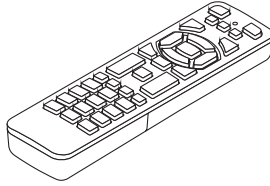
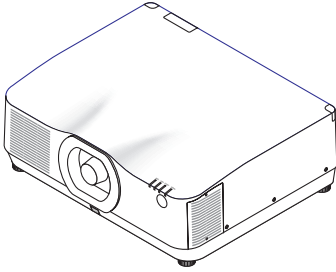

Dust cap for lens
(24F56481)

Remote control
(7N901322)

AAA alkaline batteries (x2)

* The projector is shipped without a lens. For the types of lens and throw distances, see page 171.

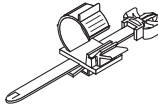
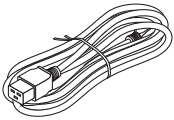

Power cord
(US: 7N080534, EU: 7N080032)

Power cord stopper
(24C10881)

Documents

(→ refer to the [next page](#))

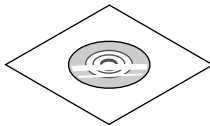
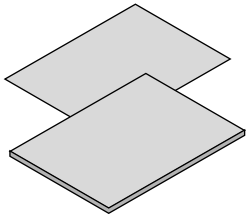

For USA and Canada only

Limited warranty

For customers in Europe

You will find our current valid Guarantee Policy on our Web Site:

<https://www.sharpnecdiseplays.eu>

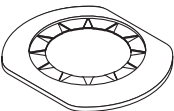

Lens mask
(24FU2831)

Lens theft prevention screw
(24V00941)

Request your dealer to install the lens mask and lens theft prevention screw together with the lens unit.

1. Check the product overview, supplied items and part names

About the attached documents

Documents	Models for USA, Canada, and South America	Models for other countries
NEC Projector CD-ROM User's manual (PDF)	No attachments • The User's Manual is posted on the Web Site.	1 pc (7N952962)
Important Information	2 pcs (For USA: 7N8R0161, For Canada/ South America: 7N8R0512)	1 pc (7N8R0152)
Quick Setup Guide	1 pc (7N8R0171)	2 pcs (7N8R0171 and 7N8R0181)
Security Sticker	1 pc • Use this sticker when security password is set on.	

1-3. Part Names of the Projector

Front

The lens is sold separately. The description below is for when the NP41ZL lens is mounted.

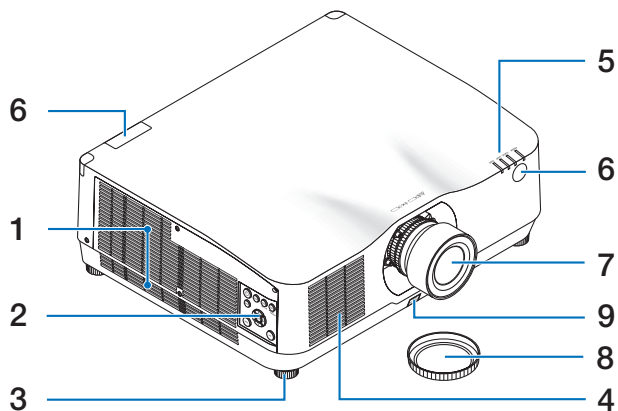

1. Exhaust vent

Heated air is exhausted from here
(→ page xxviii, 170)

2. Controls

(→ page 8)

3. Adjustable Tilt Foot

4. Intake vent

(→ page xxviii, 170)

5. Indicator Section

(→ page 8, 191)

6. Remote Sensor

(→ page 14)

7. Lens

8. Lens Cap

(The optional lens is shipped with the lens cap.)

9. Lens Release Button

Use this to remove the lens unit.
Request your dealer to attach or detach the lens unit.

Rear

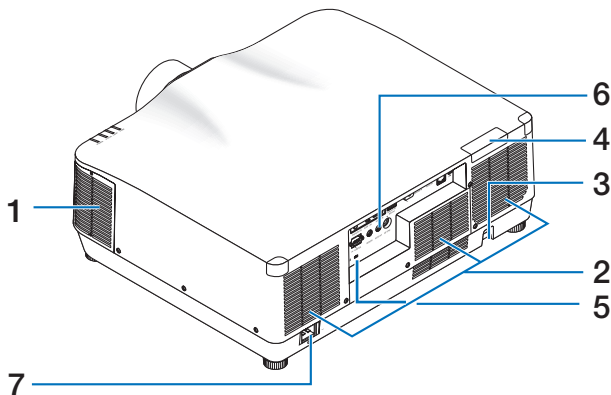

1. Exhaust vent

(→ page xxviii, 170)

2. Intake vent

(→ page xxviii, 170)

3. Security Bar

Attach an anti-theft device. The security bar accepts security wires or chains up to 0.18 inch/4.6 mm in diameter.

4. Remote Sensor

(located on the front and the rear)

(→ page 14)

5. Security Slot (🔒)*

6. Terminals

(→ page 9)

7. AC IN Terminal

Connect the supplied power cord's three-pin plug here, and plug the other end into an active wall outlet.

(→ page 17)

* Security and theft protection lock compatible with Kensington security cables/equipment. For products, visit Kensington's website.

1. Check the product overview, supplied items and part names

Controls/Indicators

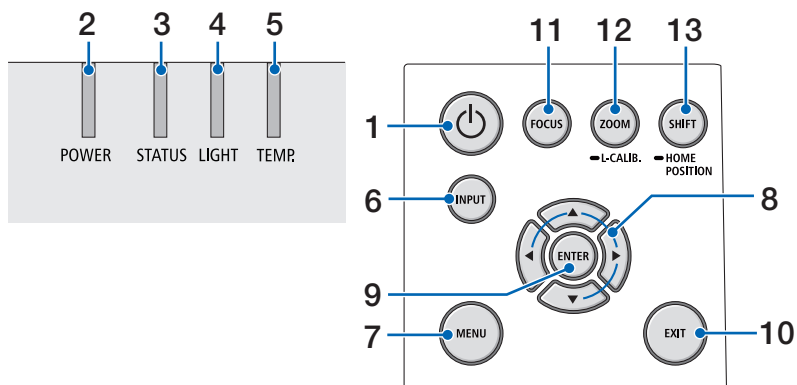

1. (POWER) Button

Switches between projector's power on and standby.

(→ page 20, 37)

2. POWER Indicator

(→ page 17, 20, 37, 191)

3. STATUS Indicator

(→ page 191)

4. LIGHT Indicator

(→ page 191)

5. TEMP. Indicator

(→ page 191)

6. INPUT Button

(→ page 23)

7. MENU Button

(→ page 82)

8. / Volume Buttons

(→ page 27, 36, 82)

9. ENTER Button

(→ page 82)

10. EXIT Button

(→ page 82)

11. FOCUS Button

(→ page 31)

12. ZOOM/L-CALIB. Button

(→ page 21, 34)

13. SHIFT/HOME POSITION Button

(→ page 27)

1. Check the product overview, supplied items and part names

Terminal Panel Features

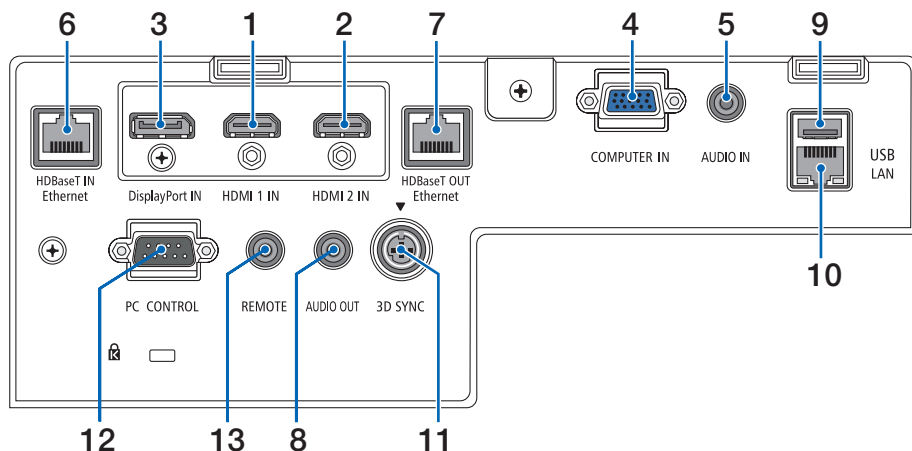

1. HDMI 1 IN Terminal (Type A)

(→ page [161](#), [163](#), [165](#))

2. HDMI 2 IN Terminal (Type A)

(→ page [161](#), [163](#), [165](#))

3. DisplayPort IN Terminal

(→ page [161](#))

4. COMPUTER IN/ Component Input Terminal (Mini D-Sub 15 Pin)

(→ page [160](#), [164](#))

5. COMPUTER AUDIO IN Mini Jack (Stereo Mini)

(→ page [160](#), [163](#))

6. HDBaseT IN/Ethernet Port (RJ-45)

(→ page [166](#), [167](#))

7. HDBaseT OUT/Ethernet Port (RJ-45)

(→ page [167](#))

8. AUDIO OUT Mini Jack (Stereo Mini)

(→ page [163](#), [165](#))

9. USB-A Port (Type A)

(→ page [48](#))

10. LAN Port (RJ-45)

(→ page [168](#))

11. 3D SYNC Terminal (Mini DIN 3 Pin)

(→ page [53](#))

12. PC CONTROL Port (D-Sub 9 Pin)

(→ page [189](#))

Use this port to connect a PC or control system. This enables you to control the projector using serial communication protocol. If you are writing your own program, typical PC control codes are on page [197](#).

13. REMOTE Terminal (Stereo Mini)

Use this terminal for wired remote control of the projector.

(→ page [15](#))

NOTE:

- When a remote control cable is connected to the REMOTE terminal, infrared remote control operations cannot be performed.
- When [HDBaseT] is selected in the [REMOTE SENSOR] and the projector is connected to a commercially-available transmission device that supports HDBaseT, remote control operations in infra-red cannot be carried out if transmission of remote control signals has been set up in the transmission device. However, remote control using infrared rays can be carried out when the power supply of the transmission device is switched off.

1-4. Part Names of the Remote Control

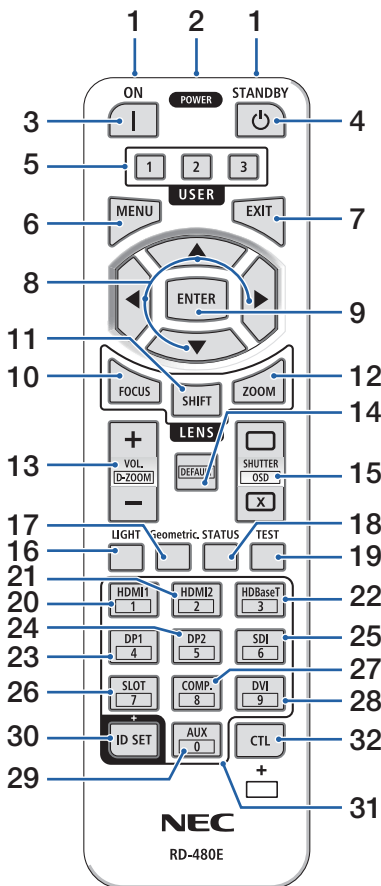

1. Infrared Transmitter

(→ page 14)

2. Remote Jack

Connect a commercially available remote cable here for wired operation.

(→ page 15)

3. POWER ON Button (|)

(→ page 20)

4. POWER STANDBY Button (⏻)

(→ page 37)

5. USER 1/2/3 Button

(Not available on this series of projectors. For future expansion)

6. MENU Button

(→ page 82)

7. EXIT Button

(→ page 82)

8. ▲▼◀▶ Button

(→ page 82)

9. ENTER Button

(→ page 82)

10. FOCUS Button

Applicable lens unit: NP40ZL/NP41ZL/NP43ZL/NP44ML

(→ page 31)

11. SHIFT Button

(→ page 27)

12. ZOOM Button

Applicable lens unit: NP40ZL/NP41ZL/NP43ZL/NP44ML

(→ page 34)

1. Check the product overview, supplied items and part names

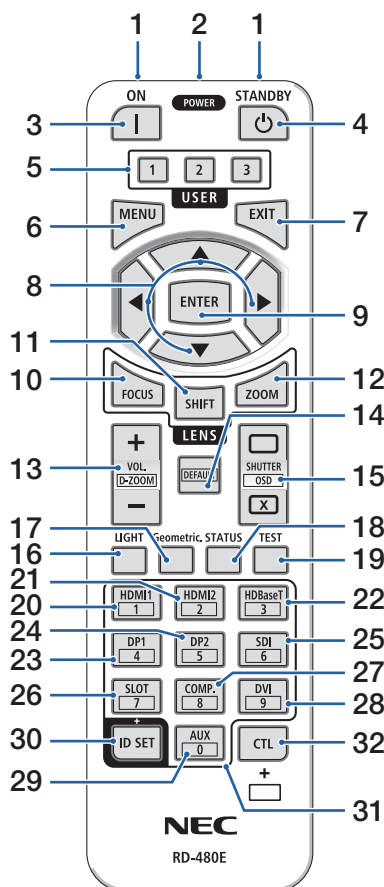

13. VOL./D-ZOOM (+)(-) Button

(→ page 36, 40)

14. DEFAULT Button

(Not available on this series of projectors. For future expansion)

15. SHUTTER/OSD OPEN (□)/CLOSE (X) Button

(→ page 39)

16. LIGHT Button

(→ page 42)

17. Geometric. Button

(→ page 45, 113)

18. STATUS Button

(→ page 156)

19. TEST Button

(→ page 92)

20. HDMI1 Button

(→ page 23)

21. HDMI2 Button

(→ page 23)

22. HDBaseT Button

(→ page 23)

23. DP1 Button

(→ page 23)

24. DP2 Button

(Not available on this series of projectors.)

25. SDI Button

(Not available on this series of projectors.)

26. SLOT Button

(Not available on this series of projectors.)

27. COMP. Button

(→ page 23)

1. Check the product overview, supplied items and part names

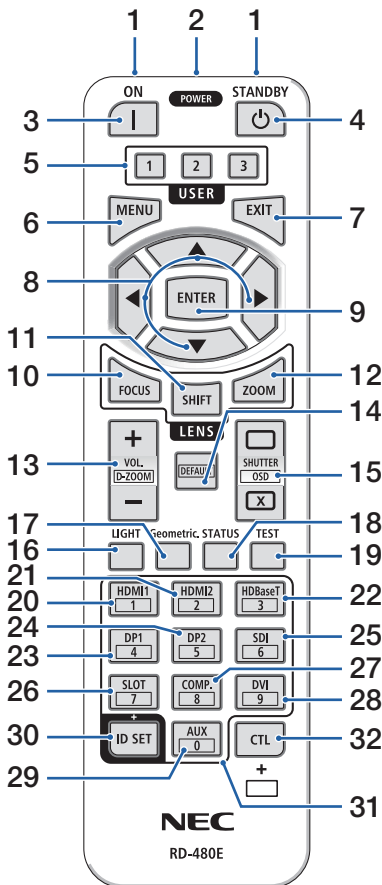

28. DVI Button

(Not available on this series of projectors.)

29. AUX Button

(Not available on this series of projectors. For future expansion)

30. ID SET Button

(→ page 139)

31. Numeric Keypad Button

(→ page 139)

32. CTL Button

(→ page 39, 40)

1. Check the product overview, supplied items and part names

Battery Installation

1. Press the catch and remove the battery cover.

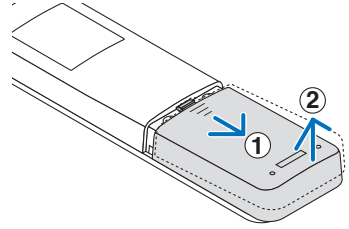

2. Install new ones (AAA). Ensure that you have the batteries' polarity (+/-) aligned correctly.

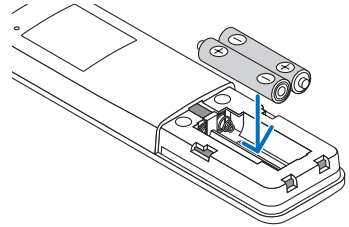

3. Slip the cover back over the batteries until it snaps into place.

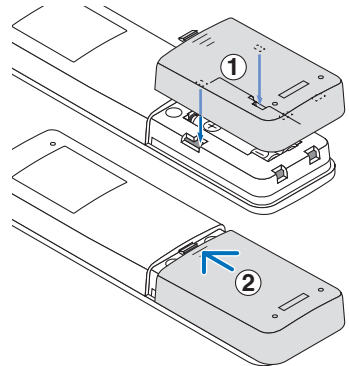

NOTE:

- Do not mix different types of batteries or new and old batteries.
-

Remote Control Precautions

- Handle the remote control carefully.
- If the remote control gets wet, wipe it dry immediately.
- Avoid excessive heat and humidity.
- Do not short, heat, or take apart batteries.
- Do not throw batteries into fire.
- If you will not be using the remote control for a long time, remove the batteries.
- Ensure that you have the batteries' polarity (+/-) aligned correctly.
- Do not use new and old batteries together, or use different types of batteries together.
- Dispose of used batteries according to your local regulations.
- Please note that if multiple projectors are installed nearby, other projectors may unintentionally light up when you turn on the power using the remote control.

1. Check the product overview, supplied items and part names

Operating Range for Wireless Remote Control

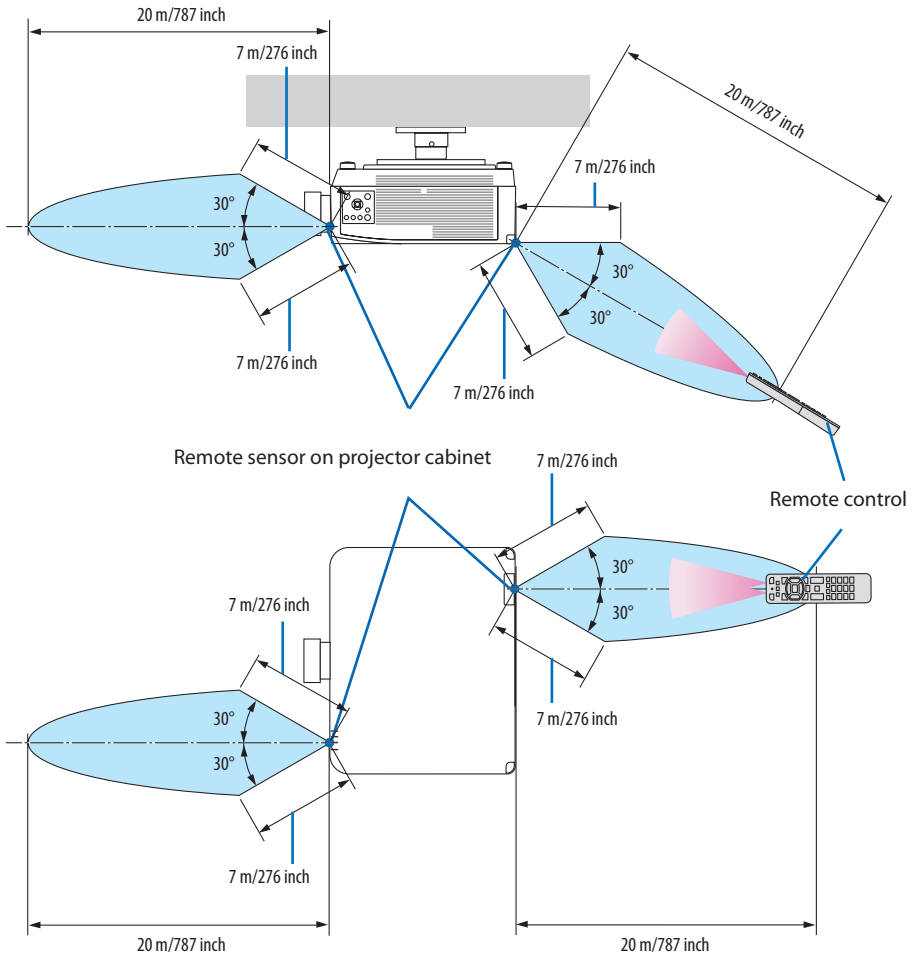

- The projector will not respond if there are objects between the remote control and the sensor, or if strong light falls on the sensor. Weak batteries will also prevent the remote control from properly operating the projector.

1. Check the product overview, supplied items and part names

Using the Remote Control in Wired Operation

Connect one end of the remote cable to the REMOTE terminal and the other end to the remote jack on the remote control.

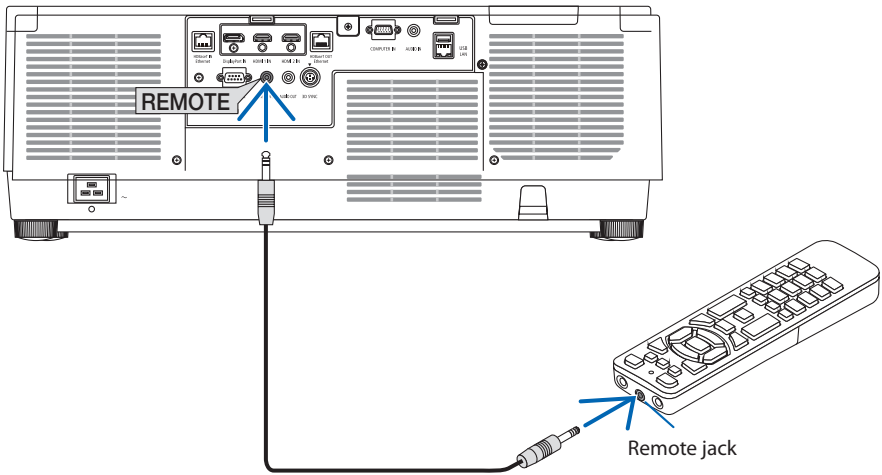

NOTE:

- When a remote cable is inserted into the REMOTE terminal, the remote control does not work for infrared wireless communication.
 - Power will not be supplied to the remote control by the projector via the REMOTE jack. Battery is needed when the remote control is used in wired operation.
-

2. Projecting an Image (Basic Operation)

This section describes how to turn on the projector and to project a picture onto the screen.

2-1. Flow of Projecting an Image

Step 1

- **Connecting your computer / Connecting the power cord** (→ [page 17](#))



Step 2

- **Turning on the projector** (→ [page 20](#))



Step 3

- **Selecting a source** (→ [page 23](#))



Step 4

- **Adjusting the picture size and position** (→ [page 26](#))
- **Correcting keystone distortion [CORNERSTONE]** (→ [page 45](#))



Step 5

- **Adjusting a picture and sound** (→ [page 36](#))



Step 6

- **Making a presentation**



Step 7

- **Turning off the projector** (→ [page 37](#))



Step 8

- **After use** (→ [page 38](#))

2-2. Connecting Your Computer/Connecting the Power Cord

1. Connect your computer to the projector.

This section will show you a basic connection to a computer. For information about other connections, see “6. Connecting to Other Equipment” on page 159.

Connect the display output terminal (mini D-sub 15 pin) on the computer to the computer video input terminal on the projector with a commercially-available computer cable (with ferrite core) and then turn the knobs of the connectors to secure them.

2. Connect the supplied power cord to the projector.

First connect the supplied power cord’s three-pin plug to the AC IN terminal of the projector, and then connect another plug of the supplied power cord directly in the wall outlet. Do not use any plug converter.



CAUTION:

- This equipment is designed to be used in the condition of the power cord connected to earth. If the power cord is not connected to the earth, it may cause electric shock. Please make sure the power cord is earthed properly.
Do not use a 2-core plug converter adapter.
- Be sure to connect the projector and the computer (signal source) to the same earth point. If the projector and the computer (signal source) will be connected to different earth points, fluctuations in the earth potential may cause fire or smoke.
- To prevent the power cord from coming loose, make sure that all the prongs of the power cord plug are fully inserted into the AC IN terminal of the projector before using the power cord stopper. A loose contact of the power cord may cause a fire or electric shock.

Upon connecting the power cable, the POWER indicator of the projector will light. (→ page 191)

2. Projecting an Image (Basic Operation)

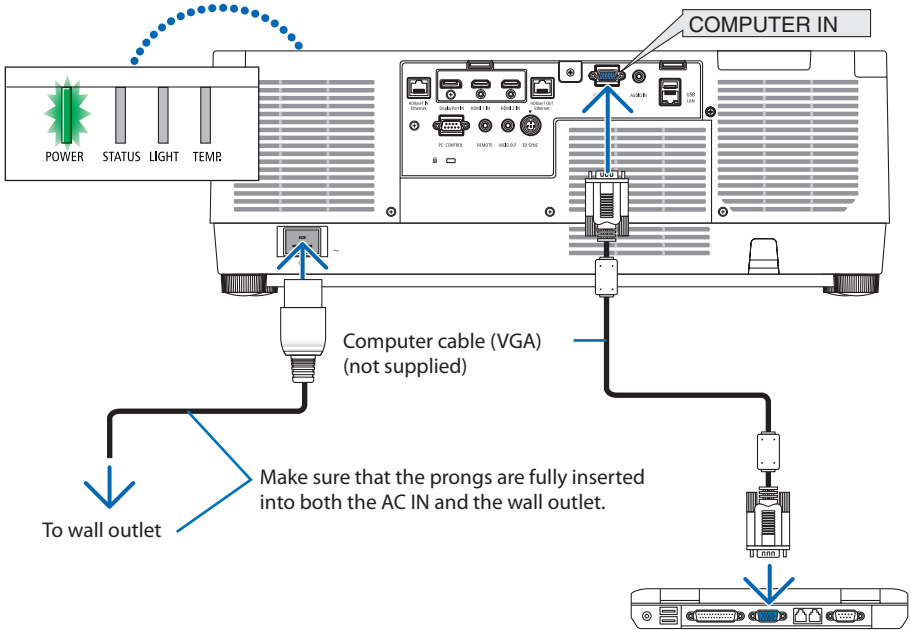

CAUTION:

Parts of the projector may become temporarily heated if the projector is turned off with the POWER button or if the AC power supply is disconnected during normal projector operation. Use caution when picking up the projector.

Using the power cord stopper

To prevent the power cord from accidentally removing from the AC IN of the projector, use the power cord stopper.

CAUTION:

To prevent the power cord from coming loose, make sure that all the prongs of the power cord are fully inserted into the AC IN terminal of the projector before using the power cord stopper to fix the power cord. A loose contact of the power cord may cause a fire or electric shock.

NOTE:

- If you pull on the power supply cord while the connector is fixed, the main unit may fall down and be damaged

Installing the power cord stopper

- ① With the clammer facing the power supply cord, align the tip of the power supply cord stopper with the hole below the AC IN terminal and push it in.
- ② Pass the power supply cord through the clammer and press the clammer to fix it.
- ③ Slide the clammer until the base of the power plug.

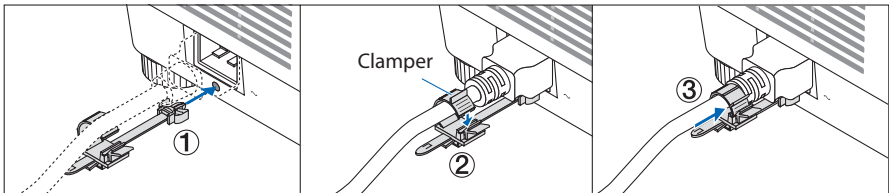

Disconnecting the power cord

- ① Pull to an appropriate position while pushing down the knob of the power cord stopper.
- ② Press down the knob on the clammer to open the clammer and take out the power cord.
- ③ Push and pull the fitted part of the power cord stopper from the left and right to remove it from the main unit.

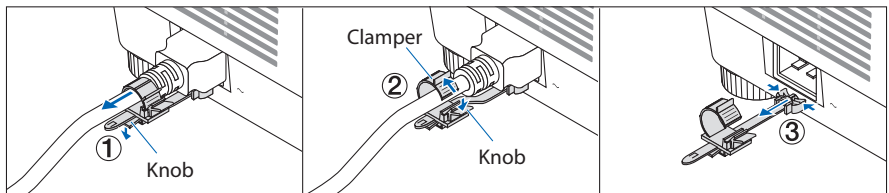

2-3. Turning on the Projector

WARNING

The projector produces a strong light. When turning on the power, operate from the side or rear of the projector (outside the hazard zone). Also, when turning on the power, make sure no one within the projection range is looking at the lens.

1. Remove the lens cap.

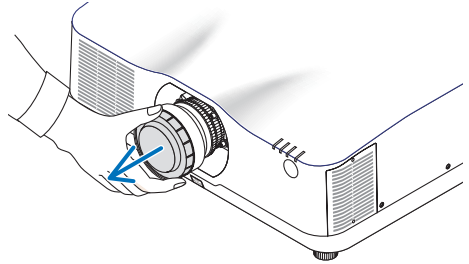

2. Press the (POWER) button on the projector cabinet or the POWER ON button on the remote control.

The POWER indicator lit in green will start to blink in blue. After that, the image will be projected onto the screen.

TIP:

- When the message "PROJECTOR IS LOCKED! ENTER YOUR PASSWORD." is displayed, it means that the [SECURITY] feature is turned on. (→ page 50)

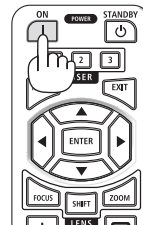

After you turn on your projector, ensure that the computer or video source is turned on.

NOTE:

- A blue screen (blue background) is displayed when no signal is being input (by factory default menu settings).

Performing Lens Calibration

After mounting the separately available lens unit or replacing a lens unit, perform [LENS CALIBRATION] by holding to press ZOOM/L-CALIB. button on the cabinet over two seconds.

Calibration corrects the adjustable zoom, shift, and focus range. If calibration is not performed, you may not be able to get the best focus and zoom even if you adjust the focus and zoom for the lens.

NOTE:

- [LENS CALIBRATION] is not available for the lens unit NP44ML.

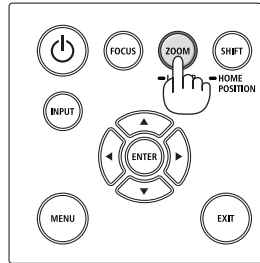

Note on Startup screen (Menu Language Select screen)

When you first turn on the projector, you will get the Startup menu. This menu gives you the opportunity to select one of the 30 menu languages.

To select a menu language, follow these steps:

1. Use the ▲, ▼, ◀ or ▶ button to select one of the 30 languages from the menu.

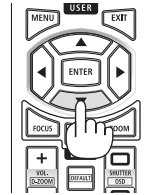

2. Press the ENTER button to execute the selection.

After this has been done, you can proceed to the menu operation.

If you want, you can select the menu language later.

(→ [LANGUAGE] on page 86 and 123)

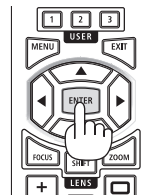

NOTE:

- If the message, [PLEASE SET "DATE AND TIME".] is shown, please set the current date and time. (→ page 137)
- In the case this message is not shown, the [DATE AND TIME SETTINGS] is recommended to complete.
- Keep the lens cap off the lens while the projector's power is on.
If the lens cap is on, it could be warped due to high temperature.
- If the STATUS indicator lights orange with the power button pressed, the projector will not be turned on since the [CONTROL PANEL LOCK] has been [ON]. Cancel the lock by turning it off. (→ page 137)
- While the POWER indicator is blinking blue in short cycles, the power cannot be turned off by using the power button.

2-4. Selecting a Source

Selecting the computer or video source

NOTE:

- Turn on the computer or video source equipment connected to the projector.

Detecting the Signal Automatically

Press the INPUT button for 1 second or longer. The projector will search for the available input source and display it. The input source will change as follows:

HDMI1 → HDMI2 → DisplayPort → COMPUTER → HDBaseT → HDMI1 → ...

- Press it briefly to display the [INPUT] screen.

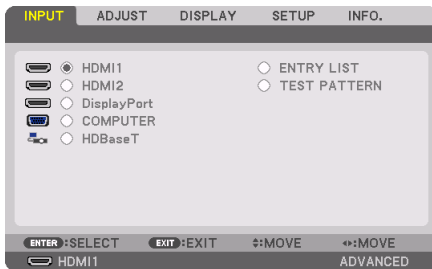

- Press the ▼/▲ buttons to match the target input terminal and then press the ENTER button to switch the input. To delete the menu display in the [INPUT] screen, press the MENU or EXIT button.

TIP:

- If no input signal is present, the input will be skipped.

Using the Remote Control

Press any one of the HDMI1, HDMI2, HDBaseT, DP1 or COMP. button.

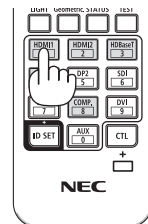
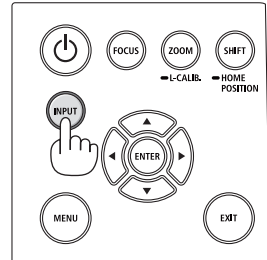

Selecting Default Source

You can set a source as the default source so that it will be displayed each time the projector is turned on.

1. Press the MENU button.

The menu will be displayed.

2. Press the ► button to select [SETUP] and press the ▼ button or the ENTER button to select [MENU(1)].

3. Press the ► button to select [SOURCE OPTIONS] and press the ▼ button or the ENTER button.

4. Press the ▼ button three times to select [DEFAULT INPUT SELECT] and press the ENTER button.



The [DEFAULT INPUT SELECT] screen will be displayed.

(→ page 150)

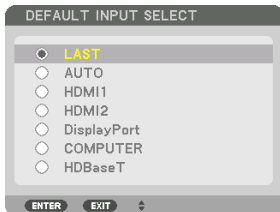

5. Select a source as the default source, and press the ENTER button.

6. Press the EXIT button a few times to close the menu.

7. Restart the projector.

The source you selected in step 5 will be projected.

NOTE:

- Even when [AUTO] is turned on, the [HDBaseT] will not be automatically selected. To set your network as the default source, select [HDBaseT].

2. Projecting an Image (Basic Operation)

TIP:

- When the projector is in Standby mode, applying a computer signal from a computer connected to the COMPUTER IN input will power on the projector and simultaneously project the computer's image. ([AUTO POWER ON SELECT] → page 154)
- On the Windows 10 keyboard, a combination of the Windows and P keys allows you to set up external display easily and quickly.

2-5. Adjusting the Picture Size and Position

Use the lens shift, the adjustable tilt foot, the zoom and the focus to adjust the picture size and position.

In this chapter drawings and cables are omitted for clarity.

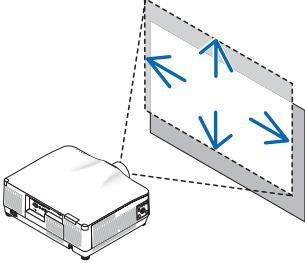
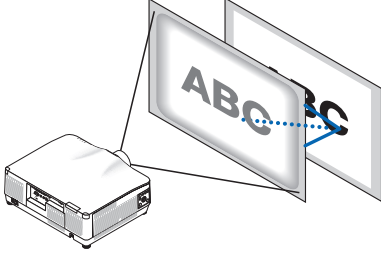
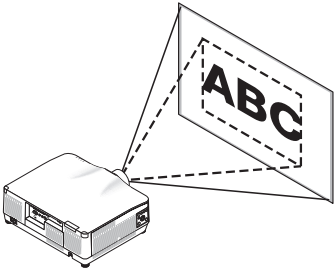
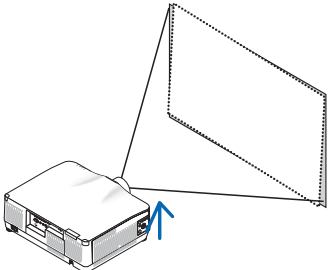
<p>Adjusting the projected image's vertical and horizontal position "Lens shift" (→ page 27)</p> 	<p>Adjusting the focus "Focus" (→ page 29)</p> 
<p>Finely adjusting the size of an image "Zoom" (→ page 34)</p> 	<p>Adjusting the projected image's inclination "Tilt foot" (→ page 35)</p> 

Adjusting the vertical position of a projected image (Lens shift)

CAUTION

- Perform the adjustment from behind or from the side of the projector. If adjustments are performed from the front, your eyes could be exposed to strong light and get injured.
- Keep hands away from the lens mounting portion while performing a lens shift. Failure to do so could result in fingers being pinched by the moving lens.

1. Press either **SHIFT/HOME POSITION** button on the cabinet or **SHIFT** button on the remote control.

The [LENS SHIFT] screen will be displayed.

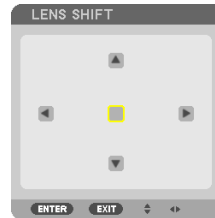

2. Press the **▼▲◀▶** buttons to move the projected image.

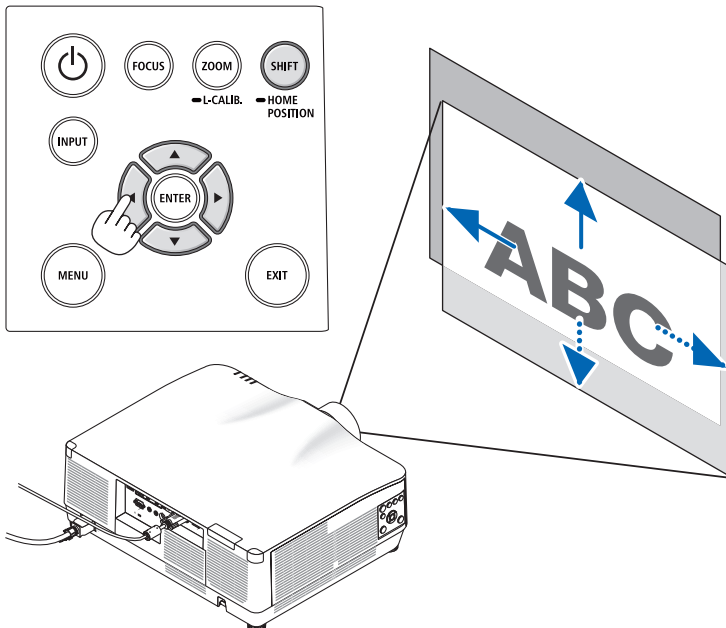

To set back the lens to the home position

Press and hold the **SHIFT/HOME POSITION** button over 2 seconds. The lens mounted on the projector goes back to the home position. (roughly to the center position)

2. Projecting an Image (Basic Operation)

NOTE:

- If the lens is shifted to the maximum in the diagonal direction, the screen peripheral area will be dark or shaded.
- Use NP11FL at the home position. If necessary, fine-adjust the position of the projected image using the lens shift function.
- The NP44ML must be fixed to the projector using the separately sold support kit (NP02LK). Loosen the screws of the support bracket, you can fine-adjustment of the lens shift. Have your dealer mount and adjust the support kit.

TIP:

- The figure below shows the lens shift adjustment range (projection method: Desktop/Front) of the NP41ZL lens unit. See page 175 for other lens units.

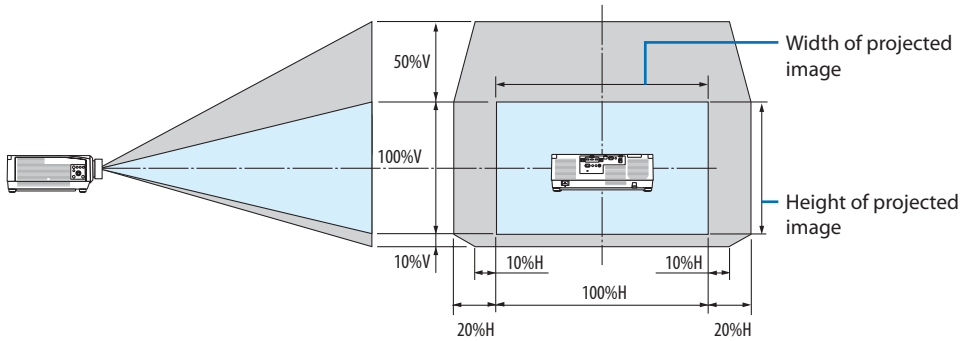

Description of symbols: V indicates vertical (height of the projected image), H indicates horizontal (width of the projected image).

Focus

Recommend to perform the focus adjustment after leaving the projector under the state the TEST PATTERN has been projected for over 30 minutes.

Please refer to page 92 in the User's Manual about the TEST PATTERN.

Applicable lens: NP12ZL/NP13ZL/NP14ZL/NP15ZL (Manual focus)

Use the focus ring to obtain the best focus.

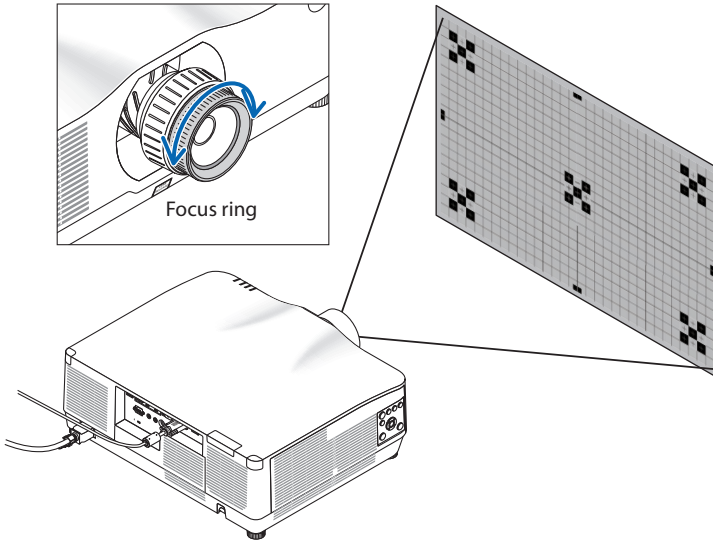

Applicable lens: NP11FL (Manual focus)

With the NP11FL lens, adjust the focus and picture distortion.

Preparations:

Press and hold the SHIFT/HOME POSITION button on the cabinet longer than 2 seconds for shifting back the lens to the home position.

1. Turn the distortion ring to the left edge.

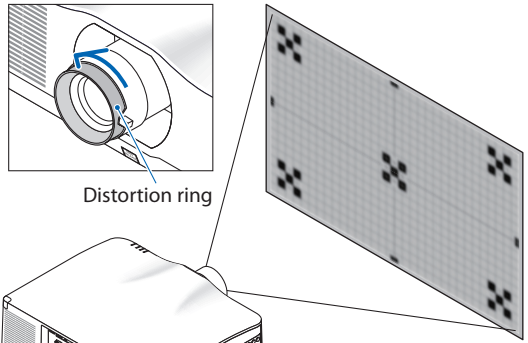

2. Turn the focus lever clockwise and counterclockwise to adjust the focus at the center of the screen.

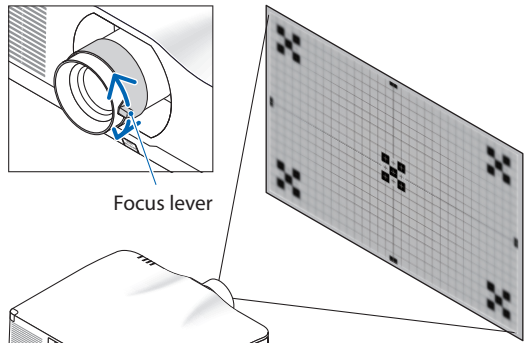

3. Use the distortion ring to correct the screen's distortion.

(This also brings the screen peripheral area into focus.)

4. Use the focus lever to adjust the screen's overall focus.

* If the focus at the center of the screen is off, turn the distortion ring a little counterclockwise. The focus at the center of the screen can now be adjusted with the focus lever.

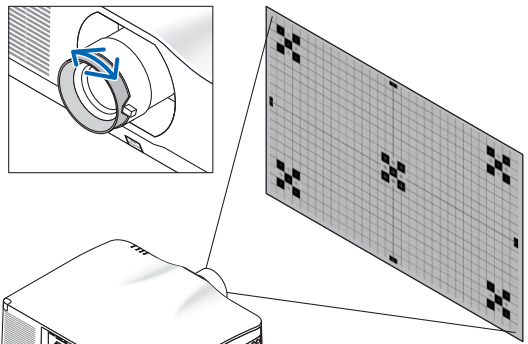

Applicable lens: NP40ZL/NP41ZL (Motorized focus)

1. Press the FOCUS button.

The [LENS FOCUS] control screen will be displayed on.



Press ◀▶ buttons to adjust focus.

2. When the cursor is on the [CENTER] on on-screen menu, press either ◀ or ▶ button to align focus around the optical axis.

* The picture shows an example when the lens shift is moved upward. The focus for the lower part of the screen is aligned.

When the lens is at the center, the focus for the center of the screen is aligned.

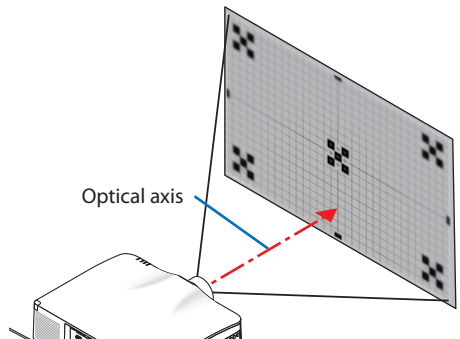
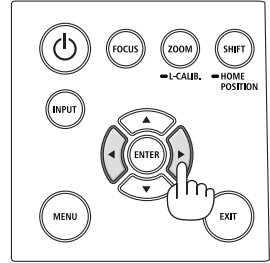
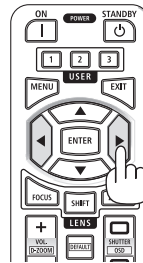
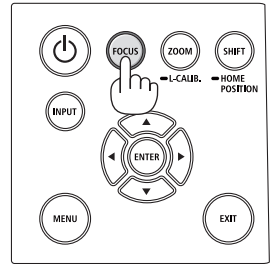
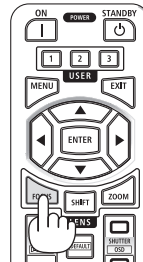

3. Press ▼ button to select the [PERIPHERY] on the on-screen menu, and then press either ◀ or ▶ button to align the focus of screen peripheral area. During this operation, the focus around the optical axis will be maintained.

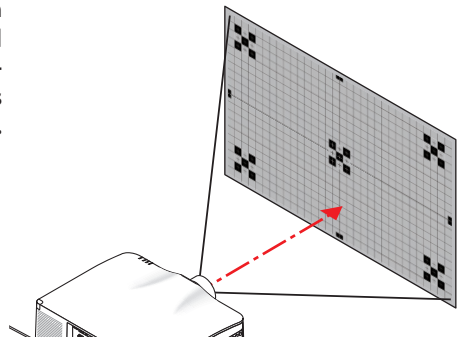

Applicable lens: NP43ZL (Motorized focus)

1. Press the FOCUS button.

The [LENS FOCUS] control screen will be displayed on.



Press ◀▶ buttons to adjust focus.

* [PERIPHERY] LENS FOCUS is not available for this lens unit.

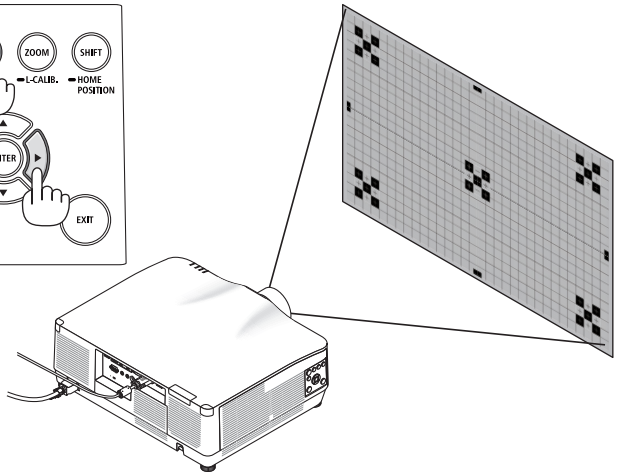
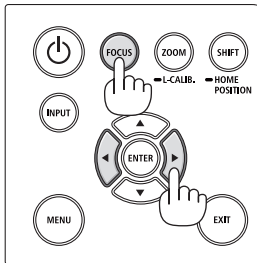
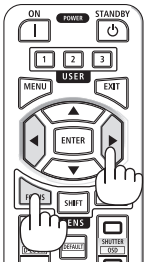

Applicable lens: NP44ML (Motorized focus)

- When operating the buttons on the main unit with the NP44ML installed, there is a risk of intruding into the hazard zone and within 1 m of the precautionary zone. We recommend that you use the remote control to operate the unit for safety reasons.
- The NP44ML must be fixed to the projector using the separately sold support kit (NP02LK). Have your dealer mount and adjust the support kit. The support kit is not shown on this illustration.

1. Press the FOCUS button.

The [LENS FOCUS] control screen will be displayed on.



Press ◀▶ buttons to adjust focus of screen center.

- * [PERIPHERY] LENS FOCUS is not available for this lens unit.

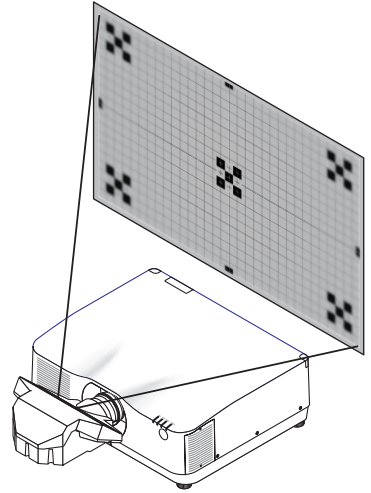
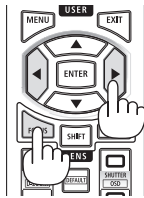

2. Press the ZOOM/L-CALIB. button on the cabinet.

The [LENS ZOOM] control screen will be displayed on.

- * In another way, press the ZOOM button on the remote control.



Press ◀▶ buttons to align the focus of screen peripheral area.

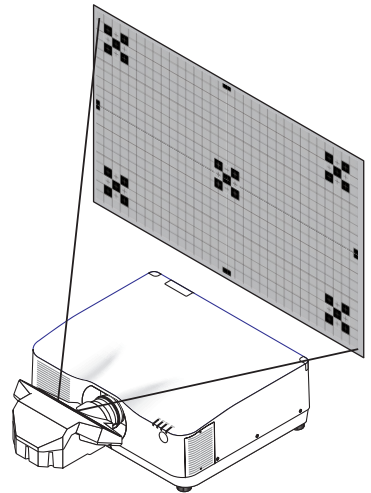
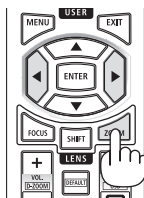

Zoom

Applicable lens: NP12ZL/NP13ZL/NP14ZL/NP15ZL (Manual zoom)

Turn the zoom ring clockwise and counterclockwise.

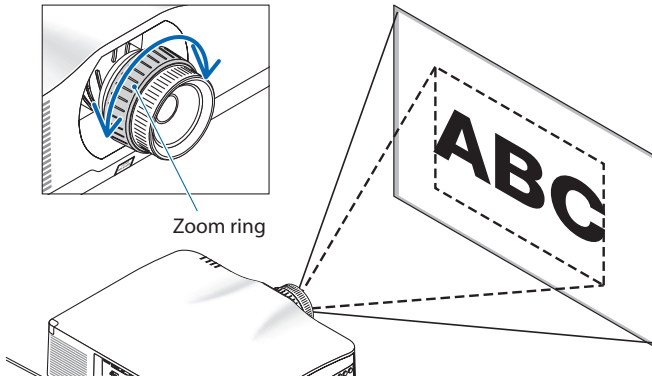

Applicable lens: NP40ZL/NP41ZL/NP43ZL (Motorized zoom)

1. Press ZOOM/L-CALIB. button.

The [ZOOM] adjustment screen will be displayed on.



* In another way, press the ZOOM button on the remote control.

Press ◀▶ buttons to adjust zoom.

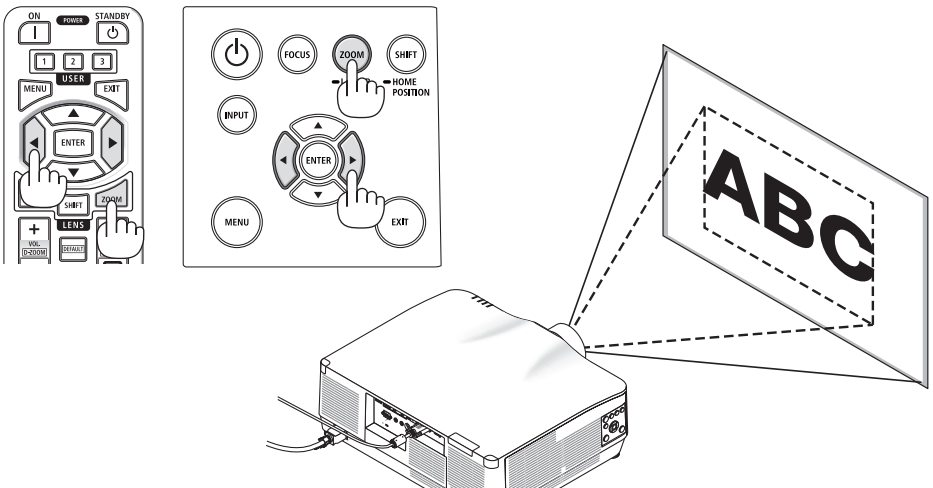

Adjusting the Tilt Foot

1. Turn the left and right tilt foot to adjust.

The tilt foot lengthen and shorten when turned. Turn one of the tilt foot to adjust the image so that it is level.

- If the projected image is distorted, see “3-5 Correcting Horizontal and Vertical Keystone Distortion [CORNERSTONE]” (→ page 45) and “[GEOMETRIC CORRECTION]” (→ page 113).
- The tilt foot can be lengthened by a maximum of 10 mm/0.4".
- The tilt foot can be used to tilt the projector by a maximum of 1.4°.

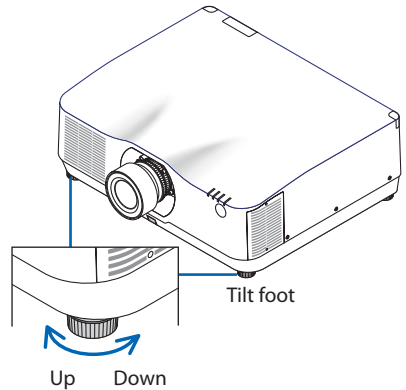
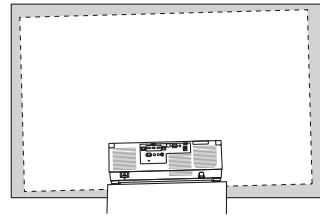

NOTE:

- Do not lengthen the tilt foot any more than 10 mm/0.4". Doing so will make the projector unstable.
- Do not use the tilt foot for any purpose other than adjusting inclination of the projector installation angle. Handling the tilt foot improperly, such as carrying the projector by grasping the tilt foot or hooking it onto a wall using the tilt foot, could damage the projector.

2-6. Adjusting a picture and sound

Adjusting the picture

Display the on-screen menu and adjust the picture. (→ page 96)

Turning Up or Down Volume

Sound level from the AUDIO OUT terminal can be adjusted.

Important:

- Do not turn up the volume to the maximum level on the external speaker system connected to the AUDIO OUT of the projector. Doing so may produce an unexpected, loud sound at the time of turning on or off the projector, causing damage to your hearing. When adjusting the volume on the external speaker system, set volume level of the speaker system to less than half its rating and adjust the volume on the projector to get appropriate sound level.

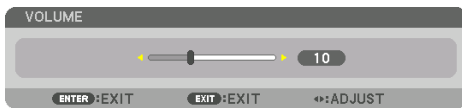

When no menus appear, the ◀ and ▶ buttons on the projector cabinet work as a volume control.

- On the remote control, press the VOL./D-ZOOM (+) or (-) button.

NOTE:

- The volume cannot be adjusted using the ◀ or ▶ button in the following cases.
 - When the on-screen menu is displayed
 - When the screen is enlarged by pressing the VOL./D-ZOOM (+) (-) buttons while holding down the CTL button on the remote control

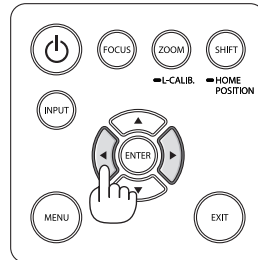
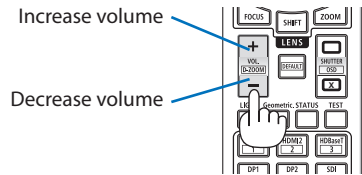



2-7. Turning off the Projector

To turn off the projector:

1. First, press the  (POWER) button on the projector cabinet or the POWER STANDBY button on the remote control.

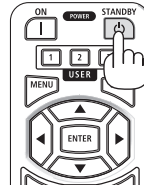
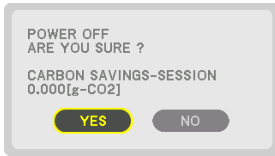
The [POWER OFF / ARE YOU SURE ? / CARBON SAVINGS-SESSION 0.000[g-CO2]] message will appear.



2. Secondly, press the ENTER button or press the  (POWER) or the POWER STANDBY button again.

The light source will be turned off and the power supply will be cut.

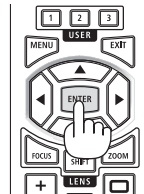

CAUTION

- Parts of the projector may become temporarily heated if the projector is turned off with the POWER button or if the AC power supply is disconnected during normal projector operation. Use caution when picking up the projector.

NOTE:

- While the POWER indicator is blinking blue in short cycles, the power cannot be turned off.
- You cannot turn off the power for 60 seconds immediately after turning it on and displaying an image.
- Do not unplug the power cord from the projector or from the power outlet while an image is being projected. Doing so could deteriorate the projector's AC IN terminal or the power plug's contact. To turn off the AC power while an image is being projected, use the power strip's switch, the breaker, etc.
- Do not disconnect the AC power supply to the projector within 10 seconds of making adjustment or setting changes and closing the menu. Doing so can cause loss of adjustments and settings.

2-8. After Use

1. Unplug the power cord.
2. Disconnect any other cables.
3. Mount the lens cap on the lens.
4. Before moving the projector, screw in the tilt foot if they have been lengthened.

3. Convenient Features

3-1. Turn off the light of the projector (LENS SHUTTER)

1. Press the SHUTTER CLOSE (X) button on the remote control.

The light source will turn off temporarily.

Press the SHUTTER OPEN (□) button to allow the screen to become illuminated again.

- You can set the projection light to gradually fade in or out.

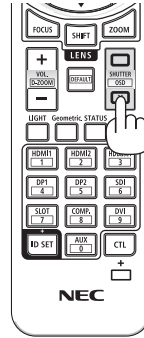

3-2. Turning Off the On-Screen Menu (On-Screen Mute)

1. Hold down the CTL button on the remote control and press the OSD CLOSE (X) button.

The on-screen menu, input terminal, etc. will disappear.

- To display the on-screen display, press the OSD OPEN (□) button while holding down the CTL button on the remote control.

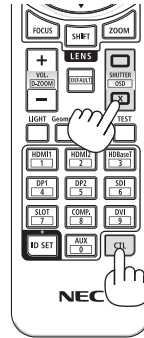

TIP:

- To confirm that the on-screen mute is turned on, press the MENU button. If the on-screen menu is not displayed even though you press the MENU button, it means the on-screen mute is turned on.
- The on-screen mute is maintained even when the projector is turned off,
- Holding down the MENU button on the projector cabinet for at least 10 seconds will turn off the on-screen mute.

3-3. Enlarging a Picture

You can enlarge the picture up to four times.

NOTE:

- Depending on an input signal, the maximum magnification may be less than four times, or the function may be restricted.

- 1. Press and hold the CTL button and then press VOL./D-ZOOM (+) button on the remote control to magnify the picture.**

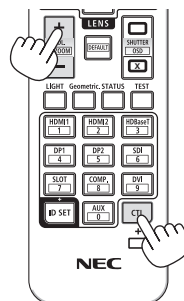
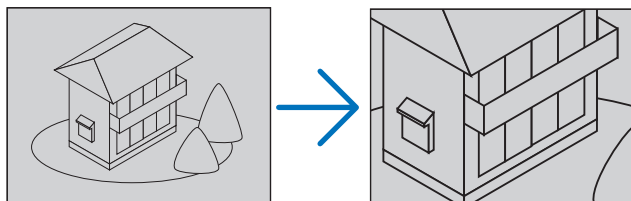

- 2. Press the ▲▼◀▶ button.**

The area of the magnified image will be moved

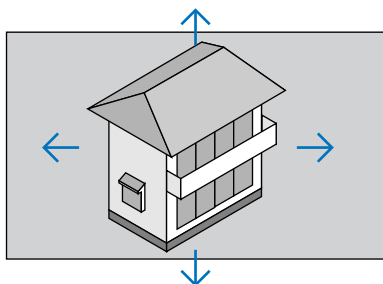

- 3. Press and hold the CTL button and then press VOL./D-ZOOM (-) button on the remote control.**

Each time the button is pressed, the image is reduced.

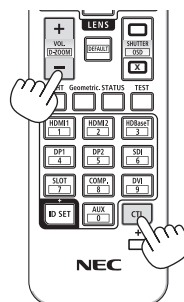







NOTE:

- The image will be enlarged or reduced at the center of the screen.
- Displaying the menu will cancel the current magnification.

3-4. Adjustment of luminance (brightness) and energy-saving effect

You can adjust the output of the unit to a range of 50–100% (in increments of 1%) and control the brightness after adjustment to keep it constant. Also, set the [REF. LIGHT MODE] to [ECO1] or [ECO2] to reduce the brightness and operating sound. By saving energy consumption, the CO₂ emission from this projector can be reduced. There are two ways to set the light mode.

Function name	Description	Page															
REF. LIGHT MODE	The adjustment values of the [REF. LIGHT MODE] and brightness are saved as a setting common to all input signals. Valid when the [MODE] (→ page 96) is set to [STANDARD].	128															
	<table border="1"> <thead> <tr> <th>REF. LIGHT MODE</th> <th>Icon at the bottom of the menu</th> <th>Description</th> </tr> </thead> <tbody> <tr> <td>BOOST</td> <td></td> <td>The picture becomes brighter than the [NORMAL] mode. However, the operating noise and power consumption will also increase due to control of the cooling fan according to the brightness. The life of the optical components may also be shortened depending on the operating environment.</td> </tr> <tr> <td>NORMAL</td> <td></td> <td>100% brightness Alternatively, you can adjust the output from 50 to 100% using [REF. LIGHT ADJUST].</td> </tr> <tr> <td>ECO1</td> <td></td> <td>Brightness will be at about 80%. The cooling fan will also slow down accordingly. Lower power consumption</td> </tr> <tr> <td>ECO2</td> <td></td> <td>Brightness will be at about 50%. The cooling fan will also slow down accordingly. Lower power consumption considerably</td> </tr> </tbody> </table>		REF. LIGHT MODE	Icon at the bottom of the menu	Description	BOOST		The picture becomes brighter than the [NORMAL] mode. However, the operating noise and power consumption will also increase due to control of the cooling fan according to the brightness. The life of the optical components may also be shortened depending on the operating environment.	NORMAL		100% brightness Alternatively, you can adjust the output from 50 to 100% using [REF. LIGHT ADJUST].	ECO1		Brightness will be at about 80%. The cooling fan will also slow down accordingly. Lower power consumption	ECO2		Brightness will be at about 50%. The cooling fan will also slow down accordingly. Lower power consumption considerably
	REF. LIGHT MODE		Icon at the bottom of the menu	Description													
	BOOST			The picture becomes brighter than the [NORMAL] mode. However, the operating noise and power consumption will also increase due to control of the cooling fan according to the brightness. The life of the optical components may also be shortened depending on the operating environment.													
	NORMAL			100% brightness Alternatively, you can adjust the output from 50 to 100% using [REF. LIGHT ADJUST].													
	ECO1			Brightness will be at about 80%. The cooling fan will also slow down accordingly. Lower power consumption													
ECO2		Brightness will be at about 50%. The cooling fan will also slow down accordingly. Lower power consumption considerably															
LIGHT MODE	Adjust the brightness and save it for each input signal. Valid when the [MODE] (→ page 96) is set to [PROFESSIONAL].	99															

Display the [LIGHT MODE] screen

1. Press LIGHT button on the remote control.

When [STANDARD] is selected for [MODE]

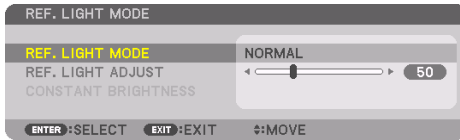

The [REF. LIGHT MODE] screen will be displayed.

When [PROFESSIONAL] is selected for [MODE]



The [LIGHT MODE] screen will be displayed.

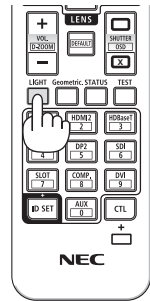

Perform [LIGHT ADJUST]

An explanation is given here using the [REF. LIGHT MODE] screen.

1. Press the ▼ button to adjust the cursor to [REF. LIGHT ADJUST].

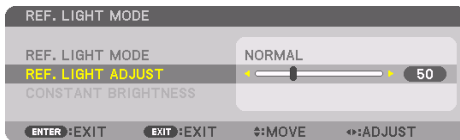

2. Press the ◀▶ button to adjust.

To keep the brightness after adjustment constant, set [CONSTANT BRIGHTNESS] to [ON].

Press the MENU button to cancel the menu screen.

TIP:

- Brightness normally decreases with use, but by selecting [CONSTANT BRIGHTNESS] mode, sensors inside the projector detect brightness and automatically adjust the output, thereby maintaining a constant brightness throughout the life of the light module. However, if output is already at its maximum, brightness will decrease with use.

Change [REF. LIGHT MODE]

1. With the cursor adjusted to [REF. LIGHT MODE], press the ENTER button.

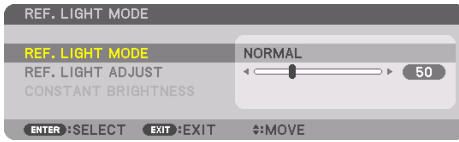

The [REF. LIGHT MODE] selection screen will be displayed.

2. Use the ▼▲ buttons to make a selection, and press the ENTER button.

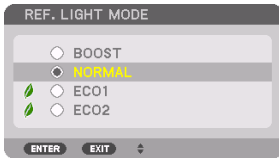

The display will return to the [REF. LIGHT MODE] screen and the selected option will be applied. Press the MENU button to return to the original screen.

NOTE:

- The light module hours used can be checked in [USAGE TIME] on the menu. Select [INFO.] → [USAGE TIME].
- After a lapse of 1 minute from when the projector displays a blue, black or logo screen, [REF. LIGHT MODE] will automatically switch to [ECO].
- The luminance (brightness) may decrease temporarily depending on the temperature of the operating environment and the [REF. LIGHT MODE] setting.

This is one of the protection functions called "Forced ECO MODE". When "Forced ECO MODE" is in operation, the TEMP. Indicator lights up in orange. At the same time, the Thermometer symbol [] is displayed at the lower right of the menu screen. The temperature inside the projector decreases due to the room temperature being lowered, cancelling the "Forced ECO MODE" and returning to the original brightness.

Checking Energy-Saving Effect [CARBON METER]

This feature will show energy-saving effect in terms of CO₂ emission reduction (kg) when the projector's [LIGHT MODE] is set to either [ECO1] or [ECO2]. This feature is called as [CARBON METER].

There are two messages: [TOTAL CARBON SAVINGS] and [CARBON SAVINGS-SESSION]. The [TOTAL CARBON SAVINGS] message shows the total amount of CO₂ emission reduction from the time of shipment up to now. You can check the information on [USAGE TIME] from [INFO.] of the menu. (→ page 156)



The [CARBON SAVINGS-SESSION] message shows the amount of CO₂ emission reduction between the time of changing to [LIGHT MODE] immediately after the time of power-on and the time of power-off. The [CARBON SAVINGS-SESSION] message will be displayed in the [POWER OFF / ARE YOU SURE ?] message at the time of power-off.

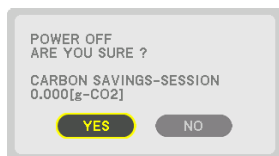

TIP:

- The formula shown below is used to calculate the amount of CO₂ emission reduction. Amount of CO₂ emission reduction = (Power consumption in [NORMAL] [REF. LIGHT MODE] – Power consumption in current setting) × CO₂ conversion factor.* When an energy-saving [LIGHT MODE] is selected, or the Lens Shutter is used, there will be a further reduction in CO₂ emission.
 - * Calculation for amount of CO₂ emission reduction is based on an OECD publication "CO₂ Emissions from Fuel Combustion, 2008 Edition".
- The [TOTAL CARBON SAVINGS] is calculated based on savings recorded in 15 minutes intervals.
- The power consumption when the projector is in standby mode is excluded from the calculation of the amount of CO₂ emission reduction.

3-5. Correcting Horizontal and Vertical Keystone Distortion [CORNERSTONE]

Use the [CORNERSTONE] feature to correct keystone (trapezoidal) distortion to make the top or bottom and the left or right side of the screen longer or shorter so that the projected image is rectangular.

1. Project an image so that the screen is smaller than the area of the raster.

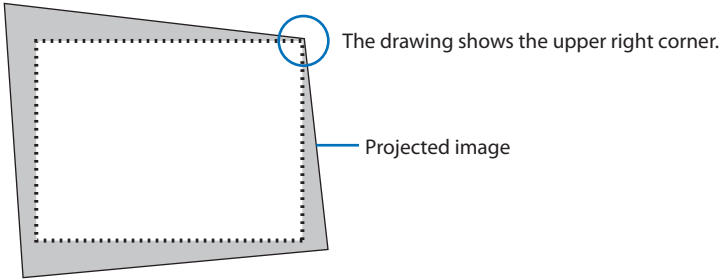

2. Pick up any one of the corners and align the corner of the image with a corner of the screen.

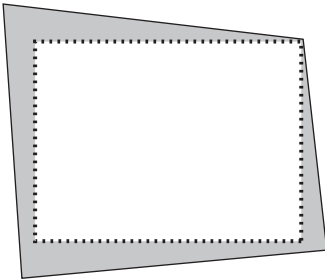

3. Press the Geometric. button either on the cabinet or the remote control.

Display the [GEOMETRIC CORRECTION] screen of the on-screen menu.

4. Move the cursor onto [MODE] by ▼ button and press the ENTER.

The mode selection screen will displayed on.

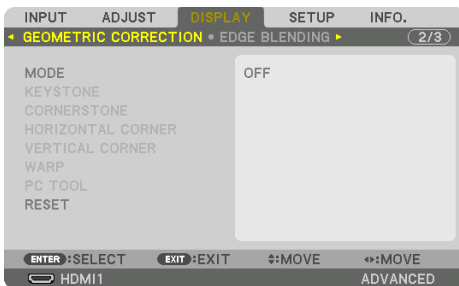

5. Select [CORNERSTONE] and press the ENTER.

Go back to display the [GEOMETRIC CORRECTION] screen of the on-screen menu.

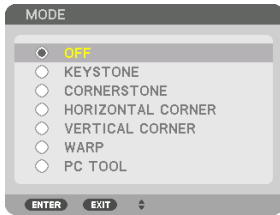

6. Press the ▼ button to align with the [CORNERSTONE] and then press the ENTER button.



The drawing shows the upper left icon (▼) is selected.

The screen will switch to the [CORNERSTONE] screen.

7. Use the ▲▼◀▶ button to select one icon (▲) which points in the direction you wish to move the projected image frame.

8. Press the ENTER button.

9. Use the ▲▼◀▶ button to move the projected image frame as shown on the example.

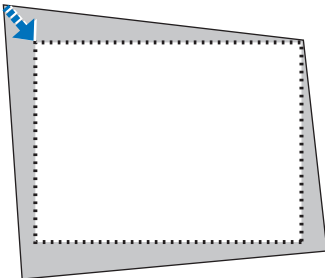

10. Press the ENTER button.

11. Use the ▲▼◀▶ button to select another icon which points in the direction.

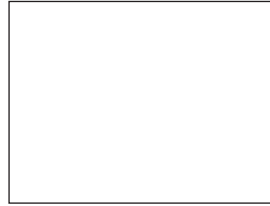
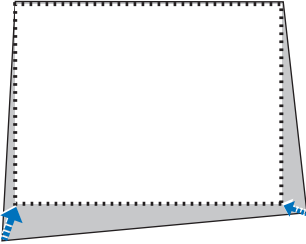

On the [CORNERSTONE] screen, select [EXIT] or press the EXIT button on the remote control.

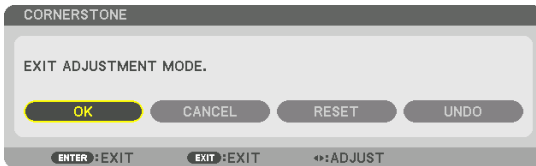

The confirmation screen is displayed.

12. Press the ◀ or ▶ button to highlight the [OK] and press the ENTER button.

This completes the [CORNERSTONE] correction.

- Select [CANCEL] and press the ENTER button to return to the [CORNERSTONE] screen.

Selecting [CANCEL] will return to the adjustment screen without saving changes (Step 3).

Selecting [RESET] will return to the factory default.

Selecting [UNDO] will exit without saving changes.

NOTE:

- Even when the projector is turned on, the last used correction values are applied.
- Carry out either one of the following actions to clear the adjustment value of [CORNERSTONE].
 - In Step 11, select [RESET] and then press the ENTER button.
 - In the state [CORNERSTONE] has been selected for [MODE] in the [GEOMETRIC CORRECTION]:
 - * Press the Geometric. button for 2 or more seconds.
 - * Run [DISPLAY] → [GEOMETRIC CORRECTION] → [RESET] in the on-screen menu.
- Using [CORNERSTONE] correction can cause the image to be slightly blurred because the correction is made electronically.
- A commercially available USB mouse is available for [CORNERSTONE] correction.

3-6. Operation for the On-Screen Menu by a commercially available USB mouse

Once a commercially available USB mouse is connected to this projector, it enables to perform the operation for the on-screen menu and the geometric correction easily.

NOTE:

- Not guarantee the performance of all USB mouse available on the market.

Menu operation

1. Display the on-screen menu by right click.
2. Select a desired menu and perform adjustment by left click.

The adjustment bar can be control by drag and drop.



3. Select [EXIT] displayed at the bottom of the menu by left click for going back to the previous level. If the cursor is on the main menu option, it works for closing the menu. (It works as the same performance with the EXIT button on the remote control.)

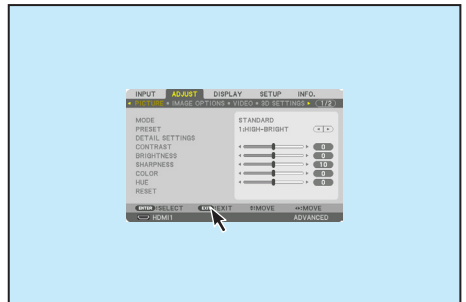

Geometric correction

The USB mouse can be used for [CORNERSTONE] CORRECTION, [HORIZONTAL CORNER], [VERTICAL CORNER], and [WARP]. In this clause, the [CORNERSTONE] CORRECTION by an USB mouse is explained as an example.

1. While the adjustment screen of the [CORNERSTONE] CORRECTION is displayed, right click on the projection screen. The shape of mouse pointer will be changed and the correction will become available.
2. Left click at the screen corner. The projection screen corner will move to the mouse clicked position.

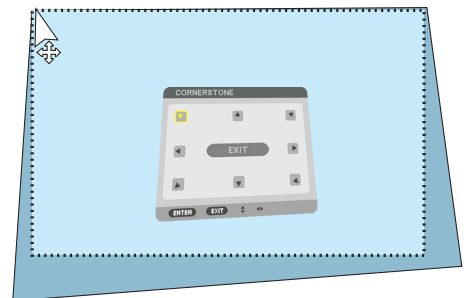
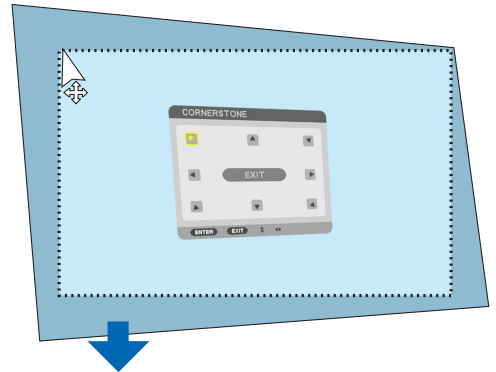
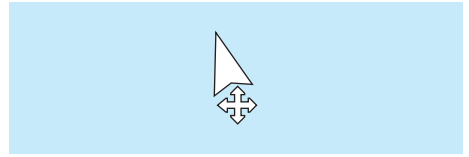

3. Repeat the step 2 for correcting all distortion. After completion of distortion correction, right click on the projection screen. The shape of mouse pointer will be changed to normal.
4. Left click [EXIT] on the correction screen to finish.

3-7. Preventing the Unauthorized Use of the Projector [SECURITY]

A keyword can be set for your projector using the Menu to avoid operation by an unauthorized user. When a keyword is set, turning on the projector will display the Keyword input screen. Unless the correct keyword is entered, the projector cannot project an image.

- The [SECURITY] setting cannot be cancelled by using the [RESET] of the menu.

To enable the Security function:

1. Press the MENU button.

The menu will be displayed.

2. Press the ► button twice to select [SETUP] and press the ▼ button or the ENTER button to select [MENU(1)].

3. Press the ► button to select [CONTROL].

4. Press the ▼ button three times to select [SECURITY] and press the ENTER button.

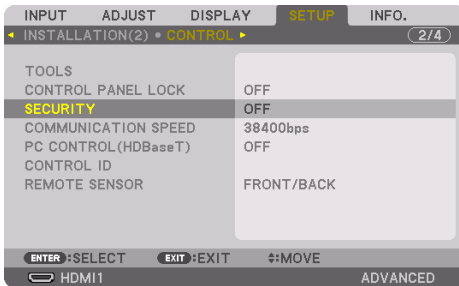

The [OFF]/[ON] menu will be displayed.

5. Press the ▼ button to select [ON] and press the ENTER button.



The [SECURITY KEYWORD] screen will be displayed.

6. Type in a combination of the four ▲▼◀▶ buttons and press the ENTER button.

NOTE:

- A keyword must be 4 to 10 digits in length.

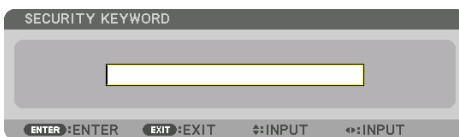

The [CONFIRM KEYWORD] screen will be displayed.

NOTE:

- Make a note of your password and store it in a safe place.

7. Type in the same combination of ▲▼◀▶ buttons and press the ENTER button.

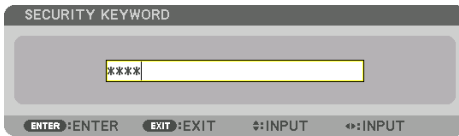

The confirmation screen will be displayed.

8. Select [YES] and press the ENTER button.



The [SECURITY] function has been enabled.

To turn on the projector when [SECURITY] is enabled:

1. Press the POWER ON button.

The projector will be turned on and display a message to the effect that the projector is locked.

2. Press the MENU button.

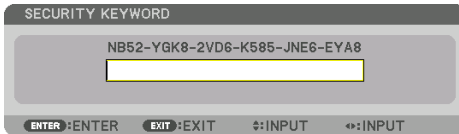

3. Type in the correct keyword and press the ENTER button. The projector will display an image.

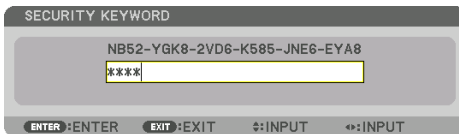

NOTE:

- The security disable mode is maintained until the main power is turned off or unplugging the power cord.

To disable the [SECURITY] function:

1. Press the MENU button.

The menu will be displayed.

2. Select [SETUP] → [CONTROL] → [SECURITY] and press the ENTER button.

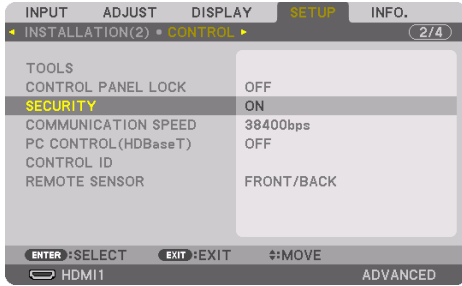

The [OFF]/[ON] menu will be displayed.

3. Select [OFF] and press the ENTER button.



The [SECURITY KEYWORD] screen will be displayed.

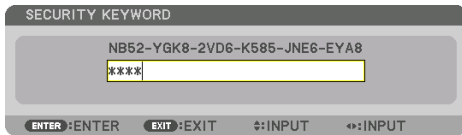

4. Type in your keyword and press the ENTER button.

When the correct keyword is entered, the [SECURITY] function will be disabled.

NOTE:

- If you forget your keyword, contact your dealer. Your dealer will provide you with your keyword in exchange for your request code. Your request code is displayed in the Keyword Confirmation screen. In this example [NB52-YGK8-2VD6-K585-JNE6-EYA8] is a request code.

3-8. Projecting 3D videos

This projector can be used to watch videos in 3D using commercially-available active shutter-type 3D eyewear. In order to synchronize the 3D video and eyewear, a commercially-available 3D emitter needs to be connected to the projector (on the projector side).

The 3D eyewear receives information from the 3D emitter and performs opening and closing on the left and right.



Health precautions

Before use, please make sure to read any health precautions that may be stated in the operating manuals enclosed with the 3D eyewear and 3D video software (Blu-ray player, games, computer animation files, etc.).

Please take note of the following in order to avoid adverse health effects.

- Please do not use the 3D eyewear for purposes other than to watch 3D videos.
- Please keep a distance of at least 2 m away from the screen when watching videos. Watching a video too close to the screen will increase eye fatigue.
- Please do not watch videos continuously for a long period of time. Please take a 15 minutes' break after every hour of watching.
- Please consult a doctor before watching if you or any of your family members have a history of suffering from seizures caused by light sensitivity.
- Please stop watching immediately and take a rest when you feel physically unwell while watching (vomiting, giddiness, nausea, headaches, sore eyes, blurred vision, cramps and numbness in the limbs, etc.). Please consult a doctor if the symptoms persist.
- Please watch a 3D video directly in front of the screen. If you watch a 3D video obliquely from the sides, this may result in physical and eye fatigue.

3D eyewear and 3D emitter preparations

Please use an active shutter-type 3D eyewear that conforms with the VESA standard.

A commercially-available RF type made by XPANDVISION is recommended.

3D eyewear	XPAND X105-RF
3D emitter	XPAND AD025-RF-X1

Procedure to watch 3D videos using this projector

1. **Connect the video device to the projector.**
2. **Switch on the power supply to the projector.**
3. **Run the 3D video software and project the video using the projector.**

This has been automatically set up when shipped from the factory. When a 3D video cannot be projected, it may be because the 3D detection signals are not included or because they are not detectable by the projector.

Please manually select the format.

4. Select the 3D video format.

- (1) Press the MENU button to display the on-screen menu and select [ADJUST] → [3D SETTINGS].

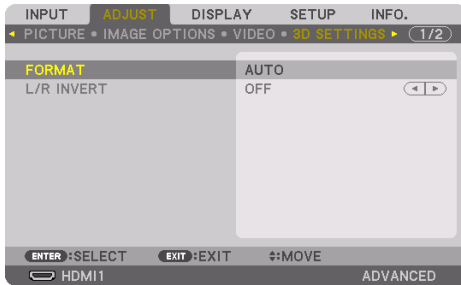

- (2) Press the ▼ button to align the cursor with the [FORMAT] and press the ENTER button. The format screen will be displayed.
- (3) Select the input signal format using the ▼ button and then press the ENTER button.

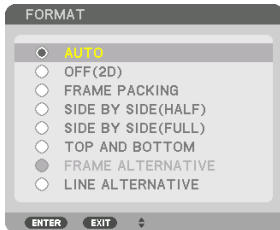

The 3D settings screen will disappear and the 3D video will be projected.

Press the MENU button and the on-screen menu will disappear.

The 3D caution message screen will be displayed when switching to a 3D video (default factory setting when shipped). Please read the “Health Precautions” on the previous page to watch videos in the correct manner. The screen will disappear after 60 seconds or when the ENTER button is pressed. (→ page 124)

5. Turn on the power supply of the 3D eyewear and wear the eyewear to watch the video.

A normal video will be shown when a 2D video is input.

To watch a 3D video in 2D, select [OFF(2D)] in the [FORMAT] screen mentioned above in (3).

NOTE:

- Upon switching to 3D image, the following functions will be cancelled and disabled. [BLANKING], [PIP/PICTURE BY PICTURE], [GEOMETRIC CORRECTION], [EDGE BLENDING] (As the adjusted values of [GEOMETRIC CORRECTION] and [EDGE BLENDING] are maintained, when you switch to 2D picture, the adjusted screen will be displayed again.)
- The output may not automatically switch to a 3D video depending on the 3D input signal.
- Check the operating conditions described in the user manual of the Blu-ray player.
- Please connect the DIN terminal of the 3D emitter to the 3D SYNC of the main projector.
- The 3D eyewear allows videos to be viewed in 3D by receiving synchronized optical signals output from the 3D emitter. As a result, the 3D image quality may be affected by conditions such as the brightness of the surroundings, screen size, viewing distance, etc.
- When playing a 3D video software on a computer, the 3D image quality may be affected if the computer CPU and graphics chip performance are low. Please check the required operating environment of the computer that is stated in the operating manual attached to the 3D video software.
- Depending on the signal, [FORMAT] and [L/R INVERT] may not be able to be selected. Please change the signal in that case.

When videos cannot be viewed in 3D

Please check the following points when videos cannot be viewed in 3D.

Please also read the operating manual attached to the 3D eyewear.

Possible reasons	Solutions
The selected signal does not support 3D output.	Please change the video signal input to one that supports 3D.
The format for the selected signal is turned to [OFF(2D)].	Please change the format in the on-screen menu to [AUTO] or a format that supports 3D.
A eyewear that is not supported by the projector is being used.	Please purchase a commercially-available 3D eyewear or 3D emitter (recommended). (→ page 53)
Please check the following points when a video cannot be viewed in 3D using a 3D eyewear that is supported by the projector.	
The power supply of the 3D eyewear is turned off.	Please turn on the power supply of the 3D eyewear.
The internal battery of the 3D eyewear is flat.	Please charge or replace the battery.
The viewer is located too far away from the screen.	Please get closer to the screen until the video can be seen in 3D. Please turn the [L/R INVERT] in the on-screen menu to [OFF].
Due to multiple 3D projectors working at the same time in the vicinity, the projectors may interfere with one another. Alternatively, there may be a bright light source near the screen.	Please maintain sufficient distance between the projectors.
	Please keep the light source away from the screen. Please turn the [L/R INVERT] in the on-screen menu to [OFF].
There is an obstacle between the optical receiver of the 3D eyewear and the 3D emitter.	Please remove the obstacle.
The 3D format of the 3D video contents is not supported.	Please check with the company selling the 3D video contents.

3-9. Controlling the Projector by Using an HTTP Browser

Overview

You can display the HTTP server screen of the projector by using a web browser and operating the projector with a computer or smartphone.

Possible operations on the HTTP server screen

- Operate the projector.
Operations such power on/off of the projector, input terminal switchover, and lens control etc. can be carried out.
- Adjusting the picture and projection screen, such as picture adjustment, geometric correction, edge blending, etc. is possible.
- Network settings (smartphones are not supported)
Configure the various settings when using the projector connected to a network (wired LAN). Also, it is possible to configure the connection settings with various control systems.

For details about settings and adjustments, see the explanation on the screen menu.

Important:

- The default [WIRED LAN] setting of this projector is set to [DISABLE] when it is shipped from the factory. To connect to a network, display the on-screen menu and change the [WIRED LAN] profile setting in the [NETWORK SETTINGS] from [DISABLE] to [PROFILE 1] or [PROFILE 2] to enable the [WIRED LAN].
- When setting up a [WIRED LAN] for the first time after purchasing the unit, be sure to set the [NETWORK PASSWORD].

To view the HTTP server screen

For computers

1. **Connect the projector to the computer with a LAN cable sold commercially. (→ page 168)**
2. **Select [SETUP] → [NETWORK SETTINGS] → [WIRED LAN] in the on-screen menu to configure the network settings. (→ page 143)**
3. **Start up the web browser on your computer and enter the address or URL in the input field.**

Specify the address or URL as "http://<IP Address of Projector>/index.html".

The HTTP server screen will be displayed.

For smartphones

1. **Connect a wireless LAN compatible router to the projector with a commercially available LAN cable.**
2. **Select [SETUP] → [NETWORK SETTINGS] → [WIRED LAN] in the on-screen menu to configure the network settings. (→ page 143)**
3. **Configure the network settings of the smartphone so that it can be connected to the projector.**

4. Start up the web browser and enter the address or URL in the input field.

Specify the address or URL as "http://<IP Address of Projector>/index.html".

The HTTP server screen will be displayed.

NOTE:

- To use the projector in a network, consult with your network administrator about network settings.
 - The display's or button's response can be slowed down or operation may not be accepted depending the settings of your network. Should this happen, consult your network administrator. The projector may not respond if its buttons are repeatedly pressed in rapid intervals. Should this happen, wait a moment and repeat. If you still can't get any response, turn off and back on the projector.
 - If the PROJECTOR NETWORK SETTINGS screen does not appear in the web browser, press the Ctrl+F5 keys to refresh your web browser (or clear the cache).
 - This projector uses "JavaScript" and "Cookies" and the browser should be set to accept these functions. The setting method will vary depending on the version of browser. Please refer to the help files and the other information provided in your software.
-

Preparation before Use

Connect the projector to a commercially available LAN cable before engaging in browser operations. (→ page 168)

Operation with a browser that uses a proxy server may not be possible depending on the type of proxy server and the setting method. Although the type of proxy server will be a factor, it is possible that items that have actually been set will not be displayed depending on the effectiveness of the cache, and the contents set from the browser may not be reflected in operation. It is recommended that a proxy server not be used unless it is unavoidable.

Handling of the Address for Operation via a Browser

Regarding the actual address that is entered for the address or entered to the URL column when operation of the projector is via a browser, the host name can be used as it is when the host name corresponding to the IP address of the projector has been registered to the domain name server by a network administrator, or the host name corresponding to the IP address of the projector has been set in the "HOSTS" file of the computer being used.

Example 1: When the host name of the projector has been set to "pj.nec.co.jp", access is gained to the network setting by specifying
http://pj.nec.co.jp/index.html
for the address or the entry column of the URL.

Example 2: When the IP address of the projector is "192.168.73.1", access is gained to the network setting by specifying
http://192.168.73.1/index.html
for the address or the entry column of the URL.

HTTP server screen

The screen size of the terminal being used is automatically determined to display the computer screen or smartphone screen.

You can also switch between the computer screen and the smartphone screen manually.

- When switching the display from a computer to a smartphone
Press the [SWITCH TO MOBILE] button at the top right of the screen.
- When switching the display from a smartphone to a computer
Press the menu button at the top left of the screen, and select [SWITCH TO PC PAGE].

Screen for computer

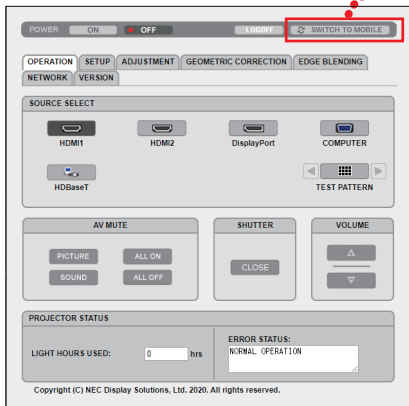

Screen for smartphone



3-10. Storing Changes for Lens Shift, Zoom, and Focus [LENS MEMORY]

This function serves to store the adjusted values when using the [LENS SHIFT], motorized [ZOOM], and motorized [FOCUS] functions of the projector. Adjusted values can be applied to the signal you selected. This will eliminate the need to adjust lens shift, focus, and zoom at the time of source selection. There are two ways to save adjusted values for lens shift, zoom, and focus.

Function name	Description	Page
REF. LENS MEMORY	Adjusted values common to all input signals. At the time of installation, two kinds of adjusted values can be stored. If no adjusted values have been saved to [LENS MEMORY], the lens will apply [REF. LENS MEMORY] adjusted values.	130
LENS MEMORY	Adjusted values for each input signal. Use the adjusted values for the signal with a different aspect ratio or resolution. The adjusted values can be applied at the time of source selection.	108

NOTE:

- Be sure to carry out [LENS CALIBRATION] after replacing the lens.
 - [LENS MEMORY] and [LENS CALIBRATION] are not available for the lens unit NP44ML.
-

To store your adjusted values in [REF. LENS MEMORY]:

1. Press the MENU button.

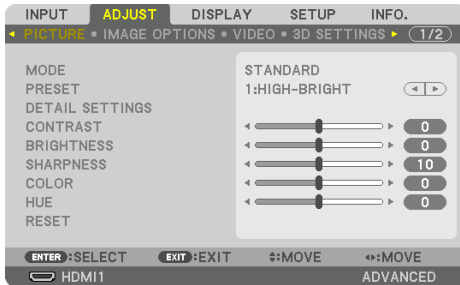

The menu will be displayed.

2. Press the ► button to select [SETUP] and press the ENTER button.



3. Press the ► button to select [INSTALLATION(2)].

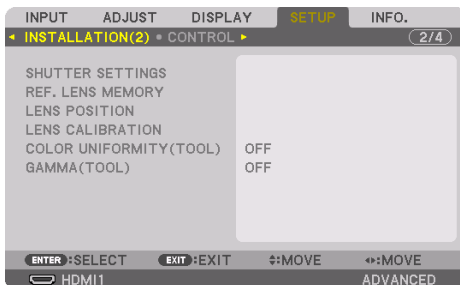

4. Press the ▼ button to select [REF. LENS MEMORY] and press the ENTER button.

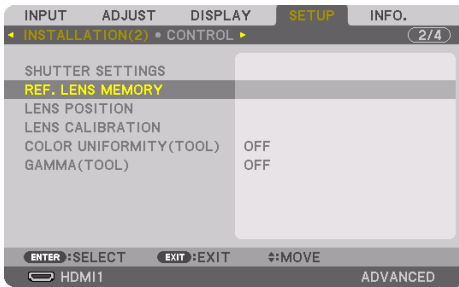

The [REF. LENS MEMORY] screen will be displayed.

5. Make sure [PROFILE] is highlighted, then press the ENTER button.

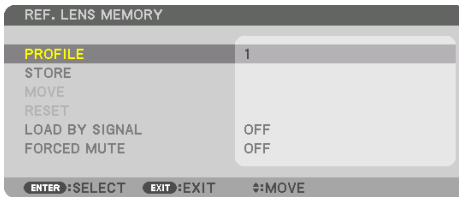

The [PROFILE] selection screen appears.

6. Press the ▼/▲ buttons to select the [PROFILE] number, then press the ENTER button.



Return to the [REF. LENS MEMORY] settings screen.

7. Select [STORE] and press the ENTER button.

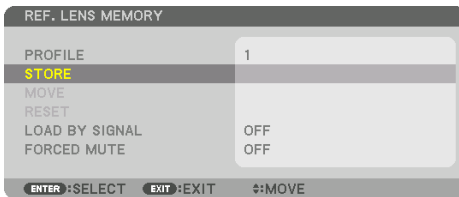

The confirmation screen will be displayed.

8. Press the ◀ button to select and [YES] and press the ENTER button.

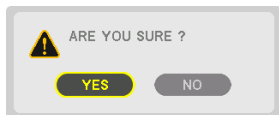

Select a [PROFILE] number and save the adjusted [LENS SHIFT], [ZOOM], and [FOCUS] values to it.

9. Press the MENU button.

The menu will be closed.

TIP:

- To store adjusted values for each input source, use the [LENS MEMORY] function. (→ page 108)
-

To call up your adjusted values from [REF. LENS MEMORY]:

1. Press the MENU button.

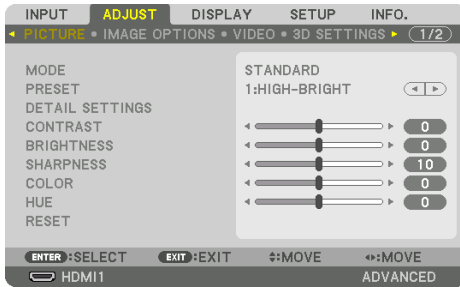

The menu will be displayed.

2. Press the ► button to select [SETUP] and press the ENTER button.



3. Press the ► button to select [INSTALLATION(2)].

4. Press the ▼ button to select [REF. LENS MEMORY] and press the ENTER button.

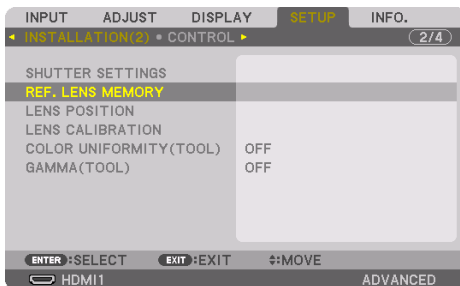

The [REF. LENS MEMORY] screen will be displayed.

5. Make sure [PROFILE] is highlighted, then press the ENTER button.

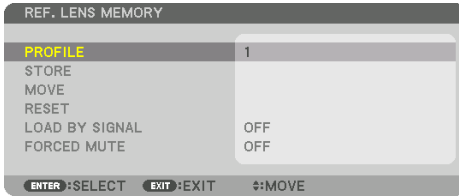

The [PROFILE] selection screen appears.

6. Press the ▼/▲ buttons to select the [PROFILE] number, then press the ENTER button.



Return to the [REF. LENS MEMORY] settings screen.

7. Select [MOVE] and press the ENTER button.

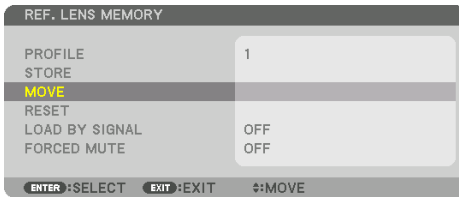

The lens will shift based on the adjusted values stored in the selected [PROFILE].

8. Press the ◀ button to select and [YES] and press the ENTER button.

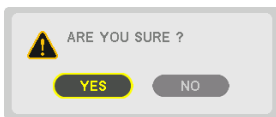

The adjusted values will be applied to the current signal. .

9. Press the MENU button.

The menu will be closed.

TIP:

To call up the stored values from [LENS MEMORY]:

1. From the menu, select [ADJUST] → [LENS MEMORY] → [MOVE] and press the ENTER button.

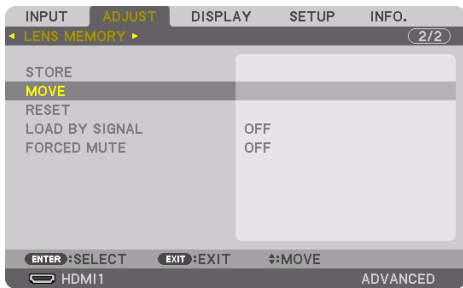

The confirmation screen will be displayed.

2. Press the ◀ button to select and [YES] and press the ENTER button.

During projection, if the adjusted values for an input signal have been saved, the lens will shift. If not, the lens will shift according to the adjusted values stored in the selected [REF. LENS MEMORY] → [PROFILE] number.

To automatically apply the stored values at the time of source selection:

1. From the menu, select [SETUP] → [REF. LENS MEMORY] → [LOAD BY SIGNAL] and press the ENTER button.



2. Press the ▼ button to select and [ON] and press the ENTER button.

This will move the lens automatically to the position at the time of source selection according to the adjusted values.



NOTE:

- The [LENS MEMORY] function may not produce a completely aligned image (due to tolerances in the lenses) using the adjusted values stored in the projector. After calling up and applying the stored values from the [LENS MEMORY] function, finely adjust the lens shift, motorized zoom and motorized focus to produce the best possible image.

4. Multi-Screen Projection

This projector can be used singly or arranged in multiple units for multi-screen projection.

4-1. Things that can be done using multi-screen projection

Case 1. Using a single projector to project two types of videos [PIP/PICTURE BY PICTURE]

Connection example and projection image

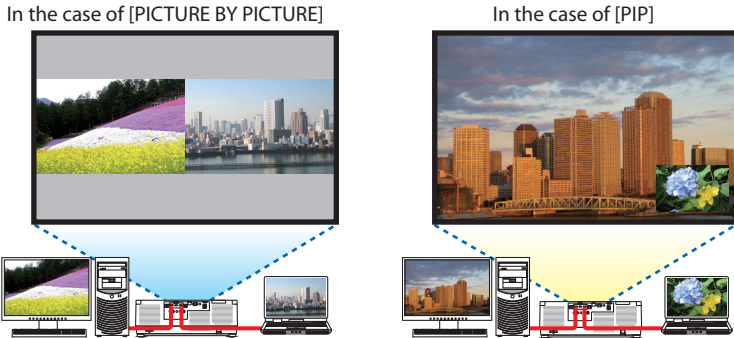

Case 2. Lien up multiple projectors to project a high-resolution image in a larger screen. [TILING]

Connection example and projection image

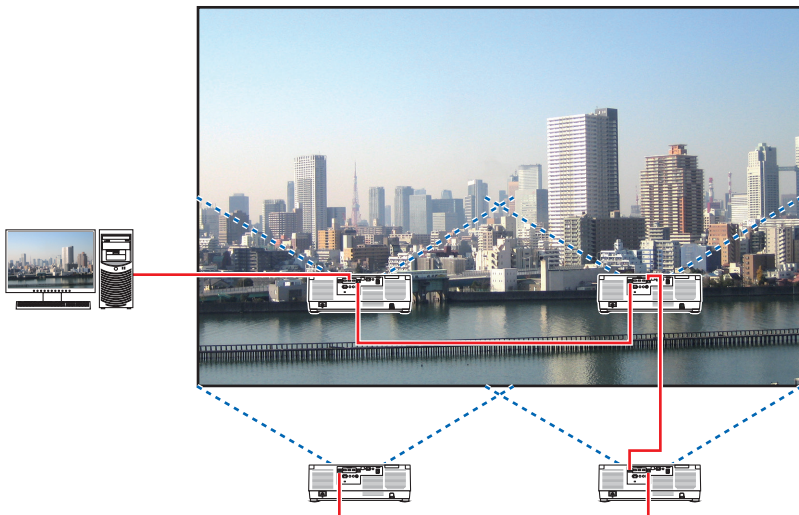

4-2. Using a single projector to project two types of videos at the same time [PIP/PICTURE BY PICTURE]

The projector has a feature that allows you to view two different signals simultaneously. You have two modes: [PIP] mode and [PICTURE BY PICTURE] mode.

The projection video in the first screen display is known as the main display while the projection video that is called out subsequently is known as the sub-display.

Select the projection function under [DISPLAY] → [PIP/PICTURE BY PICTURE] → [MODE] in the on-screen menu (the default factory setting when shipped is [PIP]). (→ page 111)

- A single screen is projected when power is turned on.

Picture in Picture function

A small sub-display is displayed inside the main display. The sub-display can be set up and adjusted as follows. (→ page 111, 112)

- Select whether to display the sub-display at the top right, top left, bottom right or bottom left of the screen (the size of the sub-display can be selected and the position can be fine-tuned)
- Switch the main display with the sub-display

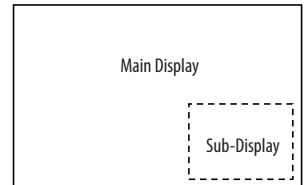

Picture by picture function

Display the main display and sub-display side by side. The main display and sub-display can be set up and adjusted as follows. (→ page 111, 112)

- Selecting the display boundary (ratio) of the main display and sub-display
- Switch the main display and sub-display

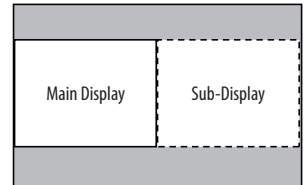

Input terminals that can be used for the main screen and sub-screen.

The main screen and sub-screen can provide the following input terminals.

- The main display and sub-display support computer signals up to WUXGA@60HzRB.

		Sub-Display or additional display				
		HDMI1	HDMI2	DisplayPort	COMPUTER	HDBaseT
Main Display	HDMI1	No	Yes	Yes	Yes	Yes
	HDMI2	Yes	No	Yes	Yes	Yes
	DisplayPort	Yes	Yes	No	Yes	Yes
	COMPUTER	Yes	Yes	Yes	No	Yes
	HDBaseT	Yes	Yes	Yes	Yes	No

NOTE:

- Some signals may not appear depending on the resolution.

Projecting two screens

- 1. Press the MENU button to display the on-screen menu and select [DISPLAY] → [PIP/PICTURE BY PICTURE].

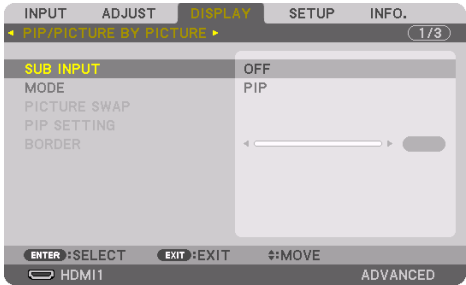

This displays the [PIP/PICTURE BY PICTURE] screen in the on-screen menu.

- 2. Select [SUB INPUT] using the ▼/▲ buttons, and press the ENTER button.

This displays the [SUB INPUT] screen.

- 3. Select the input signal using the ▼/▲ buttons, and press the ENTER button.

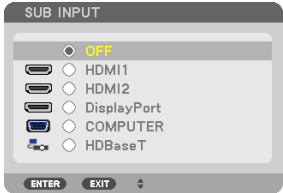

* This screen belongs to a HDBaseT model.

The [PIP] (PICTURE IN PICTURE) or [PICTURE BY PICTURE] screen set up under [MODE] is projected. (→ page 111)

- When the signal name is displayed in grey, this means that it cannot be selected.

- 4. Press the MENU button.

The on-screen menu will disappear.

- 5. When returning to single screen, display the [PIP/PICTURE BY PICTURE] screen one more time and select [OFF] in the [SUB INPUT] screen of the Step 3.

TIP:

- During dual-screen projection, if the selected input is not supported by the sub-screen, the sub-screen will appear as a black screen.

Switching the main display with the sub-display and vice versa

- 1. Press the MENU button to display the on-screen menu and select [DISPLAY] → [PIP/PICTURE BY PICTURE].

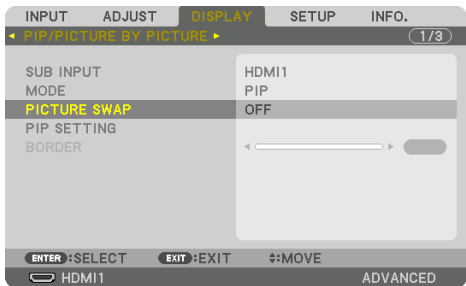

This displays the [PIP/PICTURE BY PICTURE] screen in the on-screen menu.

- 2. Select [PICTURE SWAP] using the ▼/▲ buttons and then press the ENTER button. Display the screen for switching the display positions.
- 3. Select [ON] using the ▼ button and then press the ENTER button.

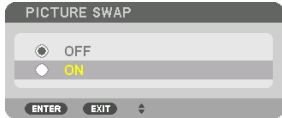

The video of the main display will switch with that of the sub-display.

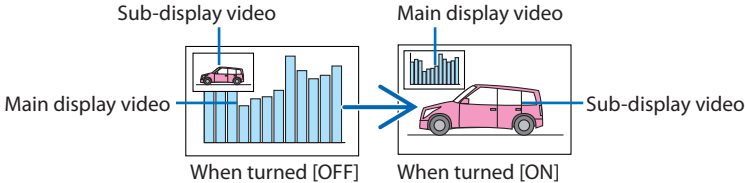

The signal output from the HDBaseT OUT/Ethernet terminal does not change even if the display positions are switched.

- 4. Press the MENU button.

The on-screen menu will disappear.

Restrictions

- The following operations are enabled only for the main display.
 - Audio-visual adjustments
 - Video magnification / compression using the partial VOL./D-ZOOM (+)(-) buttons.
However, magnification / compression is up to the positions set in [PICTURE BY PICTURE] → [BORDER] only.
 - TEST PATTERN
- [PIP/PICTURE BY PICTURE] cannot be used when a 3D video is being displayed.
- When using the [PIP/PICTURE BY PICTURE] function, [DYNAMIC CONTRAST] can not be used.
- [PIP/PICTURE BY PICTURE] cannot be used when the signal input has a resolution of 1920 × 1200 or more.
- The HDBaseT OUT/Ethernet port has a repeater function. The output resolution is limited by the maximum resolution of the connected monitor and projector.

4-3. Line up multiple projectors to display a high resolution image in a larger screen [TILING]

This section provides procedures for projecting an image with a resolution of 3840×2160 (4K UHD) by using four projectors.

Preparation:

- Arrange four projectors in a 2×2 layout.
Connect your video output equipment to the four projectors (→ page 167).
- Turn on the power of all devices to project the same four images

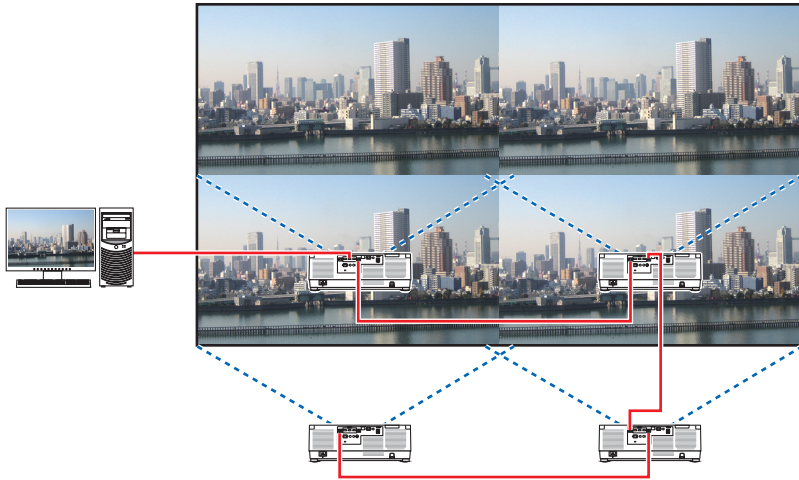

When performing settings or adjustments using one remote control, enable the [CONTROL ID] for assigning ID to each projector so as not to activate the other projectors. (→ page 138)

NOTE:

- When setting up the projector, assign a unique control ID to each projector.
- Set the "Color setting" and "DeepColor setting" on your Blu-ray player or computer to "Auto". Refer to the owner's manual accompanied with your Blu-ray player or computer for more information.
- Connect an HDMI output of your Blu-ray player or computer to the first projector and then connect to HDBaseT IN/Ethernet port of the second and subsequent projectors.
- Selecting another input source on the second and subsequent projectors will disable the HDBaseT repeater function.

Setting [TILING]

1. Press the **MENU** button to display the on-screen menu and select **[DISPLAY]** → **[PICTURE SETTING]** → **[MODE]**.

This displays the [MODE] screen.



2. Select **[TILING]** using the **▼/▲** buttons, and press the **ENTER** button.

The display returns to the [PICTURE SETTING] screen.



3. Select **[TILING]** using the **▼/▲** buttons, and press the **ENTER** button.

This displays the [TILING] screen.

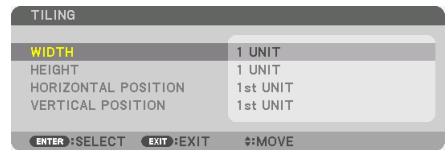

4. Set **[WIDTH]**, **[HEIGHT]**, **[HORIZONTAL POSITION]**, and **[VERTICAL POSITION]**

- (1) In the screen for setting the number of horizontal units, select [2 UNITS]. (number of units in the horizontal direction)
- (2) In the screen for setting the number of vertical units, select [2 UNITS]. (number of units in the vertical direction)
- (3) In the screen for setting the horizontal order, select [1st UNIT] or [2nd UNIT]. (look at the screens, the one on the left is the [1st UNIT] while the one on the right is the [2nd UNIT])
- (4) In the screen for setting the vertical order, select the [1st UNIT] or the [2nd UNIT]. (look at the screens, the one at the top is the [1st UNIT] while the one at the bottom is the [2nd UNIT])

After completing setting for the steps 1 to 4, a single image will be displayed to fill the screen.



5. Press the MENU button.

The on-screen menu will disappear.

To make boundaries less noticeable of a projected image, use [EDGE BLENDING] to adjust them.

(→ [next page](#))

4-4. Adjust boundaries of a projected image [EDGE BLENDING]

This projector is equipped with an "[EDGE BLENDING] Function" that makes the edges (boundaries) of the projection screen indistinguishable.

NOTE:

- Before performing the Edge Blending function, place the projector in the correct position so that the image becomes square in the appropriate size, and then make optical adjustments (lens shift, focus, and zoom).
- Adjust the brightness of each projector using [REF. LIGHT ADJUST] under [REF. LIGHT MODE]. In addition, use [REF. WHITE BALANCE] to adjust the [CONTRAST], [BRIGHTNESS] and [UNIFORMITY].

The following procedure shows an example of four projectors in a 2×2 layout.

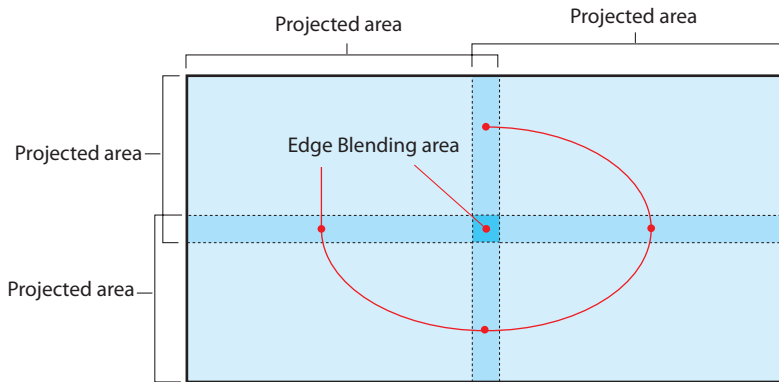

Setting the overlap of projection screens

① Enable [EDGE BLENDING].

1. Press the MENU button.

The menu will be displayed.

2. Select [DISPLAY] → [EDGE BLENDING].

The [EDGE BLENDING] screen will be displayed. Align the cursor with [MODE] and then press the ENTER button. The mode screen will be displayed.

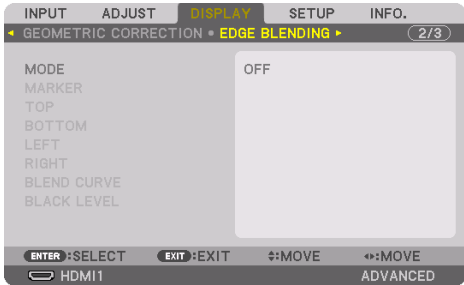

3. Select [MODE] → [ON] and press the ENTER button.



This enables the Edge Blending function. The following menu items are available: [MARKER], [TOP], [BOTTOM], [LEFT], [RIGHT], [BLEND CURVE], and [BLACK LEVEL]

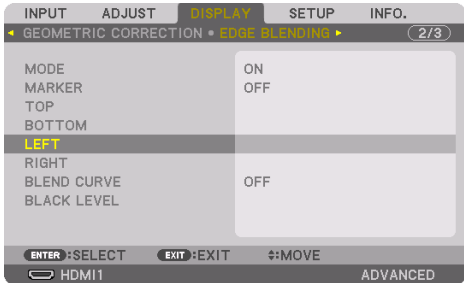

4. Select an appropriate item from [TOP], [BOTTOM], [LEFT], and [RIGHT] for an area of overlapped edges, and turn on [CONTROL].

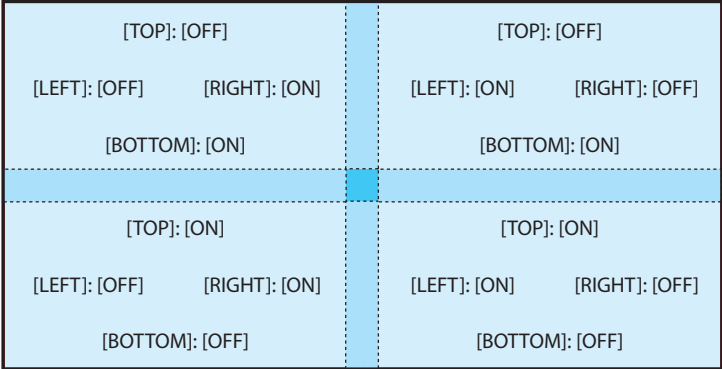

② Adjust [POSITION] and [RANGE] to determine an area of overlapped edges of images projected from each projector.

When [MARKER] is set to [ON], markers of four colors are displayed on the screen. The cyan and green markers represent the edges of the region where images overlap, the magenta and red markers represent the range of overlapping (region/width).

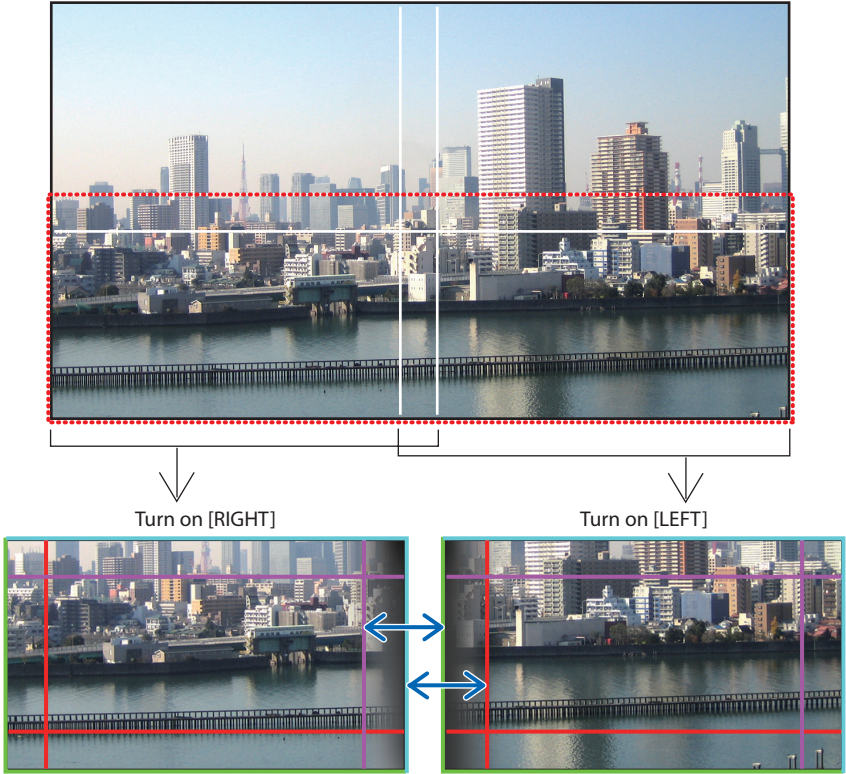

* The 2 screens are separated in the diagram for explanatory purposes.

Fit the edge of the overlapping area to the edge of the image with [POSITION], then adjust the overlapping area (width) with [RANGE]. In the case of the figure on the previous page, first set the cyan marker to the edge of the image on the left screen and the green marker to the edge of the image on the right screen. Next, adjust the magenta marker on the left screen onto the green marker on the right screen, and the red marker on the right screen onto the cyan marker on the left screen. Adjustment is completed when the markers are stacked and become white. Turn off [MARKER] to turn off the marker.

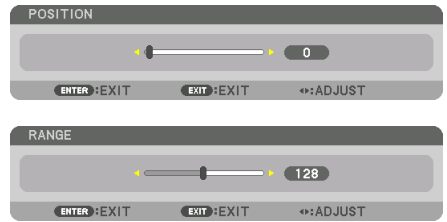

TIP:

- When displaying a signal with a different resolution, perform the Edge Blending function from the start.
- Setting of [MARKER] will not be saved and return to [OFF] when the projector is turned off.
- To display or hide the marker while the projector is running, turn on or off [MARKER] from the menu.

[BLEND CURVE]

Adjust the brightness of the overlapped section on the screens. According to the necessity, adjust the brightness of the overlapped section on the screens by the [BLEND CURVE] and [BLACK LEVEL].

- Set the [MODE] to [ON] for selecting [BLEND CURVE] and [BLACK LEVEL].

Selecting an option for the [BLEND CURVE]

By controlling the graduation of the overlapped section on the screens, it makes the border on the projected screens inconspicuous. Select the optimal option among nine.

1. On the On-Screen Menu, move the cursor onto the [DISPLAY] → [EDGE BLENDING] → [BLEND CURVE] and then press the ENTER. The option setting screen for the [BLEND CURVE] is displayed on.

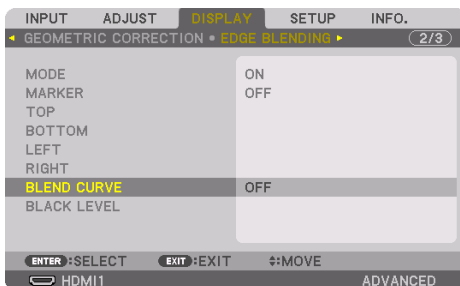

2. Select one option among nine by ▲ or ▼.

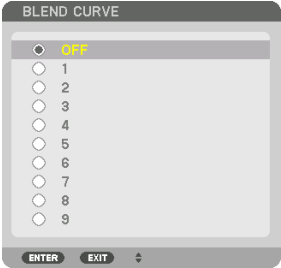

Black Level Adjustment

This adjusts the black level of the overlapping area and the non-overlapping area of the multi-screen (EDGE BLENDING).

Adjust the brightness level if you feel the difference is too large.

NOTE:

- Adjustable area varies depending on what combination of [TOP], [BOTTOM], [LEFT] and [RIGHT] are turned on.

The black level of the lower left projector is adjusted as shown in the figure.

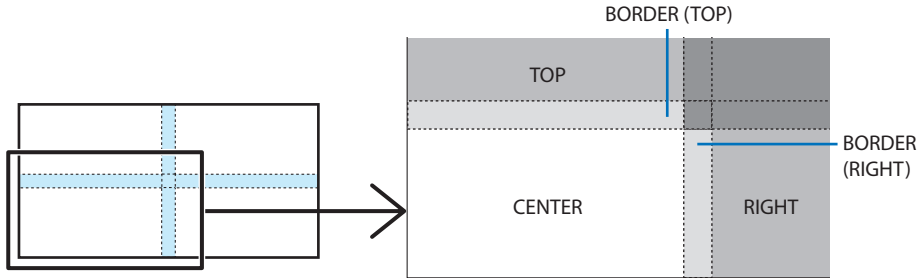

1. Select [DISPLAY] → [EDGE BLENDING] → [BLACK LEVEL] and press the ENTER button.

The screen will switch to the black level adjustment screen.



2. Use the ◀, ▶, ▼ or ▲ button to select an item and use the ◀ or ▶ to adjust the black level.

Do this for the other projector if necessary.

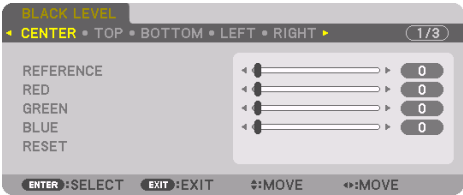

TIP:

- 9-segmented portions for Black Level adjustment
The black level of the center projector is adjusted as shown in the figure.

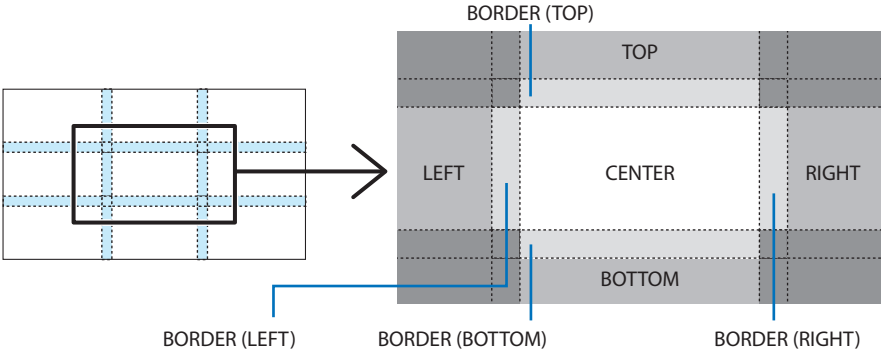

TIP:

- The number of black level division screens changes depending on the number of edge blending positions selected (top, bottom, right, left). In addition, when the top / bottom and left / right ends are selected, the corner division screen appears.
- The edge blending width is the width set in the range and the corner is formed by the intersecting area of the top / bottom ends or left / right ends.
- The [BLACK LEVEL] can be adjusted to make it brighter only.

Adjust using a computer or smartphone

[EDGE BLENDING] can be easily done using a computer or smartphone connected to the projectors via a network.

Connect to the HTTP server (→ page 56) and display the [EDGE BLENDING] tab.

Screen for computer

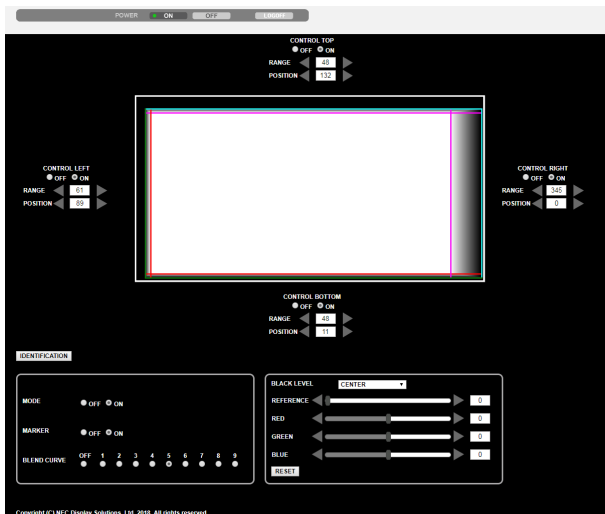

Screen for smartphone

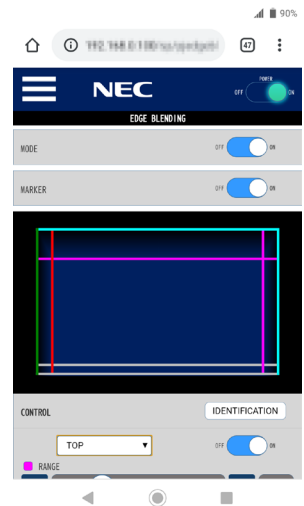

The [EDGE BLENDING] setting/adjustment items are displayed on one screen and can be operated using the mouse of the computer or the touch screen of the smartphone. For details of each setting/adjustment, refer to the On-Screen Menu explanation.

- [POSITION] and [RANGE] can be adjusted by moving the markers (cyan, green, magenta, red line) by clicking and dragging with the mouse (or swiping the smartphone).
- The following adjustment values can be finely adjusted with the ←/→ button on the keyboard:
 - POSITION
 - RANGE
 - [REFERENCE] for [BLACK LEVEL], [RED], [GREEN], [BLUE]
- To check which screen of the projector you are adjusting, press the [IDENTIFICATION] button. The identification message (IP address) will be displayed on the screen for 3 seconds.

5. Using On-Screen Menu

5-1. Using the Menus

NOTE:

- The on-screen menu may not be displayed correctly while interlaced motion video image is projected.

1. Press the MENU button on the remote control or the projector cabinet to display the menu.

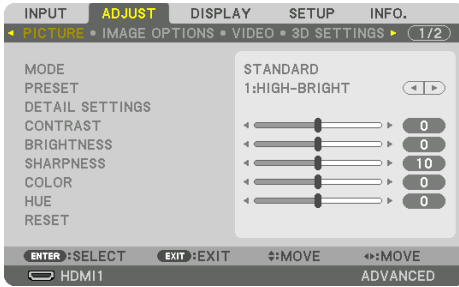

NOTE:

- The commands such as ENTER, EXIT, ▲▼, ◀▶ in the bottom show available buttons for your operation.

2. Press the ◀▶ buttons on the remote control or the projector cabinet to display the sub-menu.

3. Press the ENTER button on the remote control or the projector cabinet to highlight the top item or the first tab.

4. Use the ▲▼ buttons on the remote control or the projector cabinet to select the item you want to adjust or set.

You can use the ◀▶ buttons on the remote control or the projector cabinet to select the tab you want.

5. Press the ENTER button on the remote control or the projector cabinet to display the submenu window.

6. Adjust the level or turn the selected item on or off by using the ▲▼◀▶ buttons on the remote control or the projector cabinet.

Changes are stored until adjusted again.

7. Repeat steps 2-6 to adjust an additional item, or press the EXIT button on the remote control or the projector cabinet to quit the menu display.

NOTE:

- When a menu or message is displayed, several lines of information may be lost, depending on the signal or settings.

8. Press the MENU button to close the menu.

To return to the previous menu, press the EXIT button.

5-2. Menu Elements

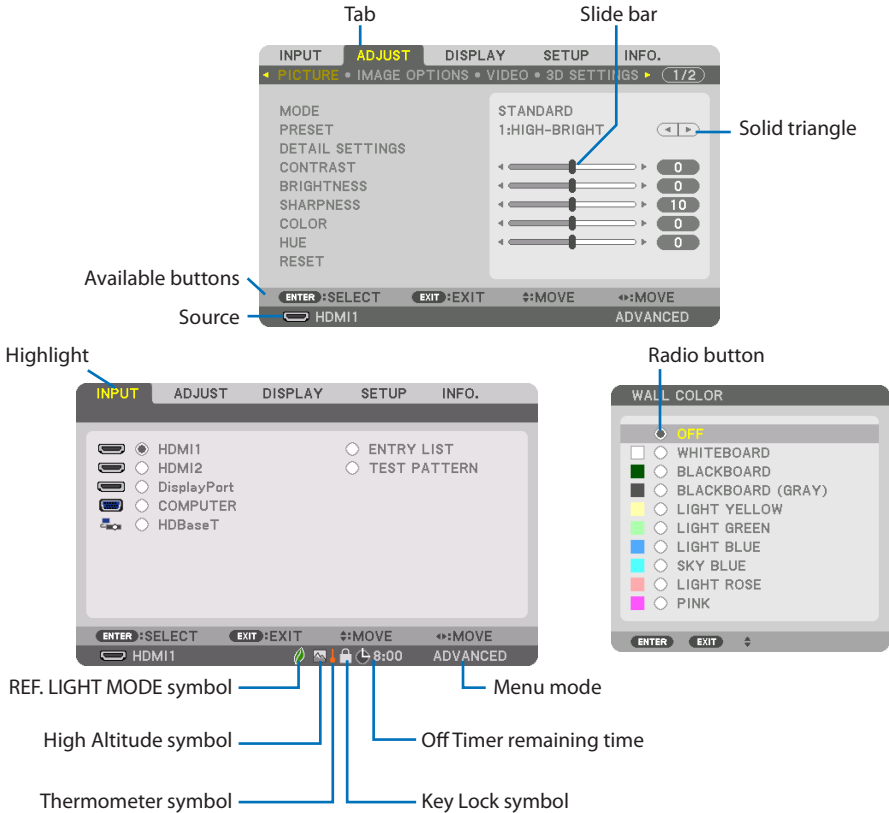

Menu windows or dialog boxes typically have the following elements:

Highlight	Indicates the selected menu or item.
Solid triangle	Indicates further choices are available. A highlighted triangle indicates the item is active.
Tab	Indicates a group of features in a dialog box. Selecting on any tab brings its page to the front.
Radio button	Use this round button to select an option in a dialog box.
Source	Indicates the currently selected source.
Menu mode	Indicates the current menu mode: [BASIC] or [ADVANCED].
Off Timer remaining time	Indicates the remaining countdown time when the [OFF TIMER] is preset.
Slide bar	Indicates settings or the direction of adjustment.
REF. LIGHT MODE symbol	Indicates [REF. LIGHT MODE] is set.
Key Lock symbol	Indicates the [CONTROL PANEL LOCK] is enabled.
Thermometer symbol	Indicates the [LIGHT MODE] is forcibly set to [ON] mode because the internal temperature is too high.
High Altitude symbol	Indicates the [FAN MODE] is set to [HIGH ALTITUDE] mode.

5-3. List of Menu Items

Some menu items are not available depending on the input source.

Menu Item		Default	Options		
INPUT	HDMI1	*			
	HDMI2	*			
	DisplayPort	*			
	COMPUTER	*			
	HDBaseT				
	ENTRY LIST				
	TEST PATTERN				
ADJUST	PICTURE	MODE	STANDARD	STANDARD, PROFESSIONAL	
		PRESET	*	AUTO, 1:HIGH-BRIGHT, 2:PRESENTATION, 3:VIDEO, 4:MOVIE, 5:GRAPHIC, 6:sRGB, 7:DICOM SIM.	
		DETAIL SETTINGS			
			GENERAL		
			REFERENCE	*	HIGH-BRIGHT, PRESENTATION, VIDEO, MOVIE, GRAPHIC, sRGB, DICOM SIM.
			GAMMA SETTING* ¹		
			SCREEN SIZE* ²	*	LARGE, MEDIUM, SMALL
			COLOR TEMPERATURE* ³	*	
			DYNAMIC CONTRAST	*	OFF, MOTION IMAGE, STILL IMAGE
			LIGHT MODE		
			LIGHT ADJUST	*	
			CONSTANT BRIGHTNESS	OFF	OFF, ON
			WHITE BALANCE		
			CONTRAST R	0	
			CONTRAST G	0	
			CONTRAST B	0	
			BRIGHTNESS R	0	
			BRIGHTNESS G	0	
			BRIGHTNESS B	0	
			COLOR CORRECTION		
			RED	0	HUE, SATURATION
			GREEN	0	HUE, SATURATION
			BLUE	0	HUE, SATURATION
			YELLOW	0	HUE, SATURATION
			MAGENTA	0	HUE, SATURATION
			CYAN	0	HUE, SATURATION
			CONTRAST	50	
			BRIGHTNESS	50	
			SHARPNESS	10	
			COLOR	50	
			HUE	0	
			RESET		

* The asterisk (*) indicates that the default setting varies depending on the signal.

*¹ The [GAMMA SETTING] item is available when an item other than [DICOM SIM.] is selected for [REFERENCE].

*² The [SCREEN SIZE] item is available when [DICOM SIM.] is selected for [REFERENCE].

*³ When [HIGH-BRIGHT] is selected in [REFERENCE], the [COLOR TEMPERATURE] is not available.

5. Using On-Screen Menu

		Menu Item	Default	Options		
ADJUST	IMAGE OPTIONS	CLOCK	*			
		PHASE	*			
		HORIZONTAL	*			
		VERTICAL	*			
		BLANKING	*	TOP, BOTTOM, LEFT, RIGHT		
		OVERSCAN		AUTO, 0[%], 5[%], 10[%]		
		ASPECT RATIO	AUTO	(HDTV/SDTV) AUTO, NORMAL, 4:3, LETTERBOX, WIDE SCREEN, ZOOM, FULL		
		AUTO	(COMPUTER) AUTO, NORMAL, 4:3, 5:4, 16:9, 15:9, 16:10, FULL, NATIVE			
		INPUT RESOLUTION*4	*	—		
	VIDEO	NOISE REDUCTION	RANDOM NR	*	OFF, LOW, MEDIUM, HIGH	
			MOSQUITO NR	OFF	OFF, LOW, MEDIUM, HIGH	
			BLOCK NR	OFF	OFF, LOW, MEDIUM, HIGH	
		DEINTERLACE		NORMAL	NORMAL, MOVIE, STILL	
		CONTRAST ENHANCEMENT	MODE	AUTO	OFF, AUTO, NORMAL	
			GAIN			
		SIGNAL TYPE		AUTO	AUTO, RGB, REC601, REC709, REC2020	
		VIDEO LEVEL		AUTO	AUTO, NORMAL, ENHANCED, SUPER WHITE	
	HDR MODE*5		AUTO	AUTO, OFF, ON		
	3D SETTINGS	FORMAT		AUTO	AUTO, OFF(2D), FRAME PACKING, SIDE BY SIDE(HALF), SIDE BY SIDE(FULL), TOP AND BOTTOM, FRAME ALTERNATIVE, LINE ALTERNATIVE	
		L/R INVERT		OFF	OFF, ON	
	LENS MEMORY	STORE				
MOVE						
RESET						
LOAD BY SIGNAL			OFF	OFF, ON		
FORCED MUTE			OFF	OFF, ON		
DISPLAY	PIP/PICTURE BY PICTURE	SUB INPUT	OFF	OFF, HDMI1, HDMI2, DisplayPort, COMPUTER, HDBaseT		
		MODE	PIP	PIP, PICTURE BY PICTURE		
		PICTURE SWAP		OFF	OFF, ON	
		PIP SETTING	START POSITION		TOP-LEFT	TOP-LEFT, TOP-RIGHT, BOTTOM-LEFT, BOTTOM-RIGHT
			HORIZONTAL POSITION			
			VERTICAL POSITION			
			SIZE		MEDIUM	LARGE, MEDIUM, SMALL
	BORDER					
	GEOMETRIC CORRECTION	MODE		OFF	OFF, KEYSTONE, CORNERSTONE, HORIZONTAL CORNER, VERTICAL CORNER, WARP, PC TOOL	
		KEYSTONE	HORIZONTAL			
			VERTICAL			
			TILT			
			THROW RATIO			
		CORNERSTONE			TOP-LEFT, TOP, TOP-RIGHT, LEFT, RIGHT, BOTTOM-LEFT, BOTTOM, BOTTOM-RIGHT	
		HORIZONTAL CORNER			TOP-LEFT, TOP, TOP-RIGHT, LEFT, RIGHT, BOTTOM-LEFT, BOTTOM, BOTTOM-RIGHT	
		VERTICAL CORNER			TOP-LEFT, TOP, TOP-RIGHT, LEFT, RIGHT, BOTTOM-LEFT, BOTTOM, BOTTOM-RIGHT	
		WARP			TOP-LEFT, TOP, TOP-RIGHT, LEFT, RIGHT, BOTTOM-LEFT, BOTTOM, BOTTOM-RIGHT	
PC TOOL			OFF	OFF, 1, 2, 3		
RESET						

*4 The [INPUT RESOLUTION] item can be selected for [COMPUTER] input.

*5 The [HDR MODE] item is available exclusively for 4K signal.

5. Using On-Screen Menu

		Menu Item	Default	Options	
DISPLAY	EDGE BLENDING	MODE	OFF	OFF, ON	
		MARKER	OFF	OFF, ON	
		TOP	CONTROL	ON	OFF, ON
			RANGE		
			POSITION		
		BOTTOM	CONTROL	ON	OFF, ON
			RANGE		
			POSITION		
		LEFT	CONTROL	ON	OFF, ON
			RANGE		
	POSITION				
	RIGHT	CONTROL	ON	OFF, ON	
		RANGE			
		POSITION			
	BLEND CURVE		5	OFF, 1, 2, 3, 4, 5, 6, 7, 8, 9	
	BLACK LEVEL	CENTER, TOP, BOTTOM, LEFT, RIGHT, BORDER(TOP), BORDER(BOTTOM), BORDER(LEFT), BORDER(RIGHT)		REFERENCE, RED, GREEN, BLUE, RESET	
	PICTURE SETTING	MODE		OFF	OFF, ZOOM, TILING
		ZOOM	HORIZONTAL ZOOM		
			VERTICAL ZOOM		
			HORIZONTAL POSITION		
			VERTICAL POSITION		
TILING		WIDTH		1 UNIT, 2 UNITS, 3 UNITS, 4 UNITS	
		HEIGHT		1 UNIT, 2 UNITS, 3 UNITS, 4 UNITS	
		HORIZONTAL POSITION		1st UNIT, 2nd UNIT, 3rd UNIT, 4th UNIT	
	VERTICAL POSITION		1st UNIT, 2nd UNIT, 3rd UNIT, 4th UNIT		
MULTI SCREEN	WHITE BALANCE	MODE	OFF	OFF, ON	
		CONTRAST W			
		CONTRAST R			
		CONTRAST G			
		CONTRAST B			
		BRIGHTNESS W			
		BRIGHTNESS R			
		BRIGHTNESS G			
SETUP	MENU(1)	LANGUAGE	ENGLISH	ENGLISH, DEUTSCH, FRANÇAIS, ITALIANO, ESPAÑOL, SVENSKA, 日本語 DANSK, PORTUGUÊS, ČEŠTINA, MAGYAR, POLSKI, NEDERLANDS, SUOMI NORSK, TÜRKÇE, РУССКИЙ, عربي, Ελληνικά, 简体中文, 한국어 ROMÂNĂ, HRVATSKA, БЪЛГАРСКИ, INDONESIA, हिन्दी, ไทย, تۆیغور, 繁體中文, Tiếng Việt	
		COLOR SELECT	COLOR	COLOR, MONOCHROME	
		OSD BRIGHTNESS	10	1, 2, 3, 4, 5, 6, 7, 8, 9, 10	
		INPUT DISPLAY	ON	OFF, ON	
		MESSAGE DISPLAY	ON	OFF, ON	
		ID DISPLAY	ON	OFF, ON	
		3D CAUTION MESSAGE	ON	OFF, ON	
		DISPLAY TIME	AUTO 45 SEC	MANUAL, AUTO 5 SEC, AUTO 15 SEC, AUTO 45 SEC	
		MENU ANGLE	0°	0°, 90°, 270°	
		MENU POSITION	CENTER	TOP-LEFT, TOP-CENTER, TOP-RIGHT, CENTER-LEFT, CENTER, CENTER-RIGHT, BOTTOM-LEFT, BOTTOM-CENTER, BOTTOM-RIGHT	
SETUP	MENU(2)				

5. Using On-Screen Menu

Menu Item		Default	Options	
INSTALLATION(1)	ORIENTATION		AUTO	AUTO, DESKTOP FRONT, CEILING REAR, DESKTOP REAR, CEILING FRONT
	SCREEN	SCREEN TYPE	FREE	FREE, 4:3 SCREEN, 16:9 SCREEN, 16:10 SCREEN
		POSITION		
	WALL COLOR		OFF	OFF, WHITEBOARD, BLACKBOARD, BLACKBOARD (GRAY), LIGHT YELLOW, LIGHT GREEN, LIGHT BLUE, SKY BLUE, LIGHT ROSE, PINK
	FAN MODE		AUTO	AUTO, NORMAL, HIGH, HIGH ALTITUDE
	REF. LIGHT MODE	REF. LIGHT MODE	NORMAL	BOOST, NORMAL, ECO1, ECO2
		REF. LIGHT ADJUST		
		CONSTANT BRIGHTNESS	OFF	OFF, ON
	REF. WHITE BALANCE	CONTRAST R		
		CONTRAST G		
		CONTRAST B		
		BRIGHTNESS R		
		BRIGHTNESS G		
		BRIGHTNESS B		
		UNIFORMITY R		
	STATIC CONVERGENCE	UNIFORMITY B		
		HORIZONTAL R		
		HORIZONTAL G		
		HORIZONTAL B		
		VERTICAL R		
		VERTICAL G		
INSTALLATION(2)	SHUTTER SETTINGS	POWER ON SHUTTER	OPEN	OPEN, CLOSE
		PICTURE MUTE SHUTTER	OPEN	OPEN, CLOSE
		FADE IN TIME		(This function is not available.)
		FADE OUT TIME	0	0–10 SEC
	REF. LENS MEMORY	PROFILE	1	1, 2
		STORE		
		MOVE		
		RESET		
		LOAD BY SIGNAL	OFF	OFF, ON
		FORCED MUTE	OFF	OFF, ON
LENS POSITION	HOME			
LENS CALIBRATION				
COLOR UNIFORMITY(TOOL)		OFF	OFF, 1, 2, 3	
GAMMA(TOOL)		OFF	OFF, 1, 2, 3	

5. Using On-Screen Menu

		Menu Item			Default	Options		
SETUP	CONTROL	TOOLS	ADMINISTRATOR MODE	MENU MODE			ADVANCED	ADVANCED, BASIC
				NOT SAVE SETTING VALUES			OFF	OFF, ON
				NEW PASSWORD				
				CONFIRM PASSWORD				
			PROGRAM TIMER	ENABLE			OFF	OFF, ON
				SETTINGS	EDIT	ACTIVE		
						DAY		
					TIME			
					FUNCTION			
					ADVANCED SETTINGS			
		REPEAT						
		DATE AND TIME SETTINGS	TIME ZONE SETTINGS					
			DATE AND TIME SETTINGS					
			SUMMER TIME SETTINGS					
		MOUSE	BUTTON			RIGHT HAND	RIGHT HAND, LEFT HAND	
			SENSITIVITY			MEDIUM	FAST, MEDIUM, SLOW	
		CONTROL PANEL LOCK				OFF	OFF, ON	
		SECURITY				OFF	OFF, ON	
		COMMUNICATION SPEED				38400bps	4800bps, 9600bps, 19200bps, 38400bps, 115200bps	
		PC CONTROL(HDBaseT)				OFF	OFF, ON	
	CONTROL ID	CONTROL ID NUMBER			1	1–254		
		CONTROL ID			OFF	OFF, ON		
	REMOTE SENSOR				FRONT/BACK	FRONT/BACK, FRONT, BACK, HDBaseT		
	NETWORK SETTINGS	NETWORK PASSWORD						
		WIRED LAN	INTERFACE				LAN, HDBaseT	
			PROFILES				DISABLE, PROFILE 1, PROFILE 2	
			DHCP				OFF, ON	
			IP ADDRESS					
			SUBNET MASK					
			GATEWAY					
			AUTO DNS				OFF, ON	
			DNS CONFIGURATION					
		RECONNECT						
PROJECTOR NAME		PROJECTOR NAME				pj-*****		
DOMAIN		HOST NAME				pj-*****		
		DOMAIN NAME						
ALERT MAIL		ALERT MAIL				OFF, ON		
		HOST NAME				pj-*****		
		DOMAIN NAME						
		SENDER'S ADDRESS						
		SMTP SERVER NAME						
		RECIPIENT'S ADDRESS 1						
		RECIPIENT'S ADDRESS 2						
		RECIPIENT'S ADDRESS 3						
TEST MAIL								

5. Using On-Screen Menu

Menu Item				Default	Options			
SETUP	NETWORK SETTINGS	NETWORK SERVICE	SERVICES	HTTP SERVER		ON	OFF, ON, AUTH.	
				PJLink	NEW PASSWORD			
					CONFIRM PASSWORD			
					CLASS		CLASS1, CLASS2	
					DESTINATION			
				AMX BEACON		OFF	OFF, ON	
				CRESTRON	ROOMVIEW	OFF	OFF, ON	
					CRESTRON CONTROL (ENABLE, CONTROLLER IP ADDRESS, IP ID)			
				Extron XTP		OFF	OFF, ON	
				PC CONTROL		ON	OFF, ON	
			AUTH. PC CONTROL		ON	OFF, ON		
			Art-Net	Art-Net	OFF	OFF, ON		
				[2.x.x.x]				
				[10.x.x.x]				
				SETTINGS				
			ACCOUNT	USER1, USER2, USER3	REGISTER			
					CHANGE USER NAME			
					CHANGE PASSWORD			
					ENABLE	ON	OFF, ON	
			DELETE					
			PASSCODE					
			SOURCE OPTIONS	AUTO ADJUST			NORMAL	OFF, NORMAL, FINE
				AUDIO SELECT	HDMI1	HDMI1	HDMI1, COMPUTER	
					HDMI2	HDMI2	HDMI2, COMPUTER	
					DisplayPort	DisplayPort	DisplayPort, COMPUTER	
					HDBaseT	HDBaseT	HDBaseT, COMPUTER	
				DEFAULT INPUT SELECT			LAST	LAST, AUTO, HDMI1, HDMI2, DisplayPort, COMPUTER, HDBaseT
	SEAMLESS SWITCHING			OFF	OFF, ON			
	BACKGROUND			BLUE	BLUE, BLACK, LOGO			
	HDBaseT OUT SELECT			OFF	OFF, AUTO, HDMI1, HDMI2, DisplayPort, HDBaseT			
	EDID VERSION	HDMI1		MODE1	MODE1, MODE2			
		HDMI2		MODE1	MODE1, MODE2			
	HDCP VERSION	HDMI1		HDCP 2.2	HDCP 2.2, HDCP 1.4			
		HDMI2		HDCP 2.2	HDCP 2.2, HDCP 1.4			
		HDBaseT		HDCP 1.4	HDCP 2.2, HDCP 1.4			
	POWER OPTIONS	POWER-SAVING			ON	OFF, ON		
		DIRECT POWER ON			OFF	OFF, ON		
		AUTO POWER ON SELECT			OFF	OFF, HDMI1, HDMI2, DisplayPort, COMPUTER, HDBaseT		
		AUTO POWER OFF			0:15	OFF, 0:05, 0:10, 0:15, 0:20, 0:30, 1:00		
		OFF TIMER			OFF	OFF, 0:30, 1:00, 2:00, 4:00, 8:00, 12:00, 16:00		
	RESET	CURRENT SIGNAL						
		ALL DATA						
		ALL DATA (INCLUDING ENTRY LIST)						

5. Using On-Screen Menu

		Menu Item	Default	Options
INFO.	USAGE TIME	LIGHT HOURS USED		
		PROJECTOR HOURS USED		
		TOTAL CARBON SAVINGS		
	SOURCE(1)	INPUT TERMINAL		
		RESOLUTION		
		HORIZONTAL FREQUENCY		
		VERTICAL FREQUENCY		
		SYNCTYPE		
		SYNC POLARITY		
		SCAN TYPE		
		SOURCE NAME		
	SOURCE(2)	ENTRY NO.		
		SIGNAL TYPE		
		BIT DEPTH		
		VIDEO LEVEL		
		SAMPLING FREQUENCY		
	SOURCE(3)	3D FORMAT		
		INPUT TERMINAL		
		RESOLUTION		
		HORIZONTAL FREQUENCY		
		VERTICAL FREQUENCY		
		SYNCTYPE		
		SYNC POLARITY		
		SCAN TYPE		
	SOURCE(4)	SOURCE NAME		
		ENTRY NO.		
		SIGNAL TYPE		
		BIT DEPTH		
		VIDEO LEVEL		
	WIRED LAN	SAMPLING FREQUENCY		
		3D FORMAT		
		IP ADDRESS		
		SUBNET MASK		
		GATEWAY		
	VERSION	MAC ADDRESS		
		DNS		
	OTHERS	SOFTWARE		
		DATE TIME		
		PROJECTOR NAME		
		MODEL NO.		
		SERIAL NUMBER		
		CONTROL ID*5		
	CONDITIONS	LENS ID		
INTAKE TEMPERATURE				
EXHAUST TEMPERATURE				
ATMOSPHERIC PRESSURE				
INSTALLATION POSITION				
X-AXIS				
Y-AXIS				
Z-AXIS				
	OPTION COVER			

*6 [CONTROL ID] will be displayed when [CONTROL ID] has been set up.

5. Using On-Screen Menu

		Menu Item	Default	Options
INFO.	HDBaseT	SIGNAL QUALITY		
		OPERATION MODE		
		LINK STATUS		
		HDMI STATUS		
	Art-Net(1)	Ch1		
		Ch2		
		Ch3		
		Ch4		
		Ch5		
		Ch6		
		Ch7		
		Ch8		
	Art-Net(2)	Ch9		
		Ch10		
		Ch11		
Ch12				

5-4. Menu Descriptions & Functions [INPUT]

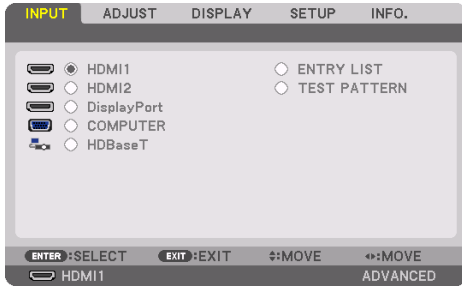

HDMI1

This projects the video of the device connected to the HDMI 1 IN terminal.

HDMI2

This projects the video of the device connected to the HDMI 2 IN terminal.

DisplayPort

This projects the video of the device connected to the DisplayPort IN terminal.

COMPUTER

This projects the video of the device connected to the computer video input terminal.
(This projects the analog RGB signal or component signal.)

HDBaseT

Projecting the HDBaseT signal.

ENTRY LIST

Displays a list of signals. See the following pages.

TEST PATTERN

Closes the menu and switches to the test pattern screen.

Using the Entry List

When any source adjustments are made, the adjustments are automatically registered in the Entry List. The (adjustment values of) registered signals can be loaded from the Entry List whenever necessary.

However, only up to 100 patterns can be registered in the Entry List. When 100 patterns have been registered in the Entry List, an error message is then displayed and no additional patterns can be registered. You should thus delete (adjustment values of) signals that are no longer needed.

Displaying the Entry list

1. Press the MENU button.

The menu will be displayed.

2. Press the ◀ or ▶ button to select [INPUT].

The [INPUT] list will be displayed.

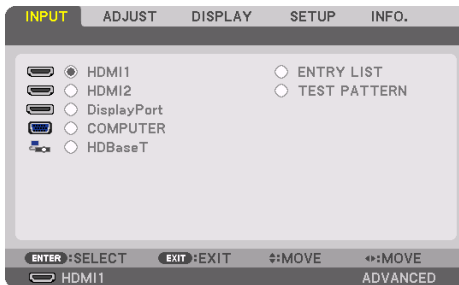

* This screen belongs to a HDBaseT model.

3. Use the ◀, ▶, ▲, or ▼ to select [ENTRY LIST] and press the ENTER button.

The [ENTRY LIST] windows will be displayed.

If the [ENTRY LIST] window is not displayed, switch the menu to [ADVANCED].

To switch the menu between [ADVANCED] and [BASIC], select [SETUP] → [CONTROL] → [TOOLS] → [ADMINISTRATOR MODE] → [MENU MODE]. (→ page 132)

ENTRY LIST					
NO.	SOURCE NAME	RESOLUTION	INPUT	✓	✓
001	1280x1024 60Hz	1024 x 768	HDMI1	✓	✓
002	NTSC358	1024 x 768	HDMI2	✓	✓
003	AAA	1024 x 768	DisplayPort	✓	✓
004	004	1024 x 768	HDMI1	✓	✓
005	005	1024 x 768	HDMI2	✓	✓
006	006	1024 x 768	DisplayPort	✓	✓
007	007	1024 x 768	HDMI1	✓	✓
008	008	1024 x 768	HDMI2	✓	✓
009	009	1024 x 768	DisplayPort	✓	✓
010	010	1024 x 768	HDMI1	✓	✓
011	011	1024 x 768	HDMI2	✓	✓
012	012	1024 x 768	DisplayPort	✓	✓
013	013	1024 x 768	HDMI1	✓	✓

Navigation buttons at the bottom: ENTER:LOAD, EXIT:EXIT, ⇄:MOVE, ⇄:MOVE

Entering the currently projected signal into the Entry List [(STORE)]

1. Press the ▲ or ▼ button to select any number.
2. Press the ◀ or ▶ button to select [ (STORE)] and press the ENTER button.

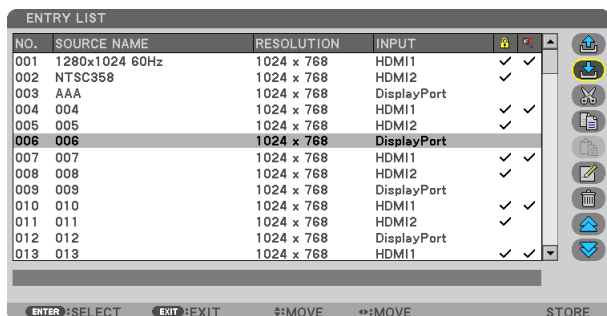

Calling up a signal from the Entry List [(LOAD)]



1. Press the ▲ or ▼ button to select a signal and press the ENTER button.

Editing a signal from the Entry List [(EDIT)]

1. Press the ▲ or ▼ button to select a signal you wish to edit.
2. Press the ◀, ▶, ▲, or ▼ button to select [ (EDIT)] and press the ENTER button.

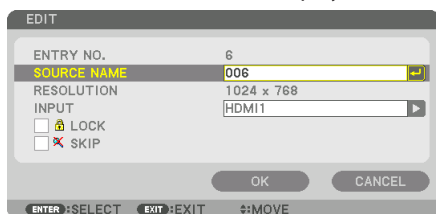
The [EDIT] window will be displayed.



SOURCE NAME	Enter a signal name. Up to 18 alphanumeric characters can be used.
INPUT	The input terminal can be changed. Switching between HDMI1/HDMI2/DisplayPort/COM-PUTER/HDBaseT is possible.
 LOCK	Set so that the selected signal cannot be deleted when [ (ALL DELETE)] is executed. The changes made after LOCK execution cannot be saved.
 SKIP	Set so that the selected signal will be skipped during auto search.

3. Set the above items and select [OK] and press the ENTER button.

NOTE:

- The input terminal cannot be changed to the currently projected signal.

Cutting a signal from the Entry List [(CUT)]

1. Press the ▲ or ▼ button to select a signal you wish to delete.
2. Press the ◀, ▶, ▲, or ▼ button to select [ (CUT)] and press the ENTER button.

The signal will be deleted from the Entry List and the deleted signal will be displayed on the clipboard at the bottom of the Entry List.



NOTE:

- The currently projected signal cannot be deleted.
 - When the locked signal is selected, it will be displayed in gray which indicates it is not available.
-

TIP:

- Data on the clipboard can be passed onto the Entry List.
 - Data on the clipboard will not be lost after the Entry List is closed.
-

Copying and pasting a signal from the Entry List [(COPY)] / [(PASTE)]

1. Press the ▲ or ▼ button to select a signal you wish to copy.
2. Press the ◀, ▶, ▲, or ▼ button to select [ (COPY)] and press the ENTER button.
The copied signal will be displayed on the clipboard at the bottom of the Entry List.
3. Press the ◀ or ▶ button to move to the list.
4. Press the ▲ or ▼ button to select a signal.
5. Press the ◀, ▶, ▲, or ▼ button to select [ (PASTE)] and press the ENTER button.

Data on the clipboard will be pasted to the signal.

Deleting all the signals from the Entry List [(ALL DELETE)]

1. Press the ◀, ▶, ▲, or ▼ button to select [ (ALL DELETE)] and press the ENTER button.
The confirmation message will be displayed.
2. Press the ◀ or ▶ button to select [YES] and press the ENTER button.

NOTE:

- The locked signal cannot be deleted.
-

Using Test Pattern [TEST PATTERN]

Displays the test pattern for adjusting distortion on the screen and the focus at the time of the projector setup. Once the [TEST PATTERN] on the onscreen menu is selected, the pattern for adjustment will be displayed on. If you find distortion on the pattern, adjust the projector installation angle or correct distortion by pressing the Geometric. button on the remote. If the focus adjustment is required, press the FOCUS button on the remote control for displaying the [FOCUS] adjustment screen and then adjust [FOCUS] by ◀ or ▶ button. Recommend to perform the focus adjustment after leaving the projector under the state the TEST PATTERN has been projected for over 30 minutes. Press EXIT button to close the test pattern and return to the menu.

5-5. Menu Descriptions & Functions [ADJUST]

[PICTURE]

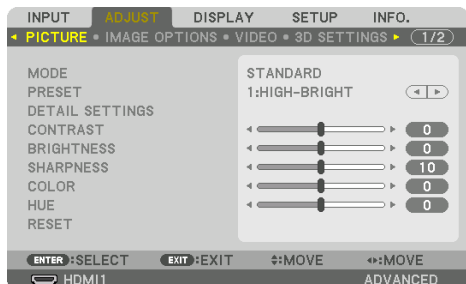

[MODE]

This function allows you to determine how to save settings for [DETAIL SETTINGS] of [PRESET] for each input.

STANDARD	Saves settings for each item of [PRESET] (Preset 1 through 7)
PROFESSIONAL	Saves all the settings of [PICTURE] for each input.

NOTE:

- When [TEST PATTERN] is displayed, [MODE] cannot be selected.

[PRESET]

This function allows you to select optimized settings for your projected image.

You can adjust neutral tint for yellow, cyan or magenta.

There are seven factory presets optimized for various types of images. You can also use [DETAIL SETTINGS] to set user adjustable settings to customize each gamma or color.

Your settings can be stored in [PRESET] 1 to [PRESET] 7.

AUTO	Automatically distinguish the optimal setting for the input signal.
HIGH-BRIGHT	Recommended for use in a brightly lit room.
PRESENTATION	Recommended for making a presentation using a PowerPoint file.
VIDEO	Recommended for typical TV program viewing.
MOVIE	Recommended for movies.
GRAPHIC	Recommended for graphics.
sRGB	Standard color values
DICOM SIM.	Recommended for DICOM simulation format.

NOTE:

- The [DICOM SIM.] option is for training/reference only and should not be used for actual diagnosis.
- DICOM stands for Digital Imaging and Communications in Medicine. It is a standard developed by the American College of Radiology (ACR) and the National Electrical Manufacturers Association (NEMA).

The standard specifies how digital image data can be moved from system to system.

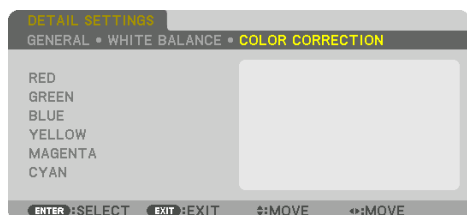
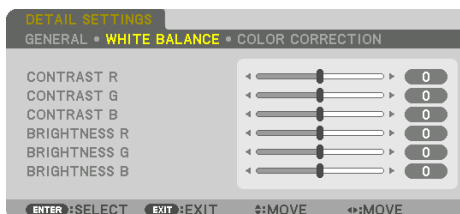
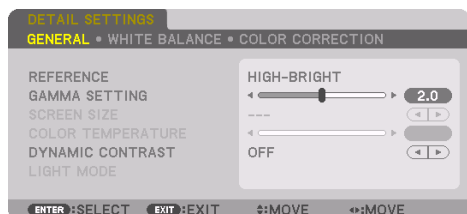
[DETAIL SETTINGS]**[GENERAL]****Storing Your Customized Settings [REFERENCE]**

This function allows you to store your customized settings in [PRESET 1] to [PRESET 7]. First, select a base preset mode from [REFERENCE], then set [GAMMA SETTING] and [COLOR TEMPERATURE].

HIGH-BRIGHT	Recommended for use in a brightly lit room.
PRESENTATION	Recommended for making a presentation using a PowerPoint file.
VIDEO	Recommended for typical TV program viewing.
MOVIE	Recommended for movies.
GRAPHIC	Recommended for graphics.
sRGB	Standard color values.
DICOM SIM.	Recommended for DICOM simulation format.

Adjusting the gradation of the picture [GAMMA SETTING]

Adjusts the gradation of the picture. With this, even dark areas can be reproduced vividly.

NOTE:

- This function is not available when [DICOM SIM.] is selected for [DETAIL SETTINGS].

Selecting Screen Size for DICOM SIM [SCREEN SIZE]

This function will perform gamma correction appropriate for the screen size.

LARGE	For screen size of 300"
MEDIUM	For screen size of 200"
SMALL	For screen size of 100"

NOTE:

- This function is available only when [DICOM SIM.] is selected for [DETAIL SETTINGS].

Adjusting Color Temperature [COLOR TEMPERATURE]

This option allows you to select the color temperature of your choice.

A value between 5000 K and 10500 K can be set in 100 K units.

NOTE:

- When [HIGH-BRIGHT] is selected in [REFERENCE], this function is not available.

Adjusting Brightness and Contrast [DYNAMIC CONTRAST]

When set, the most optimal contrast ratio is adjusted according to the video.

OFF	Dynamic contrast is disabled.
MOTION IMAGE	Most optimal settings for moving images.
STILL IMAGE	Most optimal settings for static images. Rapidly follows any changes in the video.

NOTE:

- [DYNAMIC CONTRAST] cannot be selected in the following cases.[]
 - When the [REF. LIGHT MODE] is set to [ECO2]
 - When the input terminal is selected for [SUB INPUT] under [PIP/PICTURE BY PICTURE]
 - When performing [GEOMETRIC CORRECTION]
 - When [EDGE BLENDING] → [MODE] is set to [ON]
 - When [PICTURE SETTING] → [MODE] is set to [ZOOM] or [TILING]
 - When [MULTI SCREEN] → [WHITE BALANCE] → [MODE] is set to [ON]
 - When [FAN MODE] is set to [HIGH] or [HIGH ALTITUDE]
 - When performing portrait projection

Adjusting Brightness [LIGHT MODE]

Adjust the brightness of the projector and save it for each input signal.

With the [REF. LIGHT MODE] set to [NORMAL], the adjustment will be valid if the [PICTURE] → [MODE] is set to [PROFESSIONAL]. (→ page 96, 128)

LIGHT ADJUST		Brightness can be adjusted in 1% increments from 50 to 100%.
CONSTANT BRIGHTNESS	OFF	[CONSTANT BRIGHTNESS] mode will be canceled.
	ON	<p>Maintains the brightness that is in effect at the time [ON] is selected. Unless [OFF] is selected, the same settings will remain in effect even when the projector is turned off.</p> <ul style="list-style-type: none"> To re-adjust the brightness, first turn this setting [OFF] before making further adjustments.
		<p>NOTE:</p> <ul style="list-style-type: none"> The [CONSTANT BRIGHTNESS] setting will not be saved for each input signal.

Adjusting White Balance [WHITE BALANCE]

This allows you to adjust the white balance. Contrast for each color (RGB) to adjust the white level of the screen; Brightness for each color (RGB) is used to adjust the black level of the screen.

[COLOR CORRECTION]

Corrects the color for all signals.

Adjusts the tone for the colors red, green, blue, yellow, magenta and cyan.

RED	HUE	+ Direction	Magenta direction
		– Direction	Yellow direction
	SATURATION	+ Direction	Vivid
		– Direction	Weak
GREEN	HUE	+ Direction	Yellow direction
		– Direction	Cyan direction
	SATURATION	+ Direction	Vivid
		– Direction	Weak
BLUE	HUE	+ Direction	Cyan direction
		– Direction	Magenta direction
	SATURATION	+ Direction	Vivid
		– Direction	Weak
YELLOW	HUE	+ Direction	Red direction
		– Direction	Green direction
	SATURATION	+ Direction	Vivid
		– Direction	Weak
MAGENTA	HUE	+ Direction	Blue direction
		– Direction	Red direction
	SATURATION	+ Direction	Vivid
		– Direction	Weak

CYAN	HUE	+ Direction	Green direction
		– Direction	Blue direction
	SATURATION	+ Direction	Vivid
		– Direction	Weak

[CONTRAST]

Adjusts the intensity of the image according to the incoming signal.

[BRIGHTNESS]

Adjusts the brightness level or the back raster intensity.

[SHARPNESS]

Controls the detail of the image.

[COLOR]

Increases or decreases the color saturation level.

[HUE]

Varies the color level from +/- green to +/- blue. The red level is used as reference.

NOTE:

- When [TEST PATTERN] is displayed, [CONTRAST], [BRIGHTNESS], [SHARPNESS], [COLOR] and [HUE] cannot be adjusted.

[RESET]

The settings and adjustments for [PICTURE] will be returned to the factory default settings with the exception of the following; Preset numbers and [REFERENCE] within the [PRESET] screen.

The settings and adjustments under [DETAIL SETTINGS] within the [PRESET] screen that are not currently selected will not be reset.

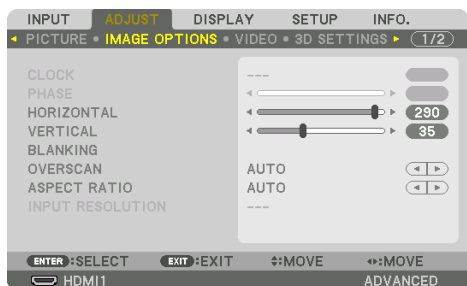
[IMAGE OPTIONS]**Adjusting Clock and Phase [CLOCK/PHASE]**

This allows you to manually adjust [CLOCK] and [PHASE].

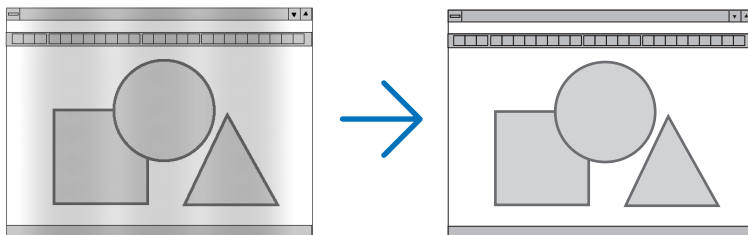

CLOCK	Use this item to fine tune the computer image or to remove any vertical banding that might appear. This function adjusts the clock frequencies that eliminate the horizontal banding in the image. This adjustment may be necessary when you connect your computer for the first time.
-------	--

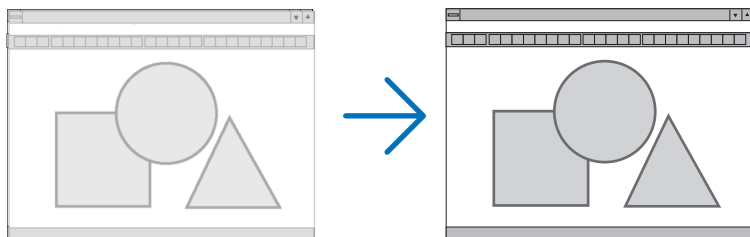

PHASE	Use this item to adjust the clock phase or to reduce video noise, dot interference or cross talk. (This is evident when part of your image appears to be shimmering.) Use [PHASE] only after the [CLOCK] is complete.
-------	---

NOTE:

- The [CLOCK] and [PHASE] items are available for RGB signals only.

Adjusting Horizontal/Vertical Position [HORIZONTAL/VERTICAL]

Adjusts the image location horizontally and vertically.

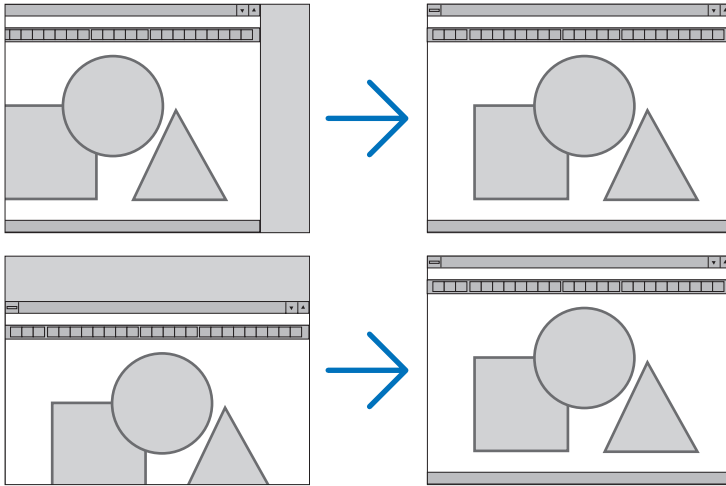
**NOTE:**

- An image can be distorted during the adjustment of [CLOCK] and [PHASE]. This is not malfunction.
- The adjustments for [CLOCK], [PHASE], [HORIZONTAL], and [VERTICAL] will be stored in memory for the current signal. The next time you project the signal with the same resolution, horizontal and vertical frequency, its adjustments will be called up and applied. To delete adjustments stored in memory, from the menu, you select [SETUP] → [RESET] → [CURRENT SIGNAL] and reset the adjustments.

[BLANKING]

Adjusts the display range (blanking) at the top, bottom, left and right edges of the input signal.

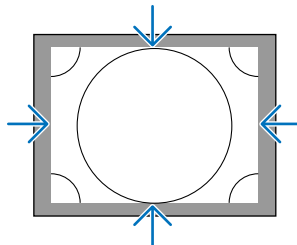
**NOTE:**

- This can be set when [3D SETTINGS] → [FORMAT] is set to [OFF(2D)].

Selecting Overscan Percentage [OVERSCAN]

Select overscan percentage (Auto, 0%, 5% and 10%) for signal.

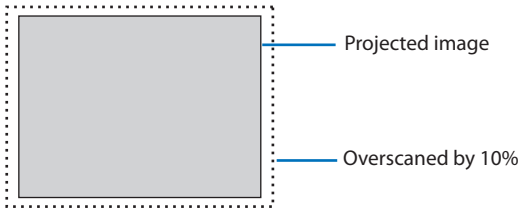

NOTE:

- The [OVERSCAN] item is not available:
 - when [NATIVE] is selected for [ASPECT RATIO].
-

Selecting the Aspect Ratio [ASPECT RATIO]

Use this function to select the screen's lateral:longitudinal aspect ratio.

The projector automatically identifies the signal being input and sets the optimum aspect ratio.

For Computer signal

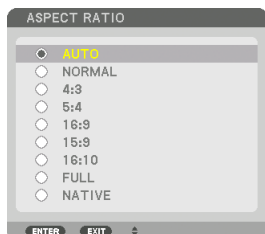

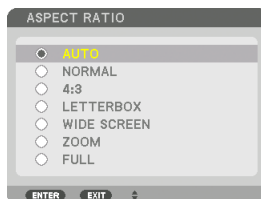

For HDTV/SDTV signals

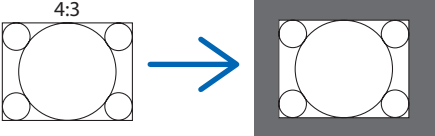
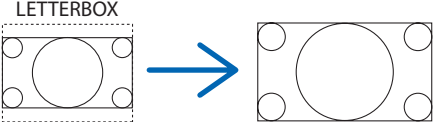
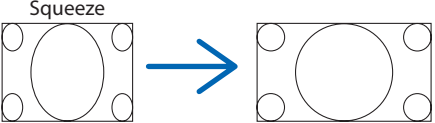

Resolution	Resolution	Aspect Ratio
VGA	640 × 480	4:3
SVGA	800 × 600	4:3
XGA	1024 × 768	4:3
WXGA	1280 × 768	15:9
WXGA	1280 × 800	16:10
HD(FWXGA)	1366 × 768	approx. 16:9
WXGA+	1440 × 900	16:10
SXGA	1280 × 1024	5:4
SXGA+	1400 × 1050	4:3
WXGA++	1600 × 900	16:9
UXGA	1600 × 1200	4:3
WSXGA+	1680 × 1050	16:10
FHD(1080P)	1920 × 1080	16:9
WUXGA	1920 × 1200	16:10
WQXGA	2560 × 1600	16:10
Quad HD	3840 × 2160	16:9
Quad HD	4096 × 2160	19:7

Options	Function
AUTO	The projector will automatically determine the incoming signal and display it in its aspect ratio. The projector may erroneously determine the aspect ratio depending on its signal. If this occurs, select the appropriate aspect ratio from the following.
NORMAL	The image is displayed in its original aspect ratio of its input signal.
4:3	The image is displayed in 4:3 aspect ratio.
5:4	The image is displayed in 5:4 aspect ratio
16:9	The image is displayed in 16:9 aspect ratio
15:9	The image is displayed in 15:9 aspect ratio
16:10	The image is displayed in 16:10 aspect ratio

Options	Function
NATIVE	<p>The projector displays the current image in its true resolution when the incoming computer signal has a lower or higher resolution than the projector's native resolution. (→ page 182)</p> <p>When the incoming computer signal has a higher resolution than the projector's native resolution, the center of an image will be displayed.</p> 
LETTERBOX	<p>The image of a letterbox signal (16:9) is stretched equally in the horizontal and vertical directions to fit the screen.</p> 
WIDE SCREEN	<p>The image of a squeeze signal (16:9) is stretched left and right in 16:9.</p> 
ZOOM	<p>The image of a squeeze signal (16:9) is stretched left and right in 4:3. Parts of the displayed image are cropped at the left and right edges and therefore not visible.</p> 
FULL	Project to full screen size.

TIP:

- Image position can be adjusted vertically using [POSITION] when the [16:9], [15:9], or [16:10] aspect ratios are selected.
- The term "letterbox" refers to a more landscape-oriented image when compared to a 4:3 image, which is the standard aspect ratio for a vide source.
The letterbox signal has aspect ratios with the vista size "1.85:1" or cinema scope size "2.35:1" for movie film.
- The term "squeeze" refers to the compressed image of which aspect ratio is converted from 16:9 to 4:3.

[INPUT RESOLUTION]

The resolution is assigned automatically when the resolution of the input signal from the computer video input terminal (analog RGB) cannot be distinguished.

[VIDEO]**Using Noise Reduction [NOISE REDUCTION]**

When projecting a video image, you can use the [NOISE REDUCTION] function to reduce the screen noise (roughness and distortion). This device is equipped with three types of noise reduction functions. Select the function according to the type of noise. Depending on the noise level, the noise reduction effect can be set to [OFF], [LOW], [MEDIUM] or [HIGH]. [NOISE REDUCTION] can be selected for SDTV, HDTV signal and component signal input.

RANDOM NR	Reduces flickering random noise in an image.
MOSQUITO NR	Reduces mosquito noise that appears around the edges of an image during Blu-ray playback.
BLOCK NR	Reduces block noise or mosaic-like patterns.

Selecting Interlaced Progressive Conversion Process Mode [DEINTERLACE]

This function allows you to select an interlaced-to-progressive conversion process for video signals.

NORMAL	Automatically distinguishes a moving image from a static image to create a distinct image. Please select [MOVIE] if there are any obvious jitter and noises.
MOVIE	Select when projecting moving images. This is suitable for signals with a lot of jitter and noise.
STILL	Select when projecting static images. The video will flicker when a moving image is projected.

[CONTRAST ENHANCEMENT]

Using the characteristics of the human eye, a picture quality with a sense of contrast and resolution is achieved.

OFF	[CONTRAST ENHANCEMENT] function is disabled.
AUTO	Contrast and picture quality are automatically improved using this function.
NORMAL	Adjust the gain manually.

[SIGNAL TYPE]

Selection of RGB and component signals. Normally, this is set to [AUTO]. Please change the setting if the color of the image remains unnatural.

AUTO	Automatically distinguishes RGB and component signals.
RGB	Switches to the RGB input.
REC601	Switches to the component signal conforming to the ITU-R Rec601 standard. Setting appropriate to SDTV images.
REC709	Switches to the component signal conforming to the ITU-R Rec709 standard. Setting appropriate to Hi-Vision images.
REC2020	Switches to the component signal conforming to the ITU-R Rec2020 standard. Setting appropriate to 4K images.

[VIDEO LEVEL]

Selection of the video signal level when connecting an external device to the HDMI 1 IN terminal, HDMI 2 IN terminal, DisplayPort input terminal, and HDBaseT IN terminal of the projector.

AUTO	The video level is switched automatically based on the information from the device outputting the signal. Depending on the connected device, this setting may not be made properly. In this case, switch to [NORMAL] or [ENHANCED] from the menu and view with the optimum setting.
NORMAL	This disables the enhanced mode.
ENHANCED	This improves the image's contrast, expressing the dark and light sections more dynamically.
SUPER WHITE	The video contrast is improved and the dark areas appear more dynamic.

[HDR MODE]

AUTO	Automatically distinguishes HDR signal.
OFF	Projects the image based on the input signal
ON	Projects the image conforming to the HDR signal

NOTE:

- These options are available exclusively for 4K signal.

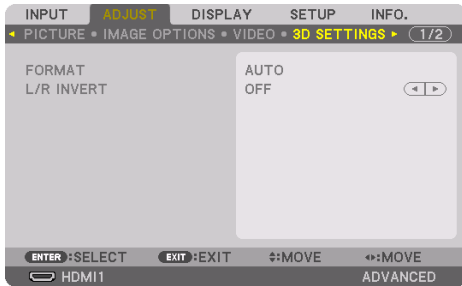
[3D SETTINGS]**[FORMAT]**

Select the 3D video format (recording / transmission format). Select to match the 3D broadcast and 3D media. Normally, [AUTO] is selected. Please select the 3D input signal format when the 3D detection signal of the format cannot be distinguished.

[L/R INVERT]

Invert the display order of the left and right videos.

Select [ON] if you feel uncomfortable with the 3D display when [OFF] is selected.

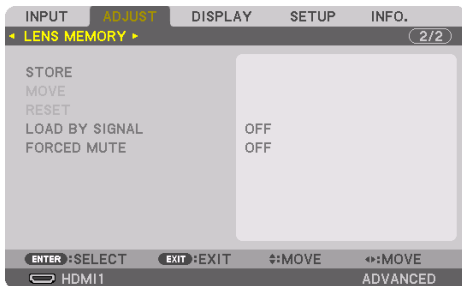
Using the Lens Memory Function [LENS MEMORY]

This function serves to store the adjusted values for each input signal when using the [LENS SHIFT], motorized [ZOOM], and motorized [FOCUS] functions of the projector. Adjusted values can be applied to the signal you selected. This will eliminate the need to adjust lens shift, focus, and zoom at the time of source selection.

STORE	Stores the current adjusted values in memory for each input signal.
MOVE	Applies the adjusted values to the current signal.
RESET	Returns the adjusted values to the last condition.
LOAD BY SIGNAL	Moves the lens to the registered lens adjustment position when the signal is switched.
FORCED MUTE	Select whether to mute the picture or not when moving the lens.

- This function is not available for the lens unit NP44ML.

TIP:

- Lens memory adjustments will be automatically registered the [ENTRY LIST]. These lens memory adjustments can be loaded from the [ENTRY LIST]. (→ page 93)
Note that performing [CUT] or [ALL DELETE] in the [ENTRY LIST] will delete lens memory adjustments as well as source adjustments. This deletion will not take effect until other adjustments is loaded.
- For storing each adjustment of [LENS SHIFT], motorized [ZOOM], and motorized [FOCUS] as common value for all input signal, store them as [REF. LENS MEMORY].

To store your adjusted values in [LENS MEMORY]:

1. **Project the connected device signal you want to adjust.**
2. **Adjust the projecting image of position, size and focus by the SHIFT/HOME POSITION, ZOOM +/-, and FOCUS +/- buttons.**
 - Adjustment can be performed by the remote control. Please refer to “2-5 Adjusting the Picture Size and Position” on page 26.
 - Slight adjustment by moving the projector position and by the tilt foot is not subject of [LENS MEMORY].
3. **Move the cursor on [STORE] and press ENTER.**

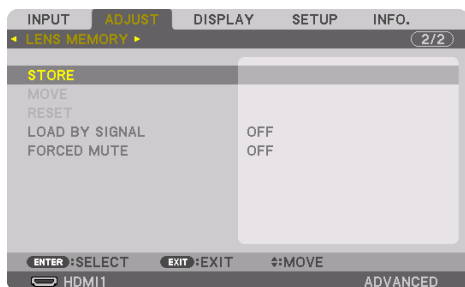

4. **Move the cursor on [YES] and press ENTER.**

To call up the adjusted values from [LENS MEMORY]:

1. **From the menu, select [ADJUST] → [LENS MEMORY] → [MOVE] and press the ENTER button.**

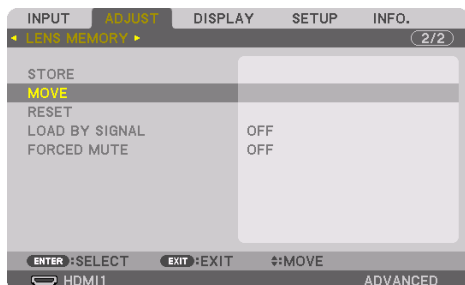

The confirmation screen will be displayed.

2. Press the ◀ button to select and [YES] and press the ENTER button.

During projection, if the adjusted values for an input signal have been saved, the lens will shift. If not, the lens will shift according to the adjusted values stored in the selected [REF. LENS MEMORY] → [PROFILE] number.

To automatically apply the adjusted values at the time of source selection:

1. From the menu, select [LOAD BY SIGNAL] and press the ENTER button.

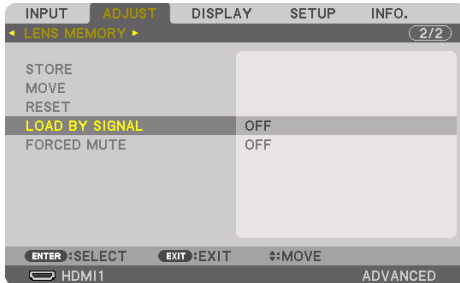

2. Press the ▼ button to select and [ON] and press the ENTER button.

This will move the lens automatically to the position at the time of source selection according to the adjusted values.



NOTE:

- The [LENS MEMORY] function may not produce a completely aligned image (due to tolerances in the lenses) using the adjusted values stored in the projector. After calling up and applying the adjusted values from the [LENS MEMORY] function, finely adjust the [LENS SHIFT], [ZOOM] and [FOCUS] to produce the best possible image.

5-6. Menu Descriptions & Functions [DISPLAY]

[PIP/PICTURE BY PICTURE]

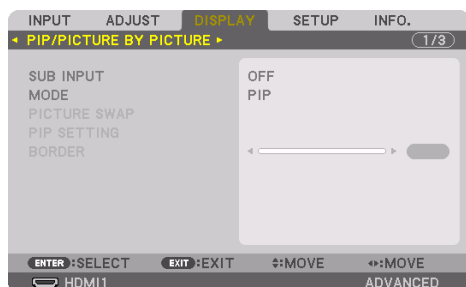

SUB INPUT

Select the input signal to be displayed in the sub-display.

Please refer to “4-2. Using a single projector to project two types of videos at the same time [PIP/PICTURE BY PICTURE]” (→ page 67) for details on the operation.

MODE

Select either [PIP] (PICTURE IN PICTURE) or [PICTURE BY PICTURE] when switching to 2-screen display.

PICTURE SWAP

The videos in the main display and sub-display will be switched.

Please refer to “4-2. Using a single projector to project two types of videos at the same time [PIP/PICTURE BY PICTURE]” (→ page 67) for details.

PIP SETTING

Select the display position, position adjustment and size of the sub-display in the [PIP] screen.

START POSITION	Selection of the display position of the sub-display when switching to the [PIP] screen.
HORIZONTAL POSITION	Adjust the display position of the sub-display in the horizontal direction. The respective corners will serve as reference points.
VERTICAL POSITION	Adjust the display position of the sub-display in the vertical direction. The respective corners will serve as reference points.
SIZE	Select the display size of the sub-display.

TIP:

- The [HORIZONTAL POSITION] and [VERTICAL POSITION] are the amount of movement from the reference points. For example, when [TOP-LEFT] is adjusted, the position is displayed with the same amount of movement even if displayed with other [START POSITION] settings.

The maximum amount of movement is half the resolution of the projector.

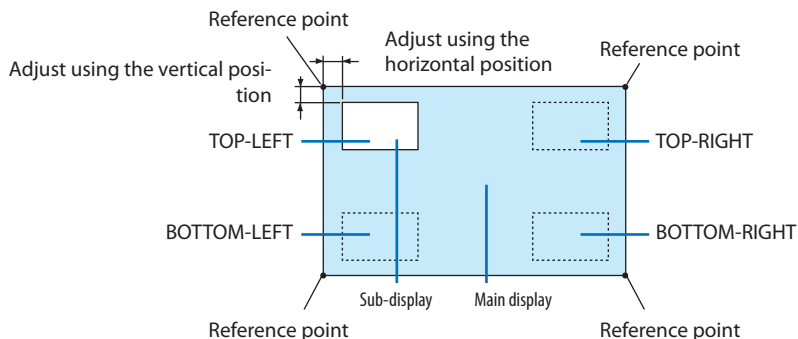

BORDER

Select the display boundary of the main display and sub-display of the [PICTURE BY PICTURE] screen.

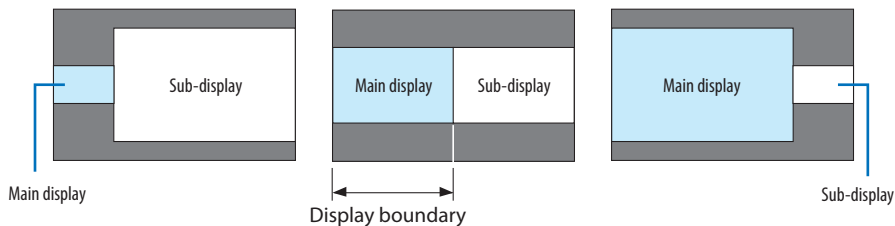

TIP:

- Seven options from zero to six are available.

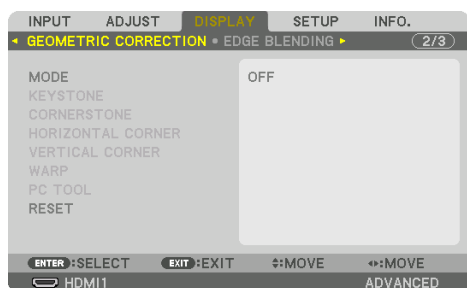
[GEOMETRIC CORRECTION]**MODE**

Set pattern for correcting distortion. If [OFF] is selected, the [GEOMETRIC CORRECTION] becomes ineffective.

NOTE:

- If you need to change the [MENU ANGLE], make sure to change it before performing the [GEOMETRIC CORRECTION]. If [MENU ANGLE] is changed after performing the [GEOMETRIC CORRECTION], corrected values will be reset to the default values.
- This can be set when [3D SETTINGS] → [FORMAT] is set to [OFF(2D)].

KEYSTONE

Correct distortion in horizontal and vertical directions.

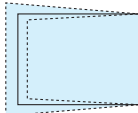
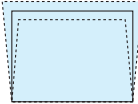
HORIZONTAL	Adjustments when projecting from a diagonal direction to the screen.																							
VERTICAL	Adjustments when projecting from the top or bottom direction to the screen.																							
TILT	Adjusts the distortion when performing trapezoidal correction with the screen moved in the vertical direction using the lens shift.																							
THROW RATIO	Adjusts according to the projection ratio of the optional lens used.																							
	<table border="1"> <thead> <tr> <th>Model name of lens unit</th> <th>Adjustment range</th> </tr> </thead> <tbody> <tr> <td>NP11FL</td> <td>8</td> </tr> <tr> <td>NP12ZL</td> <td>12–15</td> </tr> <tr> <td>NP13ZL</td> <td>15–30</td> </tr> <tr> <td>NP14ZL</td> <td>29–47</td> </tr> <tr> <td>NP15ZL</td> <td>46–71</td> </tr> </tbody> </table>	Model name of lens unit	Adjustment range	NP11FL	8	NP12ZL	12–15	NP13ZL	15–30	NP14ZL	29–47	NP15ZL	46–71	<table border="1"> <thead> <tr> <th>Model name of lens unit</th> <th>Adjustment range</th> </tr> </thead> <tbody> <tr> <td>NP40ZL</td> <td>8–11</td> </tr> <tr> <td>NP41ZL</td> <td>13–30</td> </tr> <tr> <td>NP43ZL</td> <td>30–60</td> </tr> <tr> <td>NP44ML</td> <td>3</td> </tr> </tbody> </table>	Model name of lens unit	Adjustment range	NP40ZL	8–11	NP41ZL	13–30	NP43ZL	30–60	NP44ML	3
Model name of lens unit	Adjustment range																							
NP11FL	8																							
NP12ZL	12–15																							
NP13ZL	15–30																							
NP14ZL	29–47																							
NP15ZL	46–71																							
Model name of lens unit	Adjustment range																							
NP40ZL	8–11																							
NP41ZL	13–30																							
NP43ZL	30–60																							
NP44ML	3																							

NOTE:

- When power is supplied to the device, the adjustment value of the [KEYSTONE] used previously is retained even if the gradient of the device is changed.
- As electrical correction is carried out by [KEYSTONE], the brightness may be reduced or the screen quality may deteriorate sometimes.

CORNERSTONE

Display the 4-point correction screen and adjust the trapezoidal distortion of the projection screen. Please refer to "Correcting Horizontal and Vertical Keystone Distortion [CORNERSTONE]" (→ page 45) for details on the operation.

HORIZONTAL CORNER/VERTICAL CORNER

Distortion correction for corner projection such as wall surfaces.

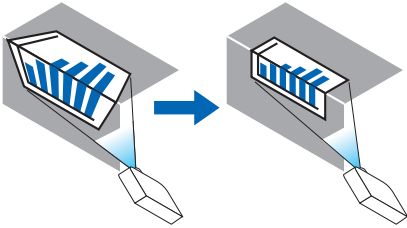
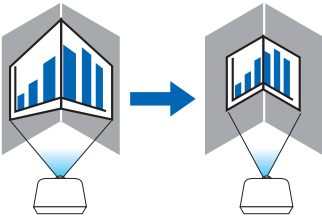
HORIZONTAL CORNER	<p>Performs correction for projection onto a wall lying at an angle to the horizontal direction.</p>  <p>* Reverse angle correction is also possible.</p>
VERTICAL CORNER	<p>Performs correction for projection onto a wall lying at an angle to the vertical direction.</p>  <p>* Reverse angle correction is also possible.</p>

NOTE:

- When the maximum adjustment range is exceeded, distortion adjustment is disabled. Set up the projector at an optimal angle as the deterioration in the image quality increases as the distortion adjustment volume gets larger.
- Please note that the image will go out of focus due to the difference in the distance between the upper and lower or left and right sides and the center of the screen for projections cutting across corners. Lenses with short focal points are also not recommended for projections cutting across corners as the image will go out of focus.

Adjustment method

1. **Align the cursor with the [HORIZONTAL CORNER] or [VERTICAL CORNER] of the [GEOMETRIC CORRECTION] menu and then press the ENTER button.**
 - The adjustment screen will be displayed.
2. **Press the ▼▲◀▶ buttons to align the cursor (yellow box) with the target adjustment point and then press the ENTER button.**
 - The cursor will change into an adjustment point (yellow in color).
3. **Press the ▼▲◀▶ buttons to adjust the corners or sides of the screen and then press the ENTER button.**
 - The adjustment point will go back to being a cursor (yellow box).

Explanation of screen transition

- The adjustment points of the four corners (a, c, f and h in the drawing) will move independently.
- The following adjustment points differ at the [HORIZONTAL CORNER] and [VERTICAL CORNER].

HORIZONTAL CORNER: When Point b in the drawing is moved, and the upper side and Point g are moved, the lower side will move in a parallel manner.

VERTICAL CORNER: When Point d in the drawing is moved, and the left side and Point e are moved, the right side will move in a parallel manner.

[Adjustment points of the [HORIZONTAL CORNER] screen and movement points of the projection screen]

Point b will be displaced in a parallel manner at the same time as Points a, b, c

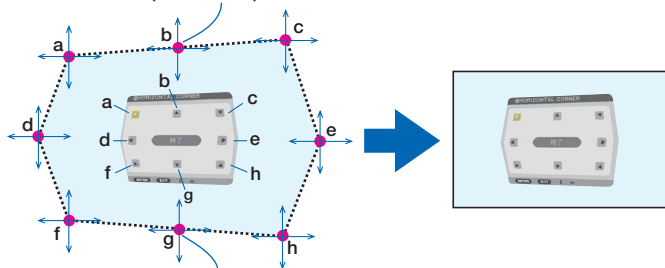

Point g will be displaced in a parallel manner at the same time as Points f, g, h

[Adjustment points of the [VERTICAL CORNER] screen and movement points of the projection screen]

Point d will be displaced in a parallel manner at the same time as Points a, d, f

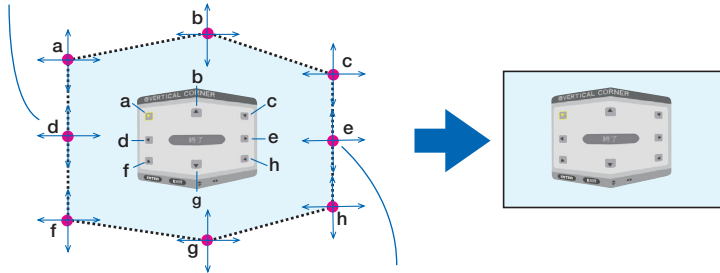

Point e will be displaced in a parallel manner at the same time as Points f, g, h

4. **Start from Step 2 onwards to adjust the other points.**
5. **When the adjustment is completed, press the ▼▲◀▶ buttons to align the cursor with the [EXIT] in the adjustment screen and then press the ENTER button.**
 - Switch to the [GEOMETRIC CORRECTION] menu screen.
6. **Press ◀ or ▶ button to move the cursor onto [OK] then press [ENTER].**
 - The adjusted values for [HORIZONTAL CORNER] or [VERTICAL CORNER] are stored and the screen display goes back to the [GEOMETRIC CORRECTION].

TIP:

- A commercially available USB mouse is available to perform correction. (→ page 49)

WARP

Correct projected image distortion on a specific surface as a column or a sphere.

NOTE:

- When the maximum adjustment range is exceeded, distortion adjustment is disabled. Set up the projector at an optimal angle since the more the adjustment volume gets large, the more image quality gets deterioration.
- Please note that the image will go out of focus due to the difference in the distance between peripheries and the center of the screen for projections cutting across corners as on a column or a sphere. Lenses with short focal points are also not recommended for projections cutting across corners as the image will go out of focus.

Adjustment method

1. **Align the cursor with the [WARP] of the [GEOMETRIC CORRECTION] menu and the press the ENTER.**
 - Adjustment screen will be displayed on.
2. **Press the ▼▲◀▶ buttons to align the cursor (blue box) with the target adjustment point and then press the ENTER.**
 - The cursor will change into an adjustment point (yellow in color).
3. **Press the ▼▲◀▶ buttons to adjust the corners or sides of the screen and then press the ENTER.**
 - The cursor will back to yellow box.

Explanation for correcting distortion

- Eight adjustment points can be moved independently.
- For left and right sides, use ◀/▶ buttons for adjusting the range of distortion, and ▼/▲ buttons for adjusting the distortion peak.
- For top and bottom sides, use ▼/▲ buttons for adjusting the range of distortion, and ◀/▶ buttons for adjusting the distortion peak.
- For corners, use ▼▲◀▶ buttons for moving positions.

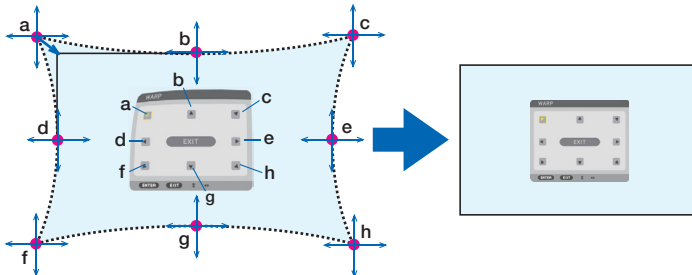

4. **For adjusting other points, repeat Step2 onwards.**
5. **When the adjustment is completed, move the cursor onto the [EXIT] on the adjustment screen and press the ENTER.**
 - The screen will be switched to the [GEOMETRIC CORRECTION] menu.
The adjustment completion screen will be displayed on.
6. **Press ◀ or ▶ button to move the cursor onto [OK] then press [ENTER].**
 - The adjusted values for [WARP] are stored and the screen display goes back to the [GEOMETRIC CORRECTION].

TIP:

- A commercially available USB mouse is available to perform correction. (→ page 49)

PC TOOL

Recall the geometric correction data that is registered in the projector beforehand.
Three types of correction data can be registered.

NOTE:

- As electrical correction is carried out in geometric correction, the brightness may be affected and the picture quality may be degraded.
-

RESET

Reset the adjustment value that has been set up as [MODE] in [GEOMETRIC CORRECTION] (return to the initial value).

- This is ineffective when [MODE] is set [OFF].
- Reset can be executed by pressing and holding the Geometric. button on the remote control for over 2 seconds.

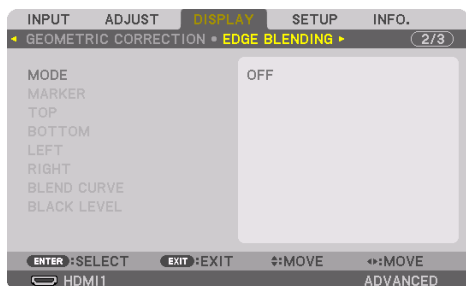
[EDGE BLENDING]

This adjusts the edges (boundaries) of the projection screen when projecting high resolution videos using a combination of several projectors in the up, down, left and right positions.

MODE

This enables or disables the [EDGE BLENDING] function.

When [MODE] is set to [ON], the [MARKER], [TOP], [BOTTOM], [LEFT], [RIGHT], [BLACK LEVEL], and [BLEND CURVE] settings can be adjusted.

NOTE:

- This can be set when [3D SETTINGS] → [FORMAT] is set to [OFF(2D)].

MARKER

Set whether to display marker or not when adjusting the range and display position. When turned on, magenta and red markers for adjusting the range adjustment and cyan and green markers for adjusting the display position will be displayed.

TOP/BOTTOM/LEFT/RIGHT

This selects the [EDGE BLENDING] locations on the left, right, top and bottom on the screen. The following settings can be adjusted when an item is selected. (→ page 75)

CONTROL	Enable [TOP], [BOTTOM], [LEFT], and [RIGHT] functions.
RANGE	Adjust the range (width) of the edge blending.
POSITION	Adjust the display position of the edge blending.

BLEND CURVE

Set brightness for the [EDGE BLENDING] sections. (→ page 78)

BLACK LEVEL

Adjust the black level of the [EDGE BLENDING] section. (→ page 79)

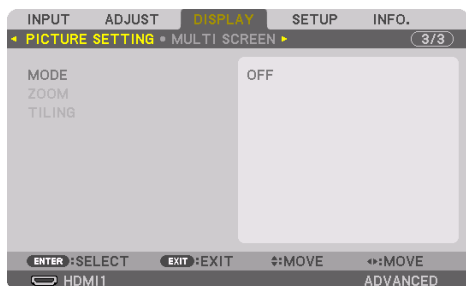
[PICTURE SETTING]

This sets the division conditions for reducing or enlarging the image area and displaying it in the desired position or for projecting using a combination of several projectors.

Please refer to “4. Multi-Screen Projection” (→ page 66) for details.

MODE	OFF	Use the projector in a standalone state.
	ZOOM	This adjusts the position and width of the video area that you wish to divide. The edge blending width will also be automatically set to that width.
	TILING	This assigns the divided screens to the projectors. The edge blending function will also be set automatically.
ZOOM	HORIZONTAL ZOOM	This enlarges the video area in the horizontal direction.
	VERTICAL ZOOM	This enlarges the video area in the vertical direction.
	HORIZONTAL POSITION	This shifts the video area in the horizontal direction.
	VERTICAL POSITION	This shifts the video area in the vertical direction.
TILING	WIDTH	This selects the number of projectors to be arranged horizontally.
	HEIGHT	This selects the number of projectors to be arranged vertically.
	HORIZONTAL POSITION	This selects the position of the projector starting from the left among those arranged horizontally.
	VERTICAL POSITION	This selects the position of the projector starting from the top among those arranged vertically.

Conditions for using tiling

- All the projectors need to fulfil the following conditions.
 - The panel size must be the same
 - The projection screen size must be the same
 - The left and right ends or top and bottom ends of the projection screen must be consistent.
 - The settings for the [LEFT] and [RIGHT] of the [EDGE BLENDING] are the same
 - The settings for the [TOP] and [BOTTOM] of the [EDGE BLENDING] are the same
- If the tiling conditions are satisfied, the video screen of the projector at each installation position will be automatically extracted and projected.
- If the tiling conditions are not satisfied, adjust the video screen of the projector at each installation position using the zoom function.
- Assign a unique control ID to each projector.
 - Set the "Color setting" and "DeepColor setting" on your Blu-ray player or computer to "Auto". Refer to the owner's manual accompanied with your Blu-ray player or computer for more information. Connect an HDMI output signal of your Blu-ray player or computer to the first projector and then connect to the HDBaseT OUT/Ethernet port on the first projector to the HDBaseT IN/Ethernet port on the second projector, same to the sequel projectors..

Tiling setting example) Number of horizontal units = 2, Number of vertical units = 2

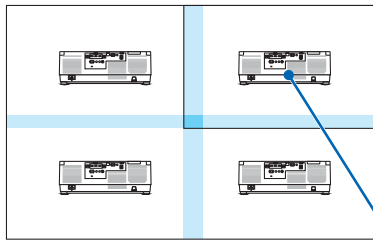

Horizontal order = Second unit
Vertical order = First unit

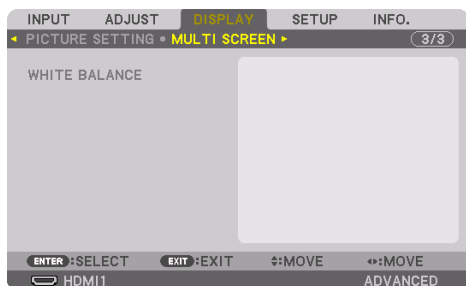
[MULTI SCREEN]**WHITE BALANCE**

This adjusts the white balance for each projector when projecting using a combination of several projectors.

This can be adjusted when [MODE] is set to [ON].

CONTRAST W, CONTRAST R, CONTRAST G, CONTRAST B	Adjusting the white color of the video.
BRIGHTNESS W, BRIGHTNESS R, BRIGHTNESS G, BRIGHTNESS B	Adjusting the black color of the video.

5-7. Menu Descriptions & Functions [SETUP]

[MENU(1)]



Selecting Menu Language [LANGUAGE]

You can choose one of 30 languages for on-screen instructions.

NOTE:

- Your setting will not be affected even when [RESET] is done from the menu.

Selecting Menu Color [COLOR SELECT]

You can choose between two options for menu color: [COLOR] and [MONOCHROME].

Selecting Menu Brightness [OSD BRIGHTNESS]

Select the brightness of the On-Screen display (menu, source display and messages) from 10 levels.

Turning On / Off Source Display [INPUT DISPLAY]

This option turns on or off input name display such as [HDMI1], [HDMI2], [DisplayPort], [COMPUTER], [HDBaseT] to be displayed on the top right of the screen.

Turning messages on and off [MESSAGE DISPLAY]

This option selects whether or not to display projector messages at the bottom of the projected image.

Even when [OFF] is selected, the security lock warning is displayed. The security lock warning turns off when the security lock is canceled.

Turning On / Off Control ID [ID DISPLAY]

This option turns on or off the ID number which is displayed when the ID SET button on the remote control is pressed. (→ page 139)

[3D CAUTION MESSAGE]

This selects whether to display a caution message or not when switching to a 3D video. The default condition when shipped from the factory is [ON].

OFF	The 3D caution message screen will not be displayed.
ON	The 3D caution message screen will be displayed when switching to a 3D video. Press the ENTER button to cancel the message. <ul style="list-style-type: none"> The message will disappear automatically after 60 seconds or when other buttons are pressed. If it disappears automatically, the 3D caution message will be displayed again when switching to a 3D video.

Selecting Menu Display Time [DISPLAY TIME]

This option allows you to select how long the projector waits after the last touch of a button to turn off the menu. The preset choices are [MANUAL], [AUTO 5 SEC], [AUTO 15 SEC], and [AUTO 45 SEC]. The [AUTO 45 SEC] is the factory preset.

[MENU(2)]**[MENU ANGLE]**

Select the direction for displaying the menu.

[MENU POSITION]

Shift the menu displaying position. You can choose from 9 locations.

TIP:

- The display position of the menu is saved even when the power supply of the projector is turned off.
- When you change the [MENU ANGLE], the display position of the menu returns to the original state when it was first shipped from the factory.
- Input terminal and message displaying position are not influenced by the [MENU POSITION].

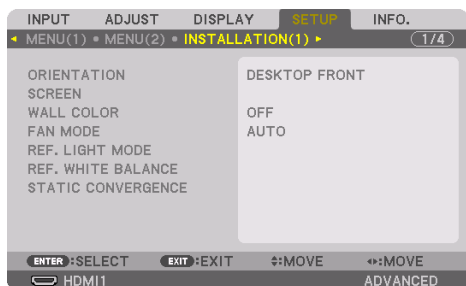
[INSTALLATION(1)]**Selecting Projector Orientation [ORIENTATION]**

This reorients your image for your type of projection. The options are: desktop front projection, ceiling rear projection, desktop rear projection, and ceiling front projection.

WARNING

- This projector is an RG3 product. The projector is for professional use and must be installed in location where safety is assured. For this reason, be sure to consult your dealer as installation and attachment/detachment of the lens unit must be performed by a professional service personnel. Never try to install the projector by yourself. This may result in visual impairment etc.

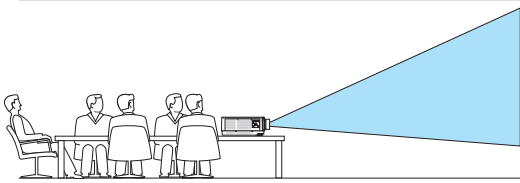
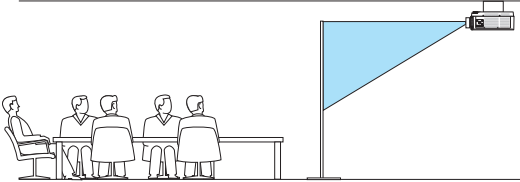
AUTO	<p>This automatically detects and projects the [DESKTOP FRONT] and [CEILING FRONT].</p> <p>NOTE:</p> <ul style="list-style-type: none"> • The [DESKTOP REAR] and [CEILING REAR] will not be detected. Please select manually.
DESKTOP FRONT	
CEILING REAR	

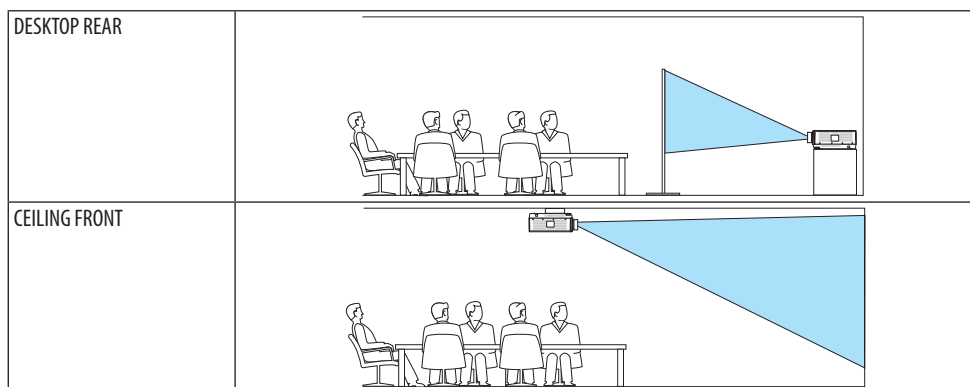

TIP:

- Check whether the automatic [DESKTOP FRONT] is installed within ± 10 degrees for floor installation and whether the [CEILING FRONT] is within ± 10 degrees for ceiling installation. Select manually when the projection screen is inverted.

Selecting Aspect Ratio and Position for Screen [SCREEN]

[SCREEN TYPE]

Sets the aspect ratio of the projection screen.

FREE	The ratio of the liquid crystal panel is selected. Select this when projecting multi-screen and 17:9 screen (2K).
4:3 SCREEN	For a screen with a 4:3 aspect ratio
16:9 SCREEN	For a screen with a 16:9 aspect ratio
16:10 SCREEN	For a screen with a 16:10 aspect ratio

NOTE:

- After changing the screen type, check the setting of [ASPECT RATIO] in the menu. (→ page 104)

[POSITION]

Adjust the screen position. Depending on the model you use and the screen type, the function may become ineffective and the adjustable range may vary.

Using the Wall Color Correction [WALL COLOR]

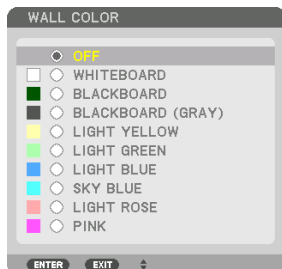

This function allows for quick adaptive color correction in applications where the screen material is not white.

NOTE:

- Selecting [WHITEBOARD] reduces light source brightness.

Selecting Fan Mode [FAN MODE]

Fan Mode is used to set the speed of the internal cooling fan.

MODE	Select one among four modes: [AUTO], [NORMAL], [HIGH], and [HIGH ALTITUDE].	
	AUTO	The built-in fans automatically run at variable speed according to the detected temperature and atmospheric pressure by the built-in sensor.
	NORMAL	The built-in fans run at the appropriate speed based on the detection by the built-in temperature sensor.
	HIGH	The built-in fans run at high speed
	HIGH ALTITUDE	The built-in fans run at high speed. Select this option when using the projector at altitudes approximately 5500 feet/1700 meters or higher.

NOTE:

- Make sure the speed is set to [HIGH] when you are using this device continuously for several days.
- Set [FAN MODE] to [AUTO] or [HIGH ALTITUDE] when using the projector at altitudes approximately 5500 feet/1700 meters or higher.
- Using the projector at altitudes approximately 5500 feet/1700 meters or higher without setting to [AUTO] or [HIGH ALTITUDE] can cause the projector to overheat and the protector could shut down. If this happens, wait a couple minutes and turn on the projector.
- Using the projector at altitudes less than approximately 5500 feet/1700 meters and setting to [HIGH ALTITUDE] can cause the projector to overcool, causing the image to flicker. Switch [FAN MODE] to [AUTO].
- Using the projector at altitudes approximately 5500 feet/1700 meters or higher can shorten the life of optical components such as the light source.
- Your setting will not be affected even when [RESET] is done from the menu.

TIP:

- When [HIGH ALTITUDE] is selected for [FAN MODE], a symbol icon  will be displayed at the bottom of the menu.

[REF. LIGHT MODE]

Set this when you want to change the brightness of the projector or when you want to use the projector in the energy-saving mode (→ page 41).

This can also be used to adjust the brightness between the different projectors when using a combination of multiple projectors.

REF. LIGHT MODE	BOOST	The picture becomes brighter than the [NORMAL] mode. However, the operating noise and power consumption will also increase due to control of the cooling fan according to the brightness. The life of the optical components may also be shortened depending on the operating environment.
	NORMAL	The light module luminance (brightness) will become 100% and the screen will turn bright.
	ECO1	By controlling the brightness and fan speed according to the selected setting, energy can be saved and motion noise and the power consumption can be lowered.
	ECO2	
REF. LIGHT ADJUST		Brightness can be adjusted in 1% increments from 50 to 100%.
CONSTANT BRIGHTNESS	OFF	[CONSTANT BRIGHTNESS] mode will be canceled.
	ON	Maintains the brightness that is in effect at the time [ON] is selected. Unless [OFF] is selected, the same settings will remain in effect even when the projector is turned off. <ul style="list-style-type: none"> To re-adjust the brightness, first turn this setting [OFF] before making further adjustments.

NOTE:

- When [WALL COLOR] is set to [WHITEBOARD], [REF. LIGHT MODE] cannot be selected.
- If [CONSTANT BRIGHTNESS] is set to [ON], then [REF. LIGHT MODE] and [REF. LIGHT ADJUST] cannot be selected.

TIP:

- Brightness normally decreases with use, but by selecting [CONSTANT BRIGHTNESS] mode, sensors inside the projector detect brightness and automatically adjust the output, thereby maintaining a constant brightness throughout the life of the light module. However, if output is already at its maximum, brightness will decrease with use. For this reason, when using multi-screen projection, it is recommended to adjust the brightness to a slightly lower level, then setting the [CONSTANT BRIGHTNESS] mode to [ON].

[REF. WHITE BALANCE]

This feature allows you to adjust the white balance for all signals.

The white and black levels of the signal are adjusted for optimum color reproduction.

Uniformity is also adjusted when the redness (R) and blueness (B) of the white color in the screen's horizontal (left/right) direction are uneven.

CONTRAST R, CONTRAST G, CONTRAST B	These adjust the picture's white color.
BRIGHTNESS R, BRIGHTNESS G, BRIGHTNESS B	These adjust the picture's black color.
UNIFORMITY R	The further this is set to the + side, the stronger the redness on the left side of the picture (increasing towards the left edge) and the weaker the redness on the right side of the picture (decreasing towards the right edge). This is reversed when set to the – side.
UNIFORMITY B	The further this is set to the + side, the stronger the blueness on the left side of the picture (increasing towards the left edge) and the weaker the blueness on the right side of the picture (decreasing towards the right edge). This is reversed when set to the – side.

[STATIC CONVERGENCE]

This features allows you to adjust for color deviation in the picture.

This can be adjusted in units of ± 1 pixel in the horizontal direction for [HORIZONTAL R], [HORIZONTAL G], and [HORIZONTAL B], in the vertical direction for [VERTICAL R], [VERTICAL G], and [VERTICAL B].

[INSTALLATION(2)]

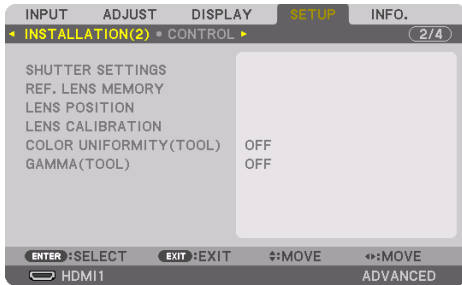

[SHUTTER SETTINGS]

Enabling and disabling the lens shutter function. You can also set how long the light will take to fade in and fade out when either the SHUTTER button on the remote control.

POWER ON SHUTTER	OPEN	When the power is turned on, the light source comes on and the picture is projected.
	CLOSE	The light source does not come on when the power is turned on. When the SHUTTER button is pressed, the shutter is released and the light source is turned on.
PICTURE MUTE SHUTTER	OPEN	The light source is still on when the picture is turned off for switching the input terminals.
	CLOSE	The light source turns off when the picture is turned off for switching the input terminals.
FADE IN TIME	(This function is not available.)	
FADE OUT TIME	Set how long the light will take to fade out after the SHUTTER button is pressed. The time can be set from 0 to 10 seconds in increments of 1 second.	

Using the Reference Lens Memory Function [REF. LENS MEMORY]

This function serves to store the adjusted values common to all input sources when using the [LENS SHIFT], motorized [ZOOM], and motorized [FOCUS] functions of the projector or the remote control. The adjusted values stored in memory can be used as a reference to the current.

PROFILE	Select a stored [PROFILE] number.
STORE	Stores the current adjusted values in memory as a reference.
MOVE	Applies the adjusted reference values stored in [STORE] to the current signal.
RESET	Reset selected [PROFILE] number [REF. LENS MEMORY] to the factory default settings.
LOAD BY SIGNAL	When you switch signals the lens will shift to the lens shift, zoom, and focus values for the selected [PROFILE] number. If no adjusted values have been saved to [LENS MEMORY], the lens will apply [REF. LENS MEMORY] adjusted values. Alternatively, if no adjusted values have been saved to [REF. LENS MEMORY], the unit will return to factory default settings.
FORCED MUTE	To turn off the image during lens shift, select [YES].

- This function is not available for the lens unit NP44ML.

TIP:

- Adjusted values in [REF. LENS MEMORY] will not be returned to default when performing [CURRENT SIGNAL] or [ALL DATA] for [RESET] from the menu.
- To store adjusted values for each input source, use the Lens Memory function. (→ page 59, 108)

[LENS POSITION]

Set back the lens to the home position.

[LENS CALIBRATION]

The adjustment range of the zoom, focus, and shift of the mounted lens is calibrated.

Be sure to carry out [LENS CALIBRATION] after replacing the lens.

- This function is not available for the lens unit NP44ML.

[COLOR UNIFORMITY(TOOL)]

Retrieves the uniformity adjustment value registered in the projector after adjusting with the ProAssist software application.

[GAMMA(TOOL)]

Retrieves the Gamma Tone adjustment value registered in the projector after adjusting with the ProAssist software application.

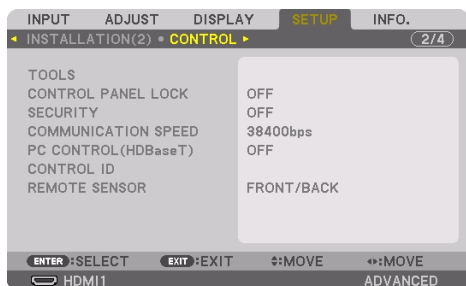
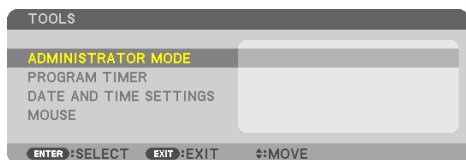
[CONTROL]**TOOLS****ADMINISTRATOR MODE**

This allows you to select [MENU MODE], save settings, and set a password for the administrator mode.

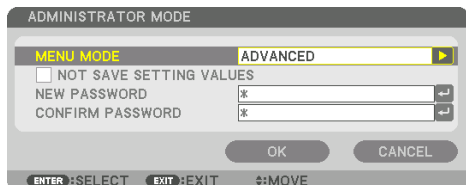

MENU MODE	Select either [BASIC] or [ADVANCED] menu. (→ page 83)	—
NOT SAVE SETTING VALUES	Placing a check mark will not save your projector settings. Clear this check box to save your projector settings.	—
NEW PASSWORD, CONFIRM PASSWORD	Assign a password for the administrator mode.	Up to 10 alphanumeric characters

PROGRAM TIMER

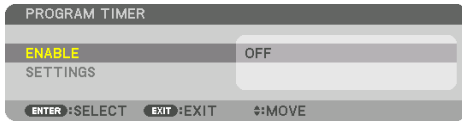

This option turns on/standby the projector and changes video signals, and selects [LIGHT MODE] automatically at a specified time.

Important:

- Before using [PROGRAM TIMER], make sure that the [DATE AND TIME SETTINGS] feature is set. (→ page 137)
Make sure that the projector is in the standby condition with the POWER cord connected.
The projector has a built-in clock. The clock will keep working for about a month after the main power is turned off. If the main power is not supplied to the projector for a month or more, it requires to set [DATE AND TIME SETTINGS] feature again.

Setting a new program timer

1. On the [PROGRAM TIMER] screen, use the ▲ or ▼ button to select [SETTINGS] and press the ENTER button.



The [PROGRAM LIST] screen will be displayed.

2. Select a blank program number and press the ENTER button.



The [ (EDIT)] screen will be displayed.

3. Make settings for each item as required.

EDIT
EVENT NO. 01

ACTIVE

DAY SUN

TIME 00:00

FUNCTION POWER

ADVANCED SETTINGS OFF

REPEAT

OK CANCEL

ENTER SELECT EXIT EXIT MOVE MOVE

ACTIVE	Place a check mark to enable the program.
DAY	Select days of the week for the program timer. To execute the program from Monday to Friday, select [MON-FRI]. To execute the program in everyday basis, select [EVERY DAY].
TIME	Set the time to execute the program. Enter time in 24-hour format.
FUNCTION	Select a function to be executed. Selecting [POWER] will allow you to turn on or off the projector by setting [ADVANCED SETTINGS]. Selecting [INPUT] will allow you to select an input terminal by setting [ADVANCED SETTINGS]. Selecting [LIGHT MODE] will allow you to select one option among [BOOST], [NORMAL], [ECO1], and [ECO2] for [LIGHT MODE] by setting [ADVANCED SETTINGS].
ADVANCED SETTINGS	Select one option for the selected item in [FUNCTION].
REPEAT	Place a check mark to repeat the program continuing basis. To use the program this week only, clear the check mark.

4. Select [OK] and press the ENTER button.

This will complete the settings.

You will be returned to the [PROGRAM LIST] screen.

5. Select [(BACK)] and press the ENTER button.

PROGRAM LIST

NO.	DAY	TIME	FUNCTION
01	SUN	00:00	POWER-OFF
02			
03			
04			
05			
06			
07			
08			
09			
10			
11			
12			
13			
14			
15			

ENTER SELECT EXIT EXIT MOVE MOVE EDIT

You will be returned to the [PROGRAM TIMER] screen.

6. Select [EXIT] and press the ENTER button.

You will be returned to the [TOOLS] screen.

NOTE:

- Up to 30 different timer settings can be programmed.
 - The Program Timer is executed on a set time basis, not in a program basis.
 - Once the program not marked with a check in [REPEAT] has been executed, the check mark in the [ACTIVE] check box will be cleared automatically and the program will be disabled.
 - When the on-time and the off-time set for the same time, the off-time setting will take preference.
 - When two different sources are set for the same time, the larger program number will take preference.
 - The on-time setting will not be executed while the cooling fans are running or an error is occurring.
 - If the off-time setting is expired under the condition in which the power off is not possible, the off-timer setting will not be executed until the power off becomes possible.
 - Programs not marked with a check mark in [ACTIVE] of the [EDIT] screen will not be executed even if the Program Timer is enabled.
 - When the projector is turned on by using the program timer and if you want to turn off the projector, set the off-time or do it manually so as not to leave the projector on for a long period of time.
-

Activating the program timer

- 1. Select [ENABLE] on the [PROGRAM TIMER] screen and press the ENTER button.**

The selection screen will be displayed.

- 2. Press the ▼ button to align the cursor with [ON] and then press the ENTER button.**

Return to the [PROGRAM TIMER] screen.

NOTE:

- When the effective settings of the [PROGRAM TIMER] have not been set to [ON], the program will not be executed even if the [ACTIVE] items in the [PROGRAM LIST] have been ticked.
 - Even when the effective settings of the [PROGRAM TIMER] are set to [ON], the [PROGRAM TIMER] will not work until the [PROGRAM TIMER] screen is closed.
-

Editing the programmed settings

- 1. On the [PROGRAM LIST] screen, select a program you want to edit and press the ENTER button.**

- 2. Change the settings on the [EDIT] screen.**

- 3. Select [OK] and press the ENTER button.**

The programmed settings will be changed.

You will be returned to the [PROGRAM LIST] screen.

Changing the order of programs

- 1. On the [PROGRAM LIST] screen, select a program whose order you want to change and press the ► button.**

- 2. Press the ▼ button to select ▲ or ▼.**

- 3. Press the ENTER button a few times to select a row to which you wish to move the program.**

The order of the programs will be changed.

Deleting the programs

1. On the [PROGRAM LIST] screen, select a program number you want to delete and press the ► button.
2. Press the ▼ button to select [ (DELETE)].
3. Press the ENTER button.
The confirmation screen will be displayed.
4. Select [YES] and press the ENTER button.
The program will be deleted.

This will complete deleting the program.

DATE AND TIME SETTINGS

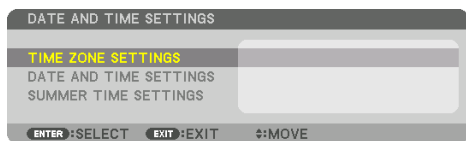

You can set the current time, month, date, and year.

NOTE:

- The projector has a built-in clock. The clock will keep working for about a month after the main power is turned off. If the main power is off for a month or more, the built-in clock will cease. If the built-in clock ceases, set the date and time again. The built-in clock will not cease while in the standby mode. In order to activate the built-in clock continuously even when the projector is not used, leave it in the standby state not plugging off the power cord.

TIME ZONE SETTINGS	Select your time zone.
DATE AND TIME SETTINGS	Set your current date (MM/DD/YYYY) and time (HH:MM). INTERNET TIME SERVER: If you place a check mark, the projector's built-in clock will be synchronized with an Internet time server in every 24 hours and at the time of projector's startup. UPDATE: Synchronizes the projector's built-in clock immediately. The [UPDATE] button is not available unless the [INTERNET TIME SERVER] check box is turned on.
SUMMER TIME SETTINGS	If you place a check mark, the clock for daylight saving will be enabled.

[MOUSE]

This function is for using a commercially available USB mouse via the USB-A port on this projector.

BUTTON	Select for using the mouse either by right or left hand.
SENSITIVITY	Select the sensitivity of mouse among [FAST], [MEDIUM] and [SLOW].

NOTE:

- This setting is not guaranteed motion of all commercially available USB mouses.

Disabling the Cabinet Buttons [CONTROL PANEL LOCK]

This option turns on or off the [CONTROL PANEL LOCK] function.

NOTE:

- How to cancel the [CONTROL PANEL LOCK]
When the [CONTROL PANEL LOCK] is set to [ON], press the EXIT button on the cabinet for 10 seconds or longer to cancel the [CONTROL PANEL LOCK] setting.

TIP:

- When the [CONTROL PANEL LOCK] is turned on, a key lock icon [] will be displayed at the bottom right of the menu.
- This [CONTROL PANEL LOCK] does not affect the remote control functions.

Enabling Security [SECURITY]

This feature turns on or off the [SECURITY] function.

Unless the correct keyword is entered, the projector cannot project an image. (→ page 50)

NOTE:

- Your setting will not be affected even when [RESET] is done from the menu.
-

Selecting Communication Speed [COMMUNICATION SPEED]

This feature sets the communication speed for the PC Control port (D-Sub 9P). Make sure to set the appropriate speed for the device to connect.

NOTE:

- Your selected communication speed will not be affected even when [RESET] is done from the menu.
-

[PC CONTROL(HDBaseT)]

Set this to [ON] when controlling the projector from a computer using RS-232C via an HDBaseT-compatible transmitter (sold separately).

Setting ID to the Projector [CONTROL ID]

You can operate multiple projectors separately and independently with the single remote control that has the [CONTROL ID] function. If you assign the same ID to all the projectors, you can conveniently operate all the projectors together using the single remote control. To do so, you have to assign an ID number to each projector.

CONTROL ID NUMBER	Select a number from 1 to 254 you wish to assign to your projector.
CONTROL ID	Select [OFF] to turn off the [CONTROL ID] setting and select [ON] to turn on the [CONTROL ID] setting.

NOTE:

- When [ON] is selected for [CONTROL ID], the projector cannot be operated by using the remote control that does not support the [CONTROL ID] function. (In this case the buttons on the projector cabinet can be used.)
 - Your setting will not be affected even when [RESET] is done from the menu.
 - Pressing and holding the ENTER button on the projector cabinet for 10 seconds will display the menu for canceling the Control ID.
-

Assigning or Changing the Control ID

1. Turn on the projector.
2. Press the ID SET button on the remote control.

The [CONTROL ID] screen will be displayed.



If the projector can be operated with the current remote control ID, the [ACTIVE] will be displayed. If the projector cannot be operated with the current remote control ID, the [INACTIVE] will be displayed. To operate the inactive projector, assign the control ID used for the projector by using the following procedure (Step 3).

3. Press one of numeric keypad buttons while pressing and holding the ID SET button on the remote control.

Example:

To assign "3", press the "3" button on the remote control.

No ID means that all the projectors can be operated together with a single remote control. To set "No ID" and cancel the control ID setting, enter "000" or press the number 0 while holding down the ID SET button.

TIP:

- The range of IDs is from 1 to 254.

4. Release the ID SET button.

The updated [CONTROL ID] screen will be displayed.

NOTE:

- The IDs can be cleared in a few days after the batteries are run down or removed.
- Accidentally pressing any one of the buttons of the remote control will clear currently specified ID with batteries removed.

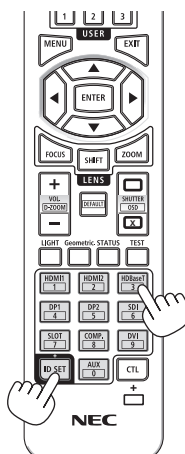
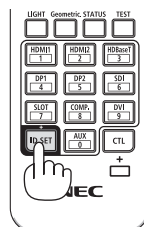

Turning On or Off Remote Sensor [REMOTE SENSOR]

This option determines which remote sensor on the projector is enabled in wireless mode. The options are: [FRONT/BACK], [FRONT], [BACK], and [HDBaseT].

NOTE:

- The remote control of the projector will not be able to receive signals if the power supply of the HDBaseT transmission device connected to the projector is switched on when this has been set to [HDBaseT].
-

TIP:

- If the remote control system does not function when direct sunlight or strong illumination strikes the remote control sensor of the projector, change to other option.
-

[NETWORK SETTINGS]

Configure the various settings when using the projector connected to a network.

Important:

- Consult with your network administrator about these settings.
- When using a wired LAN, connect the Ethernet cable (LAN cable) to the LAN port on the projector. (→ page 168)
- Please use a shielded twisted pair (STP) cable of Category 5e or higher for the LAN cable (sold commercially).
- The default [WIRED LAN] setting of this projector is set to [DISABLE] when it is shipped from the factory. To connect to a network, change the [WIRED LAN] profile setting from [DISABLE] to [PROFILE 1] or [PROFILE 2] to enable the wired LAN.

TIP:

- The network settings you make will not be affected even when [RESET] is done from the menu.

Hints on How to Set Up LAN Connection**To set up the projector for a LAN connection:**

Select [WIRED LAN] → [PROFILES] → [PROFILE 1] or [PROFILE 2].

Two settings can be set for wired LAN.

Next turn on or off for [DHCP], [IP ADDRESS], [SUBNET MASK], and [GATEWAY] and select [OK] and press the ENTER button. (→ page 143)

To recall LAN settings stored in the profile number:

Select [PROFILE 1] or [PROFILE 2] for wired LAN, and then select [OK] and press the ENTER button. (→ page 143)

To connect a DHCP server:

Turn on [DHCP] for wired LAN. Select [ON] and press the ENTER button. To specify IP address without using the DHCP server, turn off [DHCP]. (→ page 143)

To receive error messages via e-mail:

Select [ALERT MAIL], and set [SENDER'S ADDRESS], [SMTP SERVER NAME], and [RECIPIENT'S ADDRESS]. Last, select [OK] and press the ENTER button. (→ page 145)

NETWORK PASSWORD

CHANGE PASSWORD

NEW PASSWORD

CONFIRM PASSWORD

IF YOU DO NOT SET PASSWORD,
LEAVE THE FIELD BLANK AND SELECT OK.

OK CANCEL

ENTER :SELECT EXIT :EXIT ←:MOVE

Setting a password when using a wired LAN. Alternatively, changing the set password.

Set the password using a maximum of up to 10 alphanumeric characters.

If a password is set, you need to enter the password in the following cases.

- When opening the [NETWORK PASSWORD] screen and [WIRED LAN] screen of the on-screen menu
- When updating the network settings on the [SETTINGS] screen of the HTTP server

To delete the set password, leave the password entry field blank when registering.

TIP:

- However, if you forget your password, consult with your dealer.

WIRED LAN

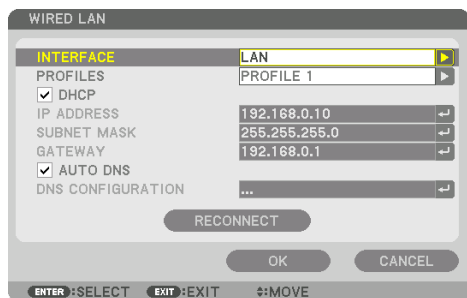

When you select [WIRED LAN] in the on-screen menu for the first time after purchasing the projector, the [NETWORK PASSWORD] setting screen will appear. Carry out the following Step (1) or Step (2).

(1) When setting the network password (recommended)

Refer to [NETWORK PASSWORD] (→ page 142).

(2) When no network password is set

Leave the 2 input fields in the [NETWORK PASSWORD] setting screen blank, then select [OK] and press the ENTER button.

If [NETWORK PASSWORD] has been set, you cannot display the [WIRED LAN] screen without entering password.

INTERFACE	Select [LAN] for using the LAN port for connecting to the wired LAN. Select [HDBaseT] for using the HDBaseT IN/Ethernet port for connecting to the wired LAN.	—
PROFILES	<ul style="list-style-type: none"> The settings for the wired LAN can be recorded in the projector memory in two ways. Select [PROFILE 1] or [PROFILE 2] and then do settings for [DHCP] and the other options. After doing this, select [OK] and press the ENTER button. This will store your settings in memory. To recall the settings from memory: After selecting [PROFILE 1] or [PROFILE 2] from the [PROFILES] list. Select [OK] and press the ENTER button. Select [DISABLE] when not connecting to a wired LAN 	—
DHCP	Place a check mark to automatically assign an IP address to the projector from your DHCP server. Clear this check box to register the IP address or subnet mask number obtained from your network administrator.	—
IP ADDRESS	Set your IP address of the network connected to the projector when [DHCP] is turned off.	Up to 12 numeric characters
SUBNET MASK	Set your subnet mask number of the network connected to the projector when [DHCP] is turned off.	Up to 12 numeric characters
GATEWAY	Set the default gateway of the network connected to the projector when [DHCP] is turned off.	Up to 12 numeric characters

AUTO DNS	Place a check mark to automatically assign the IP address of your DNS server connected to the projector from your DHCP server. Clear this check box to set the IP address of your DNS server connected to the projector.	Up to 12 numeric characters
DNS CONFIGURATION	Set the IP address of your DNS server on the network connected to the projector when [AUTO DNS] is cleared.	Up to 12 numeric characters
RECONNECT	Retry to connect the projector to a network. Try this if you have changed [PROFILES].	—

PROJECTOR NAME

PROJECTOR NAME	Set a unique projector name.	Up to 16 alphanumeric characters and symbols
----------------	------------------------------	--

DOMAIN

Set a host name and domain name of the projector.

HOST NAME	Set a host name of the projector.	Up to 16 alphanumeric characters
DOMAIN NAME	Set a domain name of the projector.	Up to 60 alphanumeric characters

ALERT MAIL

ALERT MAIL	<p>This option will notify your computer of error messages via e-mail when using wireless or wired LAN.</p> <p>Placing a checkmark will turn on the Alert Mail feature. Clearing a checkmark will turn off the Alert Mail feature.</p> <p>Sample of a message to be sent from the projector:</p> <div style="border: 1px solid black; padding: 5px;"> <p>Subject: [Projector] Projector Information THE COOLING FAN HAS STOPPED. [INFORMATION] PROJECTOR NAME: xxxxx LIGHT HOURS USED: xxxxx[H]</p> </div>	—
HOST NAME	Type in a host name.	Up to 16 alphanumeric characters
DOMAIN NAME	Type in a domain name of the network connected to the projector.	Up to 60 alphanumeric characters
SENDER'S ADDRESS	Specify the sender's address.	Up to 60 alphanumeric characters and symbols
SMTP SERVER NAME	Type in the SMTP server name to be connected to the projector.	Up to 60 alphanumeric characters
RECIPIENT'S ADDRESS 1, RECIPIENT'S ADDRESS 2, RECIPIENT'S ADDRESS 3	Type in your recipient's address.	Up to 60 alphanumeric characters and symbols
TEST MAIL	<p>Send a test mail to check if your settings are correct.</p> <p>NOTE:</p> <ul style="list-style-type: none"> If you entered an incorrect address in a test, you may not receive an Alert mail. Should this happen, check if the Recipient's Address is correctly set. Unless any one of the [SENDER'S ADDRESS], [SMTP SERVER'S NAME] or [RECIPIENT'S ADDRESS 1-3] is selected, [TEST MAIL] is not available. Be sure to highlight [OK] and press the ENTER button before executing [TEST MAIL]. 	—

[NETWORK SERVICE]

If [PASSCODE] has been set, you cannot display the [NETWORK SERVICE] screen without entering PASSCODE.

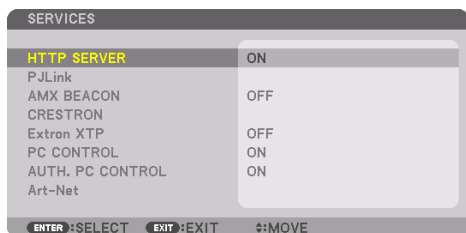
[SERVICES]

HTTP SERVER	Configure the settings for connecting to the HTTP server.		—
	ON	Connect directly to the HTTP server without displaying the login screen.	
	OFF	It is not possible to connect to the HTTP server.	
	AUTH.	Display the login screen when connecting to the HTTP server.	
Enter the USER NAME and PASSWORD that have been set at [ACCOUNT].			

PJLink	<p>Configure the settings for using PJLink.</p> <table border="1" data-bbox="269 185 852 419"> <tr> <td data-bbox="269 185 381 300">NEW PASSWORD, CONFIRM PASSWORD</td> <td data-bbox="385 185 852 300">Set the password.</td> </tr> <tr> <td data-bbox="269 304 381 357">CLASS</td> <td data-bbox="385 304 852 357">To use functions with PJLink Class 2 specifications, set [CLASS2].</td> </tr> <tr> <td data-bbox="269 362 381 419">DESTINATION</td> <td data-bbox="385 362 852 419">When the [CLASS] is set to [CLASS2], input the IP address of the destination.</td> </tr> </table> <p>NOTE:</p> <ul style="list-style-type: none"> • Do not forget your password. However, if you forget your password, consult with your dealer. • What is PJLink? PJLink is a standardization of protocol used for controlling projectors of different manufacturers. This standard protocol is established by Japan Business Machine and Information System Industries Association (JBMA) in 2005. The projector supports all the commands of PJLink Class 1. • Setting of PJLink will not be affected even when [RESET] is done from the menu. 	NEW PASSWORD, CONFIRM PASSWORD	Set the password.	CLASS	To use functions with PJLink Class 2 specifications, set [CLASS2].	DESTINATION	When the [CLASS] is set to [CLASS2], input the IP address of the destination.	Up to 32 alphanumeric characters
NEW PASSWORD, CONFIRM PASSWORD	Set the password.							
CLASS	To use functions with PJLink Class 2 specifications, set [CLASS2].							
DESTINATION	When the [CLASS] is set to [CLASS2], input the IP address of the destination.							
AMX BEACON	<p>Turn on or off for detection from AMX Device Discovery when connecting to the network supported by AMX's NetLinX control system.</p> <p>TIP:</p> <ul style="list-style-type: none"> • When using a device that supports AMX Device Discovery, all AMX NetLinX control system will recognize the device and download the appropriate Device Discovery Module from an AMX server. <p>[ON] will enable detecting the projector from AMX Device Discovery.. [OFF] will disable detecting the projector from AMX Device Discovery.</p>	—						
CRESTRON	<p>ROOMVIEW: Turn on or off when controlling the projector from your PC. CRESTRON CONTROL: Turn on or off when controlling the projector from your controller.</p> <ul style="list-style-type: none"> • CONTROLLER IP ADDRESS: Enter your IP address of CRESTRON SERVER. • IP ID: Enter your IP ID of CRESTRON SERVER. <p>TIP:</p> <ul style="list-style-type: none"> • The CRESTRON settings are required only for use with CRESTRON ROOMVIEW. For more information, visit http://www.crestron.com 	Up to 12 numeric characters						
Extron XTP	<p>Set for connecting this projector to the Extron XTP transmitter.</p> <p>[ON] will enable to connect with the XTP transmitter. [OFF] will disable to connect with the XTP transmitter.</p>	—						
PC CONTROL	<p>Set the PC control function to on or off.</p> <p>[ON] will enable the PC control function. [OFF] will disable the PC control function.</p>	—						

AUTH. PC CONTROL	<p>Set PC control function using authentication to on or off. [ON] will enable the PC control function with authentication using the user name and password registered at [ACCOUNT]. [OFF] will disable the PC control function with authentication.</p> <hr/> <p>NOTE:</p> <ul style="list-style-type: none"> This function is for future expansion. Security can be improved by using together with an application compatible with the authentication function. For specifications related to the authentication procedure required by the application software, please visit our web site. https://www.sharp-nec-displays.com/dl/en/pj_manual/lineup.html 	—								
Art-Net	<p>Art-Net is a communication protocol for transmitting and receiving DMX512 over an Ethernet network. Configure the settings for controlling the projector using the Art-Net controller.</p> <table border="1" data-bbox="269 560 852 852"> <tr> <td data-bbox="269 560 421 592">Art-Net</td> <td data-bbox="424 560 852 592">Turns on or off Art-Net.</td> </tr> <tr> <td data-bbox="269 596 421 676">[2.X.X.X], [10.X.X.X]</td> <td data-bbox="424 596 852 676">Automatically calculates the IP address according to the Art-Net specifications and overwrites it to the current wired LAN settings (IP address, subnet mask).</td> </tr> <tr> <td data-bbox="269 681 421 735">SETTINGS</td> <td data-bbox="424 681 852 735">Sets DMX Universe and start channel used by the projector.</td> </tr> <tr> <td data-bbox="269 740 421 852">CHANNEL</td> <td data-bbox="424 740 852 852">Selects projector functions to be assigned to channels 1 thru 12. To temporarily disable the assigned function, select [LOCK] to set the parameter to a non-operable value.</td> </tr> </table> <ul style="list-style-type: none"> The function and DMX value set for each channel can be checked in [INFO]. See “Art-Net DMX Parameter List” (→ page 201) for the DMX parameters. 	Art-Net	Turns on or off Art-Net.	[2.X.X.X], [10.X.X.X]	Automatically calculates the IP address according to the Art-Net specifications and overwrites it to the current wired LAN settings (IP address, subnet mask).	SETTINGS	Sets DMX Universe and start channel used by the projector.	CHANNEL	Selects projector functions to be assigned to channels 1 thru 12. To temporarily disable the assigned function, select [LOCK] to set the parameter to a non-operable value.	—
Art-Net	Turns on or off Art-Net.									
[2.X.X.X], [10.X.X.X]	Automatically calculates the IP address according to the Art-Net specifications and overwrites it to the current wired LAN settings (IP address, subnet mask).									
SETTINGS	Sets DMX Universe and start channel used by the projector.									
CHANNEL	Selects projector functions to be assigned to channels 1 thru 12. To temporarily disable the assigned function, select [LOCK] to set the parameter to a non-operable value.									

[ACCOUNT]

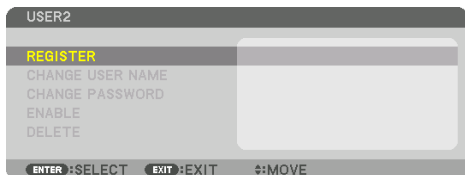
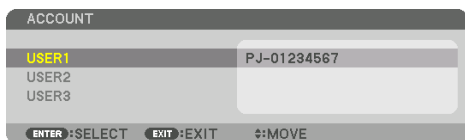

You can register three types of accounts: [USER1], [USER2], and [USER3].
 When [PASSCODE] is set, [REGISTER] is enabled for each user.
 [CHANGE USER NAME], [CHANGE PASSWORD], [ENABLE], and [DELETE] can be selected once the account has been registered at [REGISTER].

REGISTER	Set the user name and password of the account for use with [HTTP SERVER] authentication and [AUTH. PC CONTROL].	Up to 16 alphanumeric characters
CHANGE USER NAME	Change the user name registered at [ACCOUNT].	Up to 16 alphanumeric characters
CHANGE PASSWORD	Change the password registered at [ACCOUNT].	Up to 16 alphanumeric characters
ENABLE	Choose whether to enable or disable the account. [ON] will enable the account. [OFF] will disable the account. With this account, you cannot connect to an HTTP server that requires authentication or operate the projector using the [AUTH. PC CONTROL] function.	—
DELETE	Delete the USER NAME and PASSWORD that have been set at [ACCOUNT]. NOTE: • If the [USER1], [USER2], and [USER3] accounts have all been deleted, you cannot connect to the HTTP server that requires authentication or operate the projector using the [AUTH. PC CONTROL] function.	—

[PASSCODE]

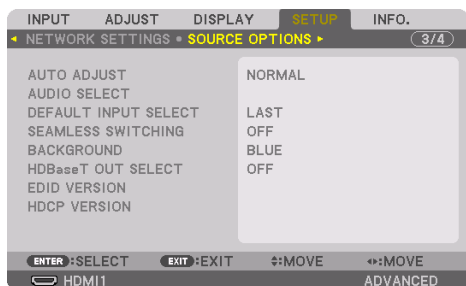

<p>Set the passcode for the network administrator.</p> <p>When the passcode is set, a confirmation screen is displayed when opening the [NETWORK SERVICE] screen of the on-screen menu and the [SERVICES] tab of the HTTP server, and the passcode must be input.</p> <p>Set the passcode using a combination of the ▼▲◀▶ buttons on the main unit or the remote control.</p> <p>To delete the passcode, register with the [PASSCODE] entry field blank.</p> <hr/> <p>NOTE:</p> <ul style="list-style-type: none"> • Make a note of your passcode and store it in a safe place. • If you forget your passcode, contact your distributor. 	Up to 10 alphanumeric characters
--	----------------------------------

[SOURCE OPTIONS]**Setting Auto Adjust [AUTO ADJUST]**

This feature sets the Auto Adjust mode so that the computer signal can be automatically or manually adjusted for noise and stability. You can automatically make adjustment in two ways: [NORMAL] and [FINE].

OFF	The computer signal will not be automatically adjusted. You can manually optimize the computer signal.
NORMAL	Default setting. The computer signal will be automatically adjusted. Normally select this option.
FINE	Select this option if fine adjustment is needed. It takes more time to switch to the source than when [NORMAL] is selected.

TIP:

- The default setting when shipped from the factory is [NORMAL].

[AUDIO SELECT]

This selects the audio input of the HDMI 1 IN terminal, HDMI 2 IN terminal, DisplayPort IN terminal and HDBaseT IN/Ethernet port.

Selecting Default Source [DEFAULT INPUT SELECT]

You can set the projector to default to any one of its inputs each time the projector is turned on.

LAST	Sets the projector to default to the previous or last active input each time the projector is turned on.
AUTO	Searches for an active source in order of HDMI1 → HDMI2 → DisplayPort → COMPUTER → HDBaseT and displays the first found source.
HDMI1	Displays the digital source from the HDMI 1 IN connector every time the projector is turned on.
HDMI2	Displays the digital source from the HDMI 2 IN connector every time the projector is turned on.
DisplayPort	Displays the digital source from the DisplayPort every time the projector is turned on.
COMPUTER	Displays the computer signal from the COMPUTER IN connector every time the projector is turned on.
HDBaseT	Project the HDBaseT signal.

[SEAMLESS SWITCHING]

When the input connector is switched, the image displayed before switching is held to switch to the new image without a break due to absence of a signal.

Selecting a Color or Logo for Background [BACKGROUND]

Use this feature to display a blue/black screen or logo when no signal is available. The default background is [BLUE].

NOTE:

- Even when the background logo is selected, if two pictures are displayed in [PIP/PICTURE BY PICTURE] mode, the blue background is displayed without the logo when there is no signal.

[HDBaseT OUT SELECT]

Select signal to output from the HDBaseT OUT/Ethernet port on the projector.

OFF	No signal is output.
AUTO	Output the input signal. When two images are projected simultaneously (PIP/PICTURE BY PICTURE), the image for the main screen is output.
HDMI1	Output the input signal thru the HDMI 1 IN terminal.
HDMI2	Output the input signal thru the HDMI 2 IN terminal.
DisplayPort	Output the input signal thru the DisplayPort IN terminal.
HDBaseT	Output the input signal thru the HDBaseT IN/Ethernet port.

NOTE:

- Signal thru the COMPUTER IN terminal can not be output. In the state [PIP] or [PICTURE BY PICTURE] has been set and [AUTO] has been set for this function, moreover, the input terminal for the main screen is the COMPUTER and the input terminal for the sub screen is one among the HDMI 1 IN, HDMI 2 IN, DisplayPort IN terminals, or HDBaseT IN/Ethernet port, the signal from the sub screen will be output.
- If the set input terminals for main and sub screen for [PIP] and [PICTURE BY PICTURE] are differed from the selected input terminals, any image will be output.
- 4K60p and 4K50p signals can not be output.

[EDID VERSION]

Switch the EDID version for the HDMI 1 IN and HDMI 2 IN terminals.

MODE1	Supports general signal
MODE2	Supports 4K signal Select this mode for displaying 4K image using the device supporting 4K

NOTE:

- If image and sound can not be output in [MODE2], switch to [MODE1].

[HDCP VERSION]

Switch the HDCP version for the HDMI 1 IN, HDMI 2 IN and HDBaseT IN/Ethernet terminals.

HDCP 2.2	Automatically switch the mode HDCP 2.2 and HDCP 1.4
HDCP 1.4	Forcedly perform transmission with HDCP 1.4

NOTE:

- If image and sound can not be output from the monitor connected with the HDBaseT OUT/Ethernet port, switch the HDCP version to HDCP 1.4.
-

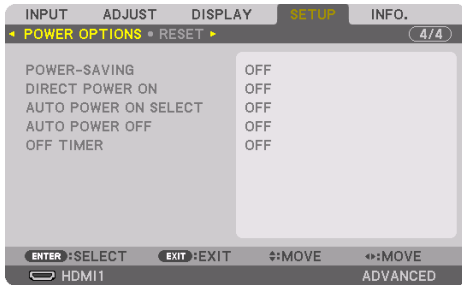
[POWER OPTIONS]**[POWER-SAVING]**

Select the standby mode:

ON	This setting is to keep the standby power consumption to the minimum necessary. The standby state changes automatically depending on the projector settings and the state and duration of connected devices (→ page 191). The consumption power also changes according to the standby state.
OFF	This is a setting with no functional restrictions during standby. To maintain the sleep state, the power consumption is higher than when this mode is set to [ON].

TIP:

- Even if [POWER-SAVING] is set to [ON], the projector goes to sleep in the following cases.
 - [PC CONTROL(HDBaseT)] is set to [ON]
 - [REMOTE SENSOR] is set to [HDBaseT]
 - [HDBaseT OUT SELECT] is set to other than [OFF]
 - When [AUTO POWER ON SELECT] is set to something other than [OFF] and a signal is being input to the HDMI1, HDMI2, DisplayPort or COMPUTER terminal
 - [WIRED LAN] → [INTERFACE] is set to [HDBaseT]
 - [Extron XTP] is set to [ON]
 - While the lens is moving
 - When a temperature error or other error has occurred
- The [POWER-SAVING] setting is not changed by [RESET].
- [POWER-SAVING] ON/OFF does not affect the carbon meter's calculation of the amount of CO₂ emission reduction.

Enabling Direct Power On [DIRECT POWER ON]

Turns the projector on automatically when the power cord is inserted into an active power outlet. This eliminates the need to always use the POWER button on the remote control or projector cabinet.

 WARNING

- The projector produces intense light. When turning on the power, make sure no one within the projection range is looking at the lens.

Turning On the Projector by Detecting Input Signal [AUTO POWER ON SELECT]

Under the state of standby or sleep, the projector automatically detects and projects synchronizing signal input from the selected terminals among [COMPUTER], [HDMI1], [HDMI2], [DisplayPort], and [HDBaseT] by this function.

OFF	[AUTO POWER ON SELECT] function becomes inactive.
HDMI1, HDMI2, DisplayPort, COMPUTER, HDBaseT*	When the projector detects the computer signal input from the selected terminal, automatically it will be turned [ON] and will project the computer screen.

WARNING

- The projector produces intense light. When the power is turned on, make sure no one within the projection range is looking at the lens.

NOTE:

- If you want to activate this [AUTO POWER ON SELECT] function after powering OFF the projector, interrupt the signal from the input terminals or disconnect the computer cable from the projector and wait for more than 3 seconds (1 minute or longer if the input signal is HDBaseT) and then the input signal from the selected terminal. In addition, if signal from HDMI1, HDMI2, DisplayPort or HDBaseT is continuously input to the projector, the projector may be turned ON again automatically based on the setting of external devices even if the projector is turned OFF and in the condition of SLEEP mode.
- This function is not activated either by component signal input from the computer screen input terminal or computer signal as Sync on Green and Composite Sync.

Enabling Power Management [AUTO POWER OFF]

When this option is selected you can enable the projector to automatically turn off (at the selected time: 0:05, 0:10, 0:15, 0:20, 0:30, 1:00) if there is no signal received by any input or if no operation is performed.

Using Off Timer [OFF TIMER]

- 1. Select your desired time between 30 minutes and 16 hours: OFF, 0:30, 1:00, 2:00, 4:00, 8:00, 12:00, 16:00.**
- 2. Press the ENTER button on the remote control.**
- 3. The remaining time starts counting down and it is displayed at the bottom of the On-Screen Menu.**
- 4. The projector will turn off after the countdown is complete.**

NOTE:

- To cancel the preset time, set [OFF] for the preset time or turn off the power.
- When the remaining time reaches 3 minutes before the projector is turned off, the [THE PROJECTOR WILL TURN OFF WITHIN 3 MINUTES.] message will be displayed on the bottom of the screen.

Returning to Factory Default [RESET]

The [RESET] feature allows you to change adjustments and settings to the factory preset for a (all) source (s) except the following:

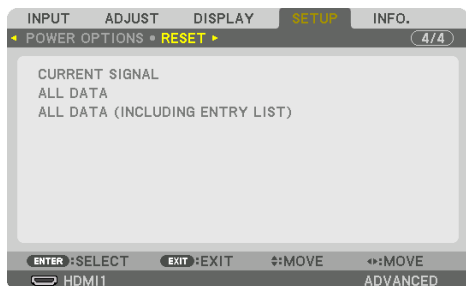

[CURRENT SIGNAL]

Resets the adjustments for the current signal to the factory preset levels.

The items that can be reset are: [PRESET], [CONTRAST], [BRIGHTNESS], [COLOR], [HUE], [SHARPNESS], [ASPECT RATIO], [HORIZONTAL], [VERTICAL], [CLOCK], [PHASE], and [OVERSCAN].

[ALL DATA]

Reset all the adjustments and settings for all the signals to the factory preset.

All items can be reset EXCEPT [ENTRY LIST], [GEOMETRIC CORRECTION], [EDGE BLENDING], [PICTURE SETTING], [MULTI SCREEN], [LANGUAGE], [SCREEN], [FAN MODE], [REF. WHITE BALANCE], [STATIC CONVERGENCE], [REF. LENS MEMORY], [COLOR UNIFORMITY(TOOL)], [GAMMA(TOOL)], [ADMINISTRATOR MODE], [DATE AND TIME SETTINGS], [CONTROL PANEL LOCK], [SECURITY], [COMMUNICATION SPEED], [PC CONTROL(HDBaseT)], [CONTROL ID], [NETWORK SETTINGS], [BACKGROUND], [EDID VERSION], [HDCP VERSION], [POWER-SAVING], [OFF TIMER], [LIGHT HOURS USED], and [TOTAL CARBON SAVINGS].

[ALL DATA (INCLUDING ENTRY LIST)]

Reset all the adjustments and settings for all the signals including the [ENTRY LIST] to the factory preset except [GEOMETRIC CORRECTION], [EDGE BLENDING], [PICTURE SETTING], [MULTI SCREEN], [LANGUAGE], [SCREEN], [FAN MODE], [REF. WHITE BALANCE], [STATIC CONVERGENCE], [REF. LENS MEMORY], [COLOR UNIFORMITY(TOOL)], [GAMMA(TOOL)], [ADMINISTRATOR MODE], [DATE AND TIME SETTINGS], [CONTROL PANEL LOCK], [SECURITY], [COMMUNICATION SPEED], [PC CONTROL(HDBaseT)], [CONTROL ID], [NETWORK SETTINGS], [BACKGROUND], [EDID VERSION], [HDCP VERSION], [POWER-SAVING], [OFF TIMER], [LIGHT HOURS USED], and [TOTAL CARBON SAVINGS]. Also deletes all the signals in the [ENTRY LIST] and returns to the factory preset.

NOTE:

- Locked signals in Entry List cannot be reset.
-

5-8. Menu Descriptions & Functions [INFO.]



[USAGE TIME]

LIGHT HOURS USED (H)	PROJECTOR HOURS USED (H)
TOTAL CARBON SAVINGS (kg-CO2)	

- The value of [LIGHT HOURS USED] reflects the temperature of the operating environment and the [LIGHT MODE] setting in the actual operating time.
- [PROJECTOR HOURS USED]
This displays the actual operating time of the projector.
- [TOTAL CARBON SAVINGS]
This displays the estimated carbon saving information in kg. The carbon footprint factor in the carbon saving calculation is based on the OECD (2008 Edition). (→ page 44)

[SOURCE(1)]

INPUT TERMINAL	RESOLUTION
HORIZONTAL FREQUENCY	VERTICAL FREQUENCY
SYNC TYPE	SYNC POLARITY
SCAN TYPE	SOURCE NAME
ENTRY NO.	

[SOURCE(2)]

SIGNAL TYPE	BIT DEPTH
VIDEO LEVEL	SAMPLING FREQUENCY
3D FORMAT	

[SOURCE(3)]

INPUT TERMINAL	RESOLUTION
HORIZONTAL FREQUENCY	VERTICAL FREQUENCY
SYNC TYPE	SYNC POLARITY
SCAN TYPE	SOURCE NAME
ENTRY NO.	

[SOURCE(4)]

SIGNAL TYPE	BIT DEPTH
VIDEO LEVEL	SAMPLING FREQUENCY
3D FORMAT	

[WIRED LAN]

IP ADDRESS	SUBNET MASK
GATEWAY	MAC ADDRESS
DNS	

[VERSION]

SOFTWARE	
----------	--

[OTHERS]

DATE TIME	PROJECTOR NAME
MODEL NO.	SERIAL NUMBER
LENS ID	

[CONDITIONS]

INTAKE TEMPERATURE	EXHAUST TEMPERATURE
ATMOSPHERIC PRESSURE	INSTALLATION POSITION
X-AXIS	Y-AXIS
Z-AXIS	OPTION COVER

About the [X-AXIS], [Y-AXIS], and [Z-AXIS] under [CONDITIONS]

* Arrow direction of the Z-AXIS in the figure represents the top of the projector.

X-AXIS:

Display the projector image at an angle of -100 – $+100$ degrees to the horizontal in the X-axis direction.

X-AXIS value of
the projector

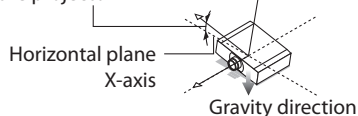
**Y-AXIS:**

Display the projector image at an angle of -100 – $+100$ degrees to the horizontal in the Y-axis direction.

Y-AXIS value of
the projector

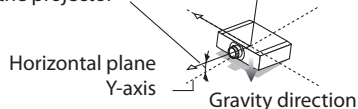

Z-AXIS:

Display the projector image at an angle of $-100 - +100$ degrees to the vertical in the Z-axis direction.

Z-AXIS value of the projector

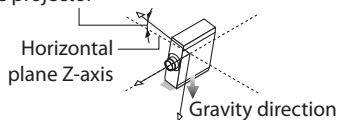

About [OPTION COVER]

This is used to check whether the option cover (separately sold) needs to be attached when the projector is installed at an angle.

- / -	Option cover is not required
A / -	Only option cover A needs to be attached
- / B	Only option cover B needs to be attached
A / B	Both of option covers A and B need to be attached

[HDBaseT]

SIGNAL QUALITY	OPERATION MODE
LINK STATUS	HDMI STATUS

[Art-Net(1)]

Ch1	Ch2	Ch3
Ch4	Ch5	Ch6
Ch7	Ch8	Ch9

[Art-Net(2)]

Ch10	Ch11	Ch12
------	------	------

6. Connecting to Other Equipment



CAUTION

- Be sure to turn off the projector before connecting the projector to an external device. In doing so, do not enter the hazard zone. If projected light enters your eyes, it may cause visual impairment.

NOTE:

- The connection cable is not enclosed with the projector. Please get ready a suitable cable for the connection. For HDMI, DisplayPort, LAN, RS-232C, and AUDIO, please use a shielded signal cable. For 15-pin mini D-Sub, please use a shielded signal cable with ferrite core. Use of other cables and adapters may cause interference with radio and television reception.
-

6-1. Connecting Your Computer

A computer cable, HDMI cable, or a DisplayPort cable can be used to connect to a computer.

Analog RGB signal connection

- Connect the computer cable to the monitor out terminal (mini D-sub 15 pin) on the computer and the computer video input terminal on the projector. Please use a computer cable attached with a ferrite core.

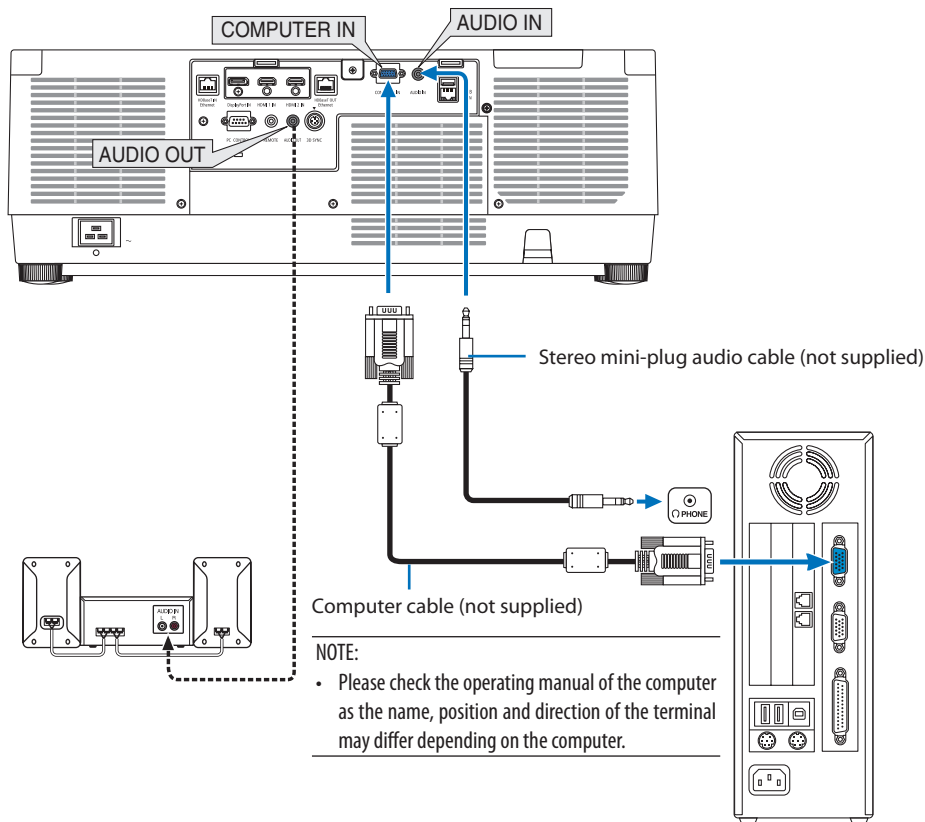

- Select the source name for its appropriate input connector after turning on the projector.



Input connector	INPUT button on the projector cabinet	Button on the remote control
COMPUTER IN	 COMPUTER	COMP.

Digital RGB signal connection

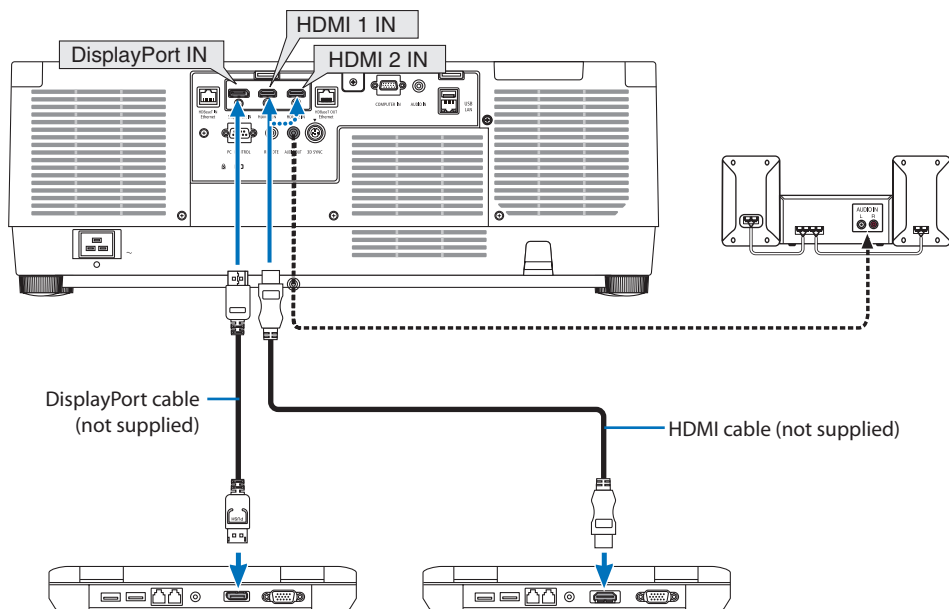
- Connect a commercially available HDMI cable between the computer's HDMI output connector and the projector's HDMI 1 IN or HDMI 2 IN connector.
- Connect a commercially available DisplayPort cable between the computer's DisplayPort output connector and the projector's DisplayPort input connector.



- Select the source name for its appropriate input connector after turning on the projector.

Input connector	INPUT button on the projector cabinet	Button on the remote control
HDMI 1 IN	 HDMI1	HDMI1
HDMI 2 IN	 HDMI2	HDMI2
DisplayPort IN	 DisplayPort	DP1

Cautions when connecting an HDMI cable

- Use a certified High Speed HDMI® Cable or High Speed HDMI® Cable with Ethernet.

Cautions when connecting a DisplayPort cable

- Use a certified DisplayPort cable.



- Depending on the computer, some time may be required until the image is displayed.
- Some DisplayPort cables (commercially available) have locks.
- To disconnect the cable, press the button on the top of the cable's connector, then pull the cable out.
- In case power supply from the DisplayPort IN terminal is required, please contact your dealer.
- When signals from a device that uses a signal converter adapter are connected to the DisplayPort input connector, the picture may not appear or may not be displayed normally.
- When the HDMI output of a computer is connected to the DisplayPort input connector, use a converter (commercially available).

Cautions when using a DVI signal

- When the computer has a DVI output connector, use a commercially available converter cable to connect the computer to the projector's HDMI 1 IN or HDMI 2 IN connector (only digital video signals can be input). Also, connect the computer's audio output to the projector's audio input connector. In this case, switch the HDMI1 or HDMI2 setting at on-screen menu's audio selection on the projector to [COMPUTER]. (→ page 150)

To connect the computer's DVI output connector to the projector's DisplayPort input connector, use a commercially available converter.

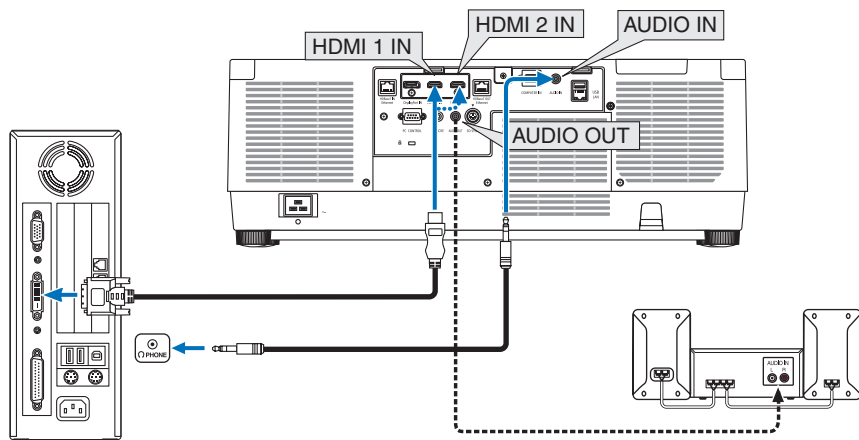

NOTE:

- Turn off the power of the computer and projector before connecting.
- When connecting the headphone terminal of the computer to the audio input terminal of the projector with an audio cable, set the computer volume to a low level before connecting. Then adjust the volume of the projector and the volume of the computer alternately to set the volume to a suitable level.
- If the computer has a mini-jack type audio output connector, we recommend connecting the audio cable to that connector.
- When a video deck is connected via a scan converter, etc., the display may not be correct during fast-forwarding and rewinding.
- Use a DVI-to-HDMI cable compliant with DDWG (Digital Display Working Group) DVI (Digital Visual Interface) revision 1.0 standard. The cable should be within 197"/5 m long.
- Turn off the projector and the PC before connecting the DVI-to-HDMI cable.
- To project a DVI digital signal: Connect the cables, turn the projector on, then select the HDMI input. Finally, turn on your PC. Failure to do so may not activate the digital output of the graphics card resulting in no picture being displayed. Should this happen, restart your PC.
- Some graphics cards have both analog RGB (15-pin D-Sub) and DVI (or DFP) outputs. Use of the 15-pin D-Sub connector may result in no picture being displayed from the digital output of the graphics card.
- Do not disconnect the DVI-to-HDMI cable while the projector is running. If the signal cable has been disconnected and then reconnected, an image may not be correctly displayed. Should this happen, restart your PC.
- The COMPUTER IN video input connectors support Windows Plug and Play.
- A Mac signal adapter (commercially available) may be required to connect a Mac computer. To connect a Mac computer equipped with a Mini DisplayPort to the projector, use a commercially available Mini DisplayPort → DisplayPort converter cable.

6-2. Connecting to a DVD player and other AV devices

Connecting Component Input

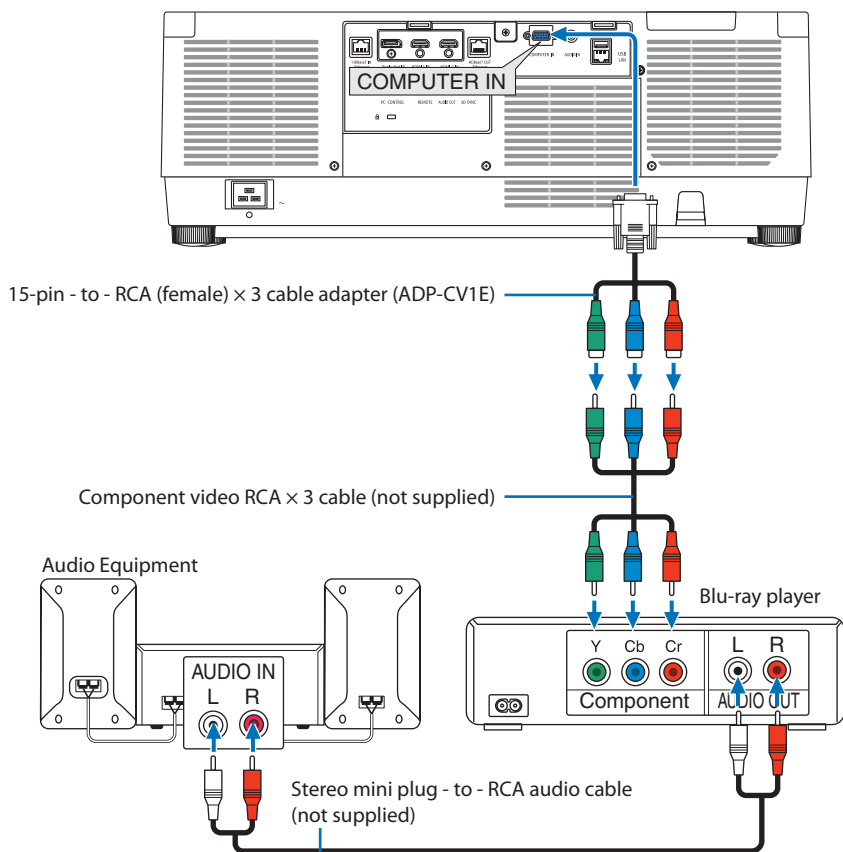

- Select the source name for its appropriate input connector after turning on the projector.

Input connector	INPUT button on the projector cabinet	Button on the remote control
COMPUTER IN	 COMPUTER	COMP.



TIP:

- When the signal format is set to [AUTO] (default factory setting when shipped), the computer signal and component signal are automatically distinguished and switched. If the signals cannot be distinguished, select the appropriate setting under [ADJUST] → [VIDEO] → [SIGNAL TYPE] in the on-screen menu of the projector.
- To connect to a video device with a D connector, use the sold separately D connector converter adapter (model ADP-DT1E).

Connecting HDMI Input

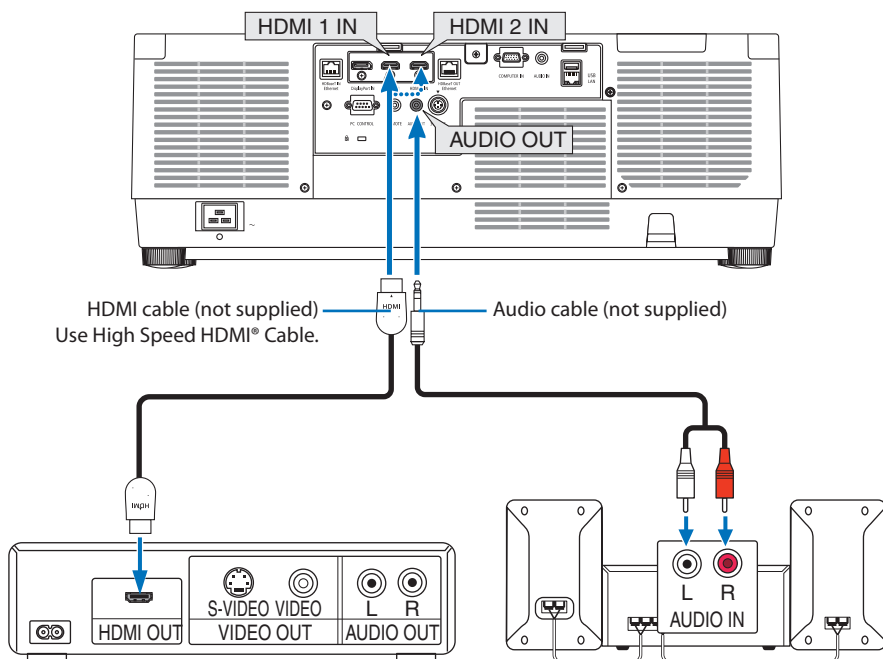
You can connect the HDMI output of your Blu-ray player, hard disk player, or notebook type PC to the HDMI 1 IN or HDMI 2 IN connector of your projector.



Input connector	INPUT button on the projector cabinet	Button on the remote control
HDMI 1 IN	 HDMI1	HDMI1
HDMI 2 IN	 HDMI2	HDMI2

TIP:

- For users of audio video equipment with an HDMI connector:
Select "Enhanced" rather than "Normal" if HDMI output is switchable between "Enhanced" and "Normal".
This will provide improved image contrast and more detailed dark areas.
For more information on settings, refer to the instruction manual of the audio video equipment to be connected.
- When connecting the HDMI 1 IN or HDMI 2 IN connector of the projector to the Blu-ray player, the projector's video level can be made settings in accordance with the Blu-ray player's video level. In the menu select [ADJUST] → [VIDEO] → [VIDEO LEVEL] and make necessary settings.
- If the HDMI 1 IN or HDMI 2 IN input's sound is not output, check if [HDMI1] and [HDMI2] are set [HDMI1] and [HDMI2] correctly in the on-screen menu [SETUP] → [SOURCE OPTIONS] → [AUDIO SELECT]. (→ page 150)

6-3. Connecting to a HDBaseT transmission device (sold commercially)

Use a LAN cable sold commercially to connect the HDBaseT IN/Ethernet port of the projector (RJ-45) to a HDBaseT transmission device sold commercially.

The HDBaseT IN/Ethernet port of the projector supports HDMI signals (HDCP) from transmission devices, control signals from external devices (serial, LAN) and remote control signals (IR commands).

- Refer to the owner's manual accompanied with your HDBaseT transmission for connecting with your external devices.

Connection example

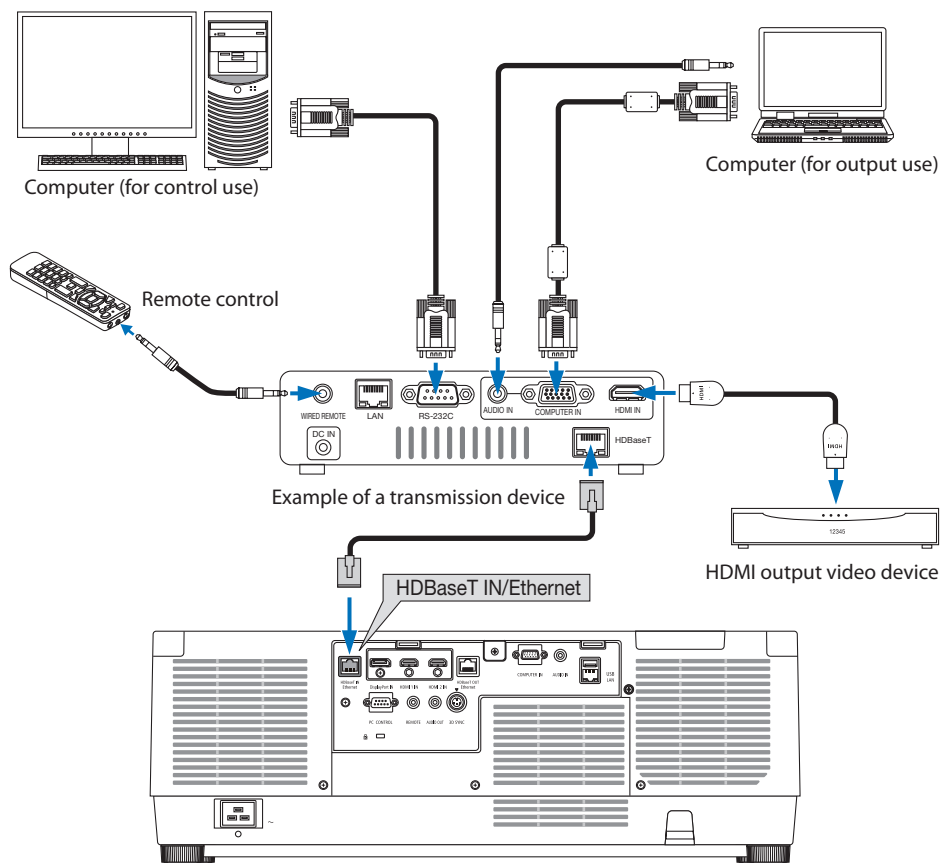

NOTE:

- Please use a shielded twisted pair (STP) cable of Category 5e or higher for the LAN cable (sold commercially).
- The maximum transmission distance over the LAN cable is 100 m.
- Please do not use other transmission equipment between the projector and transmission equipment. The picture quality may be degraded as a result.
- This projector is not guaranteed to work with all HDBaseT transmission devices sold commercially.

6-4. Connecting several projectors

It enables to project HDMI, DisplayPort, HDBaseT image on several projectors connecting the HDBaseT IN/Ethernet port and the HDBaseT OUT/Ethernet port by LAN cable. The projectors support same brightness can be connected up to four units.

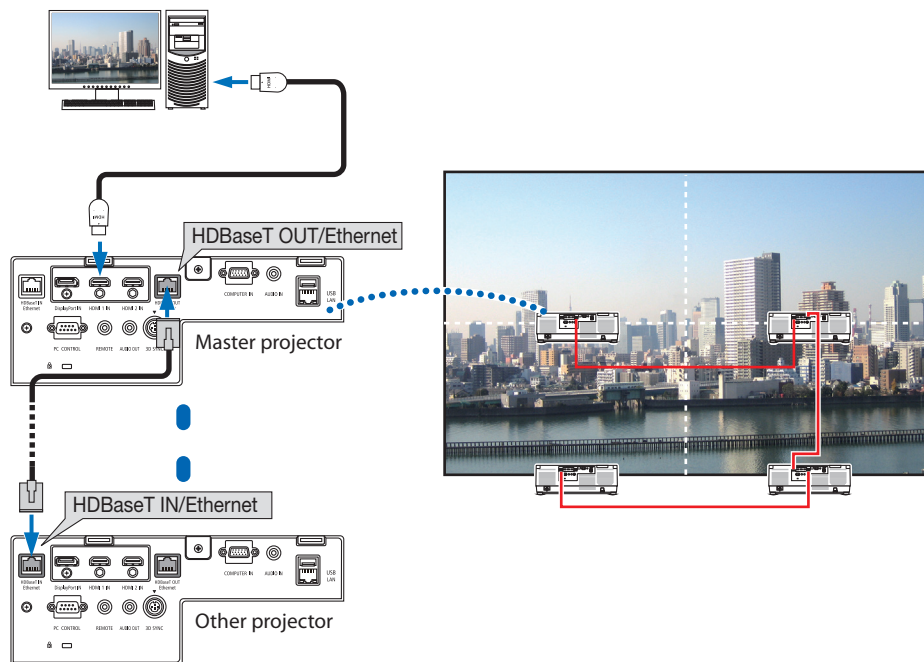

NOTE:

- When outputting HDMI signals, turn on the power of the video device on the output side and keep it connected before inputting video signals into this device. The HDBaseT OUT/Ethernet port of the projector is equipped with repeater function. When a device is connected to the HDBaseT OUT/Ethernet port, the resolution of the output signal is limited by the resolution supported by the connected device.
- The signal from the COMPUTER IN terminal is not output from the HDBaseT OUT/Ethernet port of this projector.
- Connecting and disconnecting an LAN cable or selecting another input source on the second and subsequent projectors will disable the HDBaseT repeater function.
- This projector is not guaranteed to work correctly in the connection with an other device as a monitor.

6-5. Connecting to a Wired LAN

The projector comes standard with a LAN port (RJ-45) which provides a LAN connection using a LAN cable.

To use a LAN connection, you are required to set the LAN on the projector menu. Select [SETUP] → [NETWORK SETTINGS] → [WIRED LAN]. (→ page 143).

Example of LAN connection

Example of wired LAN connection

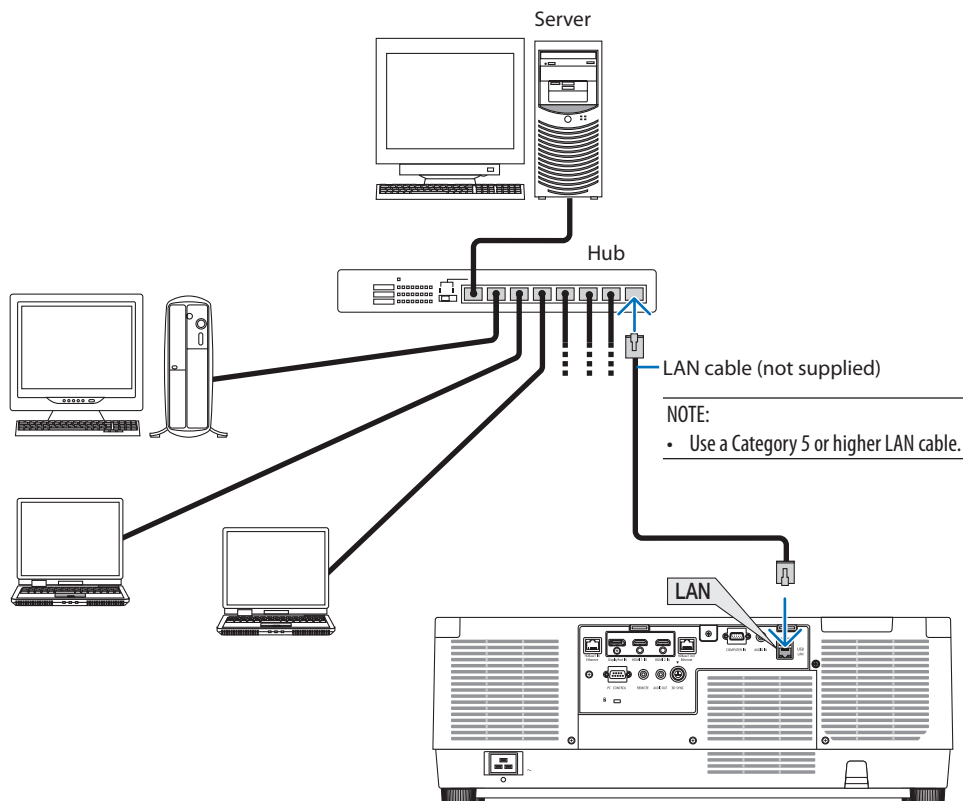

7. Maintenance

WARNING

- Turn off the projector, and unplug the projector before cleaning.
- Please do not use a spray containing flammable gas to remove dust attached to the lens and cabinet. Doing so may result in fires.

7-1. Cleaning the Lens

- Turn off the projector before cleaning.
- The projector has a plastic lens. Use a commercially available plastic lens cleaner.
- Do not scratch or mar the lens surface as a plastic lens is easily scratched.
- Never use alcohol or glass lens cleaner as doing so will cause damage to the plastic lens surface.

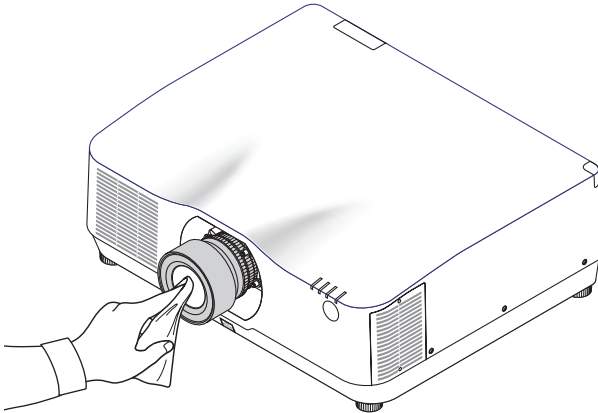

7-2. Cleaning the Cabinet

Turn off the projector, and unplug the projector before cleaning.

- Use a dry soft cloth to wipe dust off the cabinet.
If heavily soiled, use a mild detergent.
- Never use strong detergents or solvents such as alcohol or thinner.
- When cleaning the ventilation slits or the speaker using a vacuum cleaner, do not force the brush of the vacuum cleaner into the slits of the cabinet.

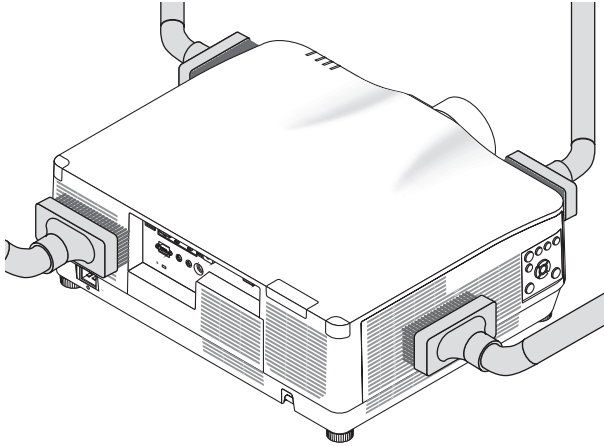

Vacuum the dust off the ventilation slits.

- Clogged ventilation slits may cause a rise in the internal temperature of the projector, resulting in malfunction.
- Do not scratch or hit the cabinet with your fingers or any hard objects
- Contact your dealer for cleaning the inside of the projector.

NOTE:

- Do not apply volatile agent such as insecticide on the cabinet, the lens, or the screen. Do not leave a rubber or vinyl product in prolonged contact with it. Otherwise the surface finish will be deteriorated or the coating may be stripped off.
-

8. Appendix

8-1. Throw distance and screen size

Three separate bayonet style lenses can be used on this projector. Refer to the information on this page and use a lens suited for the installation environment (screen size and throw distance). Request the dealer to attach or detach the lens unit.

Lens types and throw distance

NP11FL/NP12ZL/NP13ZL/NP14ZL/NP15ZL/NP40ZL/NP41ZL/NP43ZL

(Unit: inch)

Screen size (inches)	Lens model name							
	NP11FL	NP12ZL	NP13ZL	NP14ZL	NP15ZL	NP40ZL	NP41ZL	NP43ZL
30	—	28 – 37	36 – 74	—	—	—	—	—
40	26	38 – 50	48 – 99	—	—	—	—	—
50	33	48 – 64	61 – 124	—	—	33 – 46	54 – 127	129 – 254
60	40	59 – 77	74 – 149	146 – 236	231 – 354	40 – 56	66 – 153	154 – 303
80	53	79 – 103	99 – 200	196 – 317	310 – 475	53 – 75	88 – 204	204 – 403
100	67	99 – 129	124 – 250	246 – 397	389 – 596	67 – 94	110 – 256	254 – 503
120	81	119 – 155	149 – 300	296 – 477	469 – 716	81 – 113	133 – 307	303 – 602
150	101	149 – 194	187 – 376	372 – 598	588 – 897	101 – 142	166 – 384	378 – 752
200	—	199 – 259	250 – 502	497 – 799	786 – 1199	135 – 190	223 – 513	502 – 1001
240	—	239 – 312	301 – 602	598 – 959	945 – 1440	163 – 229	267 – 616	601 – 1201
300	—	300 – 390	377 – 754	748 – 1200	1183 – 1802	204 – 286	335 – 770	750 – 1500
400	—	400 – 521	503 – 1005	1000 – 1602	1580 – 2406	272 – 382	447 – 1028	999 – 1998
500	—	501 – 651	629 – 1257	1251 – 2004	1977 – 3009	340 – 478	559 – 1285	1247 – 2497

(Unit: m)

Screen size (inches)	Lens model name							
	NP11FL	NP12ZL	NP13ZL	NP14ZL	NP15ZL	NP40ZL	NP41ZL	NP43ZL
30	—	0.7 – 0.9	0.9 – 1.9	—	—	—	—	—
40	0.7	1.0 – 1.3	1.2 – 2.5	—	—	—	—	—
50	0.8	1.2 – 1.6	1.6 – 3.1	—	—	0.8 – 1.2	1.4 – 3.2	3.3 – 6.4
60	1.0	1.5 – 1.9	1.9 – 3.8	3.7 – 6.0	5.9 – 9.0	1.0 – 1.4	1.7 – 3.9	3.9 – 7.7
80	1.4	2.0 – 2.6	2.5 – 5.1	5.0 – 8.0	7.9 – 12.1	1.4 – 1.9	2.2 – 5.2	5.2 – 10.2
100	1.7	2.5 – 3.3	3.2 – 6.3	6.3 – 10.1	9.9 – 15.1	1.7 – 2.4	2.8 – 6.5	6.4 – 12.8
120	2.1	3.0 – 3.9	3.8 – 7.6	7.5 – 12.1	11.9 – 18.2	2.0 – 2.9	3.4 – 7.8	7.7 – 15.3
150	2.6	3.8 – 4.9	4.8 – 9.5	9.4 – 15.2	14.9 – 22.8	2.6 – 3.6	4.2 – 9.8	9.6 – 19.1
200	—	5.1 – 6.6	6.4 – 12.7	12.6 – 20.3	20.0 – 30.5	3.4 – 4.8	5.7 – 13.0	12.7 – 25.4
240	—	6.1 – 7.9	7.6 – 15.3	15.2 – 24.4	24.0 – 36.6	4.1 – 5.8	6.8 – 15.6	15.3 – 30.5
300	—	7.6 – 9.9	9.6 – 19.1	19.0 – 30.5	30.1 – 45.8	5.2 – 7.3	8.5 – 19.6	19.1 – 38.1
400	—	10.2 – 13.2	12.8 – 25.5	25.4 – 40.7	40.1 – 61.1	6.9 – 9.7	11.4 – 26.1	25.4 – 50.8
500	—	12.7 – 16.5	16.0 – 31.9	31.8 – 50.9	50.2 – 76.4	8.6 – 12.1	14.2 – 32.6	31.7 – 63.4

TIP:

- Calculation of the throw distance from the screen size

NP11FL lens throw distance (inch/m) = $H \times 0.8 : 27''/0.7 \text{ m}$ (min.) to $101''/2.6 \text{ m}$ (max.)

NP12ZL lens throw distance (inch/m) = $H \times 1.2$ to $H \times 1.5 : 30''/0.7 \text{ m}$ (min.) to $636''/16.1 \text{ m}$ (max.)

NP13ZL lens throw distance (inch/m) = $H \times 1.5$ to $H \times 3.0 : 38''/0.9 \text{ m}$ (min.) to $1272''/32.3 \text{ m}$ (max.)

NP14ZL lens throw distance (inch/m) = $H \times 2.9$ to $H \times 4.7 : 147''/3.7 \text{ m}$ (min.) to $1992''/50.6 \text{ m}$ (max.)

NP15ZL lens throw distance (inch/m) = $H \times 4.6$ to $H \times 7.1 : 234''/5.9 \text{ m}$ (min.) to $3010''/76.4 \text{ m}$ (max.)

NP40ZL lens throw distance (inch/m) = $H \times 0.8$ to $H \times 1.1 : 33''/0.8 \text{ m}$ (min.) to $466''/11.8 \text{ m}$ (max.)

NP41ZL lens throw distance (inch/m) = $H \times 1.3$ to $H \times 3.0 : 55''/1.4 \text{ m}$ (min.) to $1272''/32.3 \text{ m}$ (max.)

NP43ZL lens throw distance (inch/m) = $H \times 3.0$ to $H \times 5.9 : 127''/3.2 \text{ m}$ (min.) to $2501''/63.5 \text{ m}$ (max.)

“H” (Horizontal) refers to the screen width.

- * Figures differ by several % with the table above because the calculation is approximate.

Ex.: Throw distance when projecting on a 150" screen using the NP41ZL lens:

According to the “Screen Size (for reference)” table (→ page 174), H (screen width) = $127''/323.1 \text{ cm}$.

The throw distance is $127''/323.1 \text{ cm} \times 1.3$ to $127''/323.1 \text{ cm} \times 3.0 = 165''/420.0 \text{ cm}$ to $381''/969.3 \text{ cm}$ (because of the zoom lens).

Projection range for the different lenses

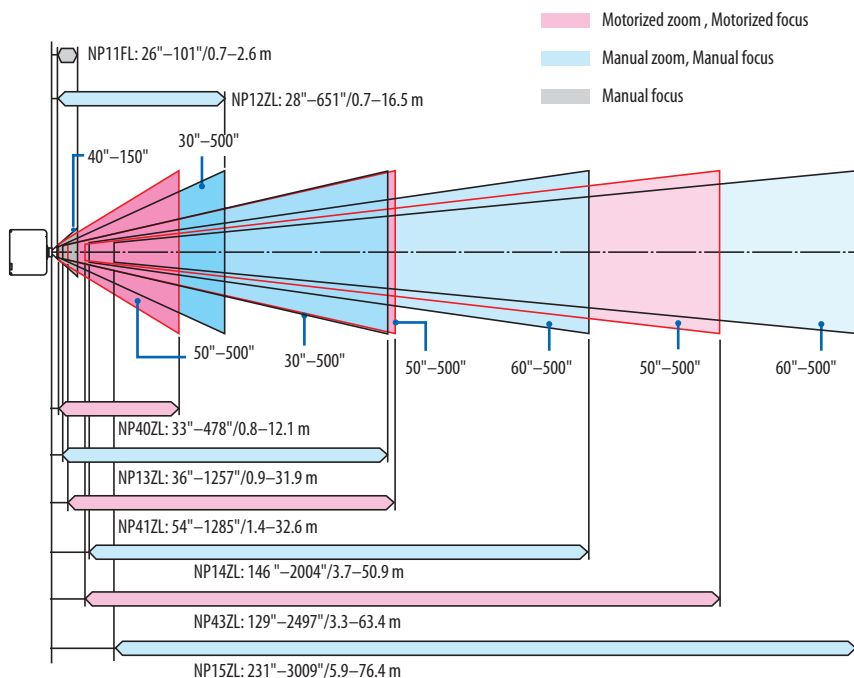

NP44ML

- Throw distance shows a distance between the center of the lens unit projection window and the screen face.
- If there is a wall below the screen bottom, allow 0.2 m/8" or longer of L1 distance to install the projector.

(Unit: inch)

Screen size (inches)	L1	L2	H1	H2
80	-2	22	21	63
100	3	27	25	78
120	9	33	28	92
150	18	42	34	114
180	26	50	40	135
200	32	56	43	149
240	44	68	51	178
270	52	76	56	199
300	61	85	62	221
350	75	99	71	257
400	90	114	80	292

(Unit: m)

Screen size (inches)	L1	L2	H1	H2
80	-0.06	0.55	0.53	1.61
100	0.08	0.70	0.63	1.98
120	0.23	0.84	0.72	2.34
150	0.45	1.06	0.86	2.88
180	0.67	1.28	1.01	3.43
200	0.81	1.43	1.10	3.79
240	1.11	1.72	1.29	4.52
270	1.33	1.94	1.43	5.07
300	1.54	2.16	1.57	5.61
350	1.91	2.52	1.81	6.65
400	2.28	2.89	2.04	7.43

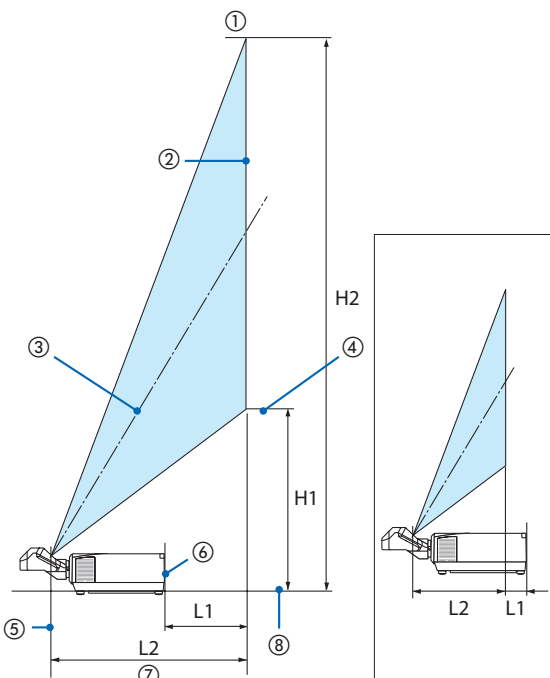

- ① Screen top end
- ② Screen face
- ③ Screen center
- ④ Screen bottom
- ⑤ Center of the lens unit projection window
- ⑥ Projector rear face
- ⑦ Throw distance
- ⑧ Projector bottom face

(when L1 is minus)

TIP:

- Calculation of the throw distance from the screen size

$$\text{NP44ML lens throw distance (m)} = H \times 0.32 : 22''/0.6 \text{ m (min.) to } 109''/2.8 \text{ m (max.)}$$
 "H" (Horizontal) refers to the screen width.

* Figures differ by several % with the table above because the calculation is approximate.

Tables of screen sizes and dimensions

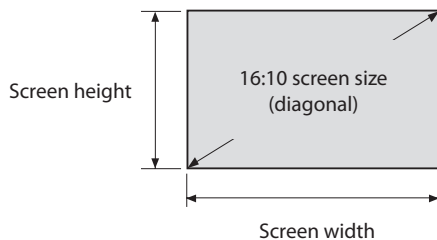

Size (inches)	Screen width		Screen height	
	(inches)	(cm)	(inches)	(cm)
30	25.4	64.6	15.9	40.4
40	33.9	86.2	21.2	53.8
50	42.4	107.7	26.5	67.3
60	50.9	129.2	31.8	80.8
80	67.8	172.3	42.4	107.7
100	84.8	215.4	53.0	134.6
120	101.8	258.5	63.6	161.5
150	127.2	323.1	79.5	201.9
200	169.6	430.8	106.0	269.2
240	203.5	516.9	127.2	323.1
300	254.4	646.2	159.0	403.9
400	339.2	861.6	212.0	538.5
500	424.0	1077.0	265.0	673.1

Lens shifting range

This projector is equipped with a lens shift function for adjusting the position of the projected image by buttons. The lens can be shifted within the range shown below.

Description of symbols: V indicates vertical (height of the projected image), H indicates horizontal (width of the projected image).

Desk/front projection

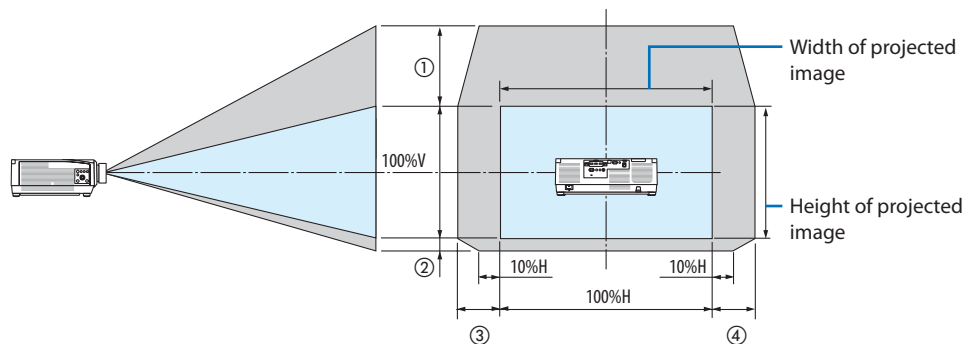

Ceiling/front projector

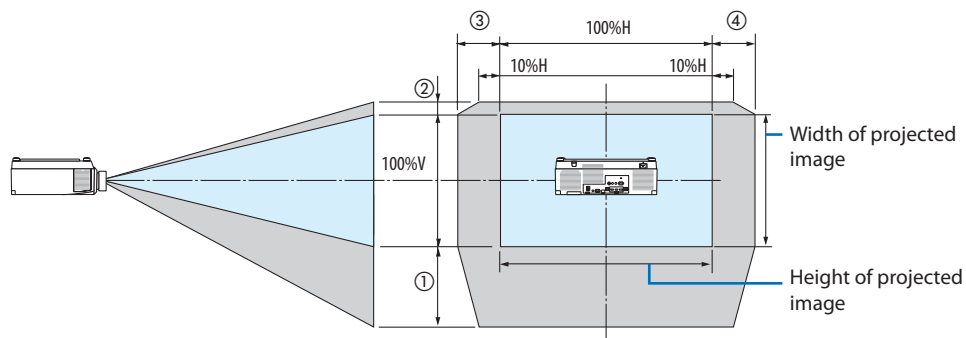

Number in the figure	Lens Unit						
	NP12ZL	NP13ZL	NP14ZL	NP15ZL	NP40ZL	NP41ZL	NP43ZL
①	50%V	50%V	50%V	50%V	50%V	50%V	50%V
②	10%V	10%V	10%V	10%V	10%V	10%V	10%V
③	30%H	30%H *	30%H	30%H	20%H	20%H	20%H
④	30%H	30%H *	30%H	30%H	20%H	20%H	20%H

* The maximum adjustable range for lens shift (H) is 15%H when the NP13ZL lens is used on 150" or larger screen.

Example: When projecting on a 150" screen using the NP40ZL lens:

According to the "Tables of screen sizes and dimensions" (→ page 174), H (screen width) = 323.1 cm and V (screen height) = 201.9 cm

Adjustment range in the vertical direction: The projected image can be moved upward $0.50 \times 201.9 \text{ cm} \approx 111 \text{ cm}$ and downward $0.1 \times 201.9 \text{ cm} \approx 20 \text{ cm}$ (when the lens is at the center position).

Adjustment range in the horizontal direction: The projected image can be moved to the left $0.20 \times 323.1 \text{ cm} \approx 65 \text{ cm}$, and this applies to the right direction which means approx. 65 cm.

* Your calculated figure has a few percent margin of error because the calculation formula is approximate.

NOTE:

- Use NP11FL at the home position. If necessary, fine-adjust the position of the projected image using the lens shift function.
 - The NP44ML must be fixed to the projector using the separately sold support kit (NP02LK). Loosen the screws of the support bracket, you can fine-adjustment of the lens shift. Have your dealer mount and adjust the support kit.
-

8-2. Compatible Input Signal List

HDMI/HDBaseT

Signal	Resolution (dots)	Aspect Ratio	Refresh Rate (Hz)
VGA	640 × 480	4 : 3	60/72/75/85/iMac
SVGA	800 × 600	4 : 3	56/60/72/75/85/iMac
XGA	1024 × 768	4 : 3	60/70/75/85/iMac
HD	1280 × 720	16 : 9	60
WXGA	1280 × 768	15 : 9	60
	1280 × 800	16 : 10	60
Quad-VGA	1280 × 960	4 : 3	60
SXGA	1280 × 1024	5 : 4	60
FWXGA	1360 × 768	16 : 9	60
	1366 × 768	16 : 9	60
SXGA+	1400 × 1050	4 : 3	60
WXGA+	1440 × 900	16 : 10	60
WXGA++	1600 × 900	16 : 9	60
WSXGA+	1680 × 1050	16 : 10	60
UXGA	1600 × 1200 *1	4 : 3	60
Full HD	1920 × 1080 *1	16 : 9	60
WUXGA	1920 × 1200 *1	16 : 10	60 (Reduced Blanking)
2K	2048 × 1080	17 : 9	60
WQHD iMac 27"	2560 × 1440	16 : 9	60
WQXGA	2560 × 1600	16 : 10	60 (Reduced Blanking)
4K	3840 × 2160	16 : 9	24/25/30/50*2/60*2
	4096 × 2160	17 : 9	24/25/30/50*2/60*2
HDTV (1080p)	1920 × 1080 *1	16 : 9	24/25/30/50*2/60*2
HDTV (1080i)	1920 × 1080 *1	16 : 9	48/50/60
HDTV (720p)	1280 × 720	16 : 9	50/60
SDTV (480p)	720/1440 × 480	4:3 / 16:9	60
SDTV (576p)	720/1440 × 576	4:3 / 16:9	50
SDTV (480i)	1440 × 480	4:3 / 16:9	60
SDTV (576i)	1440 × 576	4:3 / 16:9	50

DisplayPort

Signal	Resolution (dots)	Aspect Ratio	Refresh Rate (Hz)
VGA	640 × 480	4 : 3	60
SVGA	800 × 600	4 : 3	60
XGA	1024 × 768	4 : 3	60
HD	1280 × 720	16 : 9	60
WXGA	1280 × 768	15 : 9	60
	1280 × 800	16 : 10	60
Quad-VGA	1280 × 960	4 : 3	60
SXGA	1280 × 1024	5 : 4	60
FWXGA	1360 × 768	16 : 9	60
	1366 × 768	16 : 9	60
SXGA+	1400 × 1050	4 : 3	60
WXGA+	1440 × 900	16 : 10	60
WXGA++	1600 × 900	16 : 9	60
WSXGA+	1680 × 1050	16 : 10	60
UXGA	1600 × 1200 *1	4 : 3	60
Full HD	1920 × 1080 *1	16 : 9	60
WUXGA	1920 × 1200 *1	16 : 10	60 (Reduced Blanking)
2K	2048 × 1080	17 : 9	60
WQHD iMac 27"	2560 × 1440	16 : 9	60
WQXGA	2560 × 1600	16 : 10	60 (Reduced Blanking)
4K	3840 × 2160	16 : 9	24/25/30/50/60
	4096 × 2160	17 : 9	24/25/30/50/60
HDTV (1080p)	1920 × 1080	16 : 9	24/25/30/50/60
HDTV (720p)	1280 × 720	16 : 9	50/60
SDTV (480i/p)	720/1440 × 480	4:3 / 16:9	60
SDTV (576i/p)	720/1440 × 576	4:3 / 16:9	50

Analog RGB

Signal	Resolution (dots)	Aspect Ratio	Refresh Rate (Hz)
VGA	640 × 480	4 : 3	60/72/75/85/iMac
SVGA	800 × 600	4 : 3	56/60/72/75/85/iMac
XGA	1024 × 768	4 : 3	60/70/75/85/iMac
XGA+	1152 × 864	4 : 3	75
HD	1280 × 720	16 : 9	60
WXGA	1280 × 768	15 : 9	60/75/85
	1280 × 800	16 : 10	60/75/85
Quad-VGA	1280 × 960	4 : 3	60/85
SXGA	1280 × 1024	5 : 4	60/75/85
FWXGA	1360 × 768	16 : 9	60
	1366 × 768	16 : 9	60
SXGA+	1400 × 1050	4 : 3	60/75
WXGA+	1440 × 900	16 : 10	60/75/85
WXGA++	1600 × 900	16 : 9	60
UXGA	1600 × 1200 *1	4 : 3	60
WSXGA+	1680 × 1050	16 : 10	60
Fill HD	1920 × 1080 *1	16 : 9	60
WUXGA	1920 × 1200 *1	16 : 10	60 (Reduced Blanking)
2K	2048 × 1080	17 : 9	60
Full HD	1920 × 1080 *1	16 : 9	60
MAC 13"	640 × 480	4 : 3	67
MAC 16"	832 × 624	4 : 3	75
MAC 19"	1024 × 768	4 : 3	75
MAC 21"	1152 × 870	4 : 3	75
MAC 23"	1280 × 1024	5 : 4	65

Analog Component

Signal	Resolution (dots)	Aspect Ratio	Refresh Rate (Hz)
HDTV (1080p)	1920 × 1080	16 : 9	50/60
HDTV (1080i)	1920 × 1080	16 : 9	48/50/60
HDTV (720p)	1280 × 720	16 : 9	50/60
SDTV (480p)	720 × 480	4:3 / 16:9	60
SDTV (576p)	720 × 576	4:3 / 16:9	50
SDTV (480i)	720 × 480	4:3 / 16:9	60
SDTV (576i)	720 × 576	4:3 / 16:9	50

HDMI/HDBaseT 3D

Signal Resolution (dots)	Aspect Ratio	Refresh Rate (Hz)	3D Format			
1920 × 1080p	16 : 9	23.98/24	Frame Packing			
			Side By Side (Half)			
			Top And Bottom			
		25	Side By Side (Half)			
			Top And Bottom			
			29.97/30	Frame Packing		
		Side By Side (Half)				
		Top And Bottom				
		50	Side By Side (Half)			
			Top And Bottom			
			59.94/60	Side By Side (Half)		
		Top And Bottom				
1920 × 1080i	16 : 9	50		Side By Side (Half)		
			Top And Bottom			
		59.94/60	Side By Side (Half)			
			Top And Bottom			
			1280 × 720p	4 : 3	23.98/24	Frame Packing
						Side By Side (Half)
Top And Bottom						
25	Side By Side (Half)					
	Top And Bottom					
	29.97/30	Frame Packing				
Side By Side (Half)						
Top And Bottom						
50	Frame Packing					
	Side By Side (Half)					
	Top And Bottom					
59.94/60	Frame Packing					
	Side By Side (Half)					
	Top And Bottom					

DisplayPort 3D

Signal Resolution (dots)	Aspect Ratio	Refresh Rate (Hz)	3D Format
1920 × 1080p	16 : 9	23.98/24	Frame Packing
			Side By Side (Half)
			Top And Bottom
		25	Side By Side (Half)
			Top And Bottom
			29.97/30
		Side By Side (Half)	
		Top And Bottom	
		50	Side By Side (Half)
			Top And Bottom
			59.94/60
		Top And Bottom	
1280 × 720p	16 : 9	23.98/24	
			Side By Side (Half)
			Top And Bottom
		25	Side By Side (Half)
			Top And Bottom
			29.97/30
		Side By Side (Half)	
		Top And Bottom	
		50	Frame Packing
			Side By Side (Half)
			Top And Bottom
		59.94/60	Frame Packing
Side By Side (Half)			
Top And Bottom			

*1 Native resolution

*2 HDBaseT does not support this signal.

- Signals exceeding the projector's resolution are handled with Advanced AccuBlend.
- With Advanced AccuBlend, the size of characters and ruled lines may be uneven and colors may be blurred.
- Upon shipment, the projector is set for signals with standard display resolutions and frequencies, but adjustments may be required depending on the type of computer.

8-3. Specifications

Model name		PA1004UL-W/PA1004UL-B	PA804UL-W/PA804UL-B
Method		Three primary color liquid crystal shutter projection method	
Specifications of main parts			
Liquid crystal panel	Size	0.76" (with MLA) × 3 (aspect ratio: 16:10)	
	Pixels ^(*)	2,304,000 (1920 dots × 1200 lines)	
Projection lenses		Refer to the specifications of option lens (→ 185 page)	
Light source		Laser diode	
Optical device		Integrator, Dichroic Mirror, XDP	
Light output ^(*) ^(*)	REF. LIGHT MODE		
	NORMAL	9000 lm	7500 lm
	BOOST	10000 lm	8200 lm
Screen size (throw distance)		Please refer to the "Throw distance and screen size" (→ 171 page)	
Color reproducibility		10-bit color processing (approx. 1.07 billion colors)	
Scanning frequency	Horizontal	Analog: 15 kHz, 24 to 100 kHz (24 kHz or greater for RGB inputs), conforming to VESA standards Digital: 15 kHz, 24 to 153 kHz, conforming to VESA standards	
	Vertical	Analog: 48 Hz, 50 to 85 Hz, 100, 120 Hz conforming to VESA standards Digital: 24, 25, 30, 48 Hz, 50 to 85 Hz, 100, 120 Hz conforming to VESA standards	
Main adjustment functions		Zoom, Focus, Lens Shift (Refer to the specifications of option lens → page 185), input signal switching (HDMI1/HDMI2/DisplayPort/COMPUTER/HDBaseT), auto image adjustment, picture enlarging, picture position adjustment, muting (both video and audio), power on/standby, on-screen display/selection, etc.	
Max. display resolution (horizontal × vertical)		Analog WUXGA (1920 × 1200) with Advanced AccuBlend Pixel clock frequency: less than 165 MHz Digital Quad HD (4096 × 2160) with Advanced AccuBlend Pixel clock frequency: less than 600 MHz (HDBaseT: 300 MHz)	
Input signals			
R,G,B,H,V	RGB: 0.7 Vp-p/75 Ω		
	Y: 1.0 Vp-p/75 Ω (with Negative Polarity Sync)		
	Cb, Cr (Pb, Pr): 0.7 Vp-p/75 Ω		
	H/V Sync: 4.0 Vp-p/TTL		
	Composite Sync: 4.0 Vp-p/TTL		
Sync on G: 1.0 Vp-p/75 Ω (with Sync)			
Component	Y: 1.0 Vp-p/75 Ω (with Sync)		
	Cb, Cr (Pb, Pr): 0.7 Vp-p/75 Ω		
	DTV: 480i, 480p, 720p, 1080i, 1080p (60 Hz) 576i, 576p, 720p, 1080i (50 Hz)		
	DVD: Progressive signal (50/60 Hz)		
Audio		0.5 Vrms/22 kΩ or greater	
Input/output connectors			
Computer/Component	Video input	Mini D-Sub 15-pin × 1	
	Audio input	Stereo mini jack × 1	
	Audio output	Stereo mini jack × 1 (common for all signals)	

Model name		PA1004UL-W/PA1004UL-B	PA804UL-W/PA804UL-B
HDMI	Video input	HDMI® Connector type A × 2 RJ-450 × 1, 100BASE-TX compatible Deep Color (color depth): 8-/10-/12-bit compatible Colorimetry: RGB, YCbCr444, YCbCr422, YCbCr420, REC2020, REC709, REC601 Supports LipSync, HDCP ^(*) , 4K HDR and 3D	
	Audio input	HDMI: Sampling frequency – 32/44.1/48 kHz, Sampling bits – 16/20/24 bits	
HDBaseT/Ethernet	Video input	Deep Color (color depth): Support 8/10/12 bits Colorimetry: Support RGB, YCbCr444, YCbCr422, YCbCr420, REC2020, REC709, REC601 Support LipSync, HDCP ^(*) , 3D, HDR	
	Video output	RJ-45 × 1, 100BASE-TX Deep Color (color depth): Support 8/10/12 bits Colorimetry: Support RGB, YCbCr444, YCbCr422, REC709, REC601 Support LipSync, HDCP ^(*) , 3D	
	Audio input	Sampling frequency: 32/44.1/48 kHz Sampling bit: 16/20/24 bit	
	Audio output	Sampling frequency: 32/44.1/48 kHz Sampling bit: 16/20/24 bits	
DisplayPort	Video input	DisplayPort × 1 Data rate: 5.4 Gbps/2.7 Gbps/1.62 Gbps No. lanes: 1 lane/2 lanes/4 lanes Color depth: 8 bits, 10 bits, 12 bits Colorimetry: RGB, YCbCr444, YCbCr422, REC709, REC601 HDCP compatible ^(*)	
	Audio input	DisplayPort: Sampling frequency – 32/44.1/48 kHz, Sampling bits – 16/20/24 bits	
PC control terminal		D-Sub 9-pin × 1	
USB port		USB type A × 1	
Ethernet/LAN/HDBaseT port		RJ-45 × 1, Supports 10BASE-T/100BASE-TX	
Remote terminal		Stereo mini jack × 1	
3D SYNC output terminal		5 V / 10 mA, synchronized signal output for 3D use	
Usage environment ^(*)		Operating temperature: 41 to 104°F (5 to 40°C) Operating humidity: 20 to 80% (with no condensation) Storage temperature: 14 to 122°F (–10 to 50°C) Storage humidity: 20 to 80% (with no condensation) Operating altitude: 0 to 3650 m/12000 feet (1700 to 3650 m/5500 to 12000 feet: Set [FAN MODE] to [HIGH ALTITUDE])	
Power supply		100-240 V AC, 50/60 Hz	

Model name			PA1004UL-W/PA1004UL-B	PA804UL-W/PA804UL-B
Power consumption	REF. LIGHT MODE	BOOST	845 W (100-130 V AC) 810 W (200-240 V AC)	675 W (100-130 V AC) 655 W (200-240 V AC)
		NORMAL	750 W (100-130 V AC) 725 W (200-240 V AC)	635 W (100-130 V AC) 615 W (200-240 V AC)
		ECO1	610 W (100-130 V AC) 590 W (200-240 V AC)	515 W (100-130 V AC) 505 W (200-240 V AC)
		ECO2	405 W (100-130 V AC) 395 W (200-240 V AC)	360 W (100-130 V AC) 350 W (200-240 V AC)
	STANDBY	Network enabled	0.8 W (100-130 V AC) / 0.8 W (200-240 V AC)	
		Network disabled	0.22 W (100-130 V AC) / 0.28 W (200-240 V AC)	
Rated input current			10.5 A (100-130 V AC) 4.6 A (200-240 V AC)	8.6 A (100-130 V AC) 3.8 A (200-240 V AC)
Power cord specification			15 A or higher	
External dimensions (W × H × D)			23.6" (width) × 8.2" (height) × 19.3" (depth)/ 599 (width) × 208 (height) × 490 (depth) mm (not including protruding parts)	
			23.6" (width) × 8.5" (height) × 19.3" (depth)/ 599 (width) × 216 (height) × 490 (depth) mm (including protruding parts)	
Weight			53.8 lbs/24.4 kg (not including lens)	53.1 lbs/24.1 kg (not including lens)

*1 Effective pixels are more than 99.99%.

*2 This is the light output value (lumens) mounting the lens unit, NP41ZL, when the [PRESET] mode is set to [HIGH-BRIGHT]. The light output values will be dropped according to the setting of [REF. LIGHT MODE]. If any other mode is selected as the [PRESET] mode, the light output value may drop slightly.

*3 Compliance with ISO21118-2012

*4 If you are unable to view material via the HDMI input, this does not necessarily mean the projector is not functioning properly. With the implementation of HDCP, there may be cases in which certain content is protected with HDCP and might not be displayed due to the decision/intention of the HDCP community (Digital Content Protection, LLC).

Video: HDR, Deep Color, 8/10/12-bit, Lip Sync.

Audio: LPCM; up to 2 ch, sample rate 32/44.1/48 KHz, sample bit; 16/20/24-bit

HDMI: Supports HDCP 2.2/1.4

DisplayPort: Supports HDCP 1.3

HDBaseT: Supports HDCP 2.2/1.4

*5 "Forced ECO Mode" is set depending on the temperature of the operating environment and [REF. LIGHT MODE] setting, the projector goes into "Forced ECO Mode". (→ page 43)

• For additional information visit:

US: <https://www.sharpnecdisplays.us>

Europe: <https://www.sharpnecdisplays.eu>

Global: <https://www.sharp-nec-displays.com/global/>

For information on our optional accessories, visit our website or see our brochure.

The specifications are subject to change without notice.

Option lens (sold separately)

NP11FL	Manual focus
	(Throw ratio 0.81 : 1, F2.3, f=13.2 mm)
NP12ZL	Motorized lens shift, Manual zoom, Manual focus
	(Throw ratio 1.16–1.52 : 1, F2.20–2.69, f=19.4–25.3 mm)
NP13ZL	Motorized lens shift, Manual zoom, Manual focus
	(Throw ratio 1.46–2.95 : 1, F1.70–2.37, f=24.4–48.6 mm)
NP14ZL	Motorized lens shift, Manual zoom, Manual focus
	(Throw ratio 2.90–4.68 : 1, F2.20–2.64, f=48.5–77.6 mm)
NP15ZL	Motorized lens shift, Manual zoom, Manual focus
	(Throw ratio 4.59–7.02 : 1, F2.20–2.70, f=76.6–116.5 mm)
NP40ZL	Motorized lens shift, Motorized zoom , Motorized focus
	(Throw ratio 0.79–1.11 : 1, F2.0–2.5, f=13.3–18.6 mm)
NP41ZL	Motorized lens shift, Motorized zoom , Motorized focus
	(Throw ratio 1.30–3.02 : 1, F1.7–2.0, f=21.8–49.8 mm)
NP43ZL	Motorized lens shift, Motorized zoom, Motorized focus
	(Throw ratio 2.99–5.93 : 1, F2.2–2.6, f=49.7–99.8 mm)
NP44ML	Motorized lens shift, Motorized focus
	(Throw ratio 0.32 : 1, F2.0, f=6.27 mm)

NOTE:

- The above throw ratio is for projecting on 100" screen.
- Use NP11FL at the home position. If necessary, fine-adjust the position of the projected image using the lens shift function.
- Fix the NP44ML to the projector using the separately sold support kit (NP02LK). Loosen the screws of the support bracket, you can fine-adjustment of the lens shift.
- Have your dealer mount and adjust the lens unit and support kit.

8-4. Cabinet Dimensions

Unit: mm (inch)

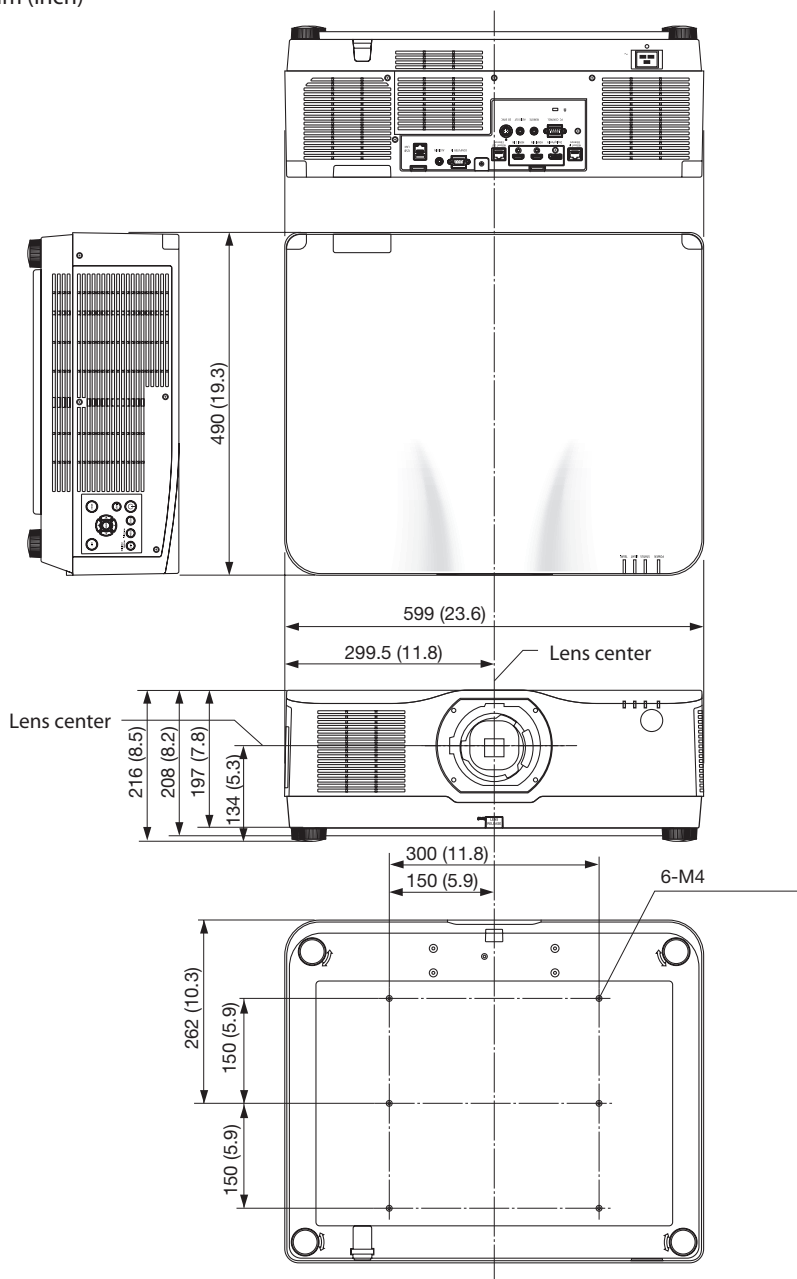

8-5. Pin assignments and signal names of main connectors

COMPUTER IN/ Component Input Connector (Mini D-Sub 15 Pin)

Connection and signal level of each pin

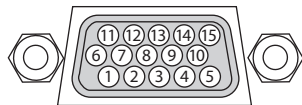

Signal Level

Video signal : 0.7 Vp-p (Analog)

Sync signal : TTL level

Pin No.	RGB Signal (Analog)	YCbCr Signal
1	Red	Cr
2	Green or Sync on Green	Y
3	Blue	Cb
4	Ground	
5	Ground	
6	Red Ground	Cr Ground
7	Green Ground	Y Ground
8	Blue Ground	Cb Ground
9	No Connection	
10	Sync Signal Ground	
11	No Connection	
12	Bi-directional DATA (SDA)	
13	Horizontal Sync or Composite Sync	
14	Vertical Sync	
15	Data Clock	

HDMI 1 IN/HDMI 2 IN Connector (Type A)

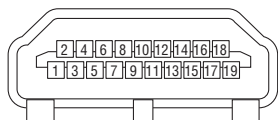

Pin No.	Signal
1	TMDS Data 2+
2	TMDS Data 2 Shield
3	TMDS Data 2-
4	TMDS Data 1+
5	TMDS Data 1 Shield
6	TMDS Data 1-
7	TMDS Data 0+
8	TMDS Data 0 Shield
9	TMDS Data 0-
10	TMDS Clock +
11	TMDS Clock Shield
12	TMDS Clock-
13	CEC
14	Disconnection
15	SCL
16	SDA
17	DDC/CEC grounding
18	+5 V power supply
19	Hot plug detection

DisplayPort IN Connector

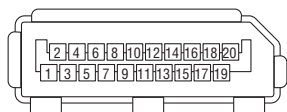

Pin No.	Signal
1	Main link lane 3-
2	Grounding 3
3	Main link lane 3+
4	Main link lane 2-
5	Grounding 2
6	Main link lane 2+
7	Main link lane 1-
8	Grounding 1
9	Main link lane 1+
10	Main link lane 0-
11	Grounding 0
12	Main link lane 0+
13	Configuration 1
14	Configuration 2
15	Supplementary channel +
16	Grounding 4
17	Supplementary channel -
18	Hot plug detection
19	Return
20	+3.3 V power supply

HDBaseT IN/Ethernet Port (RJ-45)

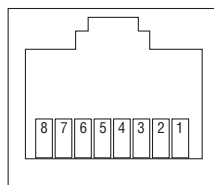

Pin No.	Signal
1	TxD+/HDBT0+
2	TxD-/HDBT0-
3	RxD+/HDBT1+
4	Disconnection/HDBT2+
5	Disconnection/HDBT2-
6	RxD-/HDBT1-
7	Disconnection/HDBT3+
8	Disconnection/HDBT3-

USB Port (Type A)

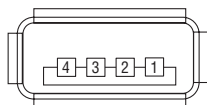

Pin No.	Signal
1	V _{BUS}
2	D-
3	D+
4	Grounding

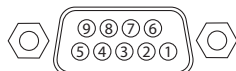
PC CONTROL Port (D-Sub 9 Pin)

Pin No.	Signal
1	Unused
2	RxD reception data
3	TxD transmission data
4	Unused
5	Grounding
6	Unused
7	RTS transmission request
8	CTS transmission allowed
9	Unused

8-6. Changing the Background Logo (Virtual Remote Tool)

This will help you perform operations such as projector's power on or off and signal selection via a LAN connection. It is also used to send an image to the projector and register it as the logo data of the projector. After registering it, you can lock the logo to prevent it from changing.

Control Functions

Power On/Off, signal selection, picture freeze, picture mute, audio mute, Logo transfer to the projector, and remote control operation on your PC.

Virtual Remote screen



Remote Control Window

Use this button for changing the background logo.

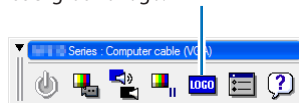

Toolbar

For getting the Virtual Remote Tool, please visit our web site and download it:

<https://www.sharp-nec-displays.com/dl/en/index.html>

NOTE:

- Remote Control Window is not available for changing the background logo.
Please see the HELP menu of the Virtual Remote Tool about how to display the Toolbar.
- Logo data (graphics) that can be sent to the projector with Virtual Remote Tool has the following restrictions:
(Only via serial or LAN connection)
 - * File size: Within 256 kilobytes
 - * Image size: Within the resolution of the projector
 - * File format: PNG (Full color)
- Logo data (image) sent using the Virtual Remote Tool will be displayed in the center with the surrounding area in black.
- To put the default "NEC logo" back in the background logo, you need to register it as the background logo by using the image file (Logo\necpj_bbwux.png) included on the supplied NEC Projector CD-ROM.

8-7. Troubleshooting





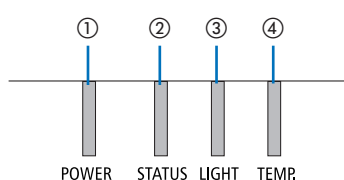



























This section helps you resolve problems you may encounter while setting up or using the projector.



























Feature of each indicator



- ① POWER indicator
- ② STATUS indicator
- ③ LIGHT indicator
- ④ TEMP. indicator

Indicator Message (Status message)

POWER	STATUS	LIGHT	TEMP.	Projector status
 Off	 Off	 Off	 Off	Power is off
 Orange (Blink ^{*1})	 Off	 Off	 Off	In the state of Standby ([POWER-SAVING] is [ON] and the network is ready).
 Orange (Blink ^{*2})	 Off	 Off	 Off	In the state of Standby ([POWER-SAVING] is [ON] and the network is unavailable).
 Orange (Light)	 Off	 Off	 Off	In the state of Standby ([POWER-SAVING] is [ON] and the network is available)
 Orange (Blink ^{*3})	 Off	 Off	 Off	[ON] time as the [PROGRAM TIMER] is activated. (In the state of Standby)
 Green (Light)	 Off	 Off	 Off	In the state of Sleep
 Green (Blink ^{*3})	 Off	 Off	 Off	[ON] time as the [PROGRAM TIMER] is activated. (In the state of Sleep)
 Blue (Light)	 Off	 Green (Light)	 Off	Powered state ([REF. LIGHT MODE] is [NORMAL])

POWER	STATUS	LIGHT	TEMP.	Projector status
 Blue (Light)	 Off	 Green (Blink* ³)	 Off	Powered state ([REF. LIGHT MODE] is [ECO1] or [ECO2])
 Blue (Light)	 Off	 Green and orange (Blink* ⁴)	 Off	Powered state ([REF. LIGHT MODE] is [BOOST])
Status varies	 Orange (Blink* ⁵)	Status varies	 Off	[LENS CALIBRATION] implement request.
 Blue (Light)	 Green (Blink* ⁵)	 Status varies	 Off	Performing the lens calibration
 Blue (Light)	 Status varies	 Off	 Off	Shutter function is activating
 Blue (Blink* ³)	 Off	 Status varies	 Off	[OFF TIMER] is activated, [OFF] time as the [PROGRAM TIMER] is activated (Powered state)
 Blue (Blink* ⁵)	 Off	 Off	 Off	Preparing for powering [ON]

*1 Repetition to light on for 1.5 seconds / off for 1.5 seconds

*2 Repetition to light on for 1.5 seconds / off for 7.5 seconds













*3 Repetition to light on for 2.5 seconds / off for 0.5 seconds

*4 Lit in green for 2.5 seconds/lit in orange for 0.5 seconds repeatedly

*5 Repetition to light on for 0.5 seconds / off for 0.5 seconds / on for 0.5 seconds / off for 2.5 seconds

*6 Repetition to light on for 0.5 seconds / off for 0.5 seconds

Indicator Message (Error message)

POWER	STATUS	LIGHT	TEMP.	Projector status	Procedure
 Blue (Light)	 Orange (Light)	Status varies	 Off	A button has been pressed while the [CONTROL PANEL LOCK] is activated.	The [CONTROL PANEL LOCK] is activated. The setting must be canceled to operate the projector. (→ page 137)
				ID numbers for the projector and the remote control do not match.	Check the [CONTROL ID] (→ page 138)
 Blue (Light)	 Off	 Orange (Light)	 Orange (Light)	Temperature problem (In the Forced ECO)	Ambient temperature is high. Lower the room temperature.
 Red (Blink*7)	 Off	 Off	 Off	Temperature problem	Ambient temperature is out of the operation temperature. Check if any obstruction stays near the exhaust vent.
 Red (Light)	Status varies	Status varies	 Off	Error requiring service support	Contact your dealer or service personnel. Make sure to check and inform indicator status for asking to repair.

*7 Repetition to light on for 0.5 seconds / off for 0.5 seconds

When the thermal protector is activated:

When inside temperature of the projector becomes too high or low, the POWER indicator start to red blink in a short cycle. After this happened, the thermal protector will activate and the projector may be turned off.

In this case, please take the below measures:

- Pull out the power plug from the wall inlet.
- Place the projector in cool place if it has been placed in high ambient temperature.
- Clean the exhaust vent if dust has accumulated on.
- Leave the projector for about one hour until inside temperature gets lower.

Common Problems & Solutions

(→ “Indicator Message” on page 191.)

Problem	Check These Items
Does not turn on or shut down	<ul style="list-style-type: none"> • Check that the power cord is plugged in and that the power button on the projector cabinet or the remote control is on. (→ pages 17, 20) • Check to see if the projector has temperature error, If projector inside temperature is too hot or cool, it disabled to turn on the projector as the protection. Wait for a moment and try turn on the projector again. • Set [FAN MODE] to [HIGH ALTITUDE] when using the projector at altitudes approximately 5500 feet/1700 meters or higher. Using the projector at altitudes approximately 5500 feet/1700 meters or higher without setting to [HIGH ALTITUDE] can cause the projector to overheat and the projector could shut down. If this happens, wait a couple minutes and turn on the projector. (→ page 127) If you turn on the projector immediately after the light module is turned off, the fans run without displaying an image for some time and then the projector will display the image. Wait for a moment. • In case it's hard to think the trouble is not caused on the above mentioned conditions, unplug the power cord from the outlet. Then wait 5 minutes before plugging it in again. (→ page 37)
Will turn off	<ul style="list-style-type: none"> • Ensure that the [OFF TIMER], [AUTO POWER OFF] or [PROGRAM TIMER] is off. (→ page 133, 154)
No picture	<ul style="list-style-type: none"> • Check if the appropriate input is selected. (→ page 23) If there is still no picture, press the INPUT button or one of the input buttons again. • Ensure your cables are connected properly. • Use menus to adjust the brightness and contrast. (→ page 100) • Is the [POWER ON SHUTTER] in the on-screen menu set to [CLOSE]? • Reset the settings or adjustments to factory preset levels using the [RESET] in the Menu. (→ page 155) • Enter your registered keyword if the Security function is enabled. (→ page 50) • If the HDMI input or the DisplayPort signal cannot be displayed, try the following. <ul style="list-style-type: none"> - Reinstall your driver for the graphics card built in your computer, or use the updated driver. For reinstalling or updating your driver, refer to the user guide accompanied with your computer or graphics card, or contact the support center for your computer manufacturer. Install the updated driver or OS on your own responsibility. We are not liable for any trouble and failure caused by this installation. • The signal may not be supported depending on the HDBaseT transmission device. In addition, RS232C interface may not be supported. • Be sure to connect the projector and notebook PC while the projector is in standby mode and before turning on the power to the notebook PC. In most cases the output signal from the notebook PC is not turned on unless connected to the projector before being powered up. <ul style="list-style-type: none"> * If the screen goes blank while using your remote control, it may be the result of the computer's screen-saver or power management software. • See also the page 196.
Picture suddenly becomes dark	<ul style="list-style-type: none"> • Check if the projector is in the Forced ECO mode because of too high ambient temperature. If this is the case, lower the internal temperature of the projector by selecting [HIGH] for [FAN MODE]. (→ page 127)
Color tone or hue is unusual	<ul style="list-style-type: none"> • Check if an appropriate color is selected in [WALL COLOR]. If so, select an appropriate option. (→ page 127) • Adjust [HUE] in [PICTURE]. (→ page 100)

Problem	Check These Items
Image isn't square to the screen	<ul style="list-style-type: none"> • Reposition the projector to improve its angle to the screen. (→ page 26) • Perform [GEOMETRIC CORRECTION] when the trapezoid is distorted. (→ page 45)
Picture is blurred	<ul style="list-style-type: none"> • Adjust the focus. (→ page 29) • Reposition the projector to improve its angle to the screen. (→ page 26) • Ensure that the distance between the projector and screen is within the adjustment range of the lens. (→ page 171) • Has the lens been shifted by an amount exceeding the guaranteed range? (→ page 175) • Condensation may form on the lens if the projector is cold, brought into a warm place and is then turned on. Should this happen, let the projector stand until there is no condensation on the lens.
Flicker appears on screen	<ul style="list-style-type: none"> • Set [FAN MODE] to other than [HIGH ALTITUDE] mode when using the projector at altitudes approximately 5500 feet/1700 meters or lower. Using the projector at altitudes less than approximately 5500 feet/1700 meters and setting to [HIGH ALTITUDE] can cause the light module to overcool, causing the image to flicker. Switch [FAN MODE] to [AUTO]. (→ page 127)
Image is scrolling vertically, horizontally or both	<ul style="list-style-type: none"> • Check the computer's resolution and frequency. Make sure that the resolution you are trying to display is supported by the projector. (→ page 177) • Adjust the computer image manually with the Horizontal/Vertical in the [IMAGE OPTIONS]. (→ page 102)
Remote control does not work	<ul style="list-style-type: none"> • Install new batteries. (→ page 13) • Make sure there are no obstacles between you and the projector. • Stand within 20 m/787 inch of the projector. (→ page 14)
Indicator is lit or blinking	<ul style="list-style-type: none"> • See the Indicator Message. (→ page 191)
Cross color in RGB mode	<ul style="list-style-type: none"> • Adjust the computer image manually with [CLOCK]/[PHASE] in [IMAGE OPTIONS] in the menu. (→ page 101)

For more information contact your dealer.

If there is no picture, or the picture is not displayed correctly.

Power on process for the projector and the PC.

Be sure to connect the projector and notebook PC while the projector is in standby mode and before turning on the power to the notebook PC.

In most cases the output signal from the notebook PC is not turned on unless connected to the projector before being powered up.

NOTE:

- You can check the horizontal frequency of the current signal in the projector's menu under Information. If it reads "0kHz", this means there is no signal being output from the computer. (→ page 156 or go to next step)
-

Enabling the computer's external display.

Displaying an image on the notebook PC's screen does not necessarily mean it outputs a signal to the projector. When using a PC compatible laptop, a combination of function keys will enable/disable the external display. Usually, the combination of the "Fn" key along with one of the 12 function keys gets the external display to come on or off. For example, NEC laptops use Fn + F3, while Dell laptops use Fn + F8 key combinations to toggle through external display selections.

Non-standard signal output from the computer

If the output signal from a notebook PC is not an industry standard, the projected image may not be displayed correctly. Should this happen, deactivate the notebook PC's LCD screen when the projector display is in use. Each notebook PC has a different way of deactivate/reactivate the local LCD screens as described in the previous step. Refer to your computer's documentation for detailed information.

Image displayed is incorrect when using a Mac

When using a Mac with the projector, set the DIPswitch of the Mac adapter (not supplied with the projector) according to your resolution. After setting, restart your Mac for the changes to take affect. For setting display modes other than those supported by your Mac and the projector, changing the DIP switch on a Mac adapter may bounce an image slightly or may display nothing. Should this happen, set the DIP switch to the 13" fixed mode and then restart your Mac. After that, restore the DIP switches to a displayable mode and then restart the Mac again.

NOTE:

- A Video Adapter cable manufactured by Apple Computer is needed for a MacBook which does not have a mini D-Sub 15-pin connector.
-

Mirroring on a MacBook

When using the projector with a MacBook, output may not be set to 1920 × 1200 unless "mirroring" is off on your MacBook. Refer to owner's manual supplied with your Mac computer for mirroring.

Folders or icons are hidden on the Mac screen

Folders or icons may not be seen on the screen. Should this happen, select [View] → [Arrange] from the Apple menu and arrange icons.

8-8. PC Control Codes and Cable Connection

PC Control Codes

Function	Code Data							
POWER ON	02H	00H	00H	00H	00H	02H		
POWER OFF	02H	01H	00H	00H	00H	03H		
INPUT SELECT HDMI1	02H	03H	00H	00H	02H	01H	A1H	A9H
INPUT SELECT HDMI2	02H	03H	00H	00H	02H	01H	A2H	AAH
INPUT SELECT DisplayPort	02H	03H	00H	00H	02H	01H	A6H	AEH
INPUT SELECT COMPUTER	02H	03H	00H	00H	02H	01H	01H	09H
INPUT SELECT HDBaseT	02H	03H	00H	00H	02H	01H	BFH	C7H
PICTURE MUTE ON	02H	10H	00H	00H	00H	12H		
PICTURE MUTE OFF	02H	11H	00H	00H	00H	13H		
SOUND MUTE ON	02H	12H	00H	00H	00H	14H		
SOUND MUTE OFF	02H	13H	00H	00H	00H	15H		

NOTE:

- Contact your local dealer for a full list of the PC Control Codes if needed.

Cable Connection

Communication Protocol

Baud rate	115200/38400/19200/9600/4800 bps
Data length	8 bits
Parity	No parity
Stop bit	1 bit
X on/off	None
Communications procedure	Full duplex

NOTE:

- Depending on the equipment, a lower baud rate may be recommended for long cable runs.

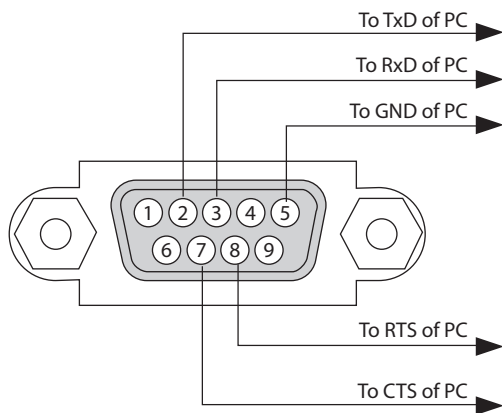
PC Control Terminal (D-Sub 9P)**NOTE:**

- Pins 1, 4, 6 and 9 are no used.
- Jumper "Request to Send" and "Clear to Send" together on both ends of the cable to simplify cable connection.
- For long cable runs it is recommended to set communication speed within projector menus to 9600 bps.

8-9. About the ASCII Control Command

This device supports the common ASCII Control Command for controlling our projector and monitor. Please visit our web site for detailed information about the command.

https://www.sharp-nec-displays.com/dl/en/pj_manual/lineup.html

How to connect with an external device

There are two methods to connect the projector with an external device such as a computer.

1. Connection thru the serial port.

Connects the projector to a computer by a serial cable (a cross cable).

2. Connection via network (LAN/HDBaseT)

Connects the projector to a computer by a LAN cable.

Concerning to the type of LAN cable, please ask to your network administrator.

Connection interface

1. Connection thru the serial port.

Communication Protocol

Item	Information
Baud rate	115200/38400/19200/9600/4800 bps
Data length	8 bits
Parity bit	No parity
Stop bit	1 bit
Flow control	None
Communications procedure	Full duplex

2. Connection via network

Communication Protocol (Connection via LAN)

Item	Information
Communication speed	Set automatically (10/100 Mbps)
Supported standard	IEEE802.3 (10BASE-T)
	IEEE802.3u (100BASE-TX, Auto-Negotiation)

Use the TCP port number 7142 for transmitting and receiving command.

Communication Protocol (Connection via HDBaseT)

Item	Information
Communication speed	100 Mbps
Supported standard	IEEE802.3u (100BASE-TX, Auto-Negotiation)

Use the TCP port number 7142 for transmitting and receiving command.

Parameters for this device

Input command

Input terminal	Response	Parameter
HDMI1	hdmi1	hdmi1 or hdmi
HDMI2	hdmi2	hdmi2
DisplayPort	displayport	displayport or displayport1
COMPUTER	computer	One among computer, computer1, vga, vga1, rgb, and rgb1
HDBaseT	hdbaset	hdbaset or hdbaset1

Status command

Response	Error Status
error:temp	Temperature error
error:fan	Fan trouble
error:light	Light source trouble
error:system	System trouble

8-10. List of Art-Net DMX parameters

Function	Behavior	Parameter	Note
POWER	OFF	0 – 63	
	No operation	64 – 191	
	ON	192 – 255	
INPUT	No operation	0 – 7	
	HDMI1	8 – 15	
	No operation	16 – 23	
	HDMI2	24 – 31	
	No operation	32 – 39	
	DisplayPort	40 – 47	
	No operation	48 – 55	
	COMPUTER	56 – 63	
	No operation	64 – 71	
	HDBaseT	72 – 79	
BLANK	OFF	0 – 63	
	No operation	64 – 191	
	ON	192 – 255	
SHUTTER	OPEN	0 – 63	
	No operation	64 – 191	
	CLOSE	192 – 255	
FREEZE	OFF	0 – 63	
	No operation	64 – 191	
	ON	192 – 255	
LIGHT ADJUST	No operation	0 – 49	
	Adjusted value	50 – 100	
	No operation	101 – 255	
LENS SHIFT(H)	Adjust Left	0 – 63	
	Stop	64 – 191	
	Adjust Right	192 – 255	
LENS SHIFT(V)	Adjust Down	0 – 63	
	Stop	64 – 191	
	Adjust Up	192 – 255	
FOCUS	Adjust (-)	0 – 63	
	Stop	64 – 191	
	Adjust (+)	192 – 255	
ZOOM	Adjust (-)	0 – 63	
	Stop	64 – 191	
	Adjust (+)	192 – 255	
KEYSTONE(H)	No operation		Adjust +/- with 128 as the center (adjustment Adjusted value value 0).
	Adjusted value		
	No operation		
KEYSTONE(V)	No operation		Adjust +/- with 128 as the center (adjustment value 0).
	Adjusted value		
	No operation		

Function	Behavior	Parameter	Note
LOCK	Inoperable	0 – 127	Disables the Art-Net function.
	Operable	128 – 255	Enables the Art-Net function.

8-11. Troubleshooting Check List

Before contacting your dealer or service personnel, check the following list to be sure repairs are needed also by referring to the “Troubleshooting” section in your user’s manual. This checklist below will help us solve your problem more efficiently.

* Print this page and the next page for your check.

Frequency of occurrence:

always sometimes (How often? _____) other (_____)

Power

- No power (POWER indicator does not light blue). See also “Status Indicator (STATUS)”.
- Power cord’s plug is fully inserted into the wall outlet.
- No power even though you press and hold the POWER button.
- Shut down during operation.
 - Power cord’s plug is fully inserted into the wall outlet.
 - [AUTO POWER OFF] is turned off (only models with the [AUTO POWER OFF] function).
 - [OFF TIMER] is turned off (only models with the [OFF TIMER] function).

Video and Audio

- No image is displayed from your PC or video equipment to the projector.
 - Still no image even though you connect the projector to the PC first, then start the PC.
 - Enabling your notebook PC’s signal output to the projector.
 - A combination of function keys will enable/disable the external display. Usually, the combination of the “Fn” key along with one of the 12 function keys turns the external display on or off.
 - No image (blue or black background, no display).
 - Still no image even though you carry out [RESET] in the projector’s menu.
 - Signal cable’s plug is fully inserted into the input terminal
 - A message appears on the screen. (_____)
 - The source connected to the projector is active and available.
 - Still no image even though you adjust the brightness and/or the contrast.
 - Input source’s resolution and frequency are supported by the projector.
- Image is too dark.
 - Remains unchanged even though you adjust the brightness and/or the contrast.
- Image is distorted.
 - Image appears to be trapezoidal (unchanged even though you carry out the [KEystone] adjustment).
- Parts of the image are lost.
 - Still unchanged even though you carry out [RESET] in the projector’s menu.
- Image is shifted in the vertical or horizontal direction.
 - Horizontal and vertical positions are correctly adjusted on a computer signal.
 - Input source’s resolution and frequency are supported by the projector.
 - Some pixels are lost.
- Image is flickering.
 - Still unchanged even though you carry out [RESET] in the projector’s menu.
 - Image shows flickering or color drift on a computer signal.
 - Still unchanged even though you change [FAN MODE] from [HIGH ALTITUDE] to [AUTO].
- Image appears blurry or out of focus.
 - Still unchanged even though you checked the signal’s resolution on PC and changed it to projector’s native resolution.
 - Still unchanged even though you adjusted the focus.
- No sound.
 - Audio cable is correctly connected to the audio input of the projector.
 - Still unchanged even though you adjusted the volume level.
 - AUDIO OUT is connected to your audio equipment (only models with the AUDIO OUT terminal).

Other

- Remote control does not work.
 - No obstacles between the sensor of the projector and the remote control.
 - Projector is placed near a fluorescent light that can disturb the infrared remote controls.
 - Batteries are new and are not reversed in installation.
- Buttons on the projector cabinet do not work (only models with the [CONTROL PANEL LOCK] function)
 - [CONTROL PANEL LOCK] is not turned on or is disabled in the menu.
 - Still unchanged even though you press and hold the EXIT button over 10 seconds.

8-12. REGISTER YOUR PROJECTOR! (for residents in the United States, Canada, and Mexico)

Please take time to register your new projector. This will activate your limited parts and labor warranty and InstaCare service program.

Visit our web site at <https://www.sharpnecdisplays.us>, click on support center/register product and submit your completed form online.

Upon receipt, we will send a confirmation letter with all the details you will need to take advantage of fast, reliable warranty and service programs from the industry leader, Sharp Sharp NEC Display Solutions of America, Inc.

NEC