



IDEAL FOR
POLE
MOUNTING

BT7012

PURLIN MOUNT FOR Ø50MM POLES

The BT7012 enables the suspension of pole mounted solutions up to 140kg from C-section and Z-section purlins, beams and girders. Compatible with B-Tech's range of BT7850 Ø50mm poles, the locking bolt securely sets the pole vertically at any angle up to 45 degrees.

SPECIFICATION

Max load	140kg
Tilt	up to +45°

FEATURES

- Adjustable purlin mount for use with Ø50mm poles
- Locking bolt included to securely set the pole vertically at any angle up to 45°
- Fits C-section and Z-section purlins with a minimum height of 95mm
- Integrated cable management
- Can also be mounted to beams and girders



Fits C-section and Z-section purlins with a minimum height of 95mm



Locking bolt included to securely set the pole vertically at any angle up to 45°



Integrated cable management



Can also be mounted to beams and girders

TOP VIEW

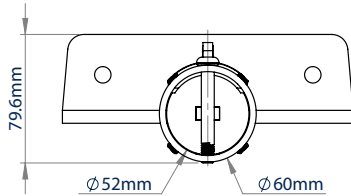
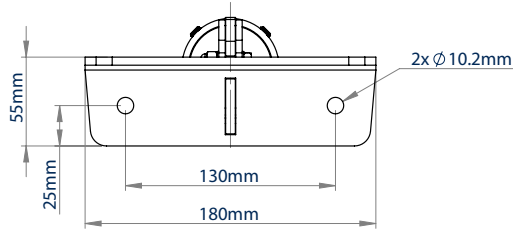

BOTTOM VIEW

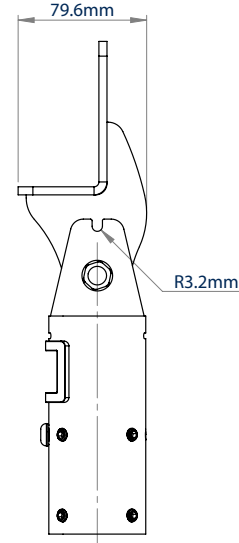

SIDE VIEW

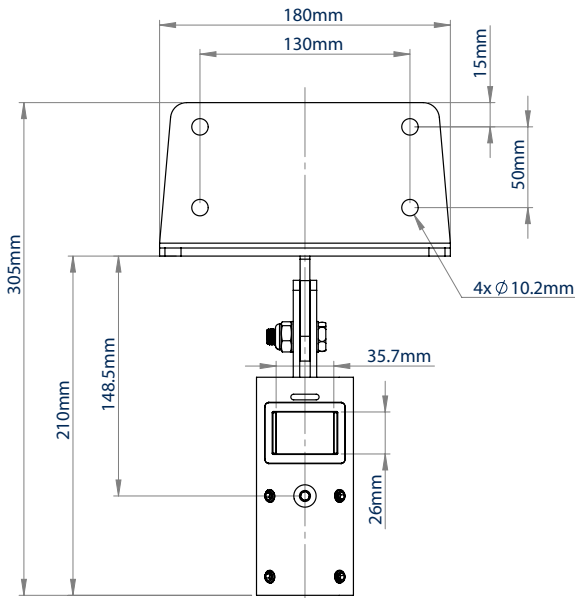

REAR VIEW

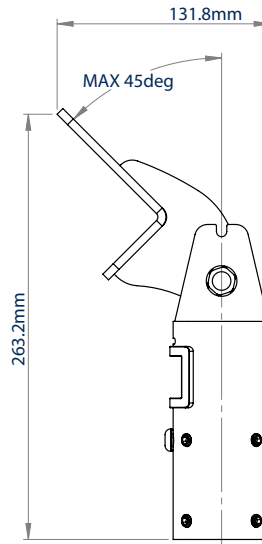

SIDE VIEW

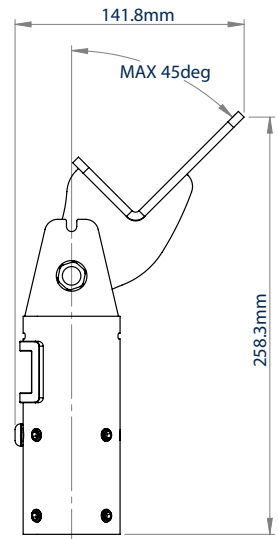

PACKING INFORMATION

COLOUR:	ORDER REF:	EAN CODE:	MASTER CARTON QTY:	PRODUCT QTY:	MASTER CARTON WEIGHT:	MASTER CARTON CUBE:
Black	BT7012/B	5019318076589	1	4	12kg	0.22cbm

ACCESSORIES & RELATED PRODUCTS



I-Beam / girder mount for Ø50mm pole



Truss Mount for use with Ø50mm pole



Ceiling / wall mount with tilt designed to mount a Ø50mm pole to a flat or angled ceiling

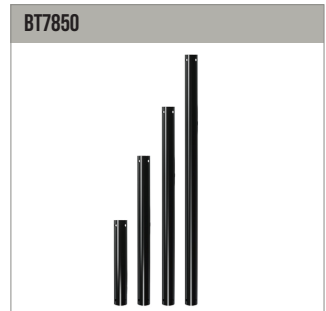

Ø50mm Poles designed to combine with many B-Tech ranges

© 2015 B-Tech Professional Limited. All rights reserved. The information in this document is subject to change without notice. B-Tech Professional Limited and its subsidiaries are not responsible for any damage or loss of data caused by improper use of the information in this document. Any reproduction or transmission of any part of this specification is strictly prohibited unless prior written permission has been granted by B-Tech Professional Limited.

SS-BT7012-V1.1-140422