



THE DISPLAY CHOICE
OF PROFESSIONALS™

www.agneovo.com

TX-22 White LCD Monitor
User Manual

The information contained in this document is subject to change without notice.

This document contains proprietary information that is protected by copyright. All rights are reserved. No part of this document may be reproduced, translated to another language or stored in a retrieval system, or transmitted by any means, electronic, mechanical, photocopying, recording, or otherwise, without prior written permission. Windows is a registered trademark of Microsoft, Inc. Other brand or product names are trademarks of their respective holders.

The test results show that this device meets the FCC rules. Those limits are set to protect residential areas from the devices with harmful emission. This device will produce, use and radiate radio frequency energy. In addition, failure to follow the user's manual to install or use this device might produce harmful interference with radio communication. Notwithstanding the foregoing, it does not guarantee that this type of harmful interference does not occur in some special installations. The interference caused by this device to the reception of radio or television signals may be verified by turning it on and off. Any changes or modifications to this TFT LCD would void the user's authority to operate this device.

TABLE OF CONTENTS

CLASSIFICATION	1
INTENDED USE	2
FOLLOW THE NATIONAL REQUIREMENT TO DISPOSE UNIT	3
ELECTROMAGNETIC COMPATIBILITY	4
USAGE NOTICE	8
Chapter 1: Product Description	
1.1 Package Overview	10
Chapter 2: Installation	
2.1 Product Overview	11
2.1.1 Front View	11
2.1.2 Bottom View (Without Stand)	11
2.2 VESA Mount for Your Monitor.....	12
2.3 Start Your Installation	13
2.4 Connecting the Display	14
2.5 Disconnecting the Device.....	14
Chapter 3: User Controls	
3.1 Side Panel Controls.....	15
3.2 How to Use the OSD Menus	16
3.3 On-Screen Display Menus	17
Chapter 4: Appendix	
4.1 Troubleshooting	18
4.2 Warning Signal	19
4.2.1 No Signal.....	19
4.2.2 Going to Sleep.....	19
4.2.3 Out of Range	19
4.3 Product Dimensions	20
4.4 Compatibility Modes	21
4.5 Touch Screen Driver Installation.....	22
4.5.1 TX-22 White Driver Install Instructions	22
Chapter 5: Specifications	
5.1 Display Specifications	24

CLASSIFICATION

- Power by Class I power supply
(Adapter Technology Co., Ltd./ATM065-P120)
- No Applied Part
- Mode of operation: Continuous Operation
- The equipment not suitable for use in the presence of a flammable anesthetic mixture with air or with oxygen or nitrous oxide: Not AP Category.

INTENDED USE

The intended use of the TX-22 White is to serve as a LCD monitor for integration with the hospital system. It is designed for general purpose for hospital environment. For displaying and viewing of images for reference. The use of this device does not require any direct contact with patients. It shall not be used for diagnostic purpose and cannot be used for a life-support system.

Equipment connected to the analogue or digital interface must comply with the respective IEC standards (e.g. IEC 60950 for data processing equipment and IEC 60601-1 for medical equipment). Furthermore all configurations shall comply with the current version of the standard for SYSTEMS IEC 60601-1-1. Everybody who connects additional equipment to the signal input part configure a medical system, and is therefore responsible that the system complies with current version of the requirements of the system standard IEC 60601-1. If in doubt, consult the technical service department or your local representative.

The instructions for use shall document:

- The use of the ME EQUIPMENT as intended by the MANUFACTURER;
- The frequently used functions;
- Any known contraindication(s) to the use of the ME EQUIPMENT; and those parts of the ME EQUIPMENT that shall not be serviced or maintained while in use with a PATIENT.

FOLLOW THE NATIONAL REQUIREMENT TO DISPOSE UNIT

Manufacturer's Recycling and Energy Information

Disposing of your old product

- Within the European Union













EU-wide legislation, as implemented in each Member State, requires that waste electrical and electronic products carrying the mark (left) must be disposed of separately from normal household waste. This includes monitors and electrical accessories, such as signal cables or power cords. When you need to dispose of your display products, please follow the guidance of your local authority, or ask the shop where you purchased the product, or if applicable, follow any agreements made between yourself.

The mark on electrical and electronic products only applies to the current European Union Member State.

- Outside the European Union

If you wish to dispose of used electrical and electronic products outside the European Union, please contact your local authority so as to comply with the correct disposal method.

ELECTROMAGNETIC COMPATIBILITY

	This symbol alerts the user that important literature concerning the operation and maintenance of this unit has been included. Therefore, it should be read carefully in order to avoid any problems.
	Stand by
	Indicates Direct Current (DC)
	Indicates Alternating Current (AC)
	Indicates this device must not be thrown in the trash but must be recycled, according to the European WEEE (Waste Electrical and Electronic Equipment) directive
	Indicates compliance with the Directive 93/42/EEC as Class I device
	Atmospheric pressure: 500hPa~1,060hPa
	Humidity: 10~90% RH
	Storage temperature: -20 degree to 60 degree
	Recyclable

ELECTROMAGNETIC COMPATIBILITY

Guidance and Manufacturer's Declaration - Electromagnetic Emission

The Model TX-22 White is intended for use in the electromagnetic environment specified below. The user of TX-22 White should assure that it is used in such an environment.		
Emission test	Compliance	Electromagnetic Environment - Guidance
RF emissions CISPR 11	Group 1	The Model TX-22 White uses RF energy only for its internal function. Therefore, its RF emissions are very low and are not likely to cause any interference in nearby electronic equipment TX-22 White is suitable for use in all establishments, including domestic establishments and those directly connected to the public low-voltage power supply network that supplies buildings used for domestic purposes
RF emissions CISPR 11	Class B	
Harmonic emissions IEC61000-3-2	Class D	
Voltage Fluctuations IEC61000-3-3	Complies	

Manufacturer's Declaration - Electromagnetic Immunity

The Model TX-22 White is intended for use in the electromagnetic environment specified below. The user of TX-22 White should assure that it is used in such an environment.			
Immunity Test	IEC 60601 Test Level	Compliance Level	Electromagnetic Environment - Guidance
Electrostatic discharge (ESD) IEC61000-4-2	±6 kV contact ±8 kV air	±6 kV contact ±8 kV air	Floors should be wood, concrete or ceramic tile. If floors are covered with synthetic material, the relative humidity should be at least 30%.
Electrical fast transient /burst IEC61000-4-4	±2 kV for power supply lines ±1 kV for input / output lines	±2 kV for power supply lines ±1 kV for input / output lines	Mains power quality should be that of a typical commercial or hospital environment
Surge IEC61000-4-5	±1 kV differential mode ±2 kV common mode	±1 kV differential mode ±2 kV common mode	Mains power quality should be that of a typical commercial or hospital environment.
Power frequency (50/60Hz) mag-netic field IEC 61000-4-8	3.0 A/m	3.0 A/m	Power frequency magnetic fields should be at levels characteristic of a typical location in a typical commercial or hospital environment.
Voltage dips, short interruptions and voltage variations on power supply input lines IEC61000-4-11	<5% Ut (>95% dip in Ut) for 0.5 cycle 40% Ut (60% dip in Ut) for 5 cycles 70% Ut (30% dip in Ut) for 25 cycles <5% Ut (>95% dip in Ut) for 5 sec.	<5% Ut (>95% dip in Ut) for 0.5 cycle 40% Ut (60% dip in Ut) for 5 cycles 70% Ut (30% dip in Ut) for 25 cycles <5% Ut (>95% dip in Ut) for 5 sec.	Mains power quality should be that of a typical commercial or hospital environment. If the user of the TX-22 White image intensifier requires continued operation during power mains interruptions, it is commended that the TX-22 White image intensifier be powered from an uninterruptible power supply or a battery.
Note: Ut is the A.C. mains voltage prior to application of the test level.			

ELECTROMAGNETIC COMPATIBILITY

Manufacturer's Declaration - Electromagnetic Immunit

The Model TX-22 White is intended for use in the electromagnetic environment specified below.
The customer or the user of TX-22 White should ensure that it is used in such an environment.

Immunity Test	IEC 60601 Test Level	Compliance Level	Electromagnetic Environment - Guidance
Conducted RF IEC61000-4-6	3 Vrms 150 KHz to 80 MHz	3 Vrms 150 KHz to 80 MHz	Portable and mobile RF communications equipment should be used no closer to any part of the TX-22 White, including cables, than the recommended separation distance calculated from the equation applicable to the frequency of the transmitter. Recommended Separation Distance 0.15 MHz to 80 MHz $d = \left[\frac{3.5}{V_1} \right] \sqrt{P}$ 80 MHz to 800 MHz $d = \left[\frac{3.5}{E_1} \right] \sqrt{P}$ 800 MHz to 2.5 GHz $d = \left[\frac{7}{E_1} \right] \sqrt{P}$ where P is the maximum output power rating of the transmitter in watts (W) according to the transmitter manufacturer and is the recommended separation distance in meters (m). Field strengths from fixed RF transmitters, as determined by an electromagnetic site survey (a), should be less than the compliance level in each frequency range (b). Interference may occur in the vicinity of equipment marked with the following symbol: 
Radiated RF IEC 61000-4-3	3 Vrms 800 MHz to 2.5 GHz	3 Vrms 800 MHz to 2.5 GHz	

NOTE 1: At 80MHz and 800MHz, the higher frequency range applies.

NOTE 2: These guidelines may not apply in all situations. Electromagnetic propagation is affected by absorption and reflection from structures, objects, and people.

(a) Field strengths from fixed transmitters, such as base stations for radio (cellular/cordless) telephones and land mobile radios, amateur radio, AM and FM radio broadcast and TV broadcast, cannot be predicted theoretically with accuracy. To assess the electromagnetic environment due to fixed RF transmitters, an electromagnetic site survey should be considered. If the measured field strength in the location in which the TX-22 White is used exceeds the applicable RF compliance level above, the TX-22 White should be observed to verify normal operation. If abnormal performance is observed, additional measures may be necessary, such as reorienting or relocating the TX-22 White.

(b) Over the frequency range 150kHz to 80MHz, field strengths should be less than $[V_1]$ V/m.

ELECTROMAGNETIC COMPATIBILITY

Recommended Separation Distances Between Portable and Mobile RF Communications Equipment and the TX-22 White			
The TX-22 White is intended for use in an electromagnetic environment in which radiated RF disturbances are controlled. The user of the TX-22 White can help prevent electromagnetic interference by maintaining a minimum distance between portable and mobile RF communications equipment (transmitters) and the TX-22 White as recommended below, according to the maximum output power of the communications equipment.			
Rated maximum output power (W) of transmitter	Separation distance (m) according to frequency of transmitter		
	150kHz to 80MHz $d=1.17, \sqrt{P}$	80MHz to 800MHz $d=1.17, \sqrt{P}$	800MHz to 2.5GHz $d=2.33, \sqrt{P}$
0.01	0.12	0.12	0.23
0.1	0.38	0.38	0.73
1	1.2	1.2	2.3
10	3.8	3.8	7.3
100	12	12	23

For transmitters rated at a maximum output power not listed above, the recommended separation distance (d) in meters (m) can be estimated using the equation applicable to the frequency of the transmitter, where P is the maximum output power rating of the transmitter in watts (W) according to the transmitter manufacturer.

NOTE 1: At 80 MHz and 800 MHz, the separation distance for the higher frequency range applies.

NOTE 2: These guidelines may not apply in all situations. Electromagnetic propagation is affected by absorption and reflection from structures, objects, and people.

USAGE NOTICE

Caution - To prevent the risk of fire or shock hazards, do not expose this product to rain or moisture.

Warning - Please do not open or disassemble the product as this may cause electric shock.

Precautions

Follow all warnings, precautions and maintenance as recommended in this user's manual to maximize the life of your unit.

Do:

- Turn off the product before cleaning.
- Touch screen surface may be cleaned using a soft clean cloth moistened with water.
- Use only high quality and safety approved AC/DC adapter.
- Disconnect the power plug from AC outlet if the product is not going to be used for an extended period of time.

Don't:

- Do not touch the LCD display screen surface with sharp or hard objects.
- Do not use abrasive cleaners, waxes or solvents for your cleaning.
- Do not operate the product under the following conditions:
 - Extremely hot, cold or humid environment.
 - Areas susceptible to excessive dust and dirt.
 - Near any appliance generating a strong magnetic field.
 - In direct sunlight.

Turning off TX-22 White properly is important for system reliability. There are one way to turn off the system. Push the power button and then the system will shut down automatically.

USAGE NOTICE

- Please do not touch patient and this medical device at the same time.
- Users must not allow SIP/SOPs and the patient to come into contact at the same time.

CAUTION – Use suitable mounting apparatus to avoid risk of injury.

Grounding reliability can only be achieved when the equipment is connected to an equivalent receptacle marked “Hospital Only” or “Hospital Grade”.

Use a power cord that matches the voltage of the power outlet, which has been approved and complies with the safety standard of your particular country.

Warning - Do not modify this equipment without authorization of the manufacturer.

Warning – To avoid risk of electric shock, this equipment must only be connected to a supply mains with protective earth.

Caution: This adapter (Adapter Technology Co., Ltd./ATM065-P120) is a forming part of the medical device.

CHAPTER 1: PRODUCT DESCRIPTION

1.1 Package Overview

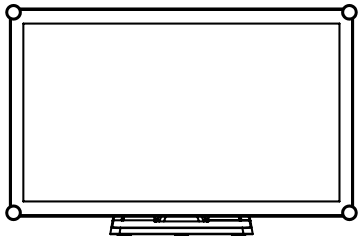

LCD Display

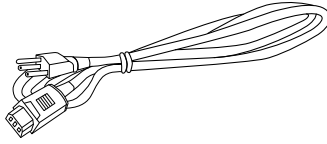

Power Cord

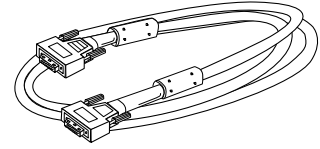

VGA Signal Cable

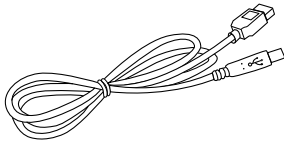

USB Cable (A to B)

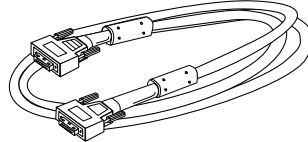

DVI-D Cable

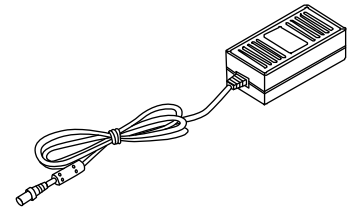

DC Power Supply



Cable Cover Screw
(M3x6mm)

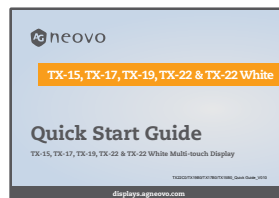

Quick Start Guide

CHAPTER 2: INSTALLATION

2.1 Product Overview

2.1.1 Front View

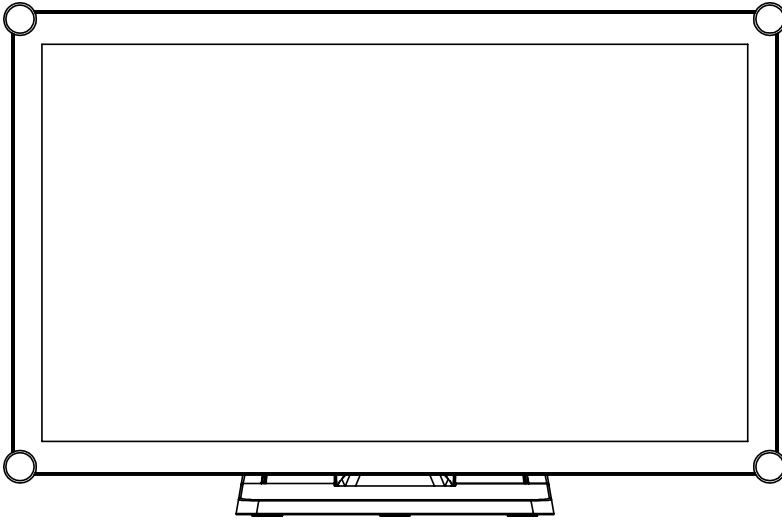

2.1.2 Bottom View (Without Stand)

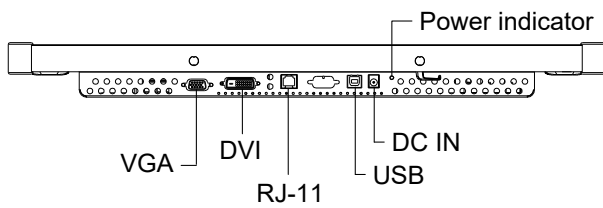

Power indicator — Indicate the operating status of the LCD display:

- Lights Green when the LCD display is turned on.
- Lights orange when the LCD display is in standby mode.
- Lights off when the LCD display is turned off.

INSTALLATION

2.2 VESA Mount for Your Monitor

This monitor conforms to the VESA Flat Panel Mounting Physical Mounting Interface standard which defines a physical mounting interface for flat panel monitors, and corresponding with the standards of flat panel monitor mounting devices, such as wall and table arms. The VESA mounting interface is located on the back of your monitor.

To mount the monitor on a UL certified swing arm or other mounting fixture, follow the instructions included with the mounting fixture to be used.

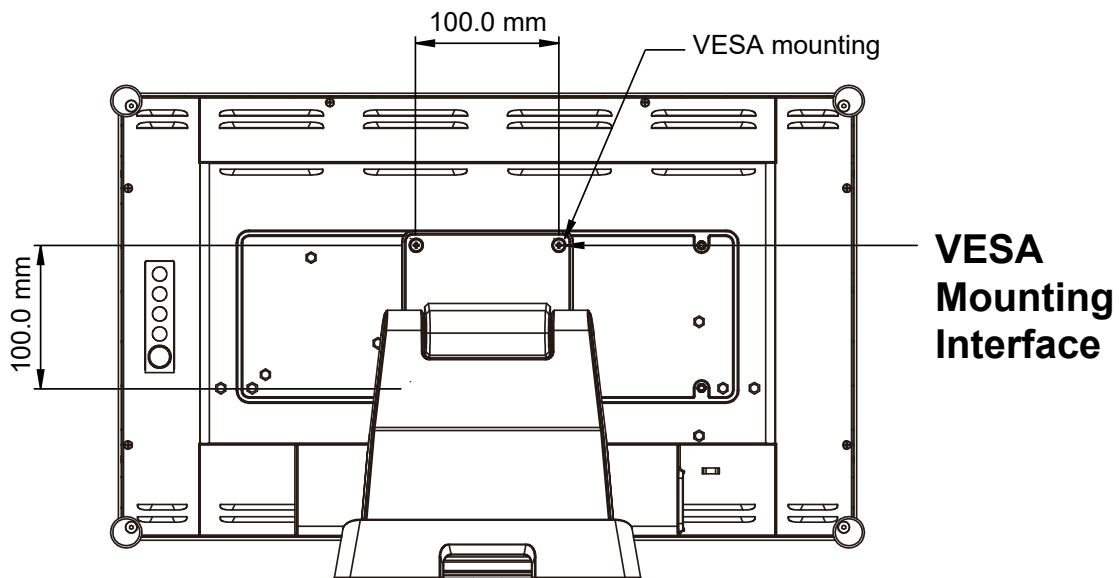

⚠ Warning!

Please select the proper screws!

The distance between the back cover surface and the bottom of the screw hole is 8 mm. Please use four M4 screws diameter with proper length to mount your monitor.

Please note: the mounting stand must be able to support at least 17.6 lbs (8Kg).

INSTALLATION

2.3 Start Your Installation

Please follow these instructions so that you can hook up the cables to associated connectors.

1. Lay the LCD flat on an even surface.
2. Move the stand into position as seen in the step 1 diagram.
3. Remove the cable cover as seen in the step 2 diagram.
4. Connect the cables to the appropriate connectors as seen in the step 3 diagram.
5. Re-attach the cable cover. Take the screw (M3x6mm) out of the accessory box, and insert the screw into the cable cover and monitor as seen in the step 4 diagram.

* Screw the cable cover to the monitor in normal use.

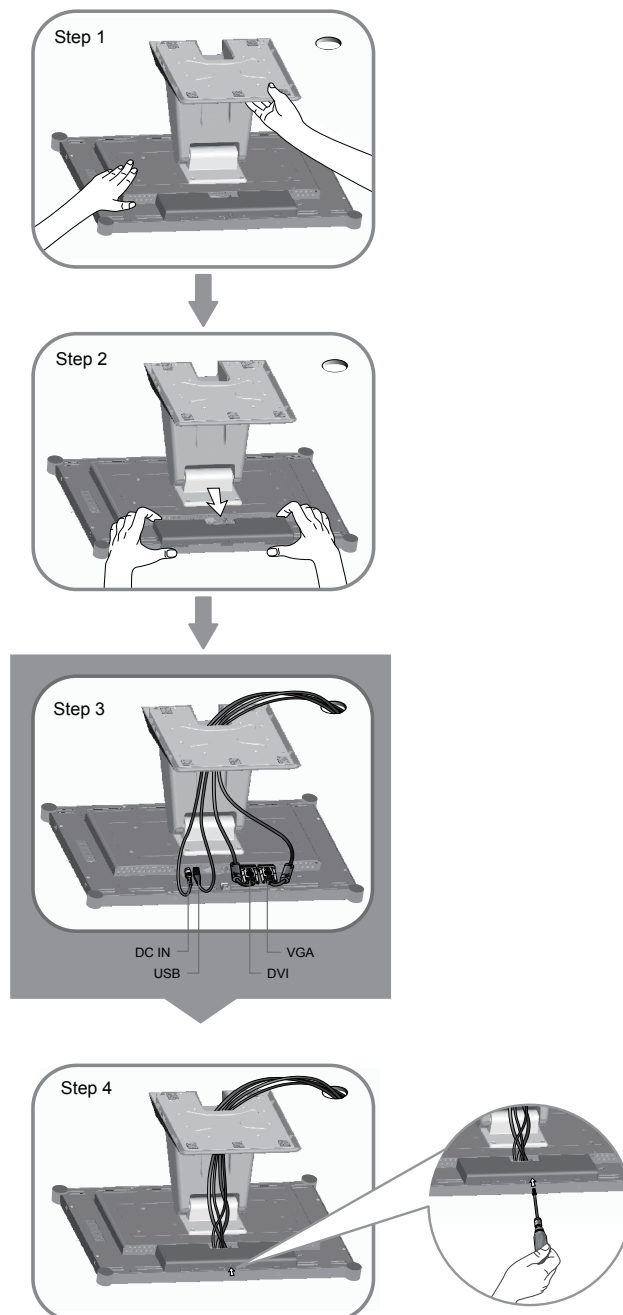

INSTALLATION

2.4 Connecting the Display

To setup this display, please refer to the following figure and procedures.

1. Be sure all equipment is turned off.
2. Connect the DC plug to the power connector on the monitor and the other end into an electrical outlet.
3. Connect the D-SUB or DVI cable from the display's D-SUB or DVI input connector to the D-SUB or DVI connector of your host computer and tighten the screws.
4. Connect the USB cable from the USB port of your display to the USB port of your computer.
5. Configure the touch screen. Refer to the "4.5 Touch Screen Driver Installation" section on page 19.
6. Once the touch screen is configured, the monitor is ready for use.
7. The function of RJ-11 port is used only for Remote Key pad(Sold Separately).
Don't connect telephone or internet cable to RJ-Type port.

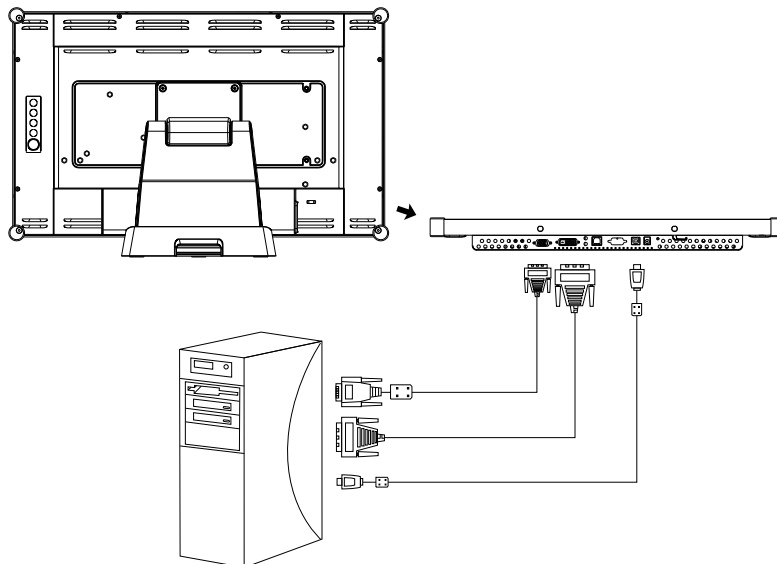

2.5 Disconnect Device

Caution:

To prevent the risk of electric shock, make sure power cord is unplugged from wall socket. To fully disengage the power to the unit, please disconnect the power cord from the AC outlet. Do not remove cover (or back). No user serviceable parts inside. Refer servicing to qualified service personnel. The AC outlet shall be readily available and accessible.

⚠ Notice!

To ensure the LCD display works well with your computer, please configure the display mode of your graphics card to make it less than or equal to 1920 x 1080 resolution and make sure the timing of the display mode is compatible with the LCD display.

We have listed the compatible "Video Modes" of your LCD display in the appendix (on page 18) for your reference.

External power supplies applicable:

Adapter Technology Co., Ltd./100-240V, 50 - 60Hz, 1.6-0.7A/ATM065-P120.

CHAPTER 3: USER CONTROLS



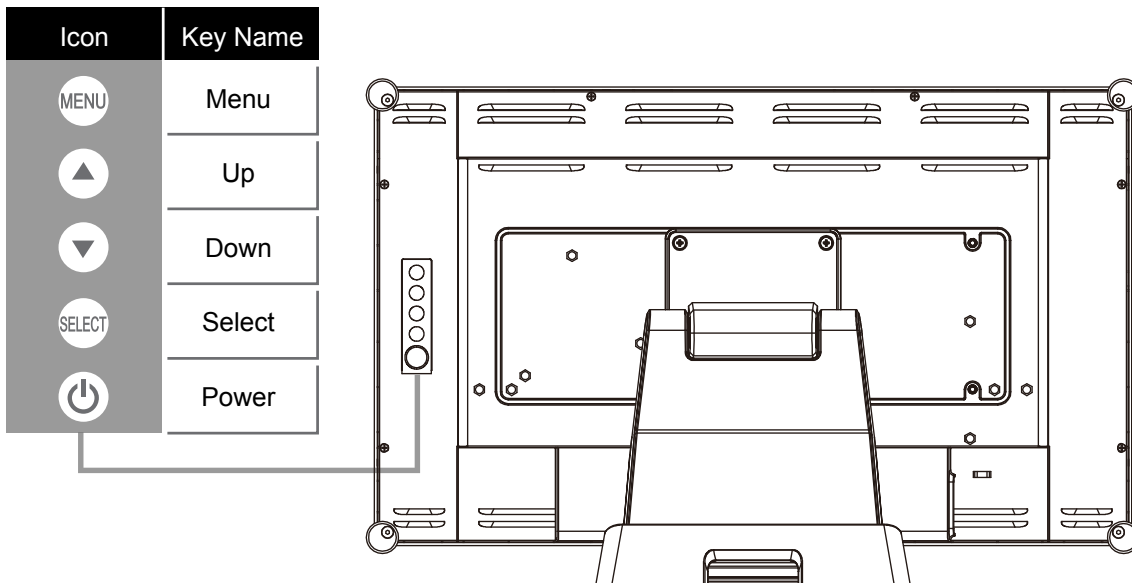

3.1 Side Panel Controls



OSD Key	Menu off status	Menu on status
MENU	Menu appear	Menu disappear / return to main item
▲	Brightness	Main item select up / Adjust up
▼	Contrast	Main item select down / Adjust down
SELECT	Select sub-item function	
⏻	Power On / Off	

USER CONTROLS

3.2 How to Use the OSD Menu

Icon	Key Name
	Menu
	Up
	Down
	Select
	Power

1. Press the “Menu” button to pop up the “on-screen menu” and press “Up” or “Down” button to select among the five functions in the main menu.
2. Choose the adjustment items by pressing the “Select” button.
3. Adjust the value of the adjustment items by pressing the “Up” or “Down” button.
4. With the OSD menu on the screen, press the “Menu” button to return to the main menu or to exit OSD.
5. The OSD menu will automatically close, if you have left it idle for a pre-set time.
6. To Lock the OSD / Power menu buttons, please follow the instructions below.
(Please note: the monitor has to be turned ON with a valid signal pre-set)
 - (a.) Press the “Menu” key; the OSD menu will open.
 - (b.) Press and hold the “Menu” key again with the OSD menu on the screen; the OSD menu will disappear. Then press the “Power” key 1 time while the menu key is still being pressed. The “Lock/Unlock” menu will appear for 3 seconds.
 - (c.) Use the “Select” key to select OSD or Power setting then set at “Lock” by pushing the “UP” or “Down” button.
 - (d.) When the “UP” or “Down” button is released, the previous setting will be saved and exit the “Lock/Unlock” menu automatically.
7. To Unlock the OSD / Power menu buttons, please follow the instructions below.
(Please note: the monitor has to be turned ON with a valid signal pre-set)
 - (a.) Press and hold the “Menu” key then press the “Power” key simultaneously; the “Lock/Unlock” menu will appear for 3 seconds.
 - (b.) Use the “Select” key to select OSD or Power setting then set at “Unlock” by pushing the “UP” or “Down” button.
 - (c.) When the “Up” or “Down” button is released, the previous setting will be saved, and the “Lock/Unlock” menu will close automatically.

Please note:

- a. When the OSD Lock function is selected, this indicates that all the buttons except the “power” button are now disabled.
- b. When the Power Lock function is selected, the “Power” key is disabled. The user cannot turn off the monitor with the “Power” key.

USER CONTROLS

3.3 On-Screen Display Menus

Main OSD Menu:

ITEM	CONTENT
Contrast	The monitor luminance level control.
Brightness	The monitor backlight level control.
Auto Adjust	Fine-tune the image to full screen automatically.
Left/Right	Moving screen image horizontal position to left or right.
Up/Down	Moving screen image vertical position to up or down.
Horizontal size	The screen image horizontal dot clock adjustment.
Fine	The screen image pixel phase adjustment.
OSD Left/Right	Moving OSD menu horizontal position to left or right.
OSD Up/Down	Moving OSD menu vertical position to up or down.
OSD Time out	OSD auto-disappear time selection.
OSD Language	OSD menu language selection. (English, French, Japanese, Deutsch, Spanish, Italian, Traditional Chinese and Simplified Chinese)
Factory Reset	Factory default value restored.
RGB	Color temperature selection. (9300K, 6500K, 5500K, 7500K, User)

Indicator lights and push-buttons

Color	Meaning
Green	Ready for use
Orange	Stand by

CHAPTER 4: APPENDIX

4.1 Troubleshooting

If you are experiencing trouble with the LCD display, refer to the following. If the problem persists, please contact your local dealer or our service center.

Problem: No image appears on screen.

- ▶ Check that all the I/O and power connectors are correctly and well connected as described in the “Installation” section.
- ▶ Make sure the pins of the connectors are not crooked or broken.

Problem: Partial Image or incorrectly displayed image.

- ▶ Check to see if the resolution of your computer is higher than that of the LCD display.
- ▶ Reconfigure the resolution of your computer to make it less than or equal to 1920 x 1080.

Problem: Image has vertical flickering line bars.

- ▶ Use “Horizontal size” to make an adjustment.
- ▶ Check and reconfigure the display mode of the vertical refresh rate of your graphic card to make it compatible with the LCD display.

Problem: Image is unstable and flickering

- ▶ Use “Fine” to make an adjustment.

Problem: Image is scrolling

- ▶ Check and make sure the VGA signal cable (or adapter) is securely connected.
- ▶ Check and reconfigure the display mode of the vertical refresh rate of your graphics card to make it compatible with the LCD display.

Problem: Vague image (characters and graphics)

- ▶ Use “Horizontal size” to make an adjustment. If this problem still exists, use “Fine” to make an adjustment.

APPENDIX

4.2 Warning Signal

If you see warning messages on your LCD screen, this means that the LCD display cannot receive a clean signal from the computer graphics card.

Below are the three kinds of Warning Signal. Please check the cable connections or contact your local dealer or our service center for more information.

4.2.1 No Signal

This message means that the LCD display has been powered on but it cannot receive any signal from the computer graphics card. Check all the power switches, power cables, and VGA/DVI signal cable.

4.2.2 Going to Sleep

The LCD display is under the power saving mode. In addition, the LCD display will enter power saving mode when experiencing a sudden signal disconnecting problem.

The monitor can be activated by pressing any keyboard, triggering the mouse or touching the screen.

4.2.3 Out of Range

This message means that the signal of the computer graphic card is not compatible with the LCD display. When the signal is not included in the "Video Modes" list we have listed in the Appendices of this manual, the LCD monitor will display this message.

APPENDIX

4.3 Product Dimensions

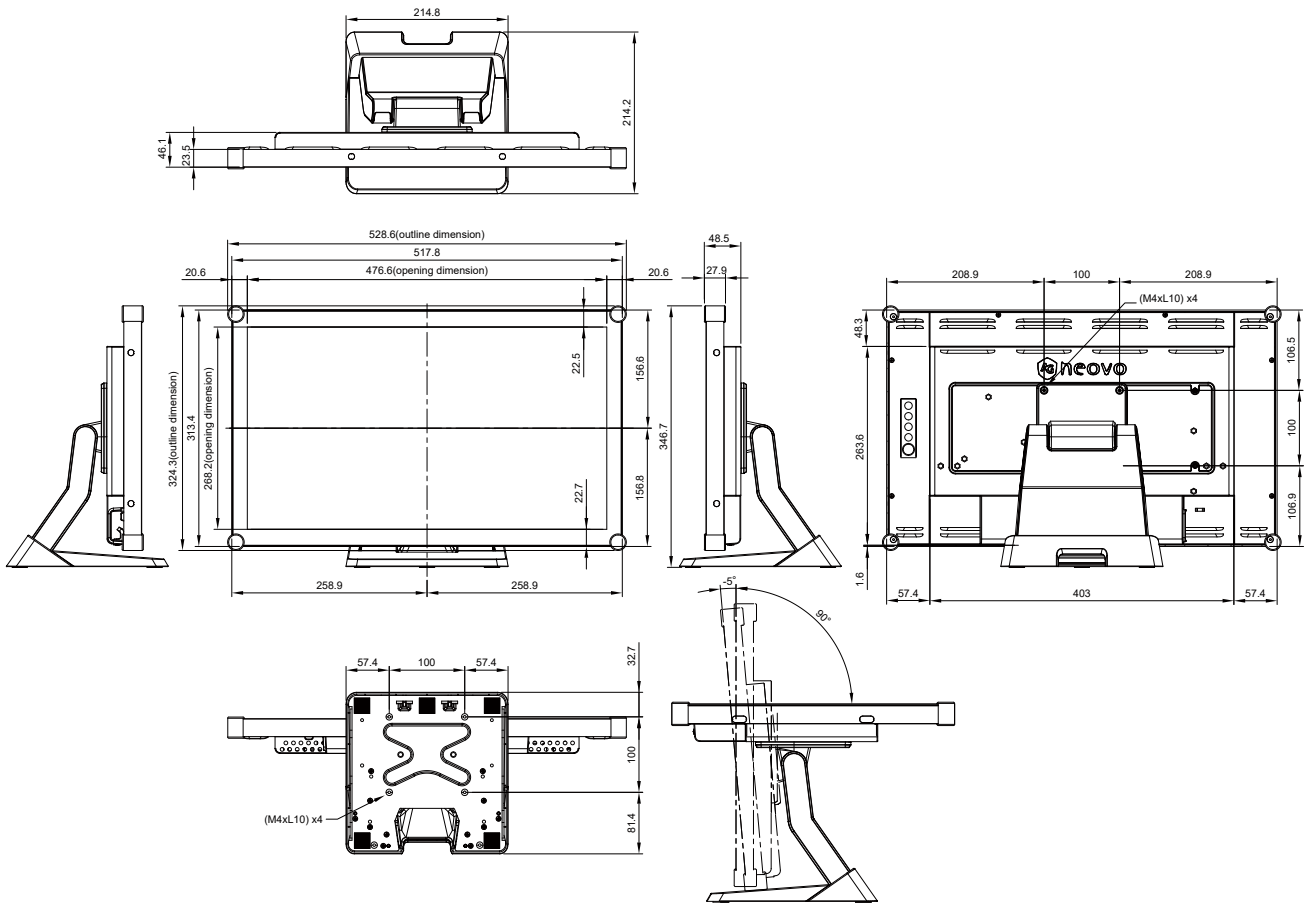

APPENDIX

4.4 Compatibility Modes

Mode	Resolution	H-Frequency(khz)	V-Frequency(hz)
IBM VGA	720X400	31.47	70
IBM VGA	640X480	31.47	60
Apple MacII	640X480	35.00	66
VESA VGA	640X480	37.86	72
VESA VGA	640X480	37.50	75
VESA SVGA	800X600	35.16	56
VESA SVGA	800X600	37.88	60
VESA SVGA	800X600	48.08	72
VESA SVGA	800X600	46.88	75
Apple Mac	832X624	49.72	75
VESA XGA	1024X768	48.36	60
VESA XGA	1024X768	56.48	70
VESA XGA	1024X768	60.02	75
VESA SXGA	1280X1024	64.00	60
VESA SXGA	1280X1024	80.00	75
VESA SXGA	1152X864	67.50	75
VESA SXGA	1280X960	60.00	60
WXGA+	1440X900	56.00	60
WXGA+	1440X900	70.60	75
WSXGA+	1680X1050	65.20	60
WSXGA+	1680X1050 (VGA only)	82.30	75
VESA WXGA	1280X768	47.776	60
WSXGA+	1920X1080	67.50	60

4.5 Touch Screen Driver Installation

The TX-22 White is available with USB connections. The touch driver can be downloaded in the “www.agneovo.com” website for these operating systems: VISTA, XP, 2000, CE, XP Embedded, Linux, Apple® Mac OS.

Please Note:

1. The TX-22 White is Microsoft® Windows® HID (Human Interface Device) compatible if you use the USB touch screen interface. No additional software driver is required for general operation of the touch screen.
2. For TX-22 White, the system requires 15 seconds for Windows 7/8/10 to install/uninstall the touch drivers while turning power on/off or plugging/unplugging USB cable.

4.5.1 TX-22 White Driver Install Instructions

If you are using a PC running VISTA, XP, 2000, follow the instructions below:

1. Power on the computer.
2. Be sure the USB cable is connected from the PC to the LCD display.
3. Open the corresponding driver folder file.
4. Follow the step-by-step instructions as shown on the pop-up windows.

If you are using a PC running Windows® XP Embedded, follow the instructions below:

Express:

1. Power on the computer.
2. Make sure that the USB cable is connected to the computer.
3. Be sure that your EWF is disabled. If your EWF is enabled, please disable the EWF by using the EWF Manager command.
4. Once the EWF is disabled click on the XP driver and follow the step-by-step instructions as shown on the pop-up windows.

Custom:

1. Power on the computer.
2. Make sure that the USB cable is connected to the computer.
3. Follow the step-by-step instructions found in the driver folder file.

APPENDIX

If you are using a PC running Windows® CE, follow the instructions below:

1. Power on the computer.
2. Make sure that the USB cable is connected to the computer.
3. Using Platform Builder, build an image file by following the step-by-step instructions found in the driver folder file.

If you are using a PC running Linux or Apple® Mac OS, follow the instructions below:

1. Power on the computer.
2. Make sure that the USB cable is connected to the computer.
3. Follow the step-by-step instructions found in the driver folder file.

CHAPTER 5: SPECIFICATIONS

5.1 Display Specifications

TX-22 White		
Panel	Panel Type	LED-Backlit TFT LCD (IPS Technology)
	Panel Size	21.5"
	Max. Resolution	FHD 1920 x 1080
	Pixel Pitch	0.248 mm
	Brightness	250 cd/m ²
	Contrast Ratio	1000:1
	Viewing Angle (H/V)	178°/178°
	Display Colour	16.7M
	Response Time	5 ms
	Surface Treatment	Anti-Glare Treatment (Haze 25%), 3H Hard Coating
Frequency (H/V)	H Freq.	31 kHz-82 kHz
	V Freq.	50 Hz-75 Hz
Input	DVI	24-Pin DVI-D x 1
	VGA	15-Pin D-Sub x 1
External Control	RJ11	Yes
Touch Screen	Technology	Projective Capacitive
	Positional Accuracy	± 2.5 mm
	Panel Interface	USB (Type-B)
	Multi-touch Plug & Play	Windows® 7/8/10
	Single Touch Support by Driver	Windows® VISTA/XP/2000/CE/XP Embedded Apple® Mac OS
Multi-touch Support by Driver	Linux (Up to 5 points) Android 2.1 upward and 4.0 as well (Up to 10 points)	
Power	Power Supply	External
	Power Requirements	DC 12V, 4A
	On Mode	19W (On)
	Stand-by Mode	< 2W
	Off Mode	< 1W
Glass	Thickness	3.1 mm (0.12")
	Transmission Rate	> 90%
	Hardness	> 7H
Operating Conditions	Temperature	0°C-40°C (32°F-104°F)
	Humidity	20%-80% (non-condensing)
Storage Conditions	Temperature	-20°C-60°C (-4°F-140°F)
	Humidity	10%-90% (non-condensing)
Mounting	VESA FPMPI	Yes (100 x 100 mm)
Stand	Tilt	-5° to 90°
Security	Kensington Security Slot	Yes

SPECIFICATIONS

TX-22 White		
Dimensions	Product with Base (W x H x D)	528.6 x 346.7 x 214.2 mm (20.8" x 13.7" x 8.4")
	Packaging (W x H x D)	610.0 x 460.0 x 320.0 mm (24.0" x 18.1" x 12.6")
Weight	Product with Base	6.7 kg (14.8 lb)
	Packaging	9.8 kg (21.6 lb)

Note:

- ◆ All specifications are subject to change without prior notice.

AG Neovo

Company Address: 5F-1, No. 3-1, Park Street, Nangang District, Taipei, 11503, Taiwan.

Copyright © 2020 AG Neovo. All rights reserved.

TX22C0_UM_V012