

Power Cord

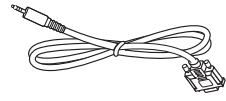

RS232 Cable

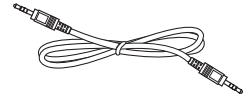

RS232 Daisy Chain Cable



IR Sensor Cable



Philips logo plate

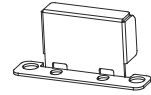

AC Switch Cover x 1



USB Cover x 1

\* Differences according to regions.

Display design and accessories may differ from those illustrated above.

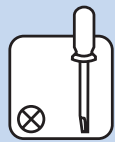

1

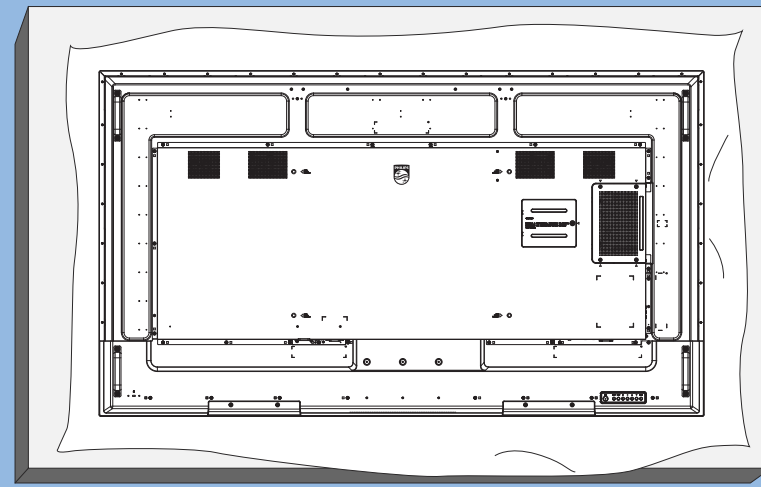

2

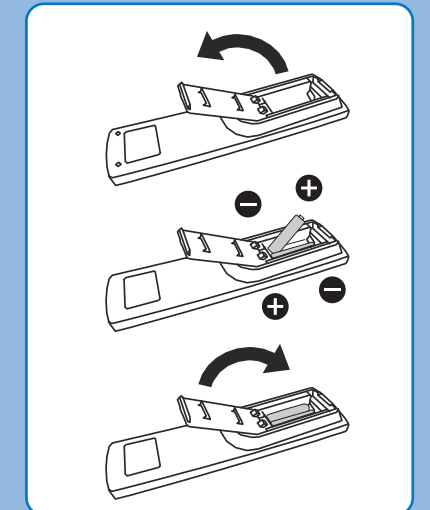
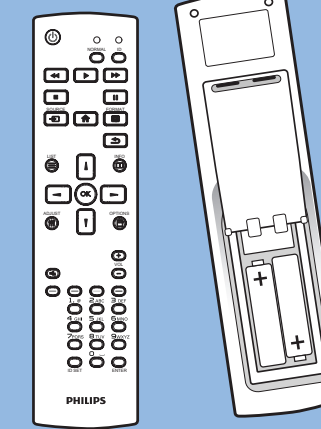
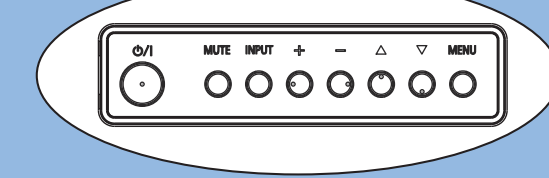
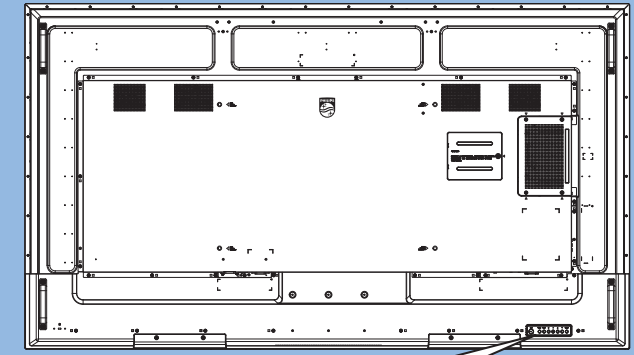

3

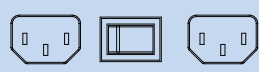
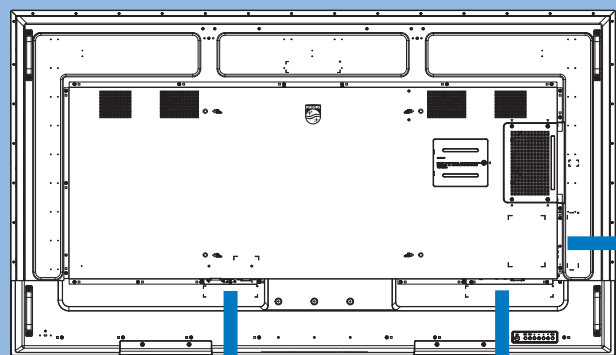

100-240V ~  
50/60Hz 2.5A

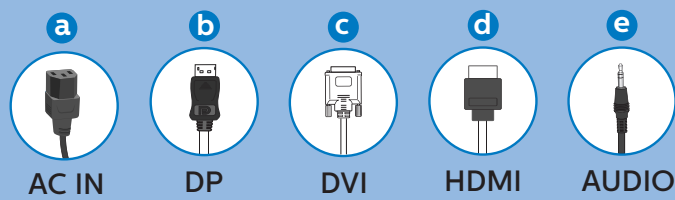
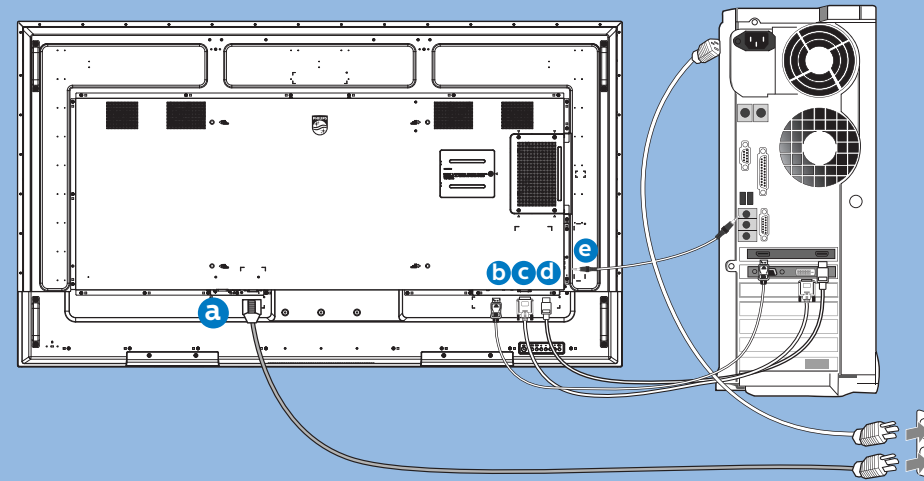

4

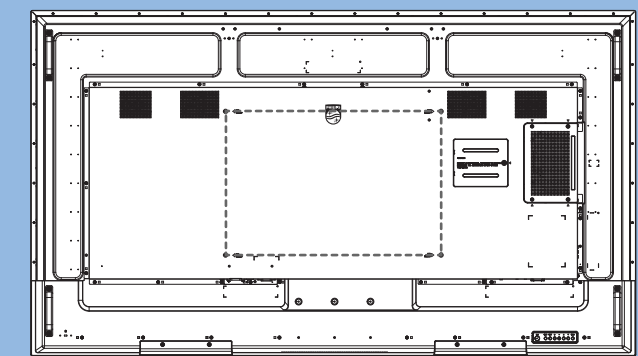

M8 \* (15+X) mm  
(X=Thickness of Wall mount BKT)

75BDL4550D: 600mmx400mm  
86BDL4550D: 600mmx400mm

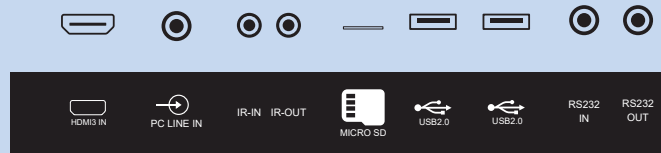
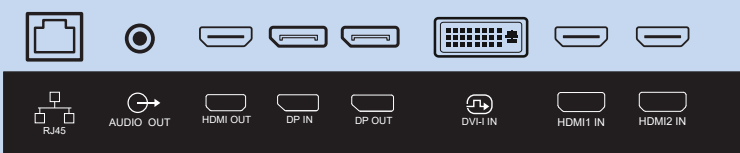

5

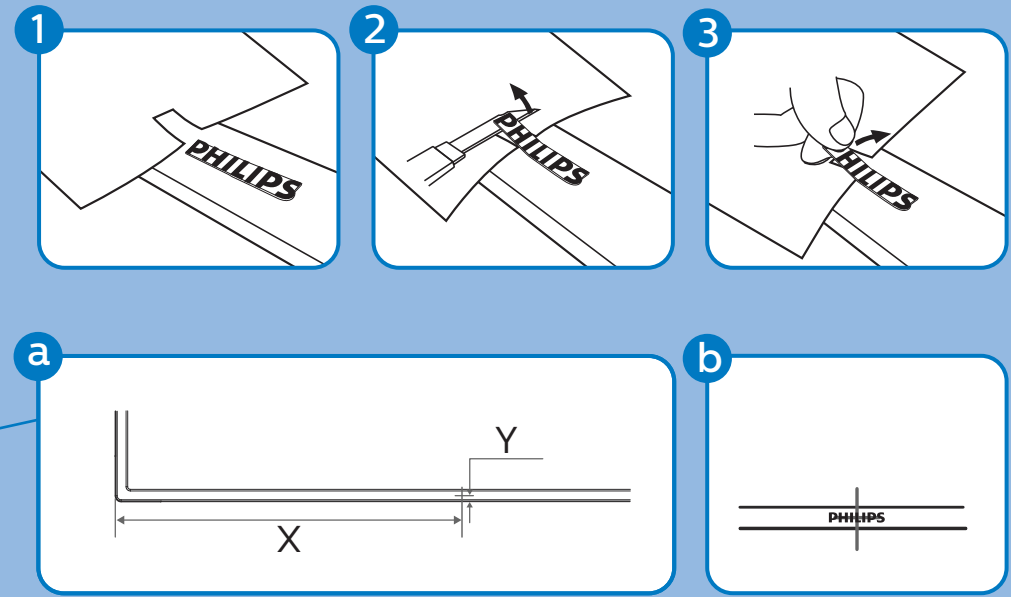
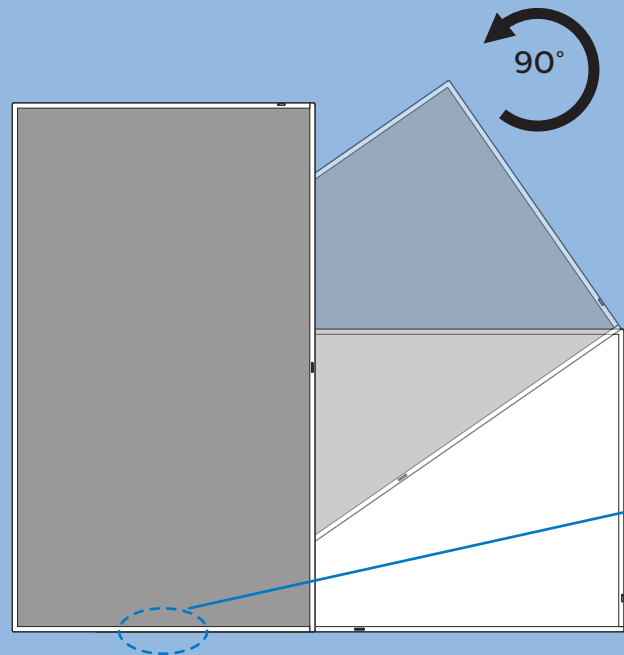

75BDL4550D: X=480.9 mm Y=7.9 mm  
 86BDL4550D: X=550.0 mm Y=8.2 mm

**PHILIPS**  
 Professional  
 Display Solutions  
 D Line  
 75BDL4550D  
 86BDL4550D

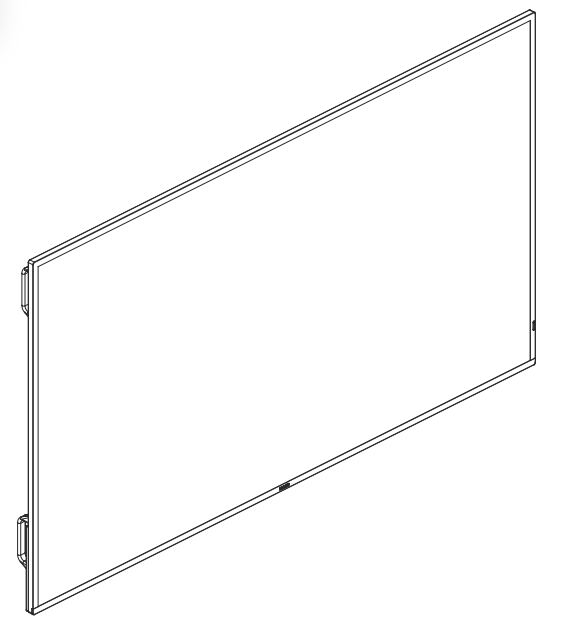

# Quick Start



Please check out the website below for more product information.  
[www.philips.com/signagesolutions-support](http://www.philips.com/signagesolutions-support)



Envision Peripherals Inc.  
 490 N McCarthy Blvd, Suite #120  
 Milpitas, CA 95035  
 USA

2021 © TOP Victory Investments Ltd. All rights reserved.  
 This product has been manufactured by and is sold under the responsibility of Top Victory Investments Ltd., and Top Victory Investments Ltd. is the warrantor in relation to this product. Philips and the Philips Shield Emblem are registered trademarks of Koninklijke Philips N.V. and are used under license.

Specifications are subject to change without notice.

Version: V1.03 2021-01-07



Q41G75M181316C