

**PHILIPS**

Professional  
Display Solutions

T Line

43BDL3452T  
55BDL3452T



# User Manual (English)

[www.philips.com/welcome](http://www.philips.com/welcome)

# Table Of Contents

1.	Safety Instructions .....	1	5.5.	CMND & Play.....	33
2.	Unpacking .....	11	5.6.	Side Bar.....	34
2.1.	Package Contents.....	13	6.	Setting UI.....	35
2.2.	Installation Notes.....	13	6.1.	Settings.....	35
2.3.	Mounting on a Wall .....	14	6.1.1.	Network & Internet .....	35
2.3.1.	VESA Grid .....	14	6.1.2.	Signage Display.....	37
3.	Parts and Functions .....	15	6.1.3.	Apps .....	45
3.1.	Control Panel.....	15	6.1.4.	Display .....	46
3.2.	Input/Output Terminals.....	16	6.1.5.	Security .....	46
3.3.	Inserting the batteries in the remote control .....	17	6.1.6.	System.....	46
3.4.	Handling the remote control.....	17	7.	OSD Menu .....	48
3.5.	Operating range of the remote control ....	17	7.1.	Navigating the OSD Menu .....	48
3.6.	Remote Control.....	18	7.1.1.	Navigating the OSD menu using the remote control .....	48
3.6.1.	General functions.....	18	7.1.2.	Navigating the OSD menu using the display's control buttons.....	48
3.6.2.	ID Remote Control .....	19	7.2.	OSD Menu Overview .....	48
3.6.3.	Remote Control buttons on Android source.....	20	7.2.1.	Picture menu .....	48
3.7.	USB Cover .....	22	7.2.2.	Screen menu .....	49
3.8.	AC Switch Cover.....	23	7.2.3.	Audio menu .....	50
4.	Connecting External Equipment .....	24	7.2.4.	Configuration 1 menu .....	50
4.1.	Connecting External Equipment (Multimedia Player).....	24	7.2.5.	Configuration 2 menu .....	51
4.1.1.	Using HDMI video input.....	24	7.2.6.	Advanced Option menu.....	51
4.2.	Connecting a PC.....	24	7.2.7.	Android Settings .....	53
4.2.1.	Using DVI input.....	24	8.	Supported Media Formats.....	54
4.2.2.	Using HDMI input .....	24	9.	Input Mode .....	55
4.2.3.	Using VGA .....	25	10.	Pixel Defect Policy .....	57
4.3.	Connecting Audio Equipment.....	25	10.1.	Pixels and Sub-Pixels.....	57
4.3.1.	Connecting an external audio device.....	25	10.2.	Types of Pixel Defects + Dot Definition.....	57
4.4.	Connecting Multiple Displays in a Daisy-chain Configuration .....	25	10.3.	Bright Dot Defects.....	57
4.4.1.	Display control connection.....	25	10.4.	Dark Dot Defects .....	58
4.5.	IR connection.....	26	10.5.	Proximity of Pixel Defects .....	58
4.6.	IR Pass-through Connection.....	26	10.6.	Pixel Defect Tolerances .....	58
4.7.	Touch Operation.....	27	10.7.	MURA.....	58
5.	Operation .....	29	11.	Cleaning and Troubleshooting .....	59
5.1.	Watch the Connected Video Source.....	29	11.1.	Cleaning .....	59
5.2.	Change Picture Format.....	29	11.2.	Troubleshooting .....	60
5.3.	Launcher .....	29	12.	Technical Specifications.....	62
5.4.	Media Player .....	30	Warranty policy for Philips Professional Display Solutions .....	64	
5.4.1.	OSD menu interaction with media player:.....	30	Index.....	66	
5.4.2.	Media Player introduction:.....	30			

# 1. Safety Instructions

## Safety precautions and maintenance



**WARNING:** Use of controls, adjustments or procedures other than those specified in this documentation may result in exposure to shock, electrical hazards and/or mechanical hazards.

Read and follow these instructions when connecting and using your display:

### Operation:

- Keep the display out of direct sunlight and away from stoves or any other heat sources.
- Keep the display away from oil, otherwise the plastic cover may be damaged.
- Remove any object that could fall into ventilation holes or prevent proper cooling of the display's electronics.
- Do not block the ventilation holes on the cabinet.
- When positioning the display, make sure the power plug and outlet are easily accessible.
- When turning off the display by detaching the power cord, wait 6 seconds before re-attaching the power cord for normal operation.
- Ensure the use of an approved power cord provided by Philips at all times. If your power cord is missing, please contact your local service center.
- Do not subject the display to severe vibration or high impact conditions during operation.
- Do not knock or drop the display during operation or transportation.
- The eye bolt is for usage in short-time maintenance and installation. We suggest not to use the eye bolt for more than 1 hour. Prolong usage is prohibited. Please keep a clear safety area under the display while using the eye bolt.

### Maintenance:

- To protect your display from possible damage, do not put excessive pressure on the LCD panel. When moving your display, grasp the frame to lift; do not lift the display by placing your hand or fingers on the LCD panel.
- Unplug the display if you are not going to use it for an extensive period of time.
- Unplug the display if you need to clean it with a slightly damp cloth. The screen may be wiped with a dry cloth when the power is off. However, never use organic solvent, such as, alcohol, or ammonia-based liquids to clean your display.
- To avoid the risk of shock or permanent damage to the set, do not expose the display to dust, rain, water or an excessively moist environment.
- If your display becomes wet, wipe it with dry cloth as soon as possible.
- If a foreign substance or water gets in your display, turn the power off immediately and disconnect the power cord. Then remove the foreign substance or water, and send the unit to the maintenance center.
- Do not store or use the display in locations exposed to heat, direct sunlight or extreme cold.
- In order to maintain the best performance of your display and ensure a longer lifetime, we strongly recommend using the display in a location that falls within the following temperature and humidity ranges.
  - Temperature: 0-40°C 32-104°F
  - Humidity: 20-80% RH
- LCD panel temperature need to be 25 degrees Celsius at all time for better luminance performance.

**IMPORTANT:** Always activate a moving screen saver program when you leave your display unattended. Always activate a periodic screen refresh application if the unit will display unchanging static content. Uninterrupted display of still or static images over an extended period may cause "burn in", also known as "after-imaging" or "ghost imaging", on your screen. This is a well-known phenomenon in LCD panel technology. In most cases, the "burned in" or "after-imaging" or "ghost imaging" will disappear gradually over a period of time after the power has been switched off.

**WARNING:** Severe "burn-in" or "after-image" or "ghost image" symptoms will not disappear and cannot be repaired. This is also not covered under the terms of your warranty.

### Service:

- The casing cover should be opened only by qualified service personnel.
- If there is any need for repair or integration, please contact your local service center.
- Do not leave your display under direct sunlight.



If your display does not operate normally, having followed the instructions set out in this document, please contact a technician or your local service center.

### Stability Hazard

The device may fall, causing serious personal injury or death. To prevent injury, this device must be securely attached to the floor/wall in accordance with the installation instructions.

### Read and follow these instructions when connecting and using your display:



- Unplug the display if you are not going to use it for an extensive period of time.
- Unplug the display if you need to clean it with a slightly damp cloth. The screen may be wiped with a dry cloth when the power is off. However, never use alcohol, solvents or ammonia-based liquids.
- Consult a service technician if the display does not operate normally when you have followed the instructions in this manual.
- The casing cover should be opened only by qualified service personnel.
- Keep the display out of direct sunlight and away from stoves or any other heat sources.
- Remove any object that could fall into the vents or prevent proper cooling of the display's electronics.
- Do not block the ventilation holes on the cabinet.
- Keep the display dry. To avoid electric shock, do not expose it to rain or excessive moisture.
- When turning off the display by detaching the power cable or DC power cord, wait for 6 seconds before re-attaching the power cable or DC power cord for normal operation..
- To avoid the risk of shock or permanent damage to the set do not expose the display to rain or excessive moisture.
- When positioning the display, make sure the power plug and outlet are easily accessible.
- **IMPORTANT:** Always activate a screen saver program during your application. If a still image in high contrast remains on the screen for an extended period of time, it may leave an 'after-image' or 'ghost image' on the front of the screen. This is a well-known phenomenon that is caused by the shortcomings inherent in LCD technology. In most cases the afterimage will disappear gradually over a period of time after the power has been switched off. Be aware that the after-image symptom cannot be repaired and is not covered under warranty.
- If provided with a 3-pin attachment plug on the power cord, plug the cord into a grounded (earthed) 3-pin outlet. Do not disable the power cord grounding pin, for example, by attaching a 2-pin adapter. The grounding pin is an important safety feature.

### EU Declaration of Conformity/UK Declaration of Conformity

This device complies with the requirements set out in the Council Directive on the Approximation of the Laws of the Member States relating to Electromagnetic Compatibility (2014/30/EU), Low-voltage Directive (2014/35/EU), RoHS directive (2011/65/ EU), ErP directive (2009/125/EC).The Radio Equipment Directive(2014/53/EU) or Radio Equipment Regulations 2017(for UK).

This product has been tested and found to comply with the harmonized standards for Information Technology Equipment, these harmonized standards published under Directives of Official Journal of the European Union.

### ESD Warnings

When user close to the monitor may cause the equipment discharge and reboot to the display of main menu.

### Warning:

This equipment is compliant with Class A of EN55032/CISPR 32. In a residential environment this equipment may cause radio interference.

### Federal Communications Commission (FCC) Notice (U.S. Only)



**NOTE:** This equipment has been tested and found to comply with the limits for a Class A digital device, pursuant to part 15 of the FCC Rules. These limits are designed to provide reasonable protection against harmful interference when the equipment is operated in a commercial environment. This equipment generates, uses, and can radiate radio frequency energy and, if not installed and used in accordance with the instruction manual, may cause harmful interference to radio communications. Operation of this equipment in a residential area is likely to cause harmful interference in which case the user will be required to correct the interference at his own expense.



Changes or modifications not expressly approved by the party responsible for compliance could void the user's authority to operate the equipment.

Use only an RF shielded cable that was supplied with the display when connecting this display to a computer device.

To prevent damage which may result in fire or shock hazard, do not expose this appliance to rain or excessive moisture.

This device complies with Part 15 of the FCC / ISED's licence-exempt RSSs Rules. Operation is subject to the following two conditions: (1) This device may not cause harmful interference, and (2) this device must accept any interference received, including interference that may cause undesired operation.

Le présent appareil est conforme aux CNR d'ISED applicables aux appareils radio exempts de licence. L'exploitation est autorisée aux deux conditions suivantes : (1) le dispositif ne doit pas produire de brouillage préjudiciable, et (2) ce dispositif doit accepter tout brouillage reçu, y compris un brouillage susceptible de provoquer un fonctionnement indésirable.

Envision Peripherals Inc.  
490 N McCarthy Blvd, Suite #120  
Milpitas, CA 95035  
USA

## Europe Statement

### IMPORTANT NOTE:

The device is restricted to indoor use only when operating in the 5150 to 5350MHz frequency range. ( for 5G product only)

	AT	BE	BG	HR	CY	CZ	DK
	EE	FI	FR	DE	EL	HU	IE
	IT	LV	LT	LU	MT	NL	PL
	PT	RO	SK	SI	ES	SE	UK(NI)
	UK						

### Radiation Exposure Statement:

This equipment complies with CE radiation exposure limits set forth for an uncontrolled environment. This equipment should be installed and operated with minimum distance 20cm between the radiator & body.

The frequency, mode and the maximum transmitted power in EU are listed below:

2400-2483.5MHz: < 20 dBm (EIRP) ( for 2.4G product only)

5150-5250MHz: < 23 dBm (EIRP)

5250-5350MHz: < 23 dBm (EIRP)

5470-5725MHz: < 30 dBm (EIRP)

5725-5825MHz: < 13.98 dBm (EIRP)

## Taiwan:

### 低功率電波輻射性電機管理辦法

取得審驗證明之低功率射頻器材，非經核准，公司、商號或使用者均不得擅自變更頻率、加大功率或變更原設計之特性及功能。

低功率射頻器材之使用不得影響飛航安全及干擾合法通信；經發現有干擾現象時，應立即停用，並改善至無干擾時方得繼續使用。

前述合法通信，指依電信管理法規定作業之無線電通信。低功率射頻器材須忍受合法通信或工業、科學及醫療用電波輻射性電機設備之干擾。

### FCC/ISED/CE-RED Caution:

Any changes or modifications not expressly approved by the party responsible for compliance could void the user's authority to operate this equipment.

This transmitter must not be co-located or operating in conjunction with any other antenna or transmitter.

Operations in the 5GHz products are restricted to indoor usage only.

### Déclaration d'exposition aux radiations:

Cet équipement est conforme aux limites d'exposition aux rayonnements ISED établies pour un environnement non contrôlé. Cet équipement doit être installé et utilisé avec un minimum de 20cm de distance entre la source de rayonnement et votre corps.

## Canada:

Industry Canada statement:

This device complies with RSS-247 of the Industry Canada Rules. Operation is subject to the following two conditions: (1) This device may not cause harmful interference, and (2) this device must accept any interference received, including interference that may cause undesired operation.

Ce dispositif est conforme à la norme CNR-247 d'Industrie Canada applicable aux appareils radio exempts de licence. Son fonctionnement est sujet aux deux conditions suivantes: (1) le dispositif ne doit pas produire de brouillage préjudiciable, et (2) ce dispositif doit accepter tout brouillage reçu, y compris un brouillage susceptible de provoquer un fonctionnement indésirable.

### Radiation Exposure Statement:

This equipment complies with FCC/ISED/CE-RED radiation exposure limits set forth for an uncontrolled environment. This equipment should be installed and operated with minimum distance 20cm between the radiator & your body.

### Déclaration d'exposition aux radiations:

Cet équipement est conforme aux limites d'exposition aux rayonnements ISED établies pour un environnement non contrôlé. Cet équipement doit être installé et utilisé avec un minimum de 20 cm de distance entre la source de rayonnement et votre corps.

## Polish Center for Testing and Certification Notice

The equipment should draw power from a socket with an attached protection circuit (a three-prong socket). All equipment that works together (computer, display, printer, and so on) should have the same power supply source.

The phasing conductor of the room's electrical installation should have a reserve short-circuit protection device in the form of a fuse with a nominal value no larger than 16 amperes (A).

To completely switch off the equipment, the power supply cable must be removed from the power supply socket, which should be located near the equipment and easily accessible.

A protection mark "B" confirms that the equipment is in compliance with the protection usage requirements of standards PN-93/T-42107 and PN-89/E-06251.

### ***Wymagania Polskiego Centrum Badań i Certyfikacji***

Urządzenie powinno być zasilane z gniazda z przyłączonym obwodem ochronnym (gniazdo z kolkiem). Współpracujące ze sobą urządzenia (komputer, monitor, drukarka) powinny być zasilane z tego samego źródła.

Instalacja elektryczna pomieszczenia powinna zawierać w przewodzie fazowym rezerwową ochronę przed zwarciami, w postaci bezpiecznika o wartości znamionowej nie większej niż 16A (amperów).

W celu całkowitego wyłączenia urządzenia z sieci zasilania, należy wyjąć wtyczkę kabla zasilającego z gniazdka, które powinno znajdować się w pobliżu urządzenia i być łatwo dostępne.

Znak bezpieczeństwa "B" potwierdza zgodność urządzenia z wymaganiami bezpieczeństwa użytkowania zawartymi w PN-93/T-42107 i PN-89/E-06251.

### ***Pozostałe instrukcje bezpieczeństwa***

- Nie należy używać wtyczek adapterowych lub usuwać kolka obwodu ochronnego z wtyczki. Jeżeli konieczne jest użycie przedłużacza to należy użyć przedłużacza 3-żyłowego z prawidłowo połączonym przewodem ochronnym.
- System komputerowy należy zabezpieczyć przed nagłymi, chwilowymi wzrostami lub spadkami napięcia, używając eliminatora przepięć, urządzenia dopasowującego lub bezzakłóceniewego źródła zasilania.
- Należy upewnić się, aby nic nie leżało na kablach systemu komputerowego, oraz aby kable nie były umieszczone w miejscu, gdzie można byłoby na nie nadeptywać lub potykać się o nie.
- Nie należy rozlewać napojów ani innych płynów na system komputerowy.
- Nie należy wpychać żadnych przedmiotów do otworów systemu komputerowego, gdyż może to spowodować pożar lub porażenie prądem, poprzez zwarcie elementów wewnętrznych.
- System komputerowy powinien znajdować się z dala od grzejników i źródeł ciepła. Ponadto, nie należy blokować otworów wentylacyjnych. Należy unikać kładzenia luźnych papierów pod komputer oraz umieszczania komputera w ciasnym miejscu bez możliwości cyrkulacji powietrza wokół niego.

## Electric, Magnetic and Electromagnetic Fields ("EMF")

1. We manufacture and sell many products targeted at consumers, which, like any electronic apparatus, in general have the ability to emit and receive electromagnetic signals.
2. One of our leading Business Principles is to take all necessary health and safety measures for our products, to comply with all applicable legal requirements and to stay well within the EMF standards applicable at the time of producing the products.
3. We are committed to develop, produce and market products that cause no adverse health effects.
4. We confirm that if its products are handled properly for their intended use, they are safe to use according to scientific evidence available today.
5. We play an active role in the development of international EMF and safety standards, enabling us to anticipate further developments in standardization for early integration in its products.

## Information for U.K. only

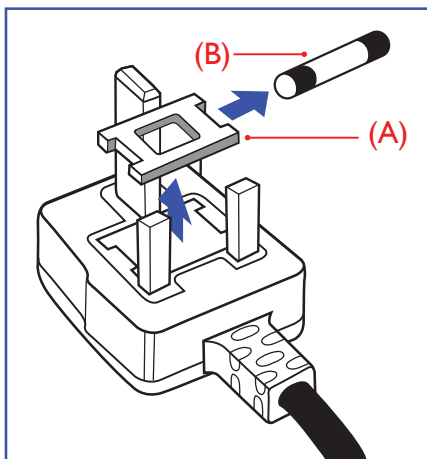

### WARNING - THIS APPLIANCE MUST BE EARTHED.

#### Important:

This apparatus is supplied with an approved moulded 13A plug. To change a fuse in this type of plug proceed as follows:+

1. Remove fuse cover and fuse.
2. Fit new fuse which should be a BS 1362 5A, A.S.T.A. or BSI approved type.
3. Refit the fuse cover.

If the fitted plug is not suitable for your socket outlets, it should be cut off and an appropriate 3-pin plug fitted in its place.

If the mains plug contains a fuse, this should have a value of 5A. If a plug without a fuse is used, the fuse at the distribution board should not be greater than 5A.

Note: The severed plug must be destroyed to avoid a possible shock hazard should it be inserted into a 13A socket elsewhere.

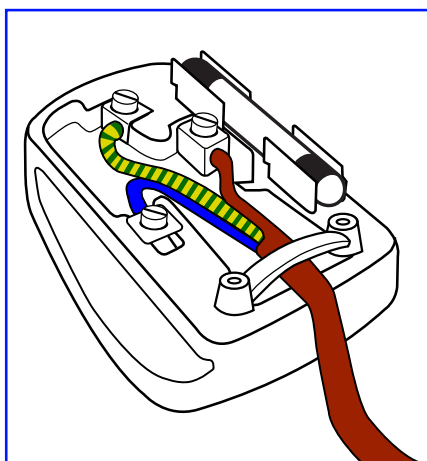

#### How to connect a plug

The wires in the mains lead are coloured in accordance with the following code:

BLUE - "NEUTRAL" ("N")

BROWN - "LIVE" ("L")

GREEN & YELLOW - "EARTH" ("E")

1. The GREEN & YELLOW wire must be connected to the terminal in the plug which is marked with the letter "E" or by the Earth symbol or coloured GREEN or GREEN & YELLOW.
2. The BLUE wire must be connected to the terminal which is marked with the letter "N" or coloured BLACK.
3. The BROWN wire must be connected to the terminal which marked with the letter "L" or coloured RED.

Before replacing the plug cover, make certain that the cord grip is clamped over the sheath of the lead - not simply over the three wires.

## North Europe (Nordic Countries) Information

Placering/Ventilation

#### VARNING:

FÖRSÄKRA DIG OM ATT HUVUDBRYTARE OCH UTTAG ÄR LÄTÅTKOMLIGA, NÄR DU STÄLLER DIN UTRUSTNING PÅPLATS.

Placering/Ventilation

#### ADVARSEL:

SØRG VED PLACERINGSFOR, AT NETLEDNINGENS STIK OG STIKKONTAKT ER NEMT TILGÆNGELIGE.

Paikka/Ilmankierto

#### VAROITUS:

SIIJOITA LAITE SITEN, ETTÄ VERKKOJOHTO VOIDAAN TARVITTAESSA HELPOSTI IRROTTAA PISTORASIESTA.

Plassering/Ventilasjon

#### ADVARSEL:

NÅR DETTE UTSTYRET Plasseres, MÅ DU PASSE PÅ AT KONTAKTENE FOR STØMTILFØRSEL ER LETTE Å NÅ.



## China RoHS

根据中国大陆《电器电子产品有害物质限制使用管理办法》，以下部分列出了本产品中可能包含的有害物质的名称和含量。

部件名称	有害物质					
	铅 (Pb)	汞 (Hg)	镉 (Cd)	六价铬 (Cr(VI))	多溴联苯 (PBB)	多溴二苯醚 (PBDE)
外壳	O	O	O	O	O	O
液晶显示屏	X	O	O	O	O	O
电路板组件*	X	O	O	O	O	O
电源适配器	X	O	O	O	O	O
电源线/连接线	X	O	O	O	O	O
遥控器	X	O	O	O	O	O

本表格依据SJ/T 11364 的规定编制。

\*: 电路板组件包括印刷电路板及其构成的零部件，如电阻、电容、集成电路、连接器等。

O: 表示该有害物质在该部件所有均质材料中的含量均在 GB/T 26572规定的限量要求以下。

X: 表示该有害物质至少在该部件的某一均质材料中的含量超出GB/T 26572规定的限量要求。

上表中打“X”的部件，应功能需要，部分有害物质含量超出GB/T 26572规定的限量要求，但符合欧盟RoHS法规要求（属于豁免部分）。

备注：上表仅做为范例，实际标示时应依照各产品的实际部件及所含有害物质进行标示。



### 环保使用期限

此标识指期限(十年)，电子电气产品中含有的有害物质在正常使用的条件下不会发生外泄或突变，电子电气产品用户使用该电子电气产品不会对环境造成严重污染或对其人身、财产造成严重损害的期限。

#### 《废弃电器电子产品回收处理管理条例》提示性说明

为了更好地关爱及保护地球，当用户不再需要此产品或产品寿命终止时，请遵守国家废弃电器电子产品回收处理相关法律法规，将其交给当地具有国家认可的回收处理资质的厂商进行回收处理，不当利用或者处置可能会对环境和人类健康造成影响。

#### 警告

此为A级产品。在生活环境中，该产品可能会造成无线电干扰。在这种情况下，可能需要用户对干扰采取切实可行的措施。

單元	限用物質及其化學符號					
	鉛 (Pb)	汞 (Hg)	鎘 (Cd)	六價鉻 (Cr+6)	多溴聯苯 (PBB)	多溴二苯醚 (PBDE)
塑料外框	○	○	○	○	○	○
後殼	○	○	○	○	○	○
液晶面板	-	○	○	○	○	○
電路板組件	-	○	○	○	○	○
底座 (選配)	○	○	○	○	○	○
電源線	-	○	○	○	○	○
其他線材	-	○	○	○	○	○
遙控器	-	○	○	○	○	○
喇叭 (選配)	-	○	○	○	○	○
風扇 (選配)	-	○	○	○	○	○
備考1. "○" 係指該項限用物質之百分比含量未超出百分比含量基準值。						
備考2. "-" 係指該項限用物質為排除項目。						

警語：使用過度恐傷害視力。

注意事項：

- (1) 使用 30 分鐘請休息 10 分鐘。
- (2) 未滿 2 歲幼兒不看螢幕，2 歲以上每天看螢幕不要超過 1 小時。

警告使用者：

此為甲類資訊技術設備，於居住環境中使用時，可能會造成射頻擾動，在此種情況下，使用者會被要求採取某些適當的對策。

#### Turkey RoHS:

Türkiye Cumhuriyeti: EEE Yönetmeliğine Uygundur

#### Ukraine RoHS:

Обладнання відповідає вимогам Технічного регламенту щодо обмеження використання деяких небезпечних речовин в електричному та електронному обладнанні, затвердженого постановою Кабінету Міністрів України від 3 грудня 2008 № 1057

## End-of-Life Disposal

Your new Public Information Display contains materials that can be recycled and reused. Specialized companies can recycle your product to increase the amount of reusable materials and to minimize the amount to be disposed of.

Please find out about the local regulations on how to dispose of your old display from your local Philips dealer.

**(For customers in Canada and U.S.A.)**

This product may contain lead and/or mercury. Dispose of in accordance to local-state and federal regulations. For additional information on recycling contact [www.eia.org](http://www.eia.org) (Consumer Education Initiative)

## Waste Electrical and Electronic Equipment-WEEE

Attention users in European Union private households



This marking on the product or on its packaging illustrates that, under European Directive 2012/19/EU governing used electrical and electronic appliances, this product may not be disposed of with normal household waste. You are responsible for disposal of this equipment through a designated waste electrical and electronic equipment collection. To determine the locations for dropping off such waste electrical and electronic, contact your local government office, the waste disposal organization that serves your household or the store at which you purchased the product.

Attention users in United States:

Please dispose of according to all Local, State and Federal Laws. For the disposal or recycling information, contact: [www.mygreenelectronics.com](http://www.mygreenelectronics.com) or [www.eiae.org](http://www.eiae.org).

End of Life Directives-Recycling



Your new Public Information Display contains several materials that can be recycled for new users. Please dispose of according to all Local, State, and Federal laws.

## Restriction on Hazardous Substances statement (India)

This product complies with the "E-Waste (Management) Rules, 2016" CHAPTER V, rule 16, sub-rule (1) . Whereas New Electrical and Electronic Equipment and their components or consumables or parts or spares do not contain Lead, Mercury, Cadmium, Hexavalent Chromium, polybrominated biphenyls and polybrominated diphenyl ethers beyond a maximum concentration value of 0.1% by weight in homogenous materials for lead, mercury, hexavalent chromium, polybrominated biphenyls and polybrominated diphenyl ethers and of 0.01% by weight in homogenous materials for cadmium. except of exemptions set in Schedule 2 of the Rule.

E-Waste Declaration for India

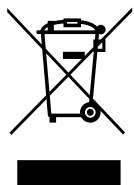

This symbol on the product or on its packaging indicates that this product must not be disposed of with your other household waste. Instead it is your responsibility to dispose of your waste equipment by handing it over to a designated collection point for the recycling of waste electrical and electronic equipment . The separate collection and recycling of your waste equipment at the time of disposal will help to conserve natural resources and ensure that it is recycled in a manner that protects human health and the environment. For more information about E -waste please visit <http://www.india.philips.com/about/sustainability/recycling/index.page> and to know where you can drop off your waste equipment for recycling in India please contact on below given contact details.

Helpline number: 1800-425-6396 (Monday to Saturday, 9 a.m. to 5:30 pm)

E-mail: [india.callcentre@tpv-tech.com](mailto:india.callcentre@tpv-tech.com)

**Batteries**

For EU: The crossed-out wheeled bin implies that used batteries should not be put to the general household waste! There is a separate collection system for used batteries, to allow proper treatment and recycling in accordance with legislation.

Please contact your local authority for details on the collection and recycling schemes.

For Switzerland: The used battery is to be returned to the selling point.

For other non-EU countries: Please contact your local authority for correct method of disposal of the used battery. According to EU directive 2006/66/EC, the battery can't be disposed improperly. The battery shall be separated to collect by local service.

	<p>Após o uso, as pilhas e/ou baterias deverão ser entregues ao estabelecimento comercial ou rede de assistência técnica autorizada.</p>
--	--

Information for EAC	
Month and year of manufacturing	please refer information in Rating label.
Name and location of manufacturer	ООО "Профтехника" Адрес: 3-й Проезд Марьиной рощи, 40/1 офис 1. Москва, 127018, Россия
Importer and information	Наименование организации: ООО "Профтехника" Адрес: 3-й Проезд Марьиной рощи, 40/1 офис 1. Москва, 127018, Россия Контактное лицо: Наталья Астафьева, +7 495 640 20 20 nat@profdisplays.ru

**Information for FAC:**

"Подтверждение соответствия Мининформсвязи России: Декларация соответствия № Д-РД-4342 от 01.09.2016 года, действительна до 01.09.2024 года, зарегистрирована в Федеральном агентстве связи 14.09.2016 года"

## 2. Unpacking

- This product is packed in a carton, together with the standard accessories.
- Any other optional accessories will be packed separately.
- As this product is high and heavy, the operation of moving the device is recommended to be performed by two technicians.
- After opening the carton, ensure that the contents are complete and in good condition.

### ■ Before Unpacking

- Please read and fully understand unpacking notice before installation.
- Please check the packing, there should be no any abnormality such as creak, dent mark...etc.
- Please do necessary inspection before you move the display out of the carton.
- Always install the display by experienced technician to prevent any damage.

### ■ Notice

- Take the display out of the carton box by two adults with both hands.
- Please do not grab or touch the glass of the display.
- Please grab on the bezel surface (plastic or metal) of the display.

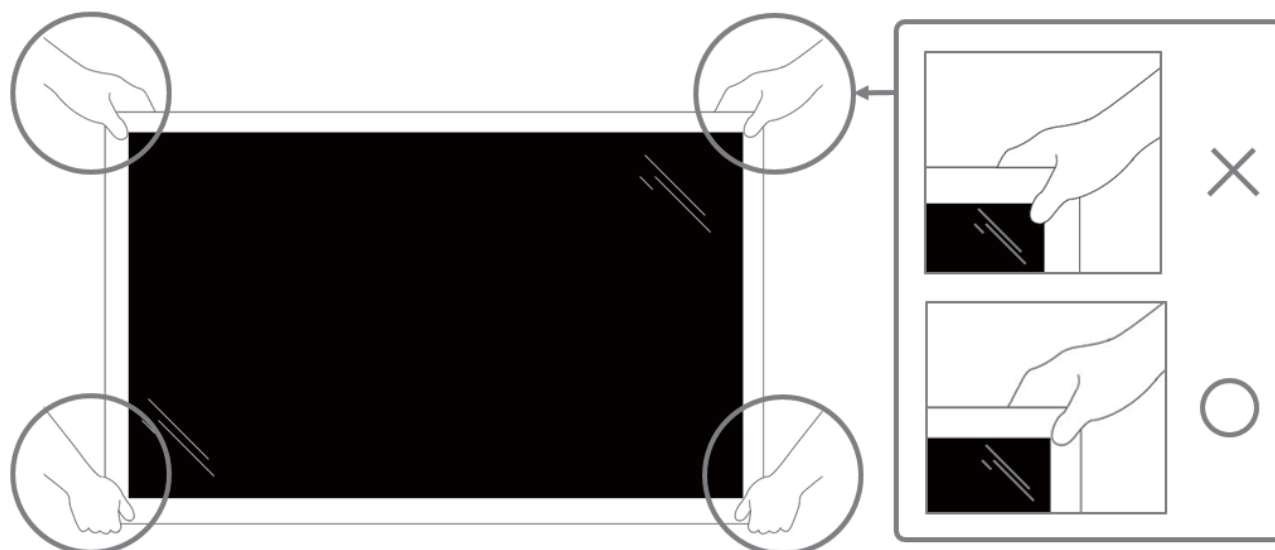

- Please keep the display vertically when moving it.

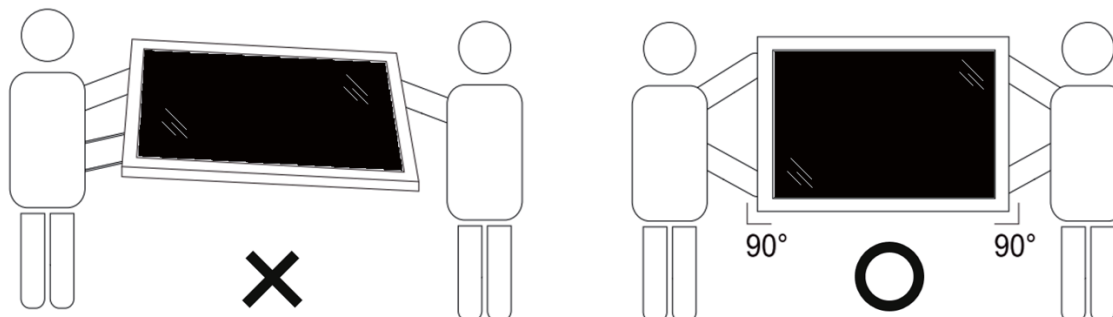

- Place the display vertically and its weight should spread evenly on the surface.

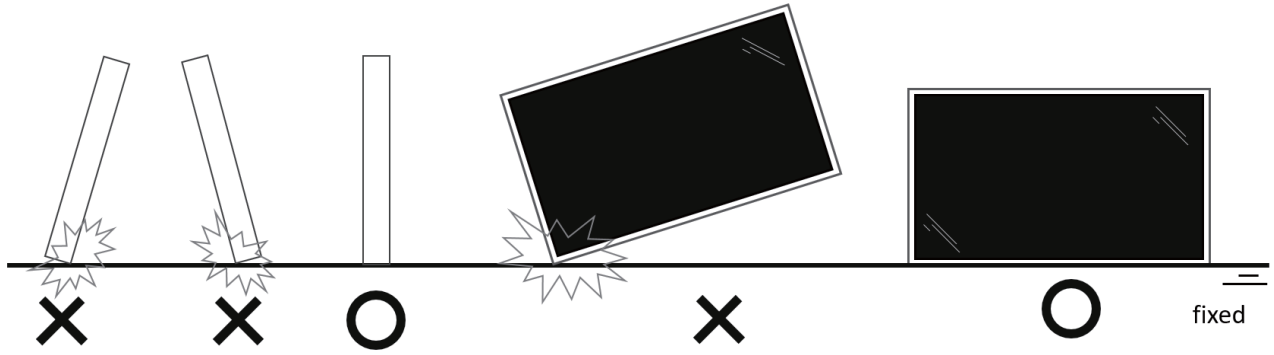

- Please keep vertically, no bending and torsion during moving the display.

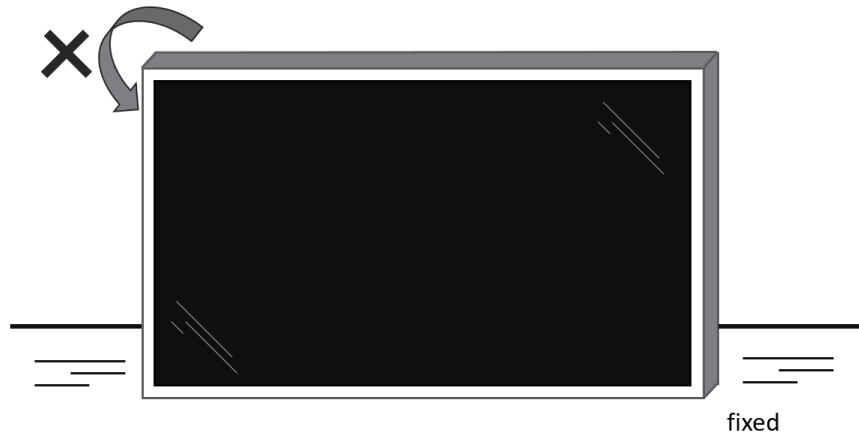

## 2.1. Package Contents

Please verify that you received the following items with your package content:

- LCD Display
- Quick start guide
- Remote Control and AAA batteries
- Power cable
- RS232 cable
- RS232 daisy chain cable
- IR sensor cable
- HDMI cable
- DVI cable
- Touch USB
- Philips logo plate
- USB Cover
- Cable Clip
- AC Cover
- Touch pen(Only 55BDL3452T)

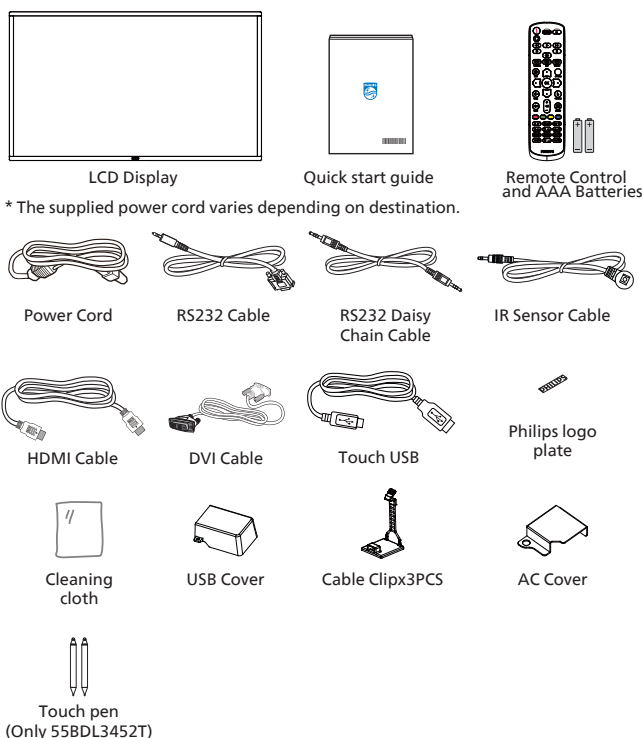

\* Items may differ in different locations

\* Display design and accessories may differ from the images shown.

### NOTES:

- For all other regions, apply a power cord that conforms to the AC voltage of the power socket and has been approved by and complies with the safety regulations of the particular country (Type H05W-F, 2G or 3G, 0.75 or 1 mm<sup>2</sup> should be used).
- Keep the packaging materials appropriately after unpacking the product.

## 2.2. Installation Notes

- Only use the power cable provided with this product. If an extension cord is required, please consult your service agent.
- The product should be installed on a flat surface, or the product may tip over. Leave a space between the rear of the product and the wall for proper ventilation. Do not install the product in a kitchen, bathroom or a place exposed to moisture, failure to do so may shorten the life of the internal parts.
- Do not install the product where it is 3000m and higher in altitude. Failure to do so may result in malfunctions.

## 2.3. Mounting on a Wall

To mount this display on a wall, a standard wall-mounting kit (commercially available) is required. It is recommended that you use a mounting interface that complied with TUV-GS and /or UL1678 standard in North America.

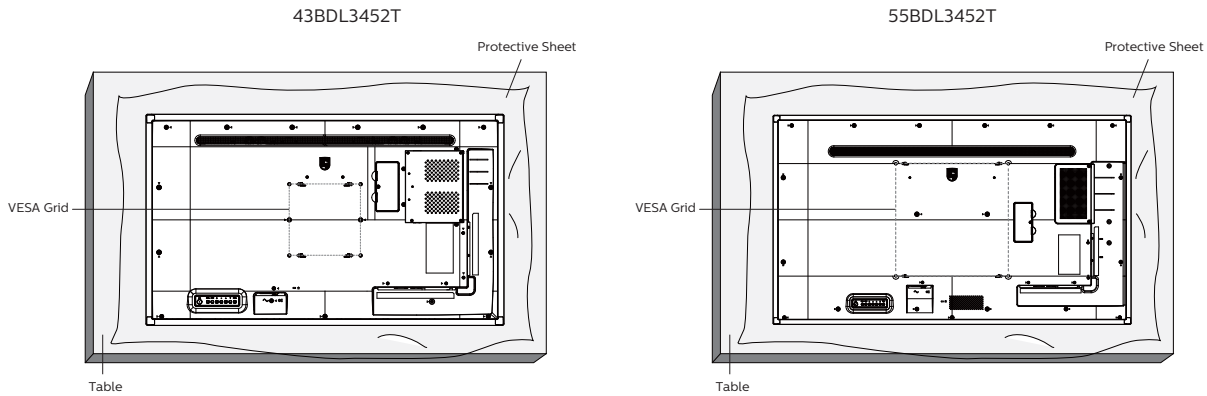

1. Prepare a flat and horizontal surface that is larger than the display and spread a thick protective sheet on it to facilitate your operation without scratching the screen.
2. Ensure you have all accessories for all types of mounting (wall mount, ceiling mount, table stand, etc).
3. Follow the instructions that came with the base mounting kit. Failure to follow the correct mounting procedures could result in damage to the equipment, or injury to the user or installer. The product warranty does not cover the damage caused by improper installation.
4. 43BDL3452T/55BDL3452T: For the wall-mounting kit, use the M6 mounting screws (with a length 10 mm longer than the thickness of the mounting bracket) and tighten them securely.

### 2.3.1. VESA Grid

43BDL3452T	200(H) x 200(V) mm
55BDL3452T	400(H) x 400(V) mm

#### Caution:

To prevent the display from falling:

- For wall or ceiling mounting, we recommend that you install the display with metal brackets which are commercially available. For detailed instructions about the installation, refer to the guide provided with the bracket.
- To prevent the display from falling in case of earthquake or other natural disaster, please consult the manufacturer of the bracket for the mounting location.
- As this product is high and heavy, the installation of this product is recommended to be performed by four technicians.

#### Required space for ventilation

Leave a space of 100 mm at the top, rear, right and left of the display for ventilation.

Note: We recommend you contact a professional technician when installing the display on a wall. We are not responsible for any damage to the product if the installation is not performed by a professional technician.

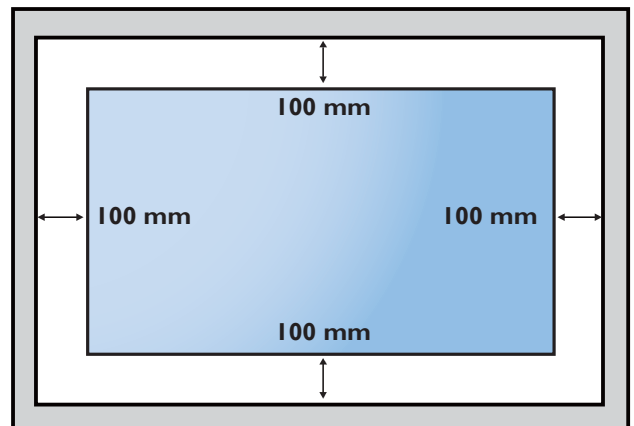



### 3. Parts and Functions

#### 3.1. Control Panel

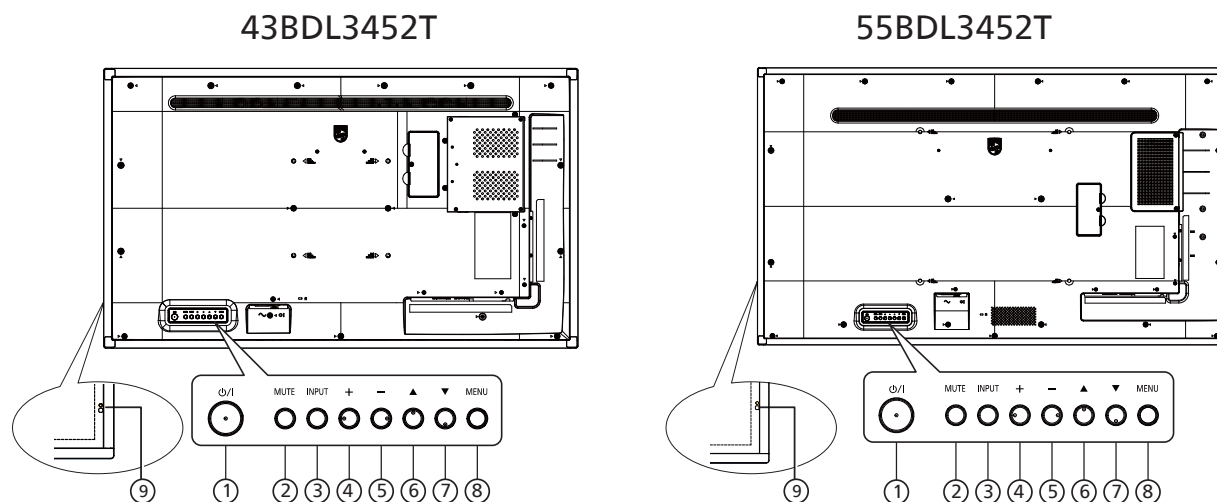

- ① **[⏻/⏻] button**  
Turn the display On or put the display to standby mode.
- ② **[MUTE] button**  
Mute the sound or reactivate sound.
- ③ **[INPUT] button**  
Select an input source.
- ④ **[+] button**  
Increase the adjustment while OSD menu is On, or increase the audio output level while OSD menu is Off.
- ⑤ **[-] button**  
Decrease the adjustment while OSD menu is On, or decrease the audio output level while OSD menu is Off.
- ⑥ **[▲] button**  
Move the selected item one level up while the OSD menu is On.
- ⑦ **[▼] button**  
Move the selected item one level down while the OSD menu is On.
- ⑧ **[MENU] button**  
Return to the previous menu while the OSD menu is On. This button can also be used to activate the OSD menu when the OSD menu is Off.
- ⑨ **Remote control sensor and power status indicator**
  - Receive command signals from the remote control.
  - Indicate the operating status of the display:
    - Light green when the display is turned On
    - Light red when the display is in the standby mode
    - When {SCHEDULE} is enabled, the light blinks green and red
    - If the light blinks red, it indicates that a failure has been detected
    - Lights off when the main power of the display is

turned off

**\* Use an IR sensor cable for better remote control performance. (Please refer to the instructions on 4.5)**

## 3.2. Input/Output Terminals

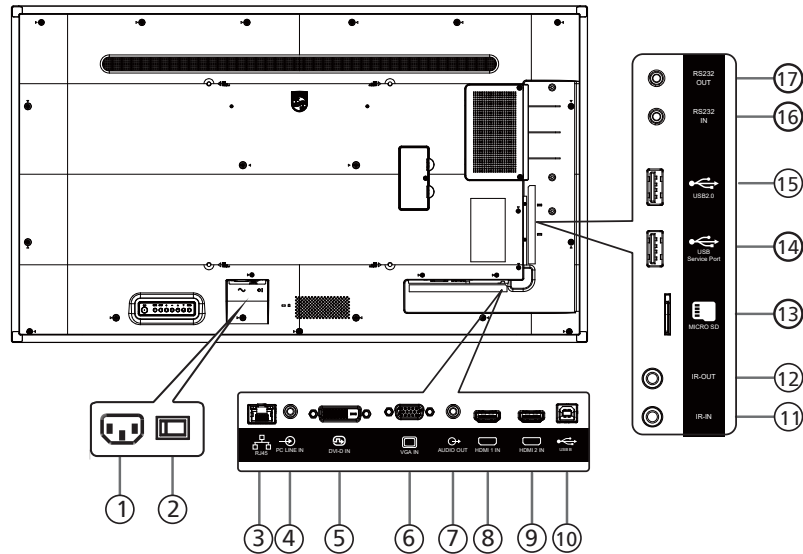

### ① AC IN

AC power input from the wall outlet.

### ② MAIN POWER SWITCH

Switch the main power between On and Off.

### ③ RJ-45

The LAN control function is used for sending the remote control signal from the control center.

### ④ PC LINE IN

Audio input for VGA source (3.5mm stereo phone).

### ⑤ DVI-D IN

DVI video input.

### ⑥ VGA IN(D-Sub)

VGA video input

### ⑦ AUDIO OUT

Audio output for external AV device.

### ⑧ HDMI1 IN / ⑨ HDMI2 IN

Connect to a source device via an HDMI cable.

### ⑩ USB-B

Connect to external PC to support touch function

### ⑪ IR IN / ⑫ IR OUT

IR signal input/output for the loop-through function.

#### NOTES:

- The remote control sensor of this display will stop working if the jack [IR IN] is connected.
- To remotely control your A/V device via this display, refer to page 26 for IR Pass Through connection.

### ⑬ MICRO SD

Insert a Micro SD card.

### ⑭ USB SERVICE PORT

Connect to USB storage for main board Firmware update.

### ⑮ USB 2.0 PORT

Connect your USB storage device and service port.

### ⑯ RS232 IN / ⑰ RS232 OUT

Android RS232 network input/output is reserved for customized protocol usage from System Integrator.

Note: It's for updating firmware only.

### 3.3. Inserting the batteries in the remote control

The remote control is powered by two 1.5V AAA batteries.

To install or replace the batteries:

1. Press and then slide the cover to open it.
2. Insert the batteries with the correct polarity (+) and (-).
3. Replace the cover.

#### Caution:

Incorrect use of batteries may cause leakage or explosion. Be sure to follow the instructions below:

- Insert "AAA" batteries with the correct polarity (+ and -).
- Do not mix battery types.
- Do not use a new battery with a used one together. Otherwise, it may cause leakage or shorten the life of the batteries.
- Remove the dead batteries immediately to avoid battery leakage in the battery compartment. Do not touch exposed battery acid, as it may cause injury to your skin.
- Disposal of a battery into fire or a hot oven, or mechanically crushing or cutting of a battery, that can result in an explosion; leaving a battery in an extremely high temperature surrounding environment that can result in an explosion or the leakage of flammable liquid or gas; and a battery subjected to extremely low air pressure that may result in an explosion or the leakage of flammable liquid or gas.

Note: Remove the batteries from the battery compartment when not using for an extended period of time.

### 3.4. Handling the remote control

- Do not drop or apply shock to the remote control.
- Do not allow any liquid to get inside the remote control. If water has entered the remote control, wipe the remote control with a dry cloth immediately.
- Do not place the remote control near heat and steam sources.
- Do not attempt to disassemble the remote control, unless you need to place batteries in the remote control.

### 3.5. Operating range of the remote control

Point the top front of the remote control at the remote sensor on the display when you press the buttons.

Use the remote control within a distance of less than 4m/16ft from the display's sensor, and a horizontal and vertical angle of less than 0°.

Note: The remote control may not function properly when the remote control sensor on the display is under direct sunlight or strong illumination, or when there is an object between the remote control and the remote sensor of the display.

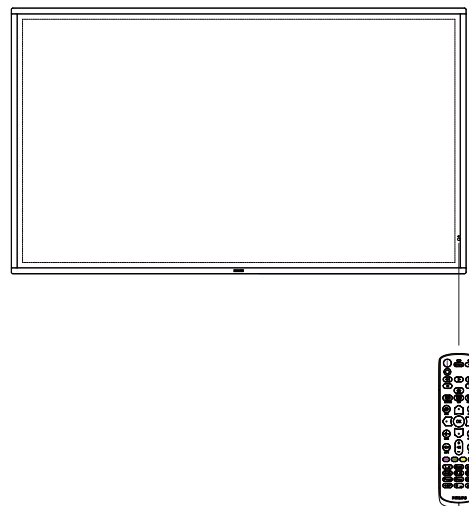

## 3.6. Remote Control

### 3.6.1. General functions

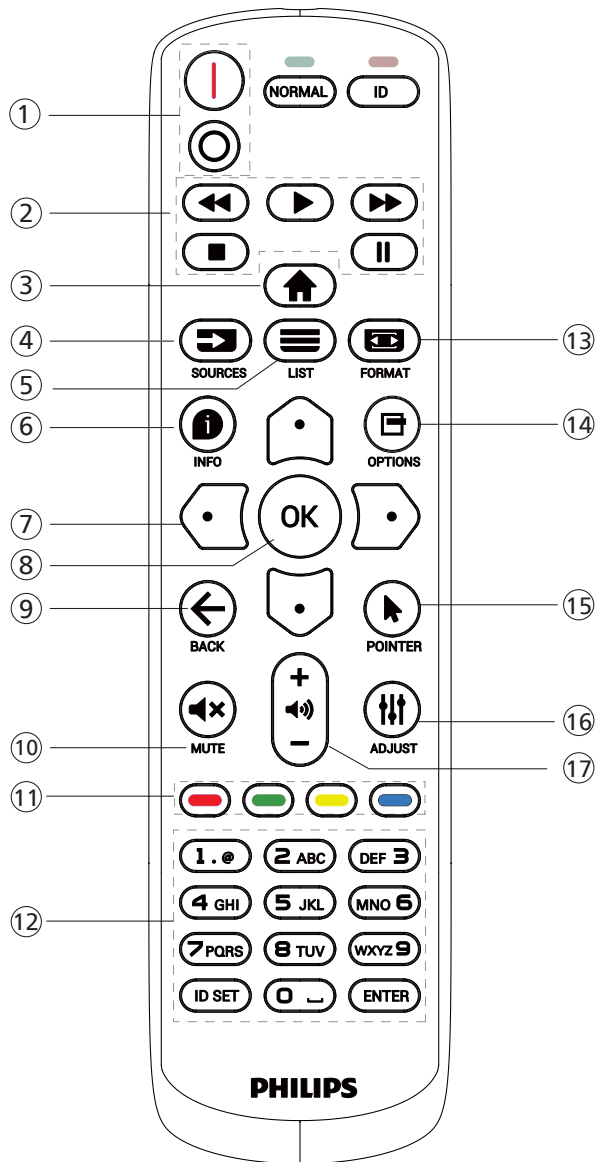

#### ① [I/O] POWER button

[I] Turn the power On.  
[O] Turn the power Off.

#### ② [PLAY] buttons

Control playback of media files.(for Media Input only)  
Freeze feature

Pause: hotkey for freezing all inputs content.  
Play: hotkey for unfreezing all input content.

#### ③ [HOME] HOME button

Root Menu: Go to the OSD of Main Menu.  
Others: Exit from the OSD.

#### ④ [SOURCE] SOURCE button

Root Menu: Go to the OSD of Video source.

#### ⑤ [LIST] LIST button

Reserved.

#### ⑥ [I] INFO button

Show Information OSD.

#### ⑦ NAVIGATION buttons

[HOME]

Root Menu: Go to the OSD of Smart picture.  
Main Menu: Move the selected item up to make adjustment.

IR Daisy Chain Menu: Increase the controlled Group ID number.

[DOWN]

Root Menu: Go to the OSD of Audio source.

Main Menu: Move the selected item bar down to make adjustment.

IR Daisy Chain Menu: Decrease the controlled Group ID number.

[UP]

Main Menu: Go to the previous level of menu.

Source Menu: Exit from the source menu.

Volume Menu: Decrease the volume.

[D]

Main Menu: Go to the next level of menu or set selected option.

Source Menu: Go to the selected source.

Volume Menu: Increase the volume.

#### ⑧ [OK] button

Root Menu: Go to the OSD of IR daisy chain in Primary/ Secondary mode.

Main Menu: Confirm an entry or selection.

#### ⑨ [←] BACK button

Return to the previous page or exit from the previous function.

#### ⑩ [MUTE] MUTE button

Mute or unmute the sound.

#### ⑪ [RED] [GREEN] [YELLOW] [BLUE] COLOR buttons

Choose a task or option. (for Media Input only)  
[GREEN] Hotkey for Window selection function.

#### ⑫ [Number/ ID SET/ ENTER] button

Enter text for network setting.

Press to set the display ID. Refer to 3.6.2. ID Remote Control for more details.

#### ⑬ [FORMAT] FORMAT button

Select image zoom mode from Full, 4:3, 1:1, 16:9, 21:9 or Custom.

#### ⑭ [OPTIONS] OPTIONS button

Reserved.

#### ⑮ [POINTER] POINTER button

Mouse function for Android

#### ⑯ [ADJUST] ADJUST button

Go to the OSD of Auto Adjust (for VGA only).

#### ⑰ [−] [+] VOLUME button

Adjust the volume.

### 3.6.2. ID Remote Control

Set remote control ID number when using several displays.

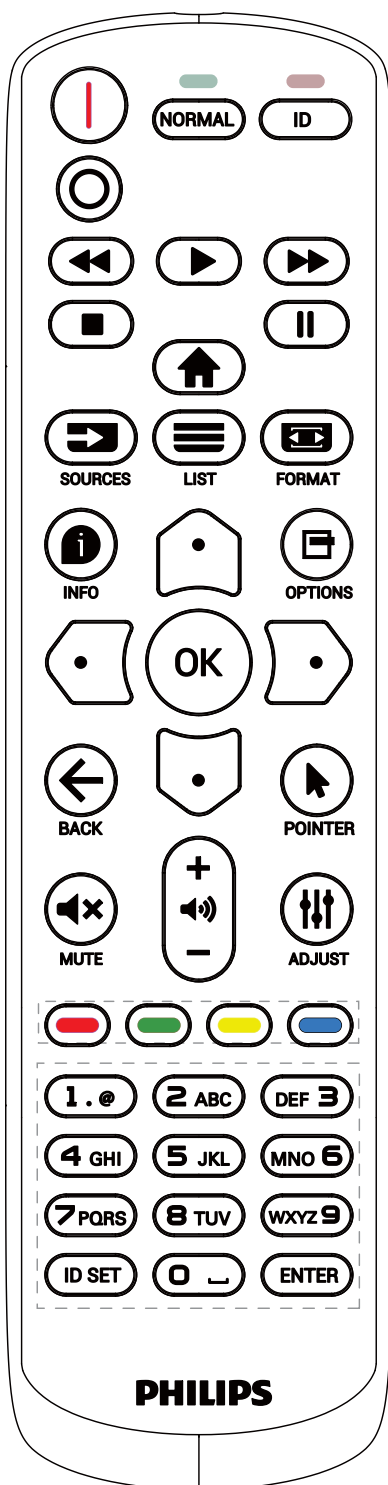

Press the [ID] button and the red LED blinks twice.

1. Press [ID SET] button for more than 1 second to enter the ID Mode. The red LED lights up.  
Press the [ID SET] button again will exit the ID Mode. The red LED lights off.

Press the digit numbers [0] ~ [9] to select the display to be controlled.

For example: press [0] and [1] for display No.1, press [1] and [1] for display No.11.

The numbers available are [01] ~ [255].

2. If no button is pressed within 10 seconds, it will exit from the ID mode.
3. If a wrong button is pressed, wait for 1 second until the red LED lights off and then turns on again, then press the correct digits.
4. Press [ENTER] button to confirm your selection. The red LED blinks twice and then lights off.

#### NOTE:

- Press [NORMAL] button. The green LED blinks twice, indicating that the display is under normal operation.
- It is necessary to set up the ID number for each display before selecting its ID number.

### 3.6.3. Remote Control buttons on Android source

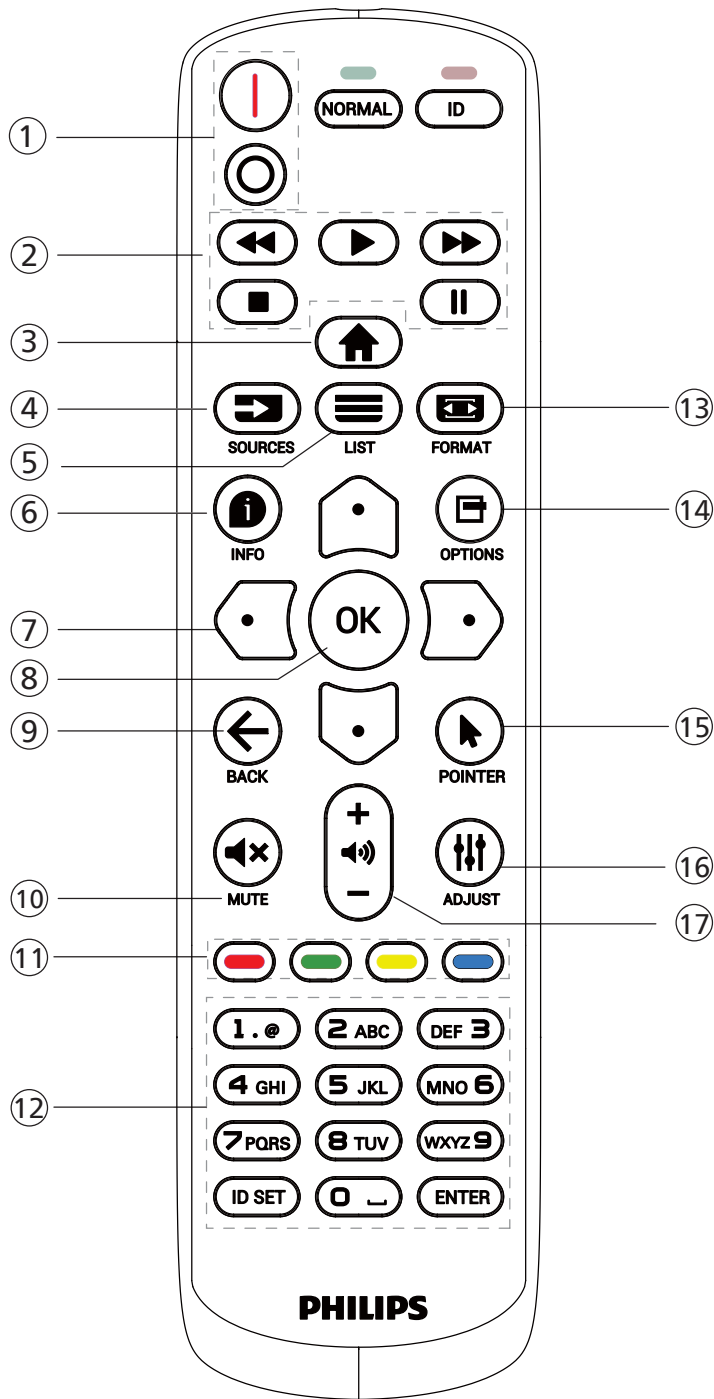

#### ① [I/O] POWER button

Turn the display On or standby mode.  
The button is only controlled by Scalar.

#### ② [PLAY] buttons

1. Control playback of media (video/audio/picture) files.  
There are 4 ways to play the media files.

1) File Manager

Find the media file from the File Manager and select it to play.

2) Media Player -> Compose -> edit or add a new playlist -> choose any media files -> press button to play the media file directly.

3) Media Player -> Play -> choose non-empty play list -> press to play all media files from the playlist.

4) Set media playlist in Boot on Source or Schedule by OSD menu.

2. When playing a video or music file, you can press button to stop playing. If you press again, playback will be started from the beginning of the file.

3. When playing a video or music file, you can press button to pause playing.

4. All media files should be located in the folder of "philips", under the root directory of the specified storage (internal/USB/SD Card). All sub-folders (video/photo/music) are named by media types and shouldn't be changed.

videos: {root dir of storage}/philips/video/  
photos: {root dir of storage}/philips/photo/  
music: {root dir of storage}/philips/music/

Note that the root directories of three storages are

Internal storage: /sdcard

USB storage: /mnt/usb\_storage

SD card : /mnt/external\_sd

#### ③ [HOME] HOME button

Access the OSD menu.  
The button is only controlled by Scalar.

#### ④ [SOURCE] SOURCE button

Select an input source.  
The button is only controlled by Scalar.

#### ⑤ [LIST] LIST button

1. In the content of the web page, move the focus up to the next selectable items.  
2. Move the focus up to the next control or widget such as buttons.

#### ⑥ [INFO] INFO button

1. Display information about the current input signal. It is shown by Scalar.  
2. Media Player -> Compose -> edit or add a new playlist -> choose any media files -> press to show the information of the selected media file.

#### ⑦ [NAVIGATION] buttons

1. Navigate through the menus and select an item.  
2. In the content of the web page, these buttons are for controlling the scroll bar of the screen. Press or for moving the vertical scroll bar up or down. Press or for moving the horizontal scroll bar left or right.

#### ⑧ [OK] button

Confirm an entry or selection.

#### ⑨ [BACK] BACK button

Return to the previous page or exit from the previous function.



⑩ [⏏] MUTE button

Mute or unmute the sound.

The button is only controlled by Scalar.

⑪ [■] [■] [■] [■] COLOR buttons

⑫ [Number/ ID SET/ ENTER] button

ID SET  and ENTER  are reserved on Android source. These buttons are only controlled by Scalar.

⑬ [🖼️] FORMAT button

Change picture format. The button is only controlled by Scalar.

⑭ [☰] OPTIONS button

Open the toolbox from Media Player.

1. Media Player ->Compose -> Edit or add a new playlist -> press  to open a toolbox. The toolbox will slide from the left side of the screen.

⑮ [🖱️] POINTER buttons

Mouse function for Android.

⑯ [⏏] ADJUST button

1. In the content of the web page, move the focus down to the next selectable items.

2. Move the focus down to the next control or widget such as buttons.

⑰ [—] [+] VOLUME button

Adjust volume level. The buttons are only controlled by Scalar.Reserved.

### 3.7. USB Cover

\* Use the USB cover and screws to cover the USB stick and Micro SD card

- Install the USB sticker and micro SD card.
- Use the screw from accessory to fix the USB cover.

Maximum suitable USB stick size: 20(W)x10(H)x80(L) mm

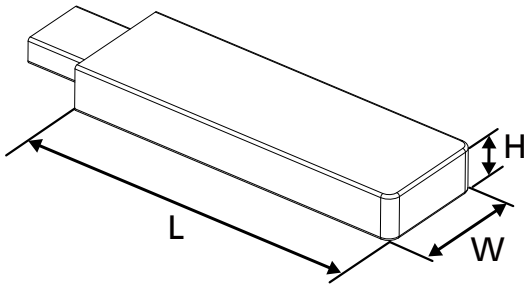

43BDL3452T

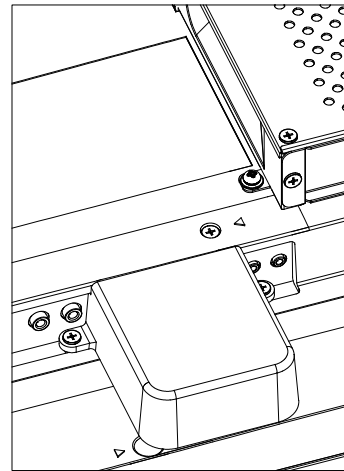
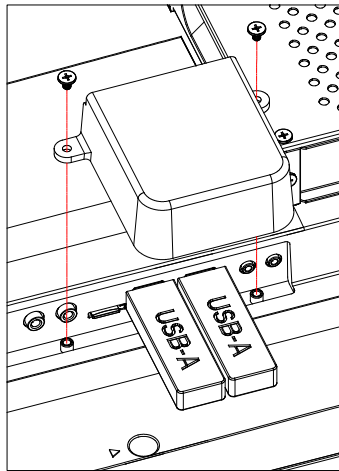
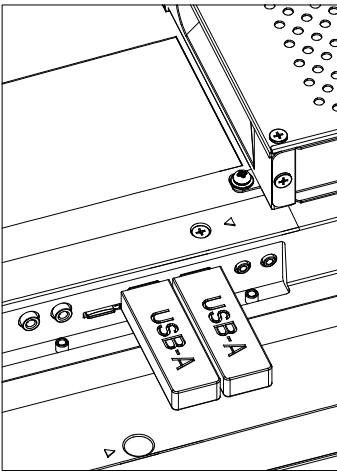

55BDL3452T

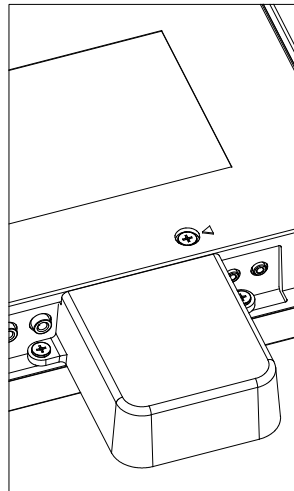
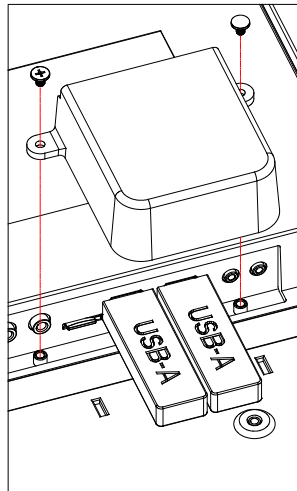
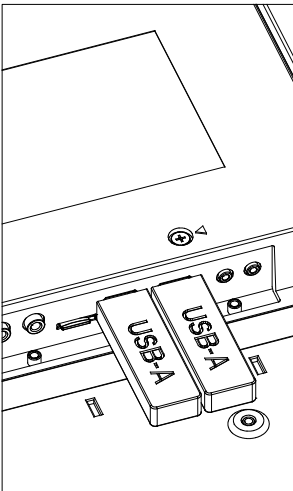



### 3.8. AC Switch Cover

- Use AC Switch Cover to cover the AC switch.
1. Release the screw.
  2. Install the AC Switch Cover.
  3. Fix the AC Switch Cover with the screw in step1.

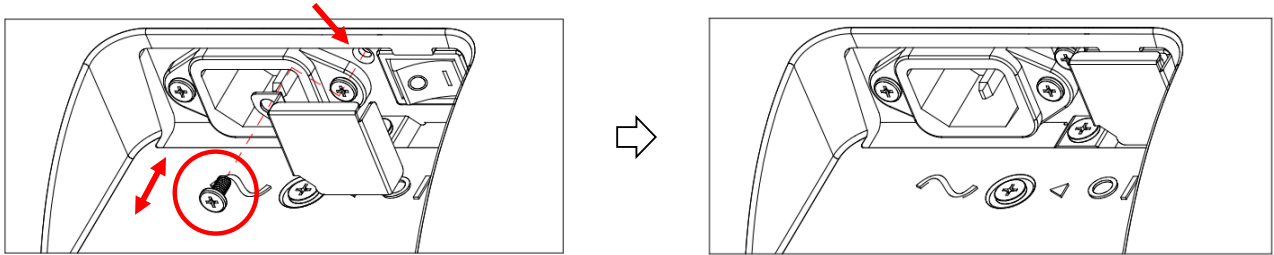

## 4. Connecting External Equipment

### 4.1. Connecting External Equipment (Multimedia Player)

#### 4.1.1. Using HDMI video input

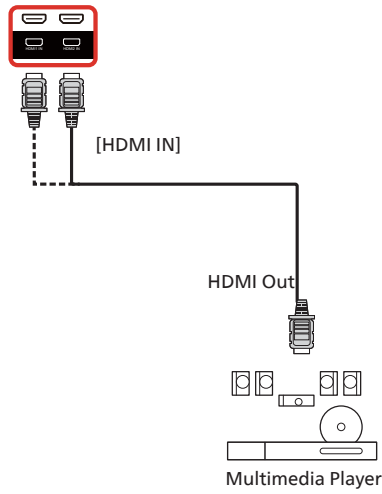

### 4.2. Connecting a PC

#### 4.2.1. Using DVI input

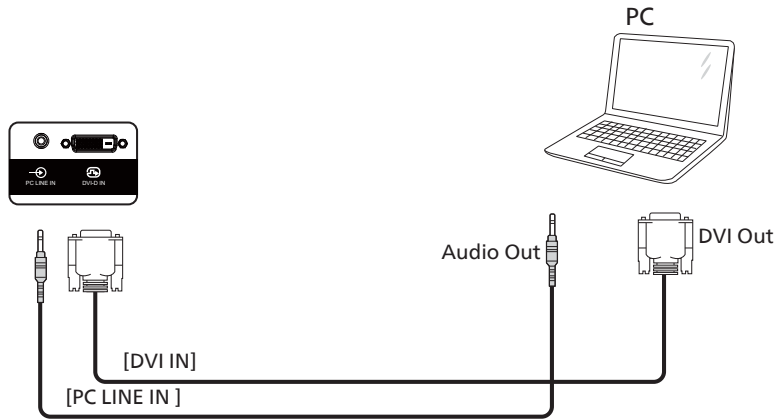

#### 4.2.2. Using HDMI input

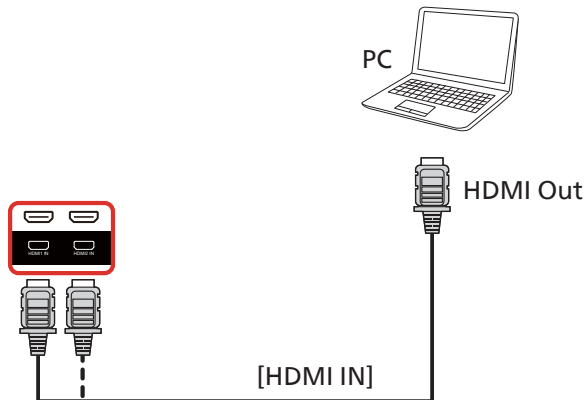

### 4.2.3. Using VGA

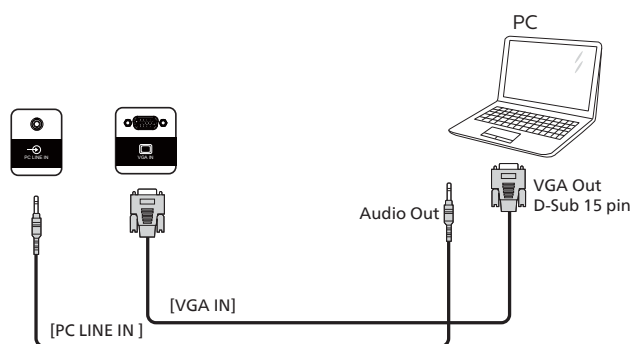

## 4.3. Connecting Audio Equipment

### 4.3.1. Connecting an external audio device

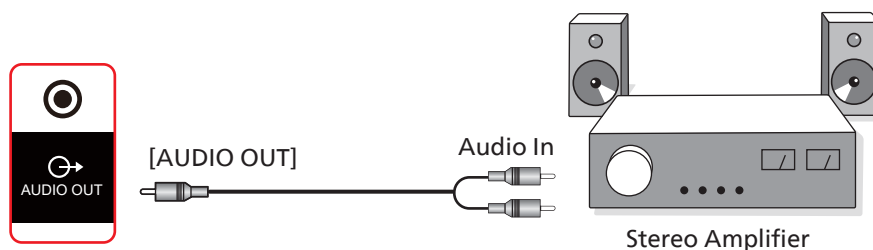

## 4.4. Connecting Multiple Displays in a Daisy-chain Configuration

You can interconnect multiple displays to create a daisy-chain configuration for applications such as a menu board.

### 4.4.1. Display control connection

Connect the [RS232 OUT] connector of DISPLAY 1 to the [RS232 IN] connector of DISPLAY 2.

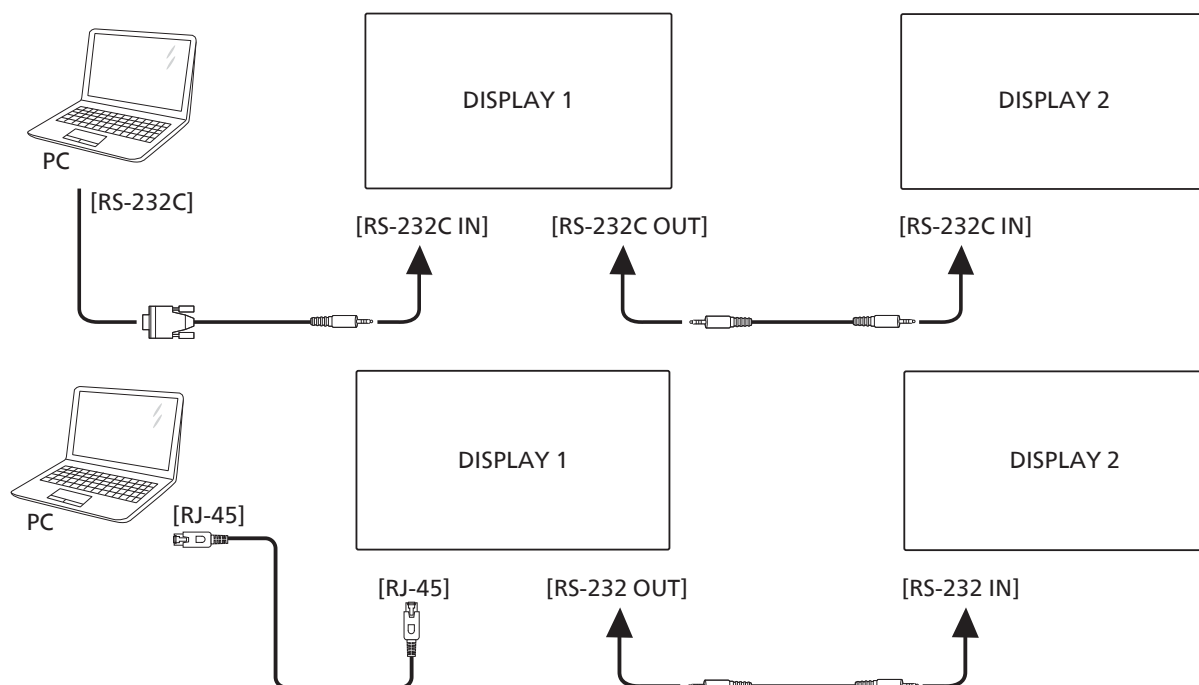

### 4.5. IR connection

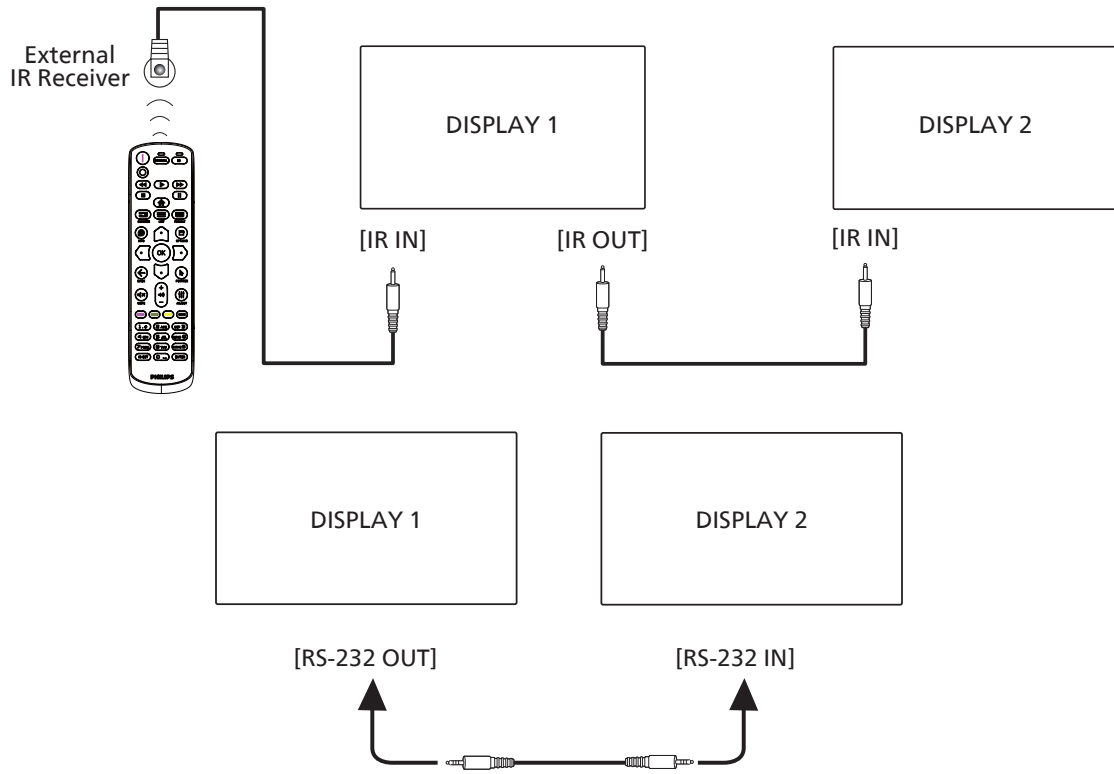

**NOTE:**

1. The remote control sensor of this display will stop working if the [IR IN] is connected.
2. IR loop through connection can support up to 9 displays.
3. IR in daisy chain via RS232 connection can support up to 9 displays.

### 4.6. IR Pass-through Connection

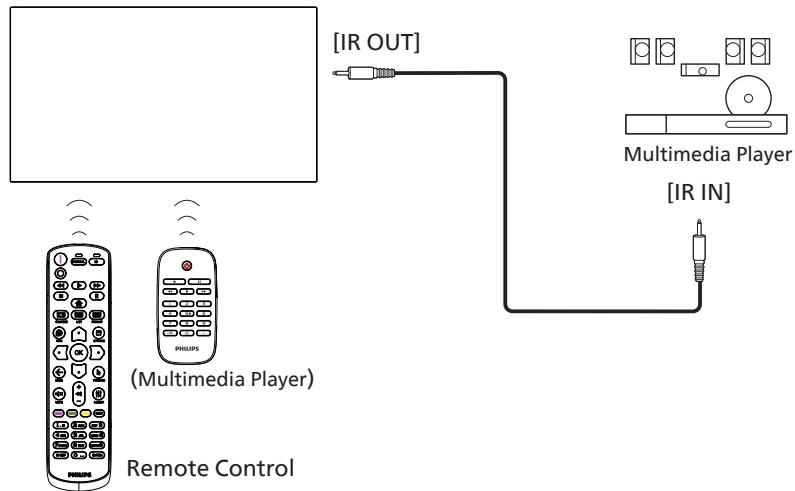

## 4.7. Touch Operation

This display is equipped with a touch-sensitive screen and supports the Windows Touch features either by single touch or multitouch operation. You can touch the pictures or text on the display gently with your fingers, and the system will react.

This section explains about the touch operation on the display. For further detail on how to run the touch operation, please refer to the Windows operation instruction.

### Single Tap

Touch the target on the screen with one fingertip for one quick tap, then release.

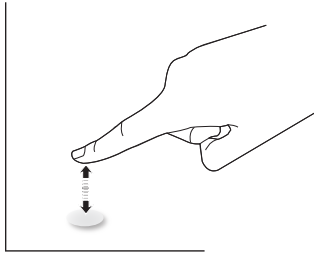

Please note that a touch screen will respond to a light touch from your fingertip when tapping within 2.5mm above touch screen.

### Double Tap

Touch the target on the screen with one fingertip for two quick taps, then release.

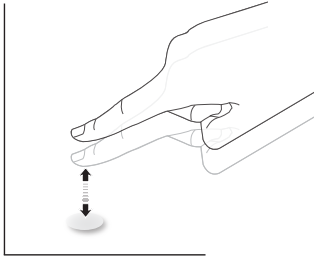

### Pan

Touch the target on the screen with one fingertip and move across the target without losing direct contact, then release.

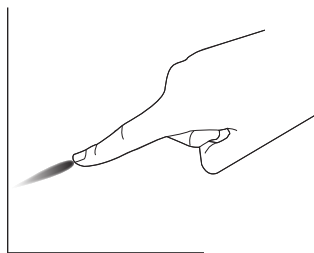

### Flick

Touch the target on the screen with one fingertip and brush the surface quickly.

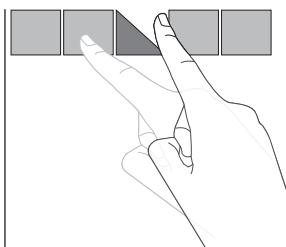

### Zoom in

Touch the target on the screen with two fingertips held together and move them apart to zoom in (magnify) the screen image.

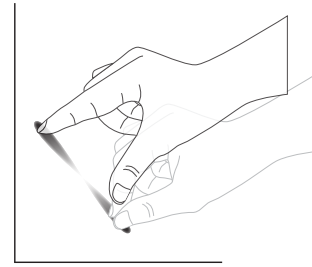

### Zoom out

Touch the target on the screen with two fingertips stretched apart and move them closer to zoom out (shrink) the screen image.

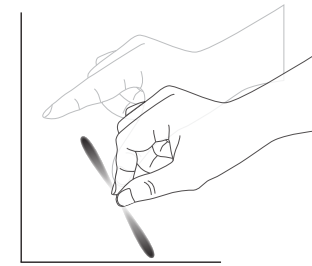

### Touch and Hold

Touch and hold the target on the screen with one fingertip for a while to display a context menu or options page for an item.

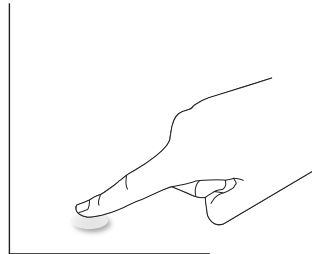

### Avoid

- Avoid scratching with sharp object on the screen. Only use your fingertips to perform touch operation.
- Do not expose the screen to intensive light, spotlight, or wide-spread light.
- Do not install the product to a location where is close to the windows or glass-doors as the direct sunlight may affect the touch-control performance.
- To avoid screen interference with each other, do not place 2 touch screens side by side as shown below.

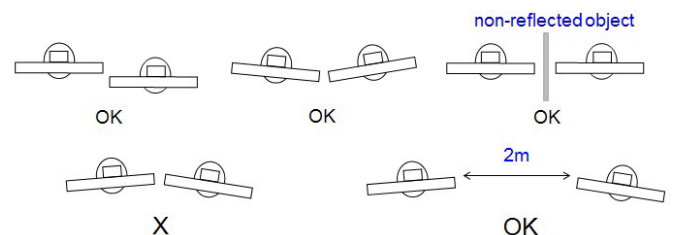

Fig. Touch screens interference

The Touch screen does not require a device driver installed on the host computer for Windows OS. For Windows 7 and Windows 8, it is recommended that the standard Microsoft Window Control Panel calibration is used.

Item	Description		
Operating Systems Supported by Plug-and-Play	Windows 7, 8/8.1, 10		
Supported Modes of Operation by the Operating System	OS	Single Touch	Multi Touch
	Windows 7, 8/8.1, 10	O	O*
	Mac OSX before (include) 10.15	O	O**
	Mac OSX after (include) 10.10	O	O**
	Chrome 38+	O	O***
	Android 4.0, Kernel after (include) 3.6	O	O****
	Linux	O	O*****
	* Support 20-point touch. ** Mac OSX for multi touch from version 10.6 to 10.15, please download "UPDD". *** Chrome for multi touch can support up to 16-point. **** Support up to 16-point. ***** Support 20-point by Ubuntu 14.04 or above with kernel 4.4.0+.		

1. We highly recommend that you use the latest Service Pack with all Windows 7 OS.
2. Digitizer input to Windows refers to touch digitizer as opposed to touch stylus in tablet PCs.
3. Set as default by Microsoft.

## 5. Operation

Note: The control button described in this section is mainly on the remote control unless specified otherwise.

### 5.1. Watch the Connected Video Source

1. Press the [SOURCE] button.
2. Press [HOME] or [SELECT] button to select a device, then press [OK] button.

### 5.2. Change Picture Format

You can change the picture format to suit the video source. Each video source has its available picture formats.

The available picture formats depend on the video source:

1. Press [FORMAT] button to select a picture format.
  - PC mode: {Full} / {4:3} / {Real} / {21:9} / {Custom}.
  - Video mode: {Full} / {4:3} / {Real} / {21:9} / {Custom}.

### 5.3. Launcher

Launcher:

- You can press "Source" and select "Home" to startup it.
- Multiple Home shortcut items can be added to the Launcher.

The Launcher consists of the following Apps:

"Whiteboard", "Present" and "Apps".

Whiteboard: go to whiteboard page.

Present: go to interact page.

Apps: show all apps.

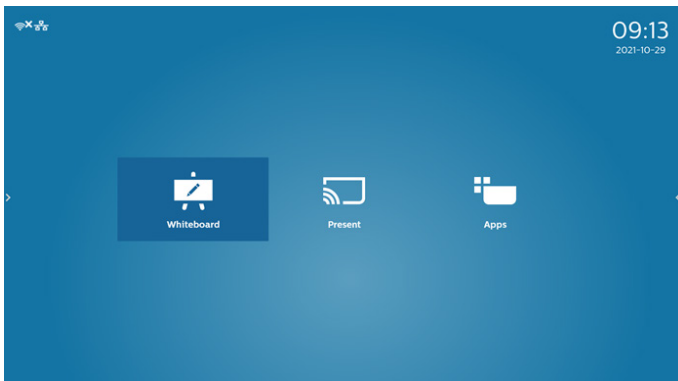

Add multiple home shortcuts to the homepage:

Settings -> Signage Display -> General settings -> Home shortcut.

Home shortcut	App	Whiteboard
Whiteboard	App	Whiteboard
Present	App	Interact
Apps	App	All Apps
Conference	App	
Shortcut 1		
Shortcut 2		
Shortcut 3		
Shortcut 4		

2) Whiteboard page:

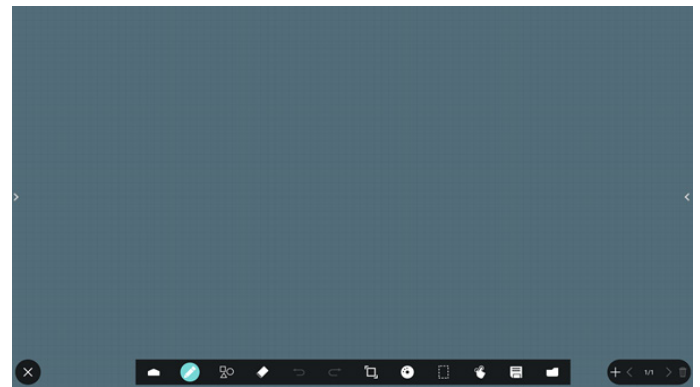

3) Present page:

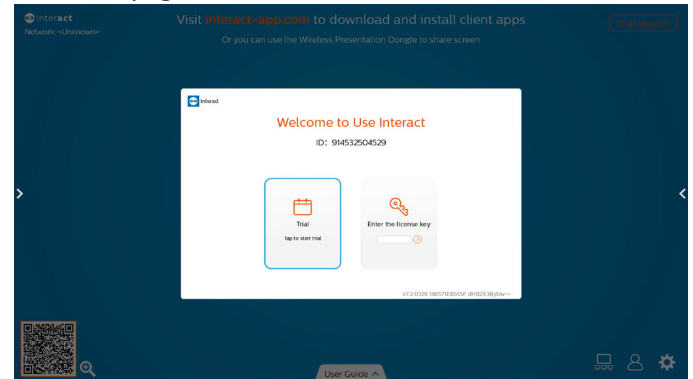

4) Apps page:

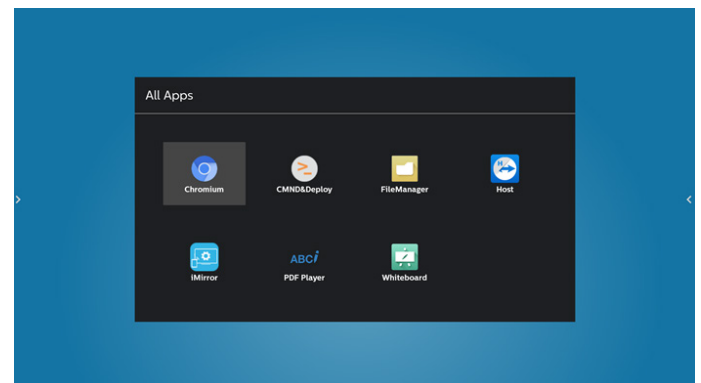

## 5.4. Media Player

### 5.4.1. OSD menu interaction with media player:

1. Boot on source:
  - Input:
    - If you select Media player as the source, the system will enter media player automatically after the boot process is completed.
  - Playlist:
    - 0: go to the main page of media player.
    - 1 - 7: go to media player and playback File1 - File7 of playlist automatically.
2. Schedule:
  - Today:
    - Show date and time.
  - 1 - 7:
    - Set up to 7 schedules.
  - On/Off:
    - Set start time and end time.
  - Input:
    - Select Media player as the source, the PD will launch the media player automatically at end time.
  - MON, TUE, WED, THU, FRI, SAT,SUN, Every week :
    - Set life cycle.
  - Play list :
    - 0: go to the main page of media player.
    - 1 - 7: go to media player and playback File1 - File7 of the playlist automatically.
  - Clear all

### 5.4.2. Media Player introduction:

1. Main page of Media Player app, this App consists of three items: "Play", "Compose" and "Settings".  
 Play: select a playlist to play.  
 Compose: edit playlist.  
 Settings: set play properties.

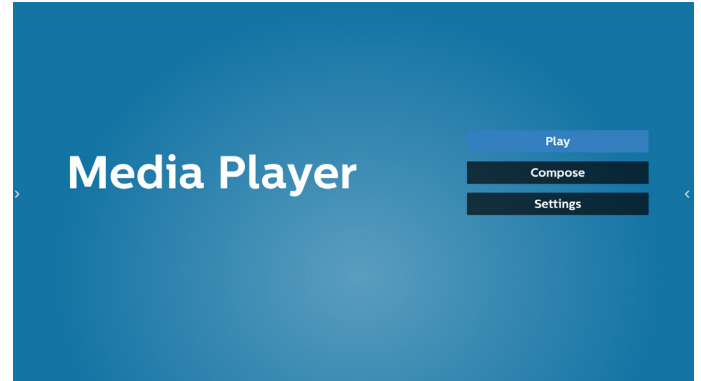

2. Select "Play" on the main page, first you should choose one playlist to play between FILE 1 and FILE 7. The pencil icon means the playlist is non-empty.

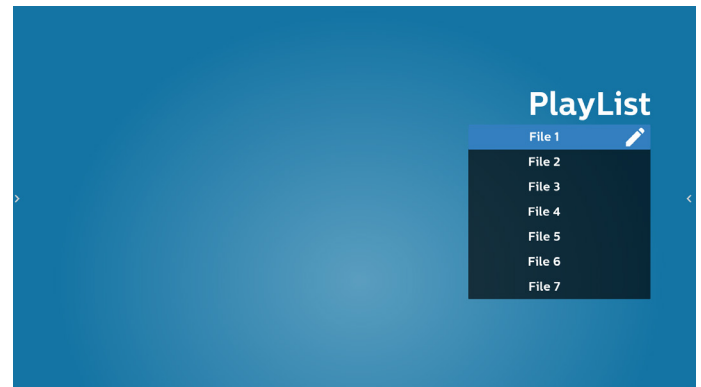

3. Select "Compose" on the main page, first you should choose one playlist to edit between FILE 1 and FILE 7. The pencil icon means the playlist is non-empty.

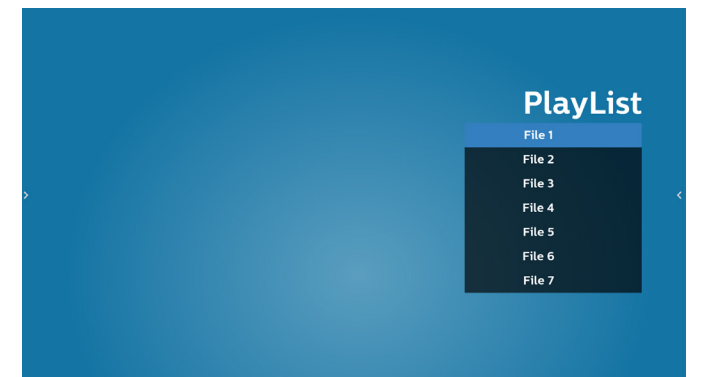

4. If an empty playlist is chosen, the app will guide you through selecting the media source.  
 All media files should be placed in /philips/ of root directory.  
 For example,
  - videos in /philips/video/
  - photos in /philips/photo/
  - music in /philips/music/



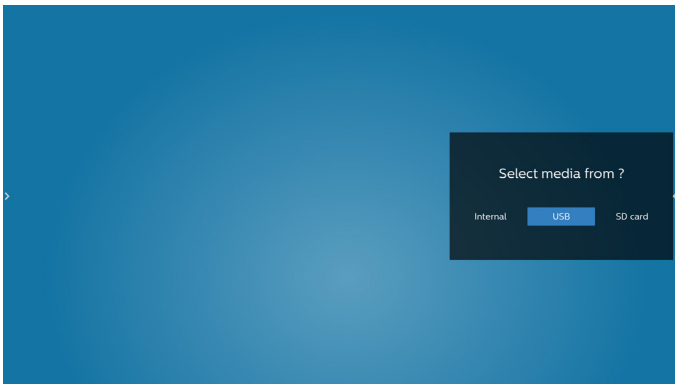

5. If you select "USB" storage, the app will guide you through selecting the USB device.

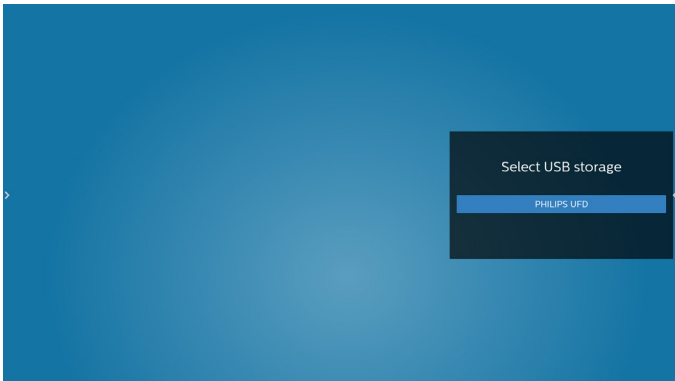

6. To edit or delete a non-empty playlist, select the desired playlist that shows a pencil icon on right side of the file.

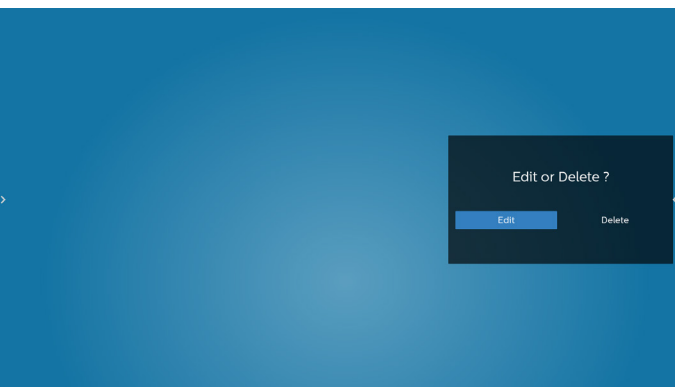

7. Once you start to edit a playlist, a menu is displayed as below:
- Source - files in storage.
  - Playlist - files in playlist.
  - Option - launch sidebar.
  - Play - play media file.
  - Info - show media info.
  - Touch file - select/unselect file.

Note: When long press on one of the directory in Source, full path will be displayed.

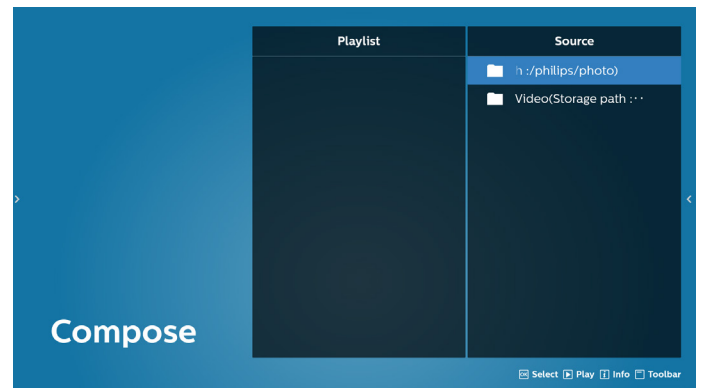

- 7.1 In the sidebar, the following functions are available:
- Select all: select all storage files.
  - Delete all: delete all playlist files.
  - Add/Remove: update playlist from source.
  - Sort: sort playlist.
  - Save/abort: save or abort playlist.
  - Back: return.

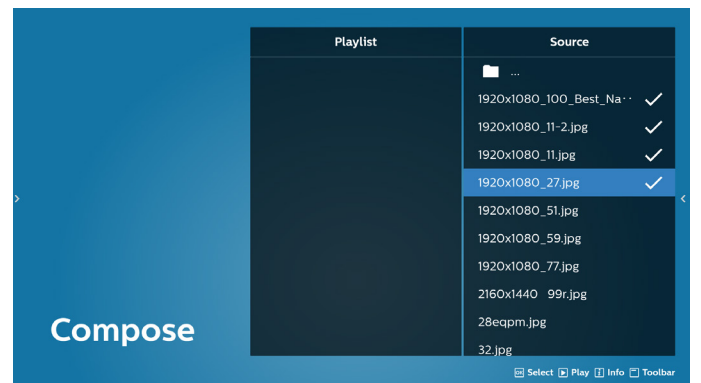

8. If "Sort" is selected, you can customize the file order severally.

Note: When leaving from this page, all data will be saved automatically.

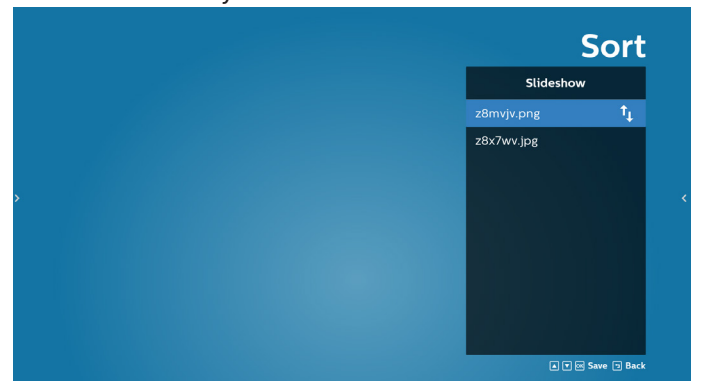

9. After selecting the desired file, press "Info" key to get detailed information.



10. After selecting the desired file, press “Play” key to play the media file immediately.



11. If you created a playlist with all image files, you will be asked to add a background music to the slideshow before saving.

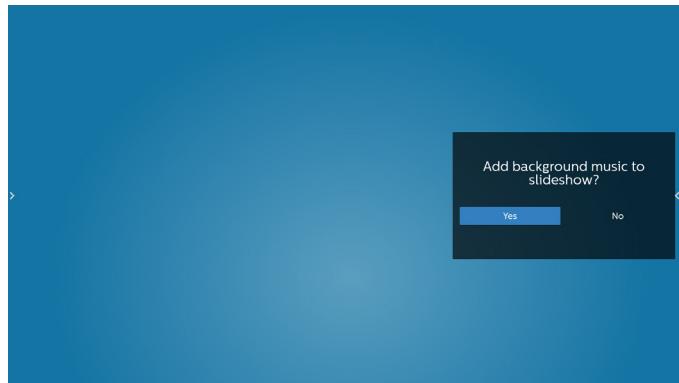

12. Select “Settings” in the main page, there are five options available: “Repeat Mode”, “Slideshow Effect”, “Effect Duration”, “Software Decode” and “Autoplay”.

- Repeat Mode:** select repeat once or repeat all.
- Slideshow Effect:** photo slideshow effect (right to left, fold corner or none).
- Effect Duration:** photo effect duration (5 seconds, 10 seconds, 15 seconds or 20 seconds).
- Software Decode:** no black screen between videos play (enable, disable).
- Autoplay:** Plug in the USB and it will automatically play files from USB root path. (enable and disable autoplay, photo only, video only, photo and video, help).

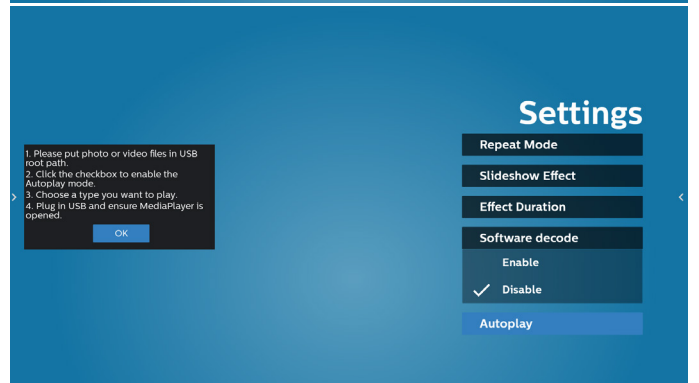
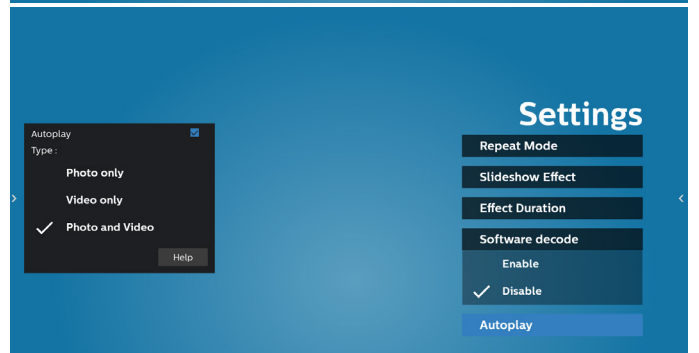
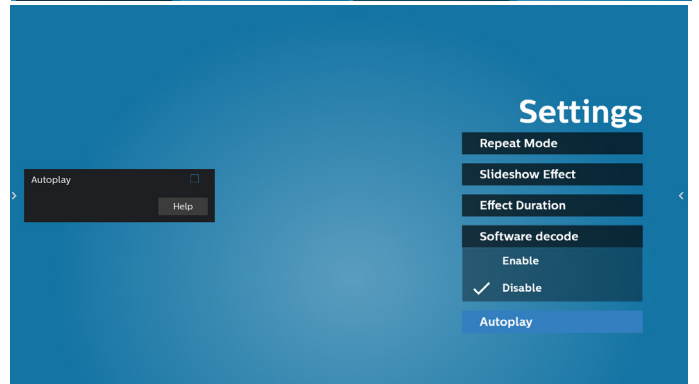
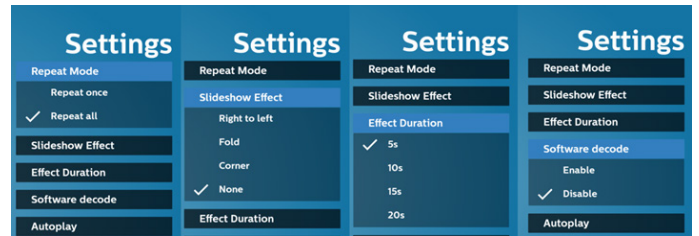

### 13. Media Player import text file

Step 1. Create media player text file.

- File name : mpplaylistX.txt, "X" means playlist number(1,2,3,4,5,6,7).

Ex. mpplaylist1.txt, mpplaylist2.txt

- Content :

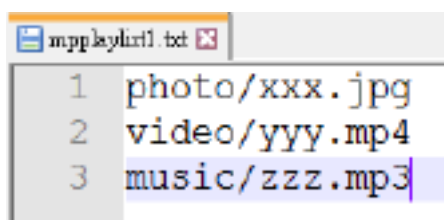

Note: If the playlist contains video and music files, the screen becomes black when playing music file.

Step 2. Copy "mpplaylistX.txt" to "philips" folder of internal storage. You may use FTP to do this.

- File path : /storage/emulated/legacy/philips (for DL, PL)

Ex. /storage/emulated/legacy/philips/mpplaylist1.txt

Step 3. Prepare media files to "photo", "video" and "music" folder under "philips" folder, internal storage only.

- Ex. /storage/emulated/legacy/philips/photo/xxx.jpg  
/storage/emulated/legacy/philips/video/yyy.mp4  
/storage/emulated/legacy/philips/photo/zzz.mp3

Step 4. Start media player app, it will automatically import media player text file.

Note: Once the playlist file (text) is imported, if user changes playlist via remote control, this change will not be written on playlist text file.

## 5.5. CMND & Play

1) Server

Setup CMND & Play server address

2) Account

Setup CMND & Play account

3) PIN Code

Setup CMND & Play PIN code

(4) Version

There are two options, Ver.2 and Ver.3

Ver. 2

use 2.0/2.2 agreement

Ver. 3

use 3.0/3.1 agreement

(5) Content

There are 3 options available: internal storage, SD card and USB storage.

If Ver.2, is selected, Server/Account/PIN code will be shown in gray and cannot be set.

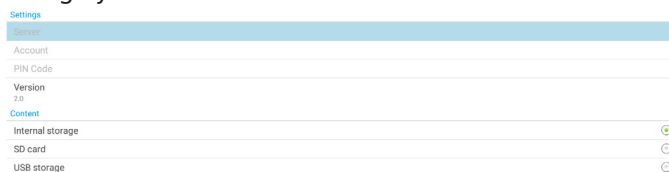

## 5.6. Side Bar

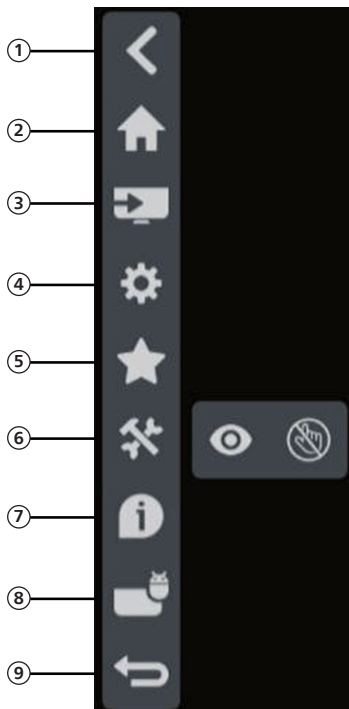

- ① **Hide**  
Hide side bar.
- ② **Home**  
Open Home.
- ③ **Source menu**  
Open source menu.
- ④ **OSD Menu**  
Open OSD menu.
- ⑤ **My Favorite**  
Open my favorite, add or remove frequently used APK.
- ⑥ **Tool**  
(6-1) Freeze/Unfreeze: Only freeze/unfreeze the signal screen of non-Android, the audio signal is still alive.  
(6-2) Touch Lock: Lock the touch function, you need to input password to unlock it after the touch lock is enable.  
The default password is 123. You also can set the new password in Settings -> Signage Display -> System tools -> Touch lock password.
- ⑦ **Quick info**  
It will display the information of Time, Network and Monitor Information.
- ⑧ **History**  
Show history app.
- ⑨ **Back**  
Return to the previous page or exit from the previous function.

## 6. Setting UI

### 6.1. Settings

Setting menu consists of the following items:

- (1).Network & Internet
- (2).Signage Display
- (3).Apps
- (4).Display
- (5).Security
- (6).System

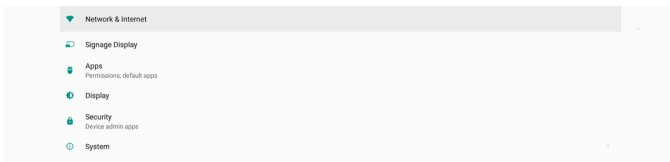

#### 6.1.1. Network & Internet

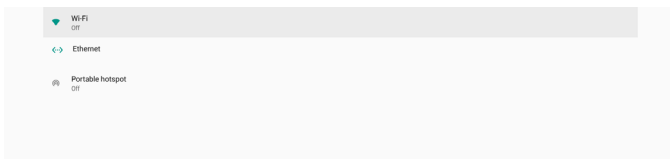

##### 6.1.1.1. Wi-Fi

Settings -> Network & Internet -> Wi-Fi

Important Note: This option is available only when the supported Wi-Fi dongle is plugged. Wi-Fi dongle hot spot is however not supported. Reboot the device whenever you plug or remove the USB Wi-Fi dongle.

##### Enable Wi-Fi

Enable/disable Wi-Fi connection through main switch in Setting -> Network & Internet -> Wi-Fi -> Off/On toggle button.

##### Wi-Fi Off

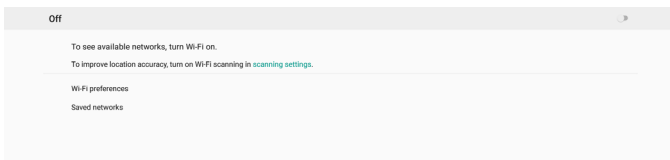

##### Wi-Fi On

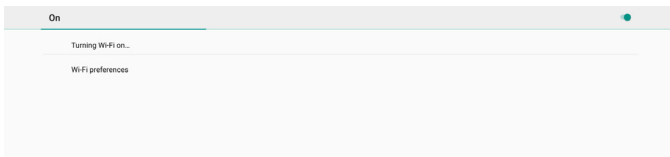

On the available network list, select an AP (access point) on an existing wireless network.

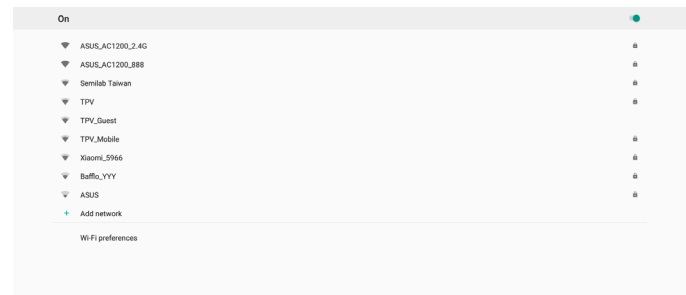

Enter the required settings.

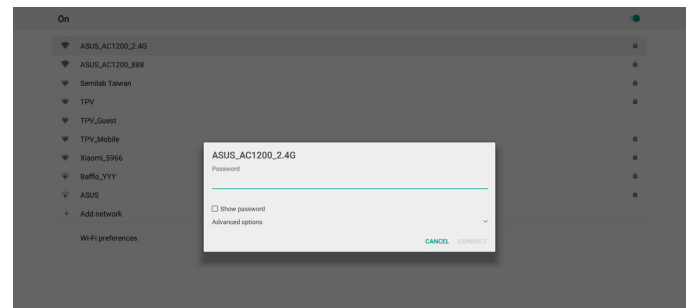

At the bottom of the list, select "Add network" to add a network not shown on your list.

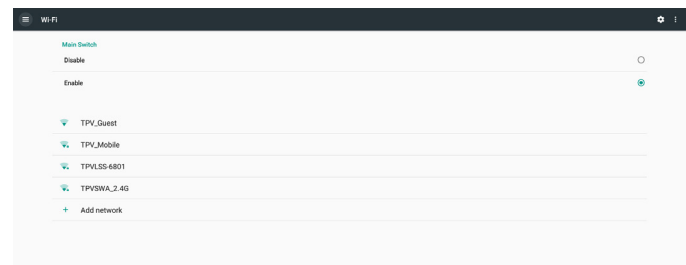

If needed, enter the network name (SSID) and security details.

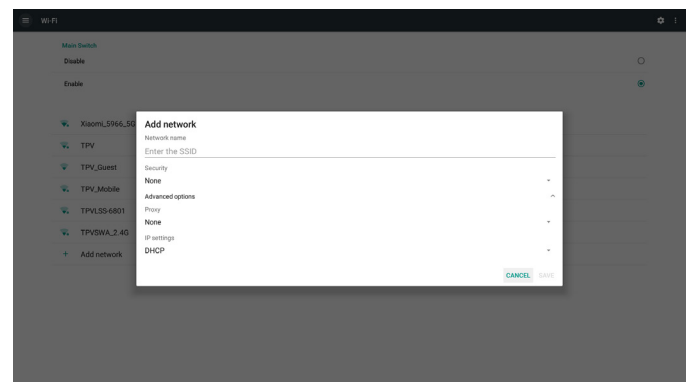

Note:

When Wi-Fi is enabled, Ethernet will be disabled automatically.

## Wi-Fi Preference

Settings -> Network & Internet -> Wi-Fi -> Wi-Fi Preference

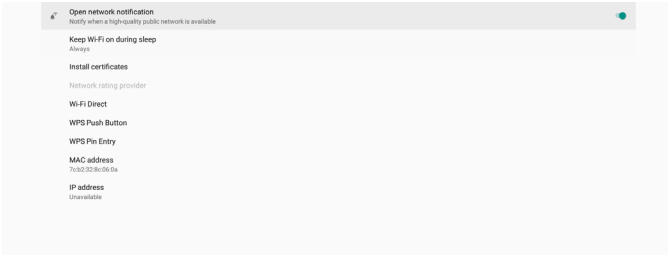

### Using WPS

WPS network can be enabled using 2 options:

PBC (Push Button Configuration), in which the user simply has to push a button to connect.

PIN (Personal Identification Number), in which a PIN will be entered in client WPS device to connect.

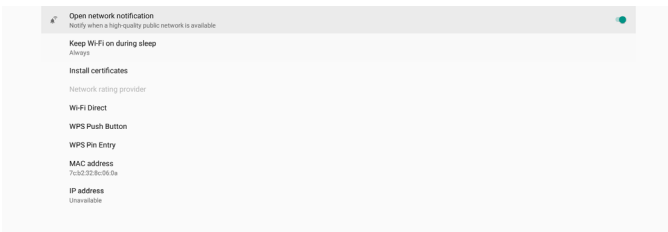

When using PBC method, select "WPS Push Button" to connect.

When using PIN method, select "WPS Pin Entry" and enter the PIN to connect.

### Wi-Fi Network Information

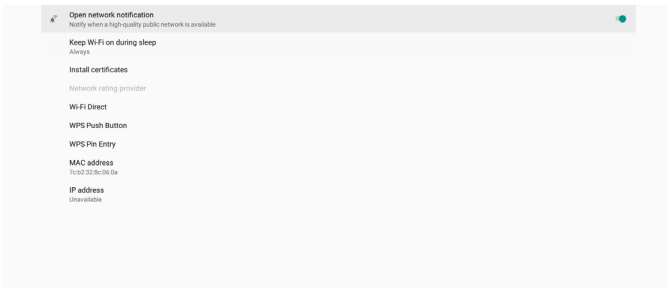

MAC address: shows Wi-Fi MAC address.

IP address: shows the IP address when the device joins a network.

### 6.1.1.2. Ethernet

Settings -> Network & Internet -> Ethernet

#### Enable Ethernet

Enable/disable Ethernet connection by Setting -> Network & Internet -> Ethernet toggle button.

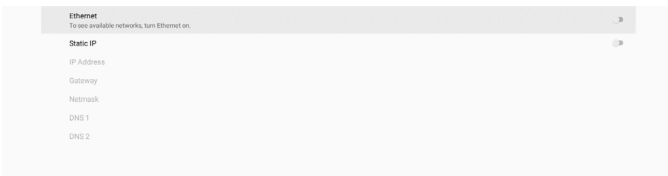

By default, the system uses DHCP to join the network.

Connection Information (When the options are grayed out, they are not editable).

- (1).IP Address
- (2).Gateway
- (3).Netmask
- (4).DNS 1/2 IP Address

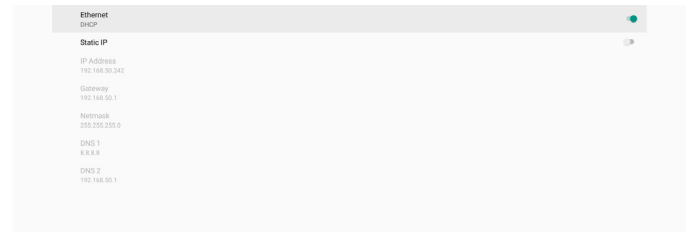

Note:

Wi-Fi connection will be disabled automatically when Ethernet connection is enabled.

#### Ethernet Static IP

User can manually set Ethernet IP address, Netmask, DNS address and gateway IP address when toggle "Static IP".

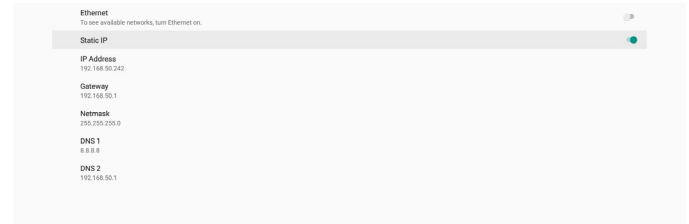

Then toggle Ethernet button again.

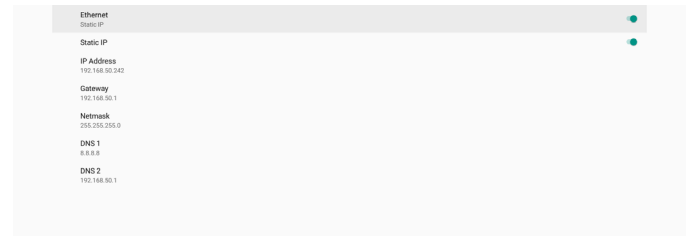

Note:

1. Please input IPv4 address in all fields; in dot-decimal notation, consisting of four decimal numbers, each ranges from 0 to 255, separated by dot.
2. User must input all fields for static IP connection before enabling Ethernet again.

## 6.1.2. Signage Display

Settings -> Signage Display, to setup most features of signage display. See below for more detailed information about Signage Display settings.



### 6.1.2.1. General Settings

Settings -> Signage Display -> General Settings Set up Signage Display name, User logo, Screenshot, Navigation bar and Home shortcut.



#### Signage Display Name

Settings -> Signage Display -> General Settings -> Signage Display Name

Set up Signage Display name, the default name is Ethernet MAC address with prefix "PD\_". For example, "PD\_000b12223398". The maximum length of name is 36 characters in UTF8 format. Click to rename it.

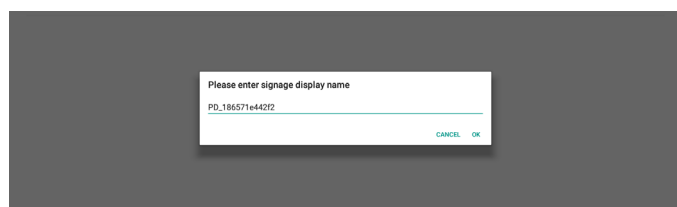

#### Boot Logo

Settings -> Signage Display -> General Settings -> Boot Logo  
User can set up device boot up logo (boot animation) when OSD Menu -> Configuration 2 -> Logo is set to "User" mode.

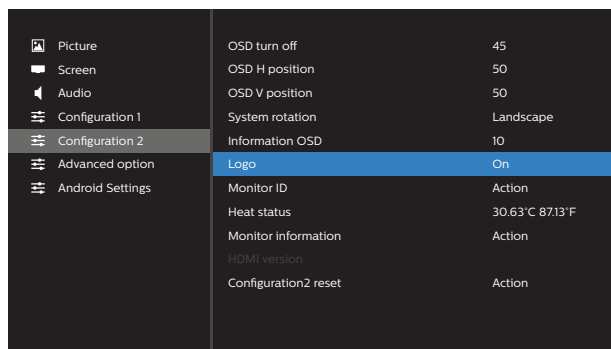

If "Logo" is not set to "User" mode, user cannot select custom boot animation.



When it is set to "User" mode, the option "Choose Boot Animation" becomes available.

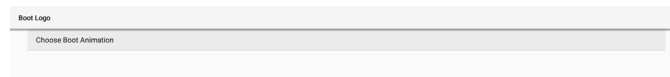

When Logo is set to "User" mode, the default Philips logo will be replaced by user selected boot animation file.

Click "Choose Boot Animation" and a pop-up menu appears for user to select boot animation file. Content saved on a SD card or USB memory card will be scanned automatically.

Boot animation file name must be set as "bootanimation.zip", any other format is invalid.

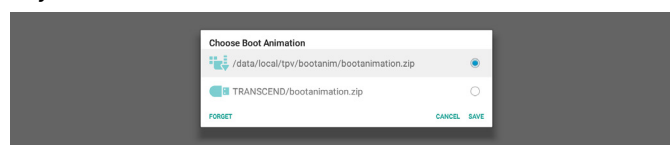

All available boot animation files can be found in the following folder:

1. File under /data/local/bootanimation/:  
The boot animation file that are copied from USB or SD card.
2. File under {SD\_STORAGE\_VOLUME\_NAME}/:  
The boot animation file saved on the SD card.
3. File under {USB\_STORAGE\_VOLUME\_NAME}/:  
The boot animation file saved on the USB storage.

#### Dialog options:

1. FORGET  
Clear "bootanimation.zip" under /data/local/bootanimation/.  
Custom boot animation will not be used during system boot up.
2. CANCEL  
Cancel and close the dialog box.
3. SAVE  
Copy selected file to /data/local/bootanimation/. After doing this, user can remove their external storage (USB and SD). System uses the boot animation file under /data/local/bootanimation.

If system does not found any bootanimation.zip file under external storage (USB, SD) and /data, the file list is empty. The "SAVE" and "FORGET" buttons are grayed out, user should check content saved on the USB memory or SD card. Click "CANCEL" button to close the dialog box, and plug in the USB memory or SD card again.

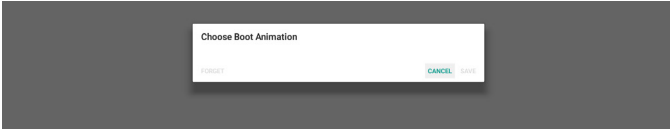

If /data/local/bootanimation/ folder is empty, it means that "bootanimation.zip" has not been saved before by user. Default Philips logo appears during system boot up.

When "bootanimation.zip" is found under external storage, a dialog box of the file list will appear.

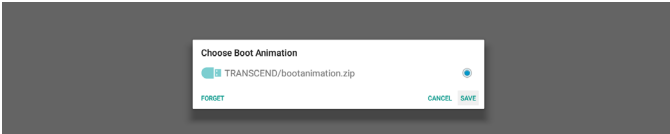

If the file "bootanimation.zip" can be found in the folder "/data/local/bootanimation/", the pop-up dialog box will show that file as the first option. It simply means that user has previously copied (saved) the file "bootanimation.zip" and that the system will boot up with boot animation from /data/local/bootanimation/bootanimation.zip.

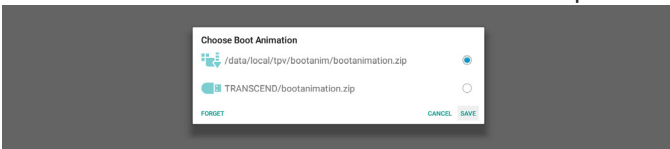

Boot animation file can be replaced by using the "SAVE" button.

### Screenshot

Settings -> Signage Display -> General Settings -> Screenshot  
To capture the screenshots from the imported content, click "Enable" to enable the auto screenshot function. If the screenshot options are shown in gray, it means that the screenshot function is not enabled yet.

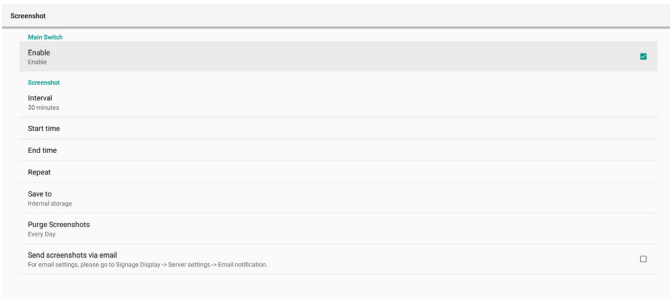

After enabling this feature, you can set the interval time between each screenshot, as well as the destination folder where the captured screen will be saved. The option "Save to" notifies you that the screenshot images will be saved in the internal storage and they cannot be changed manually.

#### NOTE:

- The screenshot images will be deleted automatically under the following conditions:
  - When the start time of screenshot feature is set to 0 second.

(2). Starting the screenshot at 40 seconds of minute.

(3). If you decide to purge the screenshot photos every week, the data of deleting the photos will be changed to the day that you apply the setting of screenshot feature. For example, if you set the purging day to Monday of every week, then changed other settings in screenshot feature on Friday, the purging day will be changed to Friday (the day of system's current time).

- Sleep (system suspend) and screenshot feature:  
The screenshot feature is suspended when the system enters sleep mode. The function of mailing out the screenshot is consequently suspended. The screenshot-related features will be restarted when the system enters active mode.

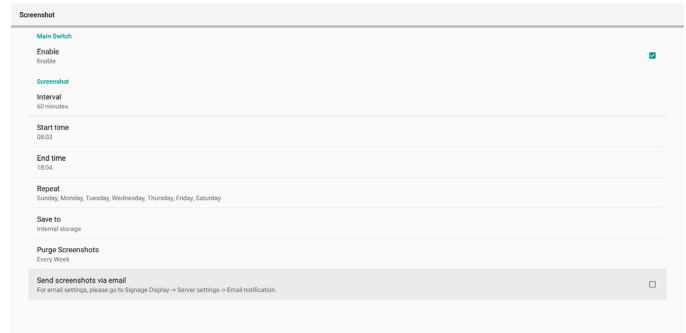

#### (1). Interval

Set the interval time between each screenshot. The available options are 30 and 60 minutes.



#### (2). Start Time

Set the start time of a day to begin the screenshot function. Make sure that you click the "Save" button before leaving the dialog box, or your settings will not be saved. The start time must be set at an earlier time than the end time. A toast message will appear notifying you if it is an invalid value.

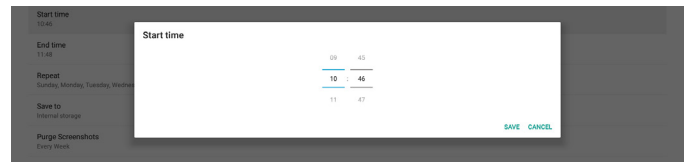

#### (3). End Time

Set the end time of a day to end the screenshot function. Make sure that you click the "Save" button before leaving the dialog box, or your settings will not be saved. The start time must be set at an earlier time than the end time. A toast message will appear notifying you if it is an invalid value.

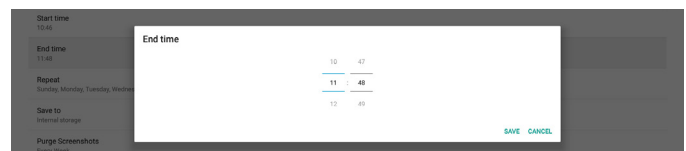

#### (4). Repeat

Set the repeat mode for auto screenshot.



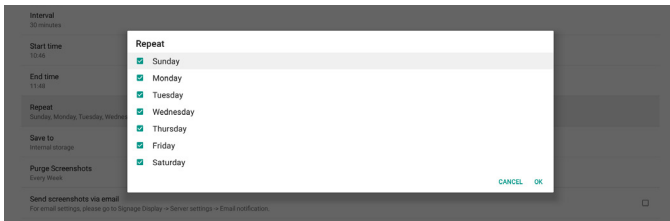

#### (5). Save to

The screen images will be saved under the folder named "philips/screenshot" of the internal storage.

#### (6). Purge Screenshots

Set the interval time for deleting the screenshot images. The available options are "Every day" and "Every week".



#### (7). Send screenshots via email

You can send every screenshot image as an e-mail attachment. User must set up mail information first in "Settings -> Signage Display -> Server Settings -> Email notification" (Refer to [Email Notification](#) section).

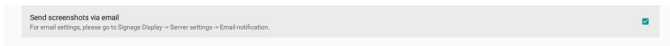

## Navigation bar

Definition support sidebar of source

Android source:

43"/55" Will show sidebar except Kiosk source, and follow the navigation bar setting

External source:

43" /55" Will show sidebar, and follow the navigation bar setting

Definition of option

1. Always on: sidebar will stay on both sides of the screen except external source
2. Always off: sidebar will not appear on the screen
3. Auto hide: sidebar will disappear in 10 seconds

The way to appear after disappearing

A. Gesture swipe from left or right to center, the sidebar will be show on the screen, and disappear again after 10 seconds

B. If source support sidebar, the sidebar will be show on the screen when change source, and disappear again after 10 seconds

Definition of arrows on both sides of the screen

a. click arrows on both sides can open sidebar menu, click the arrow at the top or waiting for 15 seconds, the sidebar menu will be disappear

b. long press arrows on both sides, it can move the sidebar position

## Home shortcut

Add APP/ Source shortcut to the Home launcher.



## 6.1.2.2. Server Settings

Settings -> Signage Display -> Server Settings

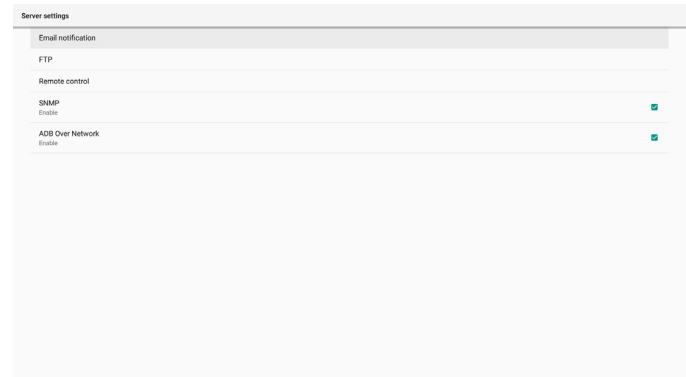

## Email Notification

Settings -> Signage Display -> Server Settings -> Email Notification

Click checkbox to enable/disable E-mail notification feature. Set SMTP and manager E-mail after enabling the E-mail notification feature.



## SMTP

Setup sender E-mail address and SMTP server information. There are two types of SMTP server for user to set up: "Gmail" and "Other". By using "Other" option, user can manually setup SMTP server, security type and server port.

Note:

1. The password should be in UTF8 format with 6 to 20 characters.
2. User cannot set port 5000 (SICP default port) and 2121 (FTP server default port).  
SICP network port setting in "Settings -> Signage Display -> Network Application -> SICP network port".  
FTP network port settings in "Settings -> Signage Display -> Server settings -> FTP -> Port".

Gmail: (SMTP server, Security type and Port are grayed out)

Other:

## Gmail Security Settings

If a problem occurs when sending the e-mail via Gmail, please visit Google website "https://www.google.com/settings/security/lesssecureapps" for checking the security setting of your Google Account. Then turn on "Access for less secure apps".

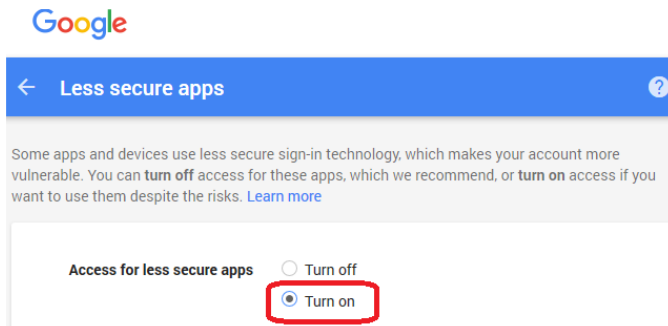

## Manager Email

Specify the destination address to receive the e-mail.

## Test

To check if your e-mail settings are correct or not, select 'Send Test Mail' to send a test e-mail.

## FTP

Settings -> Signage Display -> Server Settings -> FTP

Click the checkbox to enable/disable FTP server feature. After enabling this feature, user can setup account, password and port number.

- (1). Account: The user name to log in the FTP server. The length of the account name should be ranged from 4 to 20 characters, only [a-z], [A-Z] and [0-9] are allowed to use.
- (2). Password: The password to log in the FTP server. The length of the password should be ranged from 6 to 20 characters, only [a-z], [A-Z] and [0-9] are allowed to use. The password are covered by asterisks after setting.
- (3). Storage path: The FTP server has access to the internal storage only. The storage path is unchangeable.
- (4). Port: The port number for FTP server. Available port number ranges from 1025 to 65535, the default setting is 2121. The following port number cannot be used: 8000 / 9988 / 15220 / 28123 / 28124 and SICP network port (default 5000).

Finally, manually reboot the system to apply FTP settings.

## Remote Control

Settings -> Signage Display -> Server Settings -> Remote Control

Click the checkbox "Enable" to enable or disable the remote control client service. The default setting is "Enabled". To use the remote control feature, the device must be bound with the remote control server.

In the entry field of "Server", input the URL address with the prefix of "https://". If the device is not bound with the remote control server, please enter the PIN code provided by the server.

**Bind status:**

- (1).If the device does not have appropriate network connection, a message "Network is disconnected" will appear.
- (2).If the device is equipped with network function, but is not connected to the remote control server, a message "Server is disconnected" will appear.
- (3).If a server is connected, but not bound, a message "Server is unbinded" will appear.
- (4).If the device is bound with the server successfully, a message "Server is binded" will appear.
- (5).If the PIN code is not correct, a message "Error PIN code" will appear.

**SNMP**

Enable/Disable SNMP service.

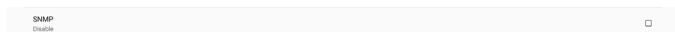

Please refer to the SNMP user manual.

**ADB over Network**

You can access ADB over a network connection with port 5555.

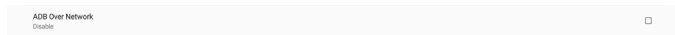
**6.1.2.3. Source Settings****6.1.2.3.1. Android Source**

Settings -> Signage Display -> Source Settings

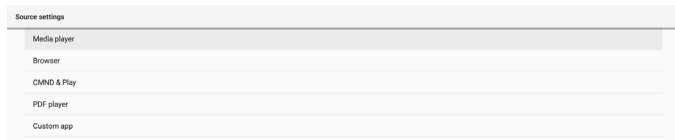

User can configure source APK's detailed options.

**Media Player**

Settings -> Signage Display -> Source Settings -> Media Player  
Open Media Player APK's edit play list activity and edit effect settings activity.

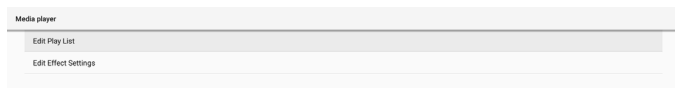
**Browser**

Settings -> Signage Display -> Source Settings -> Browser  
Open Browser APK's bookmark editor activity.

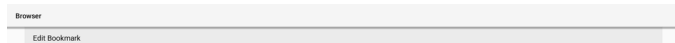
**Kiosk**

Settings -> Signage Display -> Source Settings -> Kiosk  
Open Kiosk APK's bookmark editor activity.

**CMND & Play**

Settings -> Signage Display -> Source Settings -> CMND & Play

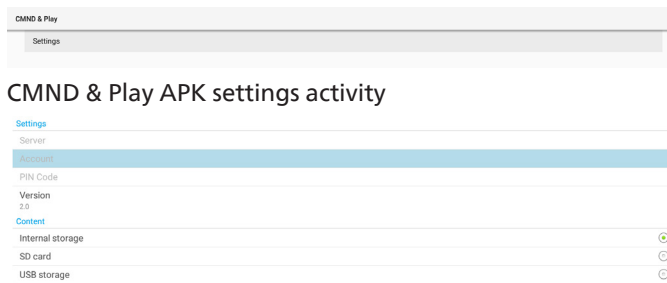

- (1).Server  
Set up CMND & Play Server IP address. Not available in 2.0 protocol.
- (2).Account  
Set up CMND & Play Server account, account format should be [a-z] [A-Z] [0-9]. Not available in 2.0 protocol.
- (3).PIN Code  
Set up CMND & Play PIN code. Not available in 2.0 protocol.
- (4).Version  
Set up CMND & Play server protocol version.
  - (1).2.0: Used for protocol version 2.0/2.2 (default)
  - (2).3.0: Used for protocol version 3.0/3.1 (default when user selects JP language in OOB)
- (5).Content  
CMND & Play APK supports playback content from internal storage (select "Internal Storage") and external storage (select "SD card" or "USB storage"). CMDN & Play APK will search content from the selected storage. The default setting is internal storage.

Please note that external storage cannot be removed (plug-out) when CMND & Play is playing content. In addition, the free disk space of the external storage must be double of the CMS file size for extracting CMS content.

**PDF Player**

Settings -> Signage Display -> Source Settings -> PDF Player  
Open PDF Player APK's edit play list activity and edit effect settings activity.

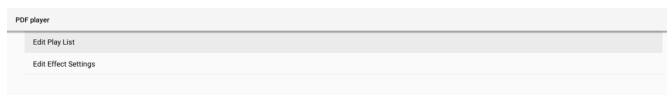
**Custom app**

Settings -> Signage Display -> Source settings -> Custom app  
User can set up customer source APK. The selected APK will be launched when switching into customer input source. If customer source APK is not set, the system shows a black screen when switching to customer input source.  
Default is "CMND&Deploy" APK.

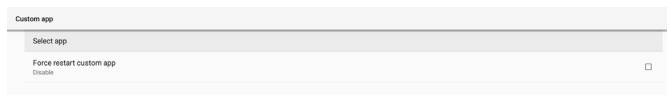

If a custom source APK is set, the APK name will be displayed. Otherwise, it means that the custom App has not been set.

## Select APP

Select a specific APP for custom APP source.

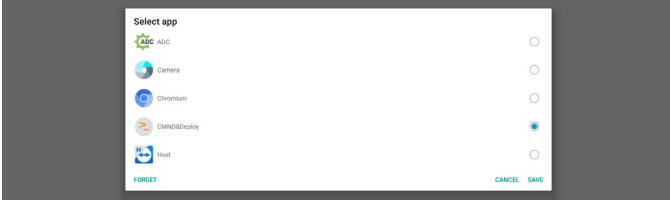

Note:

The APKs pre-installed by the system will not be shown on the list. Only the APKs that were installed manually will be listed.

(1).FORGET button

Clear the custom source application. It will be shown in gray if the customer source application has not been set.

(2).CANCEL button

Quit without saving changes.

(3).SAVE button

Click the "Save" button to select the APS as the custom source application. It will be shown in gray if no available application can be selected.

## Force Restart Custom APP

When this feature is enabled, the system can monitor the status of custom APP. If the custom APP doesn't exist and that boot on source is set to "Custom app", the system will then try to launch custom APP again.

Default setting is Disable.

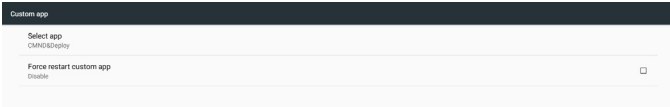

### 6.1.2.3.2. Source label/enable

Enable/Disable editing function for name of non-Android source.

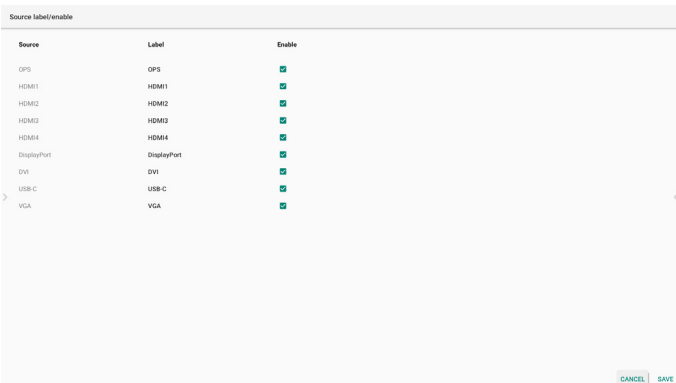

### 6.1.2.4. Network Application

Settings -> Signage Display -> Network Application

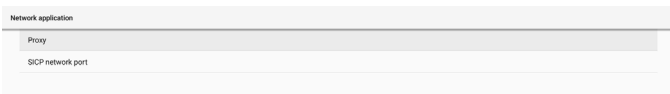

## Proxy

Settings -> Signage Display -> Network Application -> Proxy

Enable the proxy server by clicking the checkbox of "Enable". User can set up the host IP and port number of the proxy server. The default setting is "Disable".

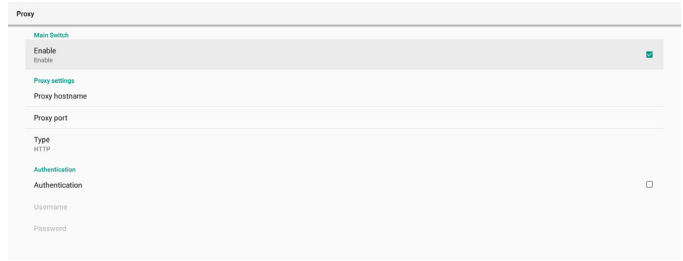

System supports the following proxy types: HTTP, HTTPS, SOCKS4, and SOCKS5. Choose one for your proxy server.

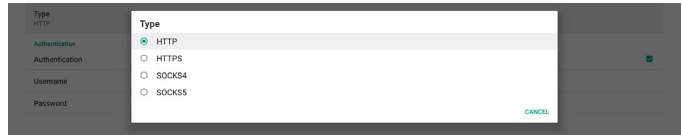

If an authorization is requested by proxy server, click the checkbox of "Authorization" and enter the username and password.



## SICP Network Port

Settings -> Signage Display -> Network Application -> SICP Network Port

Set up the default port of SICP and enable/disable the network SICP. The default SICP is enabled with the port 5000.

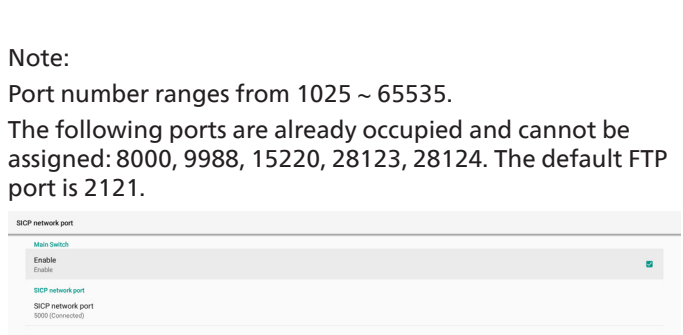

Note:

Port number ranges from 1025 ~ 65535.

The following ports are already occupied and cannot be assigned: 8000, 9988, 15220, 28123, 28124. The default FTP port is 2121.

### 6.1.2.5. System Tools

Settings -> Signage Display -> System Tools

There are eight major features in signage display system tools:

- (1). Clear Storage
- (2). Reset
- (3). Auto restart
- (4). Import & Export
- (5). Clone
- (6). Security
- (7). Admin Password
- (8). Touch lock password
- (9). Swipe up



## Clear Storage

Settings -> Signage Display -> System Tools -> Clear Storage



Clear data under {storage}/philips/folder of the internal and external storage.

- (1). All  
Clear the folder "Philips" from the internal storage, USB and SD card.
- (2). Internal Storage  
Clear the folder "Philips" from the internal storage only.
- (3). USB Storage  
Clear the folder "Philips" from the USB storage only.
- (4). SD Card  
Clear the folder "Philips" from the SD card only.

A dialog box lists all folders that the system is going to clear. Press "RESET" to clear all data under the listed folder, or press back key to quit without saving.



## Reset

Settings -> Signage Display -> System Tools -> Reset

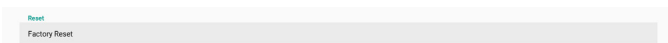

## Factory Reset

This function allows you to clear all user data and settings. The system will auto reboot and jump to OOB after rebooting.

### Important Note:

1. Only the data stored in the internal storage will be cleared and cannot be recovered, the data includes the device settings, installed APPs, APPs' data, downloaded files, music, photos and all data under "/data". However, the data stored on the USB and SD card will not be cleared.
2. Make sure that the AC adapter and power are always present during the factory reset process. User can only power off after seeing OOB on the screen.



Click "Factory Reset" to perform factory reset. Press "OK" to confirm when the dialog box appears. Please note this action clears all data in the internal storage and it is not recoverable.



## Auto Restart

Auto Restart function allows the device to restart automatically at the time you specify.

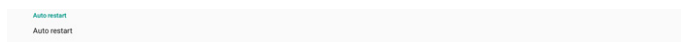

Select Disable/Enable auto restart feature from the Main Switch.

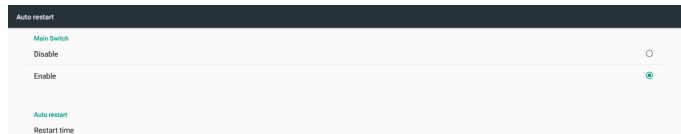

Use the time picker to set auto restart time.



Click "Save" button and the time you set for auto restart will display.

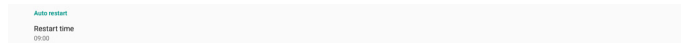

## Import & Export

Settings -> Signage Display -> System Tools -> Import & Export



This function allows you to import/export the settings and 3rd party APK from/to other device. Please note that:

- (1). Export data to BDL3452T-clone.zip file under {storage}/philips/clone folder.
- (2). Support old clone files method, and put files under {storage}/philips/sys\_backup:  
AndroidPDMediaPlayerData.db  
AndroidPDPdfData.db  
menu\_settings.db  
settings\_global.xml  
settings\_secure.xml  
settings\_system.xml  
signage\_settings.db  
smartcms.db  
Note that latest export data will archive all files into ZIP file.
- (3). "Signage Display Name" will not be imported/exported.

## Export Signage Display Settings

System exports database data and third party APKs into {storage}/philips/clone/BDL3452T-clone.zip file of the selected storage (internal storage, SD card or USB storage).

**Note:**

If the selected storage (internal storage, USB or SD card) does not contain Philips/folder, then the system will create it automatically.

A list of all available storage (internal storage, SD card and USB storage):



**Import Signage Display Settings**

Import database data from philips/clone/BDL3452T-clone.zip file of the selected storage (internal Storage, SD Card or USB storage). System imports following data in ZIP file:

- (1). Import Database in BDL3452T-clone.zip
- (2). Import 3<sup>rd</sup> party APK in BDL3452T\_clone.zip

A list of all available storage (internal storage, SD card and USB storage):



A confirmation dialog box is displayed before importing the settings and APKs. Click the "OK" button to start importing the data.

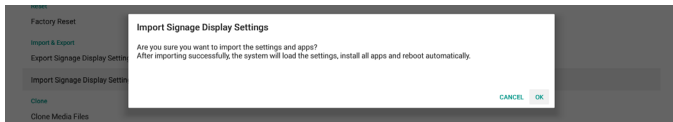

**Clone**

Settings -> Signage Display -> System Tools -> Clone

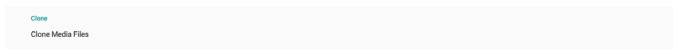

**Clone Media Files**

This function allows you to copy the media files from the selected source storage to the target storage.

- (1). System clone files are under the following folder:
  - philips/photo
  - philips/music
  - philips/video
  - philips/cms
  - philips/pdf
  - philips/browser
- (2). Clone CMS files (file extension is ".cms"):
  - Source storage
  - Source is internal storage
    - Check if there is CMS file on the FTP server.
    - If there is no CMS file on the FTP server, check philips/ folder in source storage
  - Source is external storage (SD card or USB storage)
    - Check CMS file in root directory of storage
  - Target storage
  - Target is internal storage
    - CMS file will be saved to philips/ folder
  - Target is external storage (SD card or USB storage)

CMS file will be saved to root directory of storage



**Security**

Settings -> Signage Display -> System tools -> Security

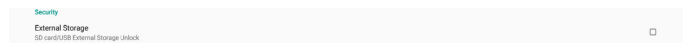

**External Storage**

Click the checkbox to lock or unlock external storage (SD card and USB storage). Default is unlocked.

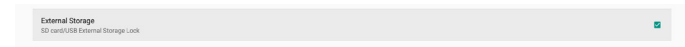

- (1). Unchecked (Disable): SD card/USB External Storage Unlock.
- (2). Checked (Enable): SD card/USB External Storage Lock.

**Note:**

When you disable external storage lock to enable state, please unplug and plugin external storage again (for both SD card and USB storage). After that, system can detect external storage again.

**Admin Password**

Settings -> Signage Display -> System tools -> Admin Password.



**Enable:**

Click the checkbox to enable or disable Admin Password. Default is disable. Once it is enabled, you will need a password to login into Admin mode. Default password is "1234".

**Password:**

Change the password if needed.

**Reset Password:**

Reset the password to its default value which is "1234". If reset is successful, it shows a message as "Successful".

**Touch lock password**

The default password is 123., You also can change touch password by this option.

**Swipe up**

Enable/disable up slide to turn on source menu.



**6.1.2.6. Misc.**

**TeamViewer Support**

Click the checkbox to enable or disable TeamViewer support. TeamViewer will send a virtual HOME key to open Admin mode. Default is enable.

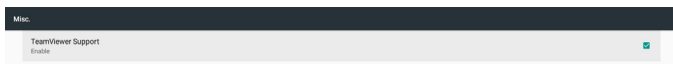

TeamViewerHost and TeamViewerQSAddOn APKs will be installed to the system automatically. Or, system will remove them if "TeamViewer Support" is disabled.

The following two APKs will be listed in Settings->Apps if "TeamViewer support" is enabled.



### 6.1.2.7. System updates

#### Local update

Settings -> Signage Display -> System updates -> Local update  
System will auto search "update.zip" in root folder of USB disk and SD card. If "update.zip" is found on the external storage, a list will be shown for user to select the file to update.

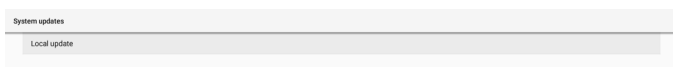

Once the file is selected from the list, the system starts rebooting and updating.

Please note that:

- (1). Do not turn off the power or remove the power adapter until the update is complete.
- (2). Current system only supports full Android update.
- (3). The update file must be named as "update.zip" only.
- (4). The "update.zip" file must be stored in the root folder of your external storage.

### 6.1.3. Apps

Display installed APKs information.

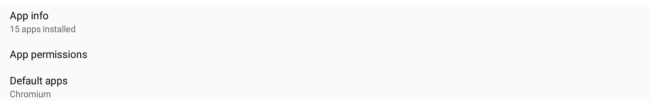

#### 6.1.3.1. App info

All installed Android APP are listed. User can manage each APP's permission and other settings.



#### 6.1.3.2. App permissions

List of major permission of Android system and the APP that has permission to control it.



#### 6.1.3.3. Default Apps

User can set default APPs if someone sends related request.

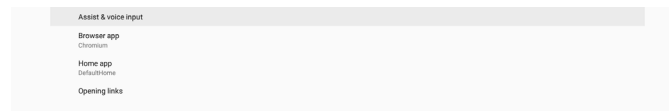

#### Browser app

The default APP to open a webpage URL. Default is Chromium.

#### Home app

The default launcher APP, default is DefaultHome APP. If user changes this APP, the external source may not display correctly.

#### Opening links

This feature allows the APP to open supported links inside its APP directly.

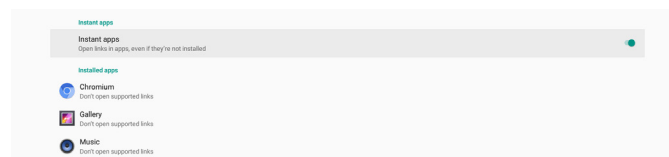

### 6.1.4. Display

Change the font size of your display.

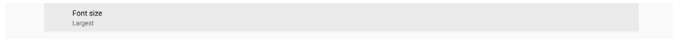

#### 6.1.4.1. Font Size

Drag the slide to adjust system font size. Default setting is "Largest".

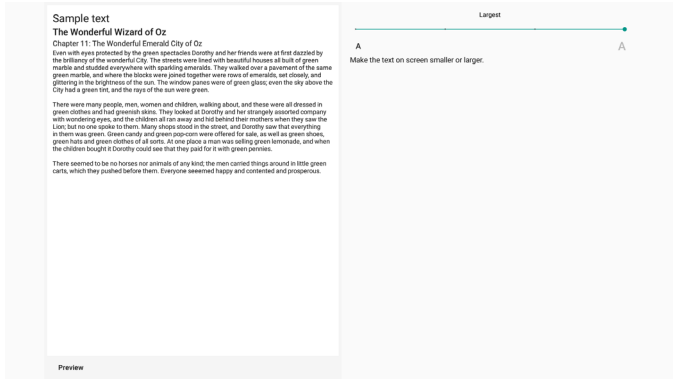

### 6.1.5. Security

Settings -> Security

List show app when it support admin related operations and control.

### 6.1.6. System

The following options are listed in Settings -> System.

- (1).Keyboard & inputs
- (2).Developer options
- (3).About

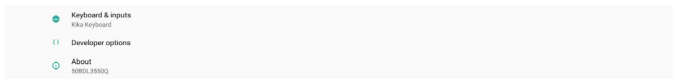

#### 6.1.6.1. Keyboard & input

Settings -> System -> Keyboard & input

User can change IME and keyboard settings.

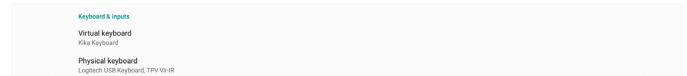

#### Virtual keyboard

Allow user to set default software IME (virtual keyboard) and control detailed IME settings.

Japanese IME will be installed automatically when Japanese language is selected in OOB.



#### Physical keyboard

Allow user to control physical keyboard and detailed keyboard settings.

The "TPV Vir-IR" is a system-level virtual keyboard; it will always exist on the keyboard list.

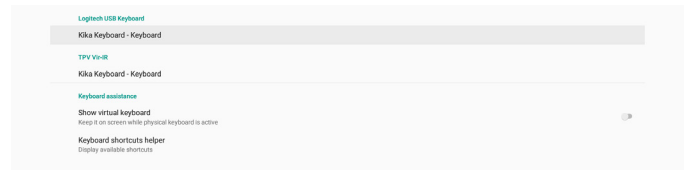

#### On-screen keyboard enable

Settings -> Languages & input -> On-screen keyboard enable

Used to enable/disable system pre-installed software keyboard (IME). User can press "menu" six times to enable on-screen software keyboard when it is disabled. By default, on-screen keyboard is enabled.

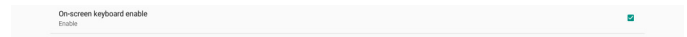

#### 6.1.6.2. Developer options

Settings -> System -> Developer options

Android developer options for developers, default setting is On and USB debugging is also "On" by default.

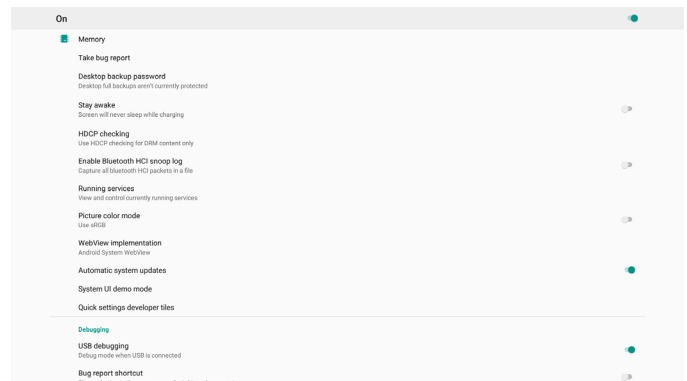



### 6.1.6.3. About

Settings -> System -> About

View the following information about the system.

- (1).Status
- (2).Legal information
- (3).Model (model name of this device)
- (4).Android version
- (5).Android security patch level
- (6).Kernel version
- (7).Build number (release version)

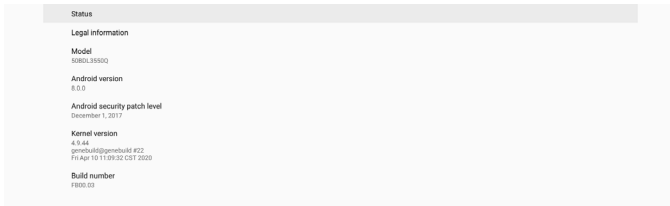

### Status

Display device serial number and total time for the device to boot up.

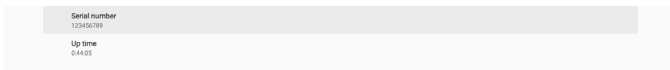

### Legal Information

Legal information and licenses of all open source projects will be listed.

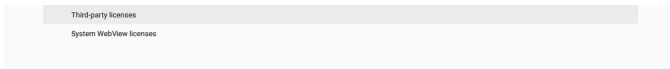

## 7. OSD Menu

An overview of the On-Screen Display (OSD) structure is shown below. You can use it as a reference for further adjustment of your display.

### 7.1. Navigating the OSD Menu

#### 7.1.1. Navigating the OSD menu using the remote control

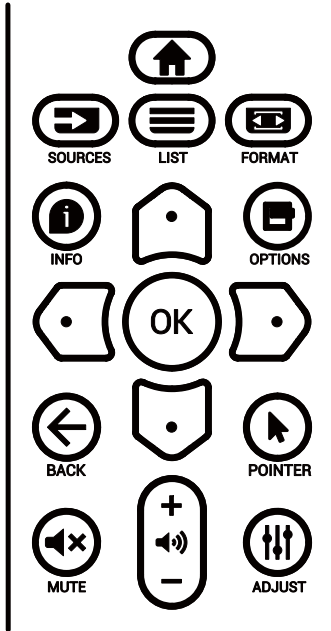

1. Press [] button on the remote control to display the OSD menu.
2. Press [] or [] button to select the item to adjust.
3. Press [OK] or [] button to enter the submenu.
4. In the submenu, press [] or [] button to toggle between items, press [] or [] button to adjust the settings. If there is a submenu, press [OK] or [] button to enter the submenu.
5. Press [] button to return to the previous menu, or press [] button to exit from the OSD menu.

#### 7.1.2. Navigating the OSD menu using the display's control buttons

1. Press [MENU] button to display the OSD menu.
2. Press [+] or [-] button to select the item to adjust.
3. Press [+] button to enter the submenu.
4. In the submenu, press [] or [] button to toggle between items, press [+] or [-] button to adjust settings. If there is a submenu, press [+] button to enter the submenu.
5. Press [MENU] button to return to the previous menu, or keep pressing [MENU] button to exit from the OSD menu.

## 7.2. OSD Menu Overview

### 7.2.1. Picture menu

Picture	Brightness	61
Screen	Contrast	50
Audio	Sharpness	10
Configuration 1	Black Level	50
Configuration 2	Tint	50
Advanced option	Color	55
Android Settings	Noise reduction	Off
	Gamma selection	Native
	Color temperature	Native
	Color control	Action
	Smart power	Off
	Overscan	Off
	Picture reset	Action

#### Brightness

Adjust the brightness of this display's backlight.

#### Contrast

Adjust the contrast ratio for the input signal.

Note: VIDEO source only

#### Sharpness

This function is digitally capable to keep a distinct image at all times.

Adjust the sharpness of the picture for each picture mode.

Note: VIDEO source only

#### Black level

Adjust the image brightness for the background.

Note: VIDEO source only. sRGB picture mode is standard and cannot be changed.

#### Tint (Hue)

Adjust the tint of the screen.

Press + button the flesh tone color becomes greenish.

Press - button the flesh tone color becomes purplish.

Note: VIDEO source only

#### Color (Saturation)

Adjust the color of the screen.

Press + button to increase color depth.

Press - button to decrease color depth.

Note: VIDEO source only

#### Noise reduction

Adjust the noise reduction level.

Note: VIDEO source only

#### Gamma selection

Select a display gamma. It refers to the brightness performance curve of signal input. Choose from {Native} / {2.2} / {2.4} / {s gamma} / {D-image}.

Note: VIDEO source only. sRGB picture mode is standard and cannot be changed.

## Color temperature

Adjust the color temperature.

The image becomes reddish as the color temperature decreases, and becomes bluish as the color temperature increases.

Note: VIDEO source only.

## Color Control

The color levels of red, green, and blue can be adjusted by the color bars.

R: Red gain, G: Green gain, B: Blue gain.

## Smart power

Control of lower power consumption based on brightness setting.

- {OFF}: no adaptation
- {MEDIUM}: 80% of power consumption relative to current settings
- {HIGH}: 65% of power consumption relative to current settings

## Overscan

If you encounter problems with overscanning, you can change display area of the image.

- {ON}: Display 95% of the total image area.
- {OFF}: Display 100% of the total image area.

Note: VIDEO source only.

## Picture reset

Reset all settings in the Picture menu.

Select "RESET" to restore factory preset data.

Press "CANCEL" button to cancel and then return to the previous menu.

## 7.2.2. Screen menu

Picture	H position	0
Screen	V position	0
Audio	Clock	0
Configuration 1	Clock phase	0
Configuration 2	Zoom mode	Full
Advanced option	Custom Zoom	Action
Android Settings	Auto adjust	Action
	Screen reset	Action

### H position

Control Horizontal Image position within the display area of the LCD.

Press + button to move screen to right.

Press - button to move screen to left.

Note: VGA input only.

### V position

Control Vertical Image position within the display area of the LCD.

Press + button to move screen to up.

Press - button to move screen to down.

Note: VGA input only.

## Clock

Press + button to expand the width of the image on the screen to the right.

Press - button to narrow the width of the image on the screen to the left.

Note: VGA input only.



## Clock Phase

Improves focus, clarity and image stability by increasing or decreasing this setting.

Note: VGA input only.

## Zoom mode

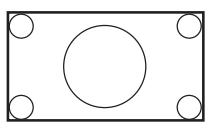
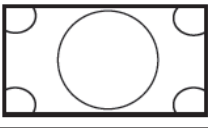
Choose one for video input: {Full} / {Real} / {21:9} / {4:3} / {Custom}

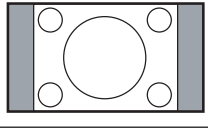

	<b>Full</b> This mode restores the correct proportions of pictures transmitted in 16:9 using the full screen display.
	<b>Real</b> This mode displays the image pixel-by-pixel on screen without scaling the original image size.
	<b>21:9</b> The picture is reproduced in 21:9 format and a black band at the top and bottom.
	<b>4:3</b> The picture is reproduced in 4:3 format and a black band is displayed on either side of the picture.
	<b>Custom</b> Choose to apply the custom zoom settings in the Custom Zoom submenu.

## Custom zoom

You can use this function to further customize the zoom settings to suit the image you want to display.

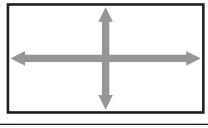
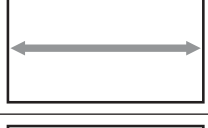
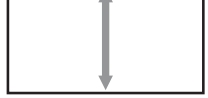
Note: This item is functional only when the {Zoom mode} is set to {Custom}.

	<b>Zoom</b> Expands the horizontal and vertical sizes of the image simultaneously.
	<b>H zoom</b> Expands the horizontal size of the image only.
	<b>V zoom</b> Expands the vertical size of the image only.

	<b>H position</b> Moves the horizontal position of the image left or right.
	<b>V position</b> Moves the vertical position of the image up or down.

**Auto adjust**

Press "Set" to detect and adjust H position, V position, Clock, Phase automatically.

Note: VGA input only.

**Screen reset**

Reset all settings in the Screen menu to factory preset values.

**7.2.3. Audio menu**

Picture	Balance	50
Screen	Treble	50
Audio	Bass	50
Configuration 1	Volume	0
Configuration 2	Audio out (line out)	20
Advanced option	Maximum volume	100
Android Settings	Minimum volume	0
	Mute	Off
	Audio source	Analog
	Audio reset	Action
	Audio Out Sync	Off
	Speaker Setting	On

**Balance**

Adjust to emphasize left or right audio output balance.

**Treble**

Adjust to increase or decrease higher-pitched sounds.

**Bass**

Adjust to increase or decrease lower-pitched sounds.

**Volume**

Adjust the volume.

**Audio Out (line out)**

Adjust to increase or decrease the line out audio output level (volume).

Note: This function will be disabled when Audio Out Sync is ON.

**Maximum volume**

Adjust limitation for the maximum volume setting.

**Minimum Volume**

Adjust limitation for the minimum volume setting.

**Mute**

Turn the mute function on/off.

**Audio Source**

Select the audio input source.

{Analog}: audio from audio input.

{Digital}: audio from HDMI/DVI audio.

**Audio reset**

Reset all settings in the Audio menu to factory preset values.

**Audio Out Sync**

Line out volume sync with internal speaker Volume.

{On}: Enable the function and gray out Audio Out (line out) Volume.

{Off}: Disable the function.

**Speaker Setting**

Turn internal speaker {On}/{Off}.

**7.2.4. Configuration 1 menu**

Picture	Switch on state	Force on
Screen	Panel saving	Action
Audio	RS232 routing	RS232
Configuration 1	Boot on source	Action
Configuration 2	WOL	Off
Advanced option	Light sensor	Off
Android Settings	Human sensor	Off
	Configuration1 reset	Action
	Factory reset	Action

**Switch on state**

Select the display status when you connect the power cord next time.

- {Power off} - The display will remain off when the power cord is connected.
- {Forced on} - The display will turn on when the power cord is connected.
- {Last status} - The display will return to the previous power status (on/off/standby mode) when the power cord is connected.

**Panel saving**

Choose to enable the panel saving functions and thus reduce the risk of image persistence or ghost imaging.

- {Brightness} - Select {On} and the image brightness will reduce to an appropriate level. The Brightness setting in the Picture menu cannot be changed when this setting is enabled.
- {Pixel Shift} - Select the time interval ({Auto}, {10-900} seconds, {Off}) for display to slightly expand the image size and shift the position of pixels in four directions (up, down, left and right). Activating pixel shift will disable H position, V position and Zoom mode in Screen menu.

Note: Video source only.

**RS232 routing**

Select RS232 routing path

- {RS232} - RS232 is routed from 2.5mm phone jack
- {LAN->RS232} - RS232 is routed from RJ45

**Boot on source**

Choose to select a source when booting up.

- {Input} - Select input source when booting up.

- {Playlist} – Select playlist index for MediaPlayer, Browser. 0 indicates there is no playlist.

### WOL (Wake on LAN)

Allow the display to be turned on by a network message.

Note: This function only works in power mode 1 and mode 2.

### Light sensor

Choose to turn on or off the light sensor function of CRD41.

### Human sensor

Choose to turn on or off the human sensor function of CRD41.

### Configuration 1 reset

Reset all settings in Configuration 1 menu to factory preset values.

### Factory Reset

Reset all customized settings in Picture, Screen, Audio, Configuration 1, Configuration 2 and Advanced Option to the factory default values.

## 7.2.5. Configuration 2 menu

Picture	OSD turn off	45
Screen	OSD H position	50
Audio	OSD V position	50
Configuration 1	System rotation	Landscape
Configuration 2	Information OSD	10
Advanced option	Logo	On
Android Settings	Monitor ID	Action
	Heat status	35.88°C 96.57°F
	Monitor information	Action
	HDMI version	
	Configuration2 reset	Action

### OSD turn off

Set the period of time the OSD (on-screen display) menu stays on the screen.

The options are {Off, 5 - 120} seconds. {Off} does not disappear automatically.

### OSD H position

Adjust the horizontal position of the OSD menu.

### OSD V position

Adjust the vertical position of the OSD menu.

### Rotation

Change OSD and Android to Landscape / Portrait mode.

Note: Video inputs will not rotate with this setting.

Note: If Android APK plays video content, user MUST stop and re-play to get correct video image.

### Information OSD

Set the period of time the information OSD display on the upper left corner of the screen. The information OSD will display when input source and signal are changed.

The options are {Off, 1 - 60} seconds.

### Logo

Choose to enable or disable the picture of Logo when turning on your display.

- {Off} – Both static Philips logo and Android boot animation will not be shown.
- {On} – Default value. Both Philips logo and Android boot animation will be shown.
- {User} – Static Philips logo will not be shown, only user-selected boot animation will be shown in Android settings.

Note: Logo will not be rotated even though rotation setting is set.

### Monitor ID

Set the ID number for controlling the display via the RS232 connection. Each display must have a unique ID number when multiple sets of the display are connected. Monitor ID number range is between 1 and 255.

- {Monitor ID} set range in {1-255}. The default setting is 1.
- {Monitor group} set range in {1-254}. The default setting is 1.

### Heat Status

Current thermal status.

### Monitor information

Shows information about your display, including model name, SW version, serial number, and operation hours.

Monitor information	
Model name	XXXXXXXXXX
Serial NO.	0000000000
Operation hours	7
SW Version	FB0B.99

### HDMI version

Set the HDMI version to 1.4 or 2.0.

Note: HDMI input source only.

### Configuration 2 reset

Reset all settings in Configuration 2 menu to factory preset values.

## 7.2.6. Advanced Option menu

Picture	IR control	Unlock
Screen	Power LED light	On
Audio	Keyboard control	Unlock
Configuration 1	Tiling	Action
Configuration 2	Off timer	Off
Advanced option	Date and time	Action
Android Settings	Schedule	Action
	HDMI with One Wire	Off
	HDMI One Wire Power Off	Off
	Auto signal detection	All
	Language	English
	OSD Transparency	Off
	Power Save	Model 2

### IR control

Select the operation mode of the remote control when multiple displays are connected via RS232 connection.

- {Unlock} - All displays can be operated normally by the remote control unit.
- {Primary} - Designate this display as the primary display for remote control operation. Only this display can be operated

by the remote control. (In primary mode, IR key will always be processed regardless of the monitor ID/group settings).

- {Secondary} - Designate this display as the secondary display. This display cannot be operated by the remote control, and will only receive the control signal from the primary display via RS232 connection.
- {Lock All} / {Lock all but Volume} / {Lock all but Power} / {Lock all except PWR & VOL} - Lock the remote control function of this display. To unlock, press and hold the INFO button on the remote control for 6 (six) seconds.

**Power LED light**

Choose to set power indication LED on or off.

Choose {On} for normal use.

**Keyboard control**

Choose to enable or disable the display keyboard (control buttons) function.

- {Unlock} - Enable the keyboard function.
- {Lock All} / {Lock all but Volume} / {Lock all but Power} / {Lock all except PWR & VOL} - Disable the keyboard function.

Note: "Keyboard Control Lock Mode" This function completely disables the access to all Keyboard Control functions. To enable or disable the keyboard control lock, press both [VOL+ ] and [UP ] buttons and hold down continuously more than 3 seconds.

**Tiling**

Create a single large-screen matrix (video wall) that consists of up to 150 sets of the display (up to 10-sets on the vertical and 15-sets on the horizontal sides). This function requires daisy-chain connection.

- **Switch on Delay:** Set the power-on delaying time (in seconds). Default option {Auto} allows a sequential powering-on for each display by monitor ID when multiple displays are connected. The options are: {Off, Auto, 2-255}.
- **Brightness:** {Normal} – Adjust the overall image and background screen brightness (backlight) in Screen menu. {ACS} – Apply brightness values (backlight) which is adjusted by MIC tool. The default value before adjustment is the same as brightness setting in Screen menu.
- **H monitors:** Select the number of displays in horizontal side.
- **V monitors:** Select the number of displays in vertical side.
- **Position:** Select the position of this display in the screen matrix.

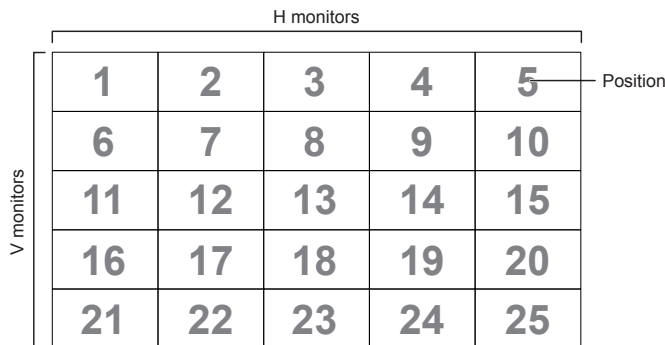

- **Frame comp.:** Turn frame compensation function on and off. The display adjusts the image to compensate the width

of display bezels in order to accurately display the image. With frame compensation:

- **Enable:** Check to enable tiling function.

**Off timer**

Set automatic power off time (in hours).

**Date and time**

Adjust the current date and time for the display's internal clock.

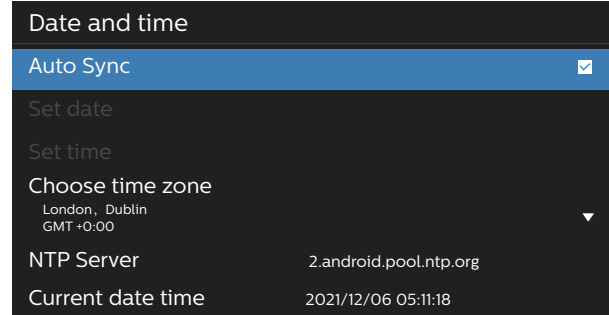

- {Auto Sync} - Auto sync display's clock with NTP server.

**Schedule**

Allow user setup up to seven different scheduled intervals of display activity.

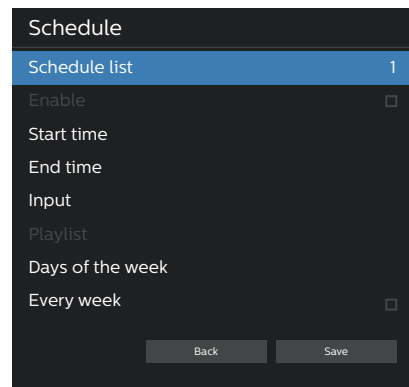

- {Schedule list} – Select 1-7 schedules to edit.
- {Enable} – Enable/disable selected schedule. If time conflict with other schedule or start/end time, input source are empty, user cannot enable this schedule.
- {Start time} – Set start time.
- {End time} – Set end time.
- {Input} – Set input source, system will go to selected source automatically at start time.
- {Play list} – Set playlist 1-7 for MediaPlayer and Browser sources.
- {Days of the week} – Set Sunday, Monday, Tuesday, Wednesday, Thursday, Friday and Saturday.
- {Every week} – Set lifecycle.
- {Back} – Cancel and do not change schedule data.
- {SAVE} – Save schedule data.

**HDMI with One Wire**

Enable or disable HDMI CEC.

**HDMI One Wire Power Off**

Allow user to set multiple devices to standby mode by pressing the power button. This function is only available when HDMI CEC is enabled.

## Auto signal detection

OPTION:

{Off}, {All}, {Failover}

{Off}: Disable Auto signal detection

{All}: HDMI1 -> HDMI2 -> DVI\*\* -> VGA\* -> OPS\* -> Media Player -> Browser -> SmartCMS ->Kiosk -> Custom -> Home

\* Not all modules have all source in this list. DVI can be DVI-I or DVI-D

\* Media Player, Browser will only try playlist index 1

{Failover}:

Failover 1: Home (default)

Failover 2: Home (default)

Failover 3: Home (default)

Failover 4: Home (default)

Failover 5: Home (default)

Failover 6: Home (default)

Failover 7: Home (default)

Failover 8: Home (default)

Failover 9: Home (default) \*

Failover 10: Home (default) \*

Failover 11: Home (default) \*

\* Not all modules have all 11 failover list, depends on total source of module

## Language

Select the language used in the OSD menu.

The options are: English/Deutsch/ 简体中文 /Français/Italiano/ Español/Русский/PolSKI/Türkçe/ 繁體中文 / 日本語 /Português/ العربية/Danish/Swedish/Finnish/Norwegian/Dutch/Czech/ Lithuanian/Latvian/Estonian.

## OSD Transparency

Adjust OSD transparency.

- {Off} - Transparency off.
- {1-100} - Transparency level 1-100

## Power Save

Mode 1 [TCP off, WOL on, auto off]

Mode 2 [TCP off, WOL on, auto on/off]

Mode 3 [TCP on, WOL off, auto on/off]

Mode 4 [TCP on, WOL off, no auto on/off]

Power Save	RCU Power Button Off	No Signal	WOL	Android (ARM)
Mode 1	DC OFF	DC OFF	V	ARM off
Mode 2	DC OFF	when signal is back, system wake up	V	ARM off
Mode 3	Backlight OFF	when signal is back, system wake up	X	ARM on
Mode 4	Backlight OFF	Backlight always on, show no signal	X	ARM on

Following table is the action for Android board with different power mode.

Power mode	Mode 1, Mode 2	Mode 3, Mode 4
DC off	System shutdown	1. Media Player, Browser, PDF Player and SmartCMS will close. 2. Android system goes to default black launcher.
DC on	System boot up	Android system reboot. If Logo settings is off, system directly turn backlight on without rebooting.

## OPS settings

Set the OPS configuration under each power condition.

- {Auto} - After selecting {Card OPS} for video source input, the OPS will be set to off when the display power is set to off, or vice versa. If you set to other video source inputs, the OPS will always be set to on.
- {Always off} - The OPS will always be set to off.
- {Always on} - The OPS will always be set to on.

## Advanced option reset

Reset all settings except {Date and Time} in the advanced option menu to factory preset values.

## 7.2.7. Android Settings

### Open Android Settings

1. When enabled admin password from Android Setting -> System tools, it must enter the password before entering the android settings.

Default password is 1234.

## 8. Supported Media Formats

### USB Multimedia Formats

Video format		
Video Codec	Resolution	Bit Rate
MPEG1/2	1080P@30fps	40Mbps
MPEG4	1080P@30fps	40Mbps
H.263	1080P@30fps	40Mbps
H.264	4k2k@60fps	135Mbps
H.265	4K2K@60fps	100Mbps
VP8	1920x1080@30fps	50Mbps

Audio format			
Audio Codec	Sampling Rate:	Channel	Bit Rate
MPEG1/2/2.5 Layer3	8KHz-48KHz	2	8Kbps-320Kbps
MPEG1/2 Layer1	16KHz-48KHz	2	32Kbps-448Kbps
MPEG1/2 Layer2	16KHz-48KHz	2	8Kbps-384Kbps
AAC, HEAAC	8KHz-48KHz	5.1	AAC-LC:12Kbps-576Kbps V1:6Kbps-288Kbps V2:3Kbps-144Kbps

Photo format	
Image	Max. Resolution
JPEG	3840 x 2160
PNG	3840 x 2160
BMP	3840 x 2160

#### NOTES:

- Sound or video may not work if the contents have a standard bit rate/frame rate above the compatible Frame/sec listed in the table above.
- Video content with a Bit rate or Frame rate larger than the rate specified in the table above can cause choppy video during playback.



## 9. Input Mode

VGA/DVI timing support:

Item	Mode	Resolution	H.Freq. (KHz)	V.Freq. (Hz)
1	IBM VGA 10H	640x350	31.469	70.086
2	IBM VGA 12H	640x480	31.469	59.94
3	MACINTOSH	640x480	35	66.67
4	VESA	640x480	37.861	72.809
5	VESA	640x480	37.5	75
6	IBM VGA 3H	720x400	31.469	70.087
7	VESA	800x600	35.156	56.25
8	VESA	800x600	37.879	60.317
9	VESA	800x600	48.077	72.188
10	VESA	800x600	46.875	75.000
11	MACINTOSH	832x624	49.726	74.551
12	VESA Standard AddDMT	848x480	31	60.000
13	-	960x720	56.4	75.000
14	VESA	1024x768	48.363	60.004
15	VESA	1024x768	56.476	70.069
16		1152x864	53.986	59.985
17	VESA	1152x864	53.783	59.959
18		1152x864	63.851	70.012
19	VESA	1152x864	67.5	75.000
20	SUN WS	1152x900	61.846	66.004
21	-	1280x720	44.772	60.000
22	-	1280x720	52.5	70.000
23	CVT 2.3MA	1280 x768	47.776	59.870
24	CVT 2.3MA	1280 x768	60.289	74.893
25	CVT	1280x800	49.7	59.810
26	CVT	1280x800	62.8	74.930
27	VESA	1280x960	60	60.000
28	VESA	1280x1024	63.981	60.020
29	SUN WS	1280x1024	71.691	67.189
30	VESA	1280x1024	79.976	75.025
31	VESA Standard AddDMT	1360x768	47.712	60.015
32	VESA Standard AddDMT	1366x768	47.712	59.790
33	VESA-reduced blanking mode	1440x900	55.469	59.901
34	VESA	1440x900	55.935	59.887
35	VESA	1440x900	70.635	74.984
36	CVT-reduced blanking	1400x1050	64.744	59.948
37	CVT AddDMT	1440x1050	65.3	60.000
38	CVT	1400x1050	82.278	74.867
39	CVT Red. Blanking	1600x900	55.54	60.000
40	VESA	1600x1200	75	60
41	CVT1.76MW	1680x1050	65.29	59.954
42	CVT1.76MW-R	1680x1050	64.674	59.883
43	CVT 2.3MA-R	1920x1080	66.587	59.934
44	VESA Standard VDMTREV	1920x1080	67.5	60.000
45	CVT1960H	1920x1080	67.1584	59.963
46	VSC1960H	1920x1080	67.08	60
47	CVT 2.3MA-R	1920x1200	74.038	59.950

## 4K2K

Item	Resolution	H.Freq. (KHz)	V.Freq. (Hz)
1	3840x2160	53.946	23.900
2	3840x2160	54	24.000
3	3840x2160	56.25	25.000
4	3840x2160	67.432	29.900
5	3840x2160	67.5	30.000
6	3840x2160	112.5	50.000
7	3840x2160	135	60.000

## Video Timing support(HDMI/DVD HD/DVI)

Item	Mode	Resolution	Comment
1	60Hz	480i	except DVI
2		480p	
3		720p	
4		1080i	
5		1080p	
6		4Kx2K	except DVI
7	50Hz	576i	except DVI
8		576p	
9		720p	
10		1080i	
11		1080p	
12		4Kx2K	except DVI

**Note:** OPS support 3840x2160@30Hz.

- The PC text quality is optimum in UHD mode (3840 x 2160, 60Hz).
- Your PC display screen might appear different depending on the manufacturer (and your particular version of Windows).
- Check your PC instruction book for information about connecting your PC to a display.
- If a vertical and horizontal frequency-select mode exists, select 60Hz (vertical) and 31.5KHz (horizontal). In some cases, abnormal signals (such as stripes) might appear on the screen when the PC power is turned off (or if the PC is disconnected). If so, press the [INPUT] button to enter the video mode. Also, make sure that the PC is connected.
- When horizontal synchronous signals seem irregular in RGB mode, check PC power saving mode or cable connections.
- The display settings table complies to the IBM/VESA standards, and based on the analog input.
- The DVI support mode is regarded as same to the PC support mode.
- The best timing for the vertical frequency to each mode is 60Hz.
- Resolution 3840x2160 50/60Hz must be equipped with HDMI certified cable(Premium High Speed HDMI Cables).

## 10. Pixel Defect Policy

We strive to deliver the highest quality products and use some of the industry's most advanced manufacturing processes whilst practicing stringent quality control. However, pixel or sub-pixel defects on the PDP / TFT panels used in Plasma- & LCD- displays are sometimes unavoidable. No manufacturer can guarantee that all panels will be free from pixel defects, but Philips guarantees that any Plasma- & LCD- displays with an unacceptable number of defects will be repaired during the warranty period in line with your local guarantee conditions.

This notice explains the different types of pixel defects and defines the acceptable defect level for the LCD screen. In order to qualify for repair under warranty, the number of pixel defects must exceed a certain level as shown in the reference table. If the LCD screen is within specification a warranty exchange / claim back will be refused. Additionally, because some types or combinations of pixel defects are more noticeable than others, Philips sets even higher quality standards for those.

### 10.1. Pixels and Sub-Pixels

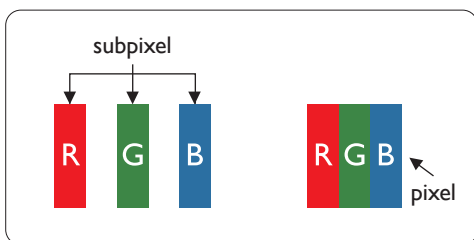

A pixel, or picture element, is composed of three sub-pixels in the primary colors of red, green and blue. Many pixels together form an image. When all sub-pixels of a pixel are lit, the three colored sub-pixels together appear as a single white pixel. When all are dark, the three colored sub-pixels together appear as a single black pixel. Other combinations of lit and dark sub-pixels appear as single pixels of other colors.

### 10.2. Types of Pixel Defects + Dot Definition

Pixel and sub-pixel defects appear on the screen in different ways. There are three categories of pixel defects and several types of sub-pixel defects within each category.

Dot definition = What is a defective "Dot"?:

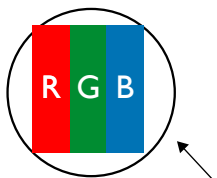

One or more defective, adjacent sub-pixel are defined as one "dot". The no. of defective sub-pixels are not relevant to define a defective dot. This means that a defective dot can consist of one, two or three defective sub-pixels which can be dark or lit.



One dot = One Pixel; consists of three sub-pixels of Red, Green, and Blue.

### 10.3. Bright Dot Defects

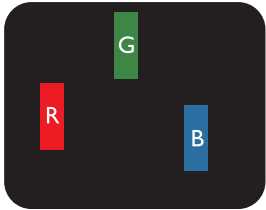
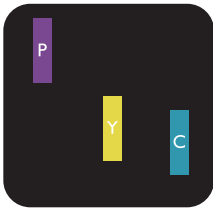
Bright dot defects appear as pixels or sub-pixels that are always lit or "on". These are the examples of bright dot defects:

 <p>One lit red, green or blue sub pixel</p>	 <p>Two adjacent lit sub pixels: Red + Blue = Purple Red + Green = Yellow Green + Blue = Cyan (Light Blue)</p>	 <p>Three adjacent lit sub pixels (one white pixel)</p>
---	---	--

## 10.4. Dark Dot Defects

Black dot defects appear as pixels or sub-pixels that are always dark or "off". These are the examples of black dot defects:

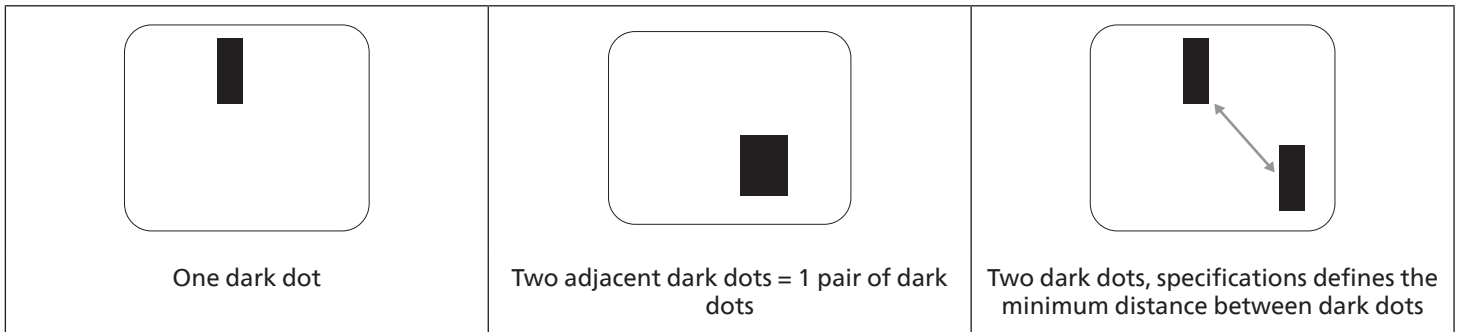

## 10.5. Proximity of Pixel Defects

Because pixel and sub-pixels defects of the same type that are nearby one another may be more noticeable, Philips also specifies tolerances for the proximity of pixel defects. In the table below you can find specifications about:

- Allowed amount of adjacent dark dots = (adjacent dark dots = 1 pair of dark dots)
- Minimum distance between dark dots
- Total no. of all defective dots

## 10.6. Pixel Defect Tolerances

In order to qualify for repair due to pixel defects during the warranty period, a PDP / TFT panel in a Philips Plasma / LCD- display must have pixel or sub-pixel defects exceeding the tolerances listed in the following table.

BRIGHT DOT EFFECT	ACCEPTABLE LEVEL
1 lit sub pixel	2
BLACK DOT EFFECT	ACCEPTABLE LEVEL
1 dark sub pixel	10
TOTAL DOT DEFECTS OF ALL TYPES	12

**Note:** \* 1 or 2 adjacent sub pixel defects = 1 dot defect

## 10.7. MURA

Dark spots or patches may occasionally appear on some liquid crystal display (LCD) panels. This is known within the industry as Mura, which is a Japanese term for "unevenness." It is used to describe an irregular pattern or area in which uneven screen uniformity appears under certain conditions. Mura is a result of the deterioration of the liquid crystal alignment layer and is most commonly caused by long-term operation under high ambient temperatures. It is an industry- wide phenomenon and Mura is not repairable. It is also not covered by our warranty terms.

Mura has been around since the introduction of LCD technology and with screens getting bigger and in operation 24/7, many displays are running in low light conditions. This all adds to the possibility of Mura affecting displays.

### HOW TO SPOT MURA

There are many symptoms of Mura and also multiple causes. Several of these are listed below:

- Impurities or foreign particles in the crystal matrix
- Uneven distribution of LCD matrix during manufacturing
- Non-uniform luminance distribution of the backlight
- Panel assembly induced stress
- Flaws within the LCD cells
- Thermal induced stress - high temperature operation over long periods of time

### HOW TO AVOID MURA

Although we can not guarantee the complete eradication of Mura every time, in general the appearance of Mura can be minimized by these methods:

- Lower the backlight brightness
- Use a screen saver
- Reduce the ambient temperature around the unit

## 11. Cleaning and Troubleshooting

### 11.1. Cleaning

#### Caution When Using the Display

- Do not bring your hands, face or objects close to the ventilation holes of the display. The top of the display is usually very hot due to the high temperature of exhaust air being released through the ventilation holes. Burns or personal injuries may occur if any body parts are brought too close. Placing any object near the top of the display could also result in heat related damage to the object as well as the display itself.
- Be sure to disconnect all cables before moving the monitor. Moving the monitor with its cables attached may damage the cables and thus cause fire or electric shock.
- Disconnect the power plug from the wall outlet as a safety precaution before carrying out any type of cleaning or maintenance procedure.

#### Front Panel Cleaning Instructions

- The front of the display has been specially treated. Wipe the surface gently using only a cleaning cloth or a soft, lint-free cloth.
- If the surface becomes dirty, soak a soft, lint-free cloth in a mild detergent solution. Wring the cloth to remove excess liquid. Wipe the surface of the display to remove dirt. Then use a dry cloth of the same type to dry.
- Do not scratch or hit the surface of the panel with fingers or hard objects of any kind.
- Do not use volatile substances such as insect sprays, solvents and thinners.

#### Cabinet Cleaning Instructions

- If the cabinet becomes dirty, wipe the cabinet with a soft, dry cloth.
- If the cabinet is extremely dirty, soak a lint-free cloth in a mild detergent solution. Wring the cloth to remove as much moisture as possible. Wipe the cabinet. Use another dry cloth to wipe over until the surface is dry.
- Do not use solution that contains oil to clean the plastic parts. Such product damage the plastic parts and void the warranty.
- Do not allow any water or detergent to come into contact with the surface of the display. If water or moisture gets inside the unit, operating problems, electrical and shock hazards may result.
- Do not scratch or hit the cabinet with fingers or hard objects of any kind.
- Do not use volatile substances such as insect sprays, solvents and thinners on the cabinet.
- Do not place anything made from rubber or PVC near the cabinet for any extended periods of time.

## 11.2. Troubleshooting

Symptom	Possible Cause	Remedy
No picture is displayed	<ol style="list-style-type: none"> <li>1. The power cord is disconnected.</li> <li>2. The main power switch on the back of the display is not switched on.</li> <li>3. The selected input has no connection.</li> <li>4. The display is in the standby mode.</li> </ol>	<ol style="list-style-type: none"> <li>1. Plug in the power cord.</li> <li>2. Make sure that the power switch is switched on.</li> <li>3. Connect a signal connection to the display.</li> </ol>
Interference displayed on the display or an audible noise is heard	Caused by surrounding electrical appliances or fluorescent lights.	Move the display to another location to see if the interference is reduced.
Color is abnormal	The signal cable is not connected properly.	Make sure that the signal cable is attached firmly to the back of the display.
Picture is distorted with abnormal patterns	<ol style="list-style-type: none"> <li>1. The signal cable is not connected properly.</li> <li>2. The input signal is beyond the capabilities of the display.</li> </ol>	<ol style="list-style-type: none"> <li>1. Make sure that the signal cable is attached firmly.</li> <li>2. Check the video signal source to see if it is beyond the range of the display. Please verify its specifications with this display's specification section.</li> </ol>
Display image doesn't fill up the full size of the screen	<ol style="list-style-type: none"> <li>1. The zoom mode is not set correctly.</li> <li>2. Scan Mode may be set incorrectly to underscan.</li> <li>3. If the image exceeds the screen size, Scan Mode may need to be set to Underscan.</li> </ol>	Use the Zoom mode or Custom zoom function in the Screen menu to fine tune display geometry and time frequency parameter.
Can hear sound, but no picture	Source signal cable is connected improperly.	Make sure that both video inputs and sound inputs are correctly connected.
Can see picture but no sound is heard	<ol style="list-style-type: none"> <li>1. Source signal cable is connected improperly.</li> <li>2. Volume is turned all the way down.</li> <li>3. {Mute} is turned on.</li> <li>4. No external speaker is connected.</li> </ol>	<ol style="list-style-type: none"> <li>1. Make sure that both video inputs and sound inputs are connected correctly.</li> <li>2. Press <b>[+]</b> or <b>[-]</b> button to hear sound.</li> <li>3. Switch MUTE off by using the <b>[MUTE]</b> button.</li> <li>4. Connect external speakers and adjust the volume to a suitable level.</li> </ol>
Some picture elements do not light up	Some pixels of the display are off.	This display is designed using an extremely high level of precision technology: however, sometimes some pixels of the display may not display. This is not a malfunction..
After-Images can still be seen on the display after the display is powered off. (Examples of still pictures include logos, video games, computer images, and images displayed in 4:3 normal mode)	A still picture is displayed for an over extended period of time	Do not allow a still image to be displayed for an extended period of time as this can cause a permanent after-image to remain on the display.

<p>How to setup the settings in the menu to control all the monitors at the same time and individually via RC?</p>	<p>Daisy chained by RS232 and no IR cable</p>	<ol style="list-style-type: none"> <li>1. The first display sets as "Primary" on OSD (Advanced option/IR control item), others set as "Secondary".</li> <li>2. The setup OSD will show on top left side of the display.(Toggle MENU will show again if it disappear)</li> <li>3. Default setting: ID NO: 0, GP NO: 0, this setting can control all displays by IR.  The "+", "-" can change "ID NO" to control signal display by "Monitor ID".  The "UP", "DOWN" can change "GP NO" to control multi-display by "Group ID".  *The first display is always controlled by IR.</li> </ol>
<p>How is the RC working?</p>	<p>Daisy chain: no connection of RS232 and IR cable</p>	<p>No setting is required. Connect with IR cables and control by IR.  *This may cause out-of-synchronism phenomenon. It is suggested to use the above settings with RS-232 cable.</p>

## 12. Technical Specifications

Item	Specifications	
	43BDL3452T	55BDL3452T
Screen Size (Active Area)	108 cm / 42.5"	138.7 cm / 54.6"
Aspect Ratio	16:9	16:9
Number of pixels	3840 (H) x 2160 (V)	3840 (H) x 2160 (V)
Pixel pitch	0.2451(H) x 0.2451 (V) [mm]	0.315(H) x 0.315 (V) [mm]
Displayable colors	1.07G (8Bits +FRC)	1.07G (8Bits +FRC)
Brightness (typical)	350 cd/m <sup>2</sup>	400 cd/m <sup>2</sup>
Contrast ratio (typical)	1200:1	1300:1
Viewing angle	178°(H)/178°(V)	178°(H)/178°(V)

### In/Out Terminals:

Item		Specifications
Speaker Output	Internal Speakers	10W (L) + 10W (R) [RMS]/8Ω 82 dB/W/M/200 Hz - 13 KHz
Audio Output	3.5mm phone jack x1	0.5V [rms] (Normal) / 2 Channel (L+R)
Audio Input	3.5mm phone jack x 1	0.5V [rms] (Normal) / 2 Channel (L+R)
RS232	2.5mm phone jack x 2	RS232 in / RS232 out
RJ-45	RJ-45 Jack x 1 (8 pin)	10/100 LAN Port
HDMI Input	HDMI Jack (Type A) (19 pin) in x 2	Digital RGB: TMDS (Video + Audio) MAX: Video - 720p, 1080p, 3840 x 2160/60 Hz Audio - 48 KHz/ 2 Channel (L+R) Supports LPCM only
DVI-D Input	DVI-D jack	Digital RGB: TMDS(VIDEO)
VGA Input	D-Sub Jack x 1 (15 pin)	Analog RGB: 0.7V [p-p] (75Ω), H/CS/V: TTL (2.2kΩ), SOG: 1V [p-p] (75Ω) MAX: 1920 x 1080/60 Hz (FHD)
IR Input/Output	3.5mm x 2	IR pass through
SD card	Micro SD card	Support to 1TB
USB-B	USB-B	Connect touch function to external PC
USB Input	USB x 2 (Type A)	USB 2.0, Multimedia play and service port



**General:**

Item	Specifications	
	43BDL3452T	55BDL3452T
Power Input	100 - 240V~, 50/60Hz	100 - 240V~, 50/60Hz
Power Consumption (Max)	220 W	270 W
Power Consumption (typ.)	100 W	140 W
Power Consumption (Standby mode & Off mode)	<0.5 W	<0.5 W
Dimensions (Without Stand) [W x H x D]	1004.4 x 592.6x 109.2 mm	1272.6 x 743.4x 81.7 mm
Weight (Without Stand)	18.54 Kg	27 Kg
Gross Weight (Without Stand)	22.0 Kg	34.5 Kg
Standby mode Power Consumption (W)	0.50 W	0.50 W
AC switch off mode (W)	0 W	0 W

**Environmental Condition:**

Item		Specifications
Temperature	Operational	0 - 40°C
	Storage	-20 - 60°C
Humidity	Operational	20 - 80% RH (No condensation)
	Storage	5 - 95% RH (No condensation)
Altitude	Operational	0 - 3,000 m
	Storage / Shipment	0 - 9,000 m

## Warranty policy for Philips Professional Display Solutions

Thank you for purchasing this Philips product. Philips products are designed and manufactured with high standards and deliver high quality performance, ease of use and ease of installation. If you encounter any difficulties while using your product, we recommend that you first consult the user manual or the information in the support section of the website, where (depending on the product type) you may find a downloadable user manual, frequently asked questions, instruction videos or a support forum.

### LIMITED WARRANTY

In the unlikely event the product requires service, we will arrange for your Philips product to be serviced free-of-charge within the warranty period, provided that the product was used in accordance with the user manual (e.g. in the intended environment).

For these product categories, a partner company of Philips is the warrantor of the product. Please check the documentation supplied with your product.

### WHO IS COVERED?

Your Warranty coverage begins from the first date of purchase of the product. You need to provide proof of purchase to receive warranty service. A valid sales receipt or other valid document showing that you purchased the product is considered proof of purchase.

### WHAT IS COVERED?

If any defect due to faulty materials and/or workmanship occurs within the warranty period, we will make arrangements for a free of charge service. Where a repair is not possible or not commercially viable, we may replace the product with a new or equivalent refurbished product with similar functionality. Replacement will be offered at our discretion and the warranty will continue from the date of original purchase of the first date of purchase of the product. Please note that all parts, including repaired and replaced parts, are covered only for the duration of the original warranty period.

### WHAT IS EXCLUDED? Your warranty does not cover:

- Consequential damages (including but not limited to loss of data or loss of income), nor compensation for activities done by yourself, such as regular maintenance, installing firmware updates or saving or restoring data (Some states do not allow the exclusion of incidental or consequential damages, so the above exclusion may not apply to you. This includes, but is not limited to, prerecorded material, whether copyrighted or not copyrighted.)
- Labor charges for installation or setup of the product, adjustment of customer controls on the product, and installation or repair of various types of external devices (e.g., WiFi, antenna, USB dongles, OPS type devices) and other systems outside of the product.
- Reception problems caused by signal conditions or cable or antenna systems outside the unit.
- A product that requires modification or adaptation to enable it to operate in any country other than the country for which it was designed, manufactured, approved and/or authorized, or repair of products damaged by these modifications.
- If the model or production number on the product has been altered, deleted, removed or made illegible.

The warranty applies on condition that the product has been handled properly for its intended use and in accordance with the operating instructions

**To Obtain Warranty Service And Information**

For detailed warranty coverage information and additional support requirement and help line, please contact the seller and/or system integrator you purchased the product from. Please note in the USA, this limited warranty is only valid for Products purchased in the Continental United States, Alaska, and Hawaii.

**Before Requesting Service**

Please check your user's manual before requesting service. Adjustments of the controls discussed there may save you a service call.

**WARRANTY PERIOD**

Warranty period for PHILIPS signage display is listed as below, for areas not covered in this table, please follow their warranty statement.

Standard warranty period for PHILIPS signage display is listed as below, for areas not covered in this table, please follow the local warranty statement.

Region	Standard Warranty Period
USA, Canada	3 years
China	1 year
Japan	3 years
Rest of world	3 years
Mexico	3 years
Brazil	3 years
Chile	3 years
Peru	3 years

Note that for professional products, the specific warranty terms of the sale- or purchase agreement may apply.

## Index

### A

AC Switch Cover 23

### C

Change Picture Format 29

Cleaning and Troubleshooting 59

CMND & Play 33

Connecting a PC 24

Connecting Audio Equipment 25

Connecting External Equipment 24

Connecting External Equipment (Multimedia Player) 24

Connecting Multiple Displays in a Daisy-chain  
Configuration 25

Control Panel 15

### H

Handling the remote control 17

### I

Input Mode 55

Input/Output Terminals 16

Inserting the batteries in the remote control 17

Installation Notes 13

IR connection 26

IR Pass-through Connection 26

### M

Media Player 30

Mounting on a Wall 14

### N

Navigating the OSD Menu 48

### O

Operating range of the remote control 17

Operation 29

OSD Menu 48

### P

Package Contents 13

Parts and Functions 15

Pixel Defect Policy 57

### R

Remote Control 18

### S

Safety Instructions 1

Settings 35

Setting UI 35

Side Bar 34

Supported Media Formats 54

### T

Technical Specifications 62

Touch Operation 27

### U

Unpacking and Installation 11

USB Cover 22

### W

Warranty policy for Philips Professional Display Solutions  
64

Watch the Connected Video Source 29



2022 © TOP Victory Investments Ltd. All rights reserved.

This product has been manufactured by and is sold under the responsibility of Top Victory Investments Ltd., and Top Victory Investments Ltd. is the warrantor in relation to this product. Philips and the Philips Shield Emblem are registered trademarks of Koninklijke Philips N.V. and are used under license.

Specifications are subject to change without notice.  
Version: V1.00 2022-06-22