

Power Cord

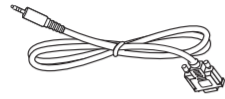

RS232 Cable



RS232 Daisy Chain Cable

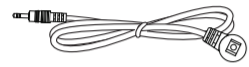

IR Sensor Cable



Philips logo plate



AC Switch Cover

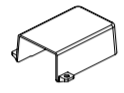

USB Cover



Edge Alignment Kit-1



Edge Alignment Kit-2 x 2

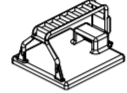

Wire Clamper X 3

* Differences according to regions.

Display design and accessories may differ from those illustrated above.

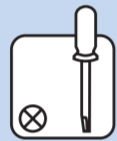

1

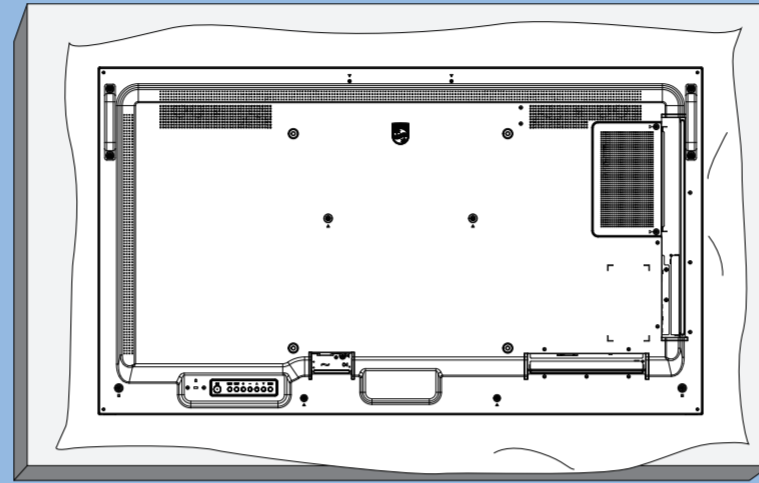

2

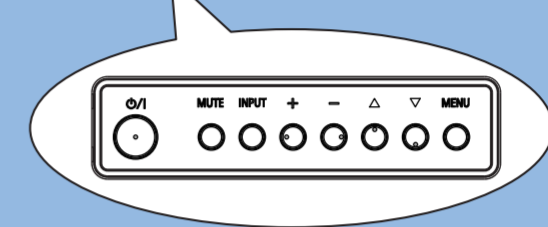
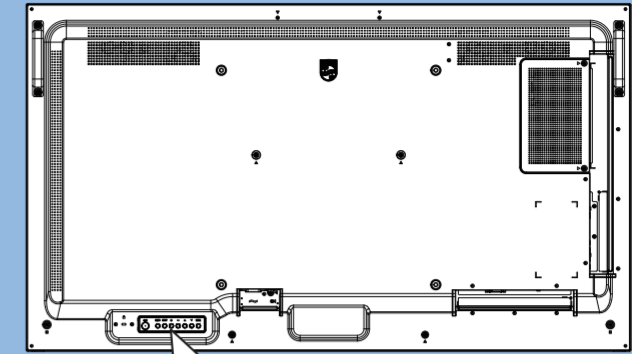

3

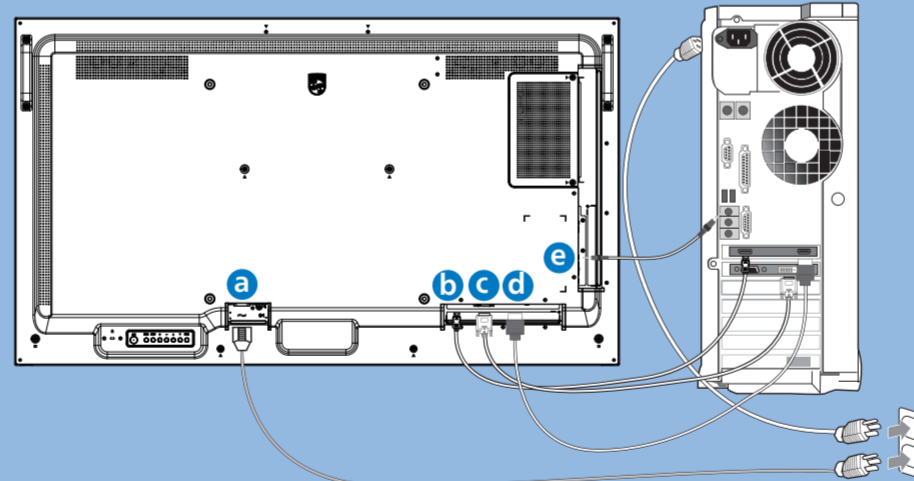
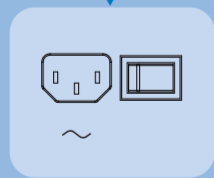
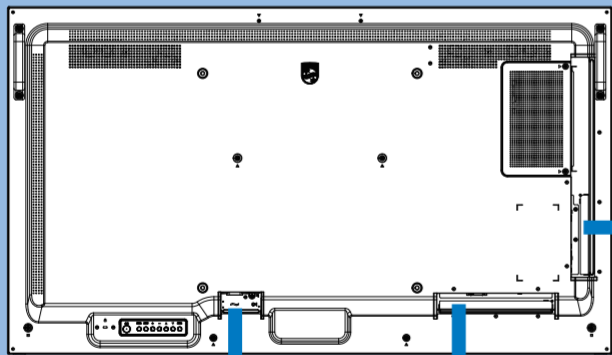

AC IN



DP



DVI



HDMI



AUDIO



4

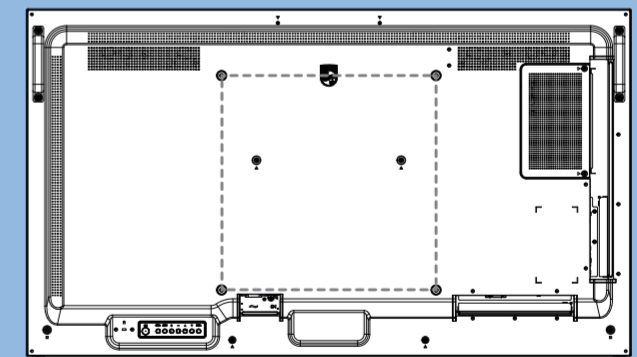

M6* (14+X) mm(43BDL3117P)
M6* (12.2+X) mm(50BDL3117P/55BDL3117P)
(X=Thickness of Wall mount BKT)

43BDL3117P: 200mmx200mm

50BDL3117P: 400mmx400mm

55BDL3117P: 400mmx400mm

5

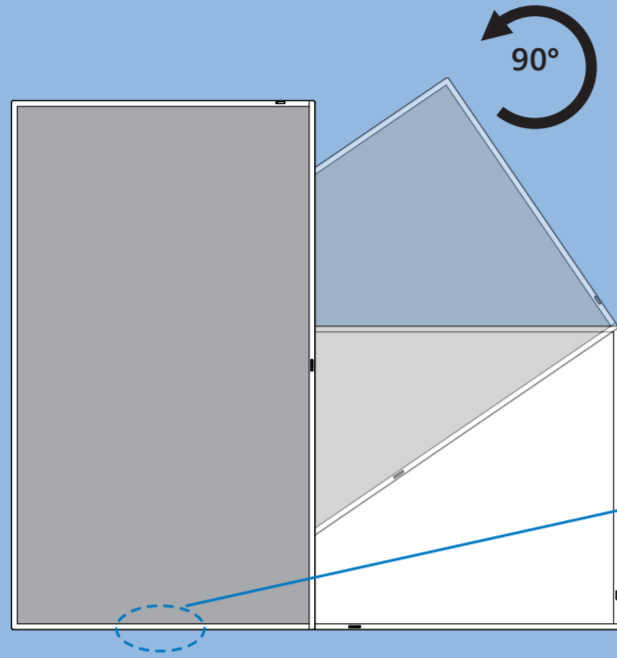

90°

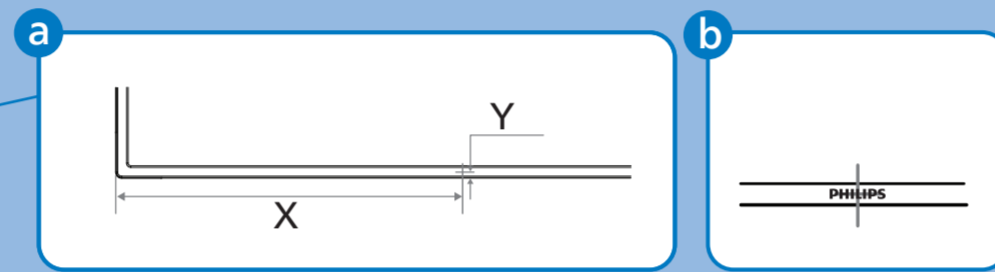
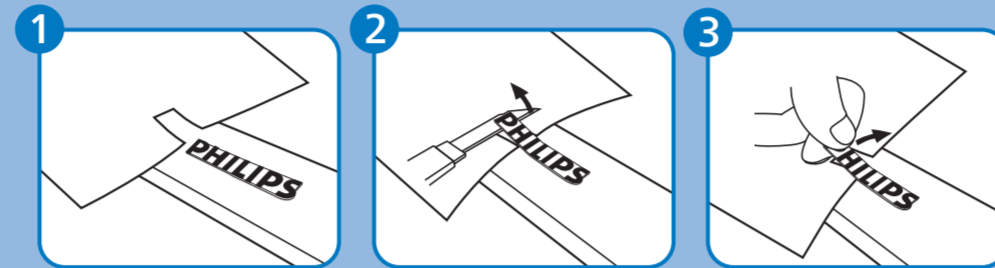

43BDL3117P: X=280.6mm Y=7.4mm
 50BDL3117P: X=324.5mm Y=7.9mm
 55BDL3117P: X=356.3mm Y=7.4mm

PHILIPS

Professional Display Solutions

P Line

43BDL3117P/50BDL3117P
55BDL3117P

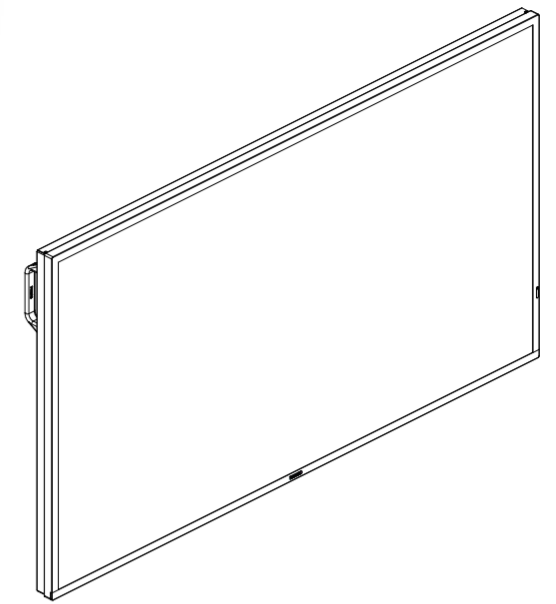

Quick Start



Please check out the website below for more product information.
www.philips.com/signagesolutions-support



Envision Peripherals Inc.
 490 N McCarthy Blvd, Suite #120
 Milpitas, CA 95035
 USA

2021 © TOP Victory Investments Ltd. All rights reserved.
 This product has been manufactured by and is sold under the responsibility of Top Victory Investments Ltd., and Top Victory Investments Ltd. is the warrantor in relation to this product. Philips and the Philips Shield Emblem are registered trademarks of Koninklijke Philips N.V. and are used under license.

Specifications are subject to change without notice.

Version: V1.00 2021-09-01

