

Power cord

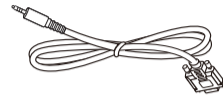

DVI Cable



RS232 Cable

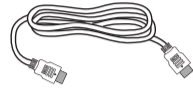

HDMI Cable



RS232 Daisy Chain Cable



IR Sensor Cable

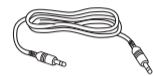

IR Cable



x 2

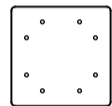

x 1

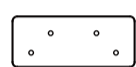

x 2



x 8

* Differences according to regions.

Display design and accessories may differ from those illustrated above.

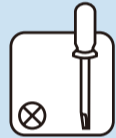

1

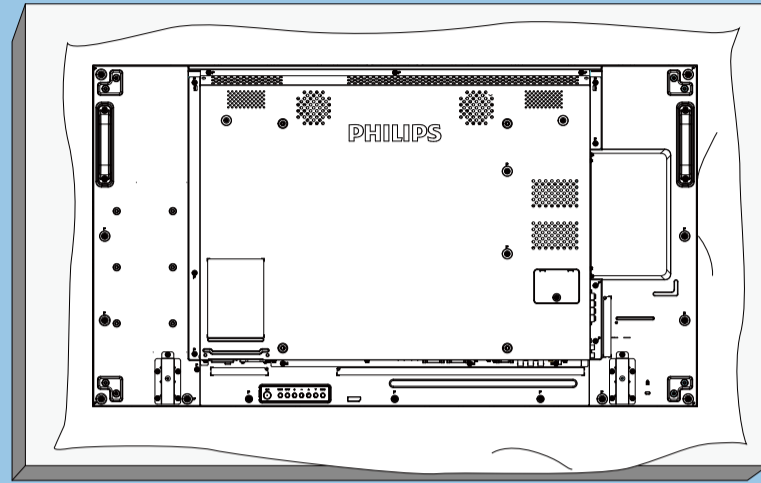

2

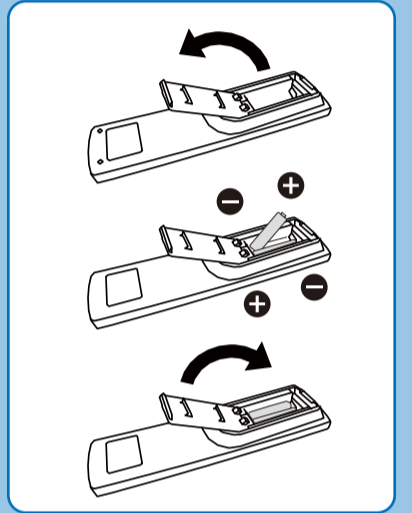
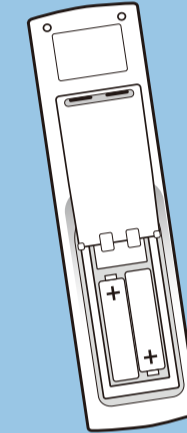
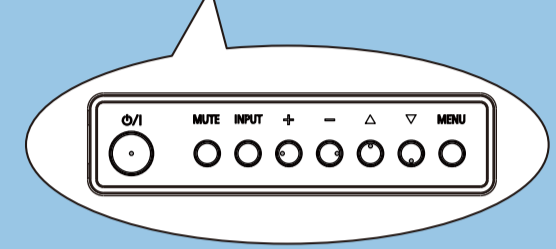
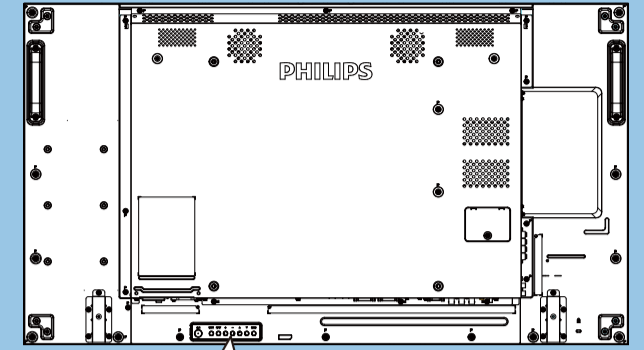

3

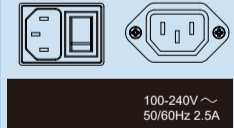
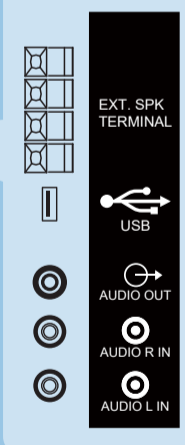
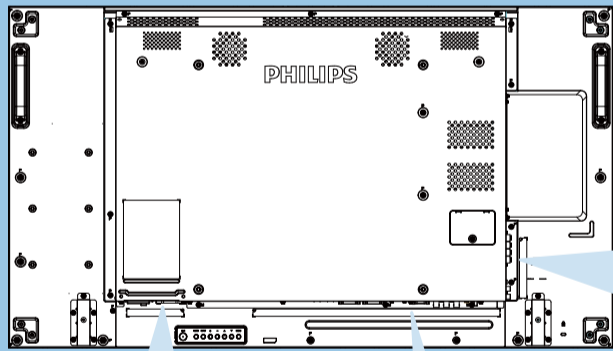

100-240V ~
50/60Hz 2.5A

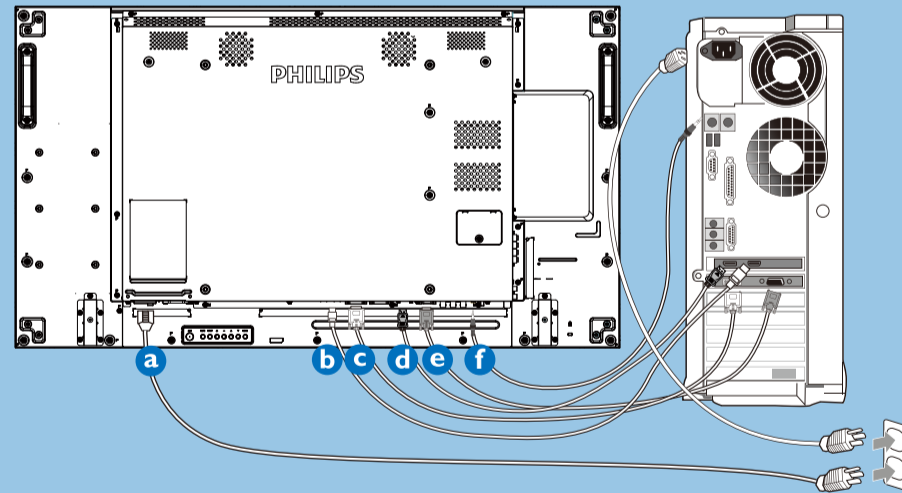

AC IN

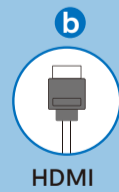

HDMI

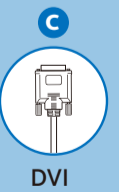

DVI

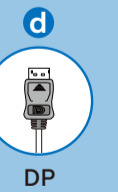

DP

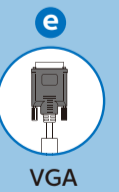

VGA



AUDIO

4

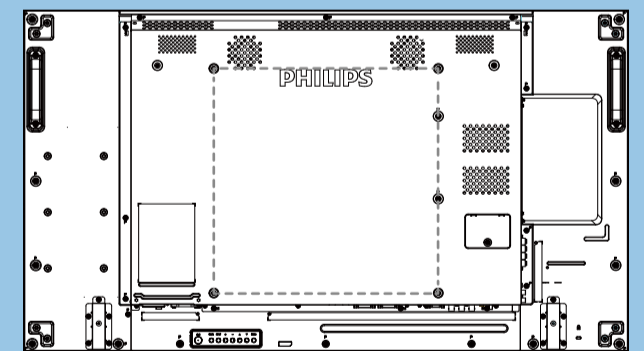
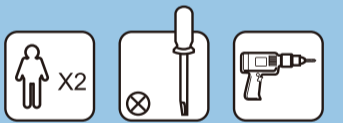

M6 * (10+X) mm
(X=Thickness of Wall mount BKT)
49BDL2005X: 400mm x 400mm

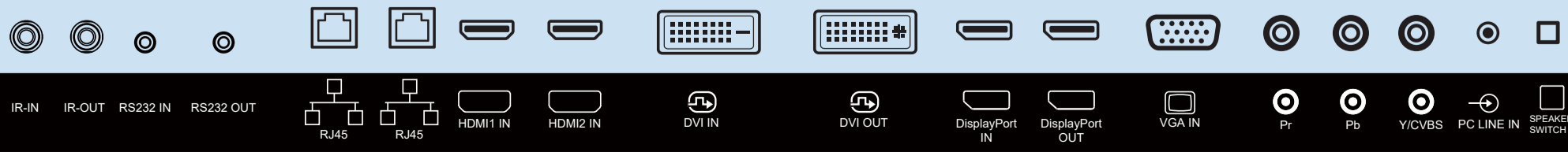

5

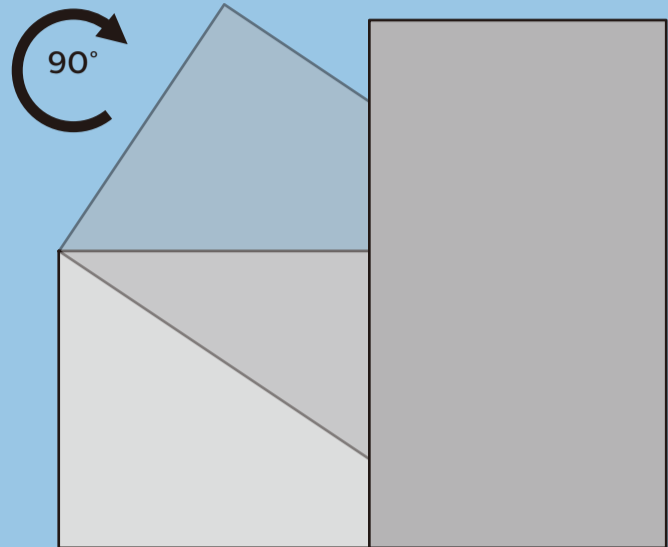

PHILIPS

Professional
Display Solutions

X Line

49BDL2005X

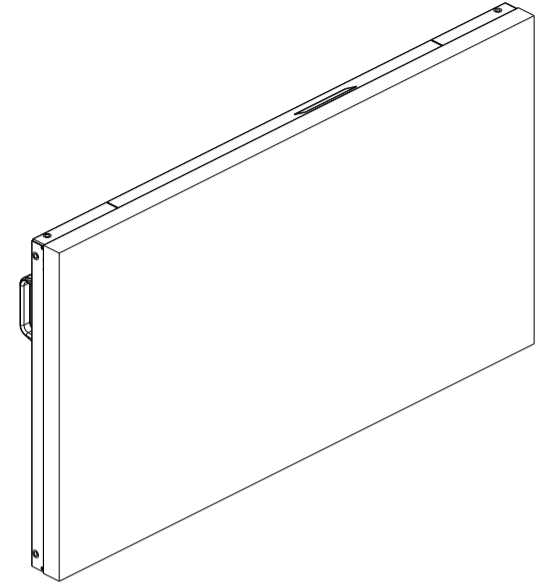

Quick Start



Please check out the website below for more product information.
www.philips.com/signagesolutions-support



Envision Peripherals Inc.
490 N McCarthy Blvd, Suite #120
Milpitas, CA 95035
USA

2021 © TOP Victory Investments Ltd. All rights reserved.
This product has been manufactured by and is sold under the responsibility of Top Victory Investments Ltd., and Top Victory Investments Ltd. is the warrantor in relation to this product. Philips and the Philips Shield Emblem are registered trademarks of Koninklijke Philips N.V. and are used under license.

Specifications are subject to change without notice.

Version: V1.01 2021-02-06



Q41G49M181327A