



\* All images in this datasheet are for illustrative purposes only.

**Video Wall** 49VL5G

# Incredible Immersion with Ultra-Narrow Bezel



Ultra-Narrow  
Bezel



Wide  
Viewing Angle



Easy Color  
Adjustment



Efficient  
Operation

## ACHIEVING INCREDIBLE IMMERSION



### Seamless Large Screens with Ultra-Narrow Bezel

The ultra-narrow bezel creates a visually stunning digital wall to effectively deliver dynamic content and immerse the viewers. The large screen it generates is enough to captivate the attention of passersby.

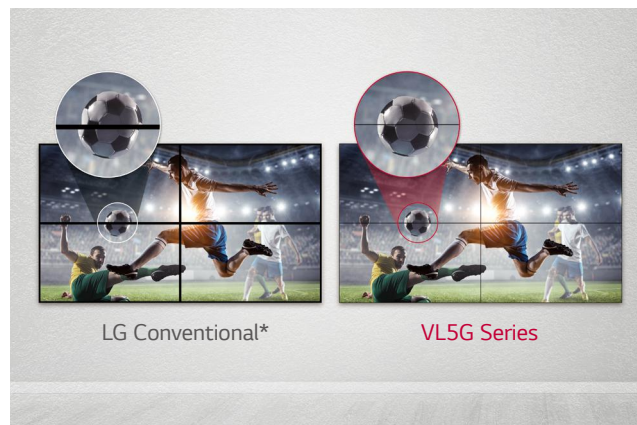

### Image Gap Reduction

The VL5G series includes an image improvement algorithm that can reduce image gaps among tiled displays when playing back videos. Objects located on the bezel boundaries are adjusted for a seamless viewing experience.

\* The "LG Conventional" refers to displays which do not include an image improvement algorithm.

## VIVID AND DYNAMIC PICTURE QUALITY



40\*\* High Viewing Angle

### Higher Viewing Angle

Large screens are usually positioned higher than human-eye level, making uniform picture quality essential for video walls. The viewing angle of the VL5G series is high enough to display vivid colors throughout the screen with no distortion.

\* Results based on in-house testing. Actual test results may differ depending on environment and measuring equipment.

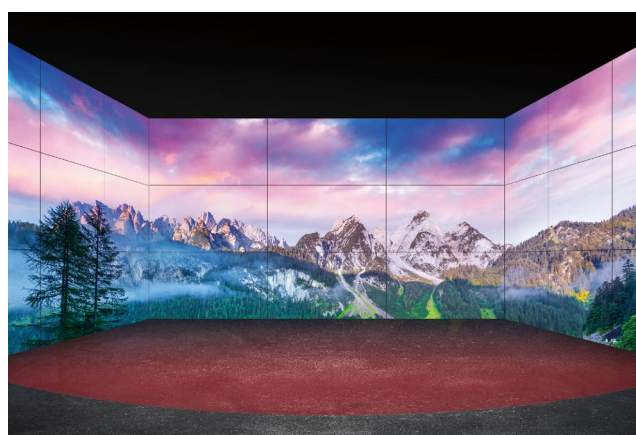

### Wide Viewing Angle

It is well known that LG IPS panel technology enables better control of liquid crystals, which in turn allows the screen to be viewed from virtually any angle. Because of this, the VL5G series captures the attention of and captivates more viewers with lifelike colors, regardless of their viewing position.

\* All images are intended to help you understand, and there may be some differences in practical use.

## USER CONVENIENCE

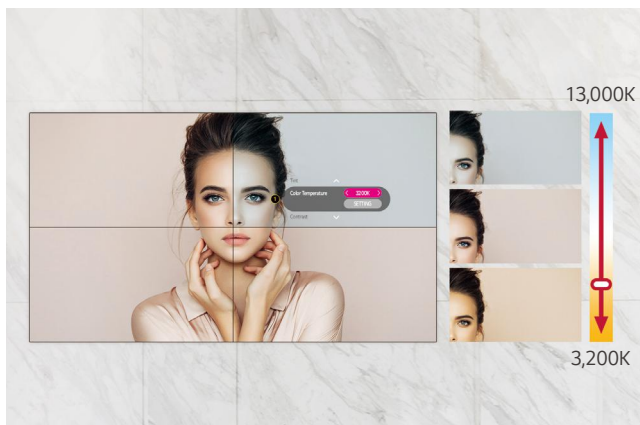

### Easy Color Adjustment

Depending on the content, the color temperature of the display can be easily adjusted in increments of 100K using a remote control.

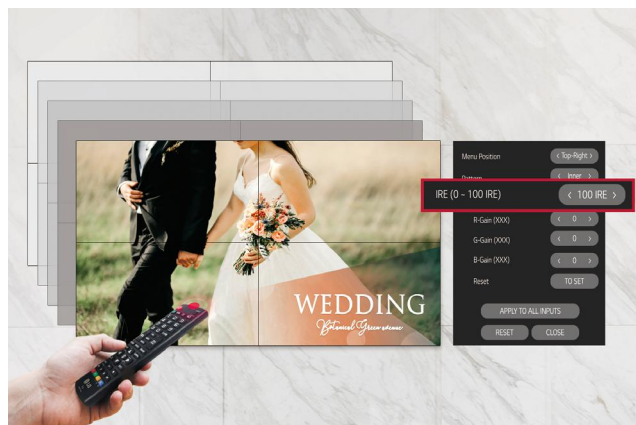

### White Balance Adjustment

In conventional video walls, white balance was adjustable only in “full-white” mode, but the VL5G series allows you to modify each value of grey scale to achieve more detailed and precise white balance adjustment.

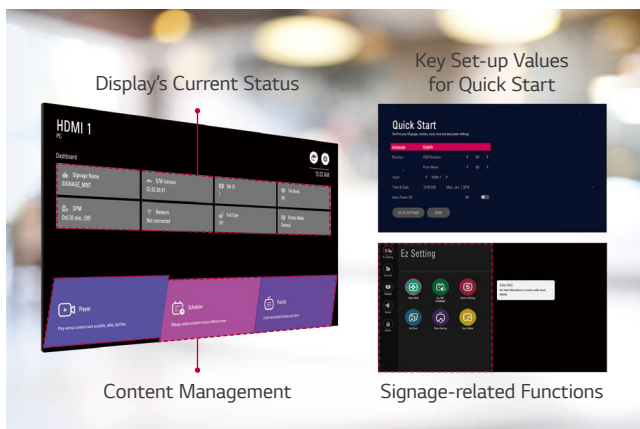

### User-Friendly Menu Structure

The menu structure has been optimized for commercial use. It simplifies approach flows and groups similar functions together, adopting a more intuitive GUI for ease of use. This way, users can avoid having to do trial-and-error when exploring desired functions and managing displays.

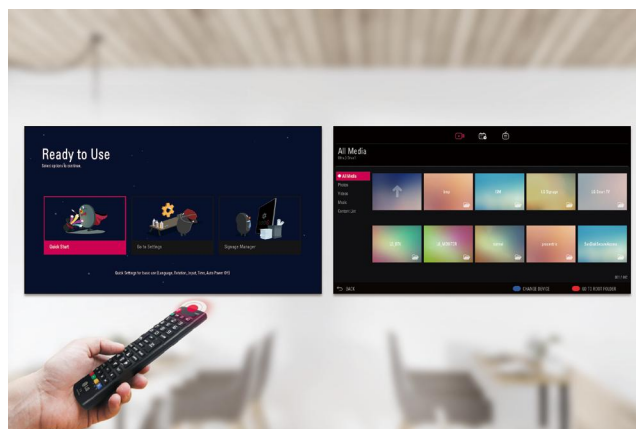

### Intuitive GUI

The GUI (Graphic User Interface) is carefully designed with a four-way navigation remote control that lets users easily switch to other settings. Also, it adopts a large font for better visibility, which is necessary when users want to control displays from relatively far distances.

\* All images are intended to help you understand, and there may be some differences in practical use.

# PRODUCT INFORMATION



## 49VL5G

Screen Size	49"
Aspect Ratio	16 : 9
Native Resolution	FHD (1,920 × 1,080)
Brightness	500 nit
Contrast Ratio	1,000 : 1

## DIMENSION

(unit: mm)

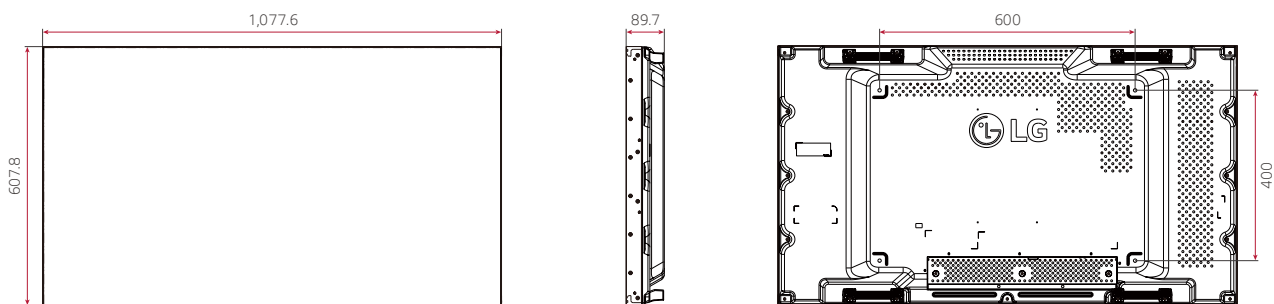

## CONNECTIVITY

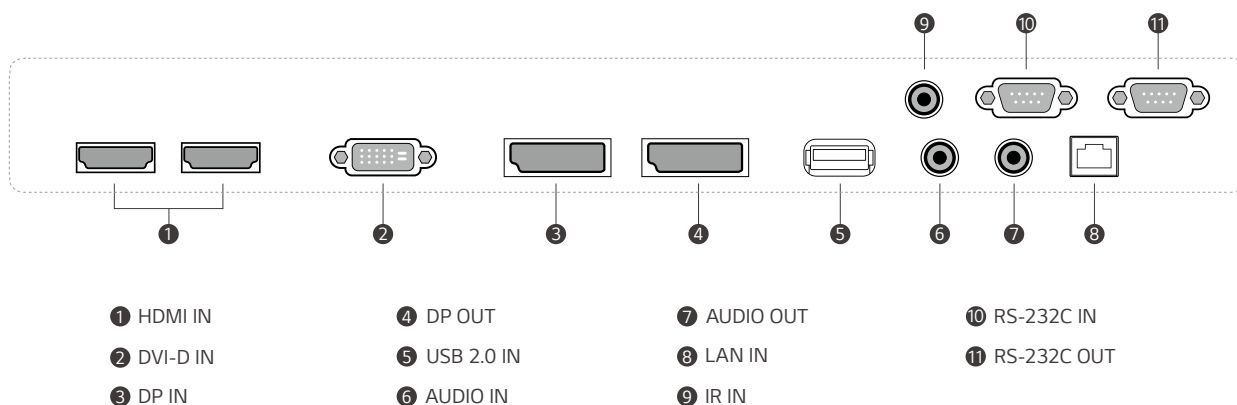

\* Dimensions & Jack Panels may differ from the above image, so please contact LG sales team to verify before ordering.



Download  
LG C-Display+  
Mobile App  
Google Play Store

- 🌐 [www.lg.com/global/business/information-display](http://www.lg.com/global/business/information-display)
- 📺 [www.youtube.com/c/LGCommercialDisplay](http://www.youtube.com/c/LGCommercialDisplay)
- 📘 [www.facebook.com/LGInformationDisplay](http://www.facebook.com/LGInformationDisplay)
- 🌐 [www.linkedin.com/company/lginformationdisplay](http://www.linkedin.com/company/lginformationdisplay)
- 🐦 [twitter.com/LG\\_ID\\_HQ](https://twitter.com/LG_ID_HQ)

LG may make changes to specifications and product descriptions without notice. Copyright © 2021 LG Electronics Inc. All rights reserved. "LG Life's Good" is a registered trademark of LG Corp. The names of products and brands mentioned here may be the trademarks of their respective owners.

