

Power Cord

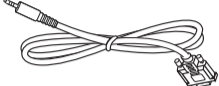

RS232 Cable

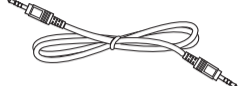

RS232 Daisy Chain Cable



IR Sensor Cable



HDMI Cable



DVI Cable

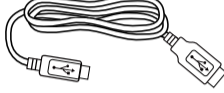

Touch USB



Philips logo plate



Cleaning cloth



USB Cover



Cable Clips 3PCS

* Differences according to regions.

Display design and accessories may differ from those illustrated above.

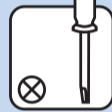

1

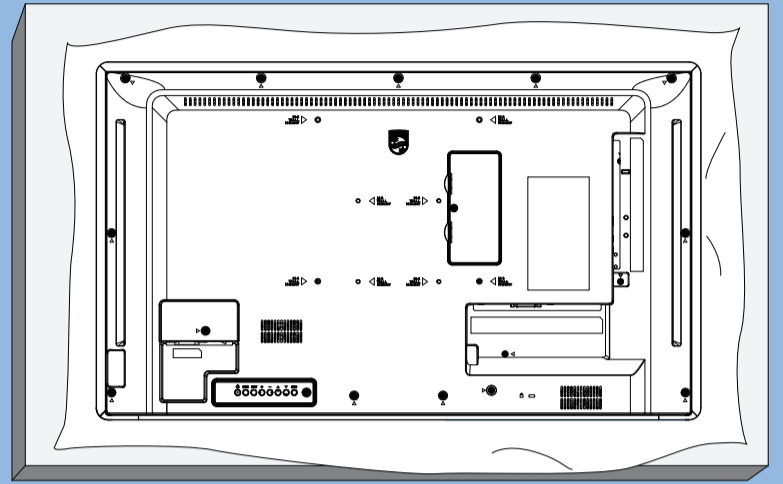

2

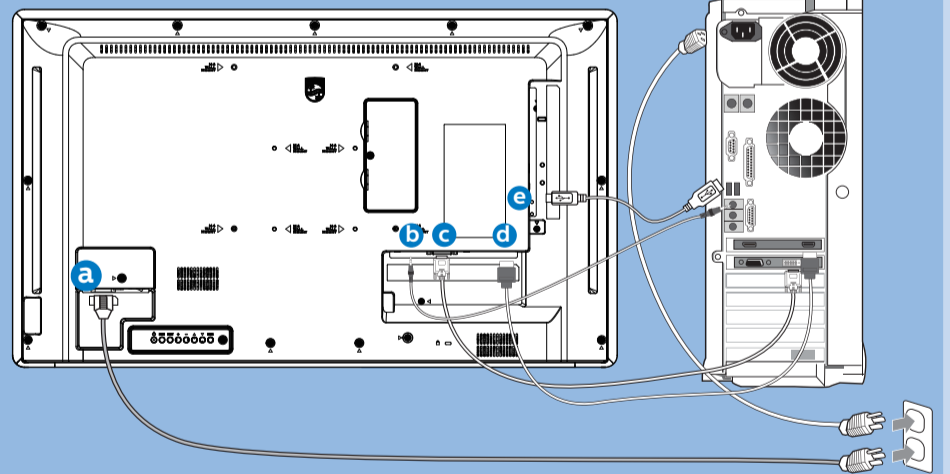
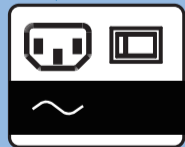
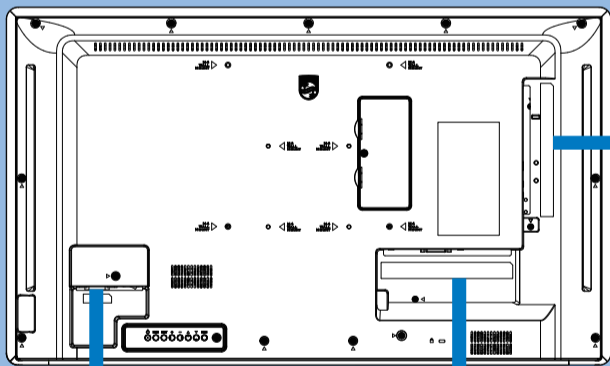

AC IN



AUDIO



DVI



HDMI



Touch USB

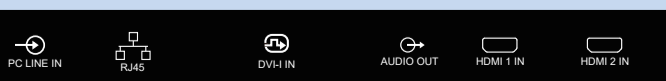
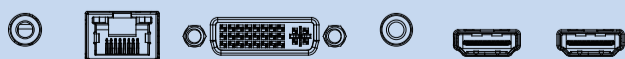

3

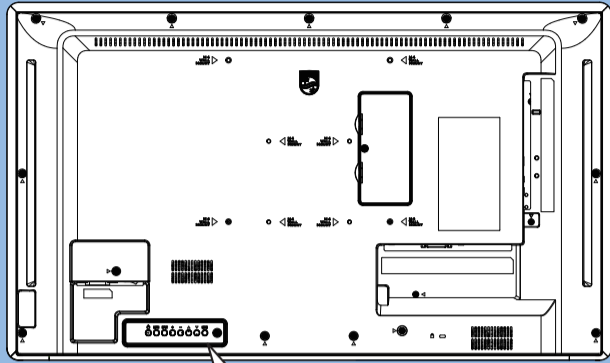

PHILIPS

Professional Display Solutions

T Line

32BDL3651T

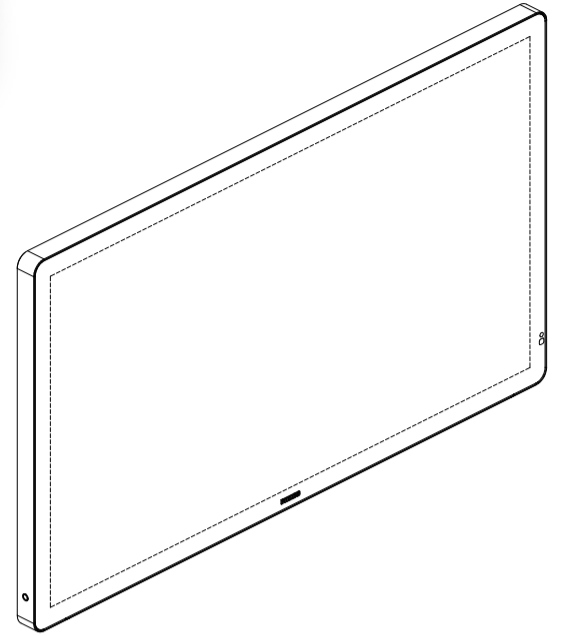

Quick Start



Please check out the website below for more product information.
www.philips.com/signagesolutions-support

4

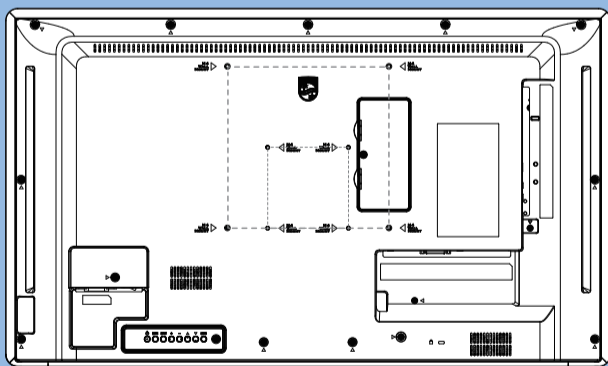

⚙ M4 * (10+X) mm
(X=Thickness of Wall mount BKT)

32BDL3651T: 100mmx100mm and 200mmx200mm



Envision Peripherals Inc.
490 N McCarthy Blvd, Suite #120
Milpitas, CA 95035
USA

2021 © TOP Victory Investments Ltd. All rights reserved.
This product has been manufactured by and is sold under the responsibility of Top Victory Investments Ltd., and Top Victory Investments Ltd. is the warrantor in relation to this product. Philips and the Philips Shield Emblem are registered trademarks of Koninklijke Philips N.V. and are used under license.

Specifications are subject to change without notice.

Version: V1.00 2021-01-06



Q41G32M181388A