

10BDL4551T
V1.00



www.philips.com/welcome

User Manual (English)

PHILIPS

SignageSolutions

Safety Instructions

Safety precautions and maintenance

This electronic user guide is intended for anyone who uses the Philips monitor. Take time to read this user manual before you use your monitor. It contains important information and notes regarding operating your monitor. The Philips guarantee applies provided the product is handled properly for its intended use, in accordance with its operating instructions and upon presentation of the original invoice or cash receipt, indicating the date of purchase, dealers name and model and production number of the product.



WARNING: Use of controls, adjustments or procedures other than those specified in this documentation may result in exposure to shock, electrical hazards and/or mechanical hazards.

Read and follow these instructions when connecting and using your display:

Operation:

- Keep the display out of direct sunlight and away from stoves or any other heat sources.
- Remove any object that could fall into ventilation holes or prevent proper cooling of the display's electronics.
- Do not block the ventilation holes on the cabinet.
- When positioning the display, make sure the power plug and outlet are easily accessible.
- When turning off the display by detaching the power cord or DC power cord, wait 6 seconds before re-attaching the power cord or DC power cord for normal operation.
- Ensure the use of an approved power cord provided by Philips at all times. If your power cord is missing, please contact your local service center.
- Do not subject the display to severe vibration or high impact conditions during operation.
- Do not knock or drop the display during operation or transportation.

Maintenance:

- To protect your display from possible damage, do not put excessive pressure on the LCD panel. When moving your display, grasp the frame to lift; do not lift the display by placing your hand or fingers on the LCD panel.
- Unplug the display if you are not going to use it for an extensive period of time.
- Unplug the display if you need to clean it with a slightly damp cloth. The screen may be wiped with a dry cloth when the power is off. However, never use organic solvent, such as, alcohol, or ammonia-based liquids to clean your display.
- To avoid the risk of shock or permanent damage to the set, do not expose the display to dust, rain, water or an excessively moist environment.
- If your display becomes wet, wipe it with dry cloth as soon as possible.
- If a foreign substance or water gets in your display, turn the power off immediately and disconnect the power cord. Then remove the foreign substance or water, and send the unit to the maintenance center.
- Do not store or use the display in locations exposed to heat, direct sunlight or extreme cold.
- In order to maintain the best performance of your display and ensure a longer lifetime, we strongly recommend using the display in a location that falls within the following temperature and humidity ranges.
 - Temperature: 0-40°C 32-104°F
 - Humidity: 10-85% RH

IMPORTANT: Always activate a moving screen saver program when you leave your display unattended. Always activate a periodic screen refresh application if the unit will display unchanging static content. Uninterrupted display of still or static images over an extended period may cause "burn in", also known as "after-imaging" or "ghost imaging", on your screen. This is a well-known phenomenon in LCD panel technology. In most cases, the "burned in" or "after-imaging" or "ghost imaging" will disappear gradually over a period of time after the power has been switched off.

WARNING: Severe “burn-in” or “after-image” or “ghost image” symptoms will not disappear and cannot be repaired. This is also not covered under the terms of your warranty.

Service:

- The casing cover should be opened only by qualified service personnel.
- If there is any need for repair or integration, please contact your local service center.
- Do not leave your display under direct sunlight.



If your display does not operate normally, having followed the instructions set out in this document, please contact a technician or your local service center.

Read and follow these instructions when connecting and using your display:



- Unplug the display if you are not going to use it for an extensive period of time.
- Unplug the display if you need to clean it with a slightly damp cloth. The screen may be wiped with a dry cloth when the power is off. However, never use alcohol, solvents or ammonia-based liquids.
- Consult a service technician if the display does not operate normally when you have followed the instructions in this manual.
- The casing cover should be opened only by qualified service personnel.
- Keep the display out of direct sunlight and away from stoves or any other heat sources.
- Remove any object that could fall into the vents or prevent proper cooling of the display’s electronics.
- Do not block the ventilation holes on the cabinet.
- Keep the display dry. To avoid electric shock, do not expose it to rain or excessive moisture.
- When turning off the display by detaching the power cable or DC power cord, wait for 6 seconds before re-attaching the power cable or DC power cord for normal operation..
- To avoid the risk of shock or permanent damage to the set do not expose the display to rain or excessive moisture.
- When positioning the display, make sure the power plug and outlet are easily accessible.
- **IMPORTANT:** Always activate a screen saver program during your application. If a still image in high contrast remains on the screen for an extended period of time, it may leave an ‘after-image’ or ‘ghost image’ on the front of the screen. This is a well-known phenomenon that is caused by the shortcomings inherent in LCD technology. In most cases the afterimage will disappear gradually over a period of time after the power has been switched off. Be aware that the after-image symptom cannot be repaired and is not covered under warranty.

EU Declaration of Conformity

This device complies with the requirements set out in the Council Directive on the Approximation of the Laws of the Member States relating to Electromagnetic Compatibility (2014/30/EU), Low-voltage Directive (2014/35/EU), RoHS directive (2011/65/EU), and Radio Equipment Directive (2014/53/EU).

This product has been tested and found to comply with the harmonized standards for Information Technology Equipment, these harmonized standards published under Directives of Official Journal of the European Union.

Radio Equipment Directive (2014/53/EU): EN60950-1/EN62311/EN300328/EN301489

ESD Warnings

When user close to the monitor may cause the equipment discharge and reboot to the display of main menu.

Warning:

This equipment is compliant with Class A of EN55032/CISPR 32. In a residential environment this equipment may cause radio interference.

Federal Communications Commission (FCC) Notice (U.S. Only)



NOTE: This equipment has been tested and found to comply with the limits for a Class A digital device, pursuant to part 15 of the FCC Rules. These limits are designed to provide reasonable protection against harmful interference when the equipment is operated in a commercial environment. This equipment generates, uses, and can radiate radio frequency energy and, if not installed and used in accordance with the instruction manual, may cause harmful interference to radio communications. Operation of this equipment in a residential area is likely to cause harmful interference in which case the user will be required to correct the interference at his own expense.



Changes or modifications not expressly approved by the party responsible for compliance could void the user's authority to operate the equipment.

Use only an RF shielded cable that was supplied with the display when connecting this display to a computer device. To prevent damage which may result in fire or shock hazard, do not expose this appliance to rain or excessive moisture.

USA:

WARNING: Changes or modifications to this unit not expressly approved by the party responsible for compliance could void the user's authority to operate the equipment.

This device complies with Part 15 of the FCC Rules. Operation is subject to the following two conditions: (1) This device may not cause harmful interference, and (2) this device must accept any interference received, including interference that may cause undesired operation.

Le présent appareil est conforme aux CNR d'ISED applicables aux appareils radio exempts de licence. L'exploitation est autorisée aux deux conditions suivantes : (1) le dispositif ne doit pas produire de brouillage préjudiciable, et (2) ce dispositif doit accepter tout brouillage reçu, y compris un brouillage susceptible de provoquer un fonctionnement indésirable.

Envision Peripherals Inc.
490 N McCarthy Blvd, Suite #120
Milpitas, CA 95035
USA

Radiation Exposure Statement:

This equipment complies with FCC/CE-RED radiation exposure limits set forth for an uncontrolled environment. This equipment should be installed and operated with minimum distance 20cm between the radiator & your body.

Déclaration d'exposition aux radiations: Cet équipement est conforme aux limites d'exposition aux rayonnements ISED établies pour un environnement non contrôlé. Cet équipement doit être installé et utilisé avec un minimum de 20 cm de distance entre la source de rayonnement et votre corps.

The suitable temperature for the Color Monitor and accessories is 0°C -45°C .

Adaptor with ferrite must be used with this equipment to ensure compliance with the Class A FCC limits.

Power Adapter information:

Model No.: ADS-26SGP-12 12024E

INPUT: 100-240V~50/60Hz 0.6A

OUTPUT: 12Vdc 2.0A

Waste Electrical and Electronic Equipment-WEEE

Attention users in European Union private households



This marking on the product or on its packaging illustrates that, under European Directive 2012/19/EU governing used electrical and electronic appliances, this product may not be disposed of with normal household waste. You are responsible for disposal of this equipment through a designated waste electrical and electronic equipment collection. To determine the locations for dropping off such waste electrical and electronic, contact your local government office, the waste disposal organization that serves your household or the store at which you purchased the product.

Attention users in United States:

Please dispose of according to all Local, State and Federal Laws. For the disposal or recycling information, contact: www.mygreenelectronics.com or www.eiae.org.

End of Life Directives-Recycling



Your new Public Information Display contains several materials that can be recycled for new users.

Please dispose of according to all Local, State, and Federal laws.

CAUTION

RISK OF EXPLOSION IF BATTERY IS REPLACED BY AN INCORRECT TYPE.

DISPOSE OF USED BATTERIES ACCORDING TO THE INSTRUCTIONS.



CAUTION

Risk of explosion if the battery is replaced by an incorrect type

Wait one-half hour after switching off before handling parts

- Replacement of a battery with an incorrect type that can defeat a safeguard (for example, in the case of some lithium battery types);
- Disposal of a battery into fire or a hot oven, or mechanically crushing or cutting of a battery, that can result in an explosion;
- Leaving a battery in an extremely high temperature surrounding environment that can result in an explosion or the leakage of flammable liquid or gas;

A battery subjected to extremely low air pressure that may result in an explosion or the leakage of flammable liquid or gas.

NOTICE SOFTWARE END USER LICENSE AGREEMENT

THIS SOFTWARE END USER LICENSE AGREEMENT (THIS “AGREEMENT”) IS A LEGAL AND BINDING AGREEMENT BETWEEN YOU (EITHER AN INDIVIDUAL OR ENTITY) AND MMD MONITORS & DISPLAYS NEDERLAND B.V., A DUTCH LIMITED LIABILITY COMPANY, WITH ITS PRINCIPAL OFFICE AT PRINS BERNHARDPLEIN 200, 1097 JB AMSTERDAM, THE NETHERLANDS AND ITS SUBSIDIARY COMPANIES (INDIVIDUALLY AND COLLECTIVELY “MMD”). THIS AGREEMENT GIVES YOU THE RIGHT TO USE CERTAIN SOFTWARE (THE “SOFTWARE”) INCLUDING USER DOCUMENTATION IN ELECTRONIC FORM WHICH MAY HAVE BEEN PROVIDED SEPARATELY OR TOGETHER WITH A MMD PRODUCT (THE DEVICE”). BY DOWNLOADING, INSTALLING OR OTHERWISE USING THE SOFTWARE, YOU ACCEPT AND AGREE TO BE BOUND BY ALL OF THE TERMS AND CONDITIONS OF THIS AGREEMENT. IF YOU DO NOT AGREE TO THESE TERMS AND CONDITIONS, DO NOT DOWNLOAD, INSTALL OR OTHERWISE USE THE SOFTWARE. IF YOU ACQUIRED THE SOFTWARE IN TANGIBLE MEDIA E.G. CD WITHOUT THE OPPORTUNITY TO REVIEW THIS LICENSE AND DO NOT ACCEPT THESE TERMS, YOU MAY RECEIVE A FULL REFUND OF THE AMOUNT, IF ANY, THAT YOU PAID FOR THE SOFTWARE IF YOU RETURN THE SOFTWARE UNUSED WITH PROOF OF PAYMENT WITHIN 30 DAYS FROM THE DATE OF PURCHASE.

1. Grant of License. This Agreement grants you a non-exclusive, nontransferable, non-sub licensable license to install and use, on the Device, one (1) copy of the specified version of the Software in object code format as set out in the user documentation solely for your personal use. The Software is “in use” when it is loaded into the temporary or permanent memory (i.e. RAM, hard disk, etc.) of the Device.

2. Ownership. The Software is licensed and not sold to you. This Agreement grants you only the right to use the Software, but you do not acquire any rights, express or implied, in the Software other than those specified in this Agreement. MMD and its licensors retain all right, title, and interest in and to the Software, including all patents, copyrights, trade secrets, and other intellectual property rights incorporated therein. The Software is protected by copyright laws, international treaty provisions, and other intellectual property laws. Therefore, other than as expressly set forth herein, you may not copy the Software without prior written authorization of MMD, except that you may make one (1) copy of the Software for your back-up purposes only. You may not copy any printed materials accompanying the Software, nor print more than one (1) copy of any user documentation provided in electronic form, except that you may make one (1) copy of such printed materials for your back-up purposes only.

3. License Restrictions. Except as provided otherwise herein, you shall not rent, lease, sublicense, sell, assign, loan, or otherwise transfer the Software. You shall not, and you shall not permit any third party, to reverse engineer, decompile, or disassemble the Software, except to the extent that applicable law expressly prohibits the foregoing restriction. You may not remove or destroy any product identification, copyright notices, or other proprietary markings or restrictions from the Software. All titles, trademarks, and copyright and restricted rights notices shall be reproduced on your back up copy of the Software. You may not modify or adapt the Software, merge the Software into another program or create derivative works based upon the Software.

4. Disclaimer. THE SOFTWARE IS DESIGNED TO ASSIST YOU IN TRANSFERRING MATERIAL IN WHICH YOU OWN THE COPYRIGHT OR HAVE OBTAINED PERMISSION TO GRAB AND TRANSFER FROM THE COPYRIGHT OWNER. UNLESS YOU OWN THE COPYRIGHT OR HAVE PERMISSION TO GRAB AND TRANSFER FROM THE COPYRIGHT OWNER, YOU MAY BE VIOLATING COPYRIGHT LAW AND BE SUBJECT TO PAYMENT OF DAMAGES AND OTHER REMEDIES. IF YOU ARE UNCERTAIN ABOUT YOUR RIGHTS, YOU SHOULD CONTACT YOUR LEGAL ADVISOR. YOU ASSUME FULL RESPONSIBILITY FOR THE LEGAL AND RESPONSIBLE USE OF THE SOFTWARE

5. Open Source Software. (a) This software may contain components that are subject to open-source terms, as stated in the documentation accompanying the Device. This Agreement does not apply to this software as such. **(b)** Your license rights under this Agreement do not include any right or license to use, distribute or create derivative works of the Software in any manner that would subject the Software to Open Source Terms. “Open Source Terms” means the terms of any license that directly or indirectly (1) create, or purport to create, obligations for MMD with respect to the Software and/or derivative works thereof; or (2) grant, or purport to grant, to any third party any rights or immunities under intellectual property or proprietary rights in the Software or derivative works thereof.

6. Termination. This Agreement shall be effective upon installation or first use of the Software and shall terminate (i) at the discretion of MMD, due to your failure to comply with any term of this Agreement; or (ii) upon destruction of all copies of the Software and related materials provided to you by MMD hereunder. MMD’s rights and your obligations shall survive the termination of this Agreement.

7. Upgrades. MMD may, at its sole option, make upgrades to the Software available by general posting on a website or by any other means or methods. Such upgrades may be made available pursuant to the terms of this Agreement or the release of such upgrades to you may be subject to your acceptance of another agreement.

8. Support Services. MMD is not obligated to provide technical or other support (“Support Services”) for the Software. If MMD does provide you with Support Services, these will be governed by separate terms to be agreed between you and MMD.

9. Limited Software Warranty. MMD provides the Software ‘as is’ and without any warranty except that the Software will perform substantially in accordance with the documentation accompanying the Software for a period of one year after your first download, installation or use of the Software, whichever occurs first. MMD’s entire liability and your exclusive remedy for breach of this warranty shall be, at MMD’s option, either (i) return of the price paid by you for the Software (if any); or (ii) repair or replacement of the Software that does not meet the warranty set forth herein and that is returned to MMD with a copy

of your receipt. This limited warranty shall be void if failure of the Software has resulted from any accident, abuse, misuse or wrongful application. Any replacement Software will be warranted for the remainder of the original warranty period or thirty (30) days, whichever is longer. This limited warranty shall not apply to you if the Software was provided to you free of charge on an evaluation only basis.

10. NO OTHER WARRANTIES. EXCEPT AS SET FORTH ABOVE, MMD AND ITS LICENSORS DO NOT WARRANT THAT THE SOFTWARE WILL OPERATE ERROR FREE OR UNINTERRUPTED, OR WILL MEET YOUR REQUIREMENTS. YOU ASSUME ALL RESPONSIBILITIES FOR SELECTION OF THE SOFTWARE TO ACHIEVE YOUR INTENDED RESULTS, AND FOR THE INSTALLATION OF, USE OF, AND RESULTS OBTAINED FROM THE SOFTWARE. TO THE MAXIMUM EXTENT PERMITTED BY APPLICABLE LAW, MMD AND ITS LICENSORS DISCLAIM ALL WARRANTIES AND CONDITIONS, WHETHER EXPRESS OR IMPLIED, INCLUDING BUT NOT LIMITED TO THE IMPLIED WARRANTIES OF MERCHANTABILITY, FITNESS FOR A PARTICULAR PURPOSE, AND ACCURACY OR COMPLETENESS OF RESULTS WITH RESPECT TO THE SOFTWARE AND THE ACCOMPANYING MATERIALS. THERE IS NO WARRANTY AGAINST INFRINGEMENT. MMD DOES NOT WARRANT THAT YOU WILL BE ABLE TO DOWNLOAD, COPY, STORE, DISPLAY, TRANSFER, AND/OR PLAY SECURE CONTENT.

11. LIMITATION OF LIABILITY. UNDER NO CIRCUMSTANCES WILL MMD OR ITS LICENSORS BE LIABLE FOR ANY CONSEQUENTIAL, SPECIAL, INDIRECT, INCIDENTAL OR PUNITIVE DAMAGES WHATSOEVER, INCLUDING, WITHOUT LIMITATION, DAMAGES FOR LOSS OF PROFITS OR REVENUES, BUSINESS INTERRUPTION, LOSS OF BUSINESS INFORMATION, LOSS OF DATA, LOSS OF USE OR OTHER PECUNIARY LOSS, EVEN IF MMD OR ITS LICENSORS HAVE BEEN ADVISED OF THE POSSIBILITY OF SUCH DAMAGES. IN NO EVENT SHALL MMD'S OR ITS LICENSORS' AGGREGATE LIABILITY FOR DAMAGES ARISING OUT OF THIS AGREEMENT EXCEED THE GREATER OF THE PRICE ACTUALLY PAID BY YOU FOR THE SOFTWARE OR FIVE POUNDS STERLING (5.00).

12. Trademarks. Certain of the product and MMD names used in this Agreement, the Software, and the printed user documentation may constitute trademarks of the MMD, its licensors or other third parties. You are not authorized to use any such trademarks.

13. Export Administration. You agree that you will not directly or indirectly, export or re-export the Software to any country for which the United States Export Administration Act, or any similar United States law or regulation requires an export license or other U.S. Government approval, unless the appropriate export license or approval has first been obtained. By downloading or installing the Software you agree to abide by this Export provision.

14. Governing law. This Agreement is governed by the laws of the Netherlands, without reference to its conflict of laws principles. This Agreement shall not be governed by the United Nations Convention on Contracts for the International Sale of Goods, the application of which is expressly excluded. Any dispute between you and MMD regarding this Agreement shall be subject to the non-exclusive jurisdiction of the courts of the Netherlands. If for any reason a court of competent jurisdiction finds any provision, or portion thereof, to be unenforceable, the remainder of this Agreement shall continue in full force and effect.

15. General. This Agreement contains the entire agreement between you and MMD and supersedes any prior representation, undertaking or other communication or advertising with respect to the Software and user documentation. If any part of this Agreement is held invalid, the remainder of this Agreement will continue in full force and effect. This Agreement shall not prejudice the statutory rights of any party dealing as a consumer.

Table Of Contents

1.	Unpacking and Installation	1
1.1.	Package Contents	1
1.2.	Installation.....	2
2.	Physical view and features	5
2.1.	Front View	5
2.2.	Top View	5
2.3.	Rear View.....	6
2.4.	IO Port.....	7
3.	Cleaning and Troubleshooting.....	8
3.1.	Cleaning	8
3.2.	Troubleshooting.....	8
4.	Technical Data	9
4.1.	Specifications	9
4.2.	Disclaimer	10
5.	Operation	10
5.1.	Setup wizard.....	10
5.1.1.	Setup wizard flow:	10
5.1.2.	Welcome	11
5.1.3.	Security Setting.....	11
5.1.4.	Signage Display Settings.....	11
5.1.5.	Network Setting.....	12
5.1.6.	Clone Media Files into internal.....	12
5.1.7.	Setup Complete.....	12
5.2.	Android Launcher	13
5.2.1.	Platform launcher.....	13
5.2.2.	Admin mode:.....	13
5.3.	Setting menu.....	15
5.3.1.	Network & Internet.....	15
5.3.2.	Signage Display.....	17
5.3.3.	Apps	22
5.3.4.	Display	22
5.3.5.	Sound.....	23
5.3.6.	Security.....	23
5.3.7.	System	23
5.3.8.	Appendix.....	24

1. Unpacking and Installation

Before installing the display

- This product is packed in a carton, together with the standard accessories.
- Any other optional accessories will be packed separately.
- After opening the carton, ensure that the contents are complete and in good condition.

1.1. Package Contents

Please verify that you received the following items with your package content:

- Colour Monitor
- Quick start guide
- USB cable
- HDMI cable
- Silicon Foot
- Stand Bar
- DC Power adapter
- Power Plug



Colour Monitor



Quick Start Guide



USB Cable

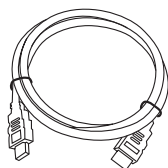

HDMI Cable



Silicon Foot



Stand Bar

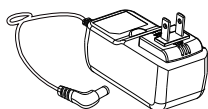

DC Power Adapter



Power Plug
(Provided by regions)

* Items may differ in different locations

* Display design and accessories may differ from the images shown.

1.2. Installation

Securing the power and network cable

1. Insert power plug

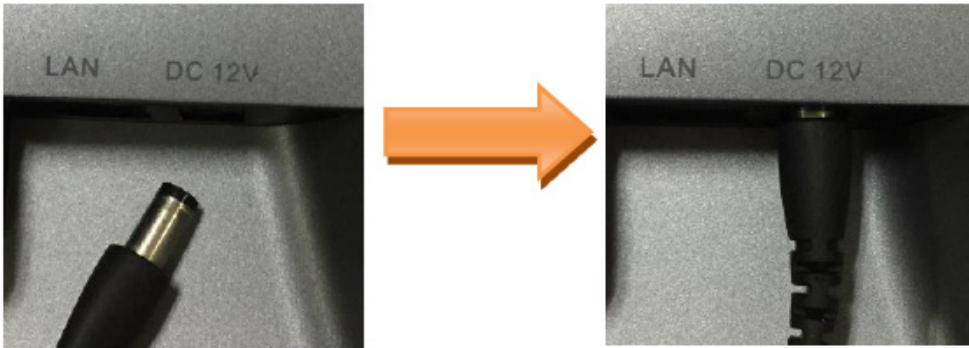

2. Securing Micro SD card: Insert SD card bracket

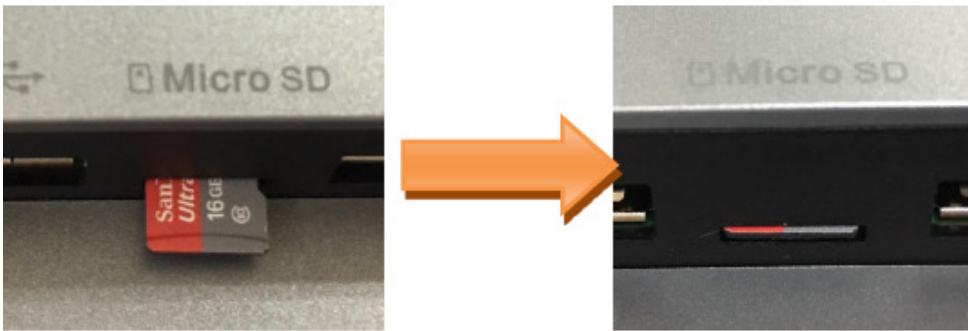

Installing the table stand

Simply screw the supplied table stand onto the stand screw hole.

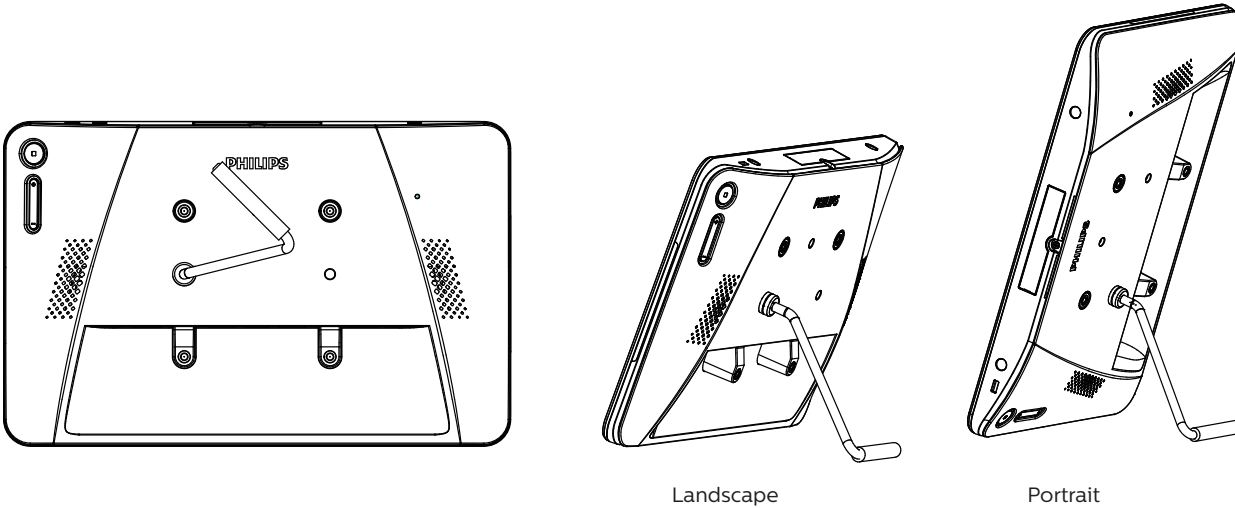

Mounting and installation

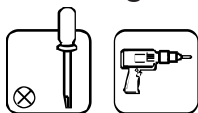

Mounting Option 1: [VESA mount]

Supporting VESA standard: VESA MIS-D75 (75*75mm)

Supporting screw: M4*4mm (exclude the mounting plate thickness)

The equipment and its associated mounting facilities still remain secure during the test. Use only the UL listed VESA mount with a minimum weight/load of the weight of the unit without base.

* Installation height: <2 m

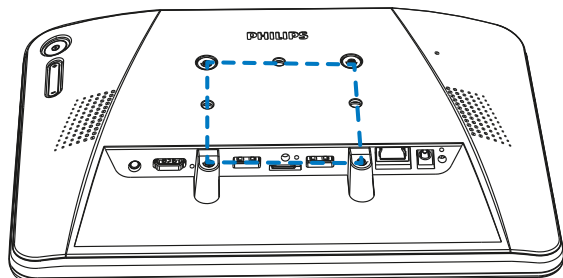

Mounting Option 2: [Using back cover]

Supporting screw: Self-tapping screw*3pcs (exclude the mounting plate thickness)

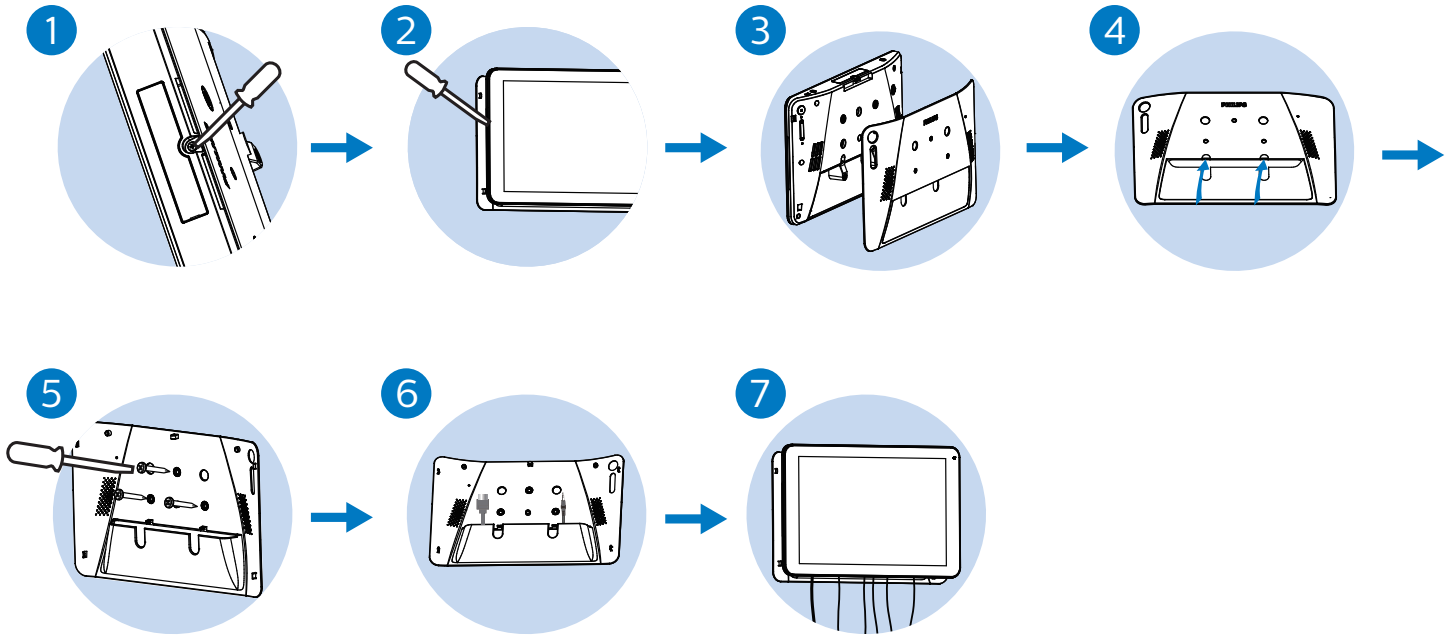

Step 1 Use a screwdriver to loosen the screw on the left side of the back cover.

Step 2 Use a screwdriver to detach the back cover.

Step 3 Remove the back cover from the signboard.

Step 4 Stick the silicon gaskets (provided) on the back cover (as indicated below)

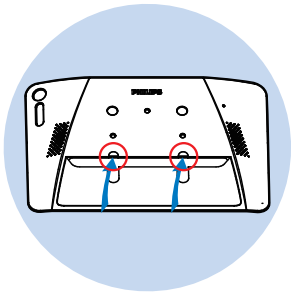

Step 5 To mount the back cover to the wall, flip over the back cover, the “Philips” logo should face the wall. Use a screwdriver to insert nails (x3) into the holes (indicated below) of back cover, then fix the back cover to the wall.

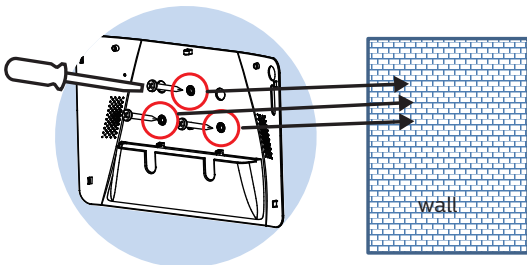

Step 6 Plug the power cable to the “DC12V” port, then connect the network cable to “LAN” port of the signboard.

Step 7 Insert the signboard carefully into the back cover which is already mounted on the wall.

2. Physical view and features

2.1. Front View

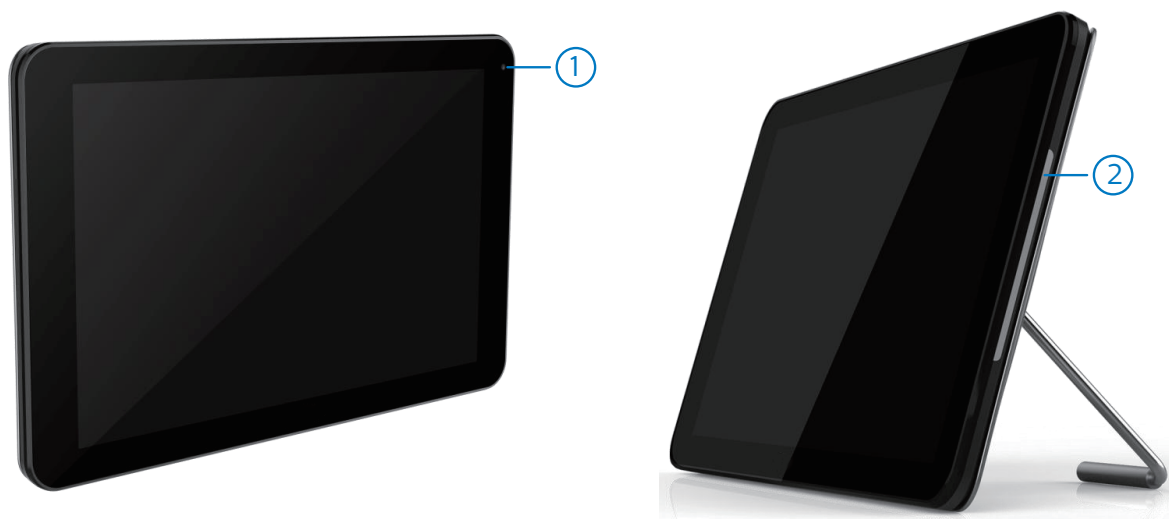

- ① Front Camera
2M
- ② RGB LED (Left & Right)
Default: OFF
Use SICP to turn On and set RGB

2.2. Top View

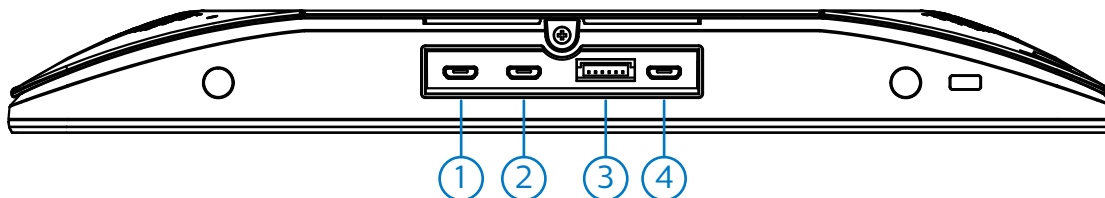

- ① - ② [Host USB]
Micro USB, Support USB external device.
- ③ Expansion Port(Reserved)
- ④ Micro USB
Support ADB data transmission, don't support OTG.

2.3. Rear View

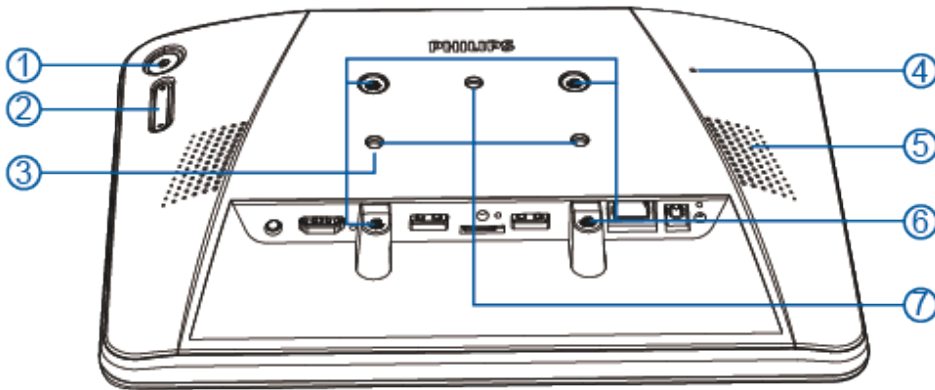

- ① [Menu] Button
- ② [Volume +/-]
Volume up and down

Key	Function
Menu + Volume-	Launch Admin mode app
Menu + Volume+	Launch Quick Information app
Menu + Menu + Volume+ + Volume- + Volume- + Volume+	Enable touch function
Menu + Menu + Volume- + Volume-	Turn on the screen

- ③ [Stand screw hole]
- ④ [Reset] Button
Factory Reset
- ⑤ [Speaker Hole]
- ⑥ [VESA mount]
Screw spec: M4
- ⑦ [Wall Mount Screw Hole]

2.4. IO Port

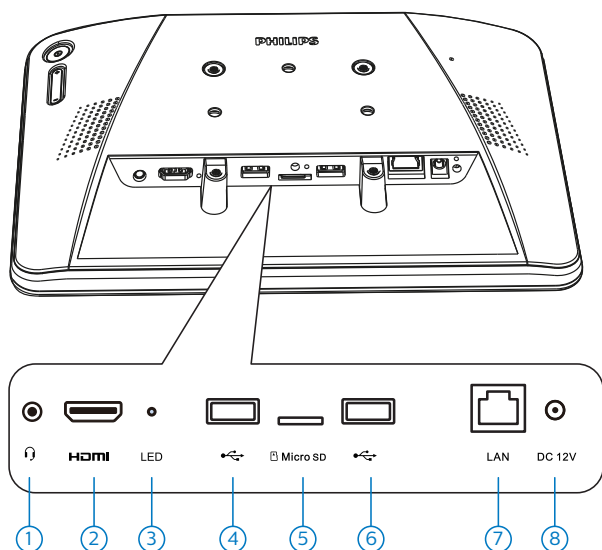

- ① [Ear jack]
3.5mm Ear Jack (CTIA standard) with mic in
- ② [HDMI OUT]
HDMI video/audio output
- ③ [LED]
Power on --> LED change to yellow after 5s --> LED change to Green when PHILIPS LOGO appear.
- ④ + ⑥ [Micro USB]
Support USB external device.
- ⑤ [Micro SD]
Connect your Micro SD card.
- ⑦ [LAN]
* LAN control function for the use of remote control signal from control center.
* PoE+ (power over Ethernet): 24W

Status	Green	Yellow
NC	OFF	OFF
10Mbps	ON (Flicker)	OFF
100Mbps	ON (Flicker)	ON

- ⑧ [DC 12V]
Switch the AC adapter on/off

3. Cleaning and Troubleshooting

3.1. Cleaning

Caution When Using the Monitor

- * Be sure to disconnect all cables before moving the monitor. Moving the monitor with its cables attached may damage the cables and thus cause fire or electric shock.
- * Disconnect the power plug from the wall outlet as a safety precaution before carrying out any type of cleaning or maintenance procedure.

Front Panel Cleaning Instructions

- * The front of the display has been specially treated. Wipe the surface gently using only a cleaning cloth or a soft, lint-free cloth.
- * If the surface becomes dirty, soak a soft, lint-free cloth in a mild detergent solution. Wring the cloth to remove excess liquid. Wipe the surface of the display to remove dirt. Then use a dry cloth of the same type to dry.
- * Do not scratch or hit the surface of the panel with fingers or hard objects of any kind.
- * Do not use volatile substances such as insect sprays, solvents and thinners.

3.2. Troubleshooting

Symptom	Possible Cause	Remedy
No picture is displayed	<ol style="list-style-type: none"> 1. The adapter is disconnected. 2. The monitor is standby mode 	<ol style="list-style-type: none"> 1. Make sure the power LED is green. Or plug in the adapter. 2. Menu + Menu + Volume- + Volume-, turn on the screen.
HDMI output is abnormal	<ol style="list-style-type: none"> 1. HDMI cable is not connected properly. 2. The External device is abnormal. 	<ol style="list-style-type: none"> 1. Make sure the HDMI cables attached firmly. 2. Check the external device is ok
Micro USB HOST & Type A USB HOST & LAN interface is abnormal.	<ol style="list-style-type: none"> 1. USB cable or output device is abnormal. 2. The cable is not connected properly. 	<ol style="list-style-type: none"> 1. Make sure USB Cable or output device is ok. 2. make sure the cable is connected properly and the RJ45 interface LED is green.
Can't read USB device and SD card.	The USB device and SD card is disabled.	Press "MENU" button, choose "setting" to enable the function.
The screen display normal but can't use touch function.	Touch function is disabled.	Menu + Menu + Volume+ + Volume- + Volume- + Volume+, enable touch function.

4. Technical Data

4.1. Specifications

Monitor	10.1" HD panel 10 points multi-touch Programming LED strip x 2 300 cd/m ² maximum Luminance 1280x800 panel resolution Viewing angle (H/V): 175/175 Built-in speaker 2W x 2
Video format support	MPEG1/2(DAT, MPG, VOB, TS) MPEG4(AVI, MKV, MP4, MOV, 3GP) H.263(3GP, MOV, MP4) H.264(AVI, MKV, MP4, MOV, 3GP, TS, FLV) GOOGLE VP8(WEBM) Motion JPEG(AVI, MOV)
Image format support	JPEG,BMP,GIF,PNG
Audio codec support	MPEG1/2/2.5 Audio Layer1/2/3(MP2, MP3) WMA Version 4,4.1, 7, 8, 9, wmapro (WMA) MAIN, ADIF ,ATDS Header AAC-LC and AAC-HE(AAC,M4A)
Dynamic content	W3C HTML5 (HTML, CSS, JavaScript) W3C SMIL 3.0 instructions (sub-set)
Physical I/O connectors	3.5mm analog stereo audio out port HDMI output port RJ45 Ethernet port Micro SD card slot(up to 32GB micro SDHC) DC -in Jack for charging(12V 2.0A) Micro USB for ADB *1 Micro USB for host*2 Type A host ports*2 reserved expansion port
Local storage	8 GB eMMC with Micro SD card expansion slot
Accessories	DC Power adapter (adapter Manufacturer: Honor / Model: ADS-26SGP-12 12024E/100-240VAC,50/60Hz, 0.7A) HDMI Cable USB Cable Stand Bar Silicon Foot Power plug(US/EU/UK) Quick start guide
Power requirement	12V 2.0A DC 802.3af compliance PoE, power over Ethernet
Power consumption*	10.96 watts max
Environmental	Operating temperature: 0 – 40° C / 32 – 104° F Storage Humidity: 10 – 85% @ 40° C / 104° F non-condensing
Dimensions	261 x 167.2 x 29 mm
Weight	0.740kg
Safety	UL/CB certified AC adapters
Certifications	CE/FCC
Warranty	One-year limited parts & labor

4.2. Disclaimer

Image Retention Disclaimer

When an image is monitored on-screen for prolonged periods of time, you may see a faint image after it is replaced. This is expected normal behavior for monitors.

Image retention may be reduced by:

- * Avoiding still images shown on-screen for more than a few minutes
- * Using non-contrasting colors and brightness
- * Using background colors other than gray

5. Operation

5.1. Setup wizard

5.1.1. Setup wizard flow:

Android Setup Wizard

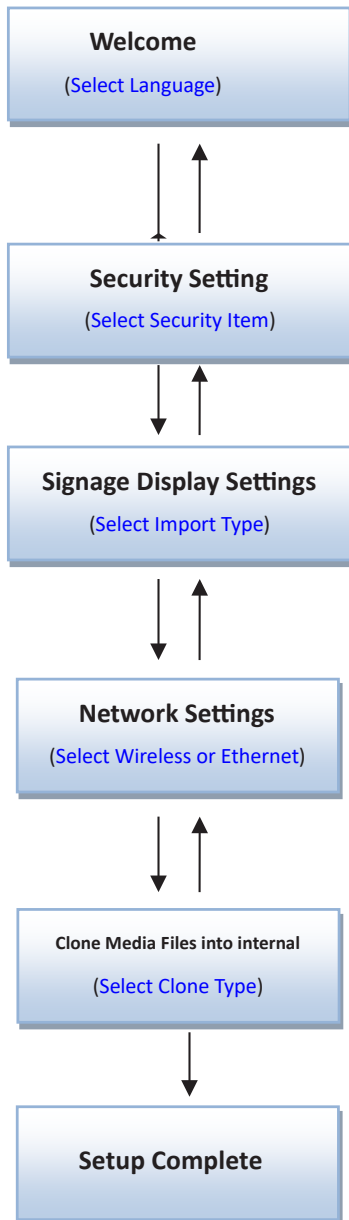

(1)The default of Navigation bar is “enable”. You can see it through all setup wizard flow.

(2)Only the 1st time you enter Android mode will go to setup wizard.

(3)Do Factory reset in Android mode, it will run setup wizard again.

Switch forward/backward among pages

(1). Welcome

Start: Network Settings

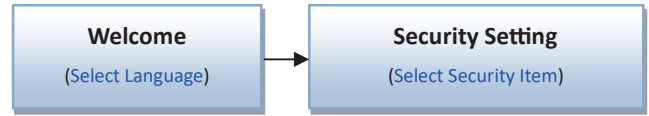

(2). Security Setting

Back Page: Welcome

Next Page: Signage Display Settings

Skip Page: Signage Display Settings

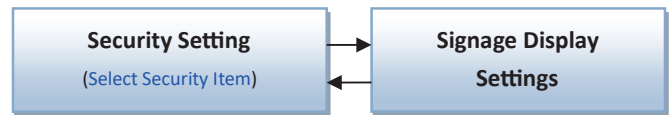

(3). Signage Display Settings

Back Page: Security Setting

Next Page: Import from SD / Import from USB / Manual Setup

Skip Page: Network Settings

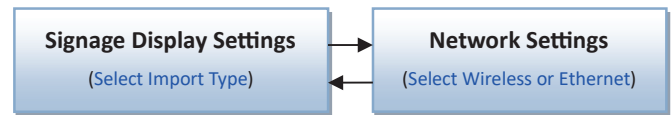

(3-1) Manual Setup

Back Page: Signage Display Settings

(4). Network Settings

Back Page: Signage Display Settings

Next Page: Wireless / Ethernet

Skip Page: Clone Media Files into internal

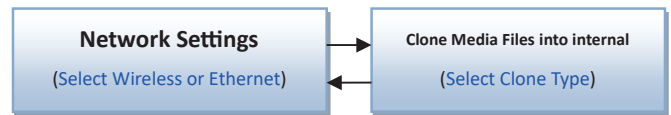

(4-1) Sub Page

Wi-Fi

Back Page: Network Settings

Next Page: Clone Media Files into internal Ethernet

Back Page: Network Settings

Next Page: Clone Media Files into internal

(5).Clone Media Files into internal

Back Page: Network Settings

Next Page: Setup Complete

Skip Page: Setup Complete

(6).Setup Complete

Finish: go to boot on source.

5.1.2. Welcome

Select the language and click “Start” to start settings.

The default of the Navigation bar is “enable”. So you can see it in the bottom.

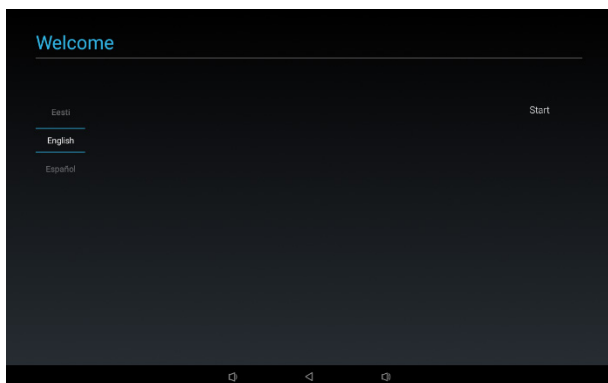

(1). Support Language

We support 22 OSD languages.

No	Support Language
1	ENGLISH
2	SPANISH
3	FRENCH
4	ITALIAN
5	LATVIAN
6	LITHUANIAN
7	DUTCH
8	NORWEGIAN
9	POLSKI
10	PORTUGUESE
11	FINNISH
12	SWEDISH
13	TURKISH
14	RUSSIAN
15	ARABIC
16	SIMPLIFIED CHINESE
17	TRADITIONAL CHINESE
18	JAPANESE
19	CZECH
20	DANISH
21	GERMAN
22	ESTONIAN

5.1.3. Security Setting

You can select which security item to open:

*SICP Network Port

*FTP

*ADB Over Network

*SNMP

You can click “Skip” if you do not want to open security items.

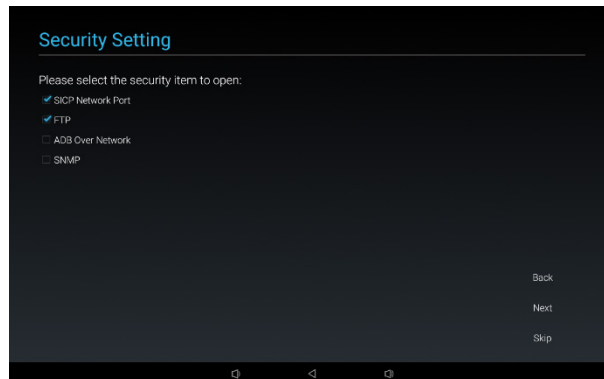

5.1.4. Signage Display Settings

The user can choose to import Database or setup manually.

You can click “Skip” if you do not want to run this page.

PS: (1) Database needs to put in the “Philips” folder in SD or USB drive.

(2) Data base file name should be “settings.db”

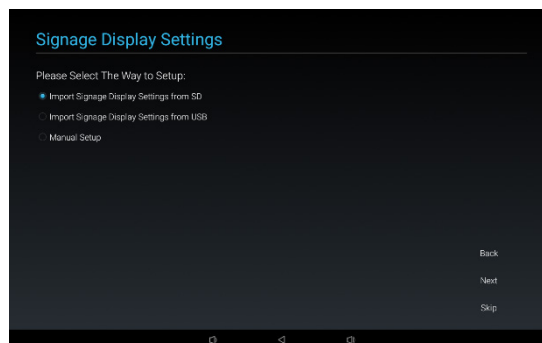

(1) Import Signage Display Settings from SD

Import Database from SD card, it will jump to the page: 5 Clone Media Files into internal .

PS: If the Database is imported successfully, you need to re-boot the display.

(2) Import Signage Display Settings from USB

Import Database from USB drive, it will jump to the page: 5 Clone Media Files into internal .

PS: If the Database is imported successfully, you need to re-boot the display.

(3) Manual Setup

If you choose manual setup, you need to setup some items:

* General Information

When you finish setup, it will jump to the page: Network Settings.

PS: Ne need to re-boot after setup.

Signage Display Name

It will show the default Signage Display name, but the user can change to other name.

You can click “Skip” if you do not want to change the name.

PS: If the name is blank, you can not click “Next” to go to next page.

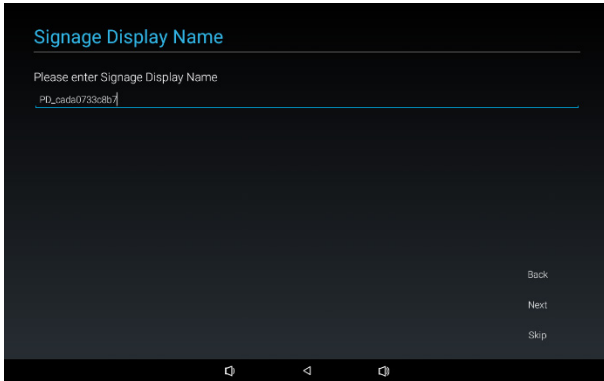

5.1.5. Network Setting

You can choose the network source: [Wi-Fi](#) or [Ethernet](#).

Then click “Next” to finish the network setting. Or, you can click “Skip” to skip network setting.

PS: If you did not connect Ethernet cable, it will show “Network cable is not plugged.” If you choose and click “Next”.

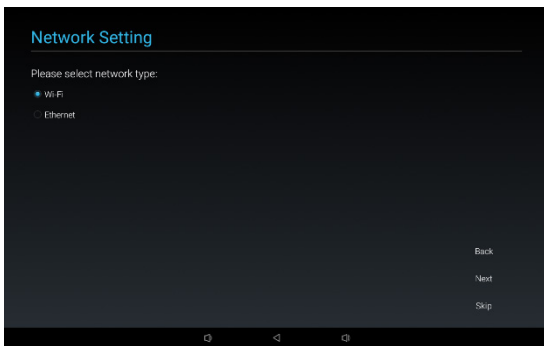

(1). Wireless

When connecting to Wi-Fi, it will lead you to next page automatically: [Signage Display Settings](#)

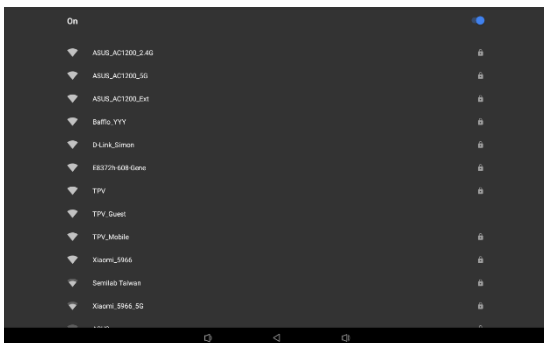

(2). Ethernet

When you enter “Ethernet” mode, it will show:
 Connection Type : 2 options: DHCP and Static IP
 IP Address (Only in Static IP mode)
 Netmask (Only in Static IP mode)
 DNS Address (Only in Static IP mode)
 Gateway (Only in Static IP mode)

Finish the setting and click “Next”, it will lead you to next page: [Signage Display Settings](#)

(1) Ethernet

Turn on the Ethernet, it will show related information about current connection.

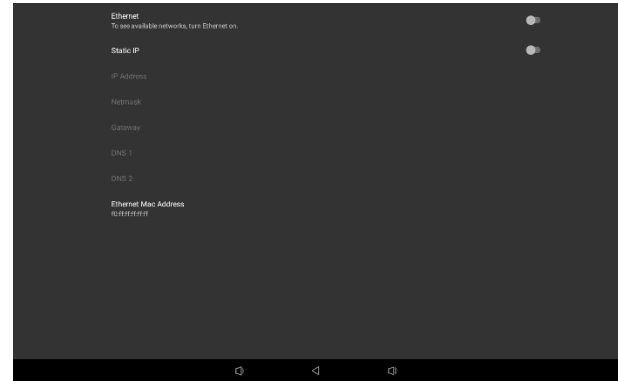

(2) Static IP

In Static IP mode, the user can set IP Address, Netmask, DNS Address, and Gateway manually.

5.1.6. Clone Media Files into internal

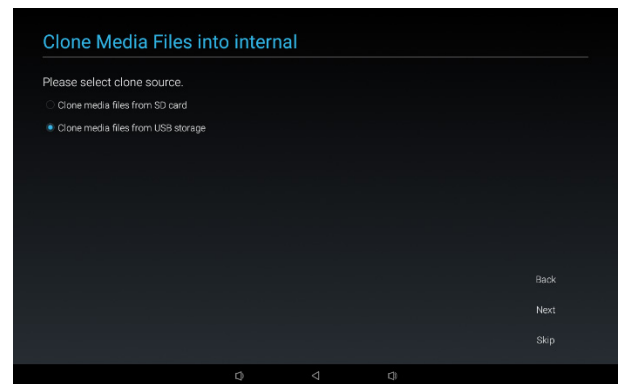

(1) Clone media files from SD

After cloning, it will jump to [6.1 Import Clone Data](#) .

(2) Clone media files from USB

After cloning, it will jump to [6.1 Import Clone Data](#) .

5.1.7. Setup Complete

When you click “Finish”, it will start “Import” or “Clone Data”.

If it runs “Import”, it will show [6.1 Import Clone Data](#) .

Otherwise it will show [6.2 Manual Setup Complete](#) .

PS: Do not power off during “Import” and “Clone” processes, otherwise it will cause data loss.

(1) Import Clone Data

Click “Finish”, run “Import data”, it will re-boot automatically.

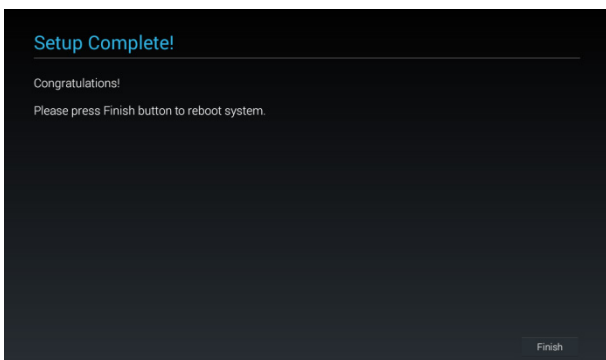

(2) Manual Setup Complete

After finishing manual setup, you can enter Admin Mode to change settings in the future if necessary.

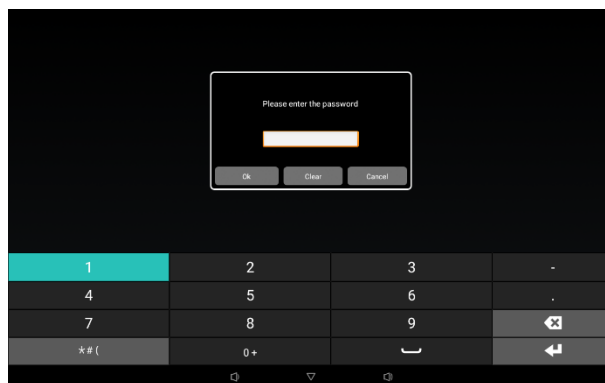
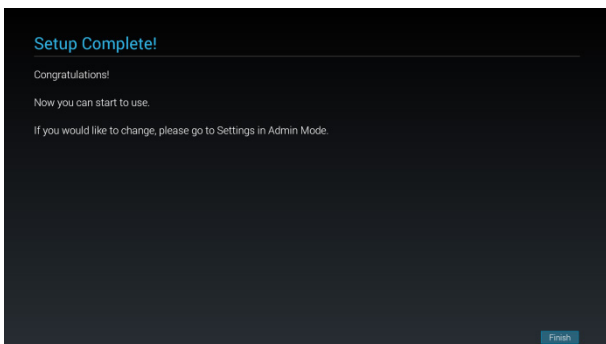

Admin mode will show five icons: “Settings”, “Apps”, “Network”, “Storage” and “Help”.

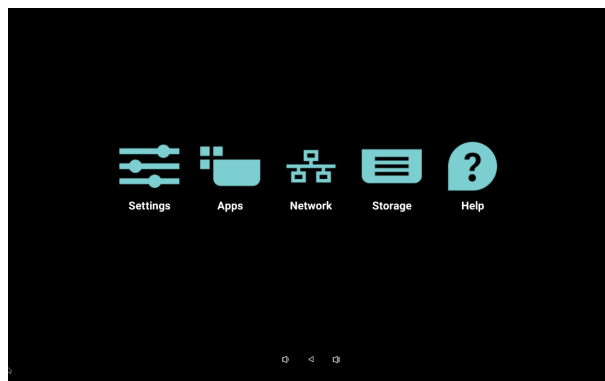

1. Settings: lunch Settings app.
2. Applications: show all apps.
3. Network: setup Wi-Fi, Ethernet and mobile network
4. Storage: simple file manager for user view the list of file in system.
5. Help: provide link for user get help from Philips official website.

Note:

When user leaving admin mode, system will back to boot on source.

(1). Settings Page

Reference Settings user manual for more detail description.

(2).Apps Page

List all application in this page, including user self-installed applications.

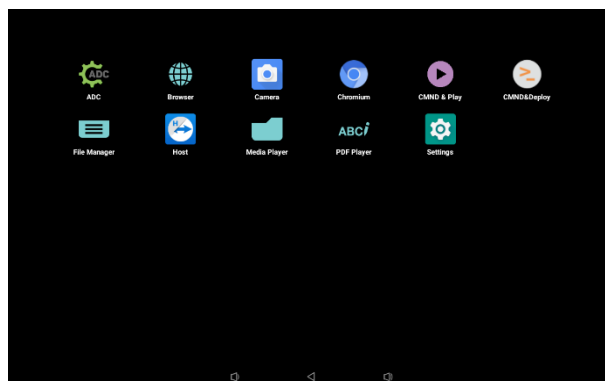

5.2. Android Launcher

5.2.1. Platform launcher

Platform launcher is black page as below:

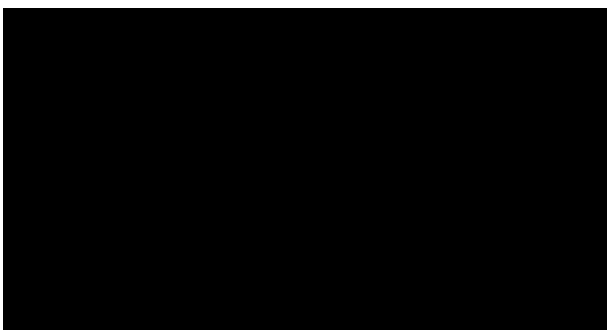

Every apps leave by press back key, the screen will go back to platform launcher..

5.2.2. Admin mode:

Admin mode let user setup and control device. Pressing “Menu, Volume Down” on keypad to startup admin mode. Screen show up a dialog request enter Admin password, default password is “1234”. User can change password in “Settings -> Signage Display -> System Tools -> Change the Administrator Password”.

(3).Network Page

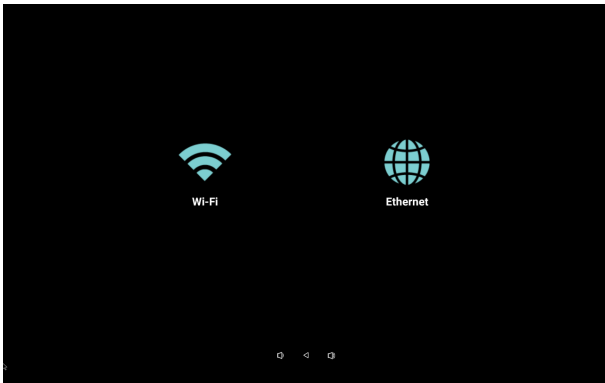

Wi-Fi and Mobile will only show up if system having available Wi-Fi module and mobile module.

a). Wi-Fi page

Enable & disable Wi-Fi connection. A list of available Access Point (AP) will be shown in below after enable Wi-Fi. Wi-Fi page is available if device connect with supported Wi-Fi module.

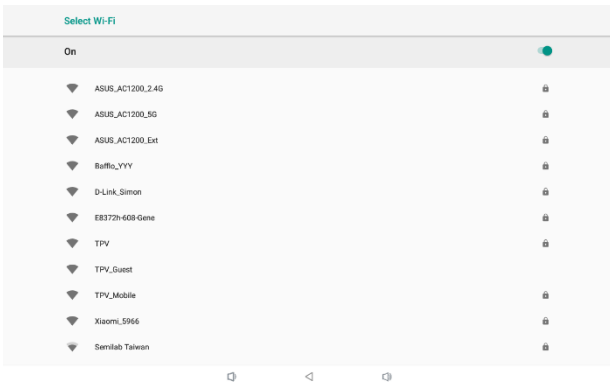

b). Ethernet page

Enable & disable Ethernet connection.

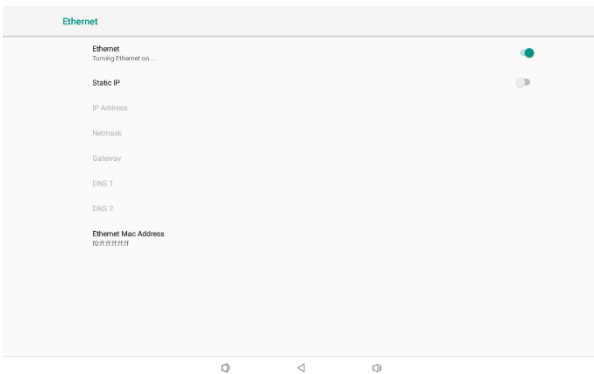

c). Mobile page

Enable and disable mobile network if device has supported mobile module.

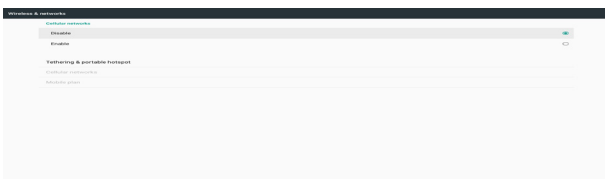

(4).Storage page

List internal storage and external storage (USB disk and SD card).

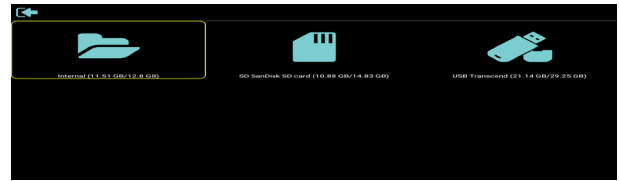

(5).Help page

Showing support website in link and QR code.



5.3. Setting menu

The major items in Settings:

- (1). Network & Internet
- (2).Signage display
- (3).Apps
- (4).Display
- (5).Sound
- (6).Security
- (7).System

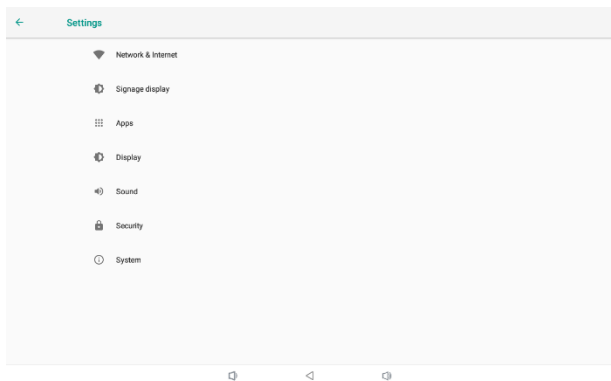

5.3.1. Network & Internet

5.3.1.1. Wi-Fi

Settings -> Network & Internet -> Wi-Fi

Turn On/Off the Wi-Fi connection through main switch in Setting -> Network & Internet -> Wi-Fi.

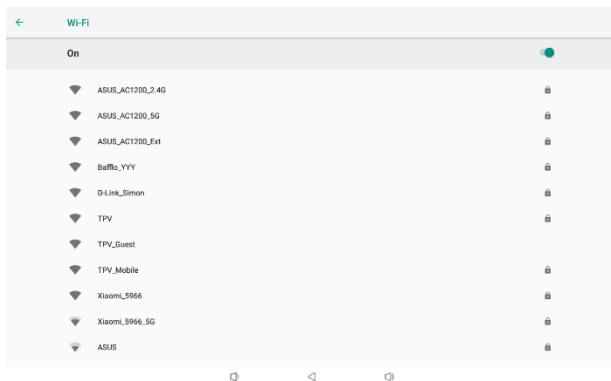

Note:

When Wi-Fi is enabled, Ethernet will be disabled automatically.

5.3.1.2. Bluetooth

Turn On/Off the Bluetooth through main switch in Settings -> Network & Internet -> Bluetooth. After press the Pair new device, it will show the device name and all available devices.

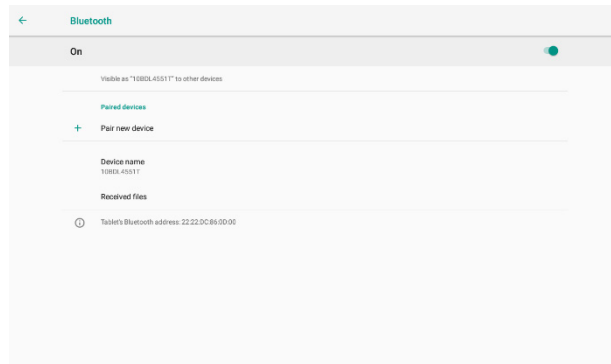

5.3.1.3. Ethernet

Settings -> Ethernet

Turn On/Off the Ethernet connection through main switch in Setting -> Network & Internet ->Ethernet. Ethernet configuration options list in below of main switch.

- (1). Static IP (Turn On/Off to connect with Static IP or DHCP
 - A. IP Address
 - B. Netmask
 - C. Gateway
 - D. DNS 1
 - E. DNS2
- (2).Mac Address (Show Ethernet MAC address, cannot be changed)

Note:

Wi-Fi connection will be disabled automatically when Ethernet connection is enabled.

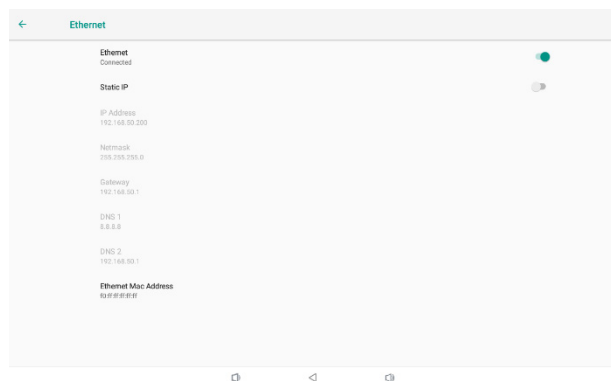

Static IP

- (1). Turn Off the Static IP through switch, if user want to connect with DHCP. When user select DHCP. You cannot modify IP Address, Netmask, Gateway ,DNS 1/2 (UI gray). And these item will should IP information when Ethernet is connected.

If Ethernet connected. The IP Address, Netmask, Gateway and DNS 1/2 and are showing information given by DHCP server.

- (3). Turn On the Static IP through switch, if user want to connect with Static IP. User can set IP Address, Netmask, Gateway ,DNS 1/2 and when select “Static IP”.

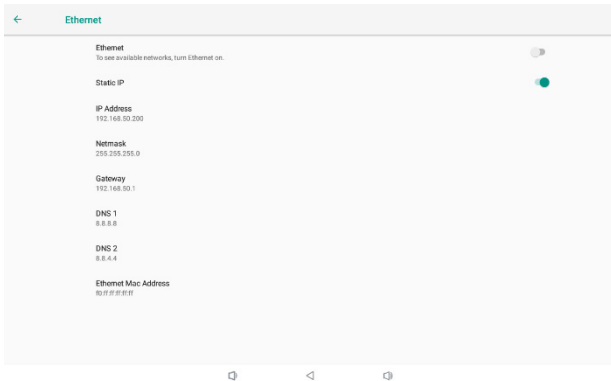

Note:

Please input IPv4 address in all field; in dot-decimal notation, consisting of four decimal numbers, each ranging from 0 to 255, separated by dot.

5.3.2. Signage Display

Settings -> Signage Display, to setup most features of signage display. Descript in below sessions.

There are different groups: General Settings / Server Settings / Source Settings / Network application / System tools / Misc. / System updates

(1) General Settings

* Signage Display Name

* Monitor ID

* Boot Logo

* Boot on source

* Schedule

* Screenshot

* Navigation bar

(2) Server Settings

* Email Notification

* FTP

* Remote Control

* SNMP

* ADB Over Network

(3) Source Settings

* Media Player

* Browser

* CMMD & Play

* PDF Player

* Custom app

(4) Network application

* Proxy

* Platform Web API

* SICP network port

(5) System tools

* Clear Storage

* Reset

* Auto restart

* Import & Export

* Clone

* Security

* Admin Password

(6) Misc.

* TeamViewer Support

(7) System updates

* Local update

5.3.2.1. General Settings

Set up Signage Display name, Monitor ID, Boot logo, Boot on source, Schedule and Screenshot.

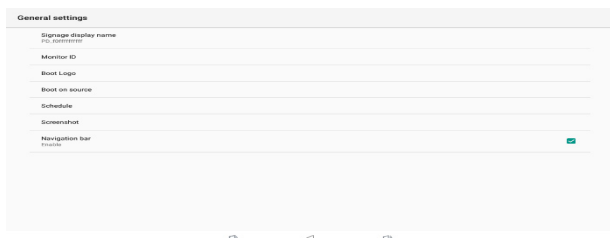

Signage Display Name

Set up PD name, default name Ethernet MAC address with prefix "PD_". For example, "PD_000b12223398". The max length of name is 36 chars in UTF8 format.

Monitor ID

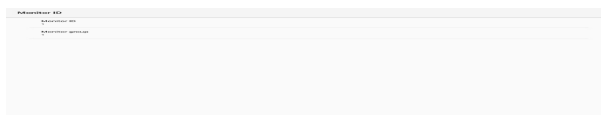

Monitor ID in range 1 to 255 decimal and Monitor Group in range 1 to 254 decimal. Default monitor ID and monitor group are both 1.

Boot Logo

User can set up device boot up logo (boot animation) mode. Default is ON.

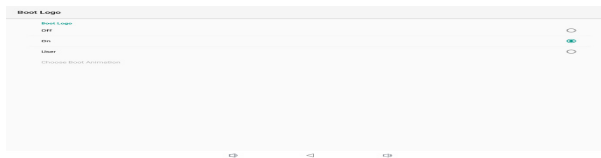

A. Off: Turn off boot animation.

B. On: Turn on boot animation, using PHILIPS default logo.

C. User

Turn on boot animation, using user choose boot animation file.

The boot animation file name is "bootanimation.zip".

Click "Choose Boot Animation" will pop up a dialog for user select boot animation file. System will auto scan the files under SD card and USB storage.

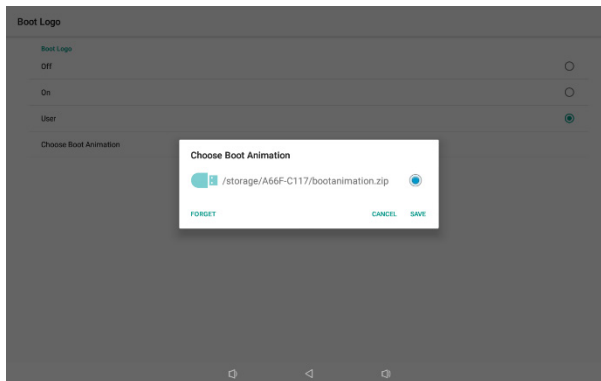

Function introduction:

* File location options:

1. File under /data/local/bootanimation/:
The boot animation file that copy from USB or SD card.
2. File under /storage/{USB_STORAGE_ID}/:
The boot animation file under USB storage.
3. File under /storage/{SD_STORAGE_ID}/:
The boot animation file under SD card storage.

Boot on source

Boot on source for user set up the default source when device power on.

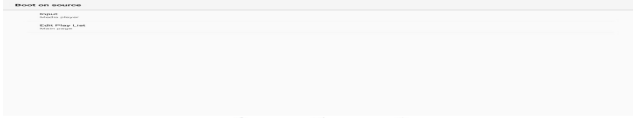

Input: System will boot to selected source automatically after boot complete.



Edit Play List: If input source is Media Play, Browser or PDF Player, user can select the play list for auto playback or boot to source main page.

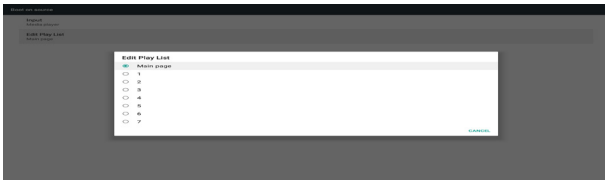

Please note that if user chose “Custom app” as boot on source, the user specified application (APK) must be selected in Settings -> Signage Display -> Source Settings -> Custom APP.

Schedule

Set up auto playback schedule.

Note:

1. Schedule priority is higher than Display -> Sleep and Display -> Screen save. When schedule is started, system will keep auto playback until schedule end, not effect by sleep time.
2. When schedule off (end time), device can only be wakeup by next schedule start time, hot key or network SICP command to wake up system. After waking up system, the system is black screen since playback applications are finished. User can call back navigation bar by finger scroll up (if touch not disabled) or enter Admin mode, quick info by hot key.
3. The hot key is available when system sleep. User can enter Admin mode or showing quick info dialog by using hot key.

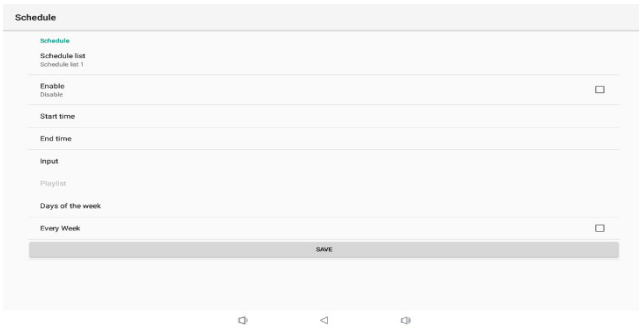

Screenshot

Setup device auto screenshot. Click “Enable” to enable screenshot features. The screenshot options is gray if user not enable screenshot.



User can set up screenshot interval and saving location folder after user enable it. “Save to” notify user that screenshot images will be saved in internal storage and user cannot change manually.

Navigation bar

Set up to enable or disable navigation bar during touch gesture. This option only available when platform has supported touch device.

5.3.2.2. Server Settings

Email Notification

Settings -> Signage Display -> Server Settings -> Email Notification

Click checkbox to enable/disable E-mail notification feature. User can set up SMTP and manager E-mail after enable E-mail notification feature.

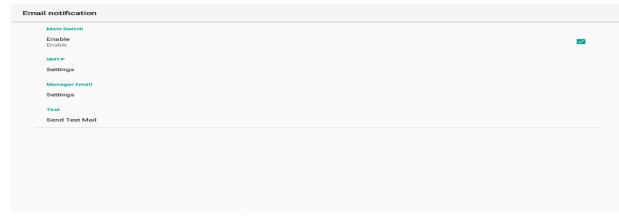

(1). SMTP

Setup sender E-mail address and SMTP server information. There are two types of SMTP server for user set up: “Gmail” and “Other”. By using “Other” option, user can manually setup STMP server, security type and server port.

Note:

Password length limit into range 6-20 chars in UTF8 format.

And user cannot set port 5000 (SICP default port) and 2121 (FTP server default port).

SICP network port setting in “Settings -> Signage Display -> Network Application -> SICP network port”.

FTP network port settings in “Settings -> Signage Display -> Server settings -> FTP -> Port”.

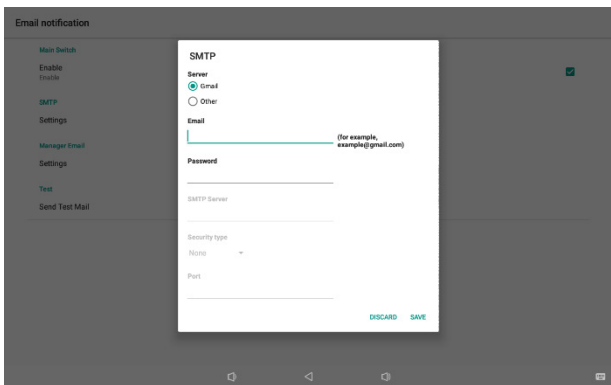

Gmail Security Settings

If you are using Gmail but cannot sent out E-mail, please check Google Account Security Setting in website: <https://www.google.com/settings/security/lesssecureapps>. And turn on “Access for less secure apps”.

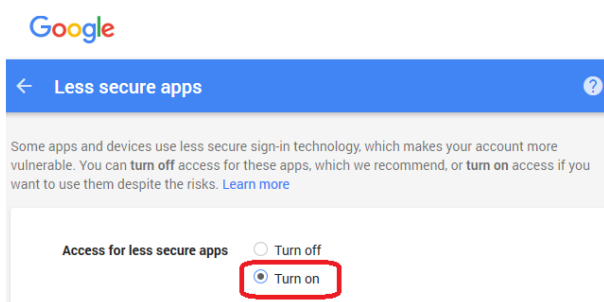

Yahoo Account Security Settings

In Yahoo Account Security option, users should enable “Allow apps that use less secure sign in” option.

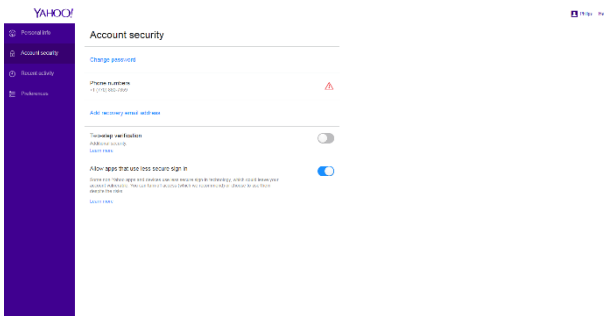

(2).Manager Email

Setup manager’s (receiver’s) E-mail address. Device will send E-mail to this account.



(3).Test

Click “Send Test Mail” will send out a test mail to check if settings are correct.

FTP

Settings -> Signage Display -> Server Settings -> FTP
Click the checkbox to enable/disable FTP server feature. After enable, user can setup account, password and port number.

- a). Account: The username for login FTP server. The length of name in range 4~20 charters, and only allow [a-z][A-Z][0-9].
- b). Password: The password for login FTP server. Password length in range 6~20 charters, and only allow [a-z][A-Z][0-9]. The password will show “*” only after set up.
- c). Storage path: The FTP server will access internal storage only. Cannot be changed by user.
- d). Port: The port number for FTP server. Available port number range from 1025 to 65535, default is 2121. The following port number cannot be used:

8000 / 9988 / 15220 / 28123 / 28124 and SICP network port (default 5000).

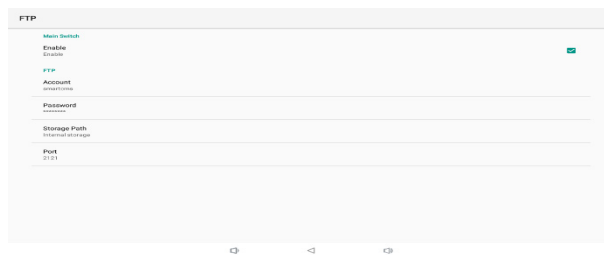

Remote Control

Settings -> Signage Display -> Server Settings -> Remote Control

Click Enable checkbox to enable/disable remote control client service, default is disabled. To use remote control must bind device with remote control server.

“Server” for user input remote control server URL address (with https:// prefix). If device does not bind with remote control server before, please input PIN code provided by server.

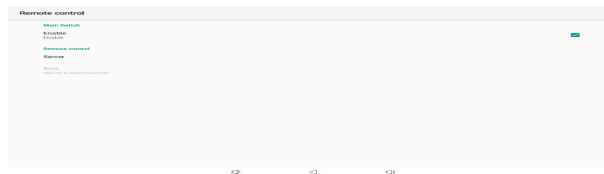

Bind status:

- (1). When device does not have network, showing “Network is disconnected”.
- (2).If device has network, but not connected with remote control server, showing “Server is disconnected”.
- (3).If server is connected but not bind with server, showing “Server is unbinded”.
- (4).If device bind with server successfully, showing “Server is binded”.
- (5).If PIN code is not correctly, showing “Error PIN code”.

SNMP

Settings -> Signage Display -> Server Settings -> SNMP
Click Enable checkbox to enable/disable SNMP service, default is disabled.

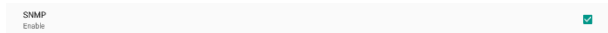

ADB Over Network

Settings -> Signage Display -> Server Settings -> ADB Over Network

Click Enable checkbox to enable/disable ADB over network, default is disabled. The switch of ADB Over Network is grayed out if you disable the “USB Debugging” option on the Settings -> Developer options.



5.3.2.3. Source Settings

Settings -> Signage Display -> Source Settings

User can configure source APK's detail options.

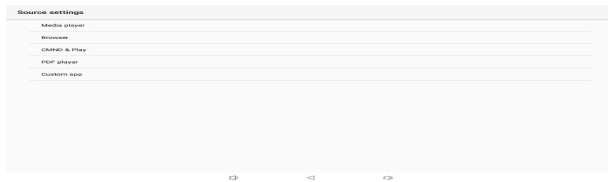

Media Player

Open Media Player APK's edit play list activity and edit effect stings activity.

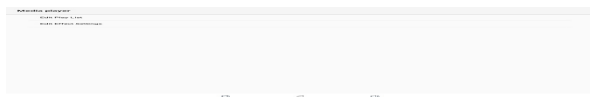

Browser

Open Browser APK's bookmark editor activity.

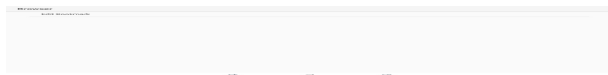

CMND & Play

CMND & Play APK settings activity

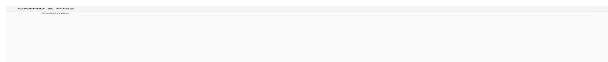

(1). Server

Set up CMND & Play Server IP address. Not available in 2.0 protocol.

(2).Account

Set up CMND & Play Server account, account should be a string in [a-z][A-Z][0-9]. Not available in 2.0 protocol.

(3).PIN Code

Set up CMND & Play PIN code. Not available in 2.0 protocol.

(4).Version

Set up CMND & Play server protocol version.

2.0: Used for protocol version 2.0/2.2 (default)

3.0: Used for protocol version 3.0/3.1

(5).Content

CMND & Play also support playback content from local storage, user can select “Internal Storage”, “SD card” or “USB storage”. CMND & Play APK will search content in selected storage folder.

Local storage cannot be removed (un-plug) when CMND & Play is playing content.

PDF Player

Open PDF Player APK's edit play list activity and edit effect settings activity.

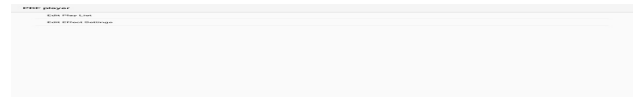

Custom app

User set up customer source APK. The selected APK will be launch when switch into customer input source. If user does not set up customer source APK, system will show black screen when switch into customer input source.

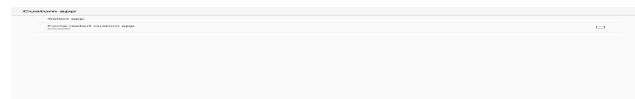

If user set up APK for custom app source, it will show APK name. If not, means that user does not set up custom app.

Select APP dialog



Note:

System pre-installed APKs will not be shown in list. Only list the APKs that user manually installed.

(1). SAVE

Click SAVE to choose selected APK as custom source application. Gray if no available application can be selected.

(2).FORGET

Clear custom source application. Gray if user does not set customer source application.

(3).CANCEL

Do nothing and close dialog.

5.3.2.4. Network Application

Settings -> Signage Display -> Network Application

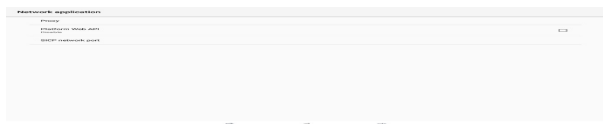

Proxy

Enable/disable network proxy by click “Enable” checkbox. User can set up host IP and port number of the proxy server. Default is disabled.

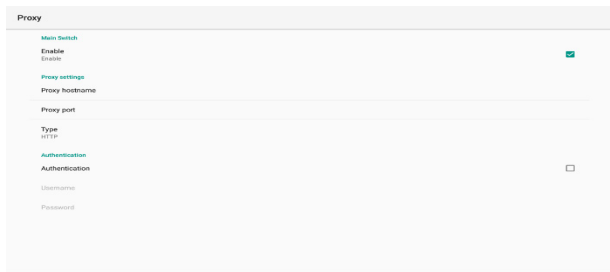

Device support proxy type: HTTP, HTTPS, SOCKS4, SOCKS5. Choose one for your proxy server.



If proxy server request authorization by login name and password, enable Authentication and enter Username and Password.

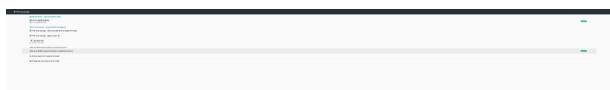

Platform Web API

Settings -> Signage Display -> Network Application -> Platform Web API

Enable/disable Platform Web API by clicking checkbox. Default is disabled.

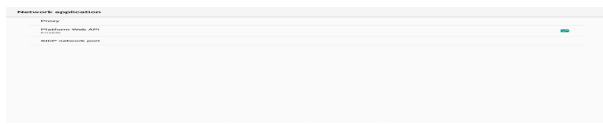

SICP Network Port

Settings -> Signage Display -> Network Application -> SICP Network Port

Set up SICP default port and enable/disable network SICP. Default SICP is enabled and using port 5000.

Note:

Port number range from 1025 ~ 65535.

Following port already been used, cannot assign:

8000, 9988, 15220, 28123, 28124 and FTP default port (2121).

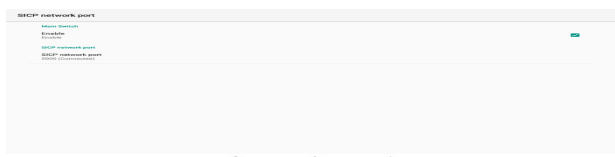

5.3.2.5. System Tools

Settings -> Signage Display -> System Tools

There are 7 major features in signage display system tools:

(1). Clear Storage

Used to clear data under Philips/ folder in internal and external storage

(2). Reset

Doing factory reset to clear all user data and settings. System will auto reboot and jump to OOB after finished.

(3). Auto restart

User can set device auto restart every day in specific time.

(4). Import & Export

Use export/import signage display setting for user easy copy settings and 3rd part APK to other device.

(5). Clone

This tool clone media files from selected source storage to target storage.

(6). Security

Lock or unlock external storage (SD card and USB storage) and keyboard (Menu/Vol +/Vol -).

(7). Admin Password

Set up Admin mode password and lock/unlock external storage.

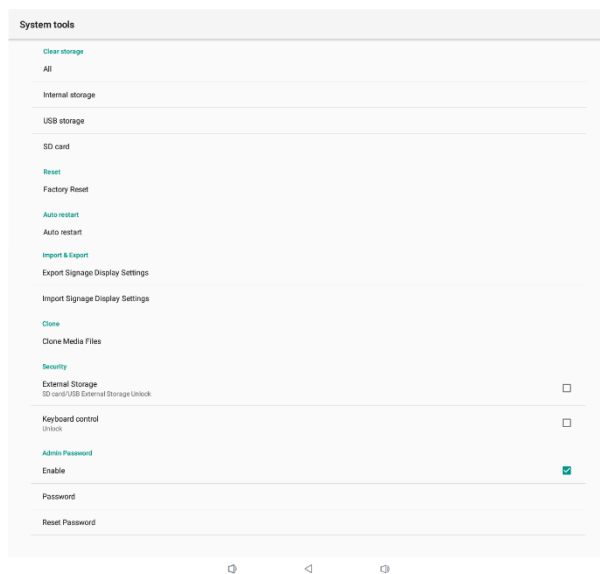

Important Note:

Reset

All data in system will be erased and cannot revert; including device settings, installed APPs, APPs’ data, download files, music, photos and all data under /data. But data in USB storage and SD card will not be clear, only clear the data in internal storage.

Make sure AC adapter and power must always exist during factory reset.



Doing factory reset by click “FACTORY RESET”, system pop up a dialog and ask again. Please make sure you understand what you are doing, then press “OK” to perform reset action. Note that this action cannot reverse and erase all data in internal storage.



External Storage

Click the checkbox to lock or unlock external storage (SD card and USB storage). Default is unlocked.

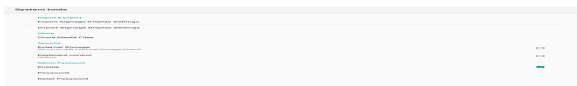

- (1). Unclicked (Disable): SD card/USB External Storage Unlock.
 - (2). Clicked (Enable): SD card/USB External Storage Lock.
- Note:

When you disable external storage lock for enable state, please unplug and plugin external storage again (for both SD card and USB storage). After that, system can detect external storage again.

5.3.2.6. Misc.

TeamViewer Support

Click the checkbox to enable or disable TeamViewer support. Default is enabled. TeamViewer will send a virtual HOME key to open Admin mode.

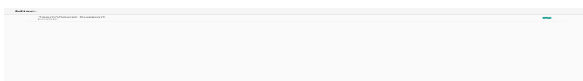

5.3.2.7. System updates

Local update

System will auto search “update.zip” in root folder of USB disk and SD card. If system found “update.zip” in external storage, pop-up a selectable list for user select which file user wants to use for update.

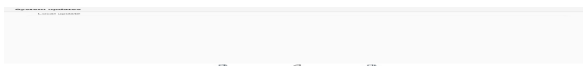

After select the file in list, system will reboot and do system update.

Please note that:

1. Keep system power alive during system update, do not remove power adapter.
2. Currently system only support full Android update.
3. The update file should be named “update.zip” only.
4. The “update.zip” file should be only put in root folder of external storage.

5.3.3. Apps

Display installed APKs information.

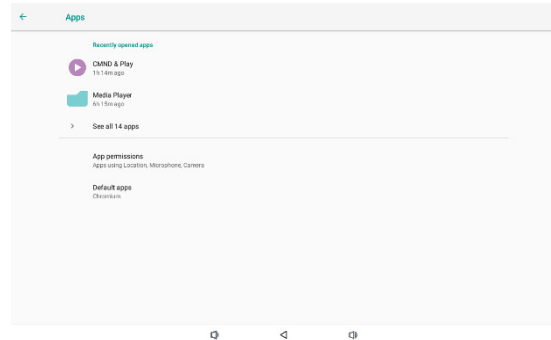

5.3.4. Display

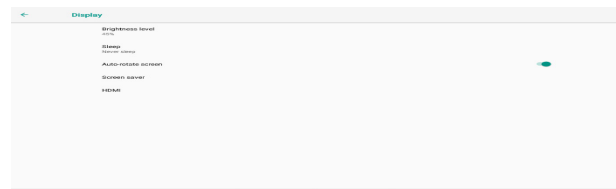

There are following features in Display.

(1). Brightness level

The adjust bar will be show on top of the screen. Drag adjust bar to set brightness.

(2). Sleep

Set up the time system go into sleep. Option “off” means that system will not go into sleep, screen will always on. Default is “off”.

(3). Auto-rotate screen

Turn On/Off to switch the rotation settings:

- Turn On : Rotate the contents of the screen
- Turn Off : Stay in current orientation

See the table below:

Orientation	Panel Output	HDMI output
Landscape		
Portrait		
Reverse Landscape		
Reverse Portrait		

(4). Screen saver

User can choose one of screen saver mode: Colors, Photo Frame and Photo Table.

(5). HDMI

HDMI will automatically output when use connect external monitor with HDMI output port.

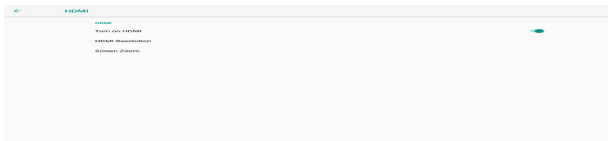

5.3.5. Sound

Set Volume

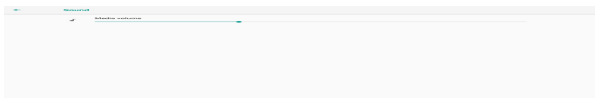

5.3.6. Security

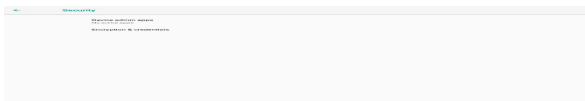

1. Device admin apps

List available device administrators for enterprises and related settings.

2. Encryption & credentials

List installed CA certificates pre-install in system. User cannot install user CA certificates.

5.3.7. System

5.3.7.1. Languages & input

Settings -> System -> Languages & input

User can set system language and change IME settings here.

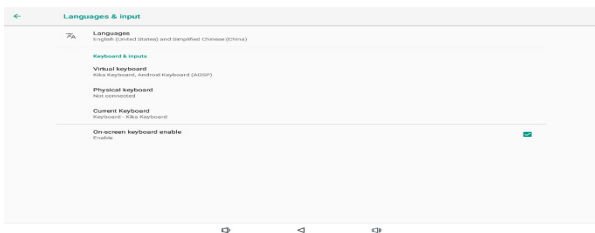

1. Languages

- Setup system language.
- Add Language in Preferences
- Change Language (Pressing the language you want to change and drag to the first one)
- Remove Language in Preferences List

2. Virtual keyboard

Virtual keyboards are commonly used as an on-screen input method. You can enable and disable input methods by pressing “Manage keyboards”.

3. Physical keyboard

User can enable/disable to keep showing virtual keyboard on screen or not.

4. Current keyboard

Used to change the current keyboard if system has multiple input methods installed.

5. On-screen keyboard enable

Used to enable/disable system pre-install software keyboard. User can press “menu” 6 times to enable on-screen software keyboard when it is disabled. By default, on-screen keyboard is enabled.

5.3.7.2. Date & time

Settings -> System -> Date & time

System date and time setting.

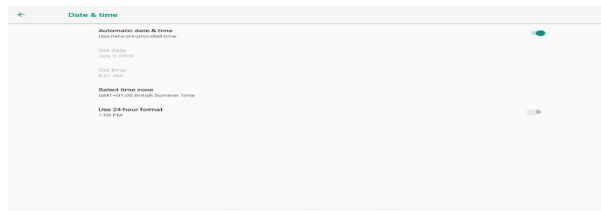

If “Automatic date & time” is on, system will get date and time from NTP server. If “automatic data & time” is disabled, user can change date and time by “Set date” and “Set time”. User can change time zone in “Select time zone”. And use can also change 24-hour format in “1:00 PM” or “13:00”.

5.3.7.3. Developer options

Settings -> System -> Developer options

Android developer options for developers, default is on and USB debugging is default on.

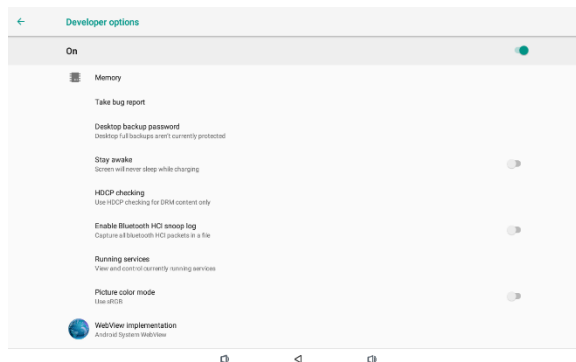

5.3.7.4. About tablet

Following list will be show in Settings -> About tablet

- (1). Status
- (2).Legal information, Open source licenses will be list in here.
- (3).Model (model name of this device)
- (4).Android version
- (5).Android security patch level
- (6). Kernel version
- (7).Build number (release version)

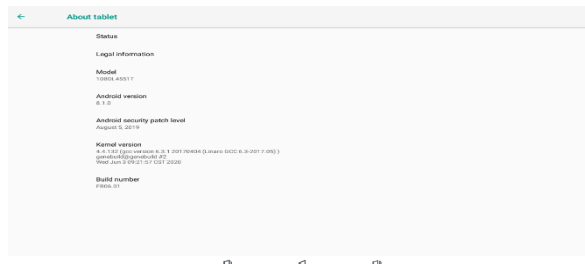

5.3.8. Appendix

5.3.8.1. Advanced features

(1). Install custom APK

You can use file-manager apk to install it. Please use key combination “Power+ V_Down” to enter “launch admin mode” page. -- click all app -- launch file manager app -- choose the apk to install

(2).Use the LED strips

Only SICIP commands can control the LED strips ON/OFF and colors.

* SICIP commands for controlling Side LED strips

Message-Set

Use this command to simultaneously switch on/off LED strips as shown above and set color based on R, G, and B values.

12.2 Message-Set

Use this command to simultaneously switch on/off LED strips as shown above and set color based on R, G, and B values.

Bytes	Bytes Description	Bits	Description
DATA[0]	0xF3 = Set		Command to set LED STRIPS ON/OFF and Choose color
DATA[1]	Light up status	0x00 = off, 0x01 = on	
DATA[2]	Red value	Valid Values range from 0x00-0xFF only if DATA[1] = 0x01	
DATA[3]	Green value	Valid Values range from 0x00-0xFF only if DATA[1] = 0x01	
DATA[4]	Blue value	Valid Values range from 0x00-0xFF only if DATA[1] = 0x01	

* Led colors

	LED Behavior
Power LED	1. Power LED is amber when power is connected.
R/L LED strips	1. Default is OFF. 2. Only SICIP commands can turn ON/OFF and set colors on side LED strips.

(3). Use the camera

Use the key combination “Menu+ V_Down” to enter “launch admin mode”. ?click “all app” ?launch camera app.

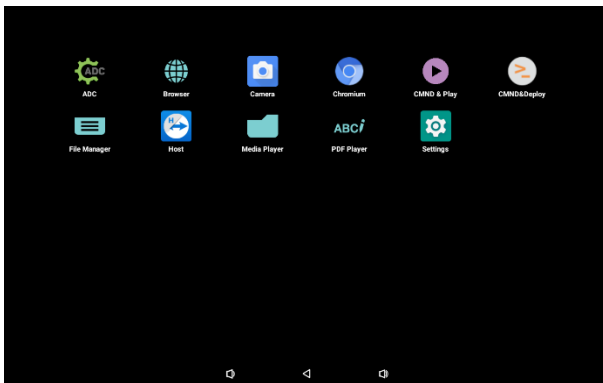

5.3.8.2. File manager app

Home page will list internal storage, SD card and USB storages. The external storage device must be named in English.



Press ok key at folder or file, it will popup option dialog.

Open: open folder or file.

Delete: delete folder or file.

Copy: copy folder or file.

Move: move folder or file.

Select: select folder or file to do action.

Select All: select all items of this page to do action.

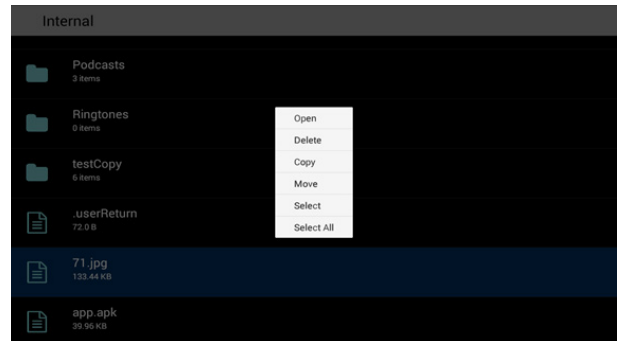

Select Copy or Move option, it will popup destination dialog.

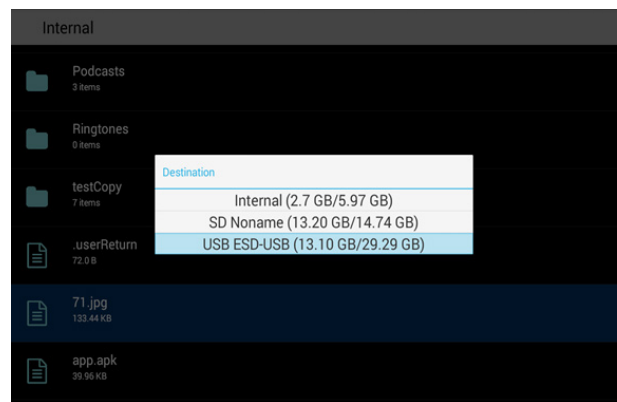

Select target storage, the bottom of screen will show function bar.

Press up or down key to move to the destination, press left or right key to select the function.

 : Paste  : Cancel

If the focus bar is a folder it will paste in this folder.

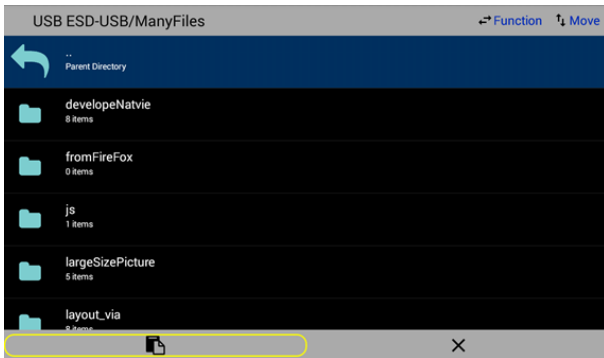



2020 © Koninklijke Philips N.V. All rights reserved.

Philips and the Philips Shield Emblem are registered trademarks of Koninklijke Philips N.V. and are used under license from Koninklijke Philips N.V.

Specifications are subject to change without notice.