

brose

Brose Battery 630

// Charger

F74738 // G01767 // F67261



ORIGINAL OPERATING INSTRUCTIONS

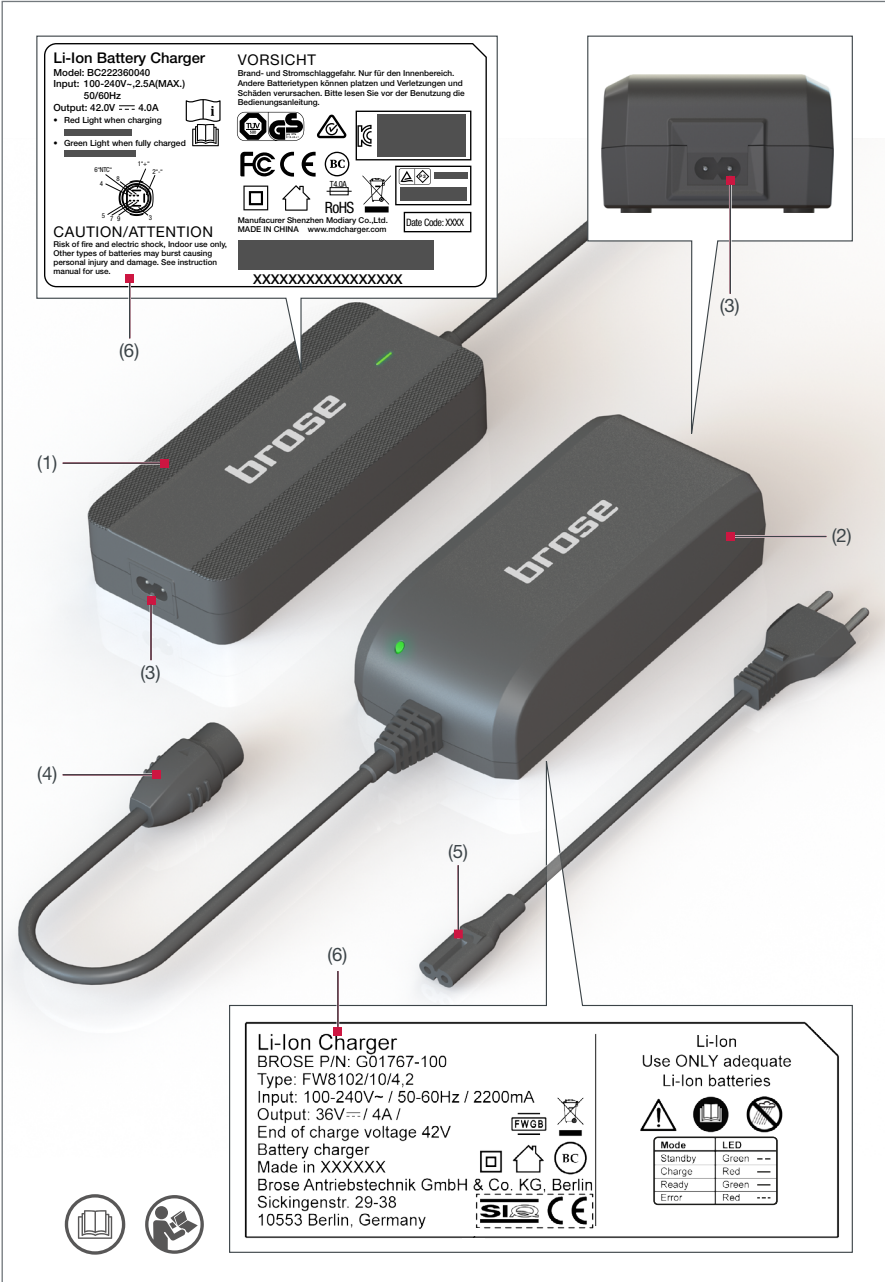

A. Charger overview

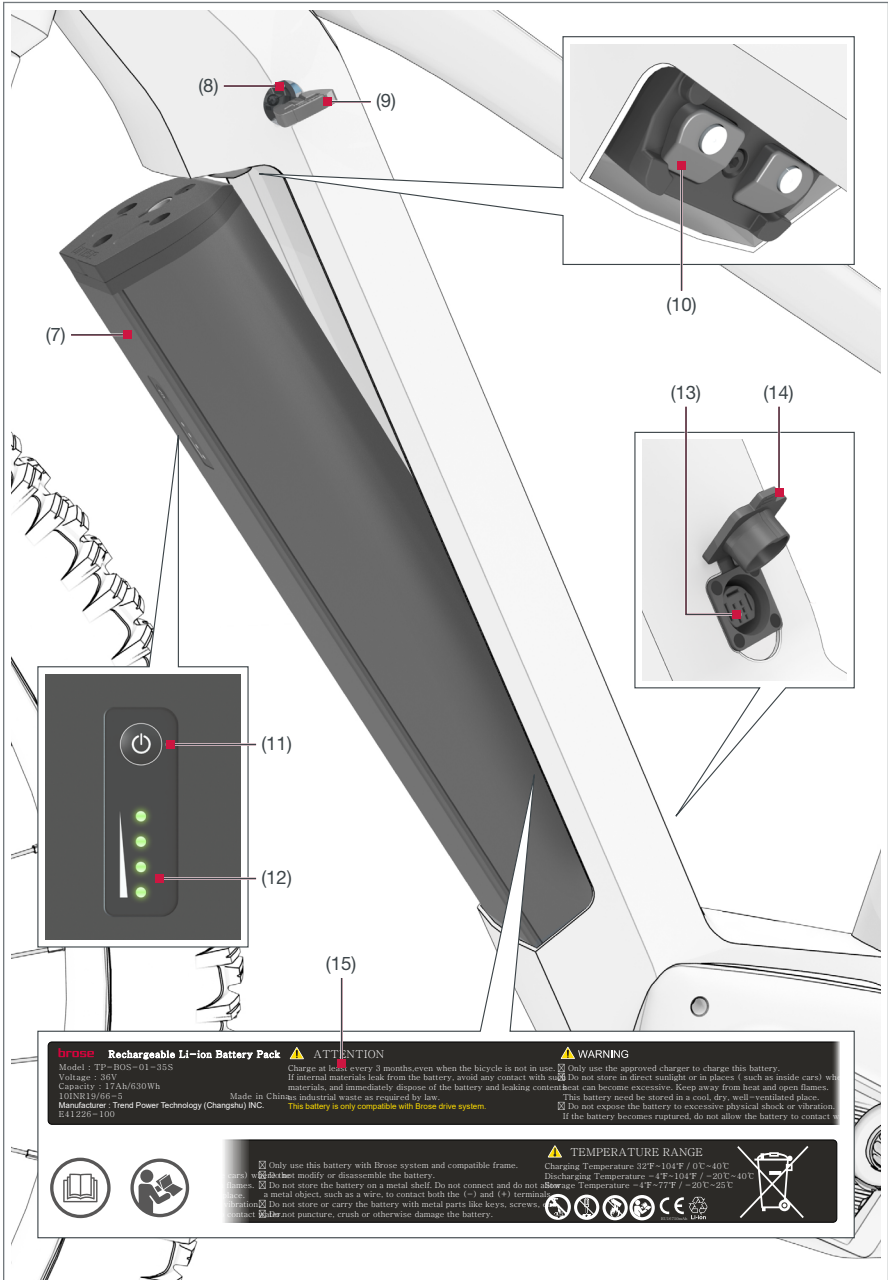

brose Rechargeable Li-ion Battery Pack ⚠ **ATTENTION** ⚠ **WARNING**

Model: TP-B05-01-35S
 Voltage: 36V
 Capacity: 17Ah/630Wh
 IEC61966-5
 Manufacturer: Trend Power Technology (Changshu) INC.
 B41226-100

Charge at least every 3 months, even when the bicycle is not in use. ⚠ Only use the approved charger to charge this battery.
 If internal materials leak from the battery, avoid any contact with skin. ⚠ Do not store in direct sunlight or in places (such as inside cars) with
 materials, and immediately dispose of the battery and leaking content can become excessive. Keep away from heat and open flames.
 Made in China; industrial waste as required by law. ⚠ This battery must be stored in a cool, dry, well-ventilated place.
 This battery is only compatible with Brose drive system. ⚠ Do not expose the battery to excessive physical shock or vibration.
 If the battery becomes ruptured, do not allow the battery to contact

⚠ Only use this battery with Brose system and compatible frame.
 Do not store the battery on a metal shelf. Do not connect and do not
 Disconnect a metal object, such as a wire, to contact both the (-) and (+) terminal
 Do not use store or carry the battery with metal parts like keys, screws,
 Do not puncture, crush or otherwise damage the battery.

TEMPERATURE RANGE
 Charging Temperature: 32°F / 0°C ~ 40°C
 Discharging Temperature: -11°F / 10°C ~ 20°C ~ 40°C
 Storage Temperature: -4°F / 7°F / -20°C ~ 25°C

⚠ Do not use this battery with Brose system and compatible frame.
 Do not store the battery on a metal shelf. Do not connect and do not
 Disconnect a metal object, such as a wire, to contact both the (-) and (+) terminal
 Do not use store or carry the battery with metal parts like keys, screws,
 Do not puncture, crush or otherwise damage the battery.

CE, RoHS, REACH, UN38.3, IEC61966-5, IEC62133, IEC60904-2, IEC60904-1, IEC60904-3, IEC60904-4, IEC60904-5, IEC60904-6, IEC60904-7, IEC60904-8, IEC60904-9, IEC60904-10, IEC60904-11, IEC60904-12, IEC60904-13, IEC60904-14, IEC60904-15, IEC60904-16, IEC60904-17, IEC60904-18, IEC60904-19, IEC60904-20, IEC60904-21, IEC60904-22, IEC60904-23, IEC60904-24, IEC60904-25, IEC60904-26, IEC60904-27, IEC60904-28, IEC60904-29, IEC60904-30, IEC60904-31, IEC60904-32, IEC60904-33, IEC60904-34, IEC60904-35, IEC60904-36, IEC60904-37, IEC60904-38, IEC60904-39, IEC60904-40, IEC60904-41, IEC60904-42, IEC60904-43, IEC60904-44, IEC60904-45, IEC60904-46, IEC60904-47, IEC60904-48, IEC60904-49, IEC60904-50, IEC60904-51, IEC60904-52, IEC60904-53, IEC60904-54, IEC60904-55, IEC60904-56, IEC60904-57, IEC60904-58, IEC60904-59, IEC60904-60, IEC60904-61, IEC60904-62, IEC60904-63, IEC60904-64, IEC60904-65, IEC60904-66, IEC60904-67, IEC60904-68, IEC60904-69, IEC60904-70, IEC60904-71, IEC60904-72, IEC60904-73, IEC60904-74, IEC60904-75, IEC60904-76, IEC60904-77, IEC60904-78, IEC60904-79, IEC60904-80, IEC60904-81, IEC60904-82, IEC60904-83, IEC60904-84, IEC60904-85, IEC60904-86, IEC60904-87, IEC60904-88, IEC60904-89, IEC60904-90, IEC60904-91, IEC60904-92, IEC60904-93, IEC60904-94, IEC60904-95, IEC60904-96, IEC60904-97, IEC60904-98, IEC60904-99, IEC60904-100

B. Battery overview

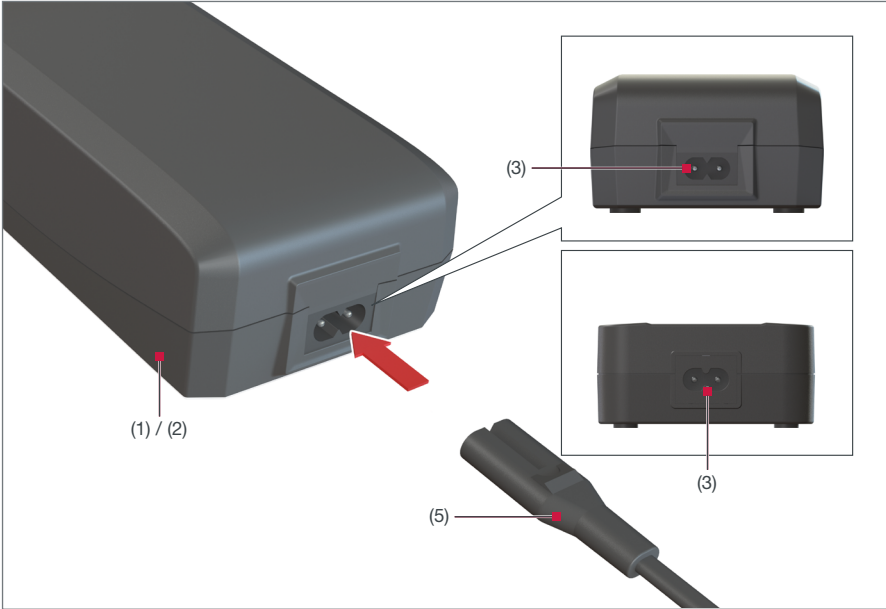

C. Charger start-up

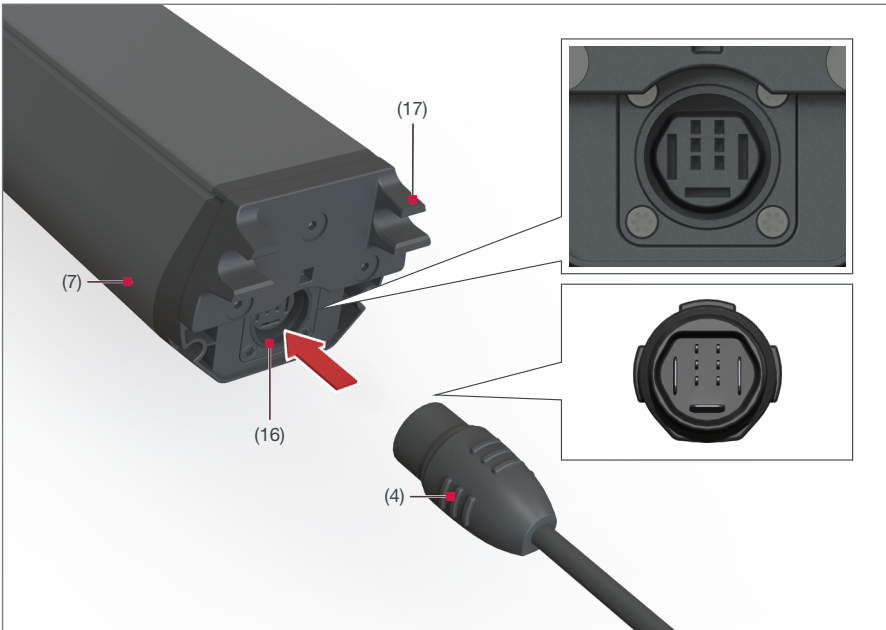

D. Charging the battery

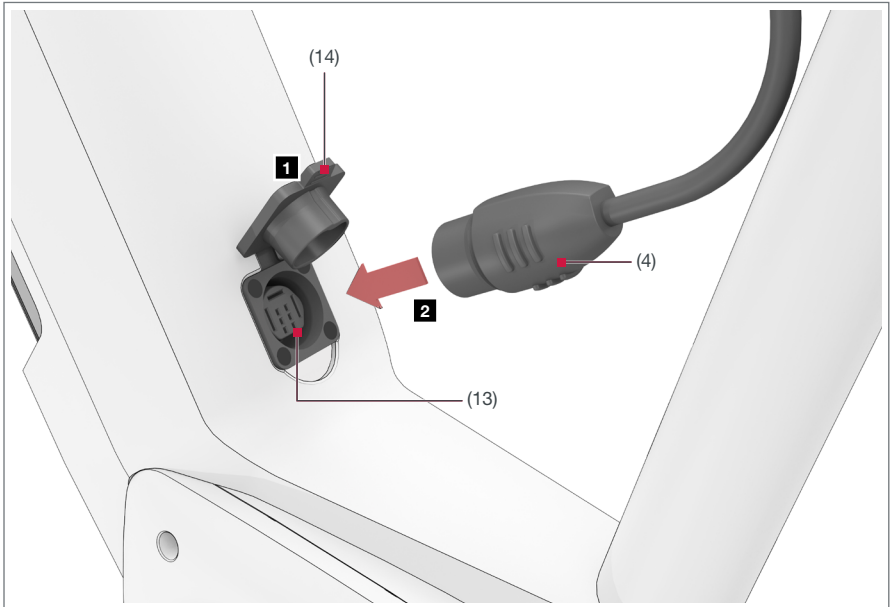

E. Charging battery on the e-bike

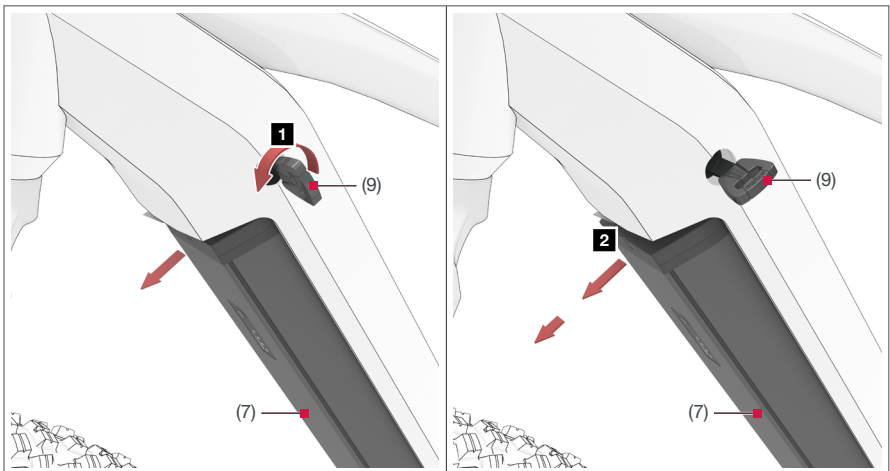

F. Removing the battery

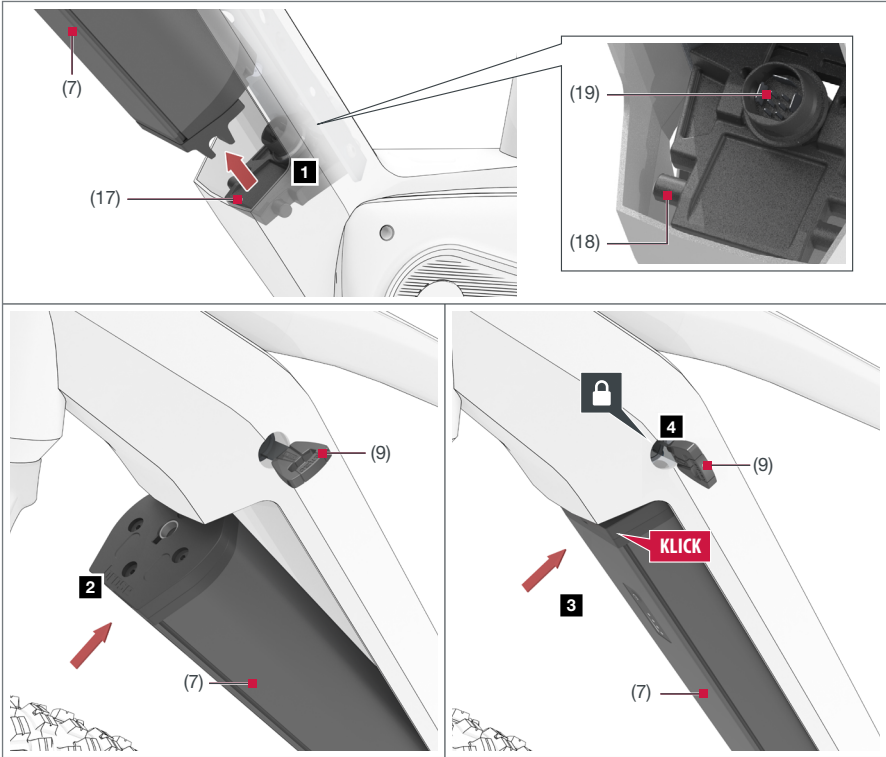

G. Inserting the battery

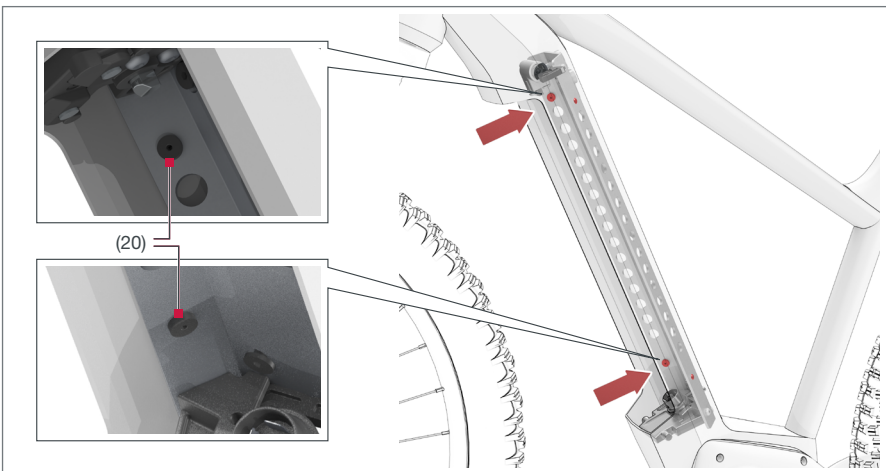

H. Vibration absorbers

Table of contents

About these original operating instructions	8	Storage, transport and dispatch	28
1 Additionally applicable documents	8	18 Service life	28
2 Reading and storing the user manual	8	19 Storage	28
3 Intended use	9	20 Transport	29
4 Foreseeable misuse	9	21 Dispatch	29
5 Residual risks	10	Maintenance and cleaning	30
6 Explanation of illustrations	11	22 Maintenance	30
7 Explanation of symbols and signs	12	23 Cleaning	30
For your safety	13	Technical Data	32
8 Information regarding safety and warning notices	13	24 Brose Battery 630	32
9 Warning notices on the product	14	25 Brose Charger	32
10 Safety notices for the battery 630	14	Disposal	33
11 Safety notices for the charger	16	Service	35
		26 Customer care and service	35
		27 Copyright	35
Commissioning	19		
12 Charging the battery	20		
13 Displays and controls	22		
14 Assembly	24		
15 Switching on/off	26		
16 Troubleshooting battery	26		
17 Troubleshooting charger	27		

About these original operating instructions

These original operating instructions – referred to as the user manual in the following – is based on the standards and regulations applicable in the European Union and contain important information on the use of Brose components.

1 Additionally applicable documents

This user manual is part of the original operating instructions for the Brose Drive System.

The complete original operating instructions consist of all documents relating to the individual components of the Brose Drive System installed in your e-bike.

The component configuration for the Brose Drive System installed in your e-bike can be found in the included data sheet of the e-bike manufacturer.

You absolutely must read and observe the following:

- The operating instructions of the e-bike manufacturer
- The user manuals of supplementary components of the Brose Drive System
- The user manuals for additional and special equipment

2 Reading and storing the user manual

Read the user manual, especially the safety advice in the following chapters, carefully before using components of the Brose Drive System.

This user manual contain information for the safe and fault-free use of the battery and corresponding charger for the Brose Drive System.

This user manual does not contain any instructions for operating the complete Brose Drive System (information on this topic can be found in the additionally applicable documents).

- Keep the user manual at hand for further use by all users.
- If you hand over your e-bike or individual components of the Brose Drive System to third parties, always include the pertinent operating instructions and all additionally applicable documents.

3 Intended use

The Brose Drive System is designed as an e-bike drive system. It consists of several components.

The components of the Brose Drive System installed in your e-bike are especially designed for your e-bike and may only be used in their original configuration as intended.

The components described in this manual – the **battery** and the **charger** – are two such components.

The manufacturer's instructions for the intended use of the e-bike (e.g., use on certain terrain or similar instructions) must also be followed (see the manufacturer's instructions for the e-bike).

4 Foreseeable misuse

Foreseeable misuse, especially tuning, will void the CE marking of your e-bike (EPAC up to 25km/h) – with all legal consequences.

Tuning consists of all non-approved modifications to the Brose Drive System or e-bike that manipulate performance. Accidents that can be traced back to technical manipulation are subject to high personal liability costs and criminal prosecution.

Furthermore, any kind of tampering with the Brose Drive System will void the warranty and guarantee claims on your e-bike.

Battery

The battery is intended for supplying power to the Brose Drive System.

- The battery is designed and intended only for use with a Brose Drive System.
- Any other use is regarded as improper.

Charger

The charger is intended for charging the battery belonging to the Brose Drive System.

- The charger may only be used to charge the battery belonging to the Brose Drive System.
- Any other use is regarded as improper.

Refrain from the following misuse of the battery and charger or the e-bike equipped with them in order to prevent hazards:

- Improperly performed repairs and/or maintenance work;
- Improperly performed cleaning and care;
- Structural modifications to the delivery condition of the Brose Drive System or the e-bike equipped with it, especially tuning, and any other manipulation of the Brose Drive System and its components;
- The opening and modification of all components of the Brose Drive System.

5 Residual risks

Certain residual risks unavoidably remain when using the e-bike - despite a well-calculated design by the manufacturer and compliance with the specifications for intended use by the user.

You can reduce these residual risks yourself by observing all safety and warning notices, but you cannot completely exclude them. It is therefore vital that you be aware of the existence of residual risks when using the e-bike.

Unforeseeable residual risks associated with the use of the e-bike described here include:

Risk of injury

- Unforeseeable driving maneuvers and/or misbehavior of other road users;
- Surprising or sudden changes in the road surface conditions, such as freezing wetness or “black ice”;
- Incalculable material defects or signs of wear that may cause components of the e-bike to break or impair their function.

Risk of fire

- Internal, invisible damage can cause the battery to catch fire and ignite objects in the vicinity.

Risk of damage

- When the battery is burning, hydrofluoric acid escapes with the flue gas. Hydrofluoric acid is highly corrosive and permanently damages surfaces.

6 Explanation of illustrations

Illustrations in this user manual show functions by way of example and may differ from the actual appearance of your Brose Drive System.

All illustrations are schematic and examples only. Some details may vary for your e-bike depending on the e-bike manufacturer. Detailed information on your entire e-bike is available from your authorized Brose dealer and e-bike manufacturer.

The numbering in the following tables refers to the illustrations at the beginning of this manual.

Illustration overview

- A. Charger overview
- B. Battery overview
- C. Charger start-up
- D. Charging the battery
- E. Charging the battery on the e-bike
- F. Removing the battery
- G. Inserting the battery
- H. Vibration absorbers

Handling sequence

















The numbering (**1**, **2**, **3**, etc.) in the illustrations indicates the sequence in which the steps must be performed.

Illustrated components

- (1) Charger **G01767**
- (2) Charger **F67261**
- (3) Device socket
- (4) Charging plug
- (5) Device plug
- (6) Charger safety label
- (7) Battery **F74738**
- (8) Battery lock
- (9) Key for battery lock
- (10) Battery safety catch
- (11) Charge level key
- (12) Charge level indicator
- (13) Charging socket (e-bike)
- (14) Charging socket cover
- (15) Battery safety label
- (16) Charging socket (battery)
- (17) Battery fixing
- (18) Lower battery holder
- (19) Swivel connector
- (20) Vibration absorbers

7 Explanation of symbols and signs

The following symbols can be found on the components of the Brose Drive System and in this user manual.

	<p>Read and observe the operating instructions to ensure safe use.</p>		<p>Products marked with this symbol comply with all applicable Community regulations of the European Economic Area.</p>
	<p>Protection category II device The AC input and DC output are electrically isolated.</p>		<p>The device corresponds with the California Code of Regulations Title 20 Standard.</p>
	<p>Use the device only in dry indoor areas. WARNING! There is a risk of electric shock when used in a damp environment and in contact with liquids!</p>		<p>SIQ Approval mark of SIQ</p>
	<p>For your own protection and for the protection of the components, observe all instructions marked with this symbol!</p>		<p>Labeling of rechargeable and other batteries that must not be disposed of with household or residual waste. Dispose of the labeled rechargeable and other batteries at suitable collection points.*</p>
	<p>Do not disassemble.</p>		<p>Electrical appliances with this labeling must not be disposed of with household or residual waste. Consumers are required by law to dispose of electrical equipment with this labeling at appropriate collection points for environmentally sound recycling.*</p>
	<p>Do not immerse in liquids.</p>		<p>Lithium-ion battery (contains recyclable materials)*</p>
	<p>Do not dispose of in a fire.</p>		<p>Dispose of the packaging according to type. Put cardboard in the waste paper container and foils in the recyclables container.*</p>
	<p>Protect the device from moisture!</p>		
	<p>Do not use the device in the rain or store it outdoors! Risk of explosion!</p>		

*Please also observe the notes on disposal on page 33.

For your safety

8 Information regarding safety and warning notices

This user manual contains instructions and notices for your safety, as well as the safe and proper operation of the Brose Drive System.

For your own safety, please read all safety notices and information in this chapter carefully before using the Brose Drive System or the components.

8.1 Explanation of safety and warning notices

Basic safety notices are summarized in this chapter and include instructions that basically apply to safe use or to maintaining a safe condition.

Action-related warnings warn of residual dangers and precede the respective step.

8.2 Presentation and structure of safety and warning notices

SIGNAL WORD

Type and source of the danger!

Explanation of the type and source of the danger.

» Measures for preventing the danger.

8.3 Danger classification of safety and warning notices

The safety and warning notices are classified with regard to their level of danger.

The danger levels with the corresponding signal words and warning symbols are explained below.

DANGER

Danger that will result in death or serious injury if not prevented.

WARNING

Danger that can result in death or serious injury if not prevented.

CAUTION

Danger that can result in moderate or minor injury if not prevented.

NOTE

Danger that can result in property damage if not prevented.

9 Warning notices on the product

Stickers with warning notices have been affixed to the components of the Brose Drive System for your protection:

- › *fig. A, page 2*
- › *fig. B, page 3*
- Read and follow the instructions on the product carefully.
- If a sticker becomes illegible or detaches, contact your authorized Brose dealer for a replacement.

10 Safety notices for the battery 630

WARNING

Risk of fire and electric shock!

If you handle the battery improperly, there is a risk of fire and electric shock.

- » The battery may heat up during charging and operation.
- » Keep flammable materials away from the battery.
- » Charge the battery in a dry and fireproof place only.
- » Do not leave the battery and charger unattended during charging.
- » Do not short-circuit the battery.
- » Keep metal objects such as coins, paper clips, screws, etc. away from the battery. When storing the battery, make sure not to store it together with metal objects (e.g., in a drawer). Metallic objects can short-circuit the battery.

WARNING

Risk of accidents and injury!

If the Brose Drive System is activated accidentally, accidents and injuries may result.

- » Always remove the battery from the e-bike:
 - Before transporting the e-bike.
 - Before performing any work on the e-bike.
 - Before storing the e-bike.

⚠ WARNING**Risk of explosion!**

Batteries can explode if handled improperly.

- » Only use an original Brose charger for charging.
- » Use only original Brose batteries for supplying power to the Brose Drive System.
- » Use the battery only for supplying power to the Brose Drive System. Do not use the battery for other purposes under any circumstances.
- » Do not use the battery until you have checked it for damage and found no damage. Never use or charge a damaged battery under any circumstances.
- » Never try to open the battery under any circumstances.
- » Have the battery checked by an authorized Brose dealer after an impact or fall.
- » Only touch a damaged battery with protective gloves.
- » Keep the battery away from open fire, heat (e.g., strong sunlight) and liquids.
- » If a battery catches fire or explodes:
 - Move away from the battery.
 - Call the fire department.
 - Maintain a distance from the battery.
 - Do not attempt to extinguish a burning battery with water.

⚠ WARNING**Risk of chemical burns!**

Improper handling of the battery may result in chemical burns and/or injury to you and others.

- » Protect the battery from impacts, mechanical effects and other stresses.
- » Have the battery checked by an authorized Brose dealer after falls or hard impacts to make sure that there is no (invisible) damage that could cause battery acid or toxic gases to escape.
- » Never open, disassemble, pierce or warp the battery or battery case.
- » Do not touch any liquid leaking from the battery.
- » In case of contact with damaged batteries, wear protective goggles and protective clothing to avoid contact with battery acid.
- » In case of contact with battery acid, immediately flush the affected area thoroughly under generous amounts of running water. After flushing, consult a doctor, especially in case of contact with the eyes and/or mucous membranes (e.g., nasal mucosa).
- » Provide fresh air immediately and seek medical attention as soon as possible if you suspect that you may have inhaled gas leaking from the battery.

11 Safety notices for the charger

WARNING

Risk of electric shock!

There is a risk of electric shock if the charger is connected to the mains incorrectly and handled improperly.

- » Check the charger, cable and plug for damage before each use.
- » If you discover any damage, do not use the charger under any circumstances.
- » Do not open the charger and have it repaired only by qualified personnel and only with original spare parts.
- » Do not use the charger when the cable is tied together or rolled up and do not store it with the cable wrapped around the charger housing.
- » Connect the charger to an easily accessible and properly installed socket. In case of a fault, you must be able to disconnect the charger from the mains immediately.
- » Only connect the charger to a mains connection whose mains voltage matches the specification on the type plate of the charger.
- » Use the charger only in dry, well-ventilated indoor areas. The charger is not suitable for use outdoors or in damp areas.
- » Keep the charger away from water and other liquids.
- » When disconnecting the mains or charging plug, always grasp the plug; do not pull on the mains or charging cable.

- » Do not grab the charger plugs with wet or damp hands.
- » Never use the charger when the connections are damp or wet.
- » Do not route power and charging cables over sharp edges and do not kink the cables.
- » Do not touch the charging contacts with metal objects. Make sure that no foreign objects can short-circuit the contacts.
- » Never expose the charger to large amounts of moisture (e.g. rain, snow, etc.). Protect the charger and connections from moisture.
- » Do not use the charger in rooms or areas with high intensity electromagnetic interference.
- » Always keep the charger clean.

⚠ WARNING**Risk of fire and explosion!**

Improper handling could lead to fire or explosion.

- » Protect the charger from fire, sparks and ignitable substances. If used incorrectly, explosive gases can escape.
- » Only use the charger to charge the pertinent original Brose battery.
- » Never use the charger to charge unsuitable batteries (e.g., vehicle batteries).
- » Never attempt to charge non-rechargeable batteries under any circumstances.
- » Do not use the charger with a multiple socket or extension cable.
- » Insert the mains plug firmly into the socket. If the mains plug and charging plug are not plugged in firmly, this can lead to fire due to electric shock or overheating.
- » The charger may heat up during the charging process. Keep flammable materials away from the charger.
- » Never cover the charger or place other objects on it while you are using it.
- » Charge the battery in a dry and fireproof place only.
- » Do not leave the battery and charger unattended during charging. Unplug the mains plug of charger from the socket after use.

⚠ WARNING**Risks for children and persons with reduced physical, sensory or mental capabilities!!!**

- » The charger may be used by persons with reduced physical, sensory or mental capabilities or lack of experience and knowledge only if they have been given supervision or instruction concerning the safe use of the device and understand the dangers involved.
- » The charger may be used by children 14 years and older only if they are supervised during use.
- » Children may not play with the charger.
- » Keep the charger out of the reach of children.

⚠ CAUTION**Risk of injury!**

The charger becomes very hot during the charging process. Touching the charger can cause burns.

- » Do not touch the charger during charging.

NOTE

Risk of damage!

Improper handling can lead to damage to the charger.

- » Never carry the charger by the electric cable.
- » Disconnect the charger from the mains before connecting or disconnecting the battery.
- » Disconnect the charger from the mains power supply during a thunderstorm.
- » Do not turn the pedals or move the bike while the charger is connected. As a result, the mains cable can become caught in the pedals and damaged.
- » Do not ride the bike wheels over the mains cable or plug.
- » Make sure that the mains cable of the charger is laid in such a way that it does not create a tripping hazard or, for example, that small children can pull on it.
- » Store the charger in a cool and dry place when not in use.

Commissioning

The battery is supplied with a maximum charge level of 30%.

To ensure full performance of the battery, charge it up fully before using it for the first time.

- To check the charge level, press the Charge level key **(11)** on the LED display of the battery *fig. B, page 3*.
- The Charge level indicator **(12)** on the battery shows the current charge level for about 5 seconds (*see chap. 13.2 on page 22*).

INFORMATION

Depending on the design of your e-bike, the Status key and charge level indicator may not be visible.

Switching on and displaying the charge level is only possible via an control unit. Information can be found in the bike manufacturer's manual.

Chargers marked with 230 V can also be operated at 220 V.

Always switch off the battery and the Brose Drive System before connecting the battery to the charger.

The drive unit is deactivated during the charging process.

12 Charging the battery

WARNING

Risk of explosion!

Batteries can explode if handled improperly.

- » Please use only the original Brose charger with the article number **G01767** or **F67261** for charging.
- » Only use original Brose batteries that are approved for the Brose Drive System.
- » Do not use the battery until you have checked it for damage and found no damage.
- » Never use or charge a damaged battery under any circumstances.
- » Do not leave the battery and charger unattended during charging.
- » Do not leave the battery permanently connected to the charger.

INFORMATION

- The battery can be charged up at any charge level. Interrupting the charging process does not cause any damage.
- The battery reaches its maximum service life when charged at ambient temperatures between +10 °C and +30 °C.
- The battery can be charged separately or on the e-bike at any time without shortening its life.

WARNING

Risk of electric shock!

If you handle the charger improperly, there is a risk of fire or electric shock.

- » Check the charger, cable and plug for damage before each use.
- » If you discover any damage, do not use the charger under any circumstances.
- » Only use the charger to charge the pertinent original Brose battery.
- » Do not leave the battery and charger unattended during charging.

INFORMATION

The battery is equipped with a temperature monitor, which allows charging only in the temperature range between 0 °C and +40 °C.

If the battery or charger is outside the charging temperature range, the LED on the charger flashes red.

- Disconnect the battery from the charger and allow it to cool down for at least 2 hours in a cool place.
- Do not reconnect the battery to the charger until the permitted charging temperature has been reached.

12.1 Charging the battery on the e-bike

› *fig. C, page 4, fig. E, page 5*

1. Switch off the Brose Drive System via the control unit.
2. Open the charging socket cover **(14)** on your e-bike.
 - › To avoid soiling the contacts, clean the cover before opening it.
3. Connect the device plug **(5)** with the device socket **(3)** of the charger.
4. Connect the charging plug **(4)** of the charger to the charging socket (e-bike) **(13)**.
5. Connect the mains cable of the charger (country-specific) to the mains supply.
 - The charging process begins.
 - › When the battery is fully charged, all 4 LEDs of the charge level indicator light up constantly.
6. After the battery has charged, disconnect the charger from the mains supply and then from the battery.
 - › The charger switches off automatically when disconnected from the battery.
7. Close charging socket cover **(14)** on your e-bike.

12.2 Charging the removed battery

› *fig. C, page 4, fig. D, page 4*

1. Connect the device plug **(5)** with the device socket **(3)** of the charger.
2. Connect the charging plug **(4)** of the charger to the charging socket (battery) **(16)**.
3. Connect the mains cable of the charger (country-specific) to the mains supply.
 - The charging process begins.
 - › When the battery is fully charged, all 4 LEDs of the charge level indicator light up constantly.
4. After the battery has charged, disconnect the charger from the mains supply and then the battery from the charger.
 - › The charger switches off automatically when disconnected from the battery.

INFORMATION

Always close the charging socket cover to prevent water or dirt from entering. The water or dirt entering the charging socket can lead to malfunctions.

13 Displays and controls

13.1 Charge level key

› fig. B, page 3

The Charge level key **(11)** on the battery is intended **ONLY** for checking the charge level of your battery (see chap. 13.2 on page 22).

The Brose Drive System cannot be switched on with it.

The charge level is also shown on the display of the control unit.

Read and follow the user manual of the corresponding control unit.

i INFORMATION

Depending on the design of your e-bike, the Charge level key **(11)** and the charge level indicator **(12)** may not be visible.

Information can be found in the e-bike manufacturer's instructions.

13.2 Charge level indicator

› fig. B, page 3

Riding





Four green LEDs on the charge level indicator **(12)** show the battery charge level.

If you press the Charge level key **(11)** on the battery, the battery charge level is displayed for about 5 seconds.

Each constantly illuminated LED corresponds with about 25% capacity.

If the battery capacity is below 10%, the first LED on the charge level indicator flashes.

LED charge level indicator (riding)





76~100%	
51~75%	
26~50%	
11~25%	
0~10%	

Charging

During the charging process, the LEDs on the battery's charge level indicator **(12)** light up.

- › A flashing LED shows that the next 25% is charging.
- › When the battery is fully charged, all four LEDs light up constantly for about 5 seconds. Then the charge level indicator extinguishes.

LED charge level indicator (charging)

76~100%	
51~75%	
26~50%	
11~25%	
0~10%	

14 Assembly

CAUTION

Risk of burns!

The brakes, motor and battery can heat up considerably during operation.

- » Always let the components cool down first before handling them or working in the vicinity of them.

CAUTION

Risk of injury!

If the drive system starts up while you are working on it, you may become injured.

- » Always switch off the battery and the Brose Drive System before inserting or removing the battery in the holder.

NOTE

Risk of damage!

Improper handling can lead to damage.

- » Be careful not to damage the fixing on the bottom of the battery.
- » Only place the battery down on a clean surface. In particular, avoid soiling the charging socket **(16)** and the contacts of the battery, e.g. with sand or soil.

INFORMATION

Due to different assembly options, the battery may be inserted and removed in different ways. For detailed information, please contact your authorized Brose dealer or e-bike manufacturer.

Special Brose vibration absorbers protect the battery and prevent noise development while riding. If you hear a rattling noise, check if all 4 absorbers are present and correctly mounted *fig. H, page 6*.

14.1 Battery safety catch/cover

NOTE

Risk of damage!

If the battery safety catch or battery cover is not correctly locked, the battery may fall out of the holder.

» If the battery safety catch/battery cover does not lock correctly, contact an authorized Brose dealer.

Different frame shapes and battery mounting variants may require different variants of battery safety catch as well as battery cover and its lock.

Detailed information on the battery cover is available from your authorized Brose dealer or e-bike manufacturer.

14.2 Removing the battery

› *fig. B, page 3*

› *fig. F, page 5*

1. Unlock the battery lock **(8)** on the outside of the e-bike frame by using the key **(9)**.
 - › The battery **(7)** now slides a little out of the holder and is held loosely in position by the battery safety catch **(10)**.
 - › Due to different assembly variants, you might have to pull the battery slightly.
2. Now remove the battery from the frame with both hands.

14.3 Inserting the battery

› *fig. G, page 6*

NOTE

Risk of damage!

If the battery is not correctly locked, the lock can open and the battery can fall out of the holder.

» The lock bolt is only properly engaged and the battery secured when the key can be removed.

1. Insert the key **(9)** into the lock **(8)** first, otherwise the lock cannot engage automatically.
2. Place the battery **(7)** with the fixing **(17)** in the lower holder **(18)** of the frame.
 - › Even a very small slide angle is sufficient.
 - › Make sure that the battery is correctly positioned in the holder on the frame.
3. Now slide the battery towards the frame and press it gently into the holder.
 - › The battery must audibly engage in the lock.

INFORMATION

If the battery does not retract, press the swivel connector **(19)** in the lower part of the battery holder down slightly.

4. Make sure the battery is firmly in place.
5. Always remove the key before riding the bike.

15 Switching on/off

Pressing the Charge level key (11) does **NOT** start the Brose Drive System.

The Brose Drive System can only be switched on or off using the control unit.

- Please read and observe the operating instructions of the corresponding control unit.

i INFORMATION

- If the Brose Drive System is not requesting any power (e.g. when the e-bike is stationary) or no key is pressed for a long time on the control panel, the battery is automatically switched off to save energy.
- The battery is protected against deep discharge, overcharge, overheating and short-circuit. In case of danger, the battery is automatically switched off by a protective circuit.

16 Troubleshooting battery

If one or two LEDs flash simultaneously, the battery is defective.

Switch off the system and contact an authorized Brose dealer.

If all 4 LEDs flash (quick) simultaneously for about 10 seconds, the battery has reached the end of its service life. Please contact an authorized Brose dealer to replace the battery.

LED error indicator

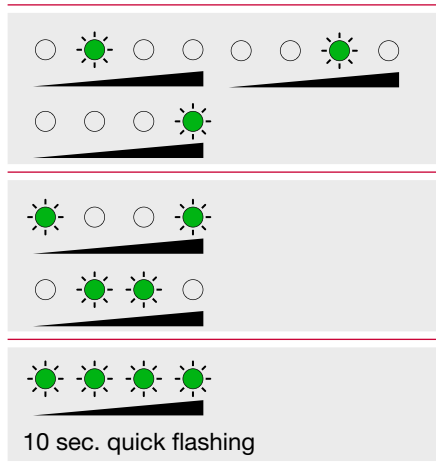

17 Troubleshooting charger

i INFORMATION

The charger is maintenance-free. If the charger is faulty or if faults occur that cannot be rectified by restarting, please contact an authorized Brose dealer.

The contact information for authorized Brose dealers can be found in the Service area at:

www.brose-ebike.com









i INFORMATION

If the battery temperature or voltage is outside the specified range, the charging process stops.

If the battery temperature or the battery voltage is within the specified working range again, the charger automatically continues charging.

The LED on the charger flashes red when an error occurs.

1. Disconnect the charger from the mains supply and allow it to cool down in a cool place.
2. Restart the charging process.
 - › To do so, the charger must be completely disconnected from the battery and power supply for at least 15 seconds.

LED indicator	F67261	G01767
Standby		
Charging		
Charging completed		
Error		

 lights up permanently

 flashing

 quick flashing

Storage, transport and dispatch

18 Service life

The life of the battery can be extended if it is well cared for and, above all, stored at the right temperatures and conditions.

With increasing age, even with good care, the capacity of the battery will decrease.

A significantly reduced operating time after charging indicates that the battery is exhausted. You should replace the battery.

19 Storage

NOTE

Risk of damage!

If the battery is stored in an empty state for a longer period of time, it may be damaged despite the low self-discharge rate, and the storage capacity may be greatly reduced.

- » If possible, store the battery in a dry, well-ventilated place at room temperature and protect it from moisture and water.
- » In unfavorable weather conditions, we recommend, for example, that you remove the battery from the e-bike and store it indoors until the next use.
- » Store batteries and rechargeable batteries in rooms with smoke detectors.
- » For example, do not leave the battery in the car in summer and store it out of direct sunlight.
- » Avoid temperatures below -10 °C or above +25 °C during storage.

Optimum storage conditions

Storage temperature	+15 °C to + 25 °C
---------------------	-------------------

Charge level	40~50%
--------------	--------

It is recommended not to leave the battery on the bicycle for storage.

- When not in use for a long period of time (>3 months), store the battery at about 50% charge (2 LEDs on the Charge level indicator light up).
- Check the charge level after 3 months. If only one LED on the Charge level indicator is still illuminated, charge the battery to approx. 50%.

20 Transport

NOTE

Risk of damage!

If you transport your e-bike outside your car, e.g., on a luggage rack, moisture can penetrate system components even at low speeds.

- » Remove the battery from the e-bike.
- » Tape any exposed contacts and pack the battery so that it does not move in the packaging.
- » Protect all e-bike components such as the control unit, drive, open plugs, etc. from moisture penetration. You can obtain appropriate protectors from the dealer.

If you intend to transport your eBike by bus, aeroplane, boat or train, contact the relevant transport company to find out the conditions under which the battery will be transported.

INFORMATION

Undamaged batteries can be transported on the road by the private user without further requirements.

21 Dispatch

Batteries are subject to the requirements of the hazardous goods law.

A battery is considered as hazardous cargo and may only be packed and shipped by trained persons. Please contact your authorized Brose dealer in this regard.

- Never ship the battery yourself.
- If you have any questions about the transport and shipping of the battery, contact an authorized Brose dealer.
- Before sending the battery, make sure that the both the battery and housing are undamaged. The sender is liable for any damage to defective batteries during transportation.

Commercial users or third parties carrying out the transport must observe the relevant hazardous goods requirements for lithium-ion batteries (e.g. regulations of the ADR).

Maintenance and cleaning

22 Maintenance

- Visually inspect the electrical lines, connections and contacts regularly to ensure that they are undamaged and clean.
- Arrange for your Brose Drive System to be given a technical inspection at least once a year to ensure that all components are present and functional (e.g. mechanics, up-to-date system software).

For service or repairs to the Brose Drive System or in case of a component failure (e.g. control unit, battery or charger), contact an authorized Brose dealer.

Information about authorized Brose dealers can be found in the Service area at:

www.brose-ebike.com

23 Cleaning

WARNING

Risk of electric shock and short circuits!

Injury due to electric current during cleaning and care work.

- » Switch off the Brose Drive System.
- » Unplug the charger plug from the socket.
- » Cover the power supply contacts.
- » Do not use any water or other cleaning fluids!
- » Do not immerse the charger and battery in water.
- » Do not use a high-pressure cleaner or steam cleaner for cleaning.

CAUTION

Risk of burns!

The brakes, motor and battery can heat up considerably during operation.

- » Always let the components cool down first before handling them or working in the vicinity of them.

CAUTION

Risk of injury!

If the drive system starts up while you are working on it, you may become injured.

- » Switch off the Brose Drive System and remove the battery when cleaning the e-bike or components.

NOTE

Risk of damage!

Improper cleaning can damage the Brose Drive System or the individual components.

- » Do not use aggressive cleaning and care agents, especially penetrating oils and brake cleaners.
 - » Do not use sharp-edged or metallic cleaning objects.
-
- Keep all components of your e-bike clean.
 - Avoid soiling the charger connections and the contacts. Wet contacts can lead to corrosion.
 - Clean the components with a dry, lint-free cloth.

Technical Data

24 Brose Battery 630

F74738	Brose Battery 630	Ambient temperature	Charging: 0 °C to +40 °C Riding: -10 °C to +40 °C
Nominal voltage	36 V	Short-term storage temperature	-20 °C to +25 °C
Nominal capacity	630 Wh	Weight	3.8 kg
Size	447×84×84 mm (with holder) // 387×84×72 mm (without holder)		
Protection class & certificates	IPX5 UN 38.3 // IEC 62133 // EN 15194 // ISO 13849		

25 Brose Charger

G01767 // F67261	Brose charger	Max. operating height	2.000 m
Operating temperature	0 °C to +40 °C	G01767: Size // weight	179×80×37 mm // 760 g
Storage temperature	-20 °C to +60 °C	F67261: Size // weight	180×86×50 mm // 630 g
Electrical data	see imprint on the charger		
Protection class & certificates	IP40 UL1012 // IEC60335 // AS/NZS 60335.2.29 // AS/NZS CISPR 14.1 // EN 60335 // EN 55014 // FCC		

Disposal

Batteries, chargers, control units, drive units, speed sensors, accessories and packaging must be recycled in an environmentally-friendly manner.

Do not throw e-bikes and their components in the household waste!

By collecting and recycling waste products separately, you are helping to conserve natural resources and are ensuring that the product is disposed of in a way that is safe for health and the environment.

Return e-bikes or components which are no longer serviceable to an authorised Brose dealer.

ONLY FOR EU COUNTRIES



According to European Directive 2006/66/EC defective or used batteries/rechargeable batteries must be collected separately and recycled in an environmentally sound manner.

The symbol indicates that both non-rechargeable and rechargeable batteries may not be disposed of with household waste.

Non-rechargeable and rechargeable batteries containing mercury (Hg), cadmium (Cd) or lead (Pb) are marked with the respective chemical symbol below the disposal symbol.

Consumers are legally obliged to non-rechargeable and rechargeable batteries to the retailer or a collection point regardless of whether they contain the above-mentioned pollutants so that they can be disposed of in an environmentally friendly manner and valuable raw materials can be recovered in order to avoid negative impacts on the environment and human health.

Batteries may contain substances that have adverse health effects for humans, animals and plants if disposed of incorrectly.

Special risks arise when handling lithium-containing batteries/rechargeable batteries, such as a high risk of fire/explosion due to the effects of heat or a short circuit.

Non-rechargeable and rechargeable batteries that are not permanently installed in the device must be removed and properly disposed of separately before the disposal of the device.

- For lithium-containing batteries and rechargeable batteries, tape off the terminals before disposal to prevent external short-circuiting.
- The disposal of old non-rechargeable and rechargeable batteries is cost-free. Make sure that non-rechargeable and rechargeable batteries are fully discharged when brought to the retailer or collection point.
- Try to avoid waste from old batteries as much as possible, e.g. by using long-life batteries or rechargeable batteries instead of disposable batteries.
- Always ensure proper disposal to counteract littering in public spaces.
- If applicable, use existing options to reuse used batteries instead of disposing of them, e.g. by having the battery serviced.



According to the European Directive 2012/19/EU, electrical appliances that are no longer fit for use must be recycled in an environmentally sound manner.

Old machines, replacement parts and packaging consist of recyclable materials. The owner has the duty to dispose of them properly according to the statutory provisions and in an environmentally-friendly manner.

All injection-moulded parts made of plastics are labelled with a recycling symbol.

- REACH directive no. 1907/2006 (EC)
- RoHS directive (2011/65/EU)

Please return Brose e-bike components that are no longer fit for use to an authorized Brose dealer.

SUBJECT TO CHANGES.

Service

26 Customer care and service

For all questions regarding the Brose Drive System and its components, please contact an authorized Brose dealer.

The contact details for authorized Brose dealers can be found in the service area at:

www.brose-ebike.com

27 Copyright

The contents of this manual are protected by copyright. Their use is allowed within the scope of the use of the appliance.

Any further use is not allowed without the manufacturer's written authorization.

All rights reserved.

The contents of this document were prepared with the utmost care. However, Brose accepts no liability for the accuracy, completeness and currentness of the content. The contents are for information purposes only and do not constitute legally binding offers.

brose

Brose Antriebstechnik GmbH und Co.
Kommanditgesellschaft, Berlin
Sickingenstr. 29-38
10553 Berlin
Germany

Phone: +49 30 343498 100
service.ebike@brose.com
www.brose-ebike.com

V 2.2 // 01/2021 // en (uk)