



B004-V2.0

PoE Security Camera System

Quick Guide

CUSTOMER SERVICE

Amazon: Love@Hiseeu.com

Aliexpress: Support@Hiseeu.com

Web: www.hiseeu.com

Tel: +1 917 688 2228

※Any questions during operating our system, please feel free to contact us.

Thank You!

Greeting from Hiseeu Team! Thank you for choosing our products and hope everything going well with you and your family. On behalf of all colleagues in Hiseeu, we sincerely appreciate your trust and support.

If you are satisfied with our product, please take a moment to share your experience on Amazon, your positive feedback means a lot to us and can encourage us to go further.

Before Return:

And if unfortunately, our products didn't meet your expectation, please contact us before returning to Amazon, we promise will give you the best solution.

For your security concerns please restore factory settings before returning. It will erase your personal information (Password, footage, email, etc. [Refer to page 31](#))

We would like to hear from you! Please do not hesitate to contact us if you have any questions.

Thanks again and wish you all the best.

Yours Sincerely,

All staff in Hiseeu

Tel: 917 688 2228

Email: Love@Hiseeu.com

Applicable Models

This manual is applicable to the models listed in the following table.

Model Number	Amazon ASIN	Item Name
8POEKIT-4HB215-1T	B07HRKDD6B	Bullet PoE system
8PK-4HC725Y-3T	B088YP8LPY	Dome PoE system
PK-8HB215-3T	B08XXGZVT2	8CH Bullet PoE system
8PK-12V-4HB915-3T	B08GX7DTPJ	PoE System with 12inch LCD Monitor
AKIT-4AHBB15-1T	B07GXTVMYQ	Bullet PoE system with Spotlight

The additional camera and NVR listed in the following table.

Model Number	Amazon ASIN	Item Name
HSY-HB215-P	B07N7BWR1V	5MP Bullet PoE Camera
HC725-P	B088YKQC7V	5MP Dome PoE Camera
AMZ-AHBB15-36	B07X9L12PQ	5MP Bullet PoE Camera with Spotlight
NVR-P-8	B075V3ZH3X	8CH PoE NVR
RJ45-B-20M	B07YWMLB1M	64ft Ethernet Cord
RJ45-B-50M	B07YWMJTND	160ft Ethernet Cord

*Please Email us at Love@Hiseeu.com for Free additional camera or Ethernet Cord.

Contents

Package Contents	01
Products Review	01
1 System Connection	03
2 Start Live View	05
2.1 System Wizard	05
2.2 System Login	06
2.3 Reset Password	08
2.4 Setup Video Recording	10
2.5 Video Playback	11
2.6 Video Backup	14
2.7 Rename The Camera	16
3 Access via Mobile App	16
3.1 Internet Connection.....	16
3.2 Download and Register an App Account.....	18
4. Access via PC Client	21
5 Setup Motion Detection	23
5.1 Enable Human Detection.....	23
5.2 Enable Audible Warning	24
5.3 Customize Arming Setting	25
5.4 Turn on/off Face Detection	27
5.5 Turn on/off Camera Spotlight.....	28
6 Add New Camera to NVR.....	29
7 Restore to Factory Setting	31

Package Contents



8 Channel NVR

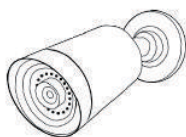

PoE Camera

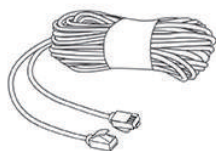

CAT5e Ethernet Cable
(with RJ 45 Waterproof Connector)

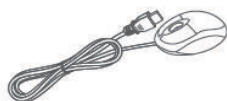

Wired Mouse

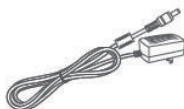

Power Adapter for NVR



Ethernet Cable

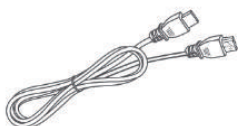

HDMI Cable



Screw(For Hard Drive)

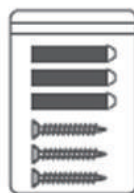

Screw Sets(For Camera)

※If there is any part missing or damaged, please contact Hisseu Customer support.

Products Review

NVR Details

Type I: Stand-alone NVR

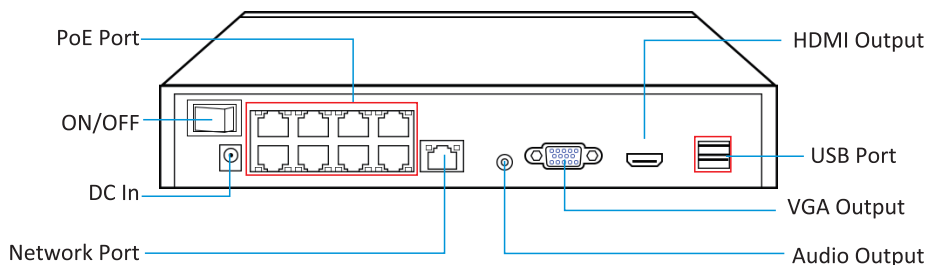

Type II: Combo NVR

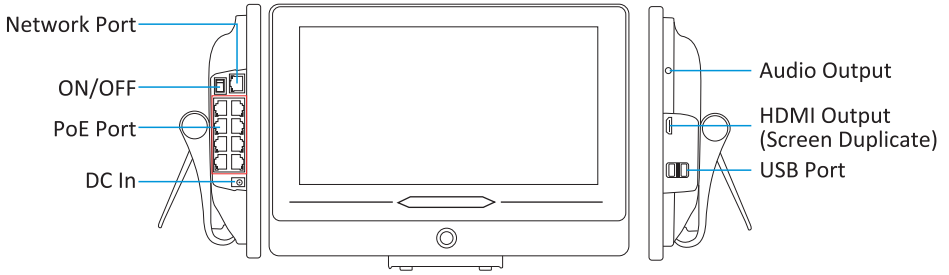

Camera Details

Type I: Bullet

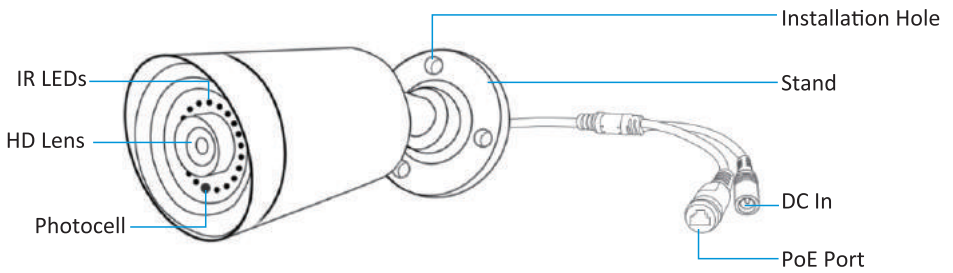

Type II: Dome

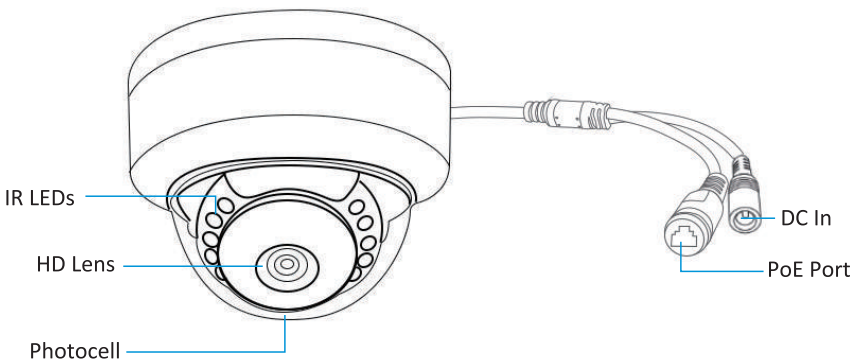

1 System Connection

Before you start:

- 1) Please test the camera before installation
- 2) Free mobile APP “XMeye Pro”, can be download from “APP Store” or “Google Play”
- 3) PC Client Download Link:
Windows: <https://download.xm030.cn/d/MDAwMDE0OTM=>
Mac: <https://download.xm030.cn/d/MDAwMDA2NDA=>

Steps:

1. Connect Cameras to NVR box by CAT5e Ethernet Cable provided.

The system is PoE (Power over Ethernet). The camera only needs to be connected to NVR by the Ethernet cord provided. No need for an additional power supply.

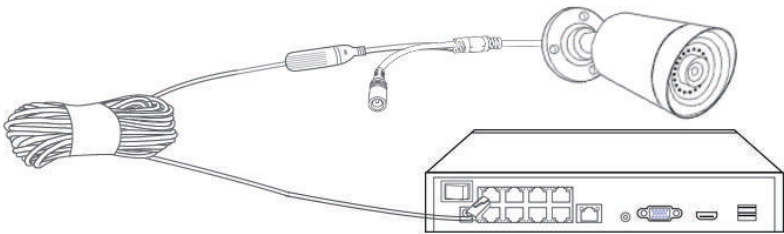

After routing and connecting the cables, use the waterproof tapes to wrap up the cables. Connected cables and spare cables both should be wrapped up as the figures below.

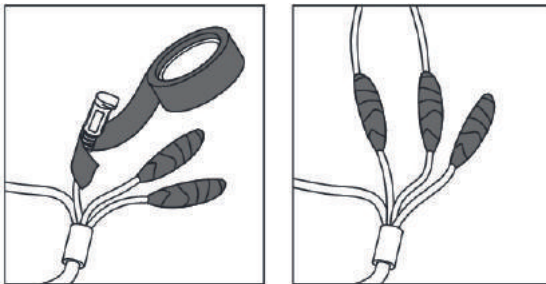

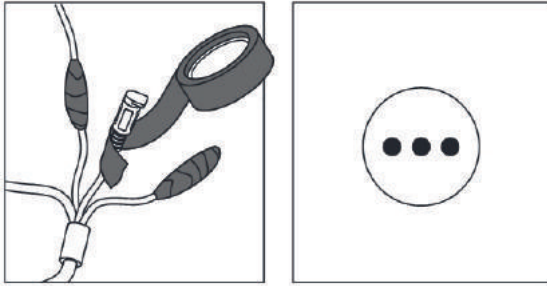

2. Connect NVR box to monitor by HDMI cable provided.

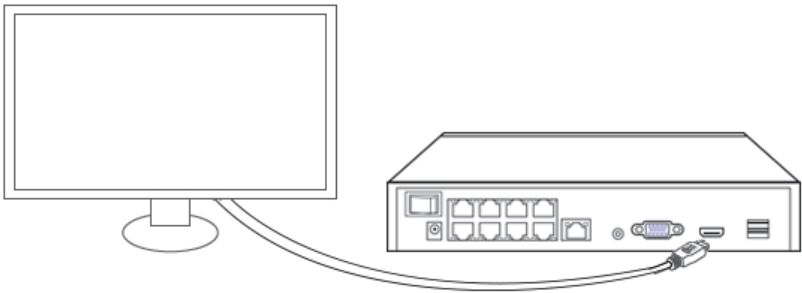

Please ensure the monitor resolution is above 1080P, otherwise will not working properly.

If the Hiseeu Logo pops up, then goes black, please right-click and hold the mouse for over 10 seconds, NVR will auto reboot with the lowest resolution. (1024×768)

3. Connect NVR's mouse, and power on the NVR with the original power adapter.

Ensure the connection is secured, then turn on the NVR by pressing the switch button.

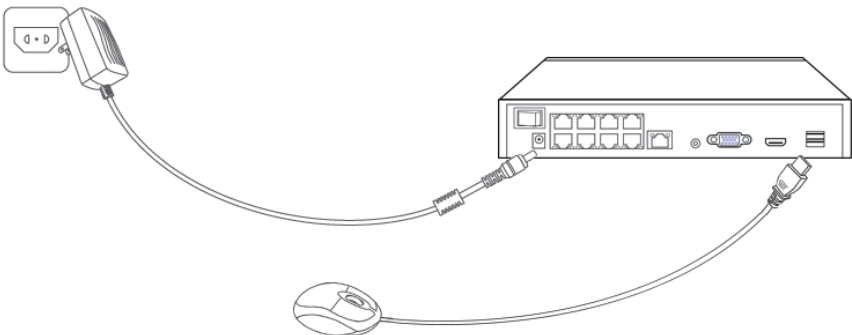

4. Hook NVR box to Network by Ethernet cable provided.

Tips:

- a. The system can work without internet if you only need local monitoring
- b. Internet is only necessary If you want to remote access the system from APP or PC Client, please connect the NVR box to internet by the network cable provided.

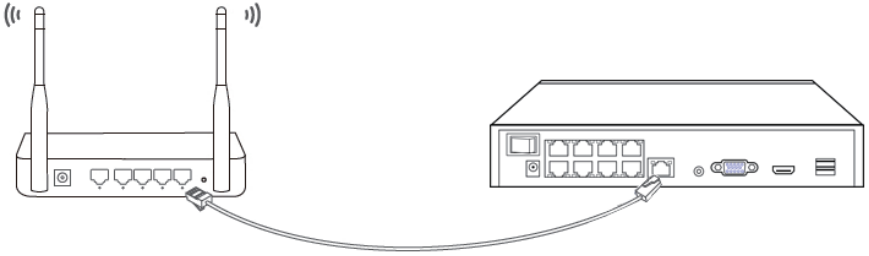

2 Start Live View

2.1 System Wizard

- 1. Setup system according to prompts.
- Or Hit **“No more hints”** to exist system wizard.



2.2 System Login

1. In the first time login, the system will generate a random user name and password.

We highly recommend click on “**Modify Pwd**” to create your own user name and password for your security concern.

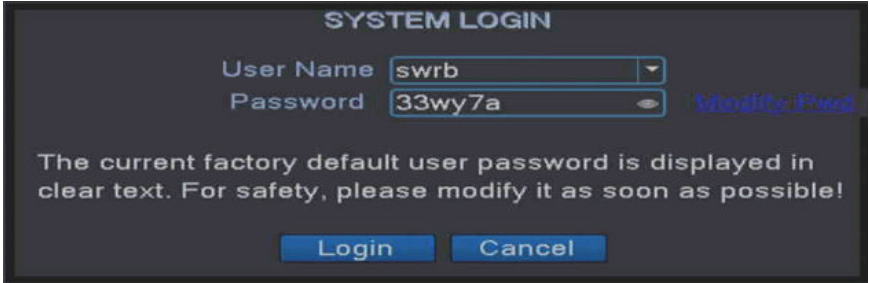

The image shows a dark-themed login screen titled "SYSTEM LOGIN". It features two input fields: "User Name" with the value "swrb" and a dropdown arrow, and "Password" with the value "33wy7a" and an eye icon. To the right of the password field is a blue link labeled "Modify Pwd". Below the fields is a message: "The current factory default user password is displayed in clear text. For safety, please modify it as soon as possible!". At the bottom are two blue buttons: "Login" and "Cancel".

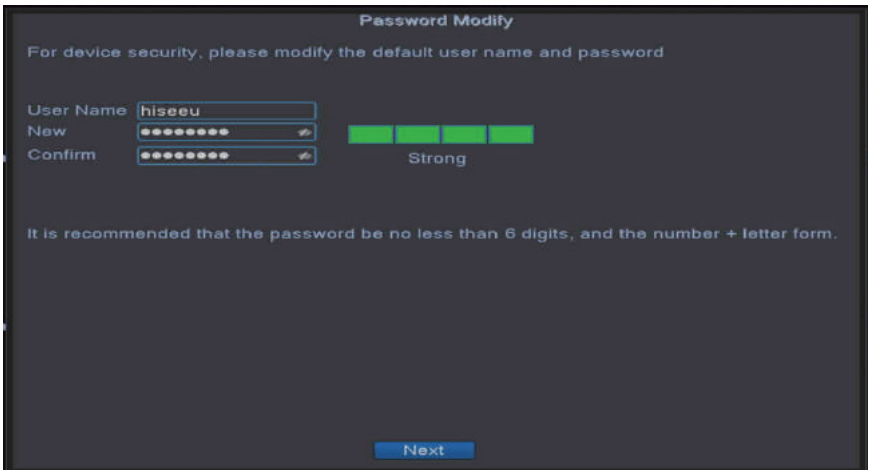

The image shows a dark-themed "Password Modify" screen. It starts with the title "Password Modify" and the instruction "For device security, please modify the default user name and password". There are three input fields: "User Name" with the value "hiseeu", "New" with a masked password of seven dots and a copy icon, and "Confirm" with a masked password of seven dots and a copy icon. To the right of the "New" field is a strength indicator consisting of four green bars, with the word "Strong" below it. At the bottom is a blue button labeled "Next". A note at the bottom of the screen reads: "It is recommended that the password be no less than 6 digits, and the number + letter form."

2. Set up “Safety Question” and Enable password retrieve via APP.

Safety question

Please complete the following information to reset your password later

Safety Question

Question:

Answer:

Question:

Answer:

Reset password by verification code

Send verification code to monitor APP

Send verification code to my contact profile

Email:

OK

Tips:

- If you don't want to set “Safety Question”, please press the “Esc” button on NVR front panel to skip this step.
- If you forget the password you created, you can reset it by answer safety question, or reset via APP.

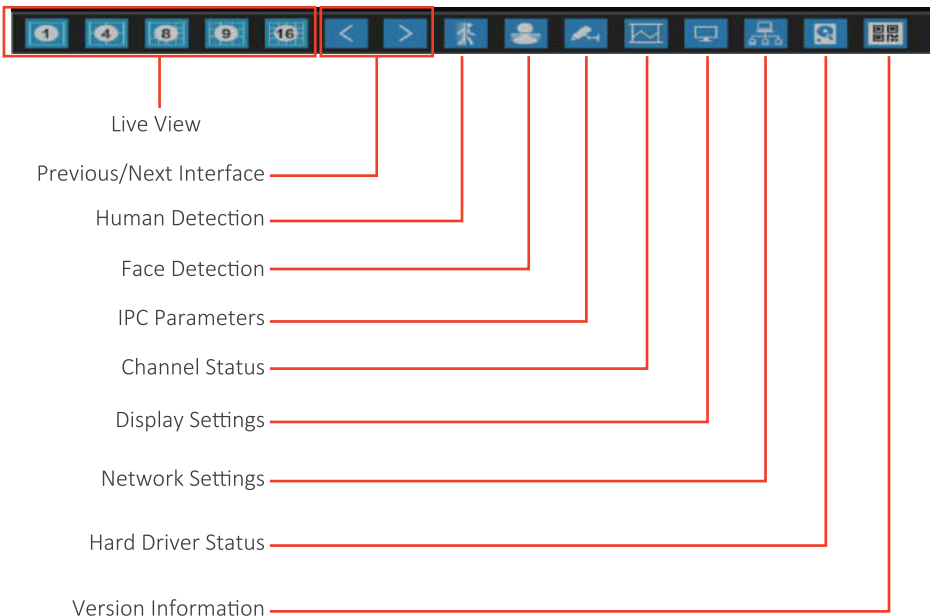

2.3 Reset Password

If you forget the password or the system comes with factory default password, please follow the instruction to rest it.

1. In the “SYSTEM LOGIN” interface, click on “Forgot password”/”Forget Answer?”

SYSTEM LOGIN

User Name

Password

Remember password [Forgot password](#)

Please Login

Safety question

Please answer these questions to reset password

Question

Answer

Question

Answer

[Forget Answer?](#)

2. If the system was setup to reset password via Mobile APP, you will see these bar code on the screen.



3. Download mobile APP “XMeye Pro”, register an account and login
As for how to register APP account, please refer to [page 18-19](#).

4. Use the APP to scan the “CAPTCH” QR code, will generate a CAPTCHA code, input the code and follow the prompt to rest password.

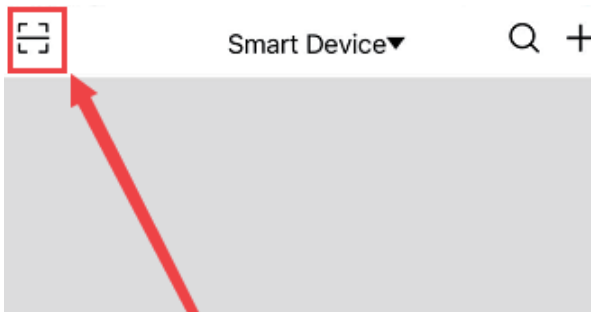

Tips:

If you unable to scan the QR code, or can't get CAPTCH code successfully, please screenshot it and email us at Love@Hiseeu.com

2.4 Setup Video Recording

2.4.1 24/7 Video Recording

Before you start:

The system was setup for 24/7 continues recording as default settings, with motion detect recording checked.

Please navigate to **Main Menu** → **Record Config.**

Week: All

Period: 00:00 – 24:00

Regular: Normal Recording

Detect: Motion Detect Recording



2.4.2 DIY Recording Plan

To make hard drive works effective, you can customize recording plan for each camera individually.

For example, **channel 3** only needs to be recording during Saturday, from **8:00 to 18:00** when motion (human) detected.

A. Channel: 3

B. Week: Sat (Saturday)

C. Period: 08:00 – 18:00

D. Detect: Checked

Remember click on **“OK”** to save the settings.

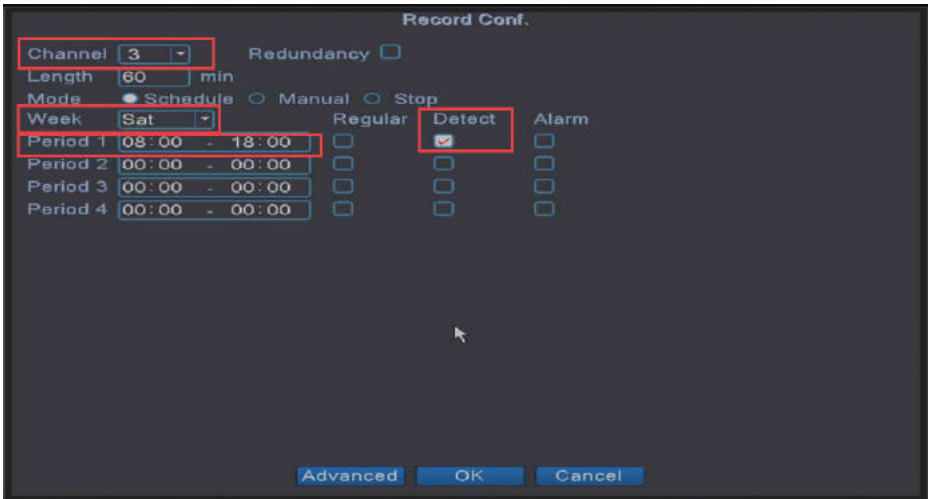

2.5 Video Playback

2.5.1 Common Playback

1. Right-Click Mouse, click on “Playback”, Or navigate to Main Menu → Playback

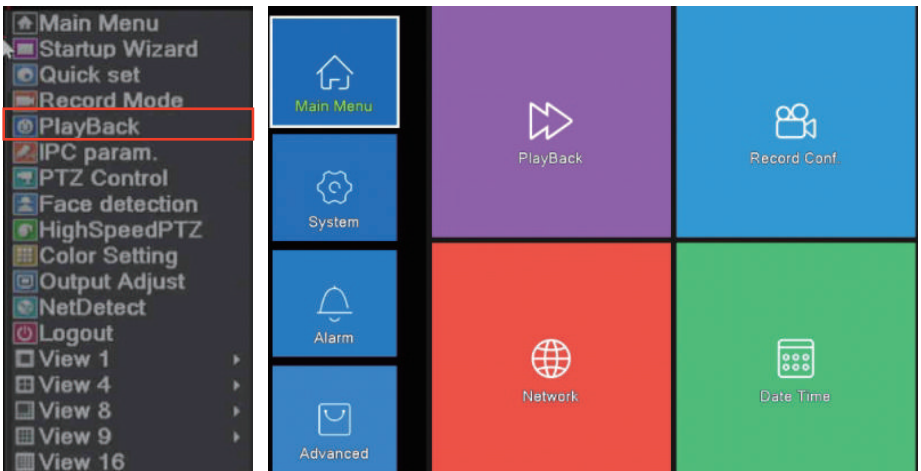

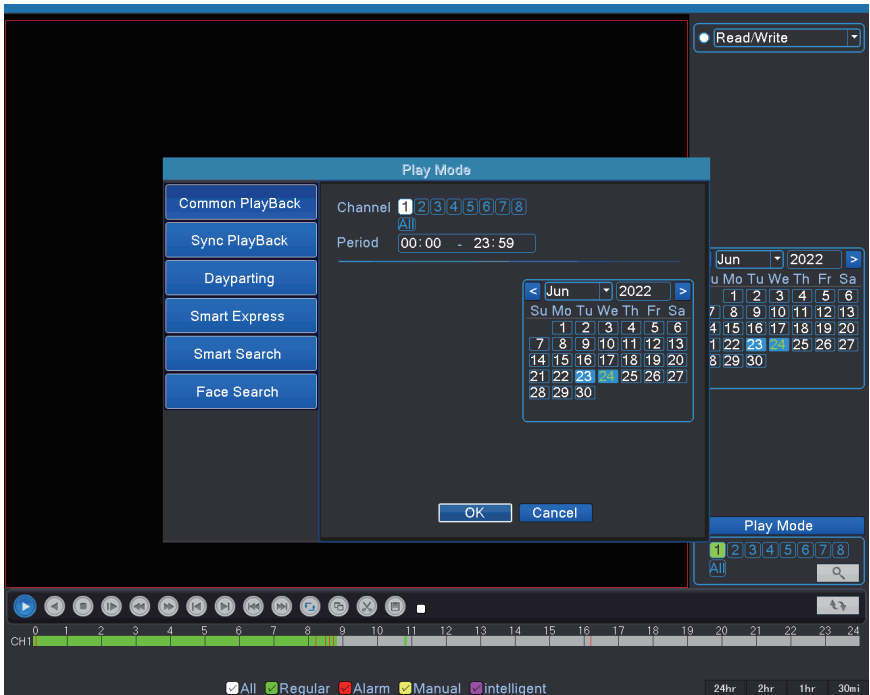

2. Select Channel, Period, date, then click “OK”

Tips:

- a. **Green:** Regular Recording
- b. **Red:** Alarm Recording
- c. You also can double-click mouse on the time bar to locate the recording quickly.

2.5.2 Smart Playback by Face Detected

Before you start, please make sure the face detection was enabled.
 (Refer to page 27)

1. Right-Click Mouse, hit “Playback”, or go to **Main Menu**→ **Playback**→ **Face Search**
2. Select Chanel and date, click “OK”
3. Click on the face detected, to playback the particular video

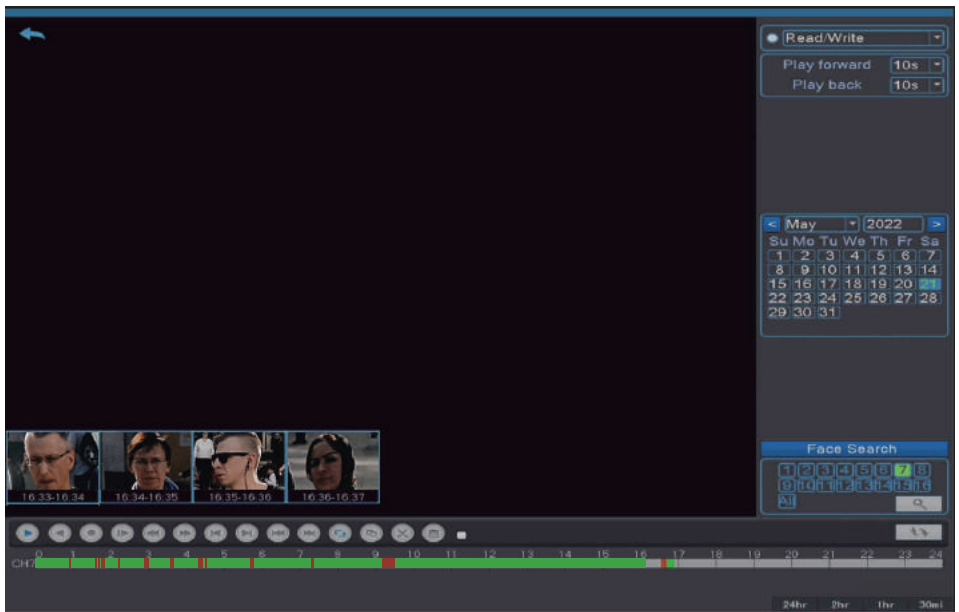

	Play/Pause		Reverse to play
	Stop		Play in slow motion
	Fast Reverse		Fast Forward
	Previous Frame		Next Frame
	Previous Video		Next Video
	Repeat to play all the videos recorded on the selected day		Full Screen
	Start/End video cutting		Backup

2.6 Video Backup

1. Insert your USB device to NVR's USB port.
2. Right-Click Mouse, navigates to Main Menu → System → Backup.

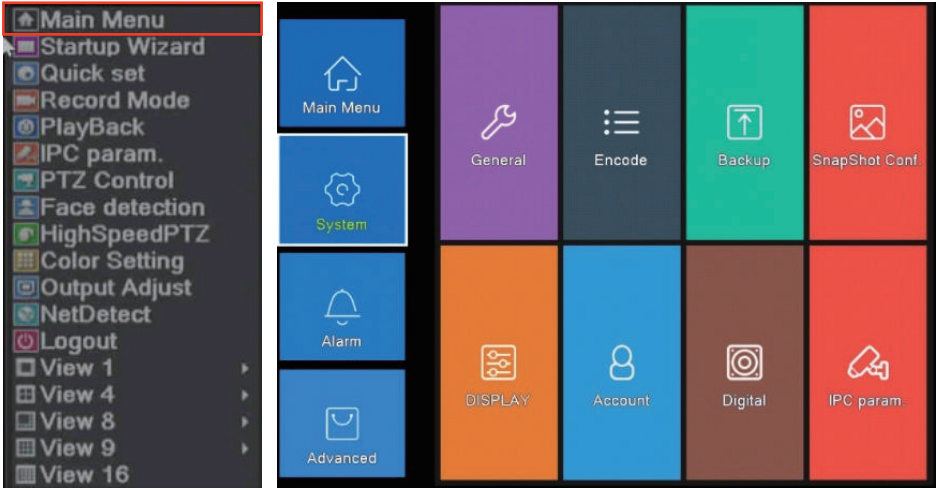

3. NVR will detect available USB device, click “Backup”.
- If your USB device didn't show up, click “Detect”.



4. Select Record Type→ Select Channel→ Set the Time→ Click Add

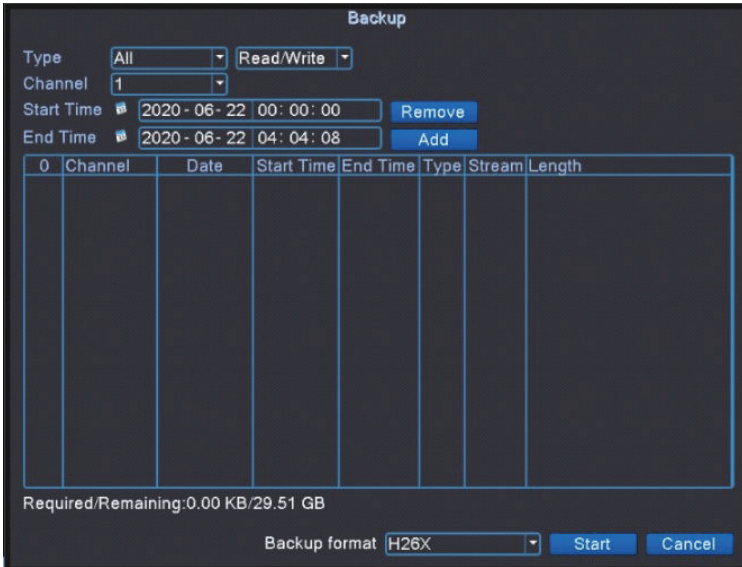

5. Select the video files→ Choose “Backup format”→ Start.
Please choose “MP4”, it’s compatible with most of video player.



2.7 Rename the Camera

Camera's default name is "AI CAM", you can change the camera title as you like. Please right-click mouse and navigate to **Main Menu**→ **System**→ **Display**→ **Set**



3 Access via Mobile APP

3.1 Internet Connection

1. Please connect NVR box to Router by Network Cable;
2. Right-Click Mouse Navigate to **Main Menu**→ **Network**→ **Enable DHCP**;

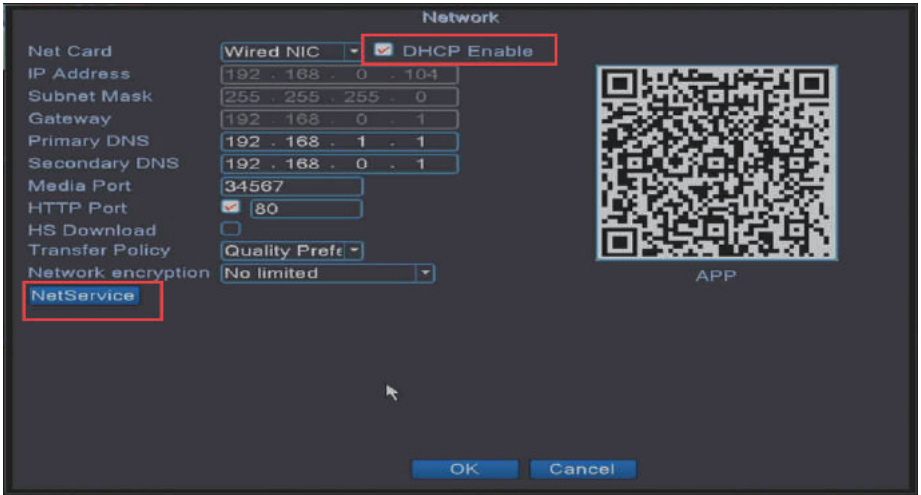

3. Click on “Net Service”, if the “Cloud Status” shows connected, means NVR is online click “OK” navigate to next step

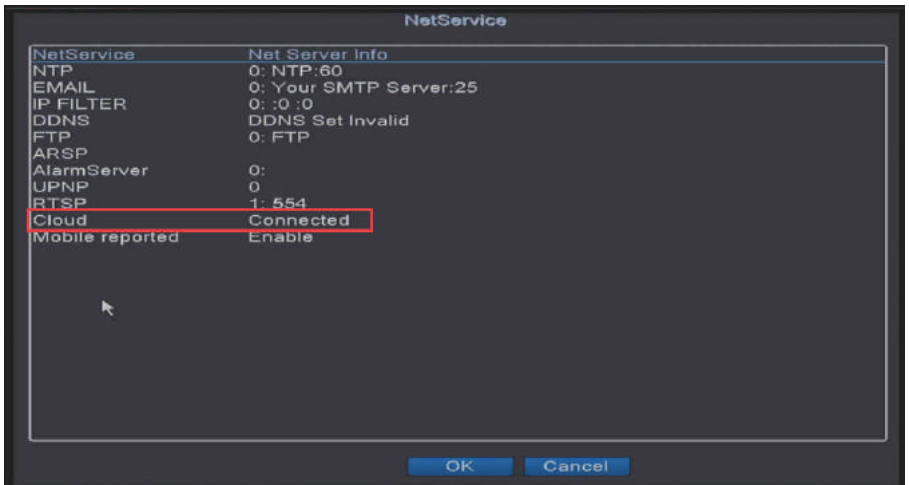

✘ If the “Cloud Status” shows “Probing DNS”, please reboot NVR device by press ON/OFF button. If the problem remains, please contact the vendor.

4. Please navigate to **Advanced**→ **Version**

Make sure “**Nat status**” is “**Connected**”.

The “**Serial Number**” and the QR code is required when you add device on APP or PC Client.

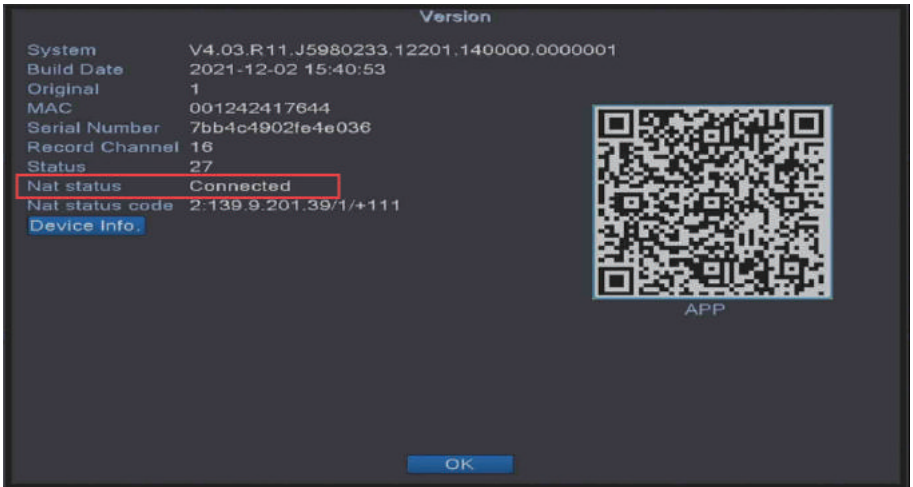

3.2 Download and register an APP account

1. Download “**XMeye Pro**” from APP store or Google Play
Or scan the QR code to download it.



XMeye Pro



Scan QR code

2. Tap on “**Sign Up**” to register an account by Email or Mobile Number.

Tips:

- a. You can tap on **“Local”** for quick login without registration. In this situation, you still can have live view and playback, but not able to received motion detect alarm message
- b. If failed to receive the verification code, please contact our customer service

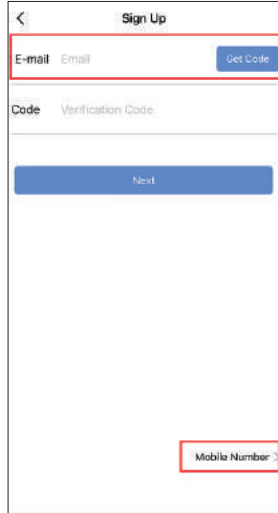
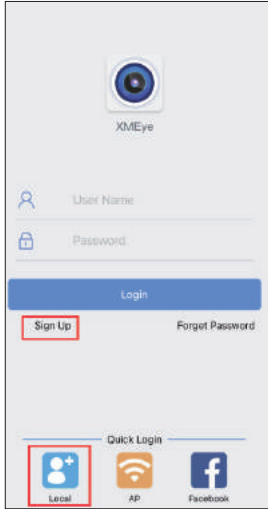

3. Follow the prompt to create your user name and password in the APP and login.

4. Tap on **“Add Device”** or **“+”** Select **“NVR”**

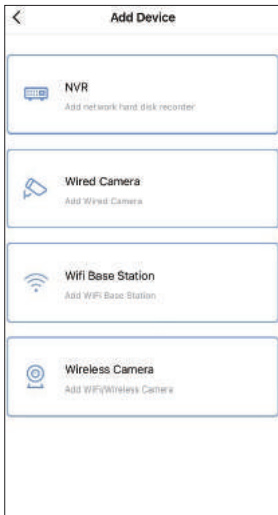
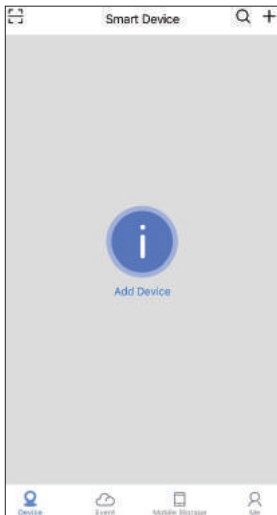

5. Fill out device information

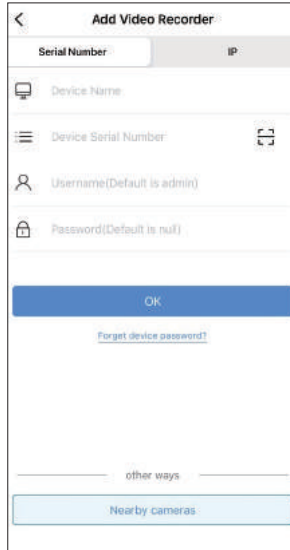

Device Name: Name Your Device as you like

Device Serial Number: Please navigate to **Main Menu**→ **Advanced**→ **Version**

Input the NVR serial number manually or scan the QR code.

(Refer to page 18)

User Name and password:

Input the user name and password that you created for the NVR

(Refer to page 08)

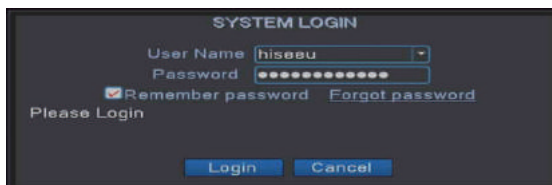

4 Access via PC Client

PC Client Download Link:

Windows: <https://download.xm030.cn/d/MDAwMDE0OTM=>

Mac: <https://download.xm030.cn/d/MDAwMDA2NDA=>

Any questions, please email customer service.

1. Download PC Client “VMS” and installed
2. Login with default User Name and Password. Click “SIGN IN”.

Default User name is: admin

Default Password is: admin

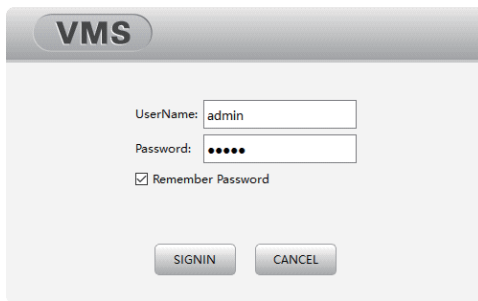

3. Navigate to “Device Manager”.

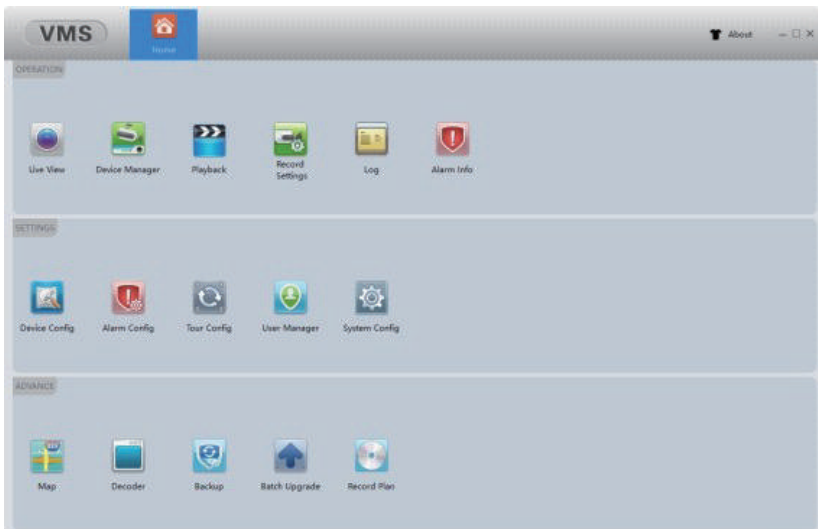

4. Manual Add.

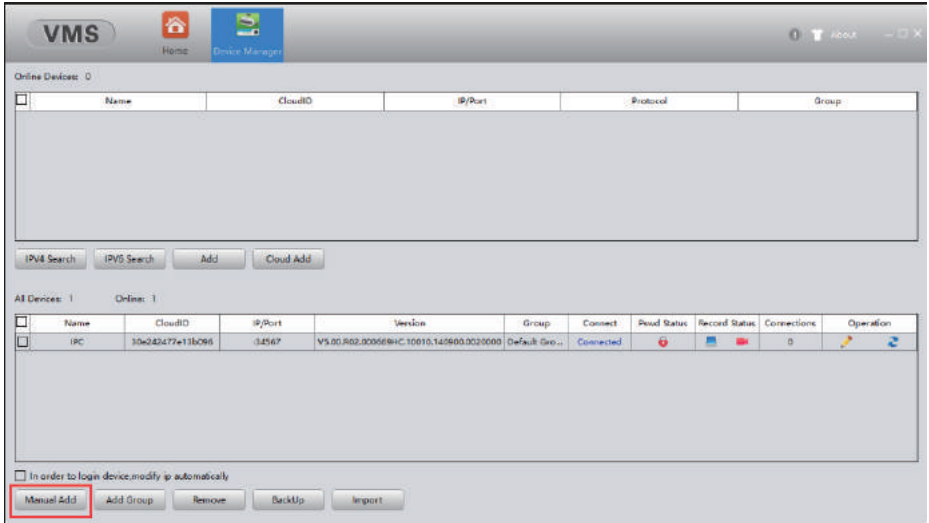

The 'Add Device' dialog box contains the following fields and options:

- Device Name: IPC
- Group: Default Group
- Login Type: CloudID
- CloudID: 30e242477e13b096
- UserName: admin
- Password: (empty field)
- Protocol: XM

At the bottom of the dialog, there are three buttons: 'Save And Continue', 'OK', and 'Cancel'.

Device Name: Name Your Device as you like

Device Serial Number: Please navigate to **Main Menu**→ **Advanced**→ **Version**

Input the NVR serial number manually or scan the QR code.

(Refer to page 18)

User Name and password:

Input the user name and password that you created for the NVR

(Refer to page 08)

5. Navigate to Home→ Live View, double-click the camera for live view

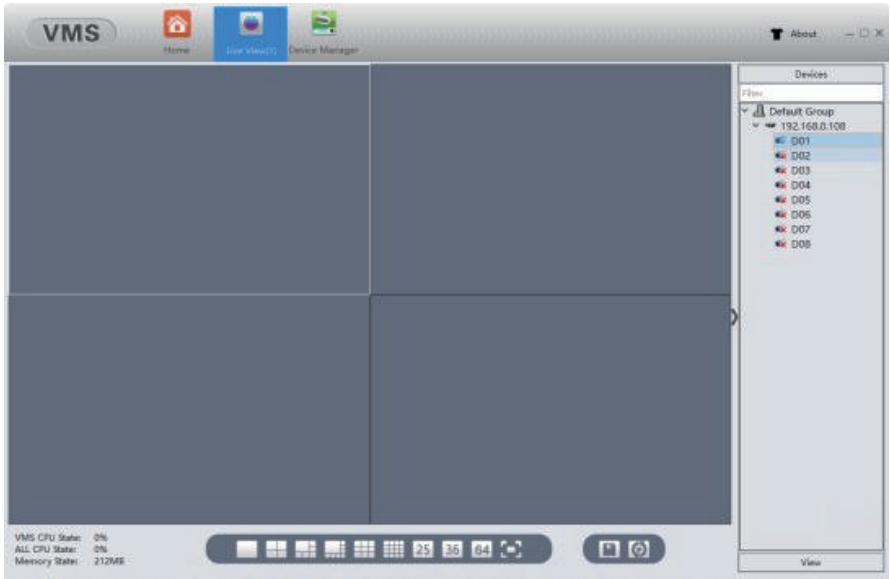

5 Setup Motion Detection

5.1 Enable Human Detection

1. Please right-click mouse navigate to Main Menu→ Alarm→ Intelligent Alert

2. Select Channel, check “Enable” and “Human Detect”

"Motion Detect": Will activated whatever object captured (like leaves or rain)

"Human Detect": AI humanoid detection, can minimize false alarm, reduce false alerts

3. Please enable "Mobile Reported", it will alert you with screenshot via APP when motion detected.

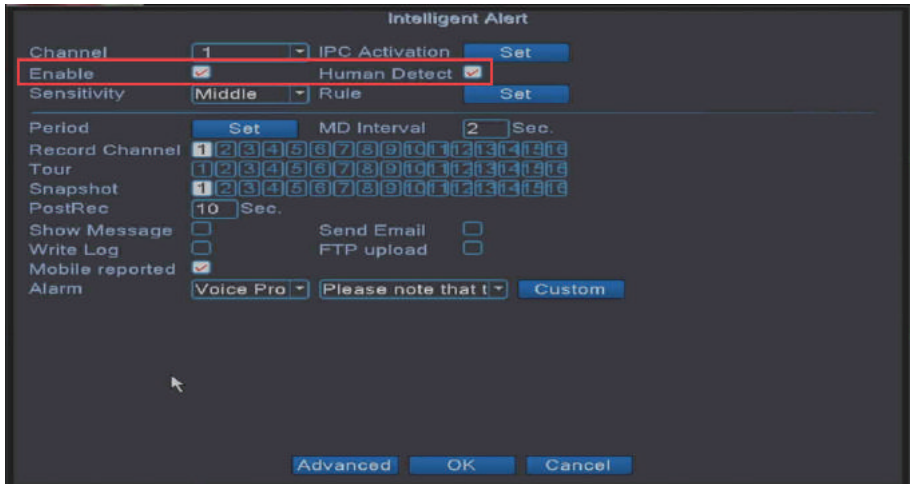

4. Log in mobile APP “XMeye Pro” navigate to “Event” → Settings → Allow Notifications.

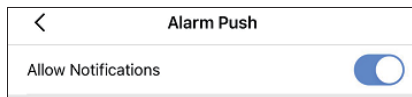

5.2 Enable Audible Warning

5.2.1 Enable audible warning for camera

IPC Activation: Click on “Set” to enable “Alarm Sound”

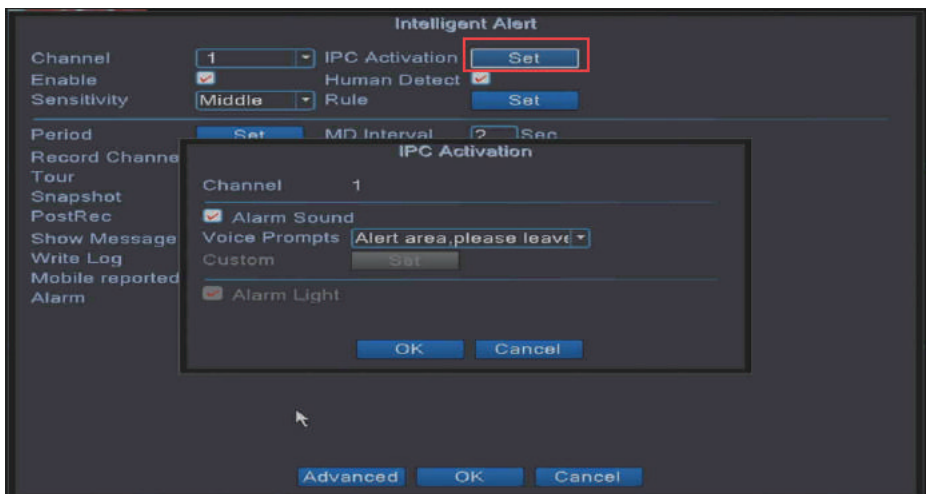

5.2.2 Enable audible warning for NVR

- A. Please connect NVR to monitor by HDMI Cable
- B. Please make sure the monitor built-in speaker

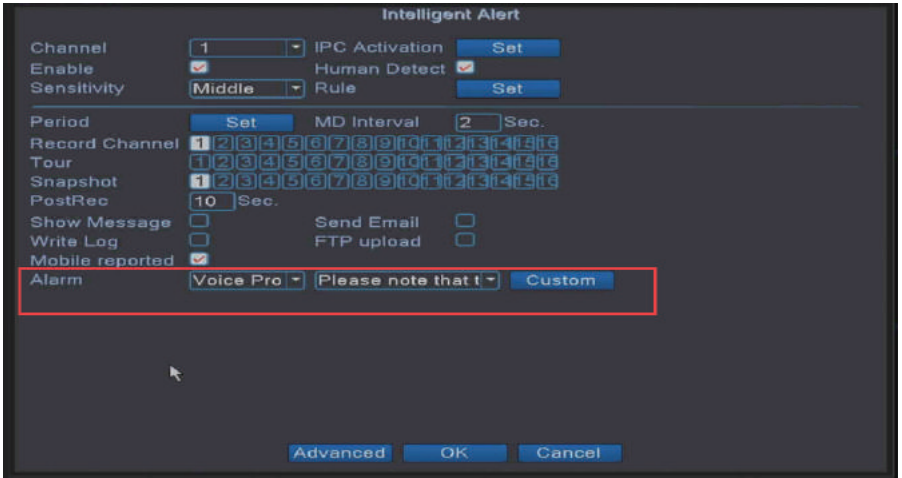

5.3 Customize Arming Setting

- 1. To reduce false alarm, you can adjust the sensitivity, schedule arming period.

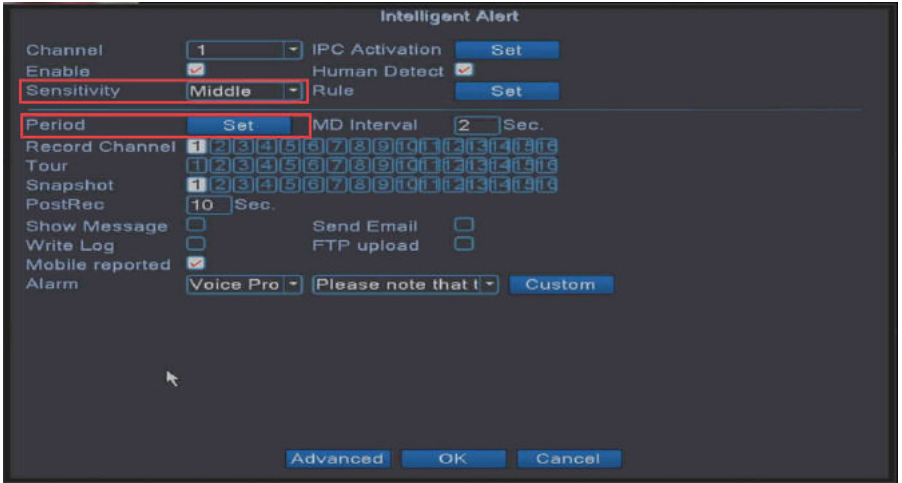

2. DIY alarm area and rule

Rule: click on "Set"

A: Region Intrusion Alert

Will only alert when someone entered to the certain area



B: Tripwire Alert

Will only alert when someone crossing the line



5.4 Turn on/off Face Detection

1. Please right-click mouse and click on “Face Detection” to enable or disable face detection on the home screen.

After enabled, the face detected will be listed in the right side



2. Please navigate to Main Menu→ Alarm→ Face Detection
Select a channel and enable it.

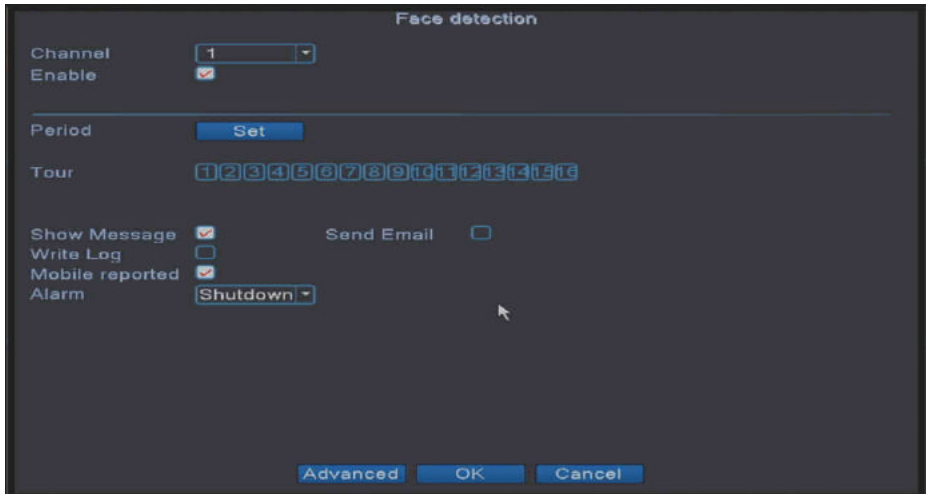

3. If you want to disable “Face Detection”,
Please navigate to Main Menu→ Advanced→ Version→ Device Info
Uncheck “Enable face detection”

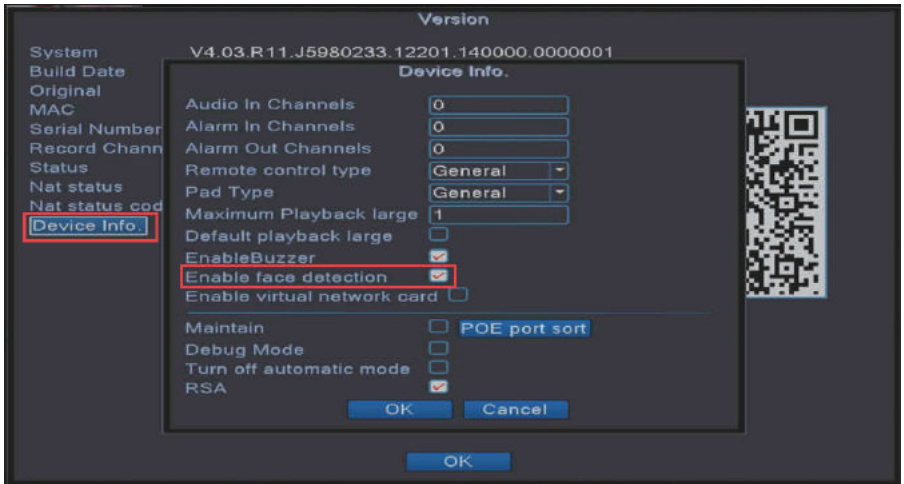

5.5 Turn on/off Camera Spotlight

Please note: Only certain models support spotlight.

1. Please right-click mouse and select “IPC Param”
2. Day/Night Mode:
 - 1) Star Light Infrared: Not available now
 - 2) Full Color: Not available now
 - 3) Black and White: Always black and white during the day and night
 - 4) Smart Alert: Spotlight will turn on when motion detected at night. Colorful during the day, black and white at night
 - 5) Intelligent Variable Light: Spotlight will always turn on at night. Colorful during the day and night
 - 6) Smart Infrared: Colorful during the day, black and white at night.

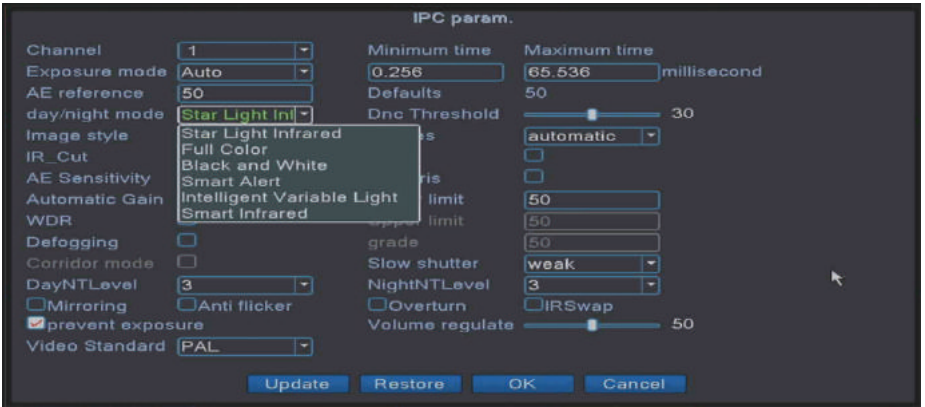

6 Add New Camera to NVR

Before you start:

1. Please connect the camera to NVR box by Ethernet cable, make sure camera are powered on properly

A: Blinking indicator light

B: Red color infrared light when cover the photocell

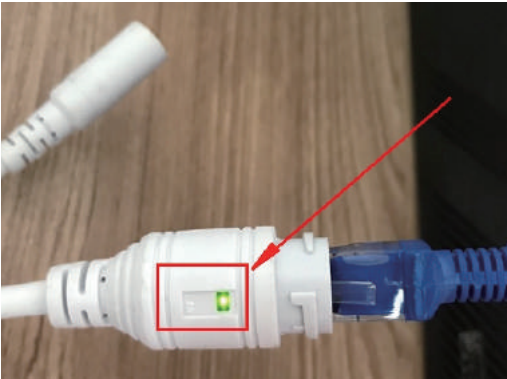

2. Right-click mouse and click on “Quick Set” (Or Channel Set)
NVR will detect and connect camera automatically

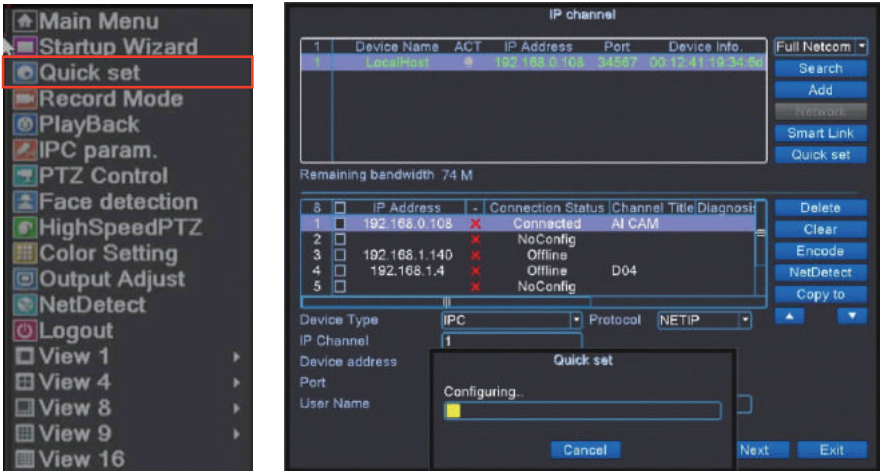

3. If the camera still not connected, please manual add as below.
 - a) In the second box, if the camera status is “offline” or “Wrong user name or password”, Please click “X” to delete it first.
 - b) Click “Search”, NVR will search camera under same network and display it in the first box.
 - c) Select the new cameras IP address click on **Network**→ **Auto Assigned**→ **Ok**
(To make sure camera and NVR under same IP segment, NVR will auto assign IP address)
 - d) Select the camera again, click “Add”
 - e) After configuration successful, click “Apply” to save settings then click “Exit”.

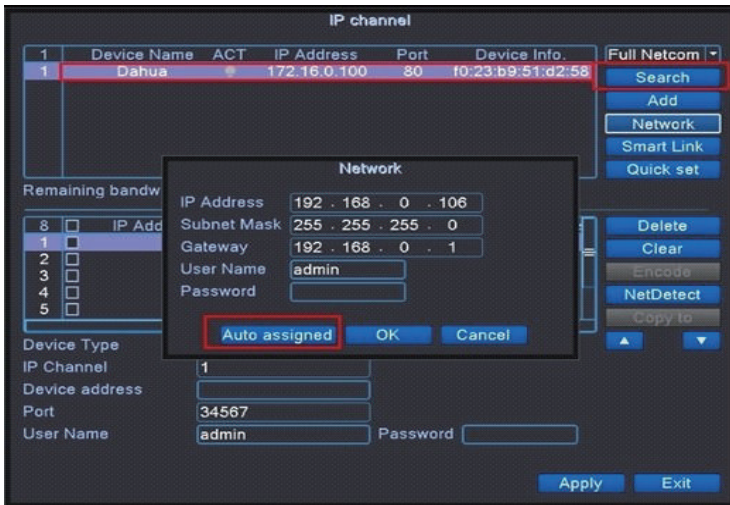

If operated failed, please contact our customer service for further solutions.

7 Restore to Factory Setting

Please right-click mouse and navigates to Main Menu→ Advanced→ Restore

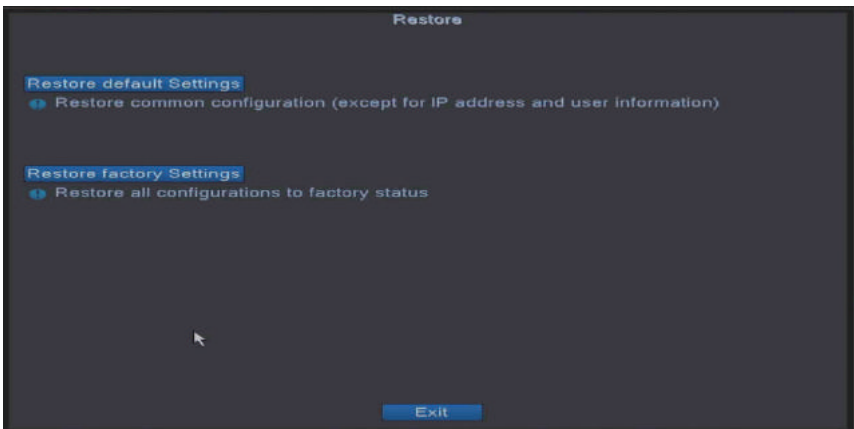

If our product didn't meet your expectation, and you want to return it, for your security concerns please help restore factory settings before returning.

It will erase your personal information (password, footage, email, etc.)



Amazon: Love@Hiseeu.com

Aliexpress: Support@Hiseeu.com

Web: www.hiseeu.com

Tel: +1 917 688 2228