

B005-V1.0



# PoE Camera System

## Quick Start Guide

Any Questions During Operating Our System, Please Feel Free to Contact Us at  
Love@HiSeeu.com (917 688 2228)

# Thank You!

Dear Valued Customer,

Greeting from Hiseeu Team! Thank you for choosing our products and hope everything going well with you and your family.

Our products were certificated with CE, FCC, and UL for safety. Any difficulties during operating the system, please feel free to contact us, we will always try our best to assist you.

If you are satisfied with our product, could you please take a moment to share your experience on Amazon? Your positive feedback means a lot to us and can encourage us to go further.

And if unfortunately, our products didn't meet your expectation, for security concerns please help us "Restore to Inactive", (Referring Page 30) before sending it back to Amazon. It will erase your personal information (footage, email, etc.)

On behalf of all colleagues in Hiseeu, we sincerely appreciate your trust and support. Please let us know if there is anything we can do to assist you further. Thanks again and wish you all the best.

Yours Sincerely,  
All staff in Hiseeu  
Tel: 917 688 2228  
Email: Love@Hiseeu.com

# Regulatory Information

## FCC Information

Please take attention that changes or modification not expressly approved by the party responsible for compliance could void the user's authority to operate the equipment.

**FCC compliance:** This equipment has been tested and found to comply with the limits for a Class B digital device, pursuant to part 15 of the FCC Rules. These limits are designed to provide reasonable protection against harmful interference in a residential installation. This equipment generates, uses and can radiate radio frequency energy and, if not installed and used in accordance with the instructions, may cause harmful interference to radio communications. However, there is no guarantee that interference will not occur in a particular installation. If this equipment does cause harmful interference to radio or television reception, which can be determined by turning the equipment off and on, the user is encouraged to try to correct the interference by one or more of the following measures:

- Reorient or relocate the receiving antenna.
- Increase the separation between the equipment and receiver.
- Connect the equipment into an outlet on a circuit different from that to which the receiver is connected.
- Consult the dealer or an experienced radio/TV technician for help

## FCC Conditions

This device complies with part 15 of the FCC Rules. Operation is subject to the following two conditions:

1. This device may not cause harmful interference.
2. This device must accept any interference received, including interference that may cause undesired operation.

## EU Conformity Statement

 This product and- if applicable- the supplied accessories too are marked with "CE" and comply therefore with the applicable harmonized European standards listed under the EMC Directive 2014/30/EU, the RoHS Directive 2011/65/EU.

 2012/19/EU (WEEE directive): Products marked with this symbol cannot be disposed of as unsorted municipal waste in the European Union. For proper recycling, return this product to your local supplier upon the purchase of equivalent new equipment, or dispose of it at designated collection points. For more information see: [www.recyclethis.info](http://www.recyclethis.info)

 2006/66/EC (battery directive): This product contains a battery that cannot be disposed of as unsorted municipal waste in the European Union. See the product documentation for specific battery information. The battery is marked with this symbol, which may include lettering to indicate cadmium (Cd), lead (Pb), or mercury (Hg). For proper recycling, return the battery to your supplier or to a designated collection point. For more information see: [www.recyclethis.info](http://www.recyclethis.info)

## Industry Canada ICES-003 Compliance

This device meets the CAN ICES-3 (B)/NMB-3(B) standards requirements.



## Safety Instruction

These instructions are intended to ensure that user can use the product correctly to avoid danger or property loss.

The precaution measure is divided into "Warnings" and "Cautions"

**Warnings:** Serious injury or death may occur if any of the warnings are neglected.

**Cautions:** Injury or equipment damage may occur if any of the cautions are neglected.

 <b>Warnings</b>	<b>Warnings</b>	Follow these safeguards to prevent serious injury or death.
 <b>Cautions</b>	<b>Cautions</b>	Follow these precautions to prevent potential injury or material damage.

### Warnings

- Proper configuration of all passwords and other security settings is the responsibility of the installer and/or end-user.
- In the use of the product, you must be in strict compliance with the electrical safety regulations of the nation and region. Please refer to technical specifications for detailed information.
- The power source should meet limited power source or PS2 requirements according to IEC 60950-1 or IEC 62368-1 standard.
- Do not connect several devices to one power adapter as adapter overload may cause over-heating or a fire hazard.
- Please make sure that the plug is firmly connected to the power socket. When the product is mounted on wall or ceiling, the device shall be firmly fixed.
- If smoke, odor or noise rise from the device, turn off the power at once and unplug the power cable, and then please contact the service center.

### Cautions

- CAUTION: Hot parts! Burned fingers when handling the parts. Wait one-half hour after switching off before handling parts. This sticker is to indicate that the marked item can be hot and should not be touched without taking care. For device with this sticker, this device is intended for installation in a restricted access location, access can only be gained by service persons or by users who have been instructed about the reasons for the restrictions applied to the location and about any precautions that shall be taken.



- Make sure the power supply voltage is correct before using the camera.
  - Do not drop the camera or subject it to physical shock.
  - Do not touch sensor modules with fingers. If cleaning is necessary, use clean cloth with a bit of ethanol and wipe it gently. If the camera will not be used for an extended period, please replace the lens cap to protect the sensor from dirt.
  - Do not aim the camera at the sun or extra bright places. Blooming or smearing may occur otherwise (which is not a malfunction), and affect the endurance of sensor at the same time.
  - The sensor may be burned out by a laser beam, so when any laser equipment is in using, make sure that the surface of sensor will not be exposed to the laser beam.
  - Do not place the camera in extremely hot, cold (the operating temperature shall be -30° C to +60° C, or -40° C to +60° C if the camera model has an "H" in its suffix), dusty or damp locations, and do not expose it to high electromagnetic radiation.
  - To avoid heat accumulation, good ventilation is required for operating environment.
  - Keep the camera away from liquid while in use.
  - While in delivery, the camera shall be packed in its original packing, or packing of the same texture.
  - Regular part replacement: a few parts (e.g. electrolytic capacitor) of the equipment shall be replaced regularly according to their average enduring time. The average time varies because of differences between operating environment and using history, so regular checking is recommended for all the users. Please contact with your dealer for more details.
  - This equipment is not suitable for use in locations where children are likely to be present.
  - CAUTION: Risk of explosion if the battery is replaced by an incorrect type. Dispose of used batteries according to the instructions
- ATTENTION: IL Y A RISQUE D'EXPLOSION SI LA BATTERIE EST REMPLACÉE PAR UNE BATTERIE DE TYPE INCORRECT. METTRE AU REBUT LES BATTERIES USAGÉES CONFORMÉMENT AUX INSTRUCTIONS
- Improper replacement of the battery with an incorrect type may defeat a safeguard (for example, in the case of some lithium battery types).
  - Do not dispose of the battery into fire or a hot oven, or mechanically crush or cut the battery, which may result in an explosion.
  - Do not leave the battery in an extremely high temperature surrounding environment, which may result in an explosion or the leakage of flammable liquid or gas.
  - Do not subject the battery to extremely low air pressure, which may result in an explosion or the leakage of flammable liquid or gas.
  - If the product does not work properly, please contact your dealer or the nearest service center. Never attempt to disassemble the camera yourself. (We shall not assume any responsibility for problems caused by unauthorized repair or maintenance.)

# Table of Contents

1 Appearance Description .....	01
Type I: Dome .....	01
Type II: Turret .....	02
Type III: Bullet.....	03
2 Installation .....	04
Memory Card Installation .....	04
Ceiling Mounting.....	04
Wall Mounting .....	06
Waterproof Measures.....	08
2.1.1 Install Network Cable Waterproof Jacket.....	08
2.1.2 Waterproof Other Cables .....	09
3 Star Up Your Device .....	09
3.1 Activate Your Device .....	09
3.2 Configure Unlock Pattern for Login .....	10
3.3 Login to System .....	10
4 Enter Wizard to Configure Quick Basic Settings.....	11
4.1 Time Zone .....	11
4.2 Enable “DHCP” .....	11
4.3 Remote Access Setting.....	12
4.4 Camera Status .....	13
4.5 Hard Drive Status .....	14
4.6 Start Live View .....	14
5 Log Out System .....	15
6 Main Menu Control Panel Description .....	15
7 Recording Settings .....	16
8 Motion Detection.....	16
9 Playback .....	17
10 Backup.....	18
11 Remote Access from Mobile APP .....	19
12 Retrieve Password.....	22
13 Add New Camera .....	23
14 Live View On PC Client.....	24
14.1 Create A Super User First.....	25
14.2 Password Protection .....	25
14.3 Home Screen Interface .....	26
14.4 Login with your mobile APP account.....	26
15 Troubleshooting.....	29

## 1 Appearance Description

This series of cameras have 3 appearances shown as the figures below.

### Type I: Dome

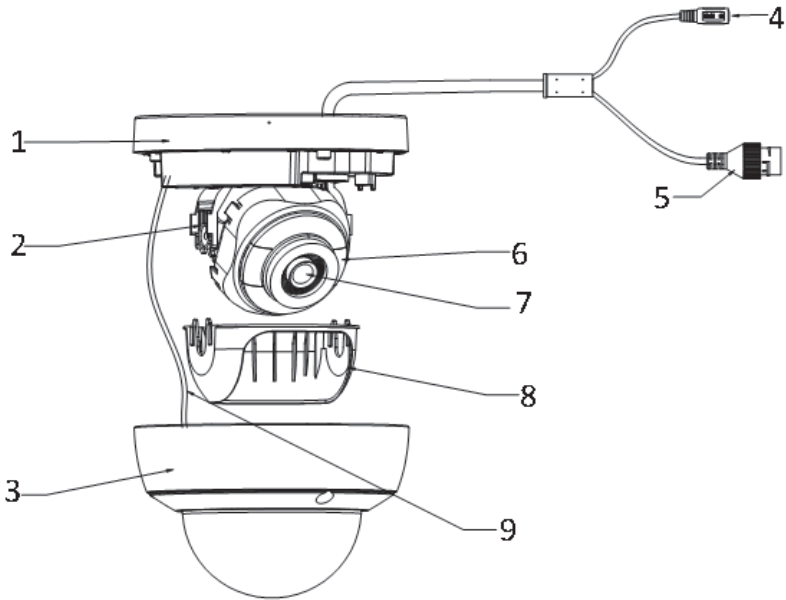

No.	Description
1	Mounting Base
2	Panning Adjusting Bracket
3	Front Cover
4	Power Cord
5	Network Cable
6	IR LED
7	Lens
8	Black Liner
9	Safety Rope

## Type II: Turret

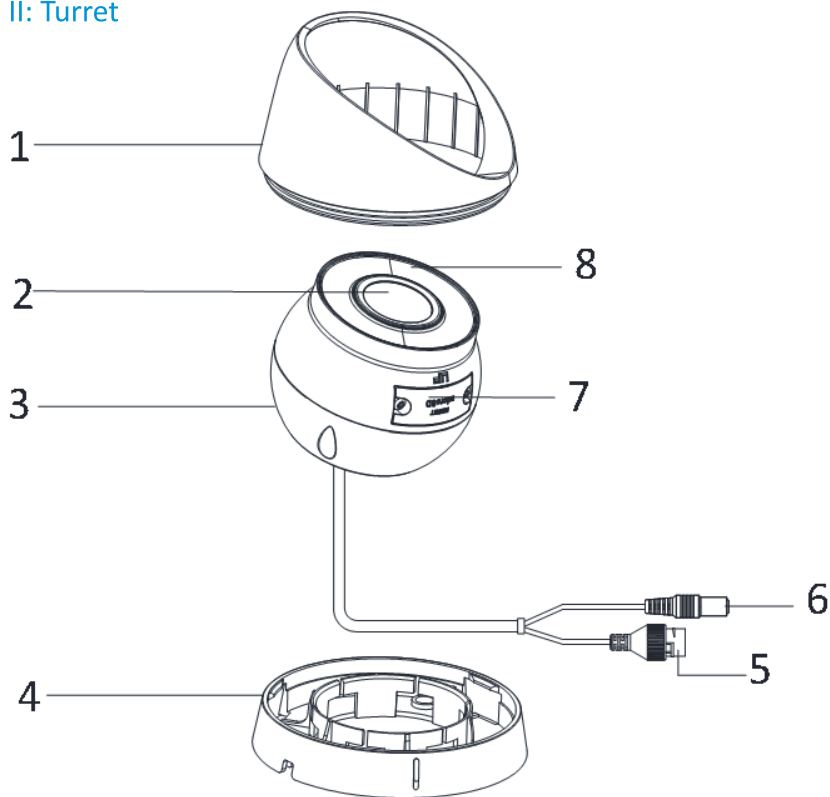

No.	Description
1	Enclosure
2	Lens
3	Camera Body
4	Mounting Base
5	Network Cable
6	Power Cord
7	Memory Card Slot Cover
8	Front Cover



## Type III: Bullet

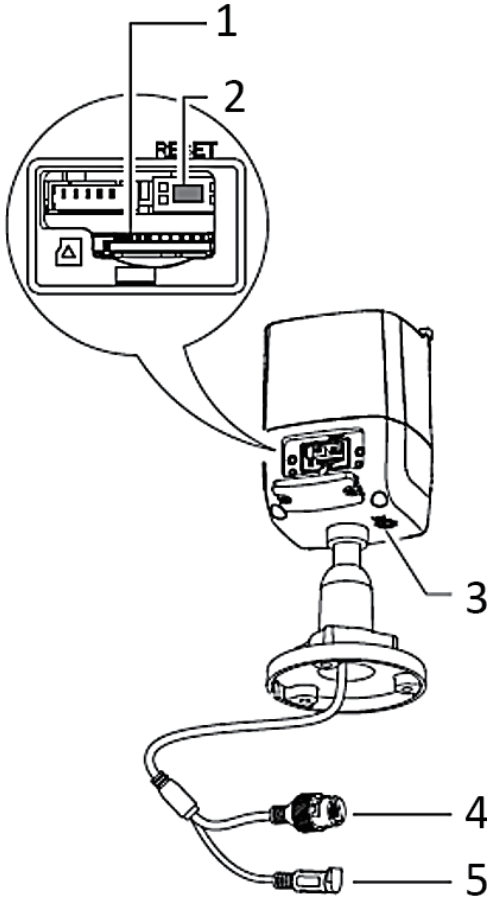

No.	Description
1	Memory Card Slot
2	Reset Button
3	Grounding
4	Network Interface
5	Power Interface

## 2 Installation

### Before you start:

- Make sure the device in the package is in good condition and all the assembly parts are included.
- The standard power supply is 12 VDC or PoE, make sure your power supply matches with your camera.
- Make sure all the related equipment is power-off during the installation.
- Check the specification of the products for the installation environment.
- Make sure that the wall is strong enough to withstand four times the weight of the camera and the bracket.
- Make sure that there is no reflective surface too close to the camera lens. The IR light from the camera may reflect back into the lens causing reflection.

### Memory Card Installation

Only certain camera models support memory card installation, you can follow the steps to mount and unmount the memory card.

#### Steps:

1. Rotate the camera to expose the memory card slot.
2. Loosen the screws to remove the memory card slot cover.
3. Insert the memory card into the memory card slot.
4. (Optional)To unmount the memory card, push to get it ejected.
5. Screw the cover back to the camera.

### Ceiling Mounting

#### Before you start:

Both wall mounting and ceiling mounting are suitable for the turret camera. Ceiling mounting will be taken as an example in this section. And you can take steps of ceiling mounting as a reference for wall mounting.

This camera series shares the same installation method, we take type III/IV turret camera as the example to illustrate the installation.

#### Steps:

1. Paste the drill template (supplied) to the desired mounting position on the ceiling.
2. Drill the screw holes and the cable hole in the ceiling according to the drill template.

**Note:** Drill the cable hole, if adopting ceiling outlet to route the cable.

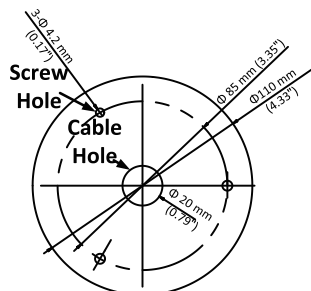

3. Disassemble the camera.

- 1). Rotate the camera to align the notch to one of the marks.
- 2). Insert a coin or another similar tool to the notch.
- 3). Press down the coin or another similar tool to pry the mounting base so as to separate the mounting base from the camera.

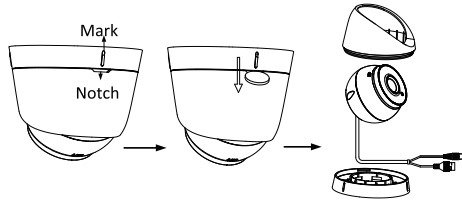

4. Fix the mounting base to the ceiling with supplied screws.

**Note:**

- In the supplied screw package, both self-tapping screws, and expansion bolts are contained.
- If the ceiling is cement, expansion bolts are required to fix the camera. If the ceiling is wooden, self-tapping screws are required.

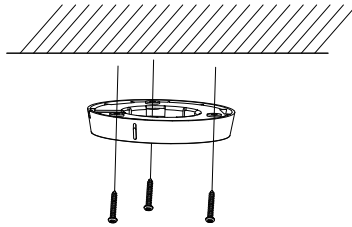

5. Route the cables through the cable hole or the side opening.

6. Install the camera body back to the mounting base.

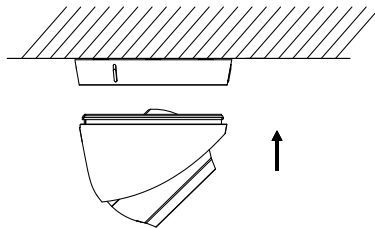

7. Connect the power cord and network cable.

8. Power on the camera, and set the network configuration (for details, refer to 3 Activate and Access Network Camera) to check whether the image is gotten from the optimum angle. If not, adjust the surveillance angle.

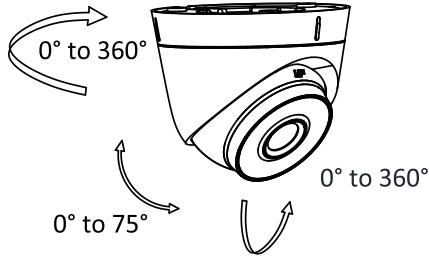

- 1). Hold the camera body and rotate the enclosure to adjust the pan angle [0° to 360°].
- 2). Move the camera body up and down to adjust the tilt angle [0° to 75°].
- 3). Rotate the camera body to adjust the rotation angle [0° to 360°].

## Wall Mounting

1.1

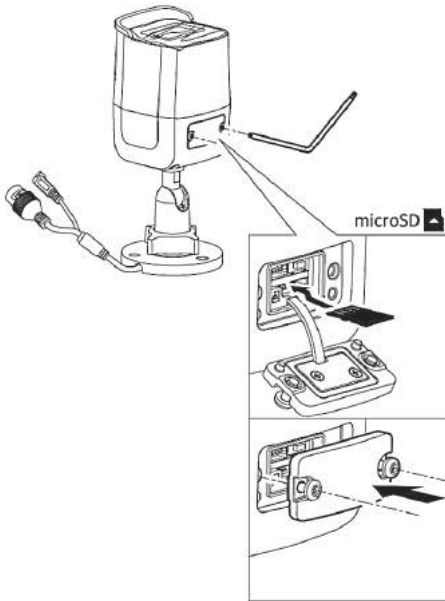

1.2

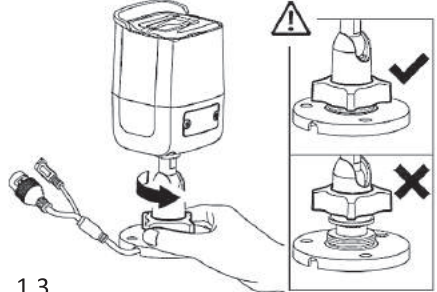

1.3

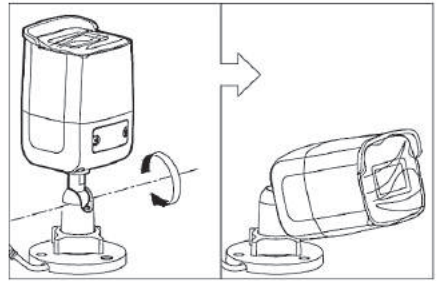

2.1

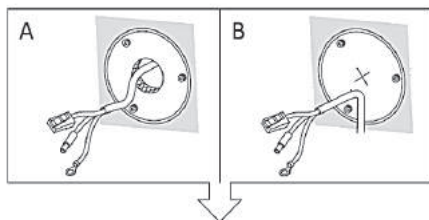
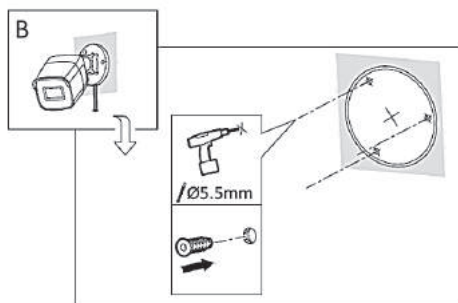
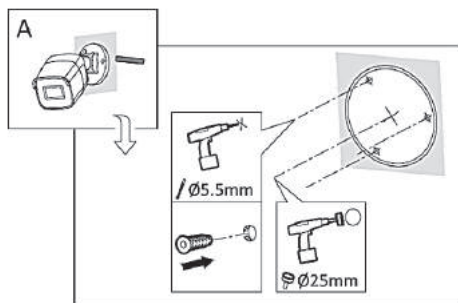

2.2

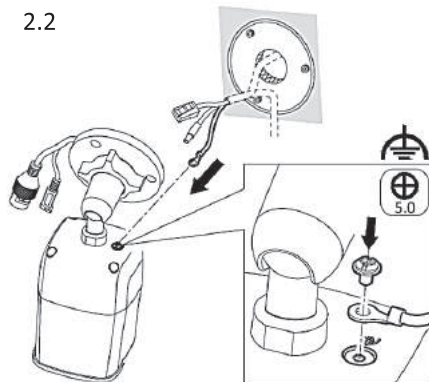

2.3

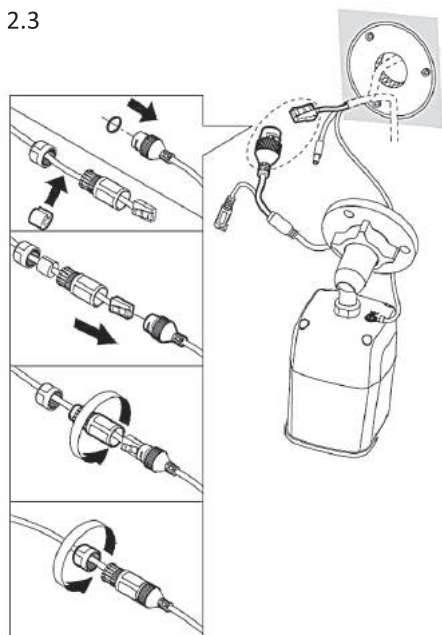

2.4

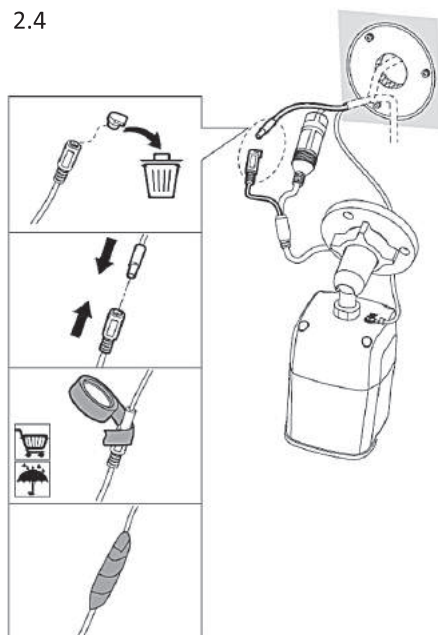

2.5

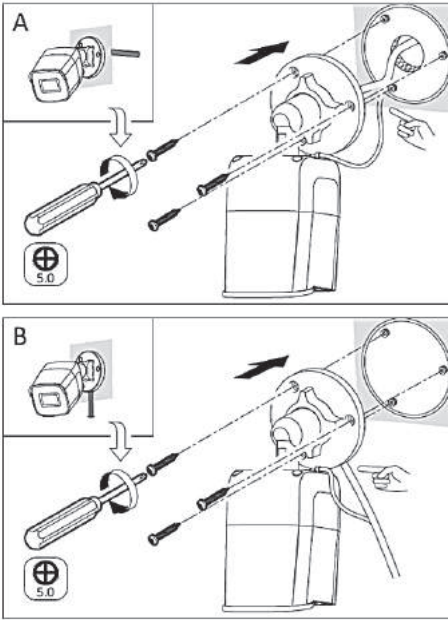

3.1

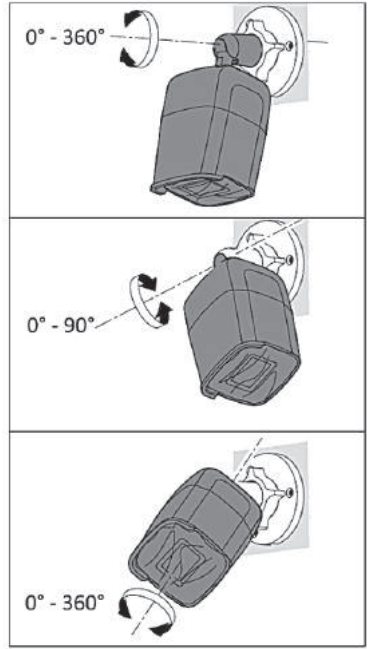

## Waterproof Measures

If the camera is installed outdoor, you should use the waterproof accessory or tapes to waterproof the cables. Otherwise, the cables might get wet or a short circuit occurs.

### 2.1.1 Install Network Cable Waterproof Jacket

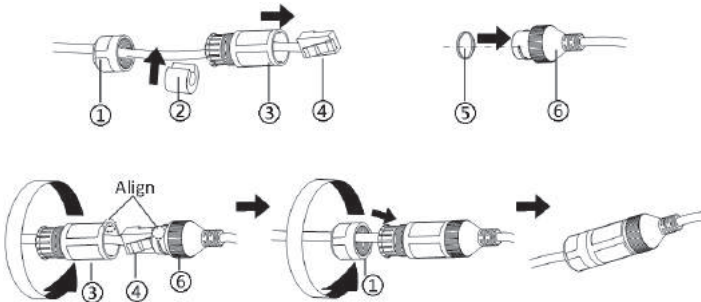

Steps:

1. Feed the network cable through ① and ③ in order.
2. Fix ② on the network cable between ① and ③.
3. Place ⑤ onto the end of ⑥, and plug the RJ45 male connector into RJ45 female connector.
4. Screw ③ to ⑥ clockwise.
5. Push ② into ③.
6. Secure ① with the ③ in clockwise direction.

### 2.1.2 Waterproof Other Cables

After routing and connecting the cables, use the waterproof tapes to wrap up the cables. Connected cables and spare cables both should be wrapped up as the figures below.

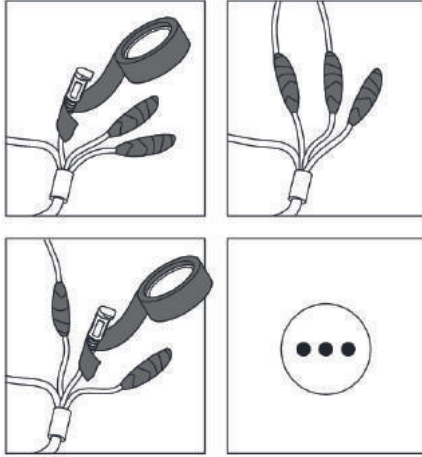

## 3 Star Up Your Device

Proper startup and shutdown procedures are crucial to expanding the life of the NVR. To start your device:

Check the power supply is plugged into an electrical outlet. It is HIGHLY recommended that an Uninterruptible Power Supply (UPS) be used in conjunction with the device. The Power button on the front panel should be red, indicating the device is receiving the power.

After the device starts up, the wizard will guide you through the initial settings, including modifying password, date and time settings, network settings, HDD initializing, and recording.

### 3.1 Activate Your Device

**Password:** Create a New Password for Your Device (8-16 Character, including Caps and Lower-Case Letters and Digits)

**Confirm Password:** Input Your New Password Again

**Camera Activation Password:** Tick off “Use Device Password” as camera activate password

**Reserved Email:** Please input your email address, you can retrieve password by this email, if you forget your device password.

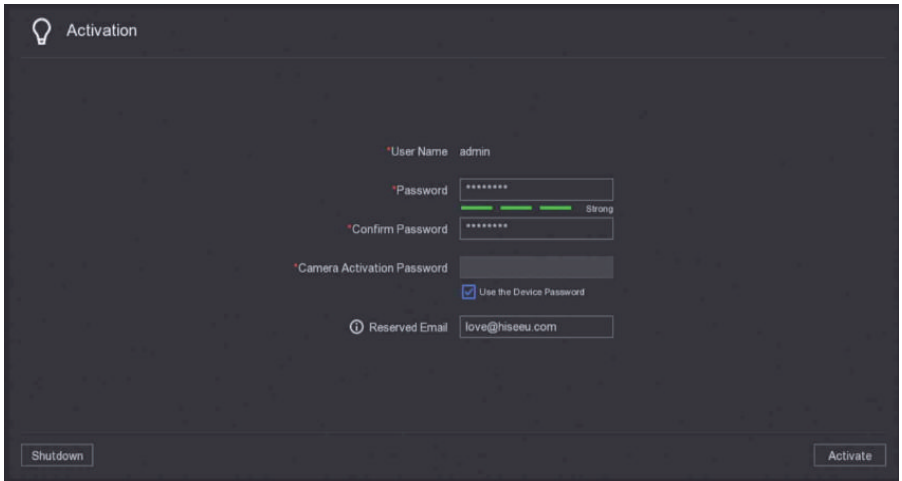

### 3.2 Configure Unlock Pattern for Login

For the admin user, you can configure the unlock pattern for device login.

Step 1: After the device is activated, you can enter the following interface to configure the device unlock pattern.

Step 2: Use the mouse to draw a pattern among the 9 dots on the screen. Release the mouse when the pattern is done

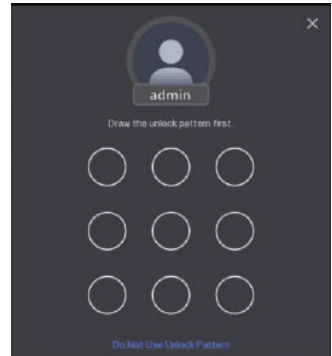

### 3.3 Login to System

Login by Password or Unlock Pattern

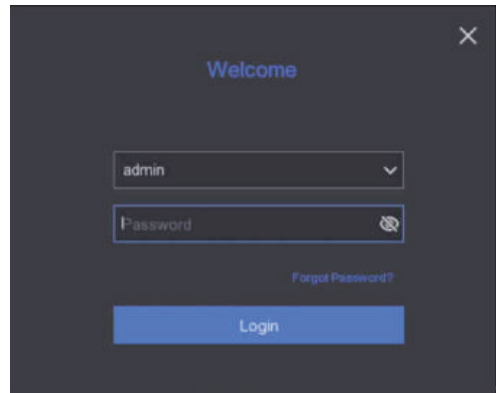
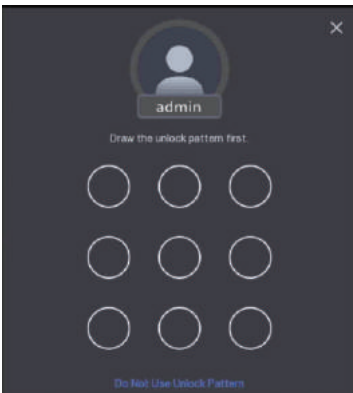



## 4 Enter Wizard to Configure Quick Basic Settings

### 4.1 Time Zone

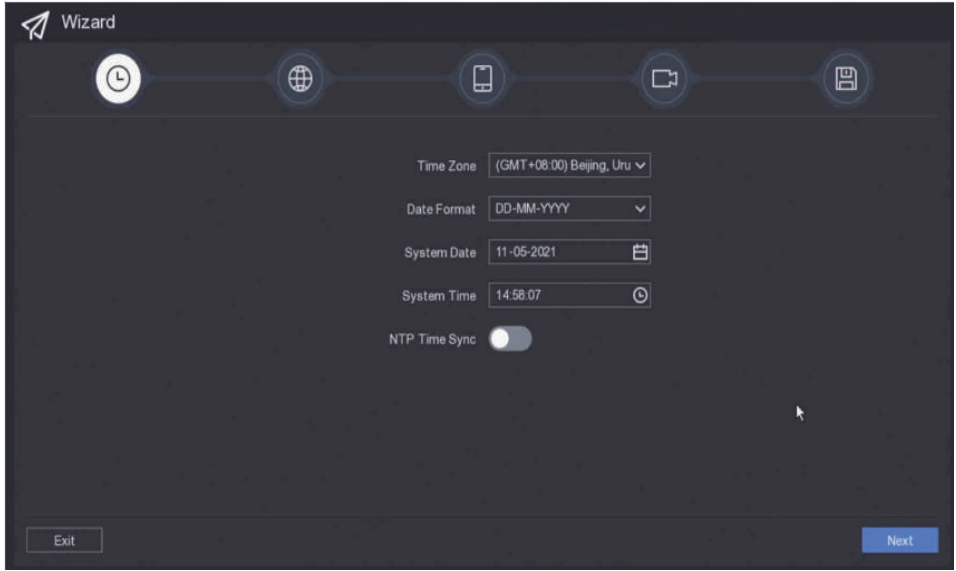

### 4.2 Enable “DHCP”

Please enable “DHCP”, the system will obtain IP address automatically after you connect it to your router via network cable.

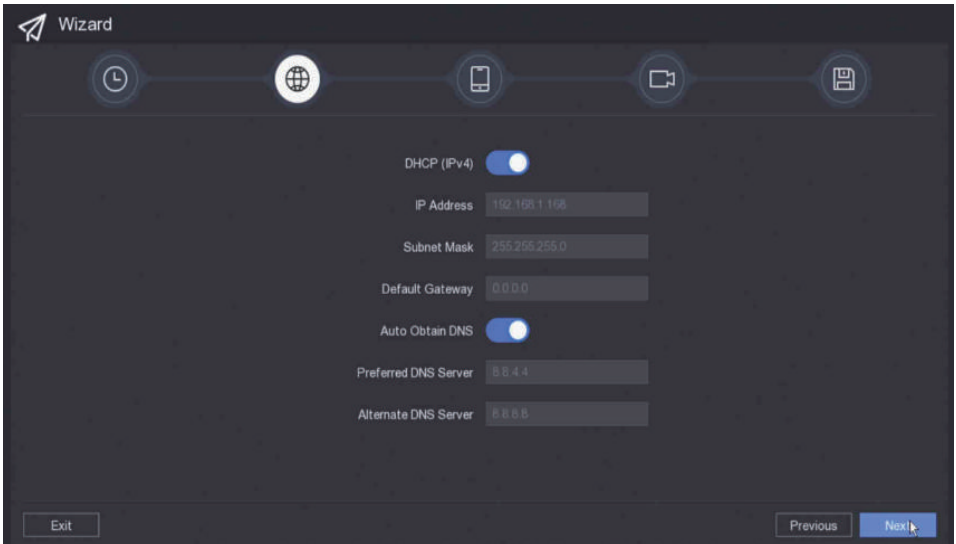

### 4.3 Remote Access Setting

a) If you only need local monitoring, no need to enable it.

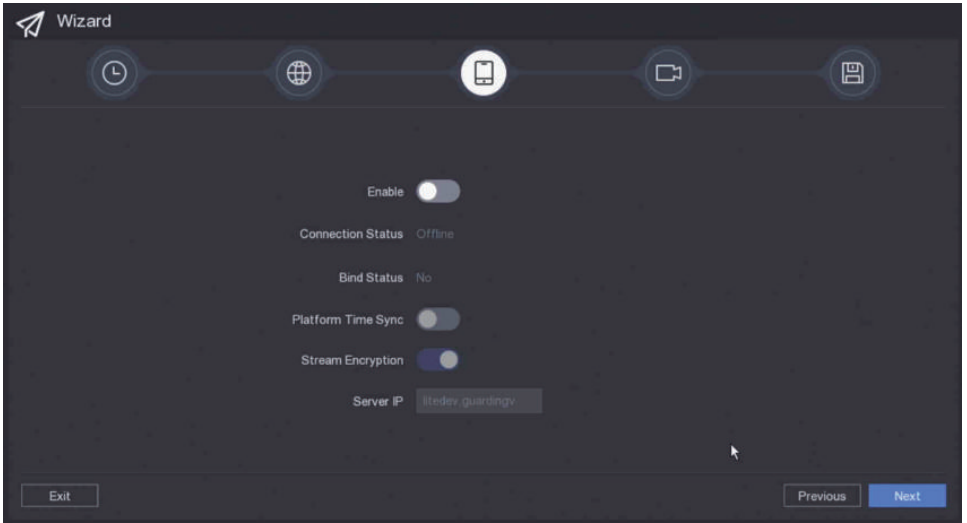

b) If you want to remote access on mobile APP you can enable it.

c) Please tick off the check box and click "OK" to continue. You can scan the QR code to read the service terms.

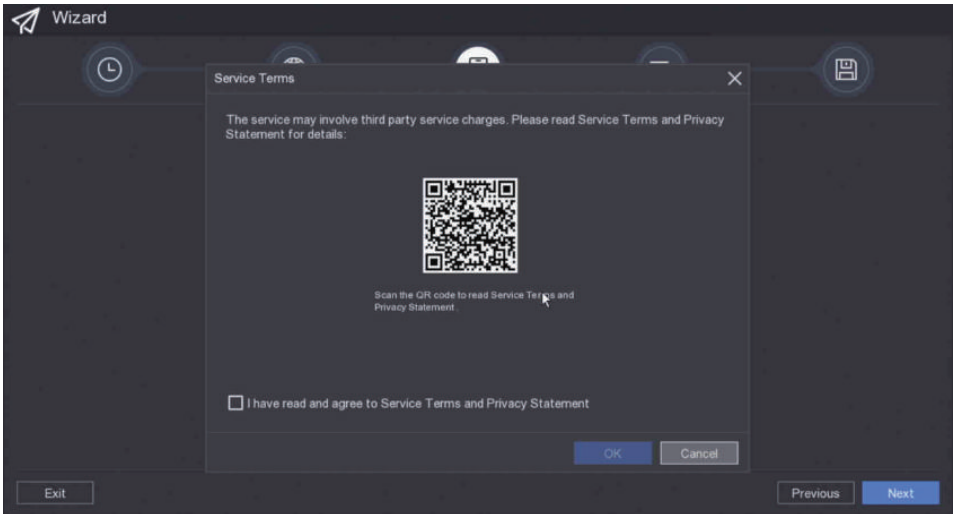

d) Scan the QR code to download mobile APP “Guarding Vision”.  
Please write down the verification code, you will need it when you adding the device to Mobile App or PC Client.

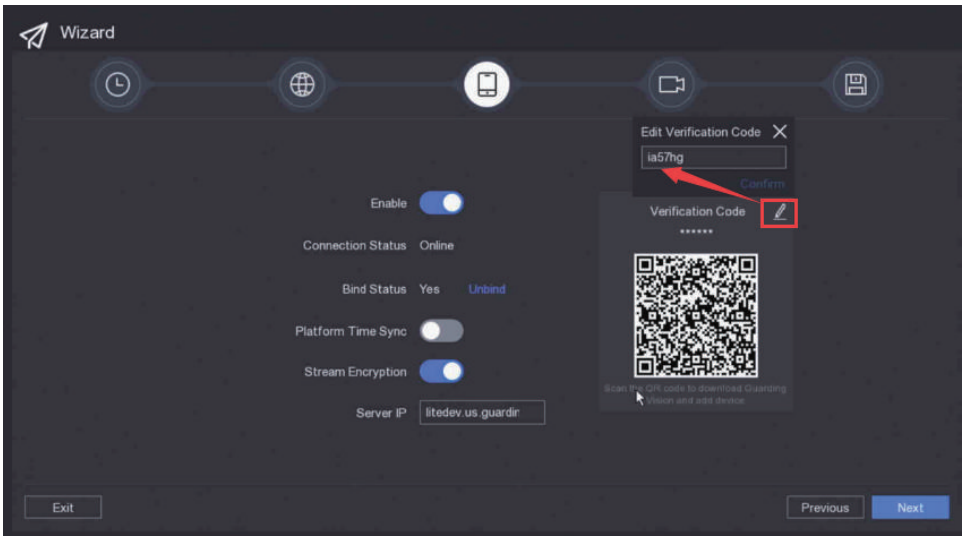

## 4.4 Camera Status

Once you plug the camera to NVR via network cable provided, you will see the camera’s IP address and status.

NVR max can take up to 8 cameras, as for how to add new camera to device, please refer to page 23:

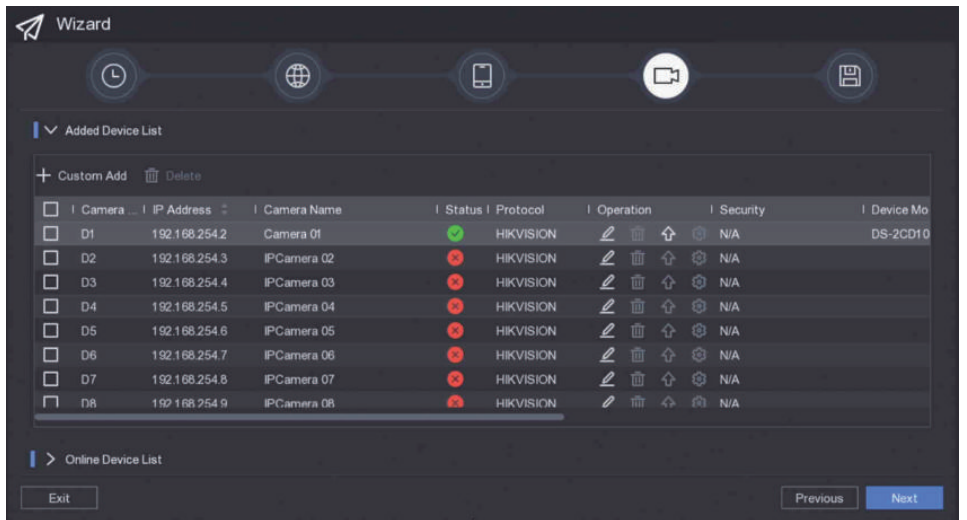

## 4.5 Hard Drive Status

Wizard

Free/Total space: 917.00GB/931.52GB

<input type="checkbox"/>	Label	Status	Type	Capacity	Free Space	Group	Operatic
<input type="checkbox"/>	1	R/W	Local	931.52GB	917.00GB	--	

Exit Previous Finish

## 4.6 Start Live View

NO LINK NO LINK NO LINK NO LINK

## 5 Log Out System

Step 1: Click  on the menu bar, there are 3 options, “Logout” “Shutdown” “Reboot”

Step 2: Click Logout

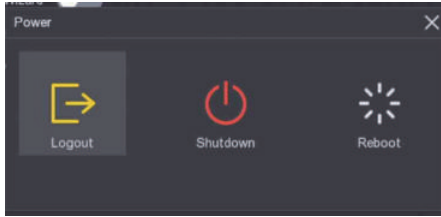

## 6 Main Menu Control Panel Description

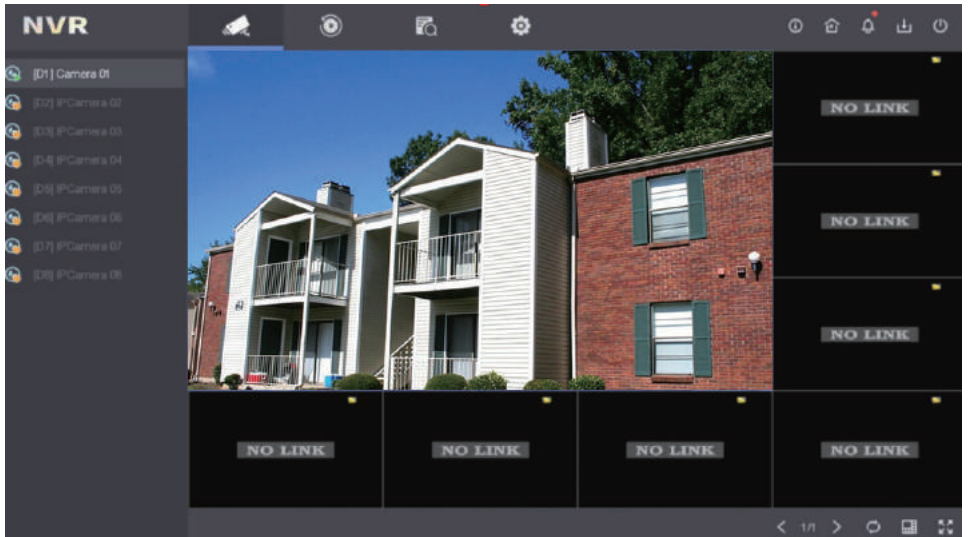

Camera Status



Playback



File Search



System Setting



System Info



Guarding Vision



Alarm Message



Firmware  
Download



Power: Shutdown,  
Reboot, Logout

## 7 Recording Settings

System default setting is for 24/7 loops recording. You also can customize it.

Event Recording

Please Navigate to  → Record → Schedule.

High-light “Event”, left-click and hold your mouse to drag the area which you need for event recording.



The screenshot shows the NVR interface for recording settings. The left sidebar has a menu with 'Record' expanded to 'Schedule'. The main area shows 'Camera No.' as '[D1] Camera 01' and 'Enable' as a checked toggle. Below this is a recording schedule grid with columns for hours (0-24) and rows for days (Mon-Sun). A red bar highlights the 'Event' recording mode, and a blue bar highlights the 'Continuous' mode. The grid shows red bars for event recording from 0 to 16 hours on all days. There are 'Apply' and 'Copy to' buttons at the bottom.

## 8 Motion Detection

Click  and navigate to Camera → Event → Enable.

You can customize the alarm area and arming time period, sensitivity, etc.

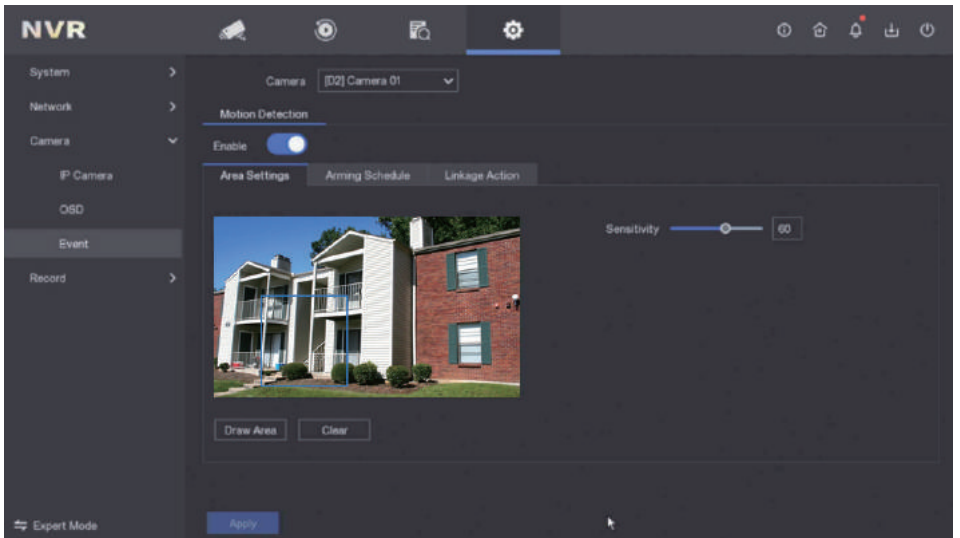

The screenshot shows the NVR interface for motion detection settings. The left sidebar has a menu with 'Event' selected. The main area shows 'Camera' as '[D2] Camera 01' and 'Motion Detection' as a checked toggle. Below this are three tabs: 'Area Settings', 'Arming Schedule', and 'Linkage Action'. The 'Area Settings' tab is active, showing a live video feed of a house. A red box on the video indicates the motion detection area. There are 'Draw Area' and 'Clear' buttons below the video. To the right, a 'Sensitivity' slider is set to 60. There is an 'Apply' button at the bottom.

## 9 Playback

Step 1: Click  on the main menu bar to enter the playback interface.

Step 2: Check the channel(s) in the list and then double click to select a date on the calendar.

Step 3: You can use the toolbar in the bottom part of Playback interface to control playing progress.



Event Playback

High-Light "Event" enter event video playback (The red color indicate event recording).



## 10 Backup

Step 1: Click  icon to enter Search interface

Step 2: Specify detailed conditions, including time, camera, event type, etc.

Step 3: Click **Search** to display results. The matched files will be displayed.

Step 4: Click **Export** to export as **Video and Log** and click **OK**.

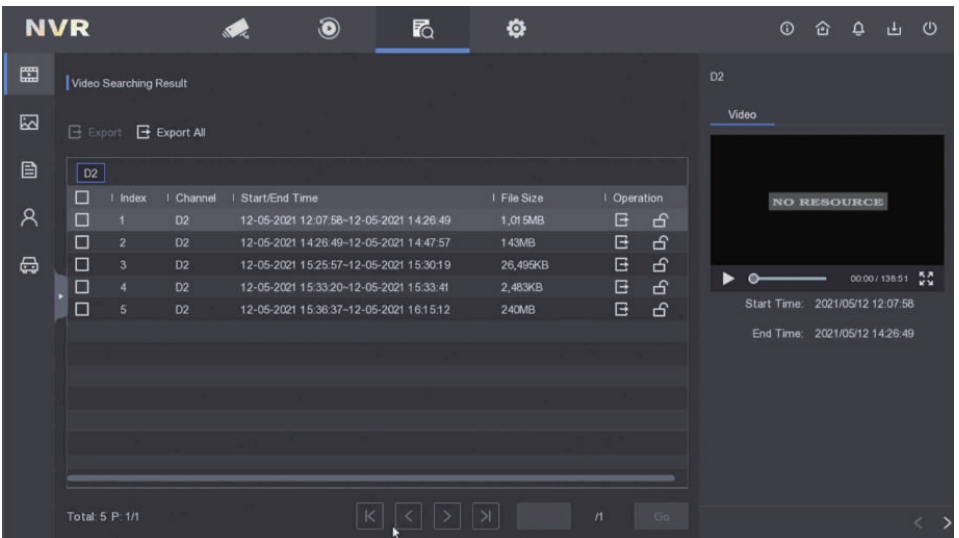
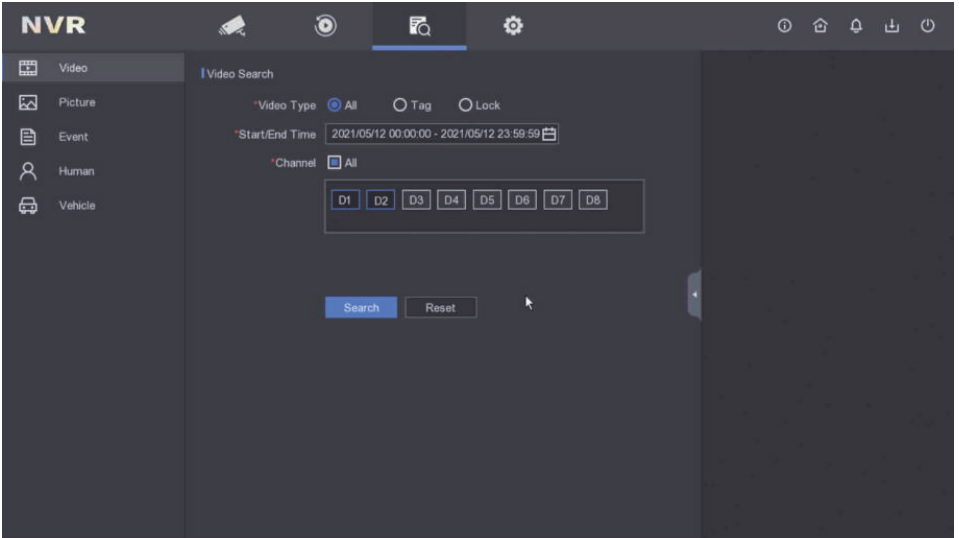



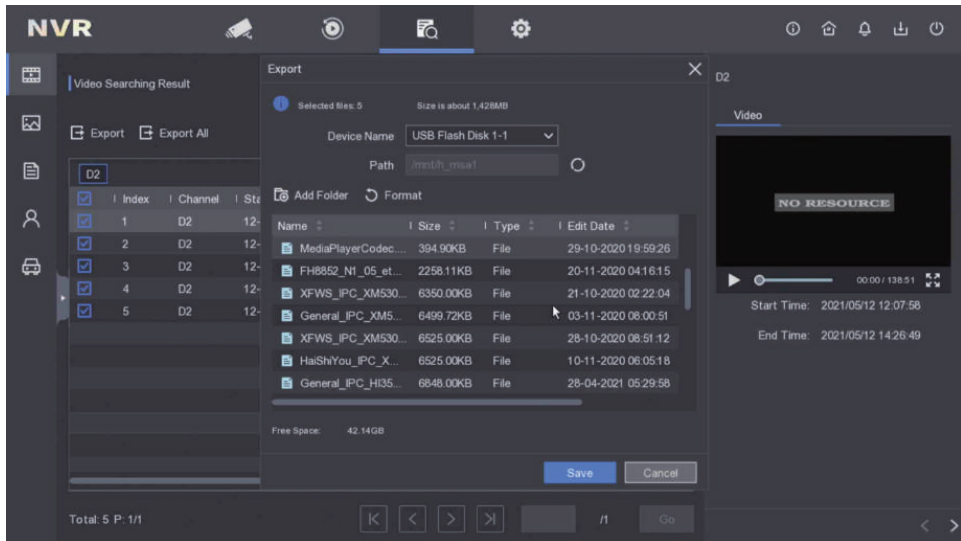

## 11 Remote Access from Mobile APP

Before you start, please make sure your device is online.

Step 1: Click  navigate to **Network**→**Guarding Vision**.

Step 2: Make sure the “Connection Status” is “Online” (①)

Step 3: Hit  icon to display the verification code (②)

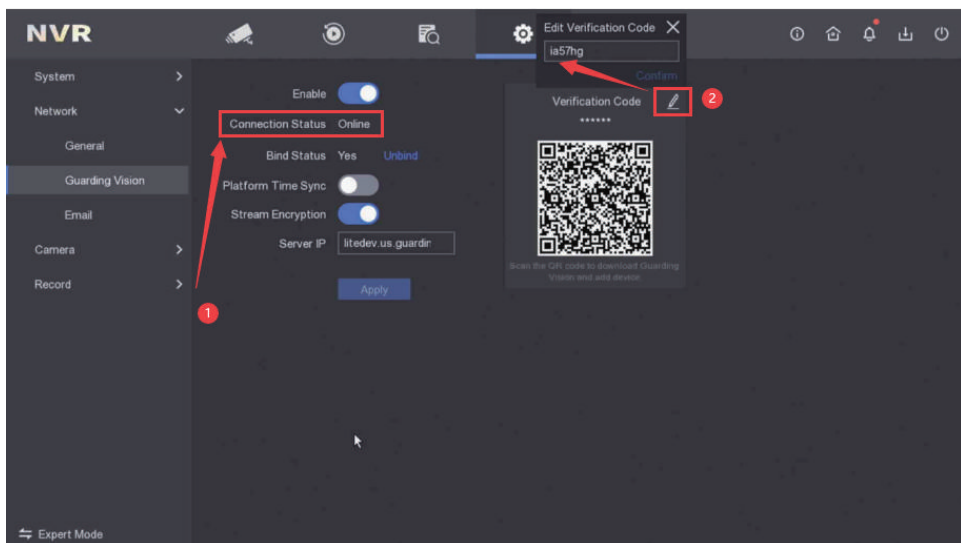

11.1 The Free APP “Guarding Vision” Can be download from “Google Play” or “APP Store”.

Or, click  icon to scan the QR code and download the APP

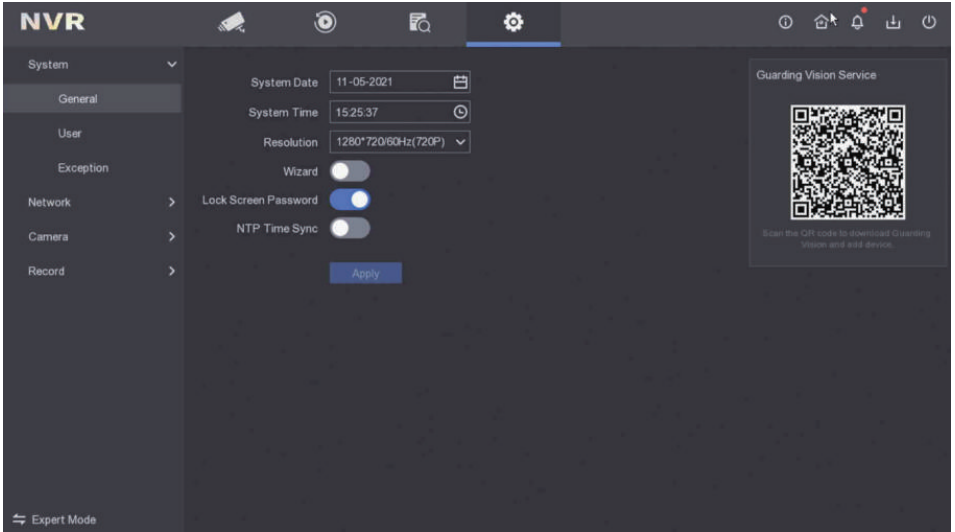

11.2 Open the APP “Guarding Vision” and register an account by Email or Mobile Number.

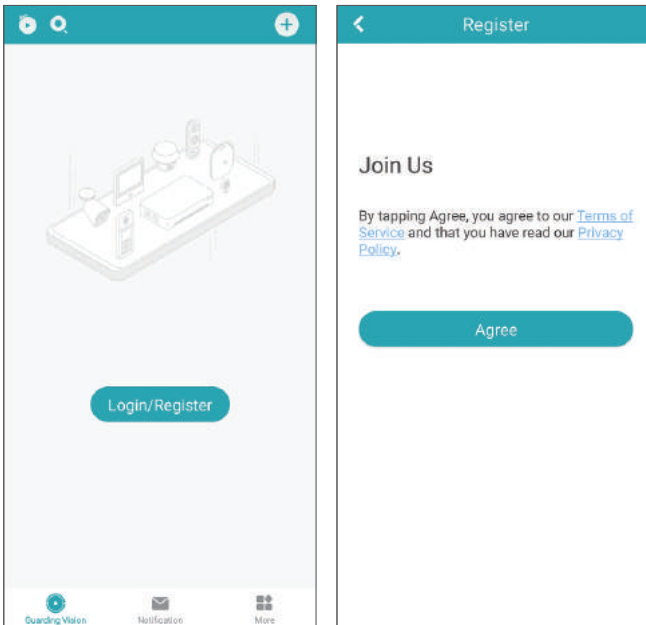

11.3 Input your email address and create new password for your “Guarding Vision” account. Hit “Get Security Code”, and enter the security code you received.

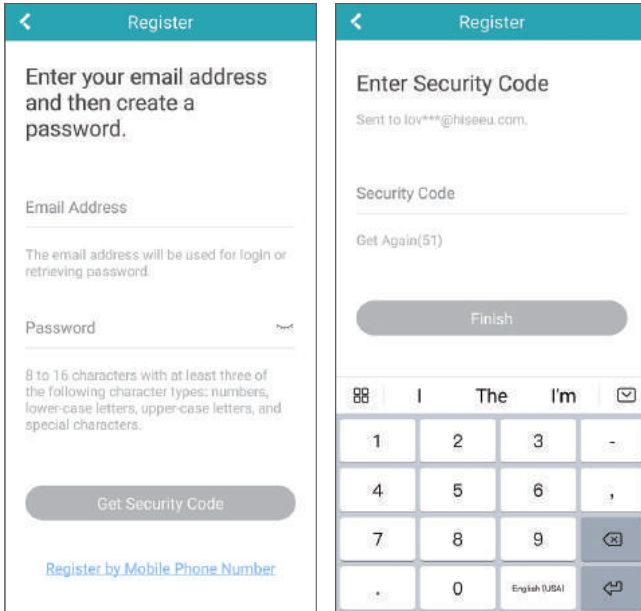

11.4 Add Device by Scan device QR code (Click  →Network→Guarding Vision).

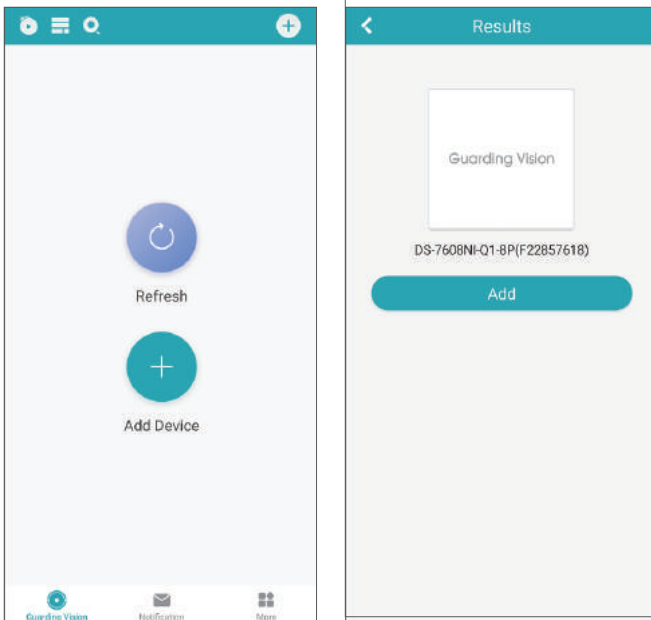

11.5 Hit “Refresh” if “My Device” didn’t update. Hit “More” To Display All Cameras  
The “Encryption password” is the “verification code”.(refer to page 19, step3)

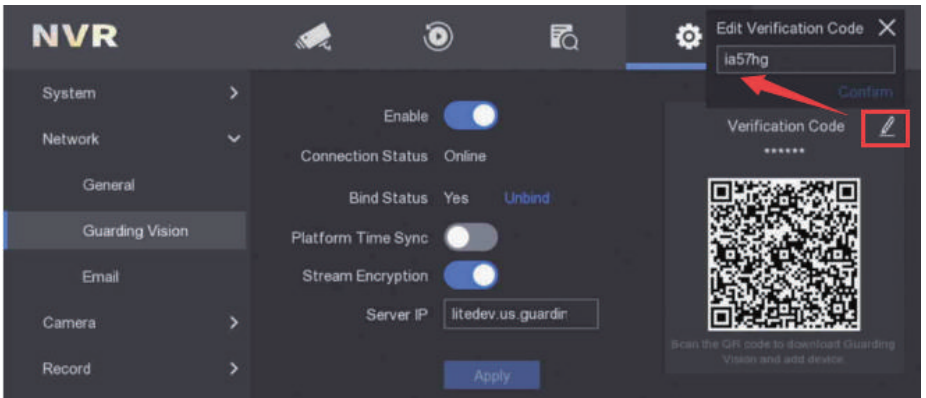
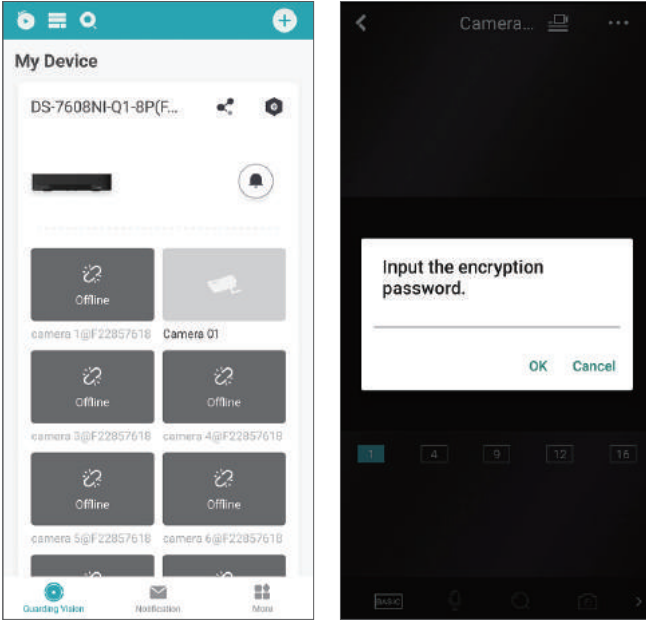

## 12 Retrieve Password

1. Click “Forget Pattern” → “Forget Password” → “Verify by Guarding Vision” or “Verify by Email”.

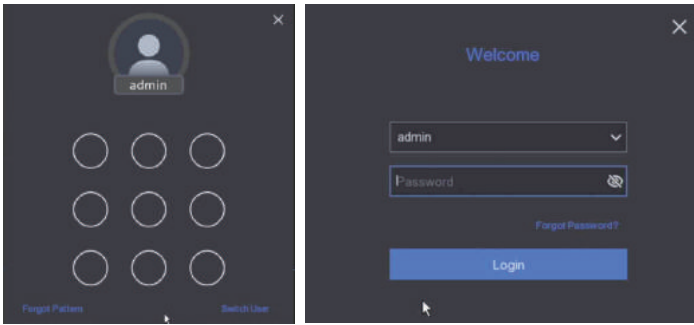

2. Follow the onscreen instruction to scan the QR code and enter verification code.

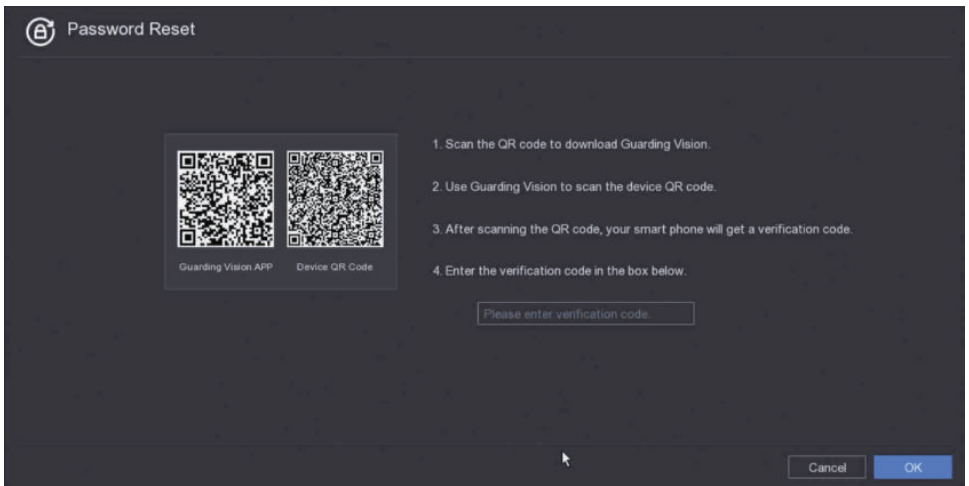

## 13 Add New Camera

[Add a new camera from Hiseeu or add a replacement camera.](#)

Hiseeu original camera is plug-play, connected via the private protocol(HIKVISION). Any questions during configuration, please feel free to contact us at [Love@hiseeu.com](mailto:Love@hiseeu.com)(917 688 2228)

[Add extra camera from third-party.](#)

Before you start.

1. Please make sure the camera is PoE(Power over Ethernet) supported and powered on properly.

2. Please make sure the camera is ONVIF compatible.

Step 1. Click  on the unadded channel

Step 2. "Adding Method" select "Manual Add"

Step 3. "Protocol": Please find your camera's brand name, if unsure, please select "ONVIF"

Step 4. Input your camera's password(Not NVR password)  
Step 5. Click "OK" and wait for the result.

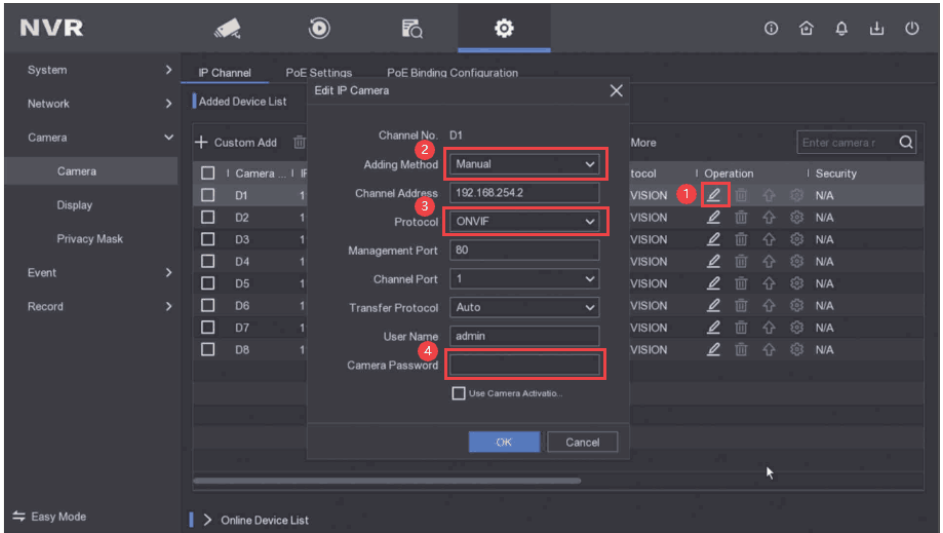

if connect failed, please click  to see the error message.

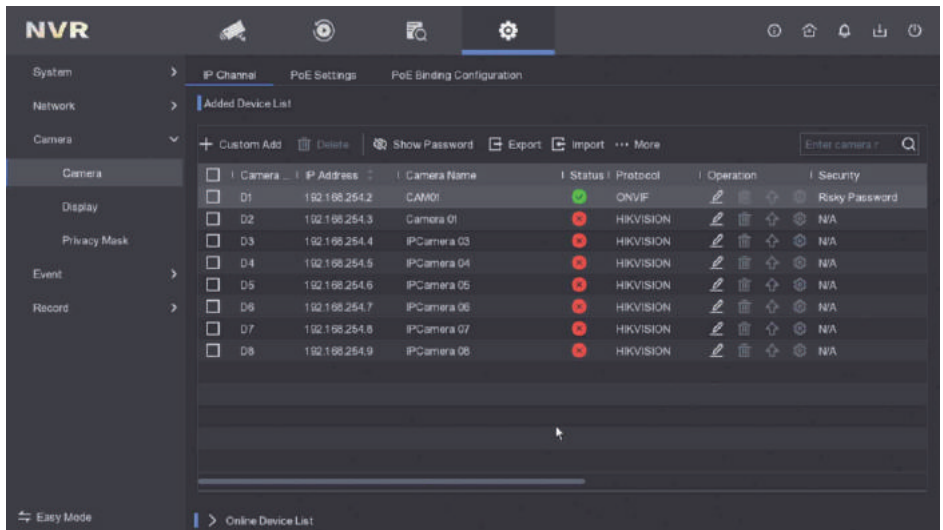

## 14 Live View On PC Client

PC Client name is "Guarding Vision" also, please contact customer service for download link and detailed instruction.

## 14.1 Create A Super User First

Create your login user name and password.



Welcome English

Please create a super user first.

Love

Strong

Auto-Login

Log In

## 14.2 Password Protection

Select the question and input answer.



← Password Protection

Please set the security questions.

Please select the question. 1

Enter the answer of question 1.

Please select the question. 2

Enter the answer of question 2.

Please select the question. 3

Enter the answer of question 3.

Log In

## 14.3 Home Screen Interface

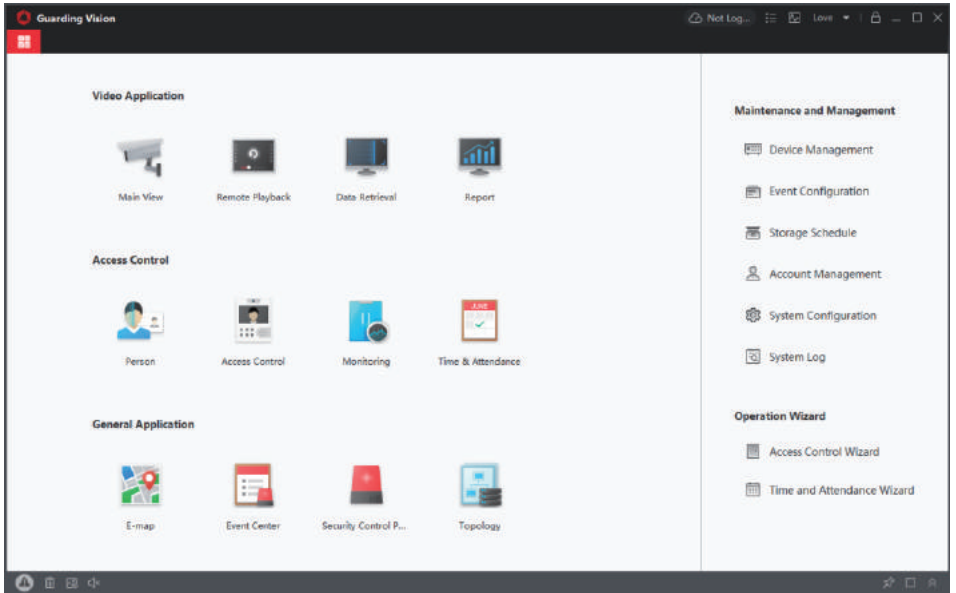

## 14.4 Login with your mobile APP account

14.4.1 In the upper tools bar, click “Not Login” -->”OK”

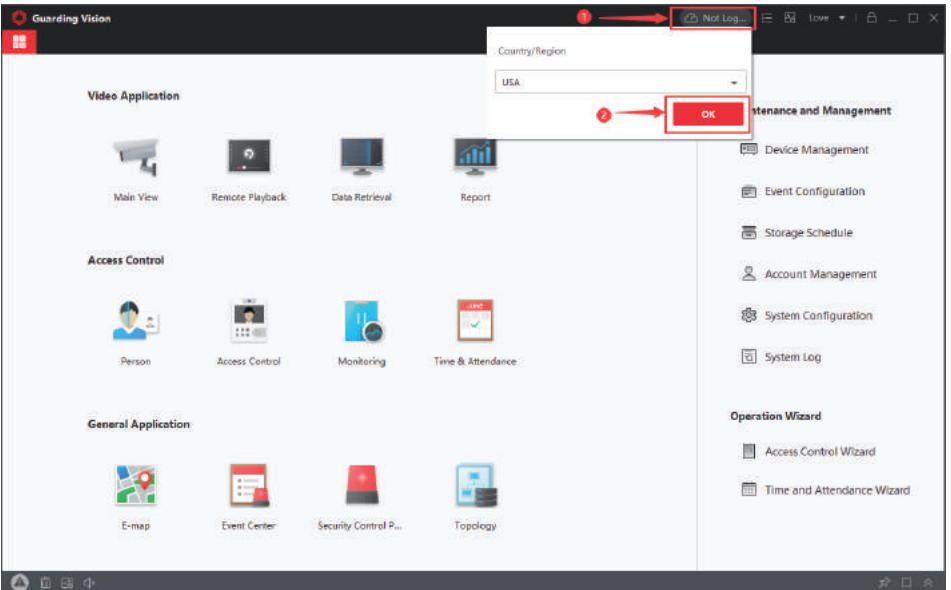



#### 14.4.2 Input the account you created in 11.2. (Page 20)

User name is your email address registered; you also can navigate to the mobile APP “Guarding Vision” → “More” → “Account” to get the user name ID.

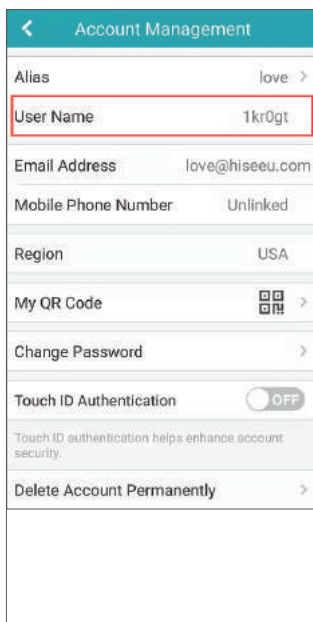
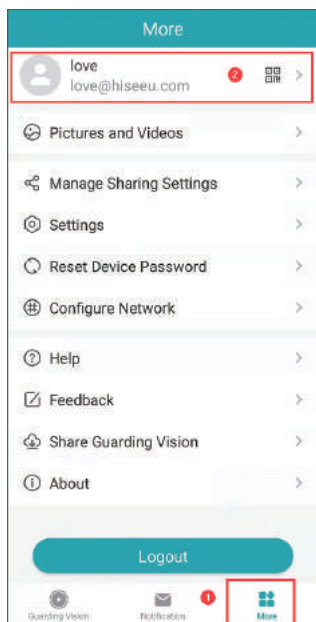
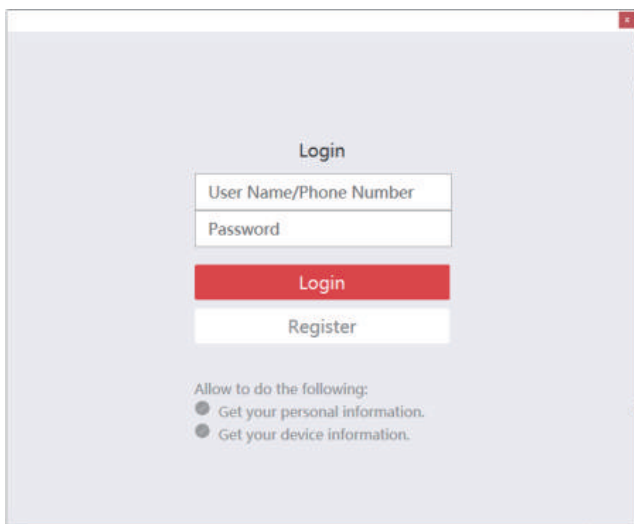

## 14.4.2 Enter Main View

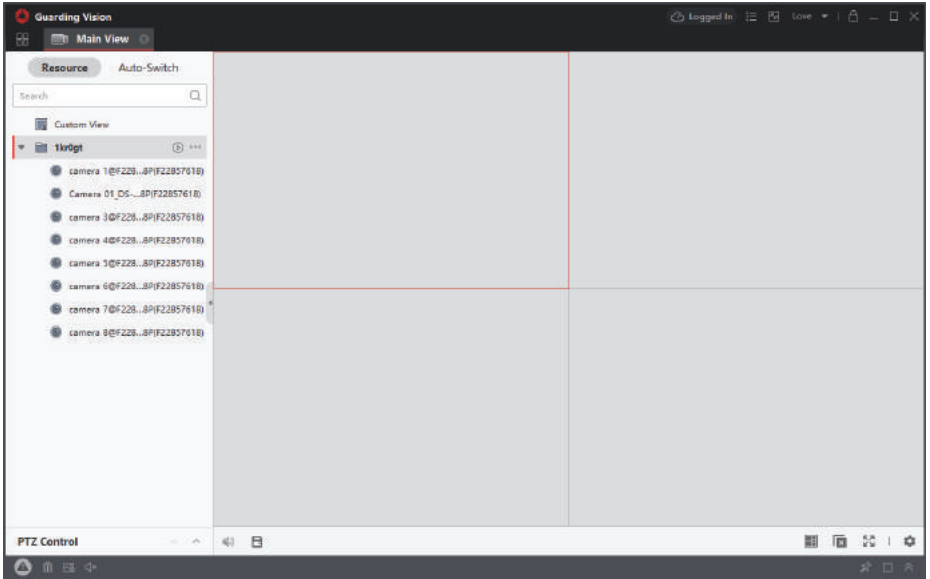

You will see the video Resource on your account. But the video will not display automatically, need to enter the verification code. (refer to page 19)  
Click "Stream Key" Input the Verification code for each camera for live view.

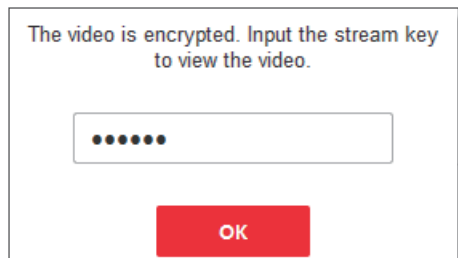
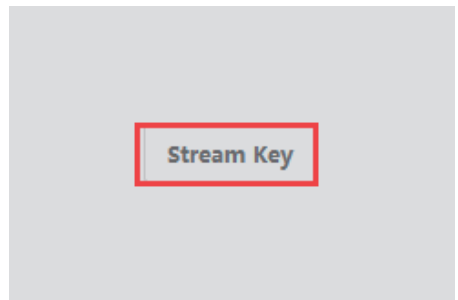
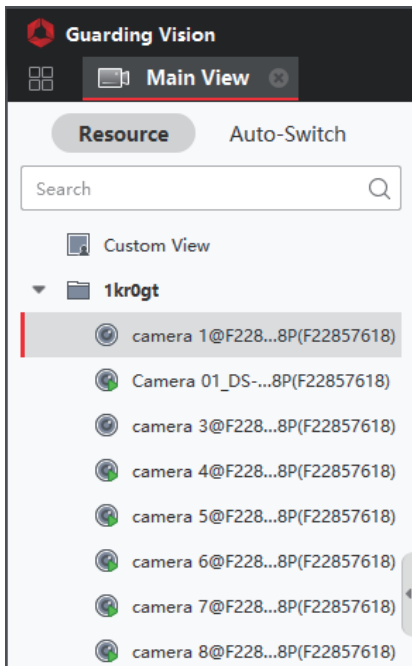

(Click  →Guarding→Verification Code)

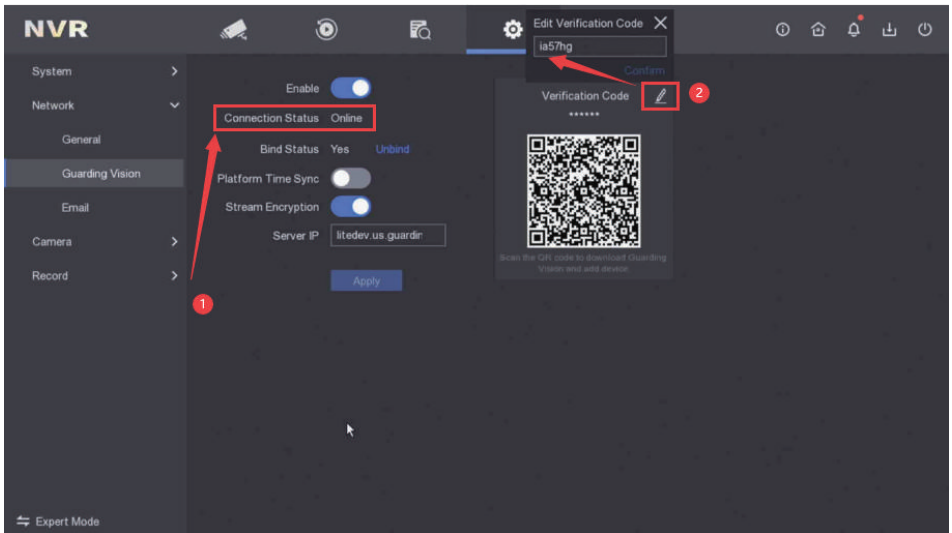

## 15 Troubleshooting

Any Questions During Operating Our Products, Please Feel Free to Contact Us at [Love@hisee.com](mailto:Love@hisee.com). (917 688 2228)

● No image displayed on the monitor after starting up normally.

Possible Reasons:

No VGA or HDMI connections.

Connection cable is damaged.

Input mode of the monitor is incorrect.

Step 1. Verify the device is connected with the monitor via HDMI or VGA cable.

Step 2. If not, please connect the device with the monitor and reboot.

Step 3. Verify the connection cable is good.

Step 4. If there is still no image display on the monitor after rebooting, please check if the connection cable is good, and change a cable to connect again.

Step 5. Verify Input mode of the monitor is correct.

Step 6. Please check the input mode of the monitor matches with the output mode of the device (e.g. if the output mode of device is HDMI output, then the input mode of monitor must be the HDMI input). And if not, please modify the input mode of monitor.

Step 7. Check if the fault is solved by the step 1 to step 3.

Step 8. If it is solved, finish the process.

If not, please contact the engineer from Hisee to do the further process.

- There is an audible warning sound “Di-Di-Di-DiDi” after a new bought device starts up.  
Possible Reasons:
  - No HDD is installed in the device.
  - The installed HDD has not been initialized.
  - The installed HDD is not compatible with the device or is broken-down.
- For other audible warning, please click  to check the Alarm Information

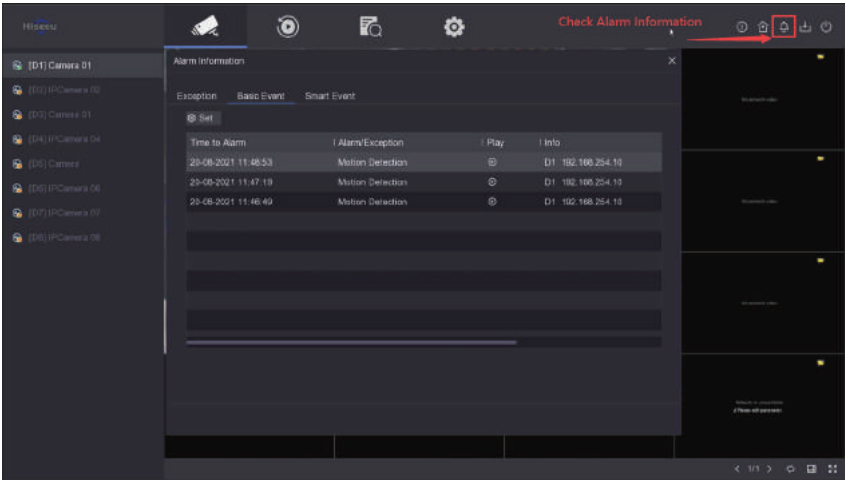

- How to restore the system?

Please click  to restore the system

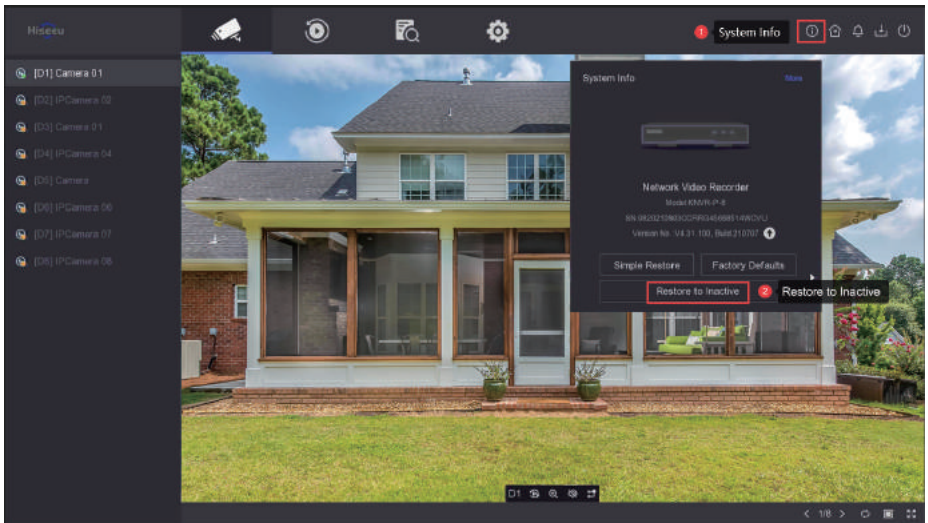

Simple Restore, Factory Defaults, **Restore to Inactive**.

**Restore to Inactive:** It will erase your personal information (footage, email, etc.)



Any Questions During Operating Our System, Please Feel Free to Contact Us at  
[Love@hiseeu.com](mailto:Love@hiseeu.com) (917 688 2228)