

USER'S GUIDE

Version: FM35-202009M



AIR CURTAINS

Elegant Models: FM-3509-L/Y, FM-3510-L/Y,
FM-3512-L/Y, FM-3515-L/Y, FM-3518-L/Y



STOP and Read! Test before installing

1. Do NOT plug in power cord to power source, check if any loose parts.
2. Plug in 120V power source (some old air curtains might use 240V, verify the power voltage if not sure); press the front switch to H or L to turn on. If the air curtain works normally, refer to section 3 through 7 to install the air curtain. Refer to section 10 for technical support.
3. After installation, if the air curtain doesn't run, first step is to check the magnetic switch. Refer to section 7 for troubleshooting.

Thanks for purchasing this Air Curtain.

PLEASE READ AND SAVE THESE INSTRUCTIONS.

Strongly recommend to test the unit before installation for any defective or damage during shipment.

WARNING – TO REDUCE THE RISK OF FIRE, ELECTRIC SHOCK, OR INJURY TO PERSONS, READ THE FOLLOWING CAREFULLY before attempting to assemble, install, operate or maintain the product.

- A. Always disconnect, lock and tag power source before installing or servicing. Failure to disconnect power source can result in fire, shock or serious injury.**
- B. Installation work and electrical wiring must be done by qualified person(s) in accordance with all applicable codes and standards, including fire-rated construction.**
- C. When cutting or drilling into wall or ceiling, do not damage electrical wiring and other hidden utilities.**
- D. To reduce the risk of fire or electric shock, do not use this fan with any solid-state speed control device**
- E. Repair and maintenance operations can only be performed by qualified personnel.**
- F. Verify and ensure the rated voltage and frequency (please refer to the rating label) of the air curtain is in compliance with the mains supply.**
- G. Make sure the air curtain is securely mounted on the wall; otherwise, the air curtain may fall and injury to persons.**

CONTENTS

1. PRODUCT INTRODUCTIONS.....	1
2. INSTALLATION CAUTIONS.....	2
3. INSTALLATION INSTRUCTIONS.....	3
4. TECHNICAL PARAMETER	4
5. WIRING DIAGRAM	5
6. OPTIONAL MAGNETIC SWITCH INSTALLATION	5
7. TROUBLESHOOTINGS.....	7
8. OPERATING INSTRUCTIONS.....	7
9. MAINTENANCE AND CLEANING.....	8
10. SUPPORT AND CONTACT	8

1. PRODUCT INTRODUCTIONS

Air curtains are widely installed at the entrances of supermarket, theater, meeting room, hotel, office room, storeroom etc. They can reduce penetration of insects, dust, and unconditioned air into a conditioned space by forcing an air stream over the entire entrance to create a comfortable environment for you.

2. INSTALLATION CAUTIONS

Must observe the following when installing air curtains:

Strongly recommend to test the unit before installation for any defective or damage during shipment.

2.1 Please install the unit on a sturdy supporting structure to avoid shaking and ensure its security (because the unit running may cause the wall to become loose or shake and make noise).

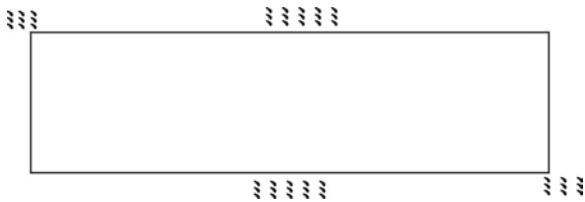

2.2 Please install the unit inside the room. Require 2 inches clearance to the ceiling.

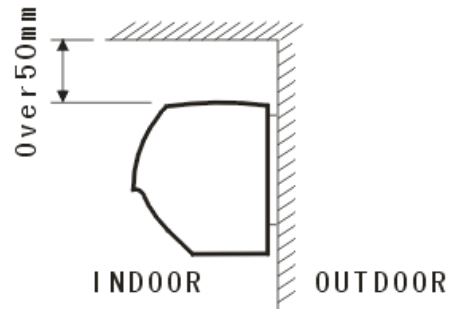

2.3 Install the unit between 7 feet to 7.5 feet from the ground.

ATENCIÓN: Instalar la unidad entre los 7 a 7.5 pies desde del suelo.

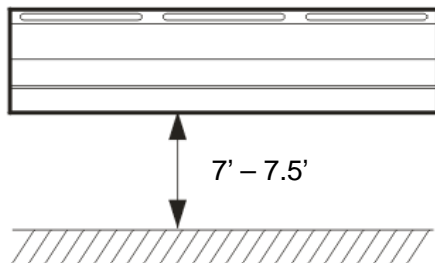

2.4 When the entrance is wider than the unit, it is recommended to install two or more units in parallel. In this case, provide 3/4" to 1-1/2" gaps between the units.

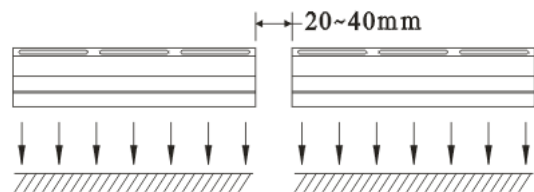

2.5 Don't allow gaps between the unit and the wall.

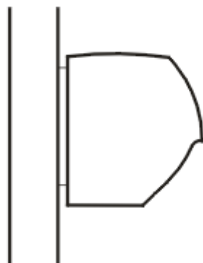

2.6 Don't install the unit at a place where it is splashed by water, exposed to excessive steam, explosive gas or corrosive gas.

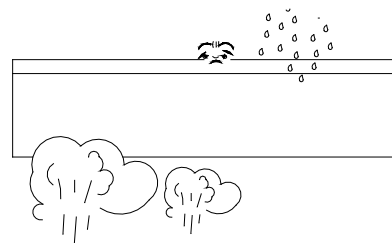

3. INSTALLATION INSTRUCTIONS

A. Installing on the concrete wall:

3.1.1 Unscrew the fixing screws to remove the mounting plate from the back of the main body.

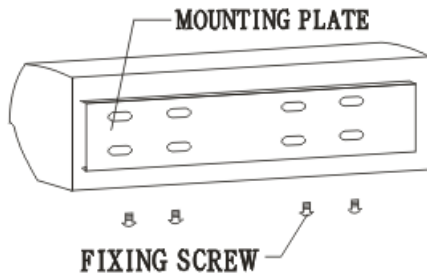

3.1.2 Determine the mounting location with the mounting plate. Drill holes and insert the **Zinc-Plated Steel Hex-Nut-Head Sleeve Anchor** (not included).

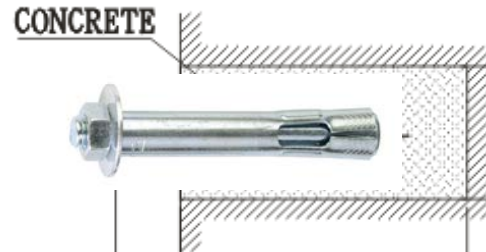

3.1.3 Tighten the nuts to secure the mounting plate to the wall (use the washers and nuts as the Fig shows).

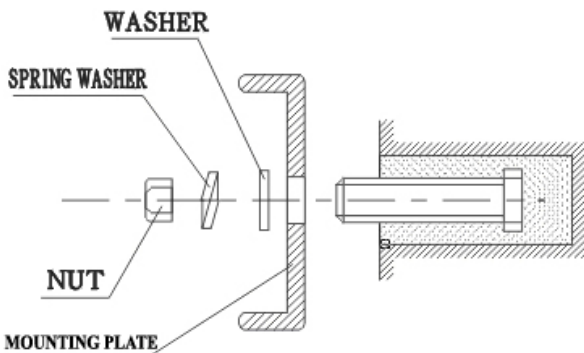

3.1.4 Hang the main body onto the upper end of the mounting plate, and then tighten the bottom fixing screws back to the mounting plate.

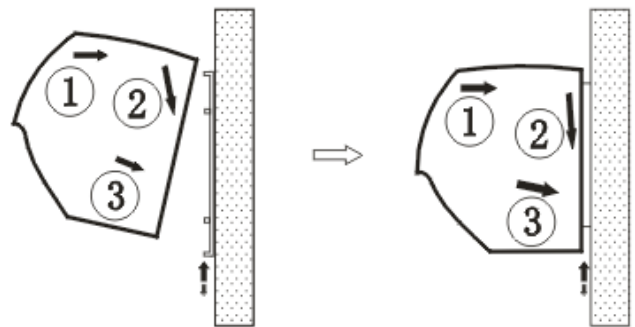

B. Installing on the wooden wall: **(Note: Make sure the screws are secured in the wood studs, drill holes on mounting plate to align to the wood studs, and attach an extra wood frame to the wall if needed.)**



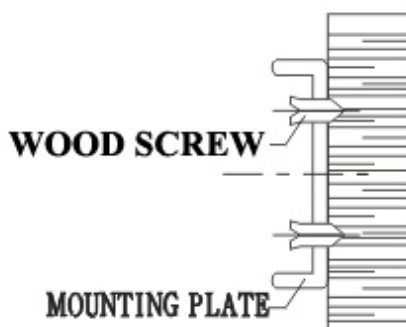

3.2.1 Refer to step 3.1.1 and determine the mounting location, use a stud finder if needed, and then mount the mounting plate to the wood studs securely with tapping screws.

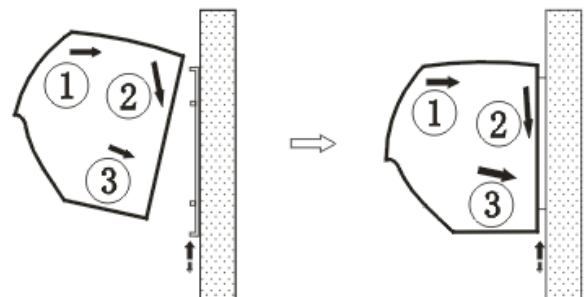

3.2.2 Hang the main body onto the upper end of the mounting plate, and then tie the bottom fixing screws back to the mounting plate.



C. Ceiling mount or side mount: **(Note: The mounting brackets are available to purchase.)**

<p>3.3.1 Ceiling mount - mount the threaded rods securely to the studs in the ceiling.</p> 	<p>3.3.2 Securely mount the mounting brackets and the mounting plate.</p> 
<p>3.3.3 Side mount – mount to the top door frame securely.</p> 	<p>3.3.4 Securely mount the mounting brackets and the mounting plate.</p> 

Note: The air curtain should be installed indoors, should not have moisture, water, rain, or snow reachable. Consult with your electrical professional for 120V electrical hard wiring.

WARNING: Make sure the air curtain is securely mounted on the wall; otherwise, the air curtain may fall and injury to persons.

4. TECHNICAL PARAMETER

Model No.	Max entry opening (Inch)	Voltage (V~Hz)	Power (W)	Max Current (A)	Max air velocity (FPM)	Air volume (CFM)		Noise level (dB)		Net weight (Lb)
						H	L	H	L	
FM-3509-L/Y	38	120V, 60Hz	300	3.13	3150 (H), 2559 (L)	907	742	52	49	28.7
FM-3510-L/Y	44		320	3.33		989	824	52	49	30.9
FM-3512-L/Y	50		400	4.17		1236	989	53	50	34.2
FM-3515-L/Y	62		500	5.21		1566	1236	55	52	44.1
FM-3518-L/Y	74		600	6.25		1878	1482	55	52	51.8

Note: ETL certified models have 1 speed only, which is the High speed. The data are subjected to change without notice due to product development.

5. WIRING DIAGRAM

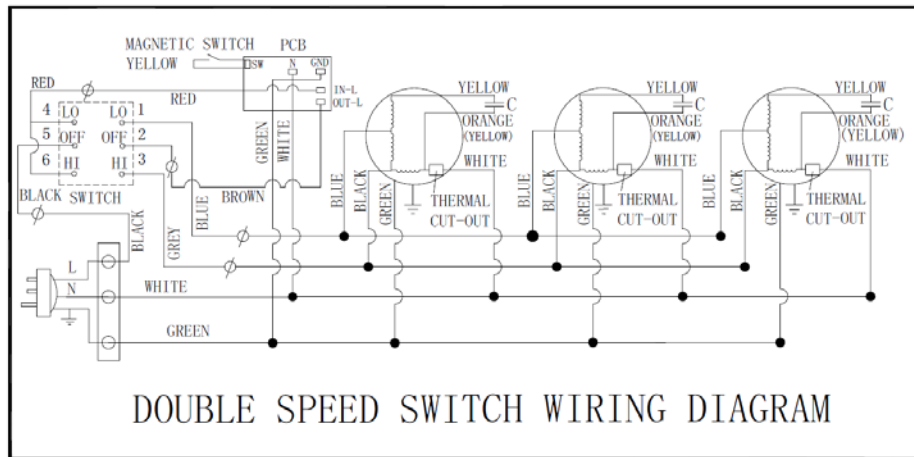

6. OPTIONAL MAGNETIC SWITCH INSTALLATION

This air curtain comes with a magnetic door switch, contact seller or Awoco if you are missing a magnetic switch. The dedicated 2 wires (Yellow) are to connect to the magnetic switch. Note: Keep the 2 wires connected (closed) if the magnetic switch is not used.

Connect the magnetic door switch:

Cut the nut off the 2 yellow wires, and connect the 2 yellow wires to the magnetic switch one by one. Use the black electrical tape to seal the connection. Don't place the magnetic switch close to existing alarm sensors.



Awoco Magnetic Switch Controlled Air Curtains Magnetic Switch Connection Instruction

Step 1: Cut the connection nut off the dedicated 2 wires for the magnetic switch

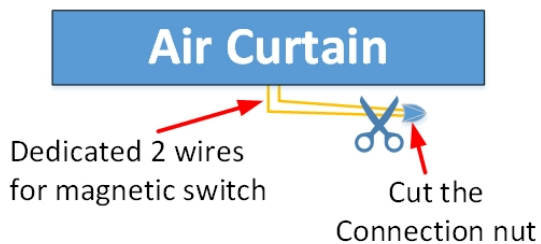

Step 2: Connect the wires one-to-one to the magnetic switch, either side is OK

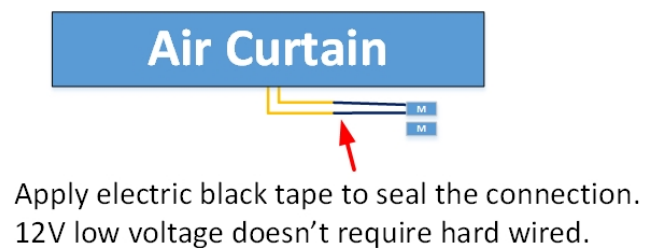

Step 3: Place the 2-piece magnetic switch closely on the door frame and panel.

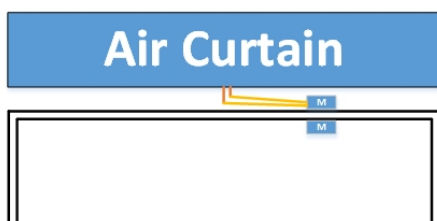

Place them on the door's middle top, side, etc. Test to find the perfect position to place the magnetic switch. If not on the same surface, raise one piece with a small piece of wood.

For double doors, connect the 2 wires to both magnetic switches one-to-one in parallel.



1 air curtain comes with 1 set of magnetic switch for 1 door only. If you have double doors, please purchase an extra magnetic switch (Model no. MAG-SW)

Mount the 2 pieces magnetic switch to the door/window edge and frame; keep them close when the door/window is closed. If needed, apply a metal "Z" bracket to raise the magnet to the same position. **Note: Do NOT use big screws!!! Oversized screws will damage the magnetic switch internally.**

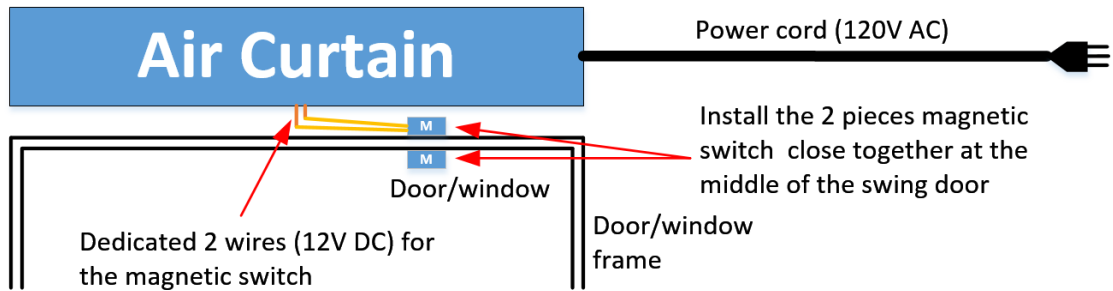

Easy Magnetic Switch Installation

- Easily apply to any kinds of swing or sliding doors and windows.
- 12VDC is safer and no hard wired required. No mechanical contact.
- It works even the door closer is not working well, just install closer to the door hinges.

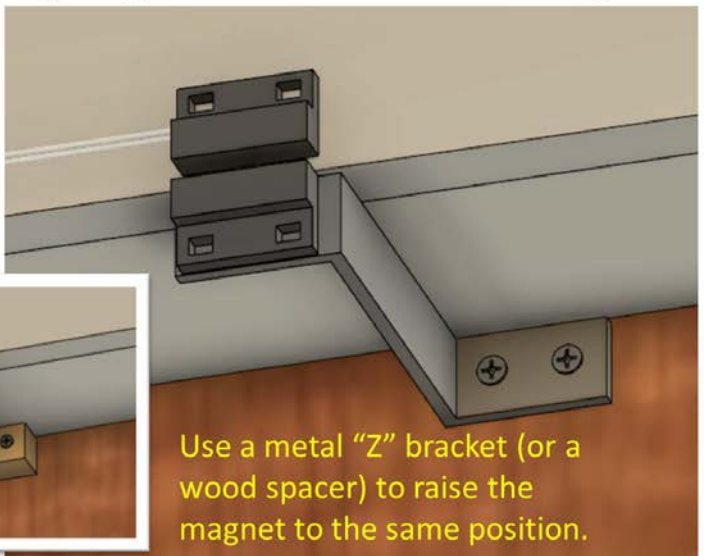
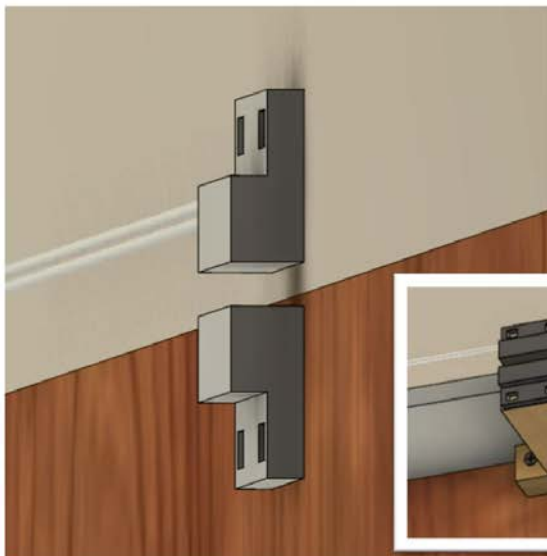

Note: Don't place the magnetic switch close to existing alarm sensors. The existing alarm sensor magnet will interfere with this magnetic door sensor.

7. TROUBLESHOOTINGS

Failure symptom	Possible causes	Troubleshoot and solution
Fan blower is broken	Damaged during shipment	If the fan blower is broken and your purchase is from an authorized seller, contact Awoco to get a fan wheel replacement.
Fan blower is stuck or generates strange noise	The fan blower is damaged during shipment	Contact Awoco for instruction on changing the fan blowers.
The magnetic switch isn't function correctly sometimes.	The magnetic switch is defective or close to an alarm sensor	Don't place the magnetic switch close to an alarm sensor. The alarm sensor magnet will interfere with it. Remove the magnetic switch connection and test if the magnetic switch is defective.
The air curtain doesn't turn on. (Make sure your power outlet is 120V before plugging in. Some old air curtains might use 240V)	The magnetic switch is defective or loosen connection	<u>Remove the magnetic switch connection, directly connect the 2 yellow wires together then test the air curtain.</u> 80% of the failure is due to the magnetic switch setup. Don't use oversize screws, and make sure the connection is secure.
	Check if the front switch is function	After a long period of time, the L/Off/H (or On/Off) switch might be burnt out. Please test the switch.
	Circuit board failure or no power to circuit board	Toggle the magnetic switch and the front switch; hear if "Tic-Tac" sounds from the relay on the circuit board. No sound means no power to motors.
Motor rotates slowly	Startup capacitor is not connected securely or defective	Check if the 2 yellow/orange wires securely connect to the capacitor under the motor. Remove the motor to get access if needed.
After above troubleshoot processes, motor still doesn't turn on	Motor is defective	This chance is very low but it might happen. Use Ohm meter to measure the continuity between motor's black wire and the white wire to check if it is open. Open means defective.

Note: This air curtain requires technique/skills to open the cover to service, and changing the blower requires some special tools. If you are a technician, please contact Awoco technical support for repair instructions. Return/exchange is always the option.

Feel free to contact Awoco technical support at 1-888-412-3428 if you need help. Awoco has all the parts for 1 year limited warranty, including fan wheels, magnetic switches, circuit boards, motors, etc.

8. OPERATING INSTRUCTIONS

8.1 Connect power (120V 60Hz) to the unit.

8.2 Press the switch to the left or right to turn on the unit. [L] - Low speed, [H] - High speed.

8.3 Adjust the air deflector to slightly outward at about 10 to 15 degrees to obtain optimum effect.

9. MAINTENANCE AND CLEANING

WARNING:

- A. Any service is to be performed only by qualified personnel who are familiar with local codes and regulations and are experienced with this type of product.
- B. Always unplug or disconnect the appliance from the power supply before servicing or cleaning the unit.
- C. Never use petrol, benzene, thinners or any other such chemicals for cleaning the unit.
- D. Don't allow water or any liquid to enter the motor.

9.1. Use the unit at the rated voltage and frequency indicated on the rating label.

9.2. Disconnect power source before unit installation or maintenance service.

9.3. Routine maintenance must be done every year.

9.4. Plastic parts should be cleaned with mild soap water, thoroughly remove soap film with a clean damp cloth.

9.5. Wipe the exterior surfaces of the fan with a moistened cloth with a solution of mild detergent and water.

9.6. Dry the case with a soft dry cloth before operating the unit.

10. SUPPORT AND CONTACT

Contact your local seller for exchange or repair.

Visit www.awoco.com for most updated information.

Email to sales@awoco.com or call 1-888-412-3428 for technical support and sales activity.