



VIDEO INSTRUCTIONS

15099

Pin & Bushing Starter Kit

Without Hydraulic Cylinder

// Safety Warning

Read all instructions and safety warnings prior to operation.

Failure to do so could result in equipment damage, personal injury, or even death.

CAUTION: Use replacement parts and accessories provided by Tiger Tool only. All replacement parts and accessories are available. Where applicable, keep hydraulic coupler protected when not in use. Dust caps should be used on couplers when not in use to avoid contaminants from entering the hydraulic cylinder and power source. This practice will help extend the life of this product and ensure continued consistent operation.

- Stay Alert! Watch what you are doing and use common sense when operating this tool.
- Inspect product for damage prior to using; do not use if product is in unsafe condition.
- Do not operate tool while under the influence of drugs, alcohol, or medication.
- Always use safety equipment to prevent injuries. Approved face and eye protection must always be worn by the operator, as well as others in the work area.
- Do not overreach. Keep proper footing and balance at all times.
- Dress properly. Do not wear loose clothing or jewelry.
- Keep your hair, clothing and gloves away from moving parts.
- Keep hands clear of all pressurized hydraulic components.
- Always ensure hoses are free from sharp bends and kinks.
- Keep your work area clean and well lit.
- Cylinders are designed for 10,000 psi (700 bar) maximum working pressure. Do not connect to a pump with a higher rated pressure. Use a pressure gauge in the system at all times. Ensure all components in the system are rated for 10,000 psi (700 bar).

Tiger Tool International Incorporated Warranty and Limit of Liability Terms and Conditions. For more information, visit tigertool.com

Warranties - 1. Tiger Tool International Incorporated ("Tiger Tool") warrants to customers who purchase the tools from Tiger Tool or an authorized dealer of Tiger Tool that cast portions of the tools are free from defects in workmanship and materials at the time of sale and for as long as the original customer owns the tool pursuant to a contract of sale between the customer and Tiger Tool or its authorized dealer. 2. Tiger Tool warrants to its customers that threaded areas, bolts and machined components in or of the tools will not fail as a direct result of and caused solely due to defects in workmanship and materials not known at the time of purchase and not discovered by the purchaser or anyone on behalf of the purchaser for a period of two years from the date of original purchase. 3. Tiger Tool warrants to its customers that hydraulic components will not fail as a direct result of and caused solely by defects in workmanship and materials for a period of one year from the date of original purchase. 4. Tiger Tool makes no other warranty regarding the fitness for purpose, use, quality, merchantability, or functioning of the tools other than as stated in writing in these terms and conditions of warranty.

Claims on Warranty - 5. In order for Tiger Tool to assess any claim of warranty the customer of Tiger Tool agrees to deliver the tool to one of the addresses stated in paragraph 6 or such other place as Tiger Tool may designate, at the customer's sole expense such freight being fully pre-paid and insured by the customer to the addresses designated to the customer by Tiger Tool. 6. US returns: 115 first street PMB-T75520, Sumas, WA 98295, Canada returns: 160-34434 McConnell Road, Abbotsford, B.C., V2S 7P1

Limit of Liability of Tiger Tool - 7. The limit of liability of Tiger Tool for any claim of warranty made by any customer pursuant to these terms and conditions of warranty is that Tiger Tool may at its option, repair the tool, replace the tool or refund the purchase price for the tool to the customer. Tiger Tool is not liable for any damages or claims, monetary relief or any other damages or claims, including costs and legal costs except as set out in this paragraph. Tiger Tool is not liable for any economic loss, damages for bodily injury, or claims for property damages. The limit of the warranty and the liability of Tiger Tool to its customer is as set out in this warranty. The warranty does not extend into the secondary market and the limitation of liability set out in this warranty does extend into the secondary market for the tools of Tiger Tool. Tiger Tool is not responsible for any warranty of its tools to customers of its customer or those who otherwise come into possession or use of its tools through or by its original customer. Tiger Tool is not liable for any damages or claims, monetary relief or any other damages or claims, including costs and legal costs and Tiger Tool is not liable for any economic loss, damages for bodily injury, or claims for property damages to customers of its customer or those who otherwise come into possession or use of its tools through or by its original customer. 8. This warranty is null and void and is of no effect unless the tools purchased by the customer from Tiger Tool or its authorized representative are used in accordance with the terms and conditions of use and the instructions for use published by Tiger Tool in the instructions given with the tool and published on the website of Tiger Tool. 9. Tiger Tool does not warrant any of its tools that are subject to abnormal use, including without limitation misuse, accident, modification, unreasonable use, neglect, lack of maintenance or use after any portion of a tool is significantly worn. 10. In the case that Tiger Tool decides that the tools delivered to Tiger Tool pursuant to a claim made on this warranty do not meet the conditions for any liability of Tiger Tool to perform any obligation pursuant to this warranty, then the customer must at its own expense remove the tools from the premises of Tiger Tool. Tools that are subject to this paragraph and are rejected by Tiger Tool for any claim of warranty will be retained in Tiger Tool's warehouse facility for four months without any liability of Tiger Tool as a bailee or warehouse of the dealer or customer. These tools will be retained for pick up for four months in the warehouse of Tiger Tool at the sole risk of the dealer or customer, for insurance and loss howsoever caused including by the neglect of Tiger Tool or for anyone it is responsible. Tiger Tool will during the four month period make three attempts to contact the dealer or customer to pick up the tool, and after four months have expired from the first date that Tiger Tool gives notice to the dealer or customer that there is no valid warranty claim for the tools, then the dealer or customer agrees that Tiger Tool may dispose of the tools as it deems necessary, and the dealer or customer quit claims any property or other interest in the tools at the end of that four month period including any claim for refund of purchase price, loss or damage. 11. Without limiting anything in these terms and conditions of warranty, Tiger Tool shall not be liable for any indirect, consequential, exemplary, incidental, special or other similar damages incurred by a customer or any purchaser or user, or any person or entity who comes into possession of its tools, except for the warranties specifically between the customer and Tiger Tool as set out in paragraphs 1, 2 and 3 above. Tiger Tool is not in any case in any event in any circumstances whatsoever, liable for claims for lost profits, lost revenues, lost sales, lost business opportunities, lost or damaged goodwill, interruption of business or any other injury or damage to person or property howsoever connected to the possession or use of its tool(s). 12. The terms and conditions of warranties by Tiger Tool and the limits of liability as set out in these terms and conditions of warranty represent the sole and exclusive remedies of the customer and are in place of all other rights and remedies that the customer of Tiger Tool may have. 13. Tiger Tool reserves the right to change the design and construction of its tools at any time without any obligation to any customer who has purchased the tool or any user of the tool. Tiger Tool may in its sole discretion discontinue the sale or service of any tool at any time without obligation to any customer or user of the tool. 14. Any dispute, claim or other demand made by a customer or any party against Tiger Tool, arising out of this agreement, or regarding the sale, use, condition, or function of a tool sold by Tiger Tool shall be governed by the laws of British Columbia and such disputes, including any dispute brought by class or representative proceedings, shall be adjudicated in Vancouver, British Columbia by a sole arbitrator appointed pursuant to the provisions of the arbitration act R.S.B.C. 1996, C. 55, (As amended). Any party including any customer making any claim whatsoever against Tiger Tool arising of this warranty or otherwise hereby attorns to the jurisdiction of the province of British Columbia and agrees to the arbitration of those claims in Vancouver, British Columbia.



To make a return or to learn more about the Tiger Tool Return Policy, scan or visit tigertool.com/policies/refund-policy

TIGER TOOL

Canada
160-34434 McConnell Road,
Abbotsford, BC V2S 7P1

USA
115 First Street, PMB-T75520
Sumas, WA 98295



Did you know?

You can now call or text Technical Support.
1.800.661.4661

Operating Instructions

View the Pin & Bushing Starter Kit w/o Cylinder demonstration video online at tigertool.com

NOTE: Hammering this tool will void your warranty.

VIDEO
INSTRUCTIONS



Removing Spring Eye Pin and Bushing

NOTE: The 15099 Pin and Bushing Starter Kit combines with your previously purchased 17202 Hydraulic Cylinder.

- 1 Support the truck by the chassis in an approved method so that the front suspension is unloaded.
- 2 Support the front axle assembly so that the shackles (side bars) can be removed from the trailing end of the spring eye and chassis bushings.
- 3 Remove the shackles from the trailing end of the front leaf springs on both sides of the vehicle. The vehicle can now be raised or the axle lowered to provide easy access to the spring eye pin and bushing.

Be aware of all other vehicle components that might be affected by this procedure such as brake lines and wiring. Ensure no damage is caused.

- 4 Place the removal split adapters over the inboard end of the pin bushing assembly - large end of the split adapter against the spring bushing. Then slide the supplied o-ring into the groove to hold them in place. The removal split adapters have an outside diameter slightly smaller than the bushing OD. The installation split adapters have an OD larger than the bushing OD. Ensure you have the smaller removal split adapters.
- 5 Slide the retainer sleeve over the split adapters. **(Diagram 2)**

NOTE: Optional split adapters used for demonstration purposes.

- 6 Attach the pullbar to the outboard end of the spring bushing. This is done with the pullbar split adapters and pullbar retainer sleeve.

The pullbar split adapter, pullbar, and bushing pin connect together. **(Diagram 3)**

Place both halves of the pullbar split adapter over the bushing pin and the head of the pullbar. Now slide the pullbar retaining sleeve down the pullbar and over the split adapters.

Figure 4 shows the pullbar retaining sleeve being installed. Be sure the pullbar retaining sleeve fully covers the pullbar split adapters.

- 7 Connect the face adapter and extension tube together and slide them over the pullbar retaining sleeve. **(Figures 5 and 6)**

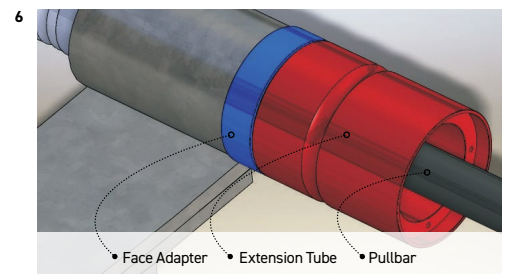
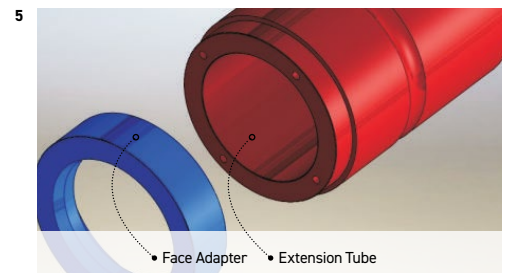
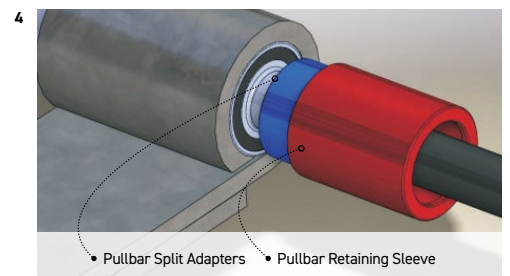
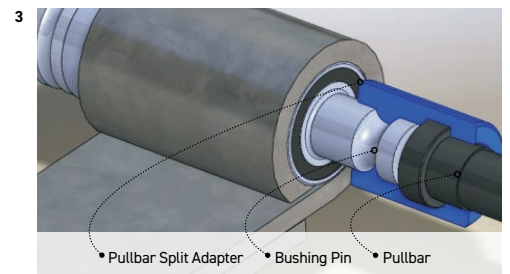
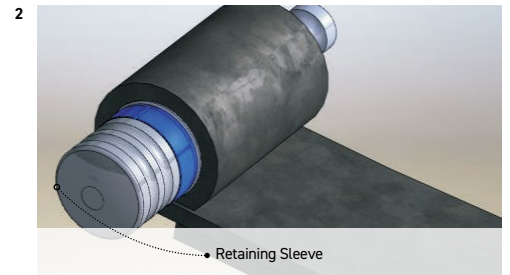
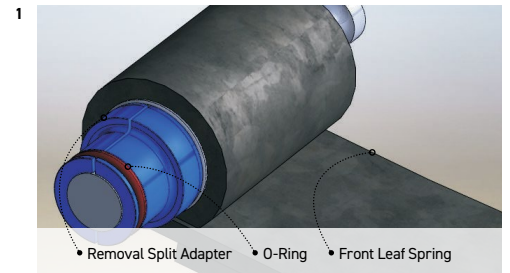

Operating Instructions

Removing Spring Eye Pin and Bushing Continued

- 8 Thread the cylinder tube onto the hydraulic cylinder. Slide the hydraulic cylinder/cylinder tube assembly over the pullbar, cylinder tube first. **(Figures 7 & 8)**
- 9 Thread on the retaining nut and tighten by hand until tight. This will hold everything in place. The 20 ton hydraulic cylinder will provide the power required to remove the pin bushing. Do final check to ensure all the parts are still in place—the face adapter should be flush against the spring face or the bushing housing. **(Figure 9)**
- 10 Apply hydraulic pressure—the bushing is pulled partially from the spring eye or bushing housing. **(Figure 10)**
- 11 Remove hydraulic pressure allowing the hydraulic cylinder to retract.
- 12 Tighten the retaining nut by hand until tight to take up the slack. Check to ensure all parts are still in place. **(Figure 11)**
- 13 Apply hydraulic pressure, the hydraulic cylinder extends and the bushing is pulled fully from the spring eye or bushing housing. If the bushing is not fully removed from the spring eye or housing, repeat steps 11 through 13.

See cross section of the bushing fully removed from the spring eye. **(Figure 12)**

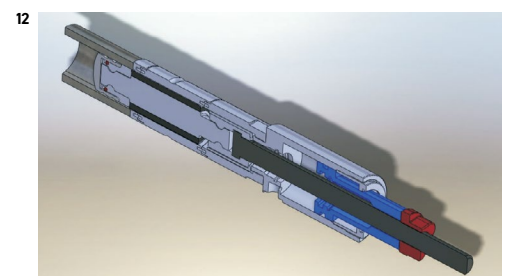
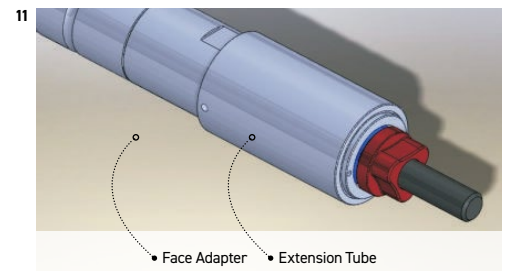
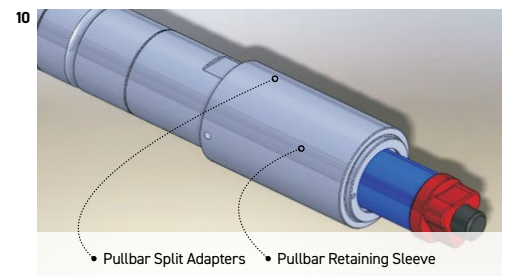
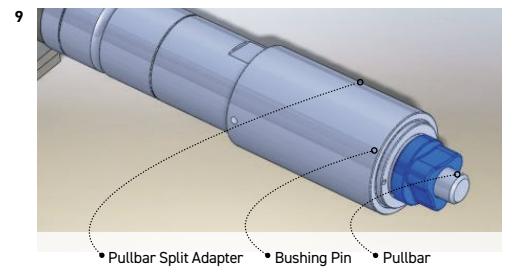
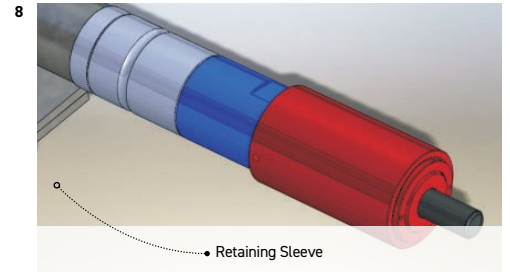
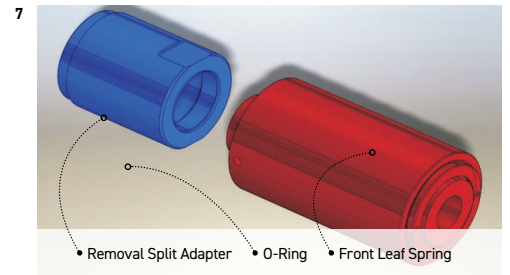

Operating Instructions

Installing Spring Eye Pin and Bushing

NOTE: Optional split adapters were used for this demonstration.

It is recommended that after removing a bushing/pin assembly, you immediately install the new bushing/pin assembly. The instructions given here follow that methodology. Note this tool pulls the bushing/pin assembly into the spring eye from the inboard side of the spring.

- 1 Disassemble the previous puller assembly leaving the cylinder tube attached to the hydraulic cylinder.
- 2 On the bench, attach the install split adapters, o-ring, and retaining sleeve to one end of the bushing/pin assembly in the same method as step 5 and 6 removal. **(Figure 1)**
- 3 Slide the pullbar through the spring eye from the outboard side of the spring. Attach the new bushing/pin assembly with the pullbar split adapters and the pullbar retaining sleeve in the same method as removal step 7. **(Figure 2)**
- 4 Slide the face adapter over the cylinder tube end and slide the cylinder, cylinder tube, and face adapter over the pullbar.
- 5 Spin on the retaining nut and tighten by hand to take up the slack **(Figure 3)**. Double check that the bushing/pin assembly is in alignment with the bore of the spring eye.
- 6 Apply hydraulic pressure to the cylinder and the bushing/pin assembly is pulled partially into the spring eye. Release pressure allowing the cylinder to retract. Tighten the retaining nut and apply hydraulic pressure once again to pull the bushing/pin assembly farther into the spring eye. The install split adapters are larger than the OD of the bushing and will stop the bushing/pin assembly at the correct installation distance.
- 7 Disassemble the tool from the bushing/pin assembly.
- 8 Replace remaining bushing/pin assemblies as required.

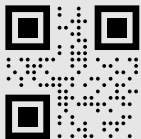
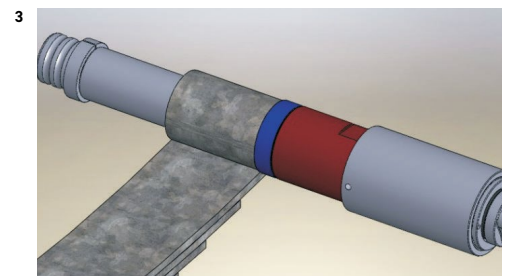
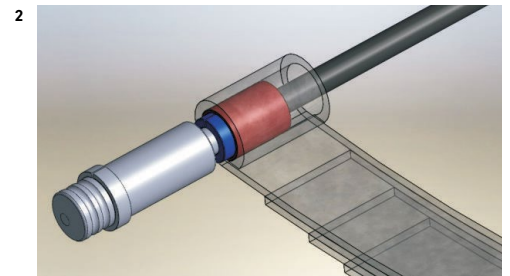
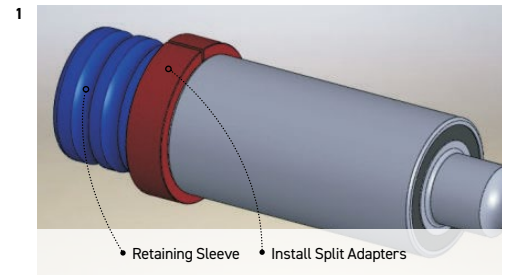

Need some assistance with your Tiger Tool?

No worries! Scan this QR code with your phone to start texting with someone who can help out.

1.800.661.4661

Parts Breakdown



Part Number	Description	Qty.
15001-77	Large Face Adapter	1
15031-1	Retaining Ring	2
15001-75	Cylinder Adapter	1
15001-76	Extension Tube	1
15001-23	Cylinder Tube Cap	1
15001-17	1 3/4" Pull Adapter	2
15001-18	Small Pull-bar Retaining Sleeve	1
15001-5	Pull-bar Retaining Sleeve	1

Parts Breakdown

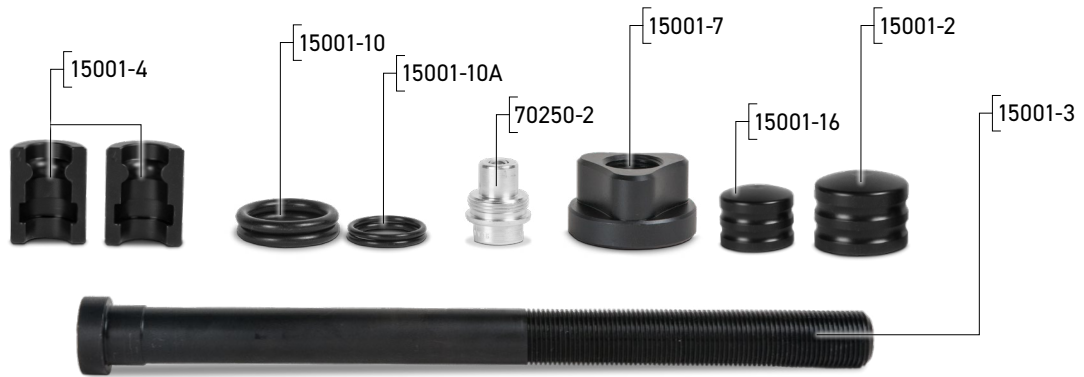

Part Number	Description	Qty.
15001-4	2 1/16" Pull Adapter	2
15001-10	Large O-Ring	2
15001-10A	Small O-Ring	2
70250-2	Male Hydraulic Coupler	1
15001-7	Trigon Retaining Nut	1
15001-16	Small Retaining Cap	1
15001-2	Large Retaining Cap	1
15001-3	Pin & Bushing Pull-bar	1