

Please read this manual carefully before installation and keep it for future reference.

Remote Control User Manual



MRCOOL®

COMFORT MADE SIMPLE

Due to updates and constantly improving performance, the information and instructions within this manual are subject to change without notice. Please visit www.mrcool.com/documentation to ensure you have the latest version of this manual.

Version Date: 08-11-22

For more info visit www.mrcool.com

- 1 Remote Controller Specifications & Quick Start Guide 2**
- 2 Handling the Remote Controller 3**
- 3 Easy Pro® & Olympus Series Remote Controller 4**

- Buttons & Functions 4
- Remote Screen Indicators 5
- How to Use Basic Functions 6
- Setting the Timer 8
- How to Use Advanced Functions 8

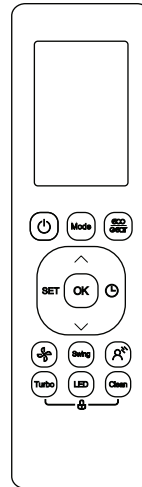

Easy Pro® & Olympus Series
Remote Controller
Model #:
RG10A(D2S)/BGEFU1

- 4 Advantage Series, DIY® Multi-Zone, & DIY® E-Star™ Remote Controller 12**

- Buttons & Functions 12
- Remote Screen Indicators 13
- How to Use Basic Functions 14
- Setting the Timer 16
- How to Use Advanced Functions 17

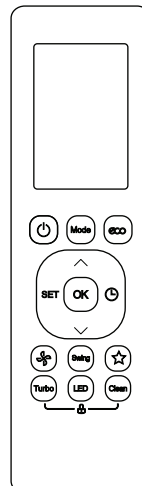

Advantage Series,
DIY® Multi-Zone, &
DIY® E-Star™
Remote Controller
Model #:
RG10A4(D1)/BGEFU1

- 5 DIY® Ceiling Cassette Remote Controller 21**

- Buttons & Functions 21
- Remote Screen Indicators 22
- How to Use Basic Functions 23
- Setting the Timer 24
- How to Use Advanced Functions 25

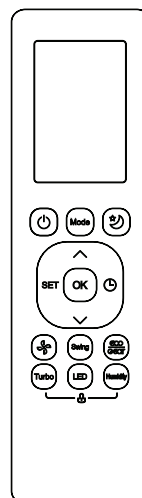

DIY® Ceiling Cassette
Remote Controller
Model #:
RG10L2(D2HS)/BGEFU1

Model	Advantage Series, DIY® Multi-Zone, & DIY® E-Star™: RG10A4(D1)/BGEFU1 Easy Pro® & Olympus Series: RG10A(D2S)/BGEFU1 DIY® Ceiling Cassette: RG10L2(D2HS)/BGEFU1
Rated Voltage	3.0V (Dry Batteries R03/LR03 x 2)
Signal Receiving Range	26.25 ft. (8 m)
Operational Temperature Range	23°F ~ 140°F (-5°C ~ 60°C)

Quick Start Guide

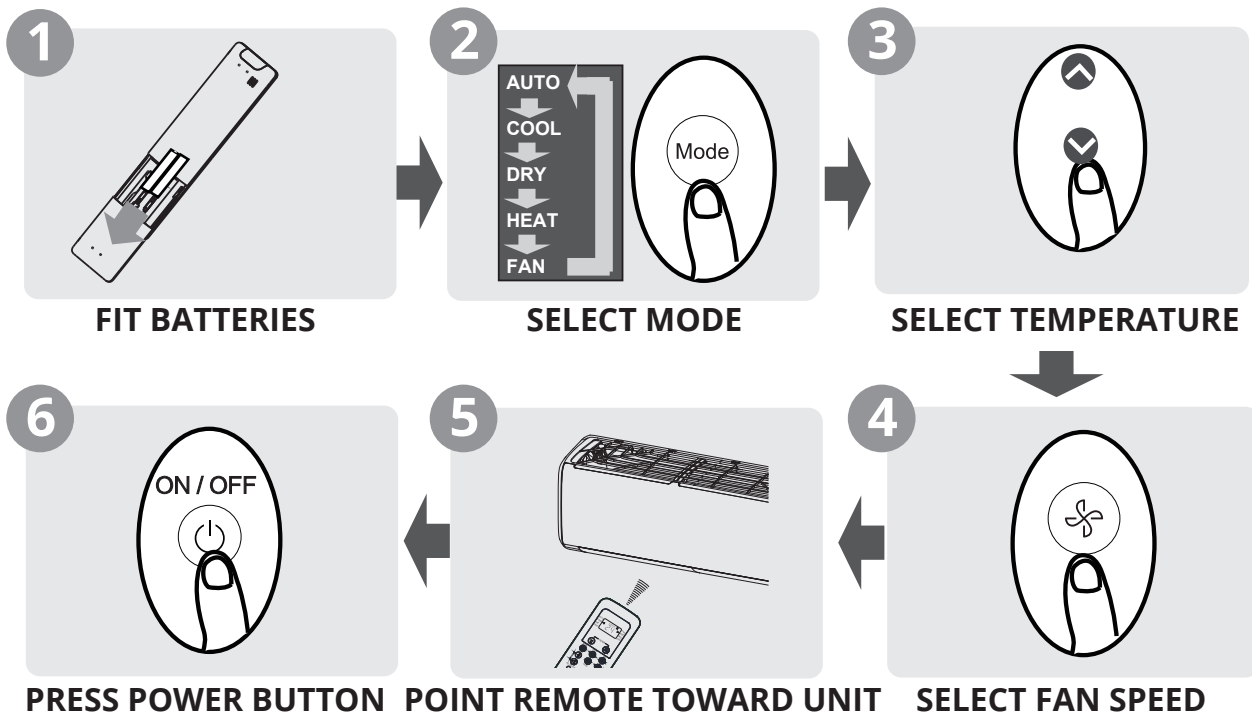

NOT SURE WHAT A FUNCTION DOES?

Refer to the **How to Use Basic Functions** and **How to Use Advanced Functions** sections of this manual for more detailed instructions of how to operate the unit.

SPECIAL NOTE

- Button designs on your remote may differ slightly from the example shown.
- If the indoor unit is not equipped with a particular function, but your remote controller has a button for it, pressing that function's button on the remote control will have no effect.
- When there are differences between the "**Remote Controller Manual**" and the "**USER'S MANUAL**" when it comes to function description, the description of "**USER'S MANUAL**" should take precedence.

Inserting and Replacing Batteries

Your air conditioning unit may come with two batteries (some units). Install the batteries in the remote control before use by following the steps below:

1. Slide the back cover from the remote control downward to expose the battery compartment.
2. Insert the batteries, making sure to match the (+) and (-) designations on the end of the batteries with the symbols inside the battery compartment.
3. Reinstall the back cover by sliding it back into place.

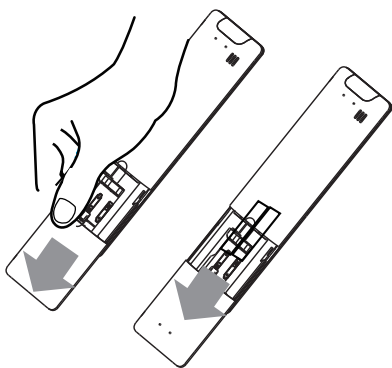

! BATTERY NOTES

For optimum product performance:

- ⊘ **DO NOT** mix old and new batteries, or batteries of different types.
- ⊘ **DO NOT** leave batteries in the remote control if the device will not be used for more than 2 months.



BATTERY DISPOSAL

- ⊘ **DO NOT** dispose of batteries as unsorted municipal waste. Refer to local laws for proper disposal of batteries.

TIPS FOR USING REMOTE CONTROL

- The remote control must be used within 26 ft (8 m) of the unit.
- The unit will beep when remote signal is received.
- Curtains, other materials, and direct sunlight can interfere with the infrared signal receiver. Remove batteries if the remote will not be used more than 2 months.

NOTES FOR USING REMOTE CONTROL

The device should comply with the local national regulations.

- In Canada, it should comply with CAN ICES-3(B)/NMB-3(B).
- In the USA, this device complies with part 15 of the FCC Rules. Operation is subject to the following two conditions:
 - (1) This device may not cause harmful interference, and
 - (2) this device must accept any interference received, including interference that may cause undesired operation.

This equipment has been tested and found to comply with the limits for a Class B digital device, pursuant to part 15 of the FCC Rules. These limits are designed to provide reasonable protection against harmful interference in a residential installation. This equipment generates, uses, and radiates radio frequency energy. If it is not installed and used in accordance with the instructions, may cause harmful interference to radio communications. However, there is no guarantee that interference will not occur in a particular installation. If this equipment does cause harmful interference to radio or television reception, which can be determined by turning the equipment off and on, the user is encouraged to try to correct the interference by using one or more of the following measures:

- Reorient or relocate the receiving antenna.
- Increase the separation between the equipment and receiver.
- Connect the equipment into an outlet on a circuit different from that to which the receiver is connected.
- Consult the dealer or an experienced radio/TV technician for help.
- Changes or modifications not approved by the party responsible for compliance could void user's authority to operate the equipment.

Buttons and Functions

Before you begin using your new air conditioner, make sure to familiarize yourself with its remote control. The following is a brief introduction to the remote control itself. For instructions on how to operate your air conditioner, refer to the **How to Use Basic Functions** section of this manual.

ON/OFF
Turns the unit on or off.

TEMP ^
Increases temperature in 1°F (1°C) increments. Maximum Temperature setting is 86°F (30°C).

NOTE: Pressing the ^ & v buttons together for 3 seconds will alternate the temperature display between °C & °F.

SET
Scrolls through operation functions in following sequence:

Sleep (⌚) → **Follow Me** (⊗) → **AP Mode** (📶)

The selected symbol will flash on the display window, press the OK button to confirm.

TEMP v
Decreases temperature in 1°F (1°C) increments. Minimum temperature setting is 60°F (16°C).

FAN SPEED
Selects fan speeds in the following sequence:
AU → **20%** → **40%** → **60%**
80% → **100%**

Press the **TEMP v** or **^** button to increase or decrease the fan speed in 1% increments.

SWING
Starts and stops the horizontal louver movement. Hold down for 2 seconds to initiate vertical louver auto swing feature.

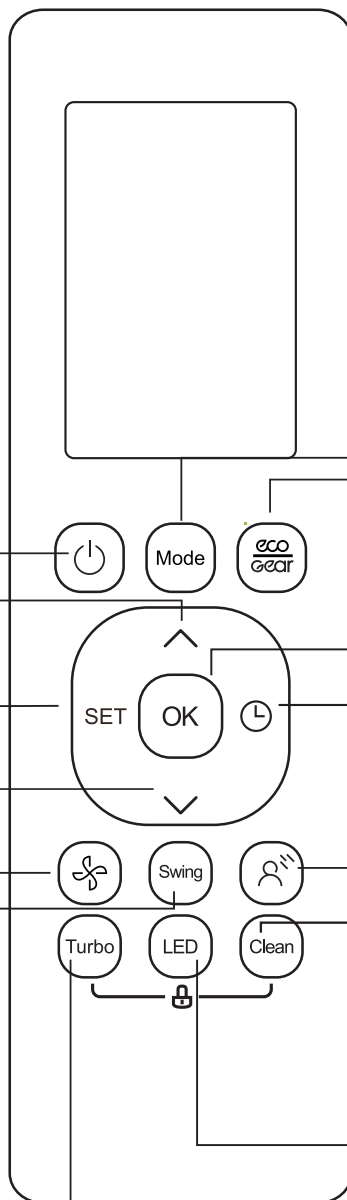

MODE
Scrolls through operation modes in the following sequence:

AUTO → **COOL** → **DRY** → **HEAT** → **FAN**

NOTE: HEAT mode is not supported by the cooling-only version.

ECO/GEAR
Press this button to enter the energy efficient modes which can be selected in the following sequence:

ECO → **GEAR (75%)** → **GEAR (50%)**
→ **Previous setting mode** → **ECO**

OK
Used to confirm the selected functions.

TIMER
Used to set the timer to turn the unit on or off at a specified time.

BREEZE AWAY
This feature keeps direct airflow from blowing directly on the occupants of the room.

NOTE: This feature is only available in COOL, FAN, and DRY modes.

CLEAN
Used to start/stop the Self-Clean or Active Clean function (Model dependent, please refer to the **USER'S OPERATION & INSTALLATION MANUAL**).

LED
Turns the indoor unit's LED display and air conditioner buzzer on and off (model dependent), to create a quiet environment.

TURBO
Enables unit to reach the preset temperature in the shortest possible time.

Remote Screen Indicators

Information that is displayed when the remote controller is turned on.

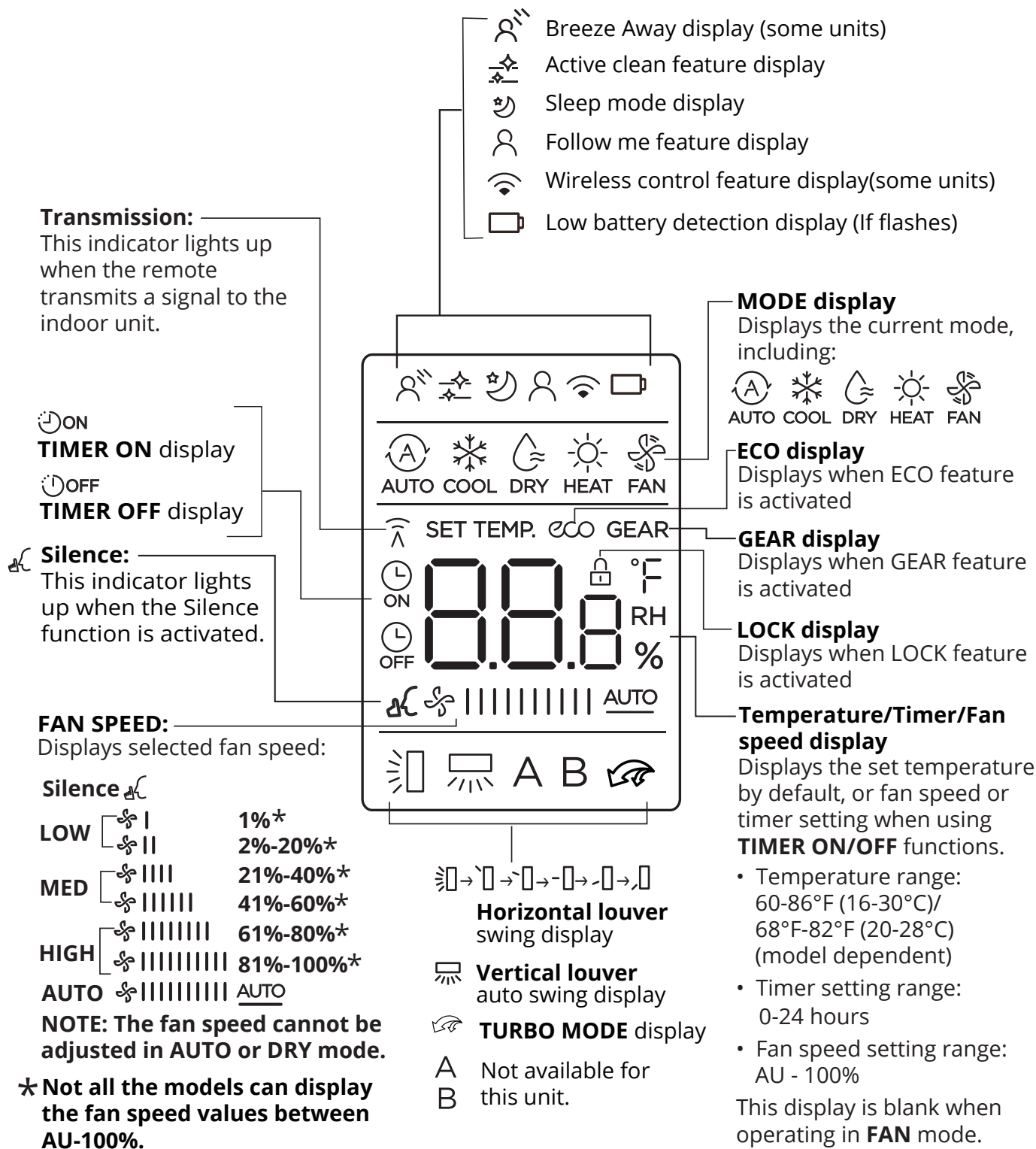

NOTE: All indicators shown are for demonstration purposes. During actual operation, only the relative and active functions will be shown in the display window.

How to Use Basic Functions

! ATTENTION

Please ensure the unit is plugged in and power is available before operation.

AUTO Mode

Select **AUTO** mode



Set your desired temperature



Turn on the air conditioner



NOTE:

- In **AUTO** mode, the unit will automatically select **COOL**, **FAN**, or **HEAT** function based on the set temperature.
- In **AUTO** mode, fan speed cannot be set or adjusted by the user.

COOL or HEAT Mode

Select **COOL/HEAT** mode

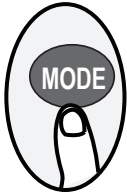

Set the temperature



Set the fan speed



Turn on the air conditioner



DRY Mode

Select **DRY** mode

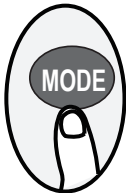

Set your desired temperature



Turn on the air conditioner



NOTE: In **DRY** mode, fan speed cannot be set because it is automatically controlled.

FAN Mode

Select **FAN** mode

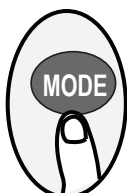

Set the fan speed



Turn on the air conditioner



NOTE: In **FAN** mode, the temperature cannot be set or adjusted. As a result, no temperature reading will display on the remote screen.

Setting the TIMER

TIMER ON/OFF - Set the amount of time after which the unit will automatically turn on/off.

TIMER ON setting

Press **TIMER** button to initiate the **ON** time sequence.

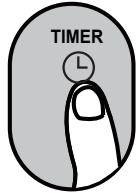

Press **Temperature UP or DOWN** button to set the desired time to turn **ON** the unit.

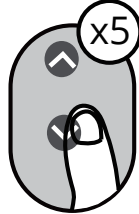

Point remote control at the unit and wait 1 second, the **TIMER ON** will be activated.

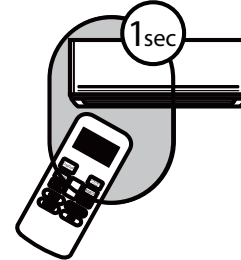

TIMER OFF setting

Press **TIMER** button to initiate the **OFF** time sequence.

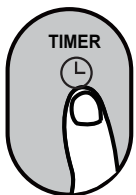

Press **Temperature UP or DOWN** button to set the desired time to turn **OFF** the unit.



Point remote control at the unit and wait 1 sec, the **TIMER OFF** will be activated.



NOTE:

- When setting the **TIMER ON** or **TIMER OFF**, the time will increase by 30 minutes increments with each press, up to 10 hours. After 10 hours and up to 24, it will increase in 1 hour increments. (For example, press 5 times to get 2.5h, and press 10 times to get 5h,) The timer will revert to 0.0 after 24.
- Cancel either function by setting its timer to 0.0h.

TIMER ON & OFF setting (example)

NOTE: Keep in mind that the time periods you set for both functions refer to hours after the current time.

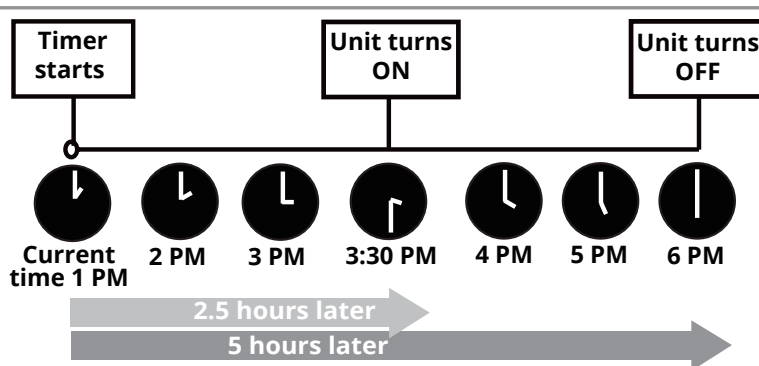
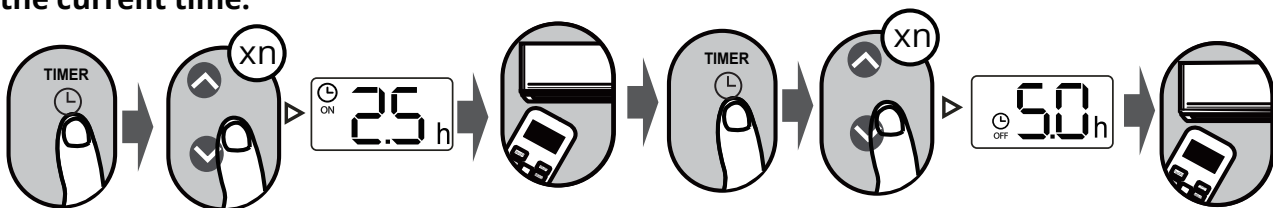

Example: If current time is 1:00PM, and the timer is set using the above steps, the unit will turn on 2.5 hours later (3:30PM) and then turn off at 6:00PM (5 hours after the timer is originally set).

How to Use Advanced Functions

Swing function

Press the **SWING** button

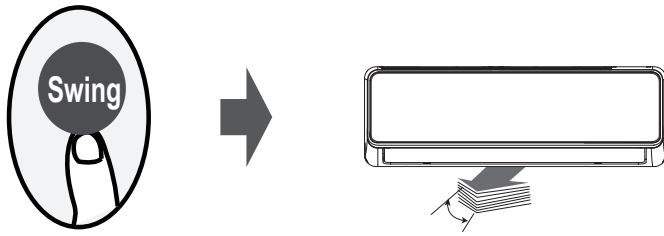

The horizontal louver will swing up and down automatically when pressing **SWING** button. Press it again to make it stop.

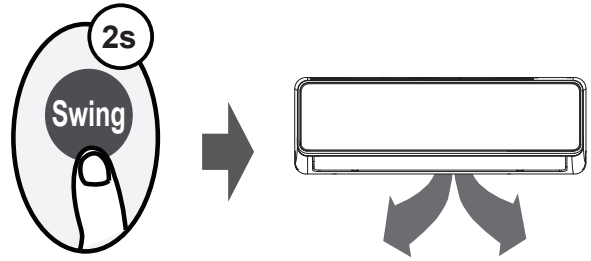

Keep pressing the **SWING** button more than 2 seconds, this will activate the vertical louver swing function (Model dependent).

Airflow direction

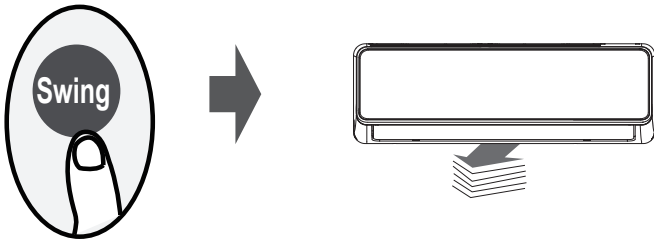

If continue to press the **SWING** button, five different airflow directions can be set. The louver can be moved to a different angle each time you press the button. Continue pressing the button until the desired setting is reached.

NOTE: When the unit is off, press and hold the **MODE** and **SWING** buttons together for one second, the louver will move to an extreme angle to make it easier to clean. Press and hold the **MODE** and **SWING** buttons together again for one second to reset the louver to its original position (Model dependent).

LED Display

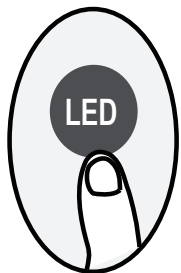

Press **LED** button

Press the **LED** button to either turn on or off the display on the indoor unit.

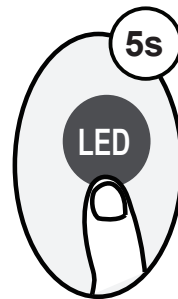

Press and hold the **LED** button more than 5 seconds (some units).

Press and hold the **LED** button more than 5 seconds, to make the display of the indoor unit show the actual room temperature. Press and hold the **LED** button for more than 5 seconds again and the display will revert back to the set temperature.

ECO/GEAR function



Pressing the **ECO/GEAR** button will allow you to select the energy efficiency modes in the following sequence:

ECO → GEAR (75%) → GEAR (50%) → Previous setting mode → ECO.....

NOTE: This function is only available under the COOL mode.

ECO operation:

Under **COOL** mode, press this button and the remote controller will automatically adjust the temperature to 75°F (24°C), fan speed off of **AUTO** to save energy. However, this only occurs when the set temperature is less than 75°F (24°C). If the set temperature is above 75°F (24°C), pressing the **ECO** button will cause the fan speed to change to **AUTO** and the set temperature will remain unchanged.

NOTE:

- Pressing the **ECO/GEAR** button, modifying the mode, or adjusting the set temperature to less than 75°F (24°C), will stop ECO operation.
- Under ECO operation, the set temperature should be 75°F (24°C) or above, or it may result in insufficient cooling. If the cooling feels insufficient, press the **ECO** button again to turn off this feature.

GEAR operation:

Press the **ECO/GEAR** button to enter the **GEAR** operation as following:

75% (up to 75% electrical energy consumption)



50% (up to 50% electrical energy consumption)



Previous setting mode.

Under **GEAR** operation, the display on the remote controller will alternate between electrical energy consumption reading and the set temperature.

Silence function

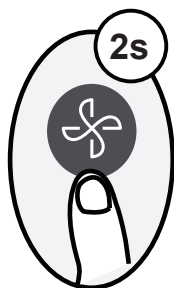

Pressing the **FAN** button for more than 2 seconds will activate or disable the Silence function (some units).

Due to low frequency operation of compressor, this function could result in insufficient cooling and heating capacity. Pressing the **ON/OFF, MODE, SLEEP, TURBO** or **CLEAN** button while the system is operating with the silence function activated will cancel it.

How To Use Advanced Functions

FP function

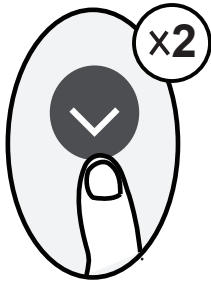

Using this function will cause the unit to operate with a high fan speed setting (while the compressor is on) with temperature automatically set to the lowest setting, 46°F (8°C), in order to achieve faster cooling.

NOTE: The function listed below is for heat pump air conditioners only.

Press the button 2 times within one second while in HEAT Mode and the temperature will be set to 60°F (16°C) or 68°F (20°C) (dependent on model) and the FP function will be activated.

Pressing the On/Off, Sleep, Mode, Fan or Temperature buttons while operating this function will cancel it.

LOCK function

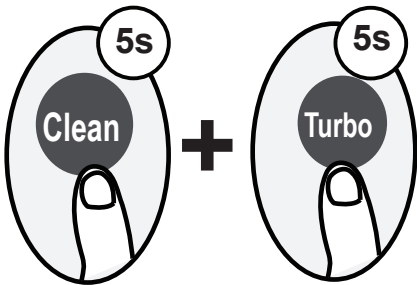

Pressing the **CLEAN** and **TURBO** buttons at the same time for more than 5 seconds will activate the **LOCK** function.

With this feature activated no buttons pressed will respond, except when these two buttons are pressed again for two seconds in order to disable the **LOCK** function.

Clean Function (some units)

Press **CLEAN** button



Airborne bacteria can grow in the moisture that condenses around heat exchanger in the unit. With regular use, most of this moisture is evaporated from the unit. By pressing the **CLEAN** button, your unit will clean itself automatically. After cleaning has been completed, the unit will turn off automatically. Pressing the **CLEAN** button mid-cycle will cancel the operation and turn off the unit. You can use the **CLEAN** function as often as you like.

NOTE: You can only activate this function in COOL or DRY mode.

TURBO Function

Press **TURBO** button



When the TURBO button is pressed while the unit is in COOL mode, the unit will blow cool air with highest fan setting to speed up the cooling process.

When the TURBO button is pressed while the unit is in HEAT mode, for units with electric heat elements, the electric heater will activate and speed up the heating process.

SET function

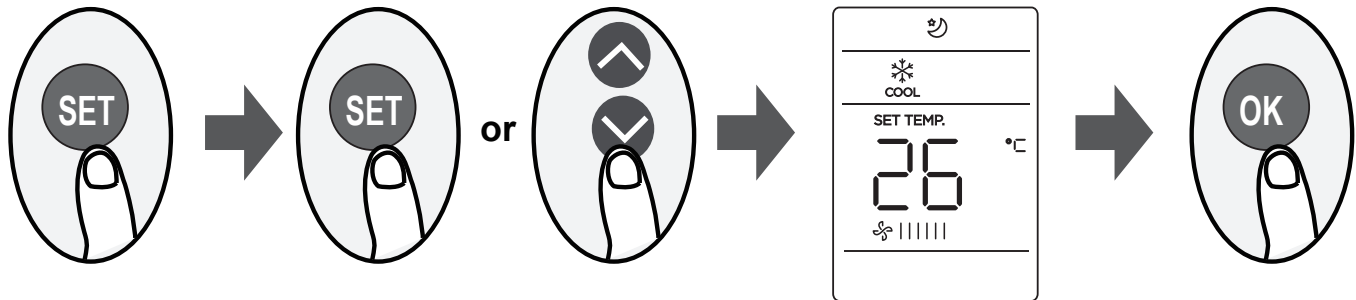

- Press the **SET** button to enter the function setting, then press the **SET** button or the **TEMP** \downarrow or \uparrow buttons to select the desired function. The selected symbol will flash on the display, press the **OK** button to confirm and this will activate the selected function.
- To cancel the selected function, just perform the same procedures as above.
- Press the **SET** button to scroll through operation functions as follows:

Breeze Away* (🌀) → **Sleep** (🌙) → **Follow Me** (👤) → **AP mode** (📶)

[*]: If your remote controller has a **Breeze Away** button or **Sleep** button, you cannot use the **SET** button to select the **Breeze Away** or **Sleep** feature.

Breeze Away function (🌀) (some units):

This feature keeps airflow from being blown directly on the occupants of the room.

NOTE: This feature is available under COOL, FAN and DRY modes only.

Sleep function (🌙):

The SLEEP function is used to decrease energy use while you sleep (temperature settings needed to stay comfortable during sleep differ from the settings needed while awake). This function can only be activated via the remote control.

For further details, please refer to the **Sleep Operation** section of your unit's **USER MANUAL**.

NOTE: The SLEEP function is not available in FAN or DRY mode.

AP function (📶) (some units):

Choose **AP** mode to use the wireless network configuration. For some units, it does not work by pressing the **SET** button. To enter the AP mode, continuously press the **LED** button seven times within 10 seconds.

Follow me function (👤):

The **FOLLOW ME** function enables the remote control to measure the temperature at the location it currently is and send this signal to the air conditioning unit in a 3 minute interval. When using **AUTO, COOL, or HEAT** modes, measuring the ambient temperature from the remote control (instead of from the indoor unit itself) will enable the air conditioner to optimize the temperature where you currently are and ensure maximum comfort.

NOTE: Press and hold the TURBO button for seven seconds to start or stop the memory feature of the FOLLOW ME function.

- If the memory feature is activated, "ON" will display for 3 seconds on the screen.
- If the memory feature is stopped, "OF" will display for 3 seconds on the screen.
- While the memory feature is activated, press the ON/OFF button, shift the mode or power failure will not cancel the Follow Me function.

Buttons and Functions

Before you begin using your new air conditioner, make sure to familiarize yourself with its remote control. The following is a brief introduction to the remote control itself. For instructions on how to operate your air conditioner, refer to the **How to Use Basic Functions** section of this manual.

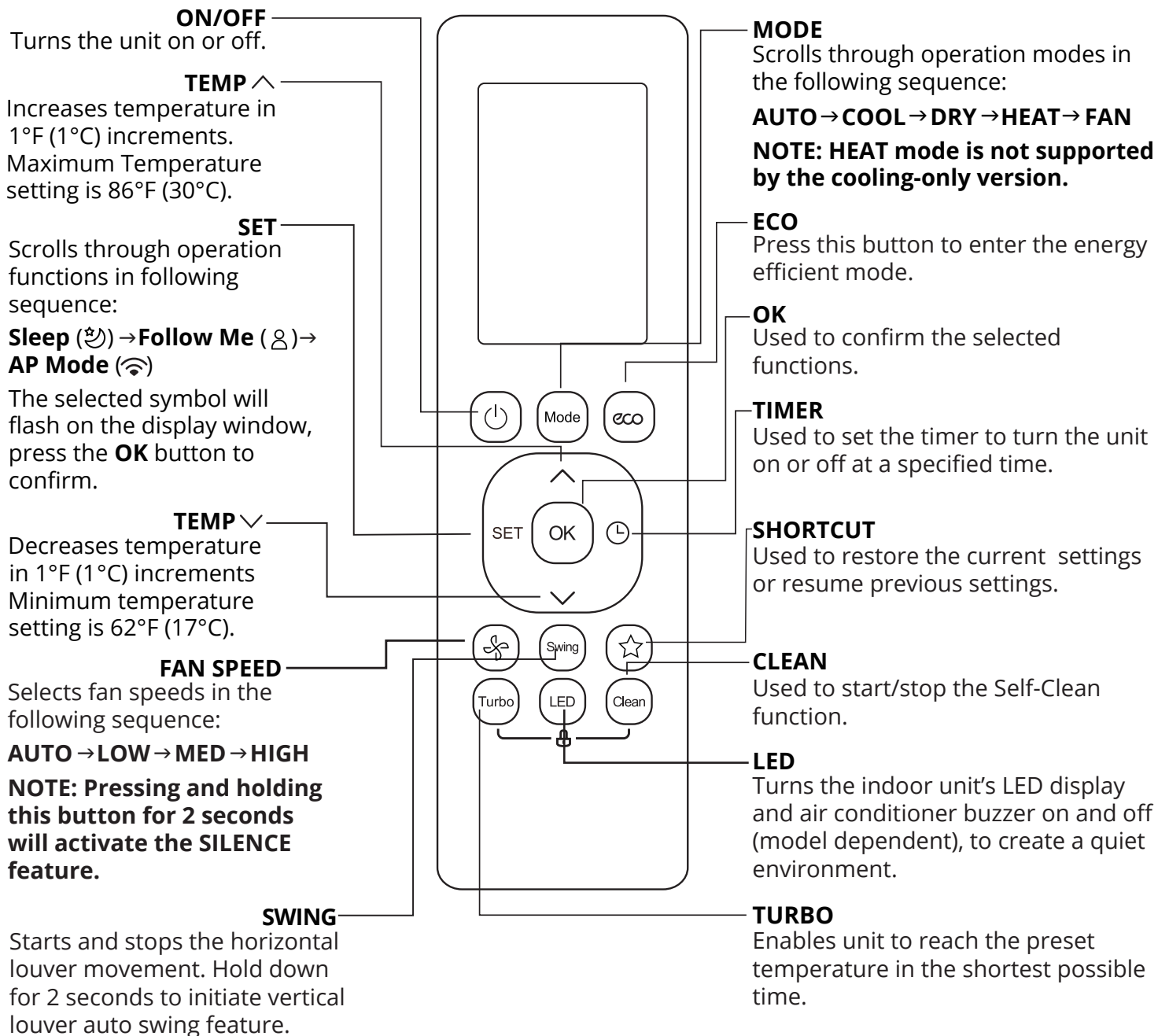

NOTE: Press and hold the temperature ^ & v buttons together for 3 seconds and it will alternate the temperature display between °F and C° readings.

Remote Screen Indicators

Information that is displayed when the remote controller is turned on.

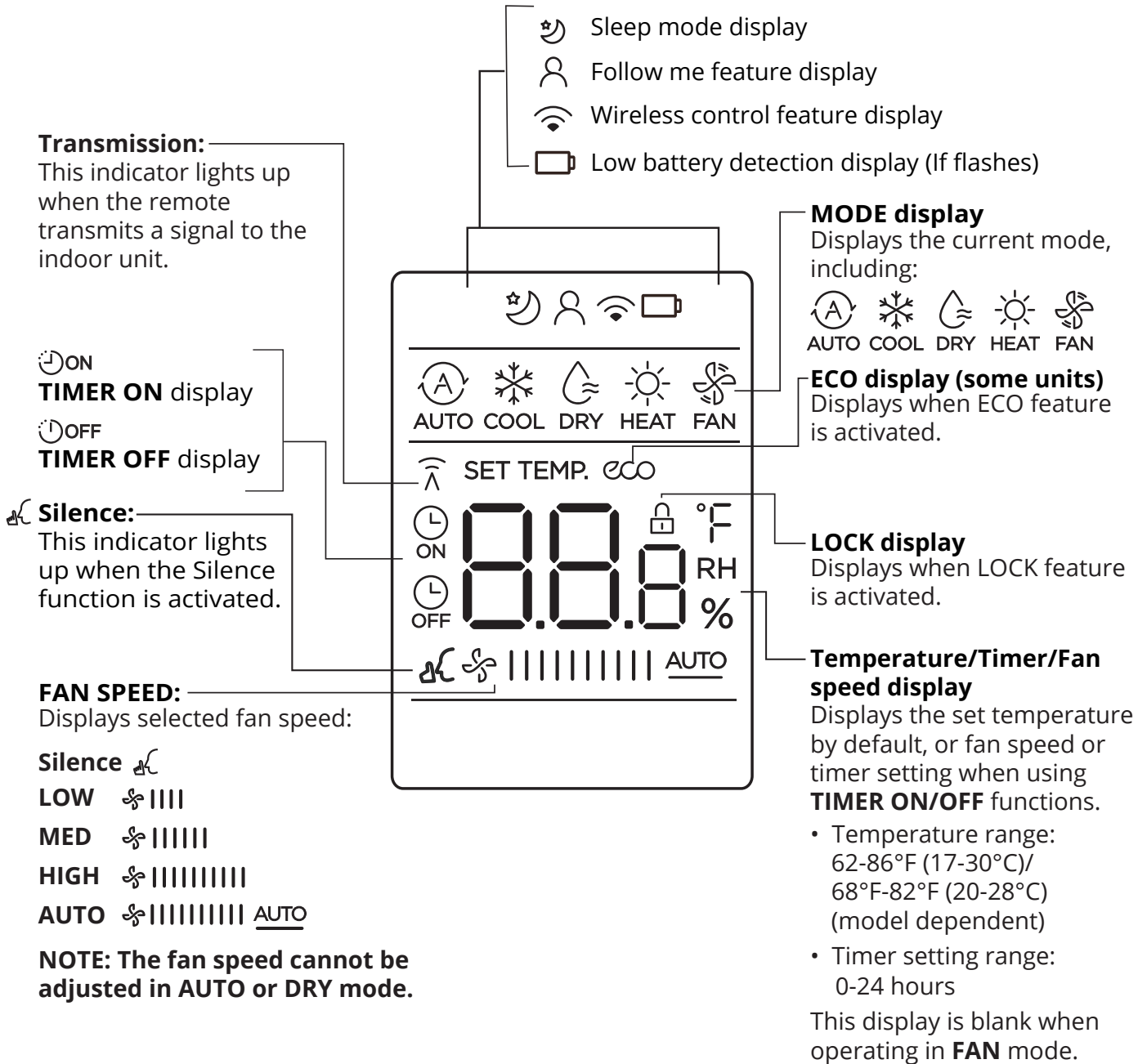

NOTE: All indicators shown are for demonstration purposes. During actual operation, only the relative and active functions will be shown in the display window.

How to Use Basic Functions

! ATTENTION

Please ensure the unit is plugged in and power is available before operation.

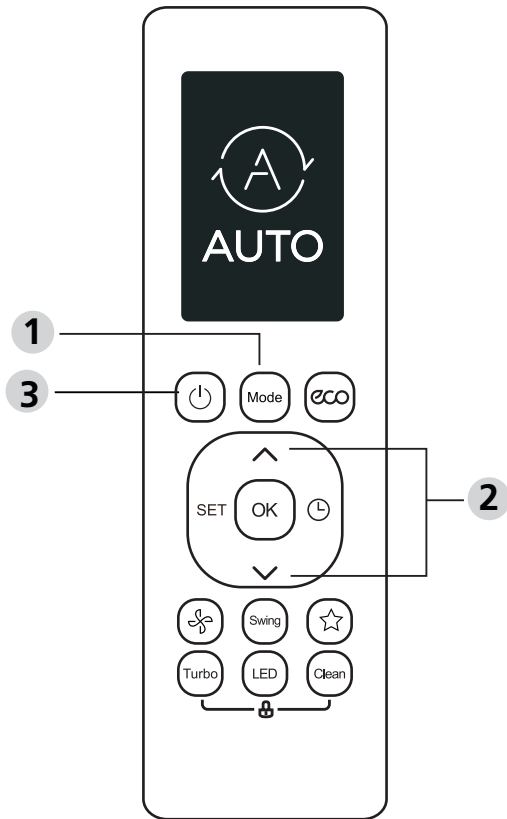

SETTING TEMPERATURE

The operating temperature range for units is 62-86°F (17-30°C) or 68-82°F (20-28°C) (model dependent). You can increase or decrease the set temperature in 1°F (1°C) increments by using the the Temperature ^ or v buttons on the remote.

AUTO Mode

In **AUTO** mode, the unit will automatically select the **COOL, FAN, or HEAT** operating mode based on the set temperature. To select AUTO mode follow these steps:

1. Press the **MODE** button and select **AUTO** mode.
2. Set your desired temperature using the **TEMPERATURE** ^ or v buttons.
3. Press the **ON/OFF** button to start the unit.

NOTE: FAN speed cannot be set or adjusted in AUTO mode.

COOL Mode

To select **COOL** Mode follow these steps:

1. Press the **MODE** button and select **COOL** mode.
2. Set your desired temperature using the **TEMPERATURE** ^ or v buttons.
3. Press the **FAN** button to select the desired fan speed: **AUTO, LOW, MED, or HIGH**.
4. Press the **ON/OFF** button to start the unit.

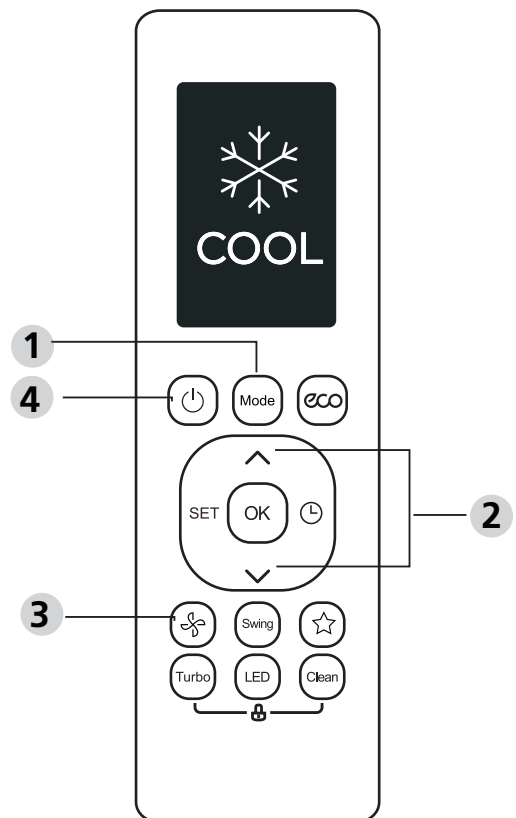

How To Use Basic Functions

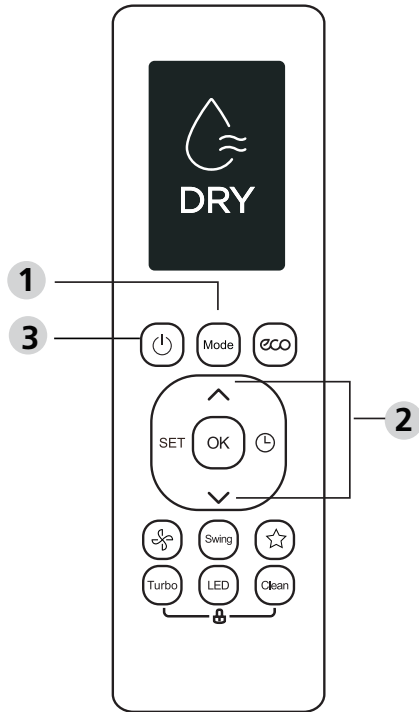

DRY Mode (dehumidifying function)

In **DRY** mode, the unit acts as a dehumidifier. To select **DRY** mode follow these steps:

1. Press the **MODE** button and select **DRY** mode.
2. Set your desired temperature using the **TEMPERATURE** \wedge or \vee buttons.
3. Press the **ON/OFF** button to start the unit.

NOTE: FAN speed cannot be set or adjusted in DRY mode.

FAN Mode

1. Press the **MODE** button and select **FAN** mode.
2. Press **FAN** button to select the desired the fan speed: **AUTO, LOW, MED, or HIGH**.
3. Press the **ON/OFF** button to start the unit.

NOTE: The temperature cannot be set or adjusted in FAN mode. As a result of this, the remote control LCD display will not display the temperature.

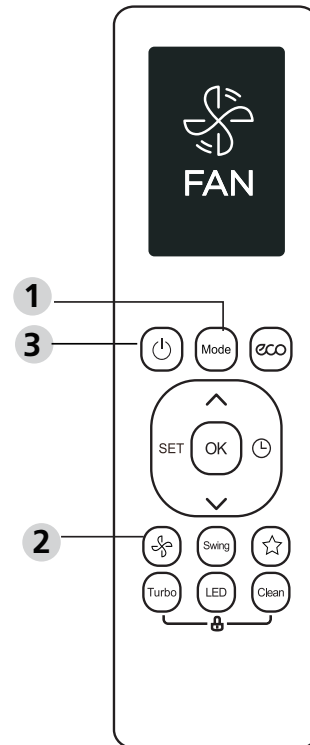

HEAT Mode

To select **HEAT** mode follow these steps:

1. Press the **MODE** button and select **HEAT** mode.
2. Set your desired temperature using the **TEMPERATURE** \vee or \wedge buttons.
3. Press the **FAN** button to select the desired fan speed: **AUTO, LOW, MED, or HIGH**.
4. Press the **ON/OFF** button to start the unit.

NOTE: As the outdoor temperature drops, the performance of the unit's HEAT function may be affected. If this occurs, we recommend using other heating appliances in conjunction with the unit.

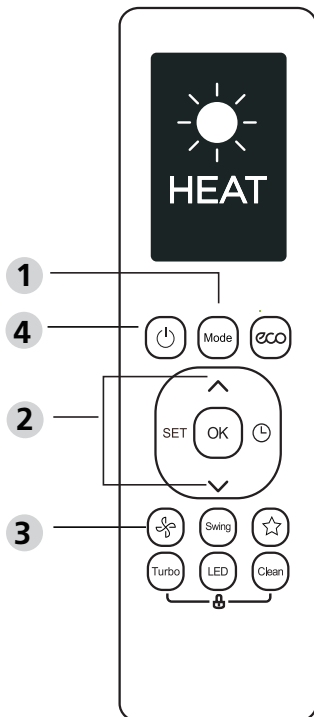

Setting the TIMER

TIMER ON/OFF - Set the amount of time after which the unit will automatically turn on/off.

TIMER ON setting

Press **TIMER** button to initiate the **ON** time sequence.

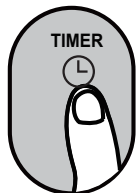

Press **Temperature UP or DOWN** button to set the desired time to turn **ON** the unit.

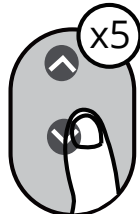

Point remote control at the unit and wait 1 second, the **TIMER ON** will be activated.

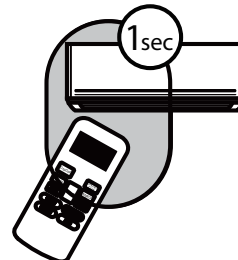

TIMER OFF setting

Press **TIMER** button to initiate the **OFF** time sequence.

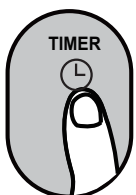

Press **Temperature UP or DOWN** button to set the desired time to turn **OFF** the unit.

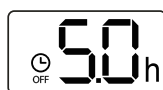
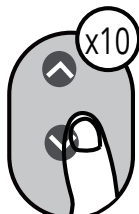

Point remote control at the unit and wait 1 sec, the **TIMER OFF** will be activated.



NOTE:

- When setting the **TIMER ON** or **TIMER OFF**, the time will increase by 30 minutes increments with each press, up to 10 hours. After 10 hours and up to 24, it will increase in 1 hour increments. (For example, press 5 times to get 2.5h, and press 10 times to get 5h,) The timer will revert to 0.0 after 24.
- Cancel either function by setting its timer to 0.0h.

TIMER ON & OFF setting (example)

NOTE: Keep in mind that the time periods you set for both functions refer to hours after the current time.

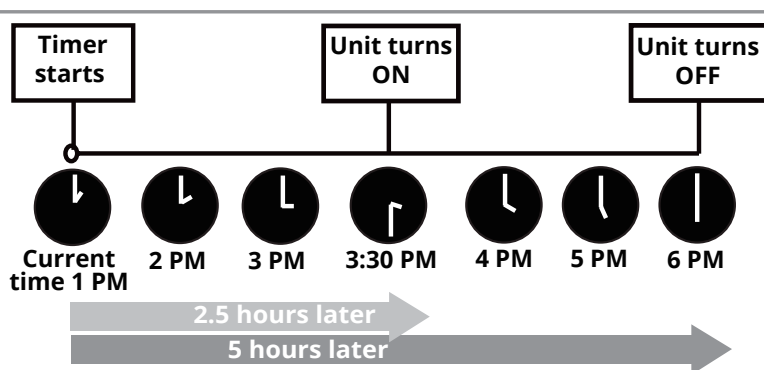
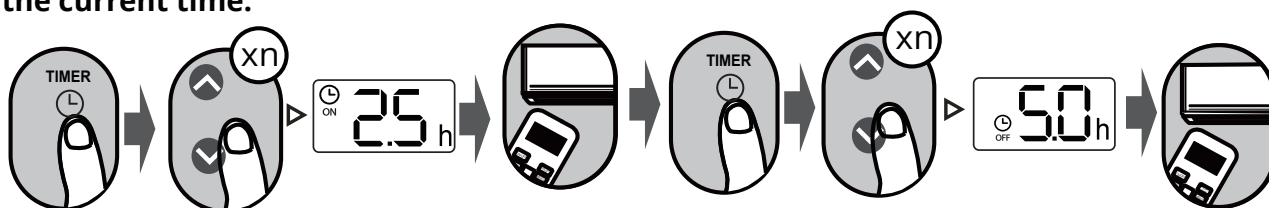

Example: If current time is 1:00PM, and the timer is set using the above steps, the unit will turn on 2.5 hours later (3:30PM) and then turn off at 6:00PM (5 hours after the timer is originally set).

How to Use Advanced Functions

Swing function

Press the **SWING** button

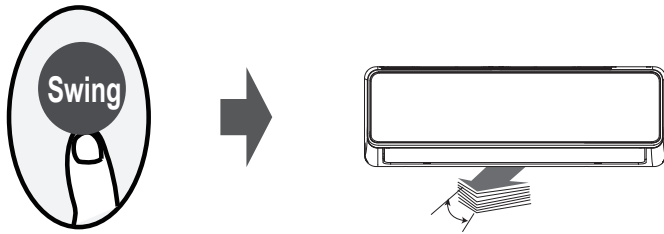

The horizontal louver will swing up and down automatically when pressing **SWING** button. Press it again to make it stop.

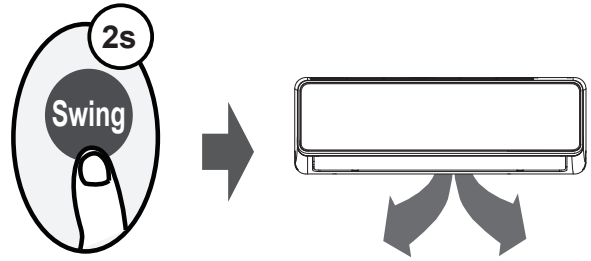

Keep pressing the **SWING** button more than 2 seconds, this will activate the vertical louver swing function (Model dependent).

Silence function

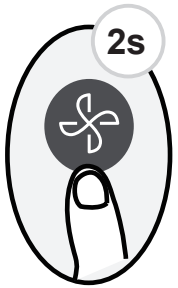

Pressing the **FAN** button for more than 2 seconds will activate or disable the Silence function (some units).

Due to low frequency operation of compressor, this function could result in insufficient cooling and heating capacity. Pressing the **ON/OFF, MODE, SLEEP, TURBO** or **CLEAN** button while the system is operating with the silence function activated will cancel it.

LED Display

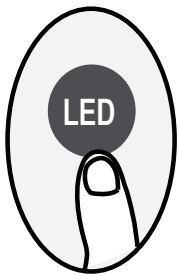

Press **LED** button

Press the **LED** button to either turn on or off the display on the indoor unit.

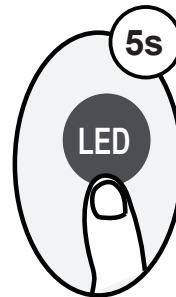

Press and hold the **LED** button more than 5 seconds (some units).

Press and hold the **LED** button more than 5 seconds, to make the display of the indoor unit show the actual room temperature. Press and hold the LED button for more than 5 seconds again and the display will revert back to the set temperature.

ECO function



Pressing the **ECO** button will enter the unit into energy efficiency mode.
NOTE: This function is only available under the COOL mode.

ECO operation:

Under **COOL** mode, press this button and the remote controller will automatically adjust the temperature to 75°F (24°C), fan speed off of **AUTO** to save energy. However, this only occurs when the set temperature is less than 75°F (24°C). If the set temperature is above 75°F (24°C), pressing the **ECO** button will cause the fan speed to change to **AUTO** and the set temperature will remain unchanged.

NOTE:

- Pressing the **ECO/GEAR** button, modifying the mode, or adjusting the set temperature to less than 75°F (24°C), will stop ECO operation.
- Under ECO operation, the set temperature should be 75°F (24°C) or above, or it may result in insufficient cooling. If the cooling feels insufficient, press the ECO button again to turn off this feature.

FP function

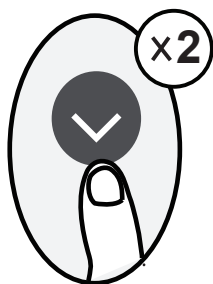

Using this function will cause the unit to operate with a high fan speed setting (while the compressor is on) with temperature automatically set to the lowest setting, 46°F (8°C), in order to achieve faster cooling.

NOTE: The function listed below is for heat pump air conditioners only.

Press the button 2 times within one second while in HEAT Mode and the temperature will be set to 60°F (16°C) or 68°F (20°C) (dependent on model) and the FP function will be activated.

Pressing the On/Off, Sleep, Mode, Fan or Temperature buttons while operating this function will cancel it.

LOCK function

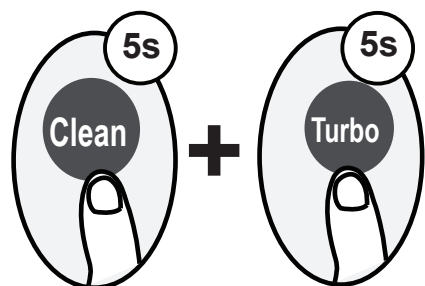

Pressing the **CLEAN** and **TURBO** buttons at the same time for more than 5 seconds will activate the **LOCK** function.

With this feature activated no buttons pressed will respond, except when these two buttons are pressed again for two seconds in order to disable the **LOCK** function.

SHORTCUT function

Press **SHORTCUT** button(some units) to revert to previous settings:

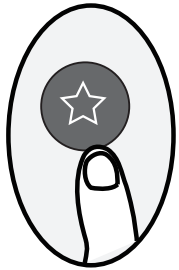

Pressing the **SHORTCUT** button when the remote controller is on will cause the system to automatically revert back to the previous settings including the operating mode, set temperature, fan speed level, and the sleep feature (if activated).

If the **SHORTCUT** button is pressed for more than 2 seconds, the system will automatically restore the current operation settings including the operating mode, set temperature, fan speed level and sleep feature (if activated).

Clean Function

Press **CLEAN** button



Airborne bacteria can grow in the moisture that condenses around heat exchanger in the unit. With regular use, most of this moisture is evaporated from the unit. By pressing the **CLEAN** button, your unit will clean itself automatically. After cleaning has been completed, the unit will turn off automatically. Pressing the **CLEAN** button mid-cycle will cancel the operation and turn off the unit. You can use the **CLEAN** function as often as you like.

NOTE: You can only activate this function in COOL or DRY mode.

TURBO Function

Press **TURBO** button



When the TURBO button is pressed while the unit is in COOL mode, the unit will blow cool air with highest fan setting to speed up the cooling process.

When the TURBO button is pressed while the unit is in HEAT mode, for units with electric heat elements, the electric heater will activate and speed up the heating process.

SET function

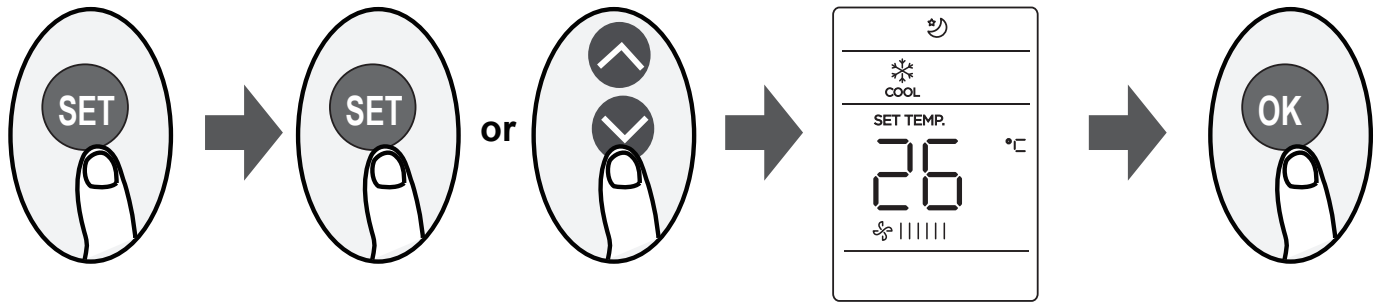

- Press the **SET** button to enter the function setting, then press the **SET** button or the **TEMP** ∇ or \blacktriangle buttons to select the desired function. The selected symbol will flash on the display, press the **OK** button to confirm and this will activate the selected function.
- To cancel the selected function, just perform the same procedures as above.
- Press the **SET** button to scroll through operation functions as follows:
Sleep* (🌙) → **Follow Me** (👤) → **AP mode** (📶)

[*]: If your remote controller has a Sleep button, you cannot use the SET button to select the Sleep feature.

Sleep function (🌙):

The **SLEEP** function is used to decrease energy use while you sleep (temperature settings needed to stay comfortable during sleep differ from the settings needed while awake). This function can only be activated via the remote control.

For further details, please refer to the **Sleep Operation** section of your unit's **USER MANUAL**.

NOTE: The SLEEP function is not available in FAN or DRY mode.

AP function (📶) (some units):

Choose **AP** mode to use the wireless network configuration. For some units, it does not work by pressing the **SET** button. To enter the AP mode, continuously press the **LED** button seven times within 10 seconds.

Follow me function (👤):

The **FOLLOW ME** function enables the remote control to measure the temperature at the location it currently is and send this signal to the air conditioning unit in a 3 minute interval. When using **AUTO**, **COOL**, or **HEAT** modes, measuring the ambient temperature from the remote control (instead of from the indoor unit itself) will enable the air conditioner to optimize the temperature where you currently are and ensure maximum comfort.

NOTE: Press and hold the TURBO button for seven seconds to start or stop the memory feature of the FOLLOW ME function.

- If the memory feature is activated, "ON" will display for 3 seconds on the screen.
- If the memory feature is stopped, "OF" will display for 3 seconds on the screen.
- While the memory feature is activated, press the ON/OFF button, shift the mode or power failure will not cancel the Follow Me function.

Buttons and Functions

Before you begin using your new air conditioner, make sure to familiarize yourself with its remote control. The following is a brief introduction to the remote control itself. For instructions on how to operate your air conditioner, refer to the **How to Use Basic Functions** section of this manual.

ON/OFF
Turns the unit on or off.

TEMP ^
Increases temperature in 1°F (1°C) increments. Maximum Temperature setting is 86°F (30°C).
NOTE: Pressing the ∨ & ^ buttons together for 3 seconds will alternate the temperature display between °C & °F.

SET
Scrolls through operation functions in following sequence:
Breeze Away (🌀) → **Active Clean** (🌀) → **Follow Me** (👤) → **AP Mode** (📶)
The selected symbol will flash on the display window, press the OK button to confirm.

TEMP ∨
Decreases temperature in 1°F (0.5°C) increments. Minimum temperature setting is 60°F (16°C).

FAN SPEED
Selects fan speeds in the following sequence:
AU → **20%** → **40%** → **60%** → **80%** → **100%**

Press the **TEMP ∨** or **^** button to increase or decrease the fan speed in 1% increments.

SWING
Starts and stops the horizontal louver movement.

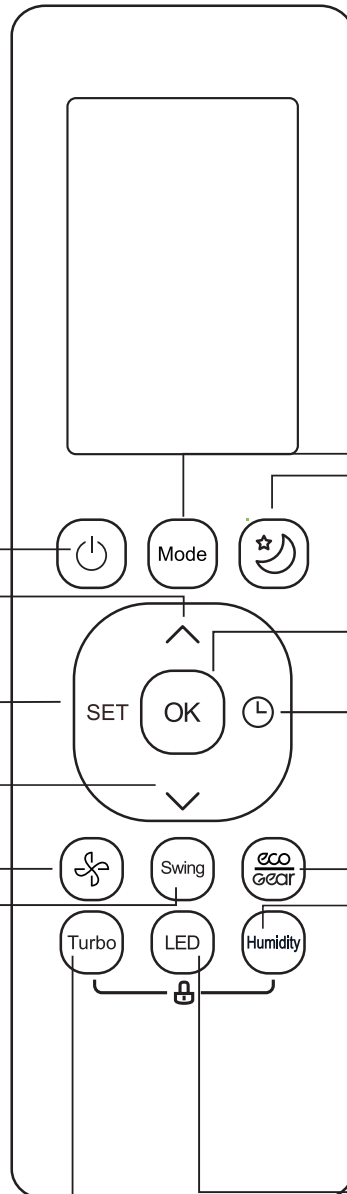

MODE
Scrolls through operation modes in the following sequence:

AUTO → **COOL** → **DRY** → **HEAT** → **FAN**
NOTE: HEAT mode is not supported by the cooling-only version.

SLEEP
Saves energy during sleeping hours.

OK
Used to confirm the selected functions.

TIMER
Used to set the timer to turn the unit on or off at a specified time.

ECO/GEAR
Press this button to enter the energy efficient modes which can be selected in the following sequence:
ECO → **GEAR (75%)** → **GEAR (50%)** → **Previous setting mode** → **ECO**

HUMIDITY
Adjusts the room humidity during **DRY** operation within a range 35%~85%. Press this button to increase the humidity in 5% increments.
NOTE: After setting the humidity, the humidity settings will display on the screen.

LED
Turns the indoor unit's LED display and air conditioner buzzer on and off (model dependent), to create a quiet environment.

TURBO
Enables unit to reach the preset temperature in the shortest possible time.

Remote Screen Indicators

Information that is displayed when the remote controller is turned on.

- Not applicable for this unit
- Not applicable for this unit
- Not applicable for this unit
- Not applicable for this unit
- Not applicable for this unit

- Breeze Away display (some units)
- Active clean feature display
- Sleep mode display
- Follow me feature display
- Wireless control feature display (some units)
- Low battery detection display (If flashes)

Transmission:

This indicator lights up when the remote transmits a signal to the indoor unit.

ON

TIMER ON display

OFF

TIMER OFF display

Silence:

This indicator lights up when the Silence function is activated.

FAN SPEED:

Displays selected fan speed:

Silence

LOW		1%
		2%-20%
MED		21%-40%
		41%-60%
HIGH		61%-80%
		81%-100%
AUTO		AUTO

NOTE: The fan speed cannot be adjusted in AUTO or DRY mode.

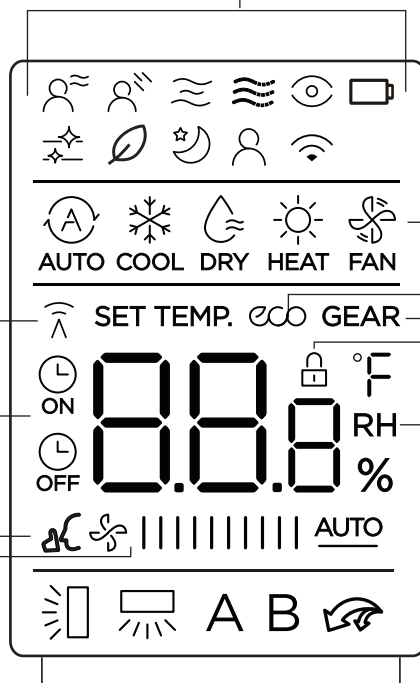

MODE display

Displays the current mode, including:



ECO display

Displays when ECO feature is activated

GEAR display

Displays when GEAR feature is activated

LOCK display

Displays when LOCK feature is activated

Temperature/Timer/Fan speed display

Displays the set temperature by default, or fan speed or timer setting when using **TIMER ON/OFF** functions.

- Temperature range: 60-86°F (16-30°C) (model dependent)
- Timer setting range: 0-24 hours
- Fan speed setting range: AU - 100%
- Humidity setting range: 35%-85%

This display is blank when operating in **FAN** mode.

Horizontal louver swing display

Vertical louver
Not applicable for this unit.

TURBO MODE display

A Not available for this unit.
B Not available for this unit.

NOTE: All indicators shown are for demonstration purposes. During actual operation, only the relative and active functions will be shown in the display window.

How to Use Basic Functions

! ATTENTION

Please ensure the unit is plugged in and power is available before operation.

AUTO Mode

Select **AUTO** mode



Set your desired temperature



Turn on the air conditioner



NOTE:

- In **AUTO** mode, the unit will automatically select **COOL**, **FAN**, or **HEAT** function based on the set temperature.
- In **AUTO** mode, fan speed cannot be set or adjusted by the user.

COOL or HEAT Mode

Select **COOL/HEAT** mode

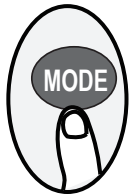

Set the temperature



Set the fan speed



Turn on the air conditioner



DRY Mode

Select **DRY** mode

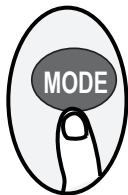

Set your desired temperature



Turn on the air conditioner



NOTE: In **DRY** mode, fan speed cannot be set because it is automatically controlled.

FAN Mode

Select **FAN** mode

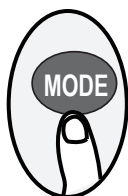

Set the fan speed



Turn on the air conditioner



NOTE: In **FAN** mode, the temperature cannot be set or adjusted. As a result, no temperature reading will display on the remote screen.

Setting the Timer

Setting the TIMER

TIMER ON/OFF - Set the amount of time after which the unit will automatically turn on/off.

TIMER ON setting

Press **TIMER** button to initiate the **ON** time sequence.



Press **Temperature UP or DOWN** button to set the desired time to turn **ON** the unit.

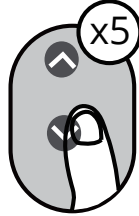

Point remote control at the unit and wait 1 second, the **TIMER ON** will be activated.

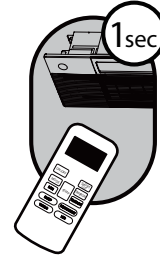

TIMER OFF setting

Press **TIMER** button to initiate the **OFF** time sequence.

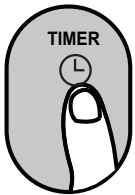

Press **Temperature UP or DOWN** button to set the desired time to turn **OFF** the unit.

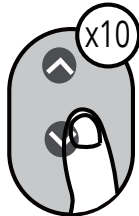

Point remote control at the unit and wait 1 sec, the **TIMER OFF** will be activated.



NOTE:

- When setting the **TIMER ON** or **TIMER OFF**, the time will increase by 30 minutes increments with each press, up to 10 hours. After 10 hours and up to 24, it will increase in 1 hour increments. (For example, press 5 times to get 2.5h, and press 10 times to get 5h,) The timer will revert to 0.0 after 24.
- Cancel either function by setting its timer to 0.0h.

TIMER ON & OFF setting (example)

NOTE: Keep in mind that the time periods you set for both functions refer to hours after the current time.

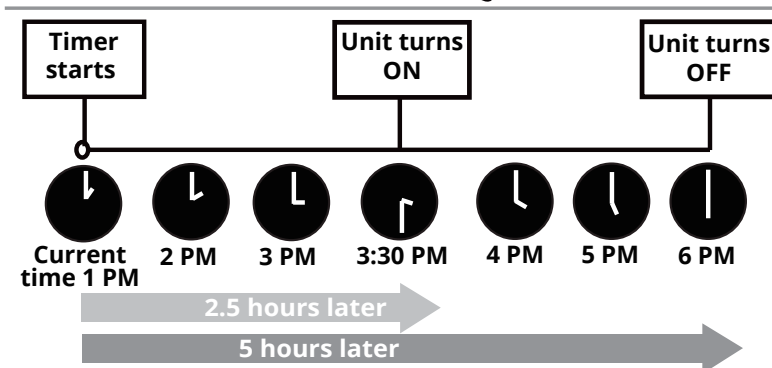
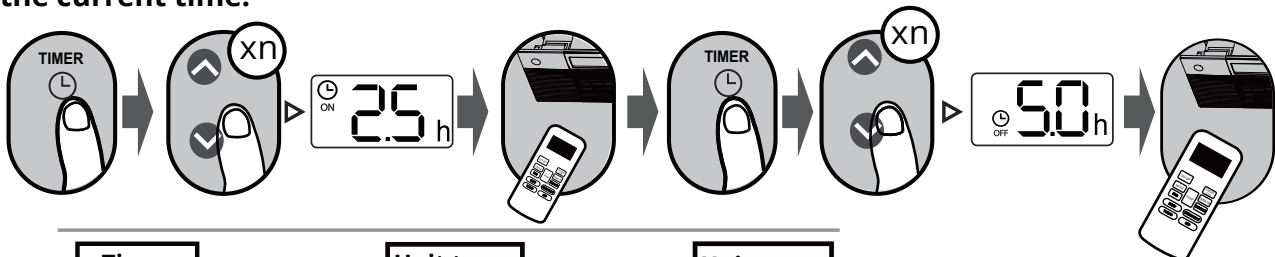

Example: If current time is 1:00PM, and the timer is set using the above steps, the unit will turn on 2.5 hours later (3:30PM) and then turn off at 6:00PM (5 hours after the timer is originally set).

How to Use Advanced Functions

Swing function

Press the **SWING** button

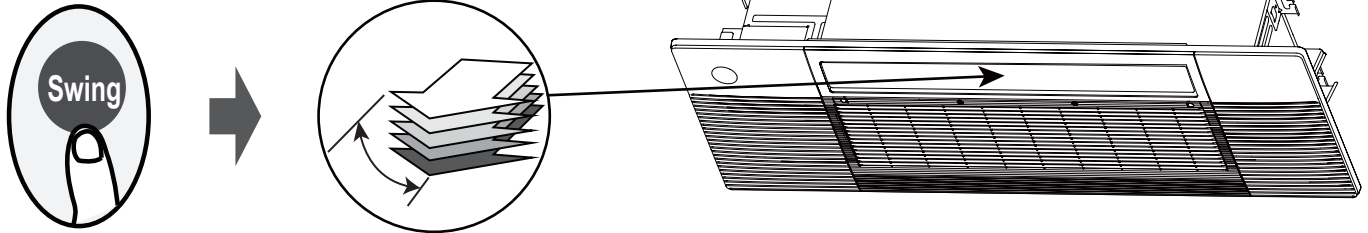

The horizontal louver will swing up and down automatically when pressing **SWING** button. Press it again to make it stop.

Airflow direction

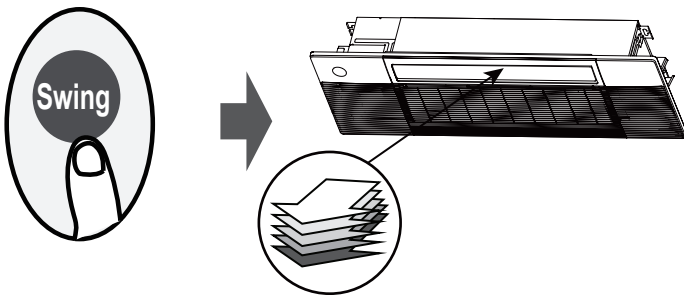

If continue to press the **SWING** button, five different airflow directions can be set. The louver can be moved to a different angle each time you press the button. Continue pressing the button until the desired setting is reached.

LED Display



Press **LED** button

Press the **LED** button to either turn on or off the display on the indoor unit.

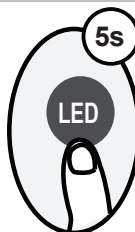

Press and hold the **LED** button more than 5 seconds (some units).

Press and hold the **LED** button for 5 seconds, to make the display of the indoor unit show the actual room temperature. Press and hold the **LED** button for more than 5 seconds again and the display will revert back to the set temperature.

Panel Drop (Air Filter Maintenance)

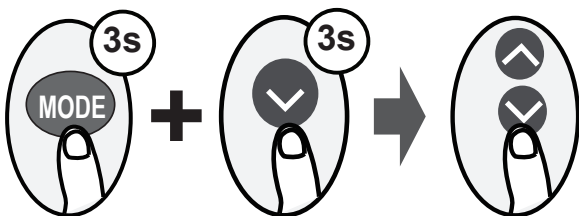

Access to the air filter for cleaning/maintenance requires the air intake panel to be lowered using the remote control. With the unit in stand-by mode, press and hold the **MODE** and **DOWN** buttons simultaneously for 3 seconds. This will access the panel setting mode. The remote controller should display **F2**. Then, use the **UP** or **DOWN** buttons to raise or lower the air intake panel. Press any button to exit the panel setting mode. For more detailed information regarding filter maintenance, please refer to the **Care & Maintenance** section in the **DIY® Ceiling Cassette Owner's Manual**.

Air Intake Panel

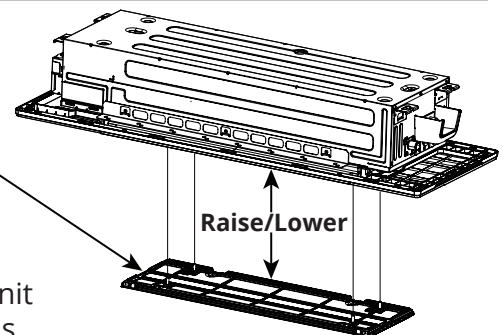

ECO/GEAR function



Pressing the **ECO/GEAR** button will allow you to select the energy efficiency modes in the following sequence:

ECO → GEAR (75%) → GEAR (50%) → Previous setting mode → ECO.....

NOTE: This function is only available under the COOL mode.

ECO operation:

Under **COOL** mode, press this button and the remote controller will automatically adjust the temperature to 75°F (24°C), fan speed off of **AUTO** to save energy. However, this only occurs when the set temperature is less than 75°F (24°C). If the set temperature is above 75°F (24°C), pressing the **ECO** button will cause the fan speed to change to **AUTO** and the set temperature will remain unchanged.

NOTE:

- Pressing the **ECO/GEAR** button, modifying the mode, or adjusting the set temperature to less than 75°F (24°C), will stop ECO operation.
- Under ECO operation, the set temperature should be 75°F (24°C) or above, or it may result in insufficient cooling. If the cooling feels insufficient, press the ECO button again to turn off this feature.

GEAR operation:

Press the **ECO/GEAR** button to enter the **GEAR** operation as following:

75% (up to 75% electrical energy consumption)



50% (up to 50% electrical energy consumption)



Previous setting mode.

Under **GEAR** operation, the display on the remote controller will alternate between electrical energy consumption reading and the set temperature.

Silence function

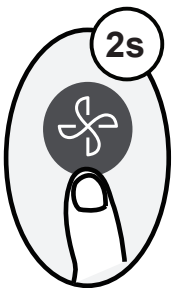

Pressing the **FAN** button for more than 2 seconds will activate or disable the Silence function (some units).

Due to low frequency operation of compressor, this function could result in insufficient cooling and heating capacity. Pressing the **ON/OFF, MODE, SLEEP, TURBO** or **CLEAN** button while the system is operating with the silence function activated will cancel it.

How To Use Advanced Functions

FP function

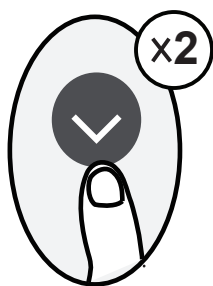

Using this function will cause the unit to operate with a high fan speed setting (while the compressor is on) with temperature automatically set to the lowest setting, 46°F (8°C), in order to achieve faster cooling.

NOTE: The function listed below is for heat pump air conditioners only.

Press the button 2 times within one second while in HEAT Mode and the temperature will be set to 60°F (16°C) and the FP function will be activated.

Pressing the On/Off, Sleep, Mode, Fan or Temperature buttons while operating this function will cancel it.

LOCK function

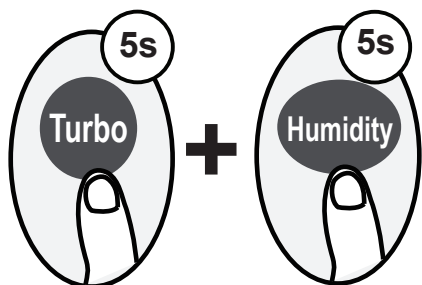

Pressing the **TURBO** and **HUMIDITY** buttons at the same time for more than 5 seconds will activate the **LOCK** function.

With this feature activated no buttons pressed will respond, except when these two buttons are pressed again for two seconds in order to disable the **LOCK** function.

Sleep Function

Press **SLEEP** button



The **SLEEP** function is used to decrease energy use while you sleep (temperature settings needed to stay comfortable during sleep differ from the settings needed while awake). This function can only be activated via the remote control.

For further details, please refer to the **Sleep Operation** section of your unit's **USER MANUAL**.

NOTE: The SLEEP function is not available in FAN or DRY mode.

TURBO Function

Press **TURBO** button



When the TURBO button is pressed while the unit is in COOL mode, the unit will blow cool air with the highest fan setting to speed up the cooling process.

When the TURBO button is pressed while the unit is in HEAT mode, the unit will blow warm air with the highest fan setting to speed up the heating process (some units). For units with electric heat elements, the electric heater will activate and speed up the heating process.

SET function

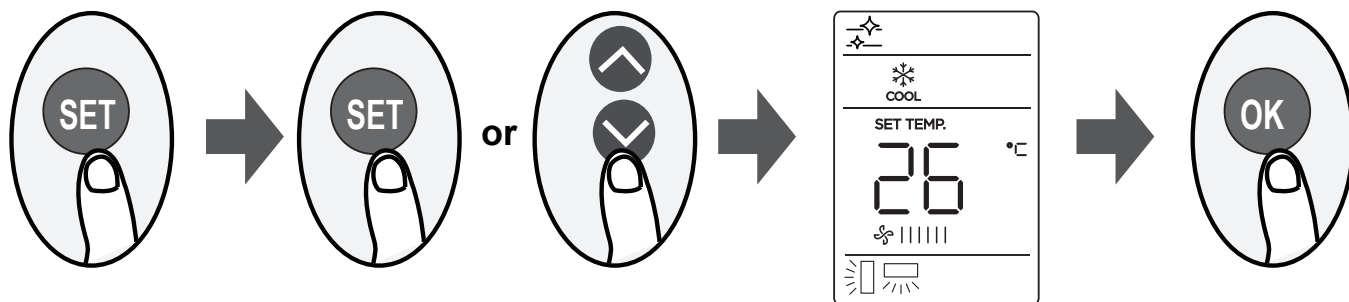

- Press the **SET** button to enter the function setting, then press the **SET** button or the **TEMP** \downarrow or \uparrow buttons to select the desired function. The selected symbol will flash on the display, press the **OK** button to confirm and this will activate the selected function.
- To cancel the selected function, just perform the same procedures as above.
- Press the **SET** button to scroll through operation functions as follows:

Breeze Away* (🌀) → **Active Clean/Self Clean** (🧼) → **Follow Me** (👤) → **AP mode*** (📶) →

[*]: Model Dependent

Breeze Away function (🌀) (some units):

This feature keeps airflow from being blown directly on the occupants of the room.

NOTE: This feature is available under COOL, FAN and DRY modes only.

Active Clean function (🧼) (some units):

The **ACTIVE CLEAN** function of this unit washes away dust, mold, and grease that can accumulate on the heat exchanger. This accumulation of debris can reduce the efficiency of the unit. The Active Clean functions works by causing the unit to operate in such a way to increase condensate production and then freezing it. It then rapidly thaws the condensate frost to clean the heat exchanger as it drains from the unit. When this function is activated "CL" will appear in the display window. After a duration of 20 to 45 minutes, the unit will turn off automatically and cancel the Active Clean function.

AP function (📶) (some units):

Choose **AP** mode to use the wireless network configuration. For some units, it does not work by pressing the **SET** button. To enter the AP mode, continuously press the **LED** button seven times within 10 seconds.

Follow me function (👤):

The **FOLLOW ME** function enables the remote control to measure the temperature at the location it currently is and send this signal to the air conditioning unit in a 3 minute interval. When using **AUTO, COOL, or HEAT** modes, measuring the ambient temperature from the remote control (instead of from the indoor unit itself) will enable the air conditioner to optimize the temperature where you currently are and ensure maximum comfort.

NOTE: Press and hold the TURBO button for seven seconds to start or stop the memory feature of the FOLLOW ME function.

- **If the memory feature is activated, "ON" will display for 3 seconds on the screen.**
- **If the memory feature is stopped, "OF" will display for 3 seconds on the screen.**
- **While the memory feature is activated, press the ON/OFF button, shift the mode or power failure will not cancel the Follow Me function.**



MRCOOL®

COMFORT MADE SIMPLE

Due to updates and constantly improving performance, the information and instructions within this manual are subject to change without notice. Please visit www.mrcool.com/documentation to ensure you have the latest version of this manual.

Version Date: 08-11-22