

# WE MAKE SUMMER

## RESIDENTIAL PARASOL





## **Introduction**

Specialist for Parasols

page 2

---

# **MAY** SIDE-POST PARASOLS

## **MEZZO**

page 6

---

## **DACAPO**

page 22

---

## **Installation Options**

page 32

---

## **Cloth Collection**

Fabrics and Colours, Borders, Product Properties

page 44

---

## **Informationen on MAY**

Clean Energy

page 54

The Team

page 56

A Family Enterprise

page 58

### **Premium parasols**

Since more than 30 years creative concepts have been transferred consequently into technical solutions. The result: multi-purpose parasols, used and proven, day by day, worldwide. The experience gained by our long-time employees has contributed to the consistently high standard of all our company objectives – from the manufacturing process to customer service.

### **Made in Germany**

This seal of quality has been established a long time ago by the high production depth of German manufacturers. Here, this is still consequently in practice. Every year there are additional employees hired and the machinery gets extended and updated. The in-house sewing department uses cutting automats and industrial sewing machines for the fitted canopy production. At the metal working, 15 CNC machines ensure highest precision. The MAY family stays for the “Made in Germany” production, there is no dilution of this seal of quality. The customer gets products that are really fully produced in Betzenweiler, Germany.

Satisfied customers and the pleasure of mutually carving a way to success – that is what motivates us anew every day. Please, allow yourself some time for this catalogue and enjoy the year outdoors with our MAY parasols.

# SMALL

**DETAILS THAT MAKE  
A GREAT DIFFERENCE**

**Designed in Germany**

**Manufactured in Germany**

**Tried and proven in the whole  
world**

**Made in Germany**





# MAY

SPECIALIST  
FOR PARASOLS





MEZZO



# EXCLUSIVE

## SIDE-POST PARASOL

Exclusive

Stylish

Designer parasol grouping

Optional pivot system





# MEZZO



MEZZO Ø 3.0 m  
MayTex-Acryl SA 314 143 mallow





MEZZO MH Ø 3.0 m, with canopy bonnet, 1 bonnet  
MayTex-Acryl SA 314 033 ivory





MEZZO MH Ø 3.0 m, with canopy bonnet, 4 bonnets  
MayTex-Acryl SA 314 033 ivory

**MEZZO**







### Crank drive

With the help of a hand crank MEZZO can be opened and closed, positioned and locked in next to no time.

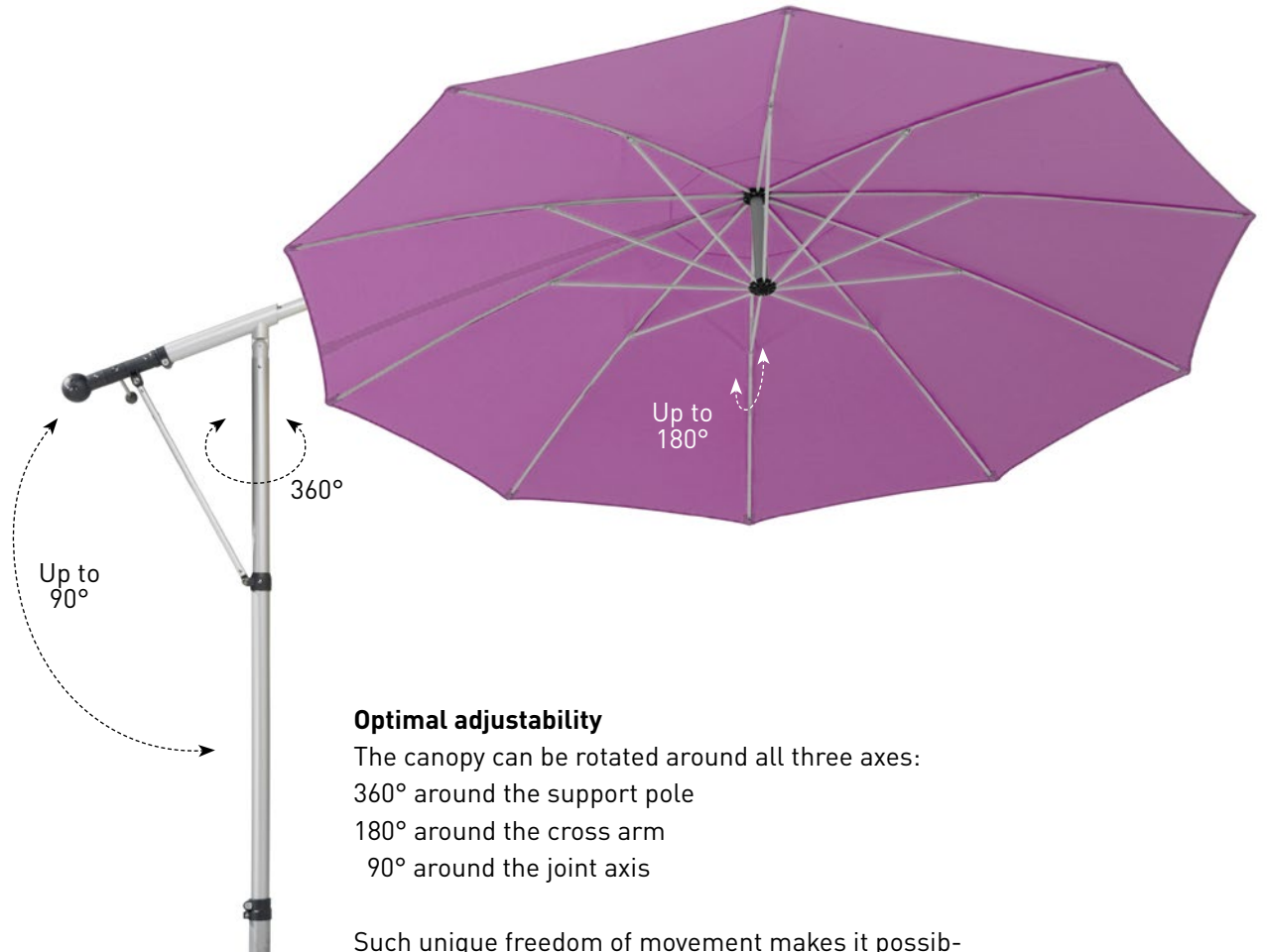

### Optimal adjustability

The canopy can be rotated around all three axes:  
360° around the support pole  
180° around the cross arm  
90° around the joint axis

Such unique freedom of movement makes it possible for the user to adjust the parasol to the changing position of the sun or to use it as a protective screen.

### When not in use

The protective cover provided can easily be slipped over the shade during bad weather periods.



## MEZZO MG – Standard model

### Stability while in use

The practical MEZZO canopy lock allows the user to open and close the parasol when it is in an inclined position and prevents the canopy from swinging in the wind.

### High-quality framework materials

The poles of our parasols are all made of high-quality alloyed, extruded aluminium profiles. Frame surfaces are anodized, highly impact-proof, and available in the colour EV1 natural silver-grey. The spokes are of spring steel and powder-coated, available in white aluminium RAL 9006.



Stability while in use

### Valance options



straight valance



without valance

### Canopy covering

For fabrics and colours cf. page 46 onwards.

### Installation options

mobile see page 35, stationary see page 40.



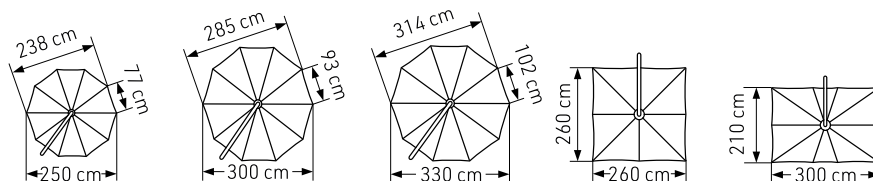

MEZZO standard model MG			Ø 2.5 m	Ø 3.0 m	Ø 3.3 m <sup>1)</sup>	2.6 × 2.6 m	2.1 × 3.0 m <sup>2)</sup>
Segments			10	10	10	8	10
Area	m <sup>2</sup>		4,6	6,6	8	6,75	6,25
<b>A</b>	without / with valance	cm	203 / 213	192 / 202	208	214	209
<b>B</b>	without / with valance	cm	259	259	268	268	268
<b>C</b>	without / with valance	cm	349 / 359	366 / 376	396	370	352
<b>D</b>	without / with valance	cm	134 / 144	105 / 115	97	129	149
<b>E</b>		cm	157	157	169	158	157
<b>F</b>		cm	277	301	328	285	266
<b>G</b>		cm	55	55	55	55	55
<b>H</b>		cm	90	90	90	90	90
<b>I</b>	without / with valance	cm	182 / 192	182 / 192	192	192	192
<b>K</b>	without / with valance	cm	258	258	278	268	268
<b>L</b>	without / with valance	cm	30	30	38	38	38
<b>M</b>	without / with valance	cm	121 / 131	98 / 108	99	69	69
<b>P</b>	without / with valance	cm	112 / 122	86 / 96	82	50	50
	Weight without packaging	kg	16	17	18	16	16
<b>Q</b>	Support pole diameter	mm	outer-Ø 55, pole thickness 3				
	Packaging		rectangular cardboard box: l= 290 cm, w= 32 cm, h= 18 cm, approx. 3 kg				
	Installation base length/width/min. depth	cm	50 / 50 / 60				
	Minimum-ballast Number of layers of concrete slabs XZ40 required		1 x = approx. 72 kg				

<sup>1)</sup> Additional pedestal weight may be required for windy locations (upwind, sloping sites and so on). Do not use granite base. Pedestals require 2 sets of concrete slabs.

<sup>2)</sup> The canopy is vaulted, so that the corner spokes are approx. 9 -18 cm lower than the centre spokes. (see sketch)

Dimensional tolerance approx. 5%.

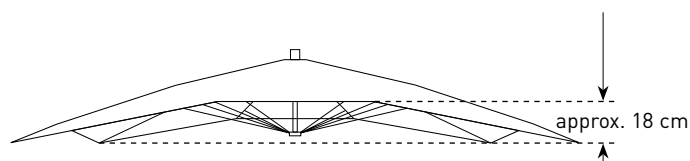

**N** The heights specified are for parasols with MayTex-Acryl covering fabric that are mounted in an anchor tube (DMZ118, DMZ146). The increase in height for parasols with other installation bases can be seen in the list below:

Cross pedestal: DMZ110 + 6 cm  
 Full frame pedestal: DMZ411 + 9 cm  
 Full frame pedestal: DMZ412 + 12 cm  
 Full frame pedestal: DMZ414 + 16 cm  
 Full frame pedestal: DMZ420 + 19 cm

Granite base: DMZ141 + 10 cm  
 Wheeled pedestal: DMZ282 + 14/15 cm  
 Anchor plate: DMZ261 + 4 cm  
 Base plate: DMZ271 + 12 cm

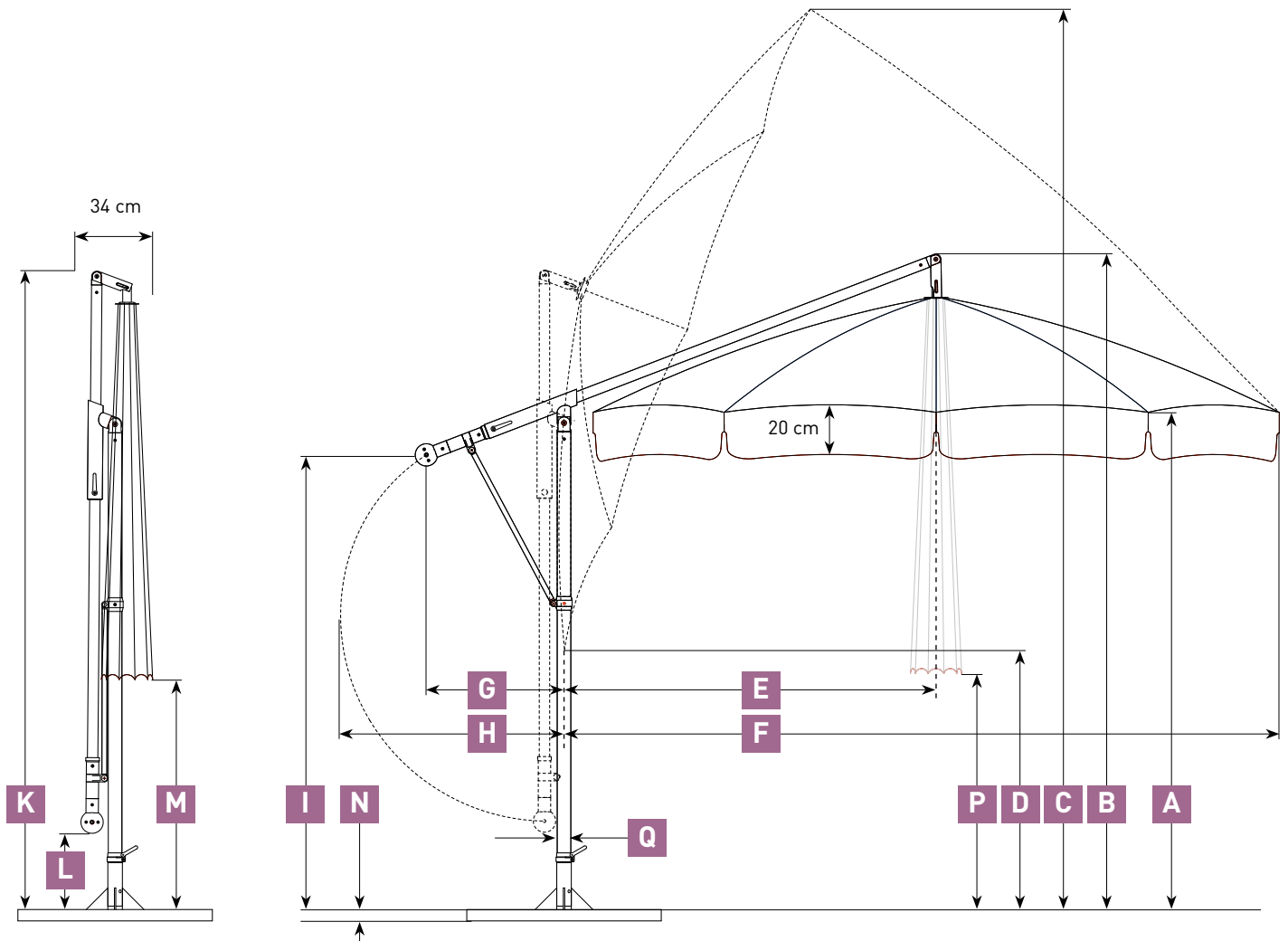

### 1 Adjustable to suit your individual needs

No matter where the sun is, the parasol canopy can be tilted at any angle for shade and protection, then locked.

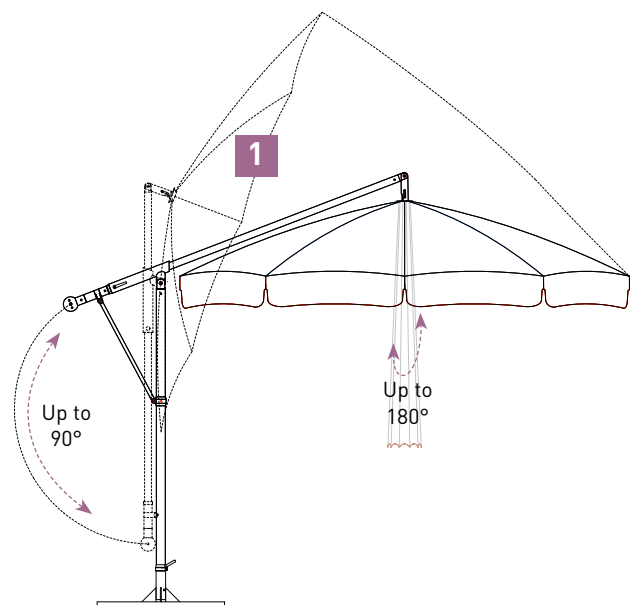

MEZZO MH 2.6 × 2.6 m,  
MayTex-Acryl SA 314 044 grey-white

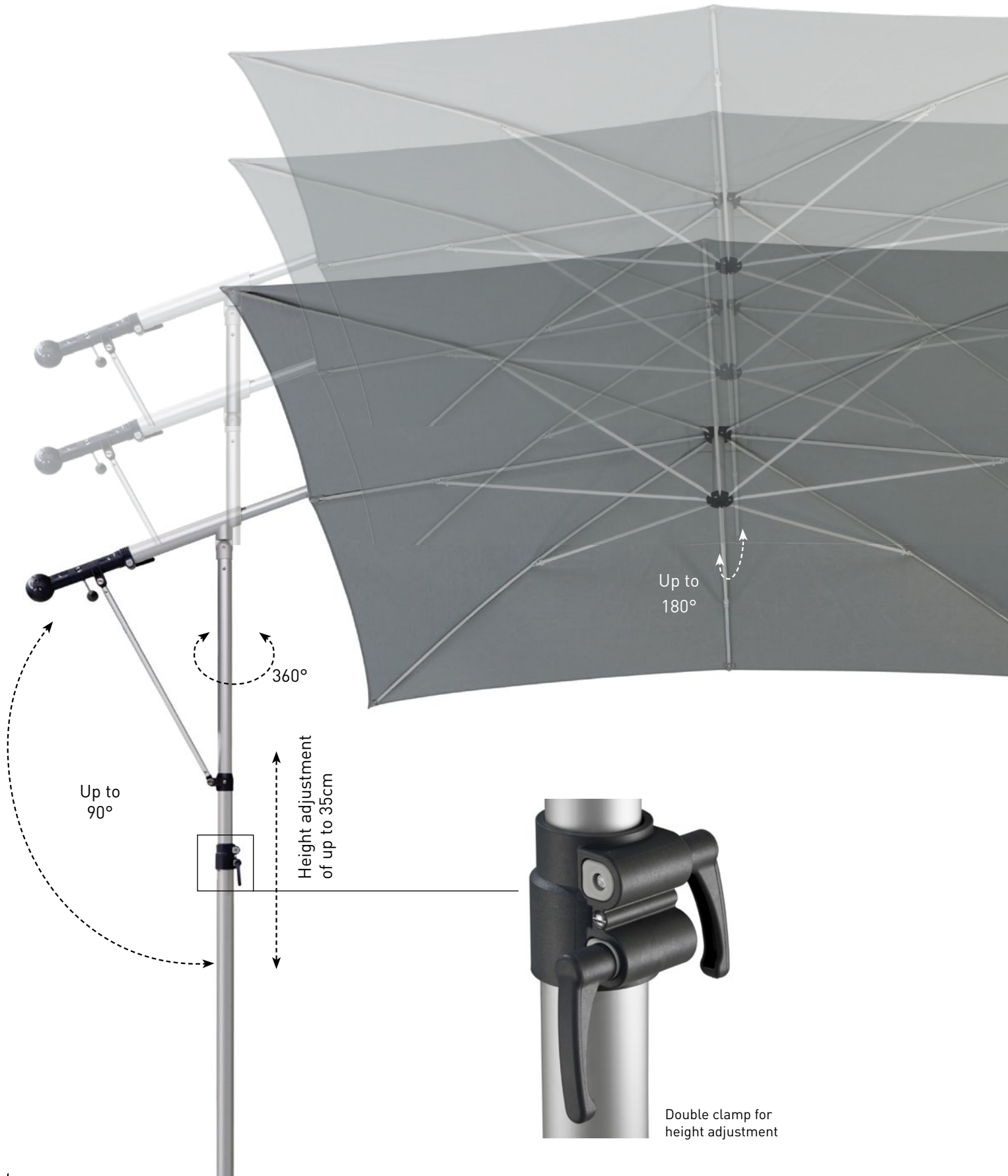

Up to  
90°

360°

Up to  
180°

Height adjustment  
of up to 35cm

Double clamp for  
height adjustment



### **MEZZO MH – with height adjustment**

More functions – more benefits! Our model MEZZO MH not only has the standard functions of MEZZO MG, it also offers the possibility of effortless height adjustment. Thanks to a pneumatic spring incorporated in the support pole, the physical strength needed to raise or lower the parasol is effectively reduced to a minimum.



### **Ergonomic handling**

The operational mechanism of the parasol is conveniently positioned and can easily be adjusted to suit the height of your choice.

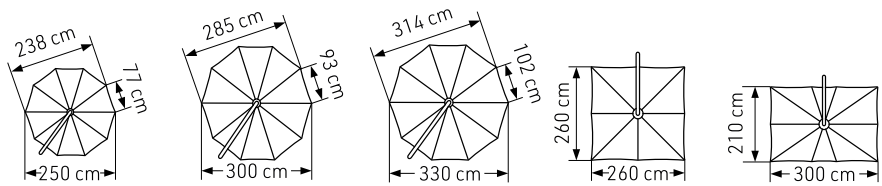

MEZZO model MH			Ø 2,5 m	Ø 3,0 m	Ø 3,3 m <sup>2)</sup>	2,6 × 2,6 m	2,1 × 3,0 m <sup>3)</sup>
	Segments		10	10	10	8	10
	Area	m <sup>2</sup>	4,6	6,6	8	6,75	6,25
<b>A<sup>1)</sup></b>	min. / max.	cm	188 / 223	176 / 211	175 / 210	178 / 213	181 / 216
<b>B</b>	min. / max.	cm	241 / 276	238 / 273	240 / 275	238 / 273	238 / 273
<b>C</b>	min. / max.	cm	335 / 370	352 / 387	371 / 405	340 / 375	321 / 356
<b>D<sup>1)</sup></b>	min. / max.	cm	110 / 145	85 / 120	79 / 114	102 / 137	125 / 160
<b>E</b>		cm	160	160	166	160	160
<b>F</b>		cm	285	300	328	282	264
<b>G</b>		cm	55	55	55	55	55
<b>H</b>		cm	90	90	90	90	90
<b>I</b>	min. / max.	cm	165 / 200	165 / 200	165 / 200	165 / 200	165 / 200
<b>K</b>	min. / max.	cm	241 / 276	241 / 276	250 / 285	241 / 276	241 / 276
<b>L</b>	min. / max.	cm	11 / 46	11 / 46	11 / 46	11 / 46	11 / 46
<b>M<sup>1)</sup></b>	min. / max.	cm	102 / 137	75 / 110	72 / 107	42 / 77	42 / 77
<b>P<sup>1)</sup></b>	min. / max.	cm	90 / 125	65 / 100	51 / 86	25 / 58	22 / 57
	Weight without packaging	kg	18	19	20	18	18
<b>Q</b>	Support pole diameter	mm	outer-Ø 55, pole thickness 3				
	Packaging		rectangular cardboard box: l= 270 cm, w= 32 cm, h= 18 cm, approx. 3 kg				
	Installation base length/width/min. depth	cm	50 / 50 / 60				
	Minimum-ballast Number of layers of concrete slabs XZ40 required		1 x = approx. 72 kg				

<sup>1)</sup> Sizes without valance: with valance less 20 cm.

<sup>2)</sup> Additional pedestal weight may be required for windy locations (upwind, sloping sites and so on). Do not use granite base. Pedestals require 2 sets of concrete slabs.

<sup>3)</sup> The canopy is vaulted, so that the corner spokes are approx. 9 – 18 cm lower than the centre spokes. (cf. sketch)

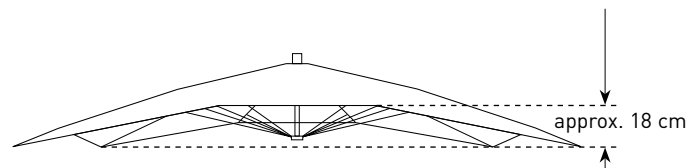

Dimensional tolerance approx. 5%.

**N** The heights specified are for parasols with MayTex-Acryl covering fabric that are mounted in an anchor tube (DMZ118, DMZ146). The increase in height for parasols with other installation bases can be seen in the list below:

Cross pedestal:	DMZ110 + 6 cm	Granite base:	DMZ141 + 10 cm
Full frame pedestal:	DMZ411 + 9 cm	Wheeled pedestal:	DMZ282 + 14 / 15 cm
Full frame pedestal:	DMZ412 + 12 cm	Anchor plate:	DMZ261 + 4 cm
Full frame pedestal:	DMZ414 + 16 cm	Base plate:	DMZ271 + 12 cm
Full frame pedestal:	DMZ420 + 19 cm		

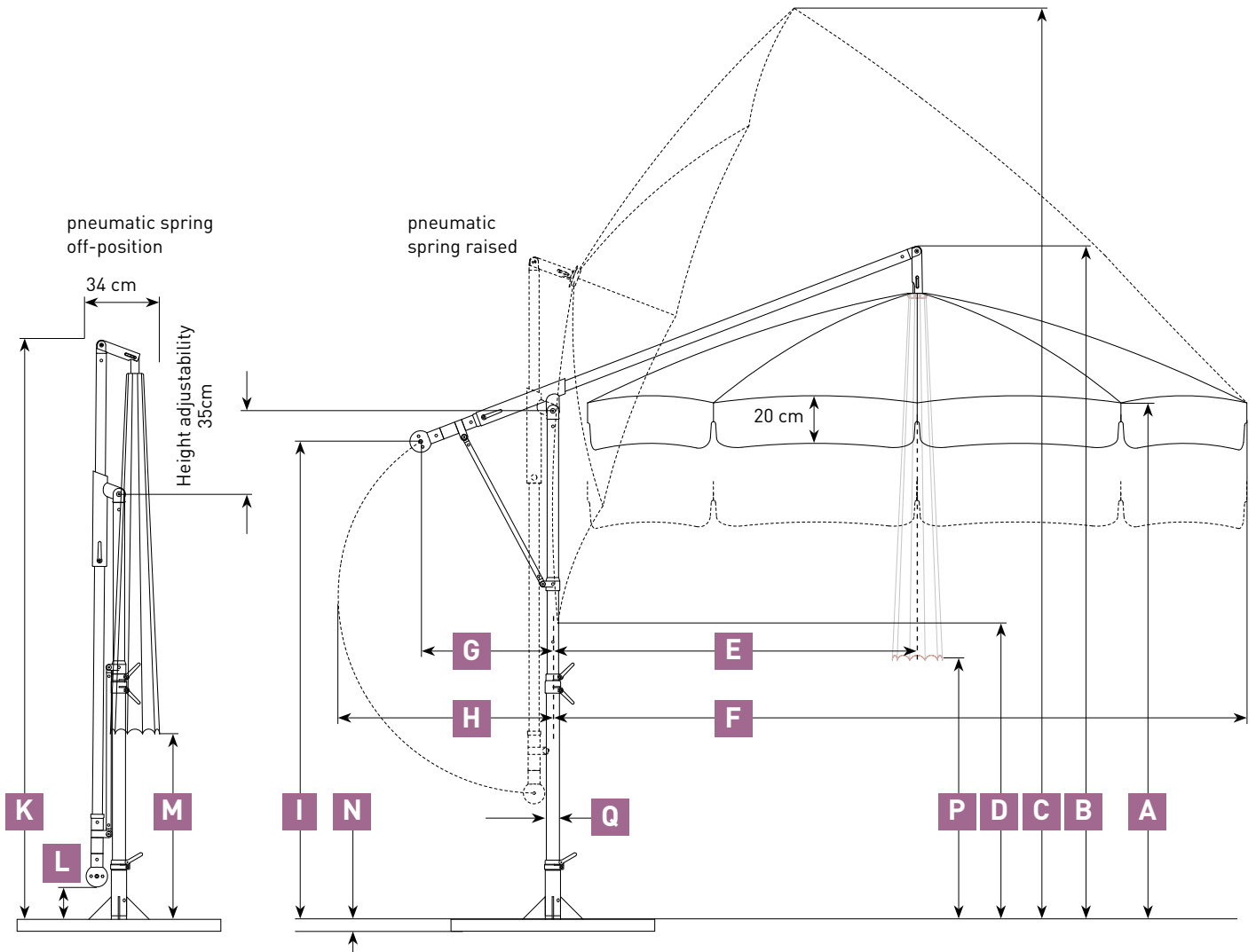

### Adjustable to suit your individual needs

- 1** No matter where the sun is, the parasol canopy can be tilted at any angle for shade and protection, then locked.
- 2** Effortless height adjustment thanks to standard incorporation of a pneumatic spring in the support pole (MH).

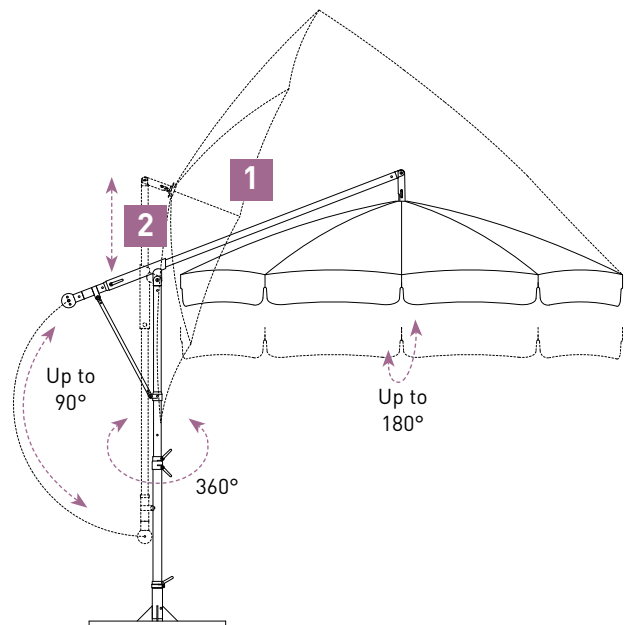



DACAPO

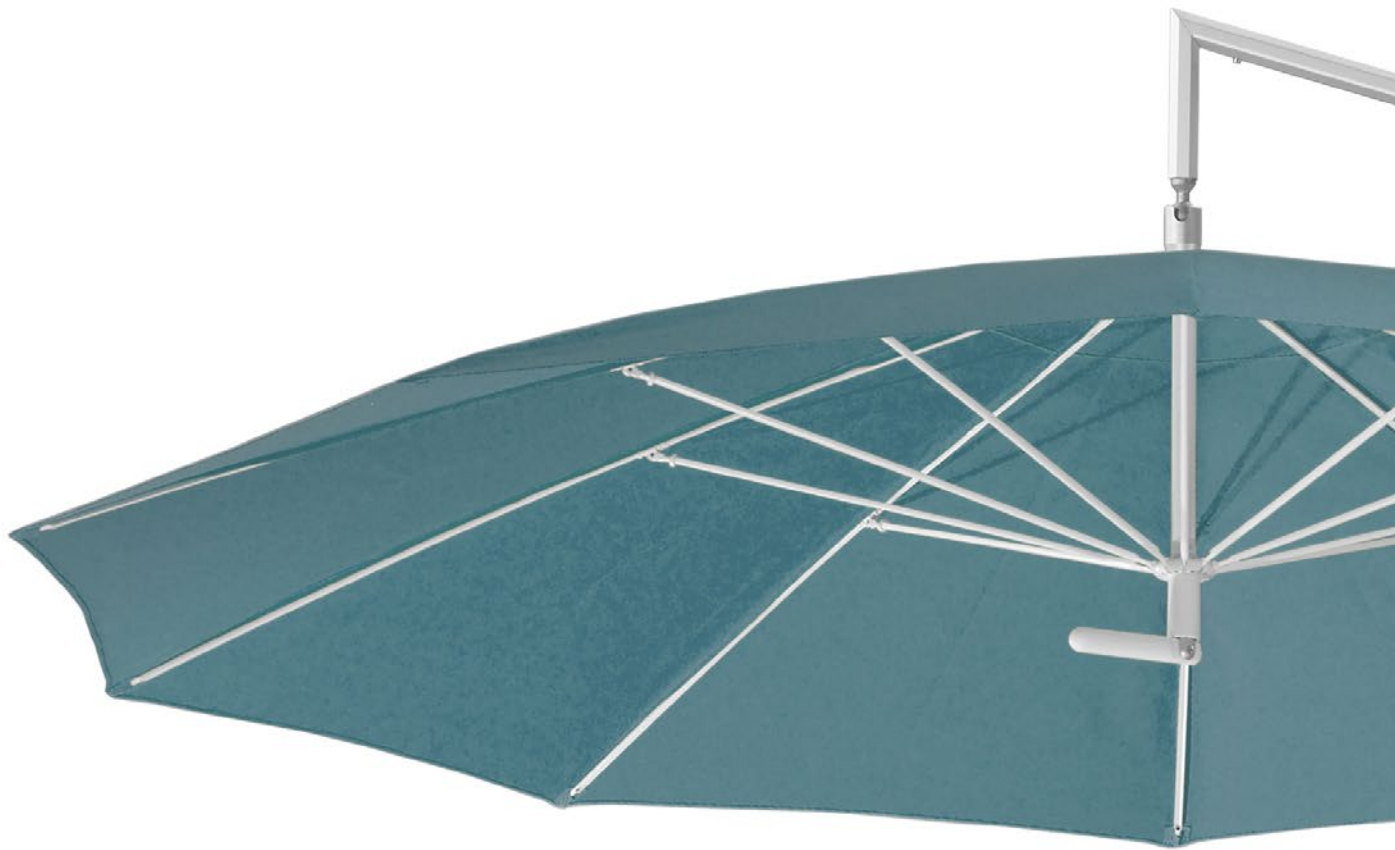

# **VERSATILE DESIGNER**

## **SIDE-POST PARASOL**

**maximum flexibility**

**elegant design**

**high-grade steel  
and aluminium**

**product video at  
[www.may-online.com](http://www.may-online.com)**

**Made in Germany**





DACAPO Ø 3.0 m  
MayTex-Acryl SA 314 011 royal blue







DACAPO DG Ø 3.0 m  
MayTex-Acryl SA 314 003 yellow



### Complete freedom of movement

The position of the mast of DACAPO side-post parasols allows completely unencumbered movement in shaded areas. Consequently, you will be able to make full use of your garden, balcony or patio space.

### Canopy covering fabric

For fabrics and colours see page 46 onwards.

### Installation options

mobile see page 35 onwards,  
stationary see page 40 onwards.



Ball joint

### Maximum movability of the canopy

The canopy of the parasol can be tilted at any angle, depending on the position of the sun. E.g. set at an angle of 90°, it can protect you from the low rays of the sun or serve as a screen for privacy.

### When not in use

The protective cover provided can easily be slipped over the shade during bad weather periods.

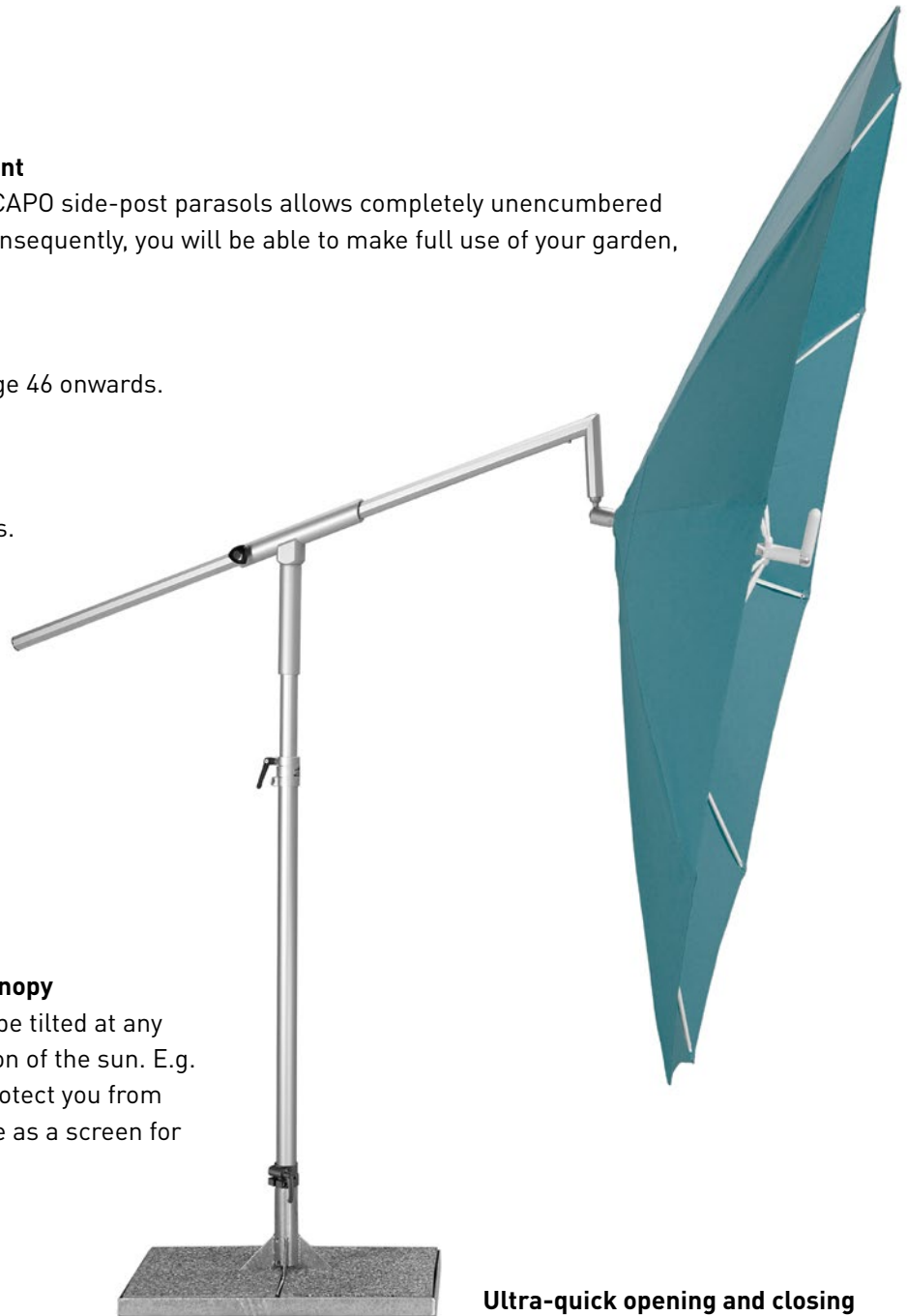

### Ultra-quick opening and closing

A technical tour de force. DACAPO can be opened in next to no time and closed again just as quickly. No need to dismount anything. When closed and folded together, the space-saving parasol can easily be stored away.



## **DACPO DG – standard model and DACPO DK – with crank for cross arm regulation**

With the help of a ball-joint mechanism the DACAPO canopy can be tilted to any required angle – depending on the position of the sun – and then locked. The standard incorporation of a pneumatic spring in the parasol mast enables easy height (vertical) adjustment. If requested, parasols can also be supplied with a crank for horizontal operation of the cross arm. In that case order DACAPO DK.



DG, Dacapo standard version



DK, Dacapo with crank

### **High-quality framework materials**

The poles of our parasols are all made of high-quality alloyed, extruded aluminium profiles. Frame surfaces are anodized, highly impact-proof, and available in the colour EV1 anodized silver-grey. The spokes are of spring steel and powder-coated, available in white aluminium RAL 9006.

### **Valance options**



straight valance



without valance



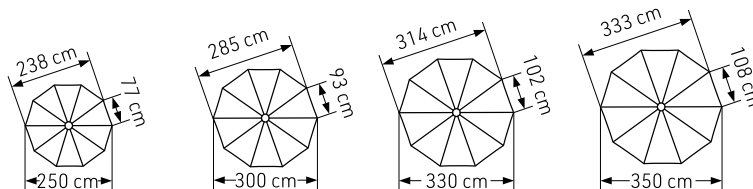

DACAPO standard model DG		Ø 2,5 m	Ø 3,0 m	Ø 3,3 m <sup>3)</sup>	Ø 3,5 m <sup>2)3)</sup>
	Segments	10	10	10	10
	Area m <sup>2</sup>	4,6	6,6	8	9
<b>A</b>	min./max.	cm	258 / 298	258 / 298	255 / 295
<b>B</b>		cm	160	160	180
<b>C</b>	min./max.	cm	223 / 263	223 / 263	223 / 263
<b>D</b>		cm	186	186	207
<b>H</b>	min./max.	cm	195 / 235	195 / 235	195 / 235
<b>K<sup>1)</sup></b>	min./max.	cm	105 / 145	78 / 118	69 / 109
<b>L<sup>1)</sup></b>	min./max.	cm	182 / 222	175 / 215	188 / 228
<b>M<sup>1)</sup></b>	min./max.	cm	69 / 109	69 / 109	47 / 87
<b>O<sup>1)</sup></b>	min./max.	cm	56 / 96	56 / 96	30 / 70
	Weight without packaging	kg	18	19	19
<b>P</b>	Support pole diameter	mm	outer-Ø 55, pole thickness 3		
	Packaging		rectangular cardboard box: l= 235 cm, w= 32 cm, h= 18 cm, approx. 3 kg		
	Installation base length/width/min. depth	cm	50/50/60		
	Minimum-ballast Number of layers of concrete slabs XZ40 required		1 x = approx. 72 kg		2 x = approx. 144 kg

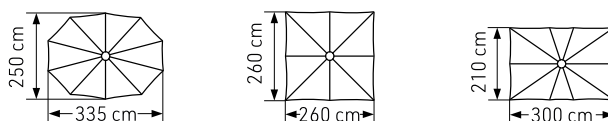

DACAPO standard model DG		2,5 × 3,35 m <sup>4)</sup>	2,6 × 2,6 m	2,1 × 3,0 m <sup>4)</sup>
	Segments	10	8	10
	Area m <sup>2</sup>	6,8	6,8	6,3
<b>A</b>	min./max.	cm	255 / 295	255 / 295
<b>B</b>		cm	180	180
<b>C</b>	min./max.	cm	223 / 263	223 / 263
<b>D</b>		cm	207	207
<b>H</b>	min./max.	cm	195 / 235	195 / 235
<b>K<sup>1)</sup></b>	min./max.	cm	105 / 145	102 / 142
<b>L<sup>1)</sup></b>	min./max.	cm	171 / 211	210 / 250
<b>M<sup>1)</sup></b>	min./max.	cm	30 / 70	47 / 87
<b>O<sup>1)</sup></b>	min./max.	cm	16 / 56	29 / 69
	Weight without packaging	kg	20	20
<b>P</b>	Support pole diameter	mm	outer-Ø 55, pole thickness 3	
	Packaging		rectangular cardboard box: l= 235 cm, w= 32 cm, h= 18 cm, approx. 3 kg	
	Installation base length/width/min. depth	cm	50/50/60	
	Minimum-ballast Number of layers of concrete slabs XZ40 required		1 x = approx. 72 kg	

Dimensional tolerance approx. 5%.

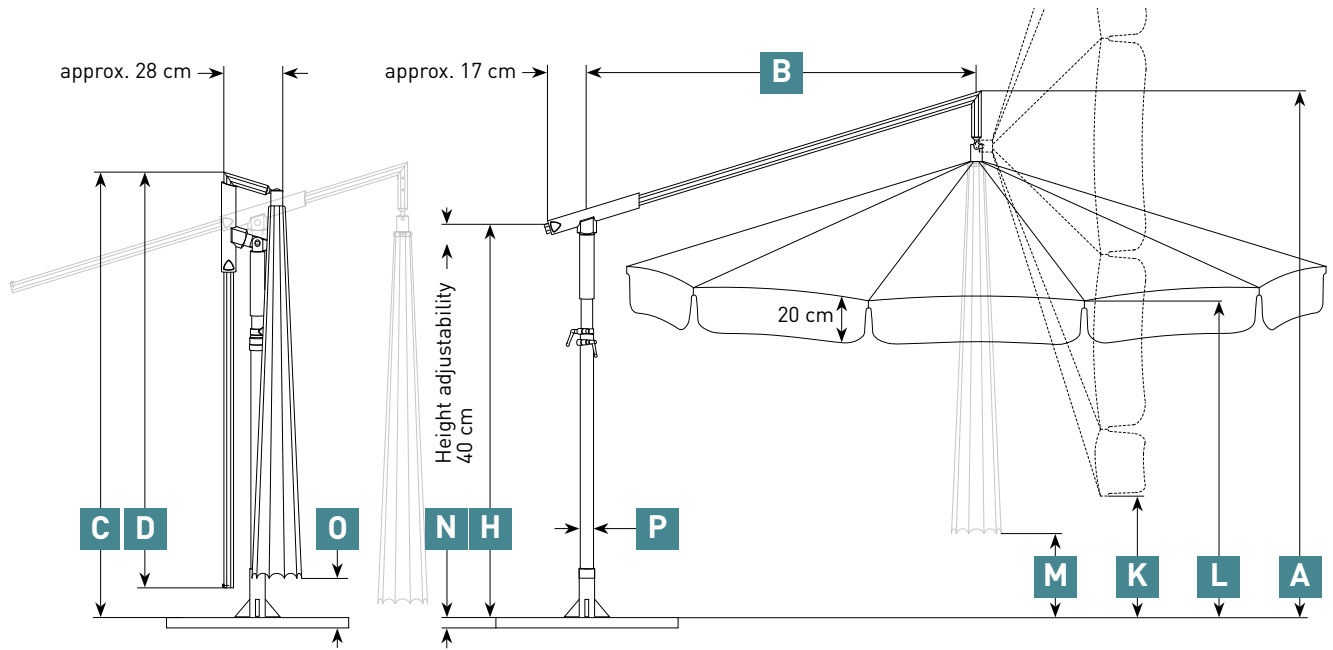

**N** The heights specified are for parasols with MayTex-Acryl covering fabric that are mounted in an anchor tube (DMZ118, DMZ146). The increase in height for parasols with other installation bases can be seen in the list below:

Cross pedestal: DMZ110 + 6 cm  
 Full frame pedestal: DMZ411 + 9 cm  
 Full frame pedestal: DMZ412 + 12 cm  
 Full frame pedestal: DMZ414 + 16 cm  
 Full frame pedestal: DMZ420 + 19 cm

Granite base: DMZ141 + 10 cm  
 Wheeled pedestal: DMZ282 + 14/15 cm  
 Anchor plate: DMZ261 + 4 cm  
 Base plate: DMZ271 + 12 cm

### Adjustable to suit your individual needs

- 1** No matter where the sun is, the parasol canopy can be tilted at any angle for shade and protection, then locked. (DG and DK).
- 2** Effortless height adjustment thanks to standard incorporation of a pneumatic spring in the support pole (DG and DK).
- 3** The cross arm can easily be adjusted (DG).

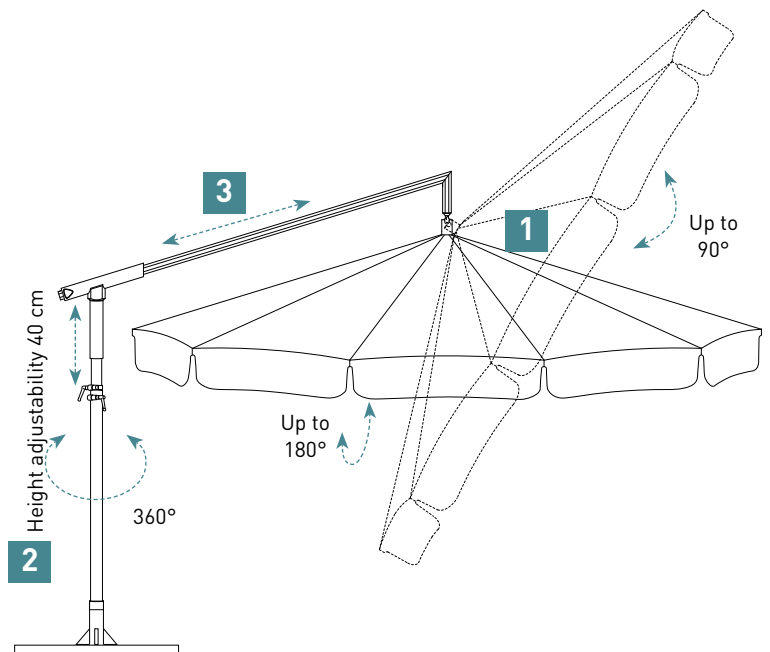

<sup>1)</sup> Parasols with valance less 20 cm.  
<sup>2)</sup> Ø 3.5 m: in MayTex-Poly only.  
<sup>3)</sup> Additional pedestal weight may be required for windy locations (upwind, sloping sites and so on). Do not use granite base. Pedestals require 2 sets of concrete slabs.  
<sup>4)</sup> The canopy is vaulted, so that the corner spokes are approx. 9-18 cm lower than the centre spokes (cf. sketch).

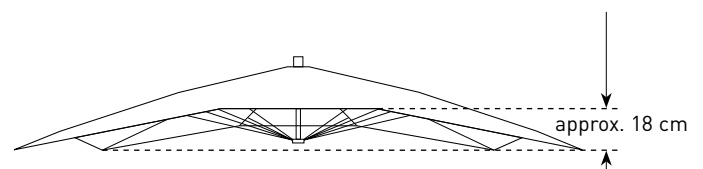

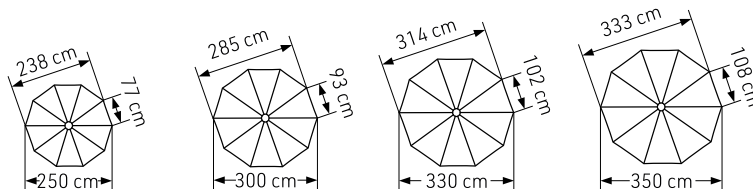

DACAPO with crank DK		Ø 2,5 m	Ø 3,0 m	Ø 3,3 m <sup>3)</sup>	Ø 3,5 m <sup>2)3)</sup>
	Segments	10	10	10	10
	Area	m <sup>2</sup> 4,6	6,6	8	9
<b>A</b>	min./max.	cm 240 / 280	240 / 280	250 / 290	250 / 290
<b>B</b>		cm 160	160	180	180
<b>C</b>	min./max.	cm 212 / 252	212 / 252	215 / 255	215 / 255
<b>D</b>		cm 186,5	186,5	206,5	206,5
<b>H</b>	min./max.	cm 185 / 225	185 / 225	185 / 225	185 / 225
<b>K<sup>1)</sup></b>	min./max.	cm 90 / 130	70 / 110	60 / 100	45 / 85
<b>L<sup>1)</sup></b>	min./max.	cm 170 / 210	160 / 200	170 / 210	165 / 205
<b>M<sup>1)</sup></b>	min./max.	cm 60 / 100	60 / 100	40 / 80	30 / 70
<b>O<sup>1)</sup></b>	min./max.	cm 44 / 84	45 / 85	19 / 59	20 / 60
	Weight without packaging	kg 18	19	19	20
<b>P</b>	Support pole diameter	mm	outer-Ø 55, pole thickness 3		
	Packaging	rectangular cardboard box: l= 235 cm, w= 32 cm, h= 18 cm, approx. 3 kg			
	Installation base length/width/min. depth	cm 50/50/60			
	Minimum-ballast Number of layers of concrete slabs XZ40 required	1 x = approx. 72 kg			2 x = approx. 144 kg

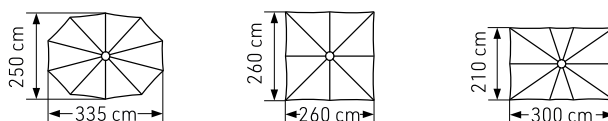

DACAPO with crank DK		2,5 × 3,35 m <sup>4)</sup>	2,6 × 2,6 m	2,1 × 3,0 m <sup>4)</sup>
	Segments	10	8	10
	Area	m <sup>2</sup> 6,8	6,8	6,3
<b>A</b>	min./max.	cm 250 / 290	250 / 290	250 / 290
<b>B</b>		cm 180	180	180
<b>C</b>	min./max.	cm 215 / 255	215 / 255	215 / 255
<b>D</b>		cm 206,5	206,5	206,5
<b>H</b>	min./max.	cm 185 / 225	185 / 225	185 / 225
<b>K<sup>1)</sup></b>	min./max.	cm 93 / 133	92 / 130	111 / 151
<b>L<sup>1)</sup></b>	min./max.	cm 160 / 200	198 / 238	190 / 230
<b>M<sup>1)</sup></b>	min./max.	cm 32 / 72	32 / 71	30 / 70
<b>O<sup>1)</sup></b>	min./max.	cm 16 / 56	16 / 56	16 / 56
	Weight without packaging	kg 20	20	20
<b>P</b>	Support pole diameter	mm	outer-Ø 55, pole thickness 3	
	Packaging	rectangular cardboard box: l= 235 cm, w= 32 cm, h= 18 cm, approx. 3 kg		
	Installation base length/width/min. depth	cm 50/50/60		
	Minimum-ballast Number of layers of concrete slabs XZ40 required	1 x = approx. 72 kg		

Dimensional tolerance approx. 5%.



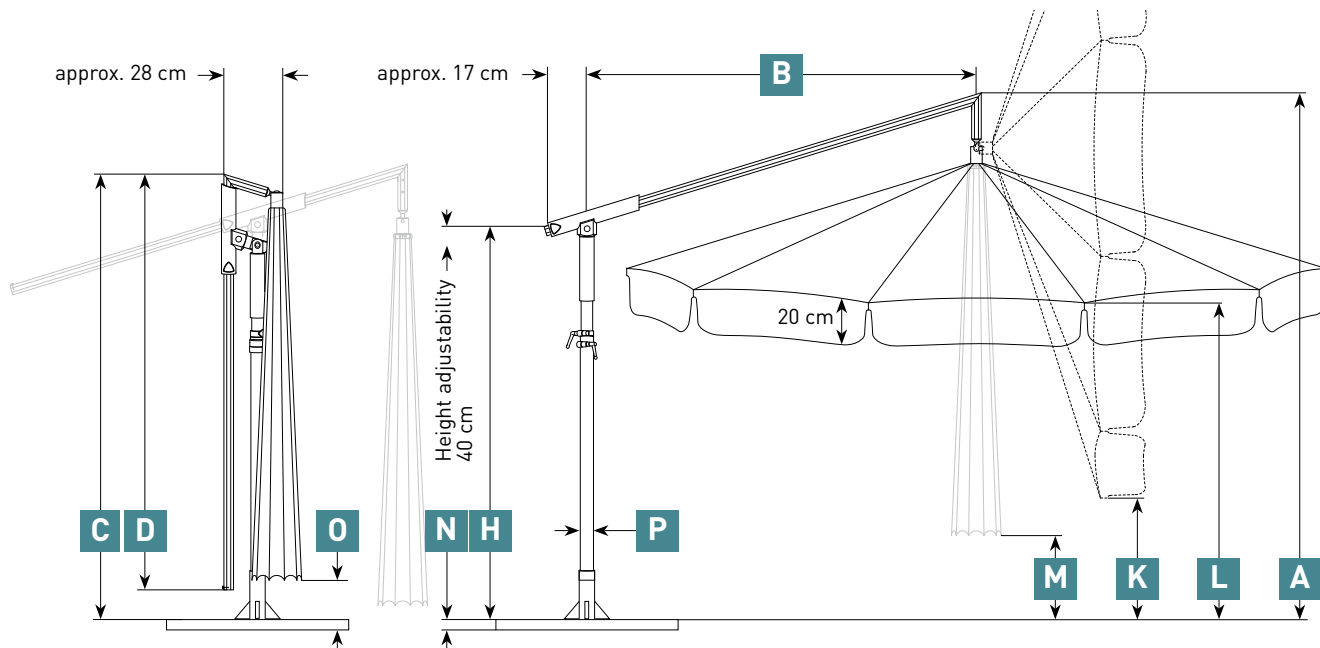

**N** The heights specified are for parasols with MayTex-Acryl covering fabric that are mounted in an anchor tube (DMZ118, DMZ146). The increase in height for parasols with other installation bases can be seen in the list below:

Cross pedestal: DMZ110 + 6 cm  
 Full frame pedestal: DMZ411 + 9 cm  
 Full frame pedestal: DMZ412 + 12 cm  
 Full frame pedestal: DMZ414 + 16 cm  
 Full frame pedestal: DMZ420 + 19 cm

Granite base: DMZ141 + 10 cm  
 Wheeled pedestal: DMZ282 + 14/15 cm  
 Anchor plate: DMZ261 + 4 cm  
 Base plate: DMZ271 + 12 cm

### Adjustable to suit your individual needs

- 1** No matter where the sun is, the parasol canopy can be tilted at any angle for shade and protection, then locked (DG and DK).
- 2** Effortless height adjustment thanks to standard incorporation of a pneumatic spring in the support pole (DG and DK).
- 3** On special request, additional crank for easy horizontal adjustment (DK).

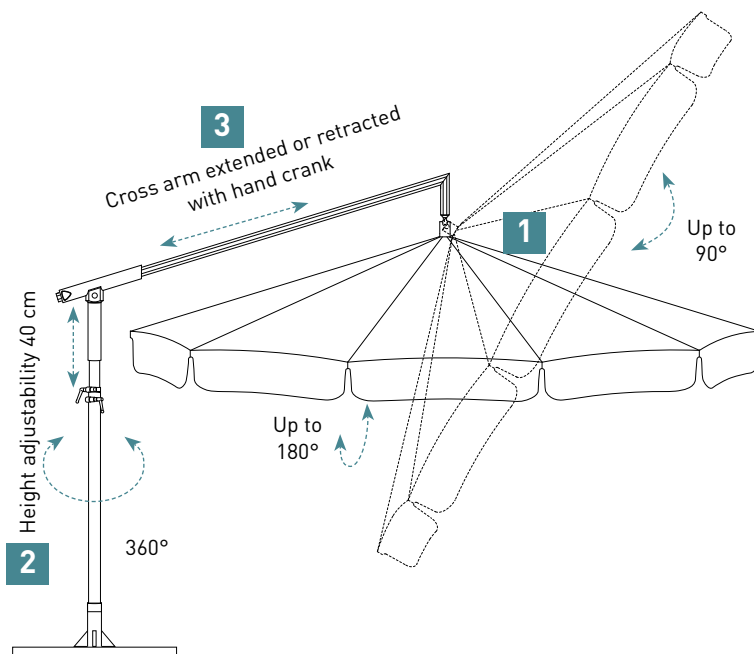

<sup>1)</sup> Parasols with valance less 20 cm.  
<sup>2)</sup> Ø 3.5 m: in MayTex-Poly only.  
<sup>3)</sup> Additional pedestal weight may be required for windy locations (upwind, sloping sites and so on). Do not use granite base. Pedestals require 2 sets of concrete slabs.  
<sup>4)</sup> The canopy is vaulted, so that the corner spokes are approx. 9-18 cm lower than the centre spokes (cf. sketch).

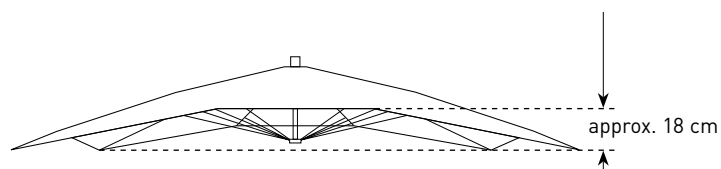

## Accessories and Bases

### Canopy bonnet, 1 bonnet

A light bonnet in the centre of the canopy optically breaks the straight areas and lines. This gives the parasol a complete new face. The overlapping between canopy bonnet and canopy ensures that as few as possible water enters the openings in case of rain and wind. So there are hardly any limitations of the regular functions.



### Canopy bonnet, 4 bonnets



### Protective sleeve, version zipper and aluminium rod

With integrated aluminium rod and zipper for easy operation. Made of tarp material, colour grey. For DACAPO please indicate parasol size and valance option. For MEZZO please indicate parasol size and type (MG or MH). Included in delivery of parasol.

For retrofitting MEZZO art. no. **MA130**  
For retrofitting DACAPO art. no. **DA130**



### Substitute canopy covering

An occasional change of canopy covering can give your patio a completely new flair.



## Cross pedestal

mounted with screws, frame size 83 × 83 cm,  
total height 28 cm, galvanized, weight approx. 4.5 kg.  
For standard concrete slabs 40 × 40 × 5 cm.  
Instructions: [may.ag/DMZ110\\_en.pdf](http://may.ag/DMZ110_en.pdf)

art. no. **DMZ110**



## Full frame pedestal

frame size 84 × 91 cm, total height 33 cm, height of  
frame **x** = 5 cm, galvanized, weight approx. 23 kg.  
For 1 set of standard concrete slabs 40 × 40 × 5 cm.  
Instructions: [may.ag/DMZ411\\_en.pdf](http://may.ag/DMZ411_en.pdf)

art. no. **DMZ411**

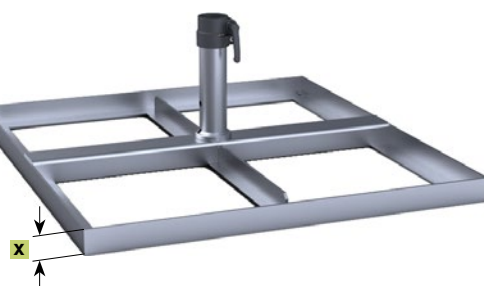

## Full frame pedestal adjustable for slanting surfaces

with 4 rubber diagonal support levelling screws,  
frame size 84 × 91 cm, total height min. 34 cm,  
max. 40 cm, galvanized, weight approx. 24 kg.  
For 1 set of standard concrete slabs 40 × 40 × 5 cm.  
Instructions: [may.ag/DMZ412\\_en.pdf](http://may.ag/DMZ412_en.pdf)

art. no. **DMZ412**



## Full frame pedestal on wheels

with rubber heavy-duty rollers and fixing brakes,  
frame size 84 × 91 cm, total height 40 cm, diameter  
of rollers 5 cm, galvanized, weight approx. 24 kg.  
For 1 set of standard concrete slabs 40 × 40 × 5 cm.  
Attention: wind sensitive!  
Instructions: [may.ag/DMZ414\\_en.pdf](http://may.ag/DMZ414_en.pdf)

art. no. **DMZ414**



## Heavy-duty wheels Ø 15 cm

wheel diameter 15 cm, for uneven surfaces. Rubber, with fixing  
brakes, loading capacity 110 kg/wheel. Suitable for DMZ414.

For orders with full frame pedestal  
For retrofitting

art. no. **351498**

art. no. **351499**

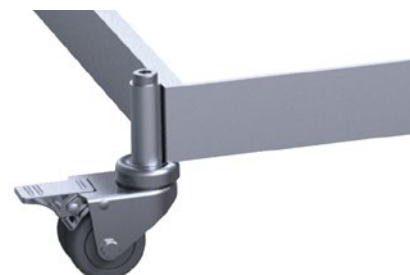

### Full frame pedestal on feet

for forklift or lift truck transport, frame size 84 × 91 cm, foot height **y** = 10 cm, weight approx. 25 kg, galvanized. For 1 set of standard concrete slabs 40 × 40 × 5 cm.  
Instructions: [may.ag/DMZ420\\_en.pdf](http://may.ag/DMZ420_en.pdf)

art. no. **DMZ420**

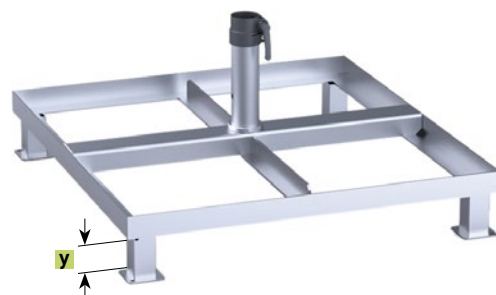

### Frame pedestal cover plate

stainless steel 1.4310, fits on DMZ411, DMZ412, DMZ414 and DMZ420. For retrofitting.

art. no. **200905**

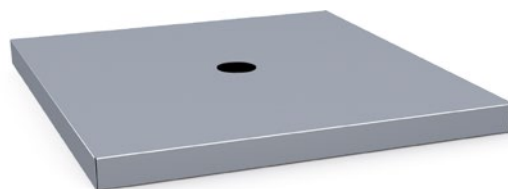

**DMZ411 mit 200905**

### Concrete slabs

1 set = 4 slabs, each 40 × 40 × 5 cm, weight per slab: approx. 18 kg, Total weight approx. 72 kg.

art. no. **XZ40**



### Granite base

Ø approx. 70 cm, 2 pieces, round, grau, polished, 4 recessed grips, stainless steel surface, weight approx. 100 kg, height **x** = approx. 10 cm.

art. no. **DMZ141**



## Wheeled pedestal

incl. weights, rubber rollers, stainless steel locking rod. Colour anthracite, 75 × 75 cm, weight approx. 100 kg.

anthracite

art. no. **DMZ282**



## Wheeled pedestal

incl. weights, rubber rollers, stainless steel locking rod. Colour graphite, 75 × 75 cm, weight approx. 100 kg.

graphite

art. no. **DMZ283**



## Free-standing base plate

plate size 80 × 80 cm, steel plate thickness **x** = 12 mm, galvanized, weight approx. 60 kg. Only use in combination with art. 351185. Instructions: [may.ag/DMZ271\\_en.pdf](http://may.ag/DMZ271_en.pdf)

art. no. **DMZ271**



## Add-on weight plate

fits for DMZ271 and DMZ139, for retrofitting. Plate size 78 × 78 cm, steel plate thickness **x** = 12 mm, galvanized, weight approx. 56 kg. Instructions: [may.ag/DMZ271\\_en.pdf](http://may.ag/DMZ271_en.pdf)

art. no. **351185**



351185 with DMZ271

## Anti-slip mat

1 piece, 80 × 80cm, suitable for the steel plates of the installation options of DMZ271 and DMZ139. Increases the coefficient of friction between steel plate and floor covering (wood, concrete slabs, asphalt) and therefore decreases slipping caused by wind. Colour black, **x** = 3 mm.

art. no. **352791**





### Full frame pedestal

customized height to fit patio surface, frame size 83 × 83 cm, screw-off upper part, galvanized, weight approx. 23 kg, incl. top plate for winter protection, **s** = Ø 8 cm. For 1 set of standard concrete slabs 40 × 40 × 5 cm.

Instructions : [may.ag/DMZ208\\_en.pdf](http://may.ag/DMZ208_en.pdf)

art. no. **DMZ208**

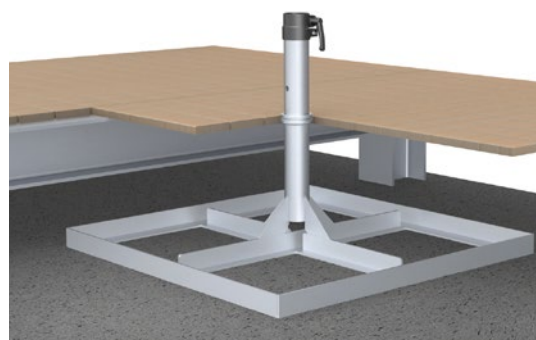
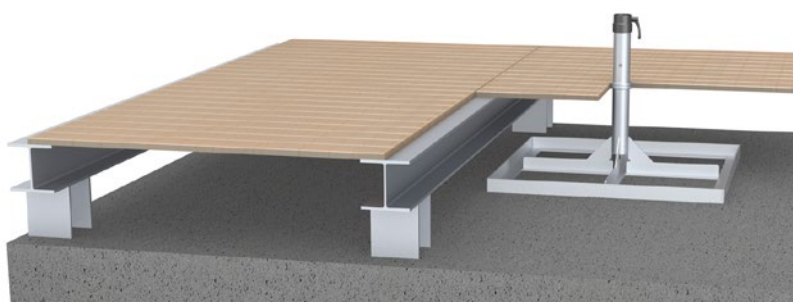
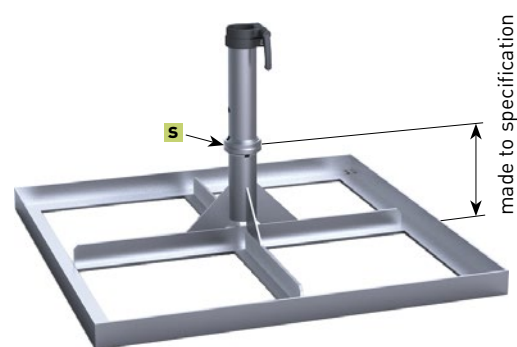



# MOBILE INSTALLATION OPTIONS



MEZZO Ø 3.0 m  
MayTex-Acryl DA 7560 light yellow  
ZimmerMeisterHaus  
Photographer: Joachim Mohr



**Anchor tube to be embedded in concrete**

2 pieces, screw-off upper part, galvanized, weight approx. 4.7 kg, incl. top plate for winter protection.

**a** = 26 cm, **b** = 29 cm, **s** = Ø 8 cm, **y** = 10.5 cm.

Instructions: [may.ag/DMZ118\\_en.pdf](http://may.ag/DMZ118_en.pdf)

art. no. **DMZ118**

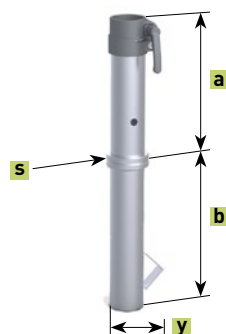

**Anchor tube to be embedded in concrete**

identical with DMZ118, tube and upper part stainless steel V4A (1.4571), surface glass bead blasted.

Instructions: [may.ag/352779\\_en.pdf](http://may.ag/352779_en.pdf)

art. no. **352779**



**DMZ118 options:**

**Drainage unit**

easy on-site installation, plastic material.

art. no. **357481**



**galvanized**

**DMZ118 upper anchor tube, extra length**

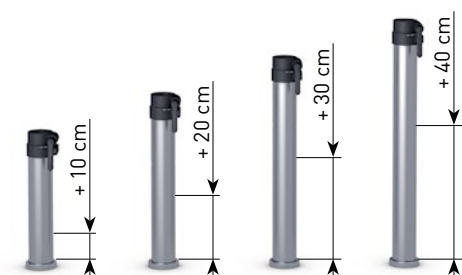

**DMZ118 lower anchor tube, extra length**

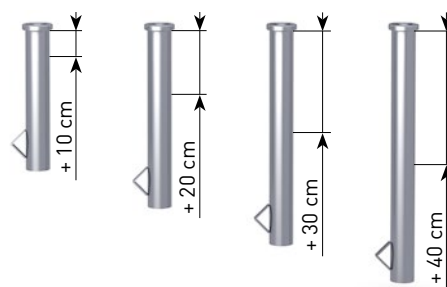

## DMZ118 options: galvanized and powder-coated in white aluminium RAL 9006

### DMZ118 upper anchor tube, standard and extra length



#### Anchor tube to be embedded in concrete

for an existing foundation with a bore hole of min.  $\varnothing$  71 mm, 2 pieces, screw-off upper part. The bore hole is filled with concrete or epoxy resin in order to fix the lower part of the anchor tube. The existing foundation must be adequate in size for the designated parasol. Galvanized, weight approx. 3 kg, lower tube square, incl. top plate for winter protection.

**a** = 25 cm, **b** = 28.5 cm, **s** =  $\varnothing$  8 cm, **y** =  $\square$  5 cm.

Instructions: [may.ag/DMZ146\\_en.pdf](http://may.ag/DMZ146_en.pdf)

art. no. **DMZ146**

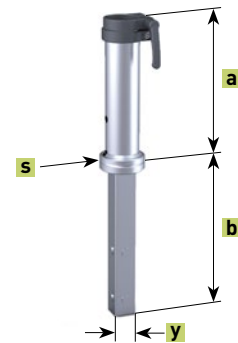

#### \* NEW!

#### Anchor tube with removable upper part (plug-in connection), to be embedded in concrete

suitable for daily assembly and disassembly (no tools required), two-piece anchor tube with bayonet connector, secured within the ground tube by centring pin, hot-dip galvanized, top plate for winter protection included, anchor tube weight: approx. 2.2 kg, upper anchor tube weight: approx. 2.6 kg,

**a** = 27 cm, **b** = 22 cm, **c** = 28 cm, **y** = 12 cm.

Instructions: [may.ag/DMZ169\\_en.pdf](http://may.ag/DMZ169_en.pdf)

art. no. **DMZ169**

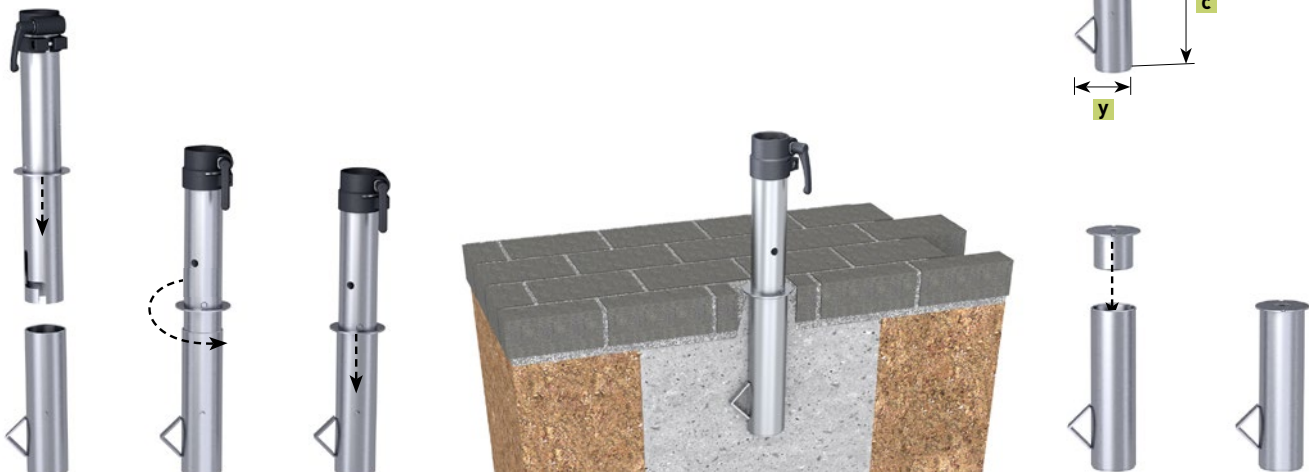
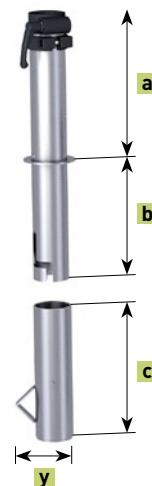

### Dowel-anchored plate

galvanized, weight approx. 5 kg,

**a** = 27.5 cm, **x** = Ø 21.5 cm, **t** = 1.2 cm, **z** = Ø 1.8 cm.

Instructions: [may.ag/DMZ261\\_en.pdf](http://may.ag/DMZ261_en.pdf)

art. no. **DMZ261**

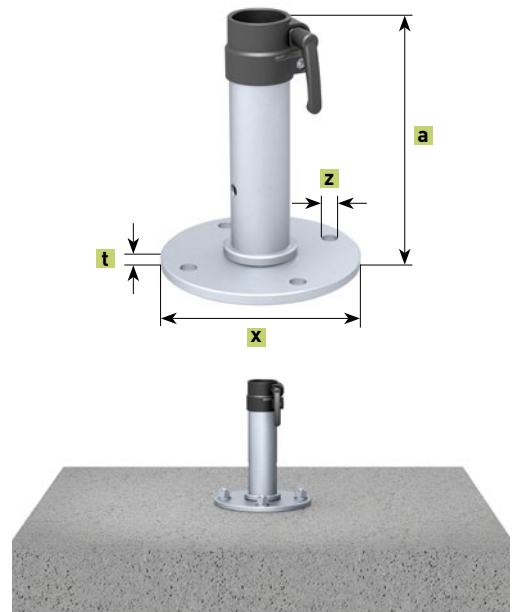

### Wall bracket

galvanized, weight approx. 5.5 kg, wall plate 30 × 16 cm,

**x** = 20 cm, **t** = 0.8 cm. Bottom of support pole rests on bottom end of anchor tube. For MEZZO this option only makes sense in case of low balustrades and ledges, otherwise the parasol canopy will hit the wall.

art. no. **DMZ125**

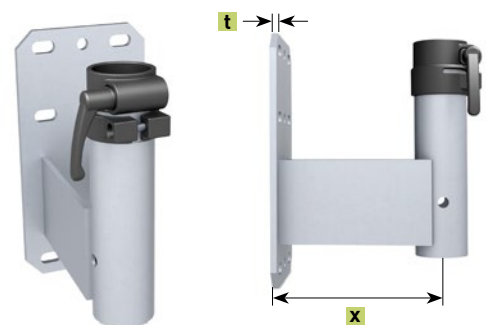

### Wall pressure plate for DMZ125

fits for DMZ125 and DMZ170, galvanized; 30 × 16 cm, to be clamped onto the existing bars (only possible if these are very strong), bore holes for M16 stud bolts (not included in the delivery).

art. no. **200084**



together with  
**200084**



# STATIONARY INSTALLATION OPTIONS

## Wall bracket

galvanized, weight approx. 6.5 kg, wall plate 30 × 16 cm, **x** = 20 cm, **t** = 0.8 cm.

art. no. **DMZ170**

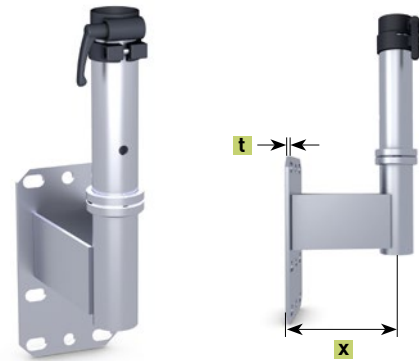

## Corner wall bracket

galvanized, weight approx. 5.5 kg, **x** = 5.5 cm, **t** = 0.8 cm.

art. no. **DMZ172**

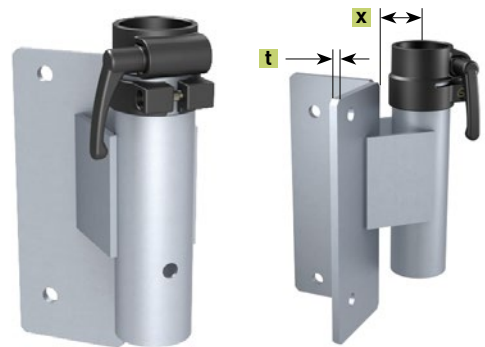

## Dowel-anchored plate

customized height to fit patio surface, anchor plate 30 × 30 cm, screw-off upper part, galvanized, weight approx. 10 kg, incl. top plate for winter protection, **s** = Ø 8 cm. Instructions: [may.ag/DMZ129\\_en.pdf](http://may.ag/DMZ129_en.pdf)

art. no. **DMZ129**

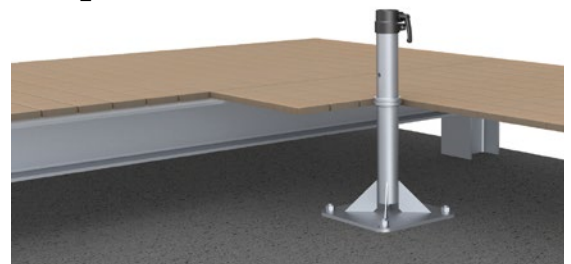
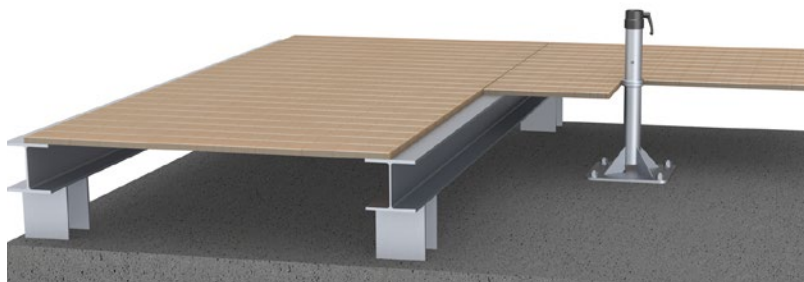
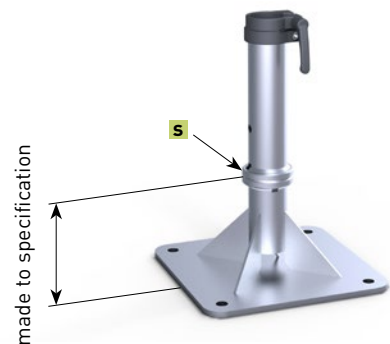

### Flat-roof dowel-anchored plate

externally insulated roof system, system-conform flat roof connection with liquid plastic, customized height to fit flat roof surface, dowel plate 30 × 30 cm, screw-off upper part, galvanized, weight approx. 13 kg, incl. top plate for winter protection, **s** = Ø 8 cm. Instructions: [may.ag/DMZ186\\_en.pdf](http://may.ag/DMZ186_en.pdf)

art. no. **DMZ186**

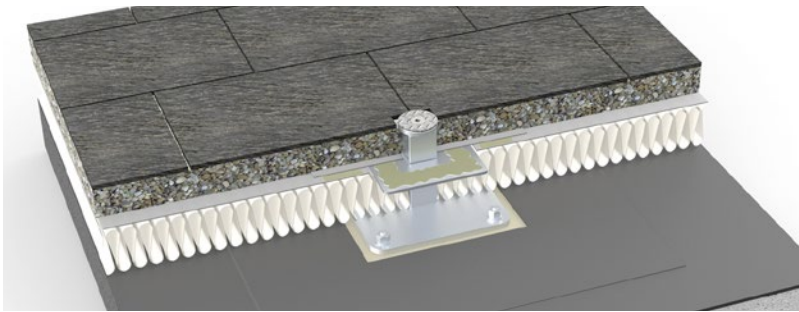
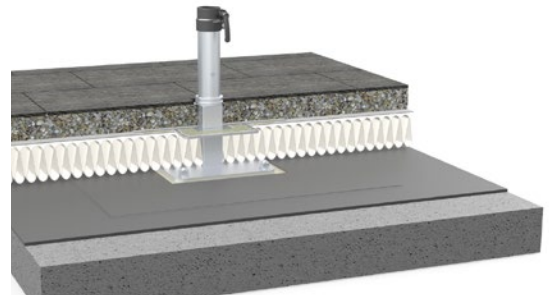
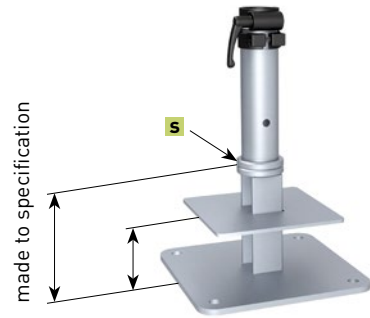

### Flat-roof dowel-anchored plate

externally insulated roof system, loose-and-fixed flange assembly, bitumen waterproofing system and synthetic waterproofing material. Total height is determined by order to achieve the same level as the flat roof ground, dowelled plate 30 × 30 cm. Upper part removable, galvanized, weight approx. 18 kg, including top plate for winter protection, **s** = Ø 8 cm. Instructions: [may.ag/DMZ194\\_en.pdf](http://may.ag/DMZ194_en.pdf)

art. no. **DMZ194**

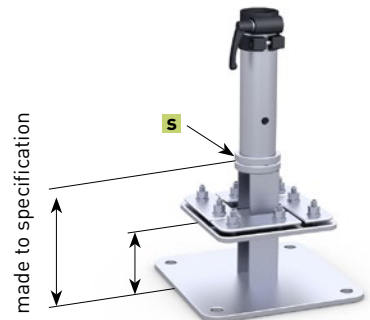

### Anchor bolt

bolt and nut, fits for DMZ261, DMZ125, DMZ170, DMZ172, DMZ129, DMZ186 and DMZ194; approved for cracked and non-cracked concrete B25 to B55 (old compressive strength classes) C20/25 to C50/60 (new EU classification), also suitable for concrete B15 = C12/15 and natural stone with dense structure. Concrete bore hole Ø 16 × 115 mm. in stainless steel A4 1.4529. Package contains 4 bolts. European Technical Approval ETA-05/0069.

art. no. **200900**



# STATIONARY INSTALLATION OPTIONS

## Ground screw anchor fixture

Upper anchor tube, suitable for ground screw KSF FMP 140x2100-M, Screw-in ground anchor not included in delivery, standard parts for screwing included. Hot-dip galvanized, weight approx. 6 kg, **a** = 26 cm, **x** = 22 cm, **t** = 1.5 cm.

Instructions: [may.ag/DMZ329\\_en.pdf](http://may.ag/DMZ329_en.pdf)

art. no. **DMZ329**



## Screw-in ground anchor

groundscrew with upper anchor tube, incl. standard parts, parts unscrewed on delivery, steel, galvanized acc. DIN EN ISO 1461, weight approx. 30 kg, delivered in two ready-to-assemble parts. See page 206 for further information.

Instructions: [may.ag/DMZ330\\_en.pdf](http://may.ag/DMZ330_en.pdf)

art. no. **DMZ330**

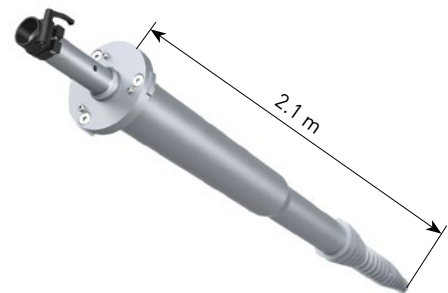

## Base plate

customized height to fit patio surface, to be screwed together on site, heaviest component approx. 60 kg, base plate size 80 x 80 cm, plate thickness **x** = 12 mm, screw-off upper part, galvanized, weight approx. 68 kg, incl. top plate for winter protection, **y** = □ 16.5 cm.

Instructions: [may.ag/DMZ139\\_en.pdf](http://may.ag/DMZ139_en.pdf)

art. no. **DMZ139**

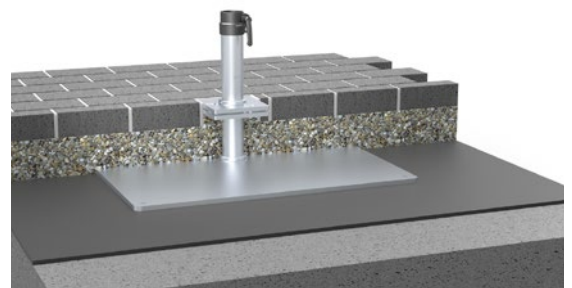
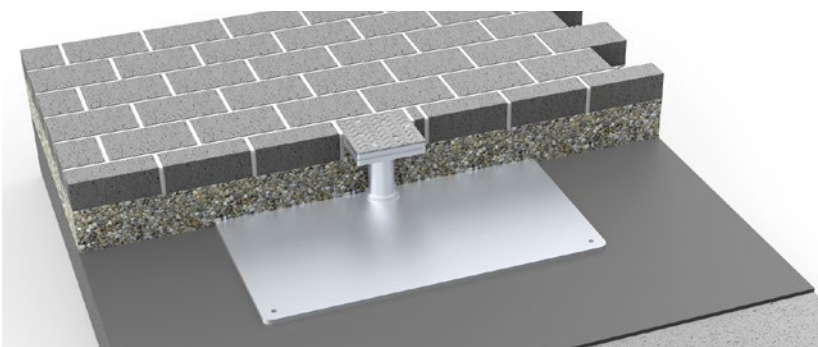
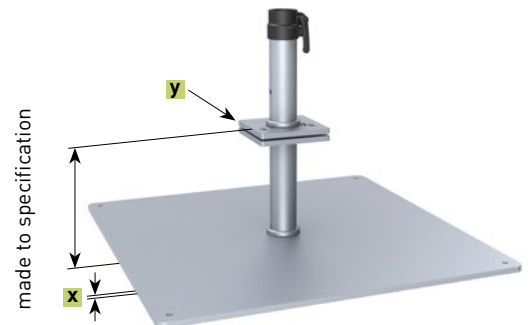

## Theft pin

padlock and pin, in stainless steel, for support pole Ø 55 mm. suitable for retrofitting.

art. no. **200194**





# MayTex-Acryl with Texgard impregnation

- material: 100% polyacrylic, spun-dyed, weight 300g/m<sup>2</sup> ±5%
- water column (fabric water tightness) 370 mm, European standard EN 20 811
- colour fastness: grade ≥7 (against bleaching), tested acc. to standard EN ISO 105-B02 (1= min., 8= max.)
- colour fastness to artificial weathering: grade ≥4-5 (against bleaching), tested acc. to standard EN ISO 105-B04 (1= min., 5= max.)
- protection against UV rays: UPF 40-80, tested acc. to UV standard 801 (see page 53 for individual values)

- weather-proof, high and low temperature resistant
- Texgard impregnation gives effective protection against oil, grease, mildew and algae, industrial pollution, exhaust fumes and other negative environmental factors
- tested acc. to OEKO-TEX Standard 100 (63864 OETI, QC 638/2 IFTH)
- imprinted ads: on parasol canopy and valance in durable, brilliant screen-printing quality
- cleaning: easy to clean with CleanoMay 13, even when mounted



SA 314 010 white  
similar to RAL 9003  
bordering 00 white



SA 314 018 white, grey knopped  
similar to RAL 9016  
bordering 00 white

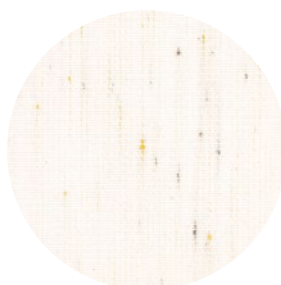

SA 314 580 white,  
yellow/white nap  
similar to RAL 9002  
bordering 18 silver



SA 314 325 ecru  
similar to RAL 1013  
bordering 52 nature

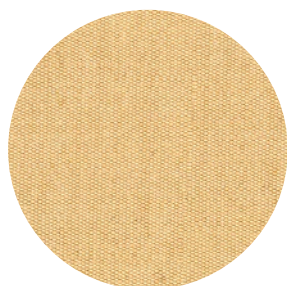

SA 314 851 vanilla  
similar to RAL 1015  
bordering 20 ivory

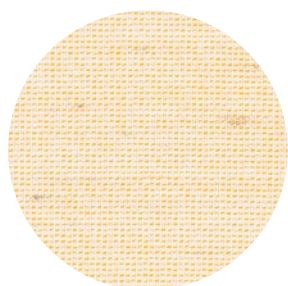

SA 314 583 white/yellow,  
grey knopped  
similar to RAL 1023/1013  
bordering 20 ivory

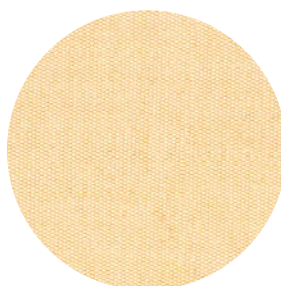

SA 314 033 ivory  
similar to RAL 1013  
bordering 20 ivory

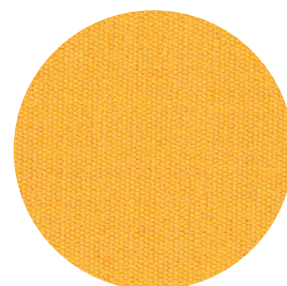

DA 7560 light yellow  
similar to RAL 1023  
bordering 10 pyrite

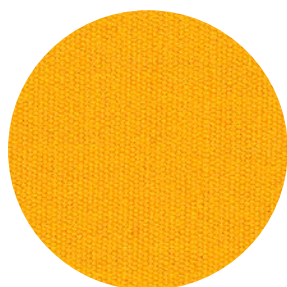

SA 314 003 yellow  
similar to RAL 1023  
bordering 32 yellow

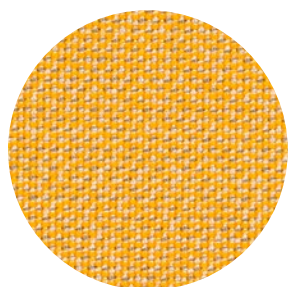

SA 314 045 pyrite  
similar to RAL 1002  
bordering 10 pyrite

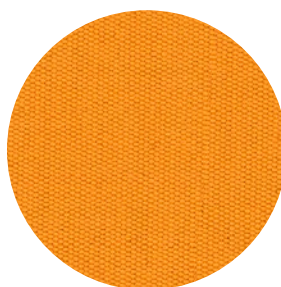

SA 314 014 mandarine  
similar to RAL 1033  
bordering 79 mandarin

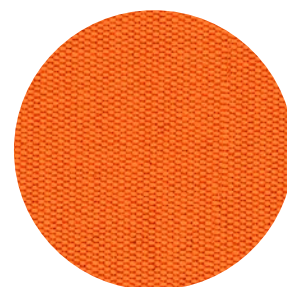

SA 314 002 orange  
similar to RAL 2004  
bordering 81 orange

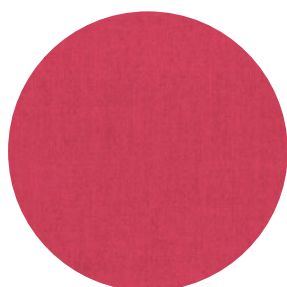

SA 314 397 magenta  
similar to RAL 4010  
bordering 410 magenta

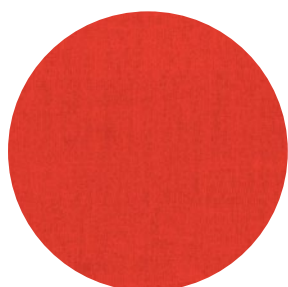

SA 314 007 pure red  
similar to RAL 3028  
bordering 82 red

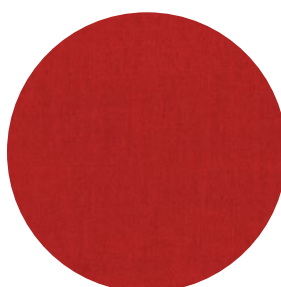

SA 314 001 cherry  
similar to RAL 3020  
bordering 85 cherry

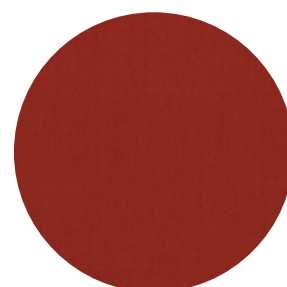

SA 314 347 ruby  
similar to RAL 3003  
bordering 85 cherry

The shades shown here are not in accordance with the original ones.  
 If requested, we will be pleased to send you a collection of original cloth samples.  
 Special colours are available upon request.

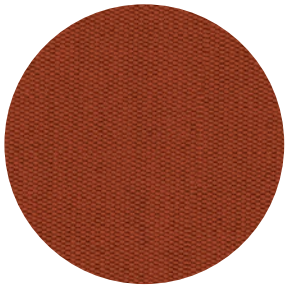

SA 314 022 rust  
 similar to RAL 2001  
 bordering 83 rust

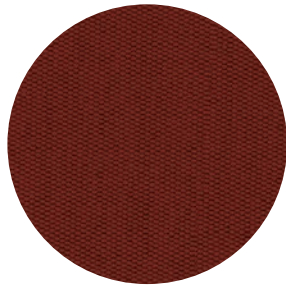

SA 314 763 bordeaux  
 similar to RAL 3004  
 bordering 86 bordeaux

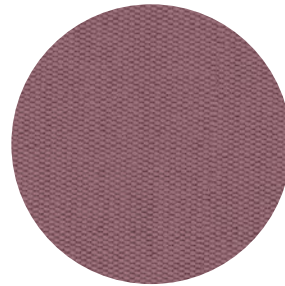

SA 314 143 mallow  
 similar to RAL 4001  
 bordering 91P mallow

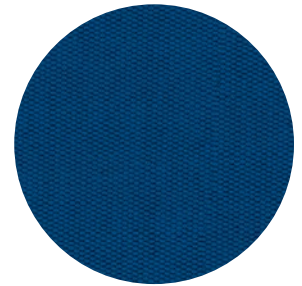

SA 314 011 royal blue  
 similar to RAL 5010  
 bordering 62 royal blue

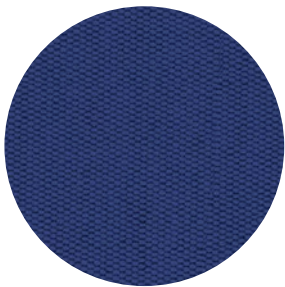

SA 314 006 sapphire  
 similar to RAL 5002  
 bordering 66 sapphire

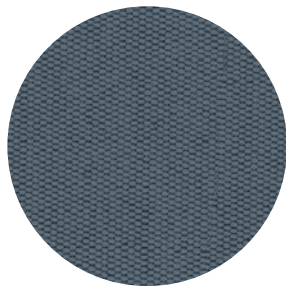

SA 314 546 patina blue  
 similar to RAL 5007  
 bordering 187 blue patina

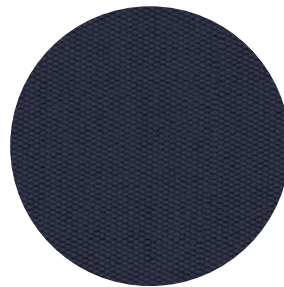

SA 314 414 navy blue  
 similar to RAL 5013  
 bordering 91 navy blue

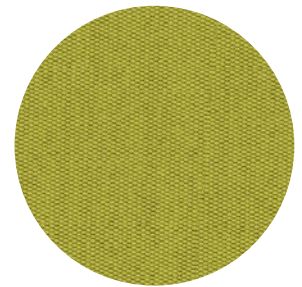

DA 7244 lime green  
 similar to RAL 6018  
 bordering 42 lime green

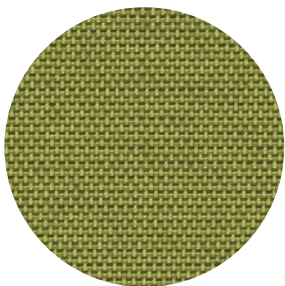

SA 314 396 green/apple green,  
 structured  
 similar to RAL 6021  
 bordering 42 lime green

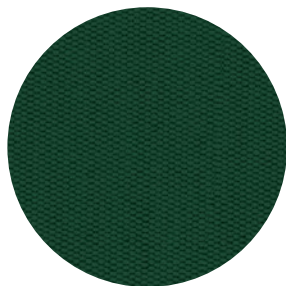

SA 314 362 dark green  
 similar to RAL 6005  
 bordering 95 dark green

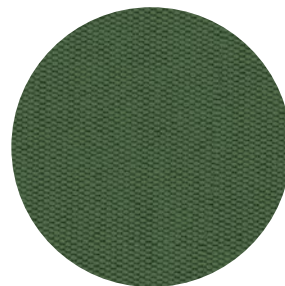

SA 314 624 patina green  
 similar to RAL 6000  
 bordering 162 green patina

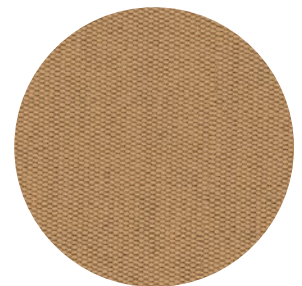

SA 314 038 beige  
 similar to RAL 1019  
 bordering 11 beige



SA 314 471 silver grey,  
 dark brown knopped  
 similar to RAL 1013/7006  
 bordering 18 silver

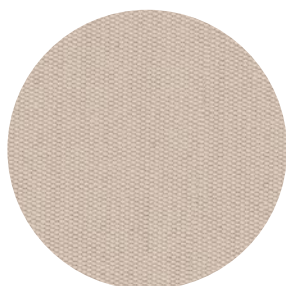

SA 314 030 light grey  
 similar to RAL 7047  
 bordering 18 silver



SA 314 028 stone grey, mottled  
 similar to RAL 7042  
 bordering 18 silver

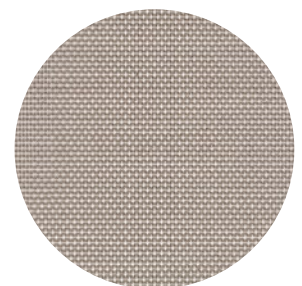

SA 314 044 grey-white  
 similar to RAL 7004  
 bordering 18 silver



# MayTex-Acryl with Texgard impregnation

- material: 100% polyacrylic, spun-dyed, weight 300g/m<sup>2</sup> ±5%
- water column (fabric water tightness) 370 mm, European standard EN 20 811
- colour fastness: grade ≥7 (against bleaching), tested acc. to standard EN ISO 105-B02 (1= min., 8= max.)
- colour fastness to artificial weathering: grade ≥4-5 (against bleaching), tested acc. to standard EN ISO 105-B04 (1= min., 5= max.)
- protection against UV rays: UPF 40-80, tested acc. to UV standard 801 (see page 53 for individual values)
- weather-proof, high and low temperature resistant
- Texgard impregnation gives effective protection against oil, grease, mildew and algae, industrial pollution, exhaust fumes and other negative environmental factors
- tested acc. to OEKO-TEX Standard 100 (63864 OETI, QC 638/2 IFTH)
- imprinted ads: on parasol canopy and valance in durable, brilliant screen-printing quality
- cleaning: easy to clean with CleanoMay 13, even when mounted

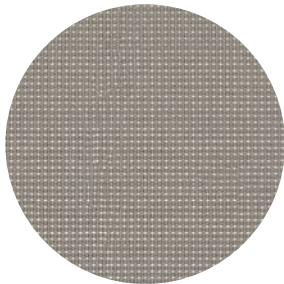

SA 314 364 telegrey/white  
similar to RAL 7046  
bordering 147 opal

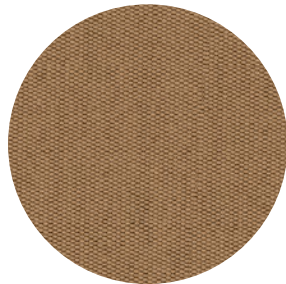

DA 8779 olive brown  
similar to RAL 7002  
bordering 9533 olive brown

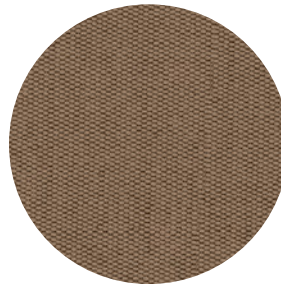

DA 7559 taupe  
similar to RAL 7006  
bordering 926 taupe

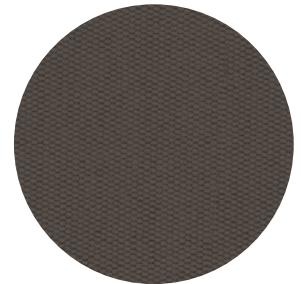

DA 8203 basalt grey  
similar to RAL 7010  
bordering 97 grey basalt

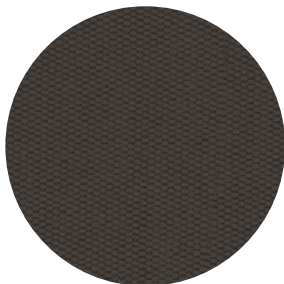

SA 314 398 atlas grey  
similar to RAL 7043  
bordering 97 grey basalt

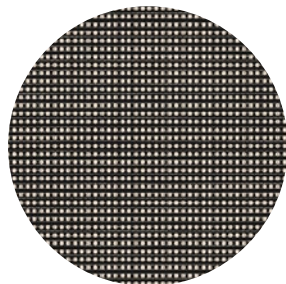

SA 314 402 black/beige, struc-  
tured  
similar to RAL 6006  
bordering 19 black

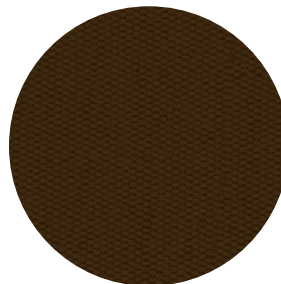

SA 314 016 dark brown  
similar to RAL 8017  
bordering 27 dark brown

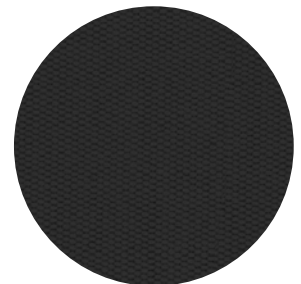

SA 314 154 black  
similar to RAL 9017  
bordering 19 black

The shades shown here are not in accordance with the original ones.  
If requested, we will be pleased to send you a collection of original cloth samples.  
Special colours are available upon request.

## MayTex-Poly

- material: 81% polyester, 19% polyacrylics, weight 230 g/m<sup>2</sup> ± 5%
- water column (fabric water tightness) 1000 mm, European standard EN 20 811
- colour fastness: grade ≥ 7 (against bleaching), tested acc. to standard EN ISO 105-B02 (1= min., 8= max.)
- protection against UV rays: UPF80, tested acc. to UV standard 801 (see page 53 for individual values)

# CLOTH COLLECTION

- Texgard impregnation gives effective protection against oil, grease, mildew and algae, industrial pollution, exhaust fumes and other negative environmental factors
- tested acc. to OEKO-TEX Standard 100 (63864 OETI)
- imprinted ads: on parasol canopy and valance in durable, brilliant screen-printing quality
- cleaning: easy to clean with CleanoMay 13, even when mounted



M 9577 white  
similar to RAL 9010  
bordering 00 white



M 9823 ivory  
similar to RAL 1015  
bordering 20 ivory

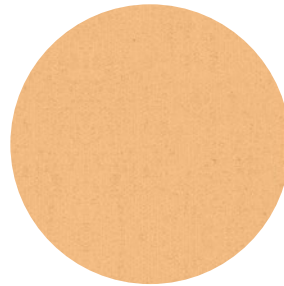

M 9875 creme  
similar to RAL 1015  
bordering 11 beige

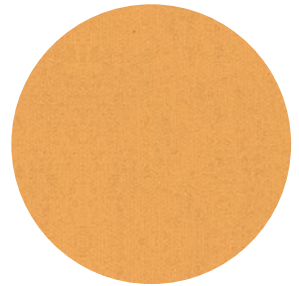

M 9816 sand  
similar to RAL 1001  
bordering 10 pyrite

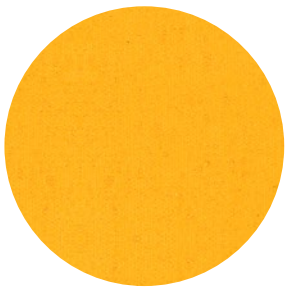

M 9526 bright yellow  
similar to RAL 1023  
bordering 32 yellow

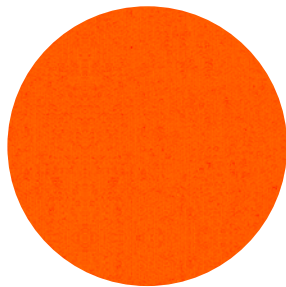

M 9527 orange  
similar to RAL 2004  
bordering 81 orange

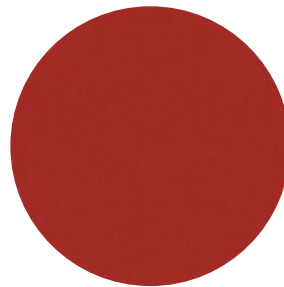

M 9671 red  
similar to RAL 3020  
bordering 82 red

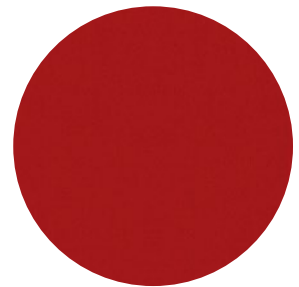

M 9675 cherry red  
similar to RAL 3000  
bordering 85 cherry



M 9878 terracotta  
similar to RAL 8004  
bordering 83 rust



M 9879 bordeaux  
similar RAL 3004  
bordering 86 bordeaux

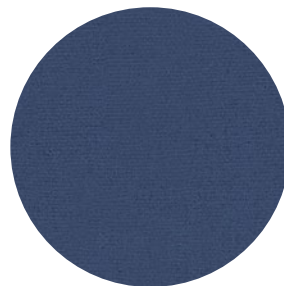

M 9793 bright blue  
similar to RAL 5005  
bordering 63 blue

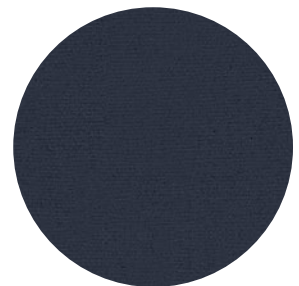

M 9545 dark blue  
similar to RAL 5003  
bordering 91 navy blue



M 9710 woodland green  
similar to RAL 6005  
bordering 95 dark green



M 9653 grey  
similar to RAL 7004  
bordering 18 silver

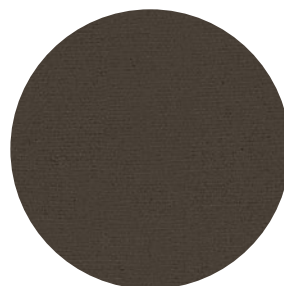

M 9654 graphite grey  
similar to RAL 7024  
bordering 97 grey basalt



M 9853 black  
similar to RAL 9004  
bordering 19 black

## Borderings

If no colour is specified, a binding tape will be chosen to match the cloth.

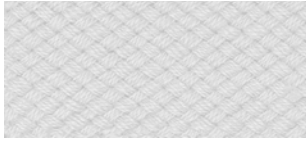

00 white

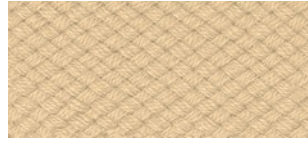

20 ivory



52 nature



11 beige

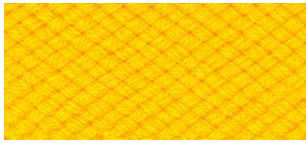

32 yellow



10 pyrite

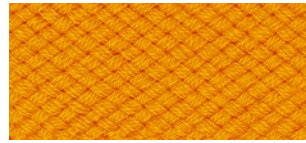

79 mandarin



81 orange



148 terracotta



410 magenta



82 red

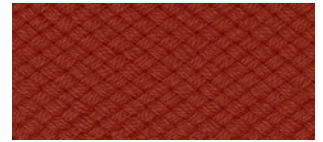

85 cherry

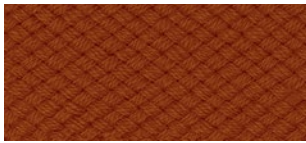

83 rust

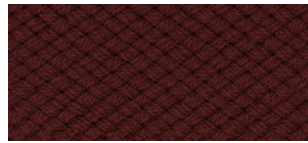

86 bordeaux

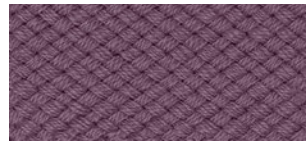

91P mallow



62 royal blue



# CLOTH COLLECTION



63 blue

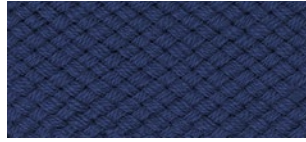

187 blue patina



66 sapphire

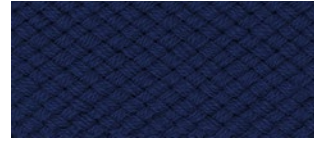

91 navy blue



42 lime green



44 gras-green



162 green patina



45 olive

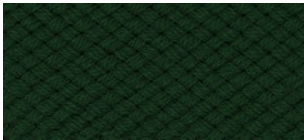

95 dark green



18 silver

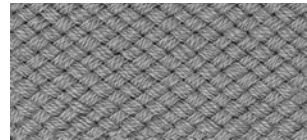

147 opal

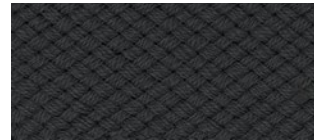

97 grey basalt

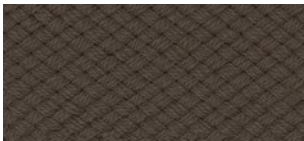

926 taupe

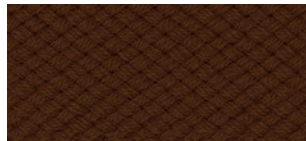

25 light brown

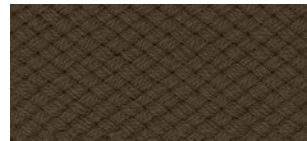

9533 olive brown

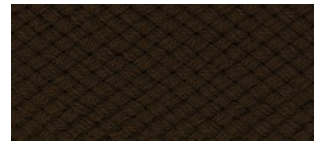

27 dark brown

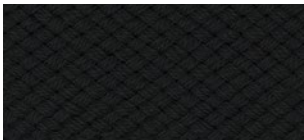

19 black

The textile finishing of a parasol canopy – i.e. the fabrics – is not only the most important and most conspicuous feature of any sun protection system, it also fulfils numerous functions:

## **Colour, light and shade: personal well-being, atmosphere and decoration**

The most comprehensive range of upmarket classics and specialities. The fabric keeps out the light. It protects, shades, creates atmosphere and serves as an element of design and decoration. The fabric evokes a sense of harmony and creates a feeling of well-being by filtering and tinting the light and thus lending a room and its environment a very special soothing atmosphere. The impact a fabric has on a person is decisively determined by its colour, pattern and degree of translucence.



### **Harmony and Inner peace**

through well-balanced colours and natural shades of colour.

---



### **Joy of living**

through vibrant colours.

---







## Healthy shade provider, protection from harmful UV radiation

The sun is a source of life and its light provides our bodies with essential vitamins, but it can also be very dangerous. Studies by the WHO indicate a threefold increase in skin diseases caused by harmful UV radiation. The UV Protection Factor (Sun Protection Factor) of our fabrics is a unit that indicates to what extent they increase the human skin's



natural protection time to direct sunlight. The length of the natural protection of human skin depends on the skin type. The following textiles in our collection have been tested and certified according to the latest and most stringent standard UV 801.

### Sun Protection Factor

### Effect on personal well-being

	 UV STANDARD 801 Test-No. 35120 ÖTI GmbH	 UV STANDARD 801 Test-No. 33282 ÖTI GmbH	 UV STANDARD 801 19.1.10.0049-80-1 Hohenstein 19.1.10.0049-80-2 Hohenstein Test-No. 35122 ÖTI GmbH Test-No. 74088 ÖTI GmbH		
				Joie de vivre	Inner peace
<b>MayTex-Acryl</b>					
SA 314 001, SA 314 002, SA 314 003, SA 314 007, SA 314 011, SA 314 014, SA 314 143, SA 314 396, SA 314 397, DA 7560			80	•	
SA 314 006, SA 314 016, SA 314 022, SA 314 028, SA 314 038, SA 314 044, SA 314 045, SA 314 154, SA 314 347, SA 314 362, SA 314 364, SA 314 398, SA 314 402, SA 314 414, SA 314 546, SA 314 624, SA 314 763, SA 314 851, DA 7244, DA 7559, DA 8203, DA 8779			80		•
SA 314 030, SA 314 325, SA 314 471, SA 314 583		60			•
SA 314 010, SA 314 018, SA 314 033, SA 314 580	40				•
<b>MayTex-Poly</b>			80		

## How high is your personal protection factor? Type 1-6

Typ	Characteristics	Reaction of the unprotected skin to 30 mins. radiation in June	The human skin's natural protection time	Protection time of the skin when shaded by a parasol		
				 UV STANDARD 801 Test-No. 35120 ÖTI GmbH	 UV STANDARD 801 Test-No. 33282 ÖTI GmbH	 UV STANDARD 801 19.1.10.0049-80-1 Hohenstein 19.1.10.0049-80-2 Hohenstein Test-No. 35122 ÖTI GmbH Test-No. 74088 ÖTI GmbH
1	light skin, freckles, fair or red hair, blue or green eyes	always sunburn no tan	5-10 minutes	200-400 minutes	300-600 minutes	400-800 minutes
2	light skin, fair hair, blue or green eyes	always sunburn a slight tan	10-20 minutes	400-800 minutes	600-1200 minutes	800-1600 minutes
3	dark hair, blue eyes	slight sunburn a good tan	20-30 minutes	800-1200 minutes	1200-1800 minutes	1600-2400 minutes
4	dark skin, dark or black hair, brown eyes	no sunburn a good tan	approx. 45 minutes	approx. 1800 minutes	approx. 2700 minutes	approx. 3600 minutes
5	dark skin, black hair, dark eyes	no sunburn	approx. 60 minutes	approx. 2400 minutes	approx. 3600 minutes	approx. 4800 minutes
6	black skin, black hair, black eyes	no sunburn	approx. 90 minutes	approx. 3600 minutes	approx. 5400 minutes	approx. 7200 minutes

## Product properties of fabrics

Parasol cloths are high-performance products. However, given the requirements that have to be met in the field of environmental protection, there is a limit to the degree of perfection that can be achieved in spite of present-day state-of-the-art production and processing. As a result, customers may occasionally lodge complaints regarding certain features that can appear on the cloth. Such features neither alter the value of the product, nor do they impair its usability in any way. As we feel committed to providing full consumer information and thus hope to avoid irritation or dissatisfaction, we should like to draw your attention to the following features:

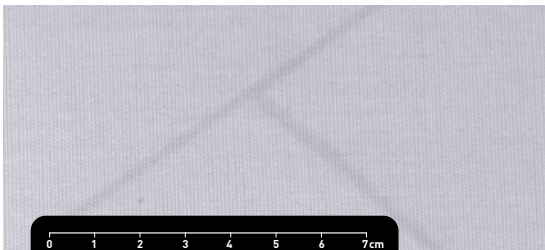

### Crease marks

Crease marks may appear during the production process or when folding the parasol fabric. When held against the light, cloths – particularly those of a light colour – may appear to have a dark streak in the crease.

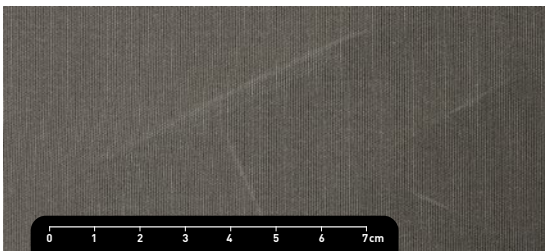

### Chalk effect

Light chalk-like stripes may arise during the processing of materials. Although the greatest of care is taken, they cannot always be totally avoided. They should, however, not be cause for complaint.

### Water/rain resistance

Acrylic canopy covering are impregnated with a water-repelling finish and can withstand short periods of light rainfall if treated with proper care. During lengthy periods of rainfall or heavy downpours, how-ever, the parasol should remain closed in order to prevent any material damage. If the cloth becomes wet, the canopy covering should be opened again as soon as possible to allow it to dry.

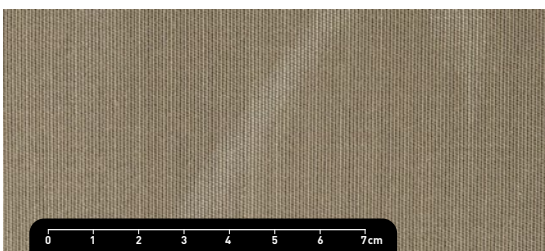

### Abrasion marks

In the course of time abrasion may weaken the canopy fabric and thus impair its quality. This can be avoided by pulling the cloth between the spokes when closing the parasol and then securing it with a strap to prevent flapping.



### Cleaning instructions

Stains can be cleaned off with a soft brush and CleanoMay 13. Rinse well afterwards with clean water to remove all detergents from the fabric. A high-pressure hose may be used for large-area surfaces (max. 30°C, max. 30 bar, min. distance from canopy covering 30 cm, cleaner: CleanoMay 13, 1 litre concentrate yields 26 litres liquid cleanser).

### Characteristic features of our sewing yarn:

- high tensile strength
- optimum abrasion resistance
- well-balanced elongation property
- high thermal resilience
- good light and weather fastness

### ALTERNATING SEGMENT COLOURS

Alternating segment colours are available as illustrated.

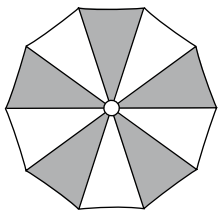

1/8-division

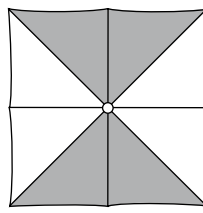
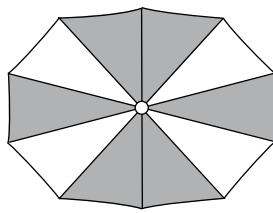

1/4-division

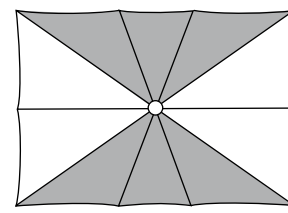

1/4-division

### Bordering

The canopy covering is trimmed with high-quality polyacrylic edge binding. If not specified otherwise, the border will be chosen to match the colour of the canopy fabric. For special optical accents you may also choose the canopy and binding in contrasting colours.

### **Energy for generations**

The MAY partner illwerke vkw AG produces electricity exclusively from renewable energy sources. Besides modern storage and pump storage power stations the illerwerke vkw AG runs power stations of different sizes all across Vorarlberg (Austria). Due to topographic conditions the most powerful stations are located in Montafon and Bregenzerwald.

The clean energy from water power is being used with respect to humans and nature, wherever possible, developed with gentle use of resources and its efficiency is increased by modern, innovative technologies.

This electricity supplier was selected, because of their environment-friendly strategy based on water power and further renewable energy sources. According to the Fuel Mix Disclosure 2019 the illerwerke AG reached an energy mix of 93 percent renewable energy, the remaining 7 percent were generated from natural gas power stations. Therefore, the carbon footprint is reduced about 330g per kilowatt hour compared to the German energy mix.

# **ENERGY**

## **ELECTRICITY FROM WATER POWER**

**clean energy**

**modern standards**

**low CO2 emissions**









# LARGEST

MANUFACTURER OF  
PARASOLS IN GERMANY

With approximately  
140 employees



## The team

Many factors contribute to the success. However, the most important is and remains the employee. The MAY company focusses on a positive working atmosphere. Challenges are coped as a team. Long-term employees and the positive atmosphere are a prove.

## Grown structures and customer satisfaction

The production in Betzenweiler is true to the motto: "Together we are strong". More than 140 motivated employees ensure quality workmanship by MAY daily. Short distances result in short responses. The MAY company is focussing on improving itself every year – for high quality products and satisfied customers.



### **The company management**

In 1983, Anton May and his wife Gertrud May set up a small family business called MAY Gerätebau.

Nowadays, after a successful company transition to the new generation, tradition in combination with modern management characterize the company. The family enterprise is run in second generation by the brothers Karl-Heinz and Klaus-Peter May.

### **The Future**

Like started in the first generation, MAY continues to count on innovation, technically high standards and flexibility.

Consistent growth proves MAY that this the right way to meet the needs of the customers. The family enterprise counts on long-term planning. Organic growth with high standards of quality ensures new solutions and outstanding products for your terrace in the future.



Anton May, company founder

## **TYPICAL GERMAN MEDIUM-SIZED COMPANIES**

**Continuity**

**Sustainability**

**Family-owned**





Karl-Heinz May  
Industrial mechanic  
Graduate industrial engineer (FH)



Klaus-Peter May  
Graduate engineer (FH)  
Graduate business administrator (BA)







For further information we will be happy to assist you.

**MAY Gerätebau GmbH**

Zum Mühlbach 1  
88422 Betzenweiler, Germany

[info@may-online.com](mailto:info@may-online.com)  
[www.may-online.com](http://www.may-online.com)

Management:  
Karl-Heinz May, Klaus-Peter May  
Amtsgericht Ulm HRB 650155