



fiberbuilt

UMBRELLAS & CUSHIONS

BUILT FOR COMFORT. BUILT TO LAST.

EDITION 22

PRESTIGE SERIES

2 Flight	12 Oceana	18 Diamante	24 Bambusa
4 Unico	14 Riva	20 Augusta	26 Palm
6 Contempo	16 Lucaya	22 Bridgewater	
8 Gusto			
10 Wattsun			

EURO COLLECTION

28 Edge
30 Venice

OFFSET COLLECTION

32 Cantina
34 Cantilever

36 Pavilions and Tents	48 Canopy Options	62 Fabrics
40 Beach Umbrellas and Cabanas	52 Accesories	71 Warranty
44 Market Umbrellas	54 Bases	
46 Patio & Garden		

CUSTOM CUSHIONS

56 Cushion Styles
60 Cushion Options
61 Pillows



FLEXIBLE FIBERGLASS RIBS

BUILT FOR COMFORT. BUILT TO LAST.

FiberBuilt Umbrellas & Cushions is dedicated to manufacturing state-of-the-art shade products for hotel, restaurant, country club, and many other hospitality and commercial uses as well as apartment and residential applications desiring contract quality umbrellas.

- Our innovative fiberglass rib construction ensures strength, resilience and durability. They absorb wind gusts, have been tested to over 50 MPH and last significantly longer than steel or wood ribbed umbrellas.
- We have developed a full line of contract quality umbrellas that hold up to the harshest weather conditions - intense sunlight, high winds, salt air and driving rain - and will not decay or lose their shape.
- For its inherent strength and longevity, the standard canopies of most of our umbrellas and cabanas are made of marine grade fabric.
- Our large scale and cantilever umbrellas provide substantial shade, have a uniquely contemporary look, and provide an architectural element to your outdoor space.
- FiberBuilt's cushion division manufactures high quality cushions and pillows. We offer a wide selection of standard and custom products that are durable, comfortable and fashionable at competitive prices with prompt lead times.

NEW FOR 2022



FLIGHT
Page 2



UNICO
Page 4



CONTEMPO
Page 6



WATTSUN
Page 10



CANTINA
Page 32

From popular, traditional models to innovative and high tech products, you'll find exactly the style, size, and options that fit the needs of your outdoor décor.

FLIGHT

PRESTIGE COLLECTION

Let your imagination take flight with the Flight umbrella. The inverted rib system of this patented model provides ample support to the canopy which is nearly horizontal when fully open. The polished aluminum upper ribs create a modern, industrial feel that appeals to boutique hotels and upscale restaurants. The 3/4" diam fiberglass ribs are encased in fabric above the canopy so that from below all you see is the fabric itself.



POLE INFORMATION

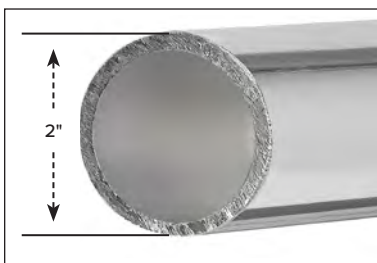

One piece, 2" diam
aluminum, .125 thickness

POLE FINISHES

BRIGHT ALUMINUM



- 24" x 2 1/2" upper ribs are gently curved polished aluminum
- Fabric encased fiberglass ribs with molded nylon joints
- Solid aluminum hub
- Pole comes in a bright, anodized aluminum finish
- Sewn-in storage ties are standard
- Custom top options include alternating panels, trim and banding
- Standard tops are made of marine or furniture grade, solution dyed acrylic. See fabric selections on pages 62-70. Tops are also available in COM.

LOCKING PULLEY DETAIL



Detail of pulley rope in Locking Lift Mechanism



The polished aluminum upper ribs and flat, solid aluminum finial provide a contemporary look.



When open the horizontal canopy has a minimal silhouette.

SIZE/ SHAPE	MODEL #	FINISH COLOR OPTIONS*	FIBERGLASS RIBS	LIFT	HEIGHT	WEIGHT
9' Oct	9FLP-A	A - Bright Aluminum	3/4" diam	Locking Pulley	108"	53 lbs
11' Oct	11FLP-A		3/4" diam	Locking Pulley	108"	70 lbs

UNICO

PRESTIGE COLLECTION

With a modern, minimalist appeal, the Unico umbrella's inverted rib system creates a canopy which is nearly horizontal. The 3/4" exposed fiberglass upper ribs and fabric covered lower ribs support the elegant silhouette of this model.



POLE INFORMATION

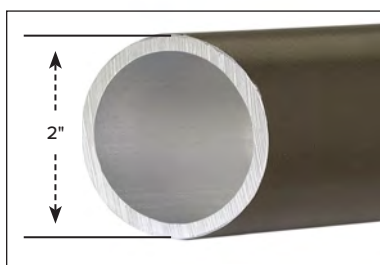

One piece, 2" diam aluminum,
.125 thickness

POLE FINISHES

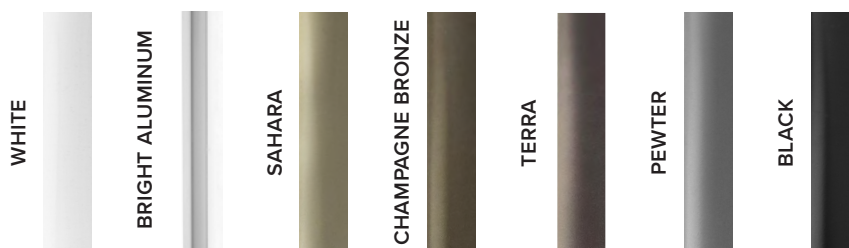

- Fiberglass ribs with molded nylon joints and hubs
- Pole finishes are powder coated
- All rib, finial and hub colors coordinate with the finish color selected for the pole except for Sahara which has Champagne Bronze ribs, finials and hubs.
- Sewn-in storage ties are standard
- Custom top options include alternating panels, trim and banding. See page 48.
- Standard tops are made of marine or furniture grade, solution dyed acrylic. See fabric selections on pages 62-70. Tops are also available in COM.

LOCKING PULLEY DETAIL



Detail of pulley rope in Locking Lift Mechanism

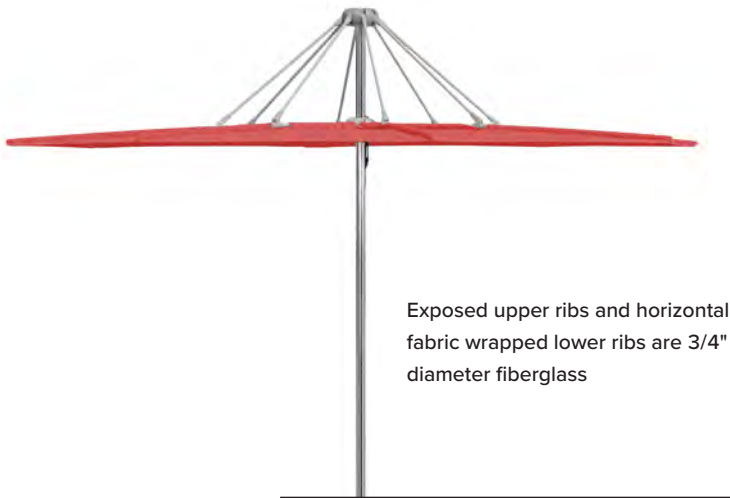

Exposed upper ribs and horizontal fabric wrapped lower ribs are 3/4" diameter fiberglass

SIZE/ SHAPE	MODEL #	FINISH COLOR OPTIONS*	FIBERGLASS RIBS	LIFT	HEIGHT	WEIGHT
9' Oct	9ULP	W - White A - Bright Aluminum S - Sahara CB - Champ.Bronze	3/4" diam	Locking Pulley	108"	40 lbs
11' Oct	11ULP	T - Terra P - Pewter K - Black	3/4" diam	Locking Pulley	108"	60 lbs

*Designate finish color by adding color letter abbreviation to the model number.

CONTEMPO

PRESTIGE COLLECTION

For a minimal silhouette and contemporary design, Contempo's a great shade solution. The 1 1/2" diameter pole allows it to be used freestanding or in-table and with seven available powder coated finishes it complements a wide variety of outdoor furnishings.



POLE INFORMATION

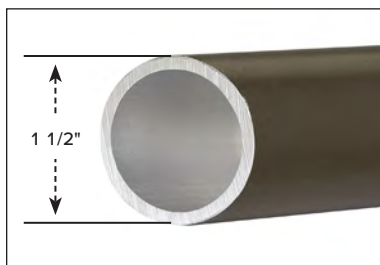

One piece, 1 1/2" diam aluminum,
.125 thickness

POLE FINISHES

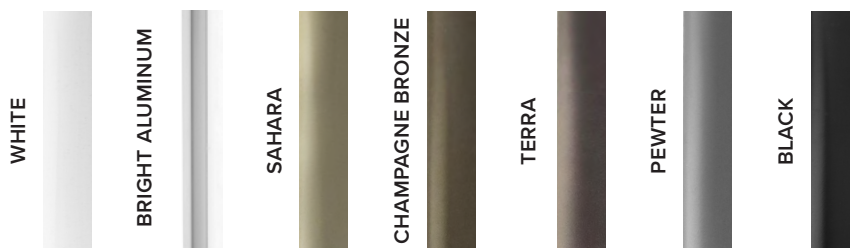

- Flexible fiberglass ribs with molded nylon joints, hubs and end tips.
- Pole finishes are powder coated. Other finish colors are available for large orders. Consult factory.
- All rib, finial and hub colors coordinate with the finish color selected for the pole except for Sahara which has Champagne Bronze ribs, finials and hubs.
- Single, sewn-in vent and storage ties are standard.
- Custom top options include double vent, alternating panels, trim, and banding. See page 48.
- Standard tops are made of marine or furniture grade, solution dyed acrylic. See fabric selections on pages 62-70. Tops are also available in COM.

HUB DETAIL WITH PUSH UP & PIN LIFT



SIZE/ SHAPE	MODEL #	FINISH COLOR OPTIONS*	FIBERGLASS RIBS	LIFT	HEIGHT	WEIGHT
8' Oct	8CPU	W - White	1/2" diam	Push Up & Pin	90"	27 lbs
9' Oct	9CPU	A - Bright Aluminum S - Sahara CB - Champ.Bronze	1/2" diam	Push Up & Pin	96"	28 lbs
11' Oct**	11CPP	T - Terra P - Pewter K - Black	1/2" diam	Push Up & Pin	102"	30 lbs
6' Sq	6SQCPU		1/2" diam	Push Up & Pin	96"	24 lbs

*Designate finish color by adding color letter abbreviation to the model number.

**For freestanding use only

GUSTO

PRESTIGE COLLECTION

With its a stylish horizontal profile, single vent, and a one piece powder coated aluminum pole with 2" diameter Gusto combines an innovative look with a durable frame.



POLE INFORMATION

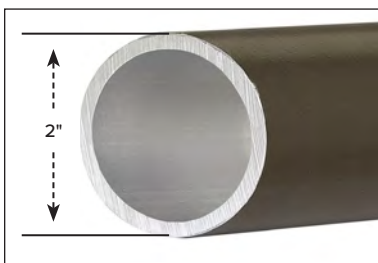

One piece, 2" diam aluminum,
.125 thickness

POLE FINISHES

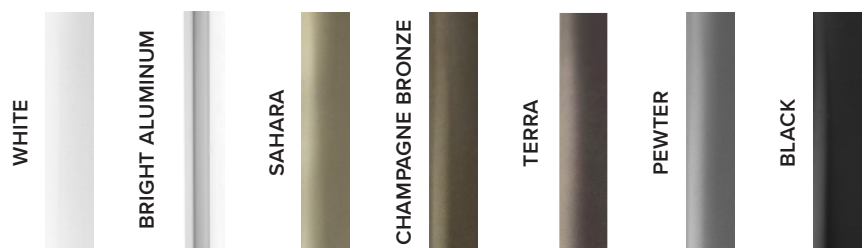

- Fiberglass ribs with molded nylon joints, hubs and end tips.
- Pole finishes are powder coated. Other finish colors are available for large orders. Consult factory.
- All rib, finial and hub colors coordinate with the finish color selected for the pole except for Sahara which has Champagne Bronze ribs, finials and hubs.
- Single, sewn-in vent and storage ties are standard.
- Custom top options include double vent, alternating panels, trim, and banding. See page 48.
- Standard tops are made of marine or furniture grade, solution dyed acrylic. See fabric selections on pages 62-70. Tops are also available in COM.

HUB DETAIL WITH PUSH UP & PIN LIFT



SIZE/ SHAPE	MODEL #	FINISH COLOR OPTIONS*	FIBERGLASS RIBS	LIFT	HEIGHT	WEIGHT
8' Oct	8GPU	W - White A - Bright Aluminum	1/2" diam	Push Up & Pin	90"	32lbs
9' Oct	9GPU	S - Sahara CB - Champ.Bronze	1/2" diam	Push Up & Pin	96"	34 lbs
11' Oct**	11GPP	T - Terra P - Pewter	1/2" diam	Push Up & Pin	102"	38 lbs
6' Sq	6SQGPU	K - Black	1/2" diam	Push Up & Pin	96"	26 lbs

*Designate finish color by adding color letter abbreviation to the model number.

**For freestanding use only



WATTSUN

PRESTIGE COLLECTION

Whether relaxing by the pool or dining al fresco, you can keep your devices charged with Wattsun. The solar power finial and 2 USB ports mounted on the umbrella's pole allow you to stay connected while you're comfortably shaded. The battery holds a charge for up to eight hours, is glass-free for safety, and charges at outlet speed.



- Flexible fiberglass ribs with molded nylon joints, hubs and end tips.
- Solar panel finial and 2 USB port charging station on the pole. Charger sits 32" from the bottom of the pole so umbrella can be used in-table.
- Pole finishes are powder coated. Other finish colors are available for large orders. Consult factory.
- All rib, finial and hub colors coordinate with the finish color selected for the pole except for Sahara which has Champagne Bronze ribs, finials and hubs.
- Single, sewn-in vent and storage ties are standard.
- Custom top options include double vent, valance, alternating panels, trim, and banding. See pages 48-51.
- Standard tops are made of marine or furniture grade, solution dyed acrylic. See fabric selections on pages 62-70. Tops are also available in COM.
- Pulley & Pin lift is available in place of Push Up & Pin for an upcharge. When ordering change the end of the model number from PU to PP.

HUB DETAIL WITH PUSH UP & PIN LIFT



PULLEY & PIN DETAIL



POLE INFORMATION

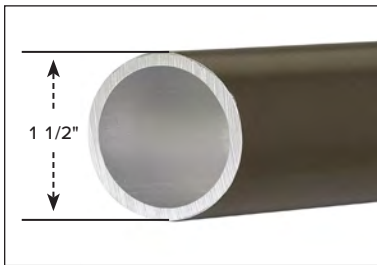

One piece, 1 1/2" diam aluminum,
.125 thickness

POLE FINISHES

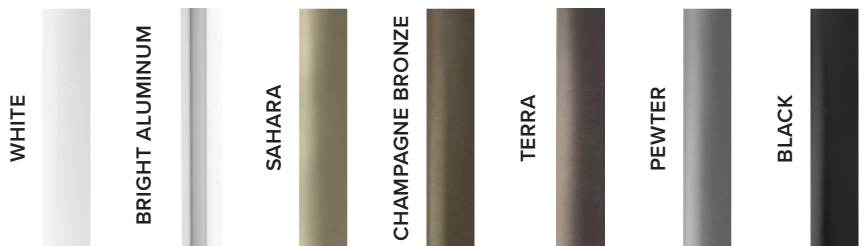

SIZE/ SHAPE	MODEL #	FINISH COLOR OPTIONS*	FIBERGLASS RIBS	LIFT	HEIGHT	WEIGHT
8' Oct	8WSPU	W - White A - Bright Aluminum S - Sahara CB - Champ.Bronze	1/2" diam	Push Up & Pin	104"	24 lbs
9' Oct	9WSPU	T - Terra P - Pewter K - Black	1/2" diam	Push Up & Pin	104"	26 lbs

*Designate finish color by adding color letter abbreviation to the model number.

OCEANA

PRESTIGE COLLECTION

These large Prestige Collection umbrellas feature a 2.5" diameter, one piece pole with a .125 aluminum wall thickness and come in seven powder coated finish colors. For freestanding use only, they provide significant shade coverage with canopy sizes up to 13' octagon or 10' square. Optional double vent or Aruba canopies are excellent for locations that experience high winds.



POLE INFORMATION

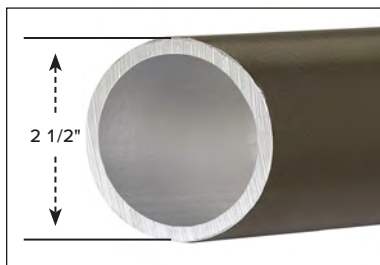

One piece, 2 1/2" diam aluminum,
.125 thickness

POLE FINISHES

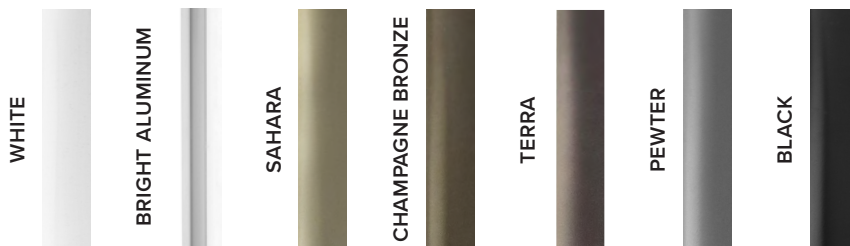

- Fiberglass ribs with molded nylon joints, hubs and end tips.
- Pole finishes are powder coated. Other finish colors are available for large orders. Consult factory.
- All rib, finial and hub colors coordinate with the finish color selected for the pole except for Sahara which has Champagne Bronze ribs, finials and hubs.
- Single sewn-in vent and storage ties are standard on most sizes. 13' Oct and 10' Sq come with Double sewn-in vents and storage ties.
- Custom top options include the Aruba extra large vent, double vent, valance, alternating panels, trim, banding and logos. See pages 48-51.
- Standard tops are made of marine or furniture grade, solution dyed acrylic. See fabric selections on pages 62-70. Tops are also available in COM.
- Pulley & Pin lift is available in place of Push Up & Pin for an upcharge. When ordering change the end of the model number from PU to PP.

Note: 2 1/2" diameter pole was designed for freestanding applications.

HUB DETAIL WITH PUSH UP & PIN LIFT



PULLEY & PIN DETAIL



SIZE/ SHAPE	MODEL #	FINISH COLOR OPTIONS*	FIBERGLASS RIBS	LIFT	HEIGHT	WEIGHT
9' Oct	9OPU		3/4" diam	Push Up & Pin	96"	37 lbs
11' Oct	11OPP	W - White	3/4" diam	Pulley & Pin	102"	45 lbs
13' Oct	13OPP	A - Bright Aluminum	3/4" diam	Pulley & Pin	108"	58 lbs
6' Sq	6SQOPU	S - Sahara	3/4" diam	Push Up & Pin	96"	35 lbs
7 1/2' Sq	7SQOPP	CB - Champ.Bronze	3/4" diam	Pulley & Pin	102"	51 lbs
10' Sq	10SQOPP	T - Terra	3/4" diam	Pulley & Pin	108"	55 lbs
		P - Pewter				
		K - Black				

*Designate finish color by adding color letter abbreviation to the model number.

RIVA

PRESTIGE COLLECTION

This heavy duty umbrella has a 2" diameter, one piece .125 wall thickness aluminum pole with 3/4" diameter ribs. Designed for use in hospitality settings such as restaurants, hotels, resorts and country clubs, it will provide years of durable service, and with seven finish colors will compliment the decor of any outdoor space.



POLE INFORMATION

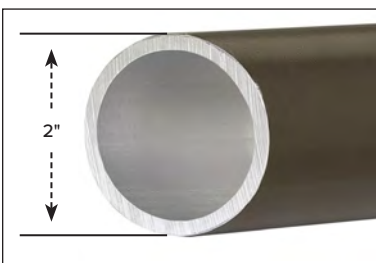

One piece, 2" diam aluminum,
.125 thickness

POLE FINISHES

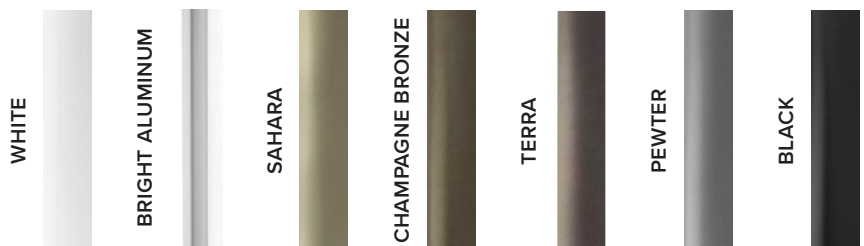

- Fiberglass ribs with molded nylon joints, hubs and end tips.
- Pole finishes are powder coated. Other finish colors are available for large orders. Consult factory.
- All rib, finial and hub colors coordinate with the finish color selected for the pole except for Sahara which has Champagne Bronze ribs, finials and hubs.
- Single sewn-in vent and storage ties are standard on most sizes. 10' Sq come with Double sewn-in vents and storage ties.
- Custom top options include the Aruba extra large vent, double vent, valance, alternating panels, trim, banding and logos. See pages 48-51.
- Standard tops are made of marine or furniture grade, solution dyed acrylic. See fabric selections on pages 62-70. Tops are also available in COM.
- Pulley & Pin lift is available in place of Push Up & Pin for an upcharge. When ordering change the end of the model number from PU to PP.

HUB DETAIL WITH PUSH UP & PIN LIFT

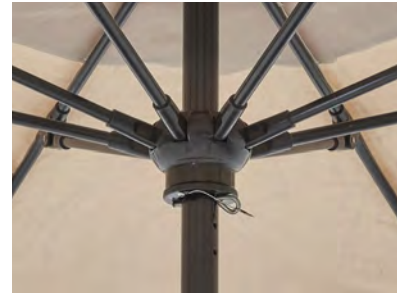

PULLEY & PIN DETAIL



SIZE/ SHAPE	MODEL #	FINISH COLOR OPTIONS*	FIBERGLASS RIBS	LIFT	HEIGHT	WEIGHT
8' Oct	8RPU		3/4" diam	Push Up & Pin	90"	30 lbs
9' Oct	9RPU	W - White A - Bright Aluminum	3/4" diam	Push Up & Pin	96"	34 lbs
11' Oct	11RPP	S - Sahara CB - Champ.Bronze	3/4" diam	Pulley & Pin	102"	38 lbs
6' Sq	6SQRPU	T - Terra P - Pewter	3/4" diam	Push Up & Pin	96"	26 lbs
7 1/2' Sq	7SQRPP	K - Black	3/4" diam	Pulley & Pin	102"	30 lbs
10' Sq	10SQRPP		3/4" diam	Pulley & Pin	108"	54 lbs

*Designate finish color by adding color letter abbreviation to the model number.

LUCAYA

PRESTIGE COLLECTION

This umbrella features a 1 1/2" diameter, one piece pole that allows for both in-table and freestanding use. To accompany a wide range of dining, lounge and chaise seating, the .125 thickness aluminum pole comes in seven finishes.



POLE INFORMATION

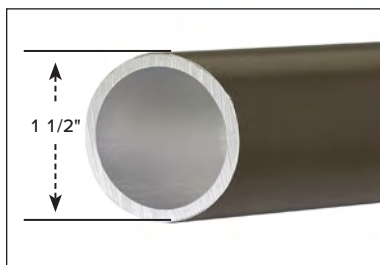

One piece, 1 1/2" diam aluminum,
.125 thickness

POLE FINISHES

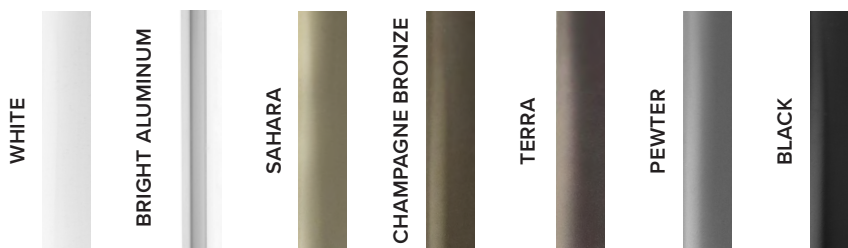

- Fiberglass ribs with molded nylon joints, hubs and end tips.
- Pole finishes are powder coated. Other finish colors are available for large orders. Consult factory.
- All rib, finial and hub colors coordinate with the finish color selected for the pole except for Sahara which has Champagne Bronze ribs, finials and hubs.
- Single, sewn-in vent and storage ties are standard.
- Custom top options include the Aruba extra large vent, double vent, valance, alternating panels, trim, banding and logos. See pages 48-51.
- Standard tops are made of marine or furniture grade, solution dyed acrylic. See fabric selections on pages 62-70. Tops are also available in COM.
- Pulley & Pin lift is available in place of Push Up & Pin for an upcharge. When ordering change the end of the model number from PU to PP.

HUB DETAIL WITH PUSH UP & PIN LIFT



PULLEY & PIN DETAIL



SIZE/ SHAPE	MODEL #	FINISH COLOR OPTIONS*	FIBERGLASS RIBS	LIFT	HEIGHT	WEIGHT
8' Oct	8LPU	W - White	1/2" diam	Push Up & Pin	90"	27 lbs
9' Oct	9LPU	A - Bright Aluminum	1/2" diam	Push Up & Pin	96"	28 lbs
11' Oct	11LPP	S - Sahara	1/2" diam	Pulley & Pin	102"	30 lbs
6' Sq	6SQLPU	CB - Champ.Bronze	1/2" diam	Push Up & Pin	96"	24 lbs
7 1/2' Sq	7SQLPP	T - Terra	1/2" diam	Pulley & Pin	102"	26 lbs
		P - Pewter				
		K - Black				

*Designate finish color by adding color letter abbreviation to the model number.

DIAMANTE

PRESTIGE COLLECTION

The largest of our Prestige FiberTeak™ umbrellas, it features a one piece, 2 1/2" diameter pole with a .125 wall thickness aluminum core and our simulated wood finish. For freestanding use only, all have 3/4" diameter ribs and provide shade coverage with canopy sizes up to 13' octagon or 10' square. Optional double vent or Aruba canopies are excellent for locations that experience high winds.



POLE INFORMATION

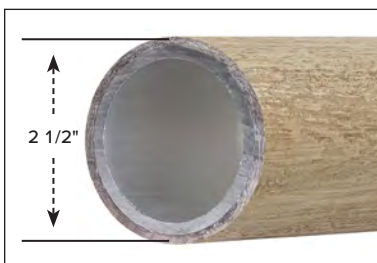

One piece, 2 1/2" diam
aluminum core, FiberTeak™
Simulated Wood Finish

POLE FINISHES



- Fiberglass ribs with molded nylon joints and end tips
- FiberTeak™ finishes on poles and finials simulate the look and feel of real wood
- The poles are made with heavy duty aluminum cores and a protective, textured fiberglass coating for excellent durability
- All rib, finial and hub colors coordinate with the pole finish color except for Aged Teak which has white ribs and hubs
- Stainless steel hardware
- Single sewn-in vent and storage ties are standard on most sizes. 13' Oct and 10' Sq come with Double sewn-in vents and storage ties.
- Custom top options include the Aruba extra large vent, double vent, valance, alternating panels, trim, banding and logos. See pages 48-51.
- Canopies are made of marine or furniture grade, solution dyed acrylic. See fabric selections on pages 62-70. Tops are also available in COM.
- Pulley & Pin lift is available in place of Push Up & Pin for an upcharge. When ordering change the end of the model number from PU to PP.

Note: 2 1/2" diameter pole was designed for freestanding applications.

HUB DETAIL WITH PUSH UP & PIN LIFT



PULLEY & PIN DETAIL



SIZE/ SHAPE	MODEL #	FINISH COLOR OPTIONS*	FIBERGLASS RIBS	LIFT	HEIGHT	WEIGHT
9' Oct	9DPU		3/4" diam	Push Up & Pin	96"	41 lbs
11' Oct	11DPP		3/4" diam	Pulley & Pin	102"	45 lbs
13' Oct	13DPP	TK - Teak CH - Chestnut AG - Aged Teak	3/4" diam	Pulley & Pin	108"	70 lbs
6' Sq	6SQDPU		3/4" diam	Push Up & Pin	96"	37 lbs
7 1/2' Sq	7SQDPP		3/4" diam	Pulley & Pin	102"	39 lbs
10' Sq	10SQDPP		3/4" diam	Pulley & Pin	108"	65 lbs

*Designate finish color by adding color letter abbreviation to the model number.

AUGUSTA

PRESTIGE COLLECTION

This Prestige model features the patented FiberTeak™ simulated wood pole with a 1 3/4" diameter, one piece, .125 wall thickness aluminum core, three woodgrain finish choices and 3/4" diameter fiberglass ribs. This structural integrity coupled with the warm wood look is more durable than actual wood umbrellas as they will not warp, check or split.



POLE INFORMATION

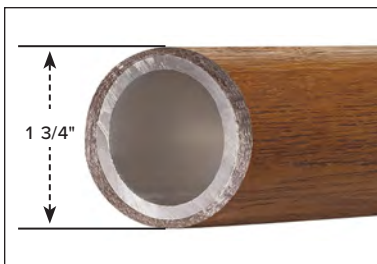

One piece, 1 3/4" diam aluminum core, FiberTeak™ Simulated Wood Finish

POLE FINISHES



- Fiberglass ribs with molded nylon joints and end tips
- FiberTeak™ finishes on poles and finials simulate the look and feel of real wood
- The poles are made with heavy duty aluminum cores and a protective, textured fiberglass coating for excellent durability
- All rib, finial and hub colors coordinate with the pole finish color except for Aged Teak which has white ribs and hubs
- Stainless steel hardware
- Single sewn-in vent and storage ties are standard on most sizes. 10' Sq come with Double sewn-in vents and storage ties.
- Custom top options include the Aruba extra large vent, double vent, valance, alternating panels, trim, banding and logos. See pages 48-51.
- Standard tops are made of marine or furniture grade, solution dyed acrylic. See fabric selections on pages 62-70. Tops are also available in COM.
- Pulley & Pin lift is available in place of Push Up & Pin for an upcharge. When ordering change the end of the model number from PU to PP.

HUB DETAIL WITH PUSH UP & PIN LIFT



PULLEY & PIN DETAIL



SIZE/ SHAPE	MODEL #	FINISH COLOR OPTIONS*	FIBERGLASS RIBS	LIFT	HEIGHT	WEIGHT
8' Oct	8APU		3/4" diam	Push Up & Pin	90"	30lbs
9' Oct	9APU		3/4" diam	Push Up & Pin	96"	36 lbs
11' Oct	11APP	TK - Teak CH - Chestnut AG - Aged Teak	3/4" diam	Pulley & Pin	102"	40 lbs
6' Sq	6SQAPU		3/4" diam	Push Up & Pin	96"	32 lbs
7 1/2' Sq	7SQAPP		3/4" diam	Pulley & Pin	102"	34 lbs
10' Sq	10SQAPP		3/4" diam	Pulley & Pin	108"	58 lbs

*Designate finish color by adding color letter abbreviation to the model number.

BRIDGEWATER

PRESTIGE COLLECTION

This contract grade umbrella features FiberBuilt's patented FiberTeak™ simulated wood pole which has a sturdy aluminum core with a .125 wall thickness and comes in three woodgrain finishes. The 1 1/2" diameter, one piece pole allows for both in-table and freestanding use.



POLE INFORMATION

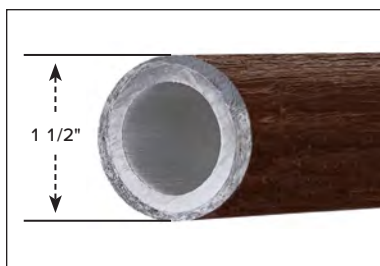

One piece, 1 1/2" diam aluminum core, FiberTeak™ Simulated Wood Finish

POLE FINISHES



- Flexible fiberglass ribs with molded nylon joints and end tips
- FiberTeak™ finishes on poles and finials simulate the look and feel of real wood
- The poles are made with heavy duty aluminum cores and a protective, textured fiberglass coating for excellent durability
- All rib, finial and hub colors coordinate with the pole finish color except for Aged Teak which has white ribs and hubs
- Stainless steel hardware
- Single, sewn-in vent and storage ties are standard
- Custom top options include the Aruba extra large vent, double vent, valance, alternating panels, trim, banding and logos. See pages 48-51.
- Standard tops are made of marine or furniture grade, solution dyed acrylic. See fabric selections on pages 62-70. Tops are also available in COM.
- Pulley & Pin lift is available in place of Push Up & Pin for an upcharge. When ordering change the end of the model number from PU to PP.

HUB DETAIL WITH PUSH UP & PIN LIFT



PULLEY & PIN DETAIL

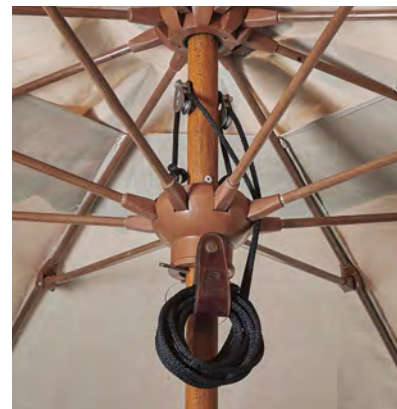

SIZE/ SHAPE	MODEL #	FINISH COLOR OPTIONS*	FIBERGLASS RIBS	LIFT	HEIGHT	WEIGHT
8' Oct	8BPU		1/2" diam	Push Up & Pin	90"	30 lbs
9' Oct	9BPU		1/2" diam	Push Up & Pin	96"	33 lbs
11' Oct	11BPP	TK - Teak CH - Chestnut AG - Aged Teak	1/2" diam	Pulley & Pin	102"	38 lbs
6' Sq	6SQBPU		1/2" diam	Push Up & Pin	96"	29 lbs
7 1/2' Sq	7SQBPP		1/2" diam	Pulley & Pin	102"	34 lbs

*Designate finish color by adding color letter abbreviation to the model number.

BAMBUSA

PRESTIGE COLLECTION

The FiberTeak™ pole on these umbrellas is hand-finished with the culms and nodes that simulate the look and feel of real bamboo. The Natural and Dark finishes compliment a variety of casual furniture and outdoor motifs. The durable finish, heavy duty hub and 3/4" ribs are designed for long-wearing, trouble-free performance.



POLE INFORMATION

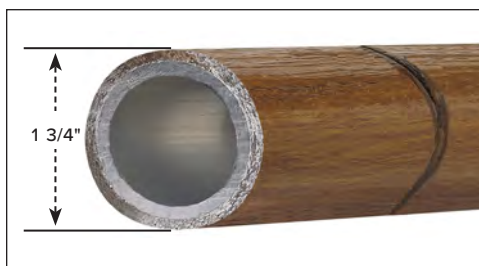

One piece, 1 3/4" diam aluminum core, FiberTeak™ Simulated Bamboo Finish

POLE FINISHES



- Flexible fiberglass ribs with molded nylon joints and end tips
- FiberTeak™ poles and finials simulate the look and feel of real bamboo, and include hand-finished culms and nodes.
- The poles are made with a heavy duty .125 wall thickness aluminum core and a protective, textured fiberglass coating for excellent durability
- Stainless steel hardware
- Single sewn-in vent and storage ties are standard
- Custom top options include the Aruba extra large vent, double vent, valance, alternating panels, trim, banding and logos. See pages 48-51.
- Standard tops are made of marine or furniture grade, solution dyed acrylic. See fabric selections on pages 62-70. Tops are also available in COM.
- Pulley & Pin lift is available in place of Push Up & Pin for an upcharge. When ordering change the end of the model number from PU to PP.
- Finial color coordinates with the pole finish. Ribs and hubs are black for both pole finishes.

HUB DETAIL WITH PUSH UP & PIN LIFT



PULLEY & PIN DETAIL



FINIAL DETAIL



SIZE/ SHAPE	MODEL #	FINISH COLOR OPTIONS*	FIBERGLASS RIBS	LIFT	HEIGHT	WEIGHT
8' Oct	8SPU		3/4" diam	Push Up & Pin	90"	32 lbs
9' Oct	9SPU		3/4" diam	Push Up & Pin	96"	36 lbs
11' Oct	11SPP	N - Natural TK - Dark	3/4" diam	Pulley & Pin	102"	40 lbs
6' Sq	6SQSPU		3/4" diam	Push Up & Pin	96"	32 lbs
7 1/2' Sq	7SQSPP		3/4" diam	Pulley & Pin	102"	34 lbs

*Designate finish color by adding color letter abbreviation to the model number.

PALM

PRESTIGE COLLECTION

The highly textured palm tree's trunk was the inspiration for this model's pole. The unique design incorporates a simulated bark-like pole, coconut shaped finial and unique multi-vented palm frondesque canopy. The layered tiers of fabric provide superior wind management and are recommended for properties that experience constant ocean breezes.



POLE INFORMATION

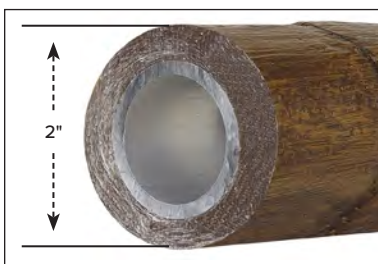

One piece,
aluminum core,
FiberTeak™ Simulated
Coconut Palm Finish

POLE FINISHES



- Flexible fiberglass ribs with molded nylon joints and end tips
- FiberTeak™ poles and finials simulate the look and feel of a real Coconut Palm Tree
- The poles are made with a heavy duty .125 wall thickness aluminum core and a protective, textured fiberglass coating for excellent durability
- Stainless steel hardware
- Single sewn-in vent and storage ties are standard
- Multi-layer palm leaf canopy with binding
- Standard tops are made of marine or furniture grade, solution dyed acrylic. See fabric selections on pages 62-70. Tops are also available in COM.

PULLEY & PIN DETAIL



The multiple layers of this unique canopy are shaped to resemble palm fronds.

SIZE/ SHAPE	MODEL #	FINISH COLOR OPTIONS*	FIBERGLASS RIBS	LIFT	HEIGHT	WEIGHT
8' Oct	8PPP		3/4" diam	Pulley & Pin	96"	45 lbs
9' Oct	9PPP	BARK	3/4" diam	Pulley & Pin	96"	48 lbs
11' Oct	11PPP		3/4" diam	Pulley & Pin	102"	55 lbs

Designed for freestanding use. Will fit in base that accommodates 2" pole.



10 ft Octagon Edge



EDGE

EURO COLLECTION

The Edge cantilever umbrellas sport clean lines, a contemporary feel and a touch of European panache. Unique features include the easy open lift design, the 80° inclined aluminum pole and a 360° rotation. Coupled with the multiple angles to which the canopy can be set, this chic style provides all day shade.

- 360° rotating pole and canopy
- 8 rectangular fiberglass ribs
- 80° forward-leaning inclined pole
- Platinum powder coated aluminum, stainless steel hardware and nylon accessories
- Non-vented canopy is standard
- Canopies are made of furniture grade, solution dyed acrylic. See pages 65-70. Tops are also available in COM.
- In horizontal position, canopy clearance is 77". In fully tilted position, total height is 150".
- Cast aluminum hub
- Stainless steel latch to lock ribs
- Accordion-fold canopy closure and covered ribs
- Umbrella and Base sold as a set



BASE PLATE

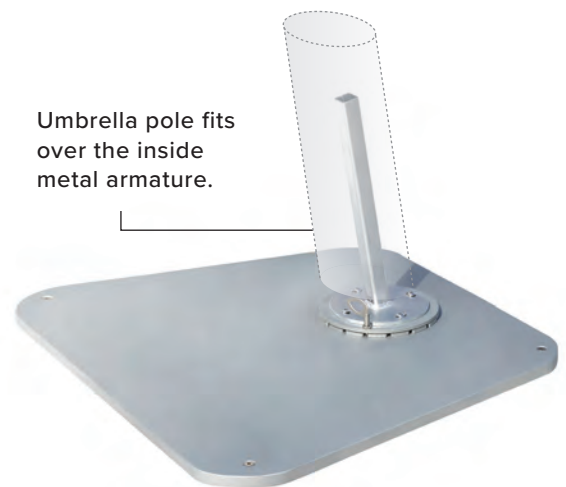

Trapezoid shape base with curved corners, 32" W (narrow end) x 42" (wide end) x 36" L x 1" H
Rotator Plate is 10" diam



Closure Clip



Push Up Lift Handle

SIZE/ SHAPE	MODEL #	FINISH COLOR OPTIONS*	OFFSET POLE	FIBERGLASS RIBS	HEIGHT	WEIGHT
10' Oct	10EDGE-PL	Platinum	4" fluted oval	3/4" diam	102"	485 lbs
10' Sq	10SQEDGE-PL		4" fluted oval	3/4" diam	102"	485 lbs



VENICE

EURO COLLECTION

This large scale umbrella is available in two sizes - 16' and 20' squares - that provide shade to either 256 or 400 square feet, respectively. Canopies are manufactured with double, sewn-in vents to provide excellent wind control. The heavy duty base affords a stable and complementary foundation to this imposing shade structure.

- Telescopic opening and closing system with lift rod
- 8 rectangular aluminum ribs
- Carbon powder coated finished aluminum and steel structure with nylon accesories
- Steel cross base structure for (4) 19"x 19" granite tiles with handles
- Double, sewn-in vent with storage ties standard
- Canopies are made of marine or furniture grade, solution dyed acrylic. See fabric selections on pages 62-70. Tops are also available in COM.
- Custom top options include valance, alternating panels, banding and logos. See pages 48-51.
- Umbrella and Base sold as a set

BASE PLATE



HUB DETAIL

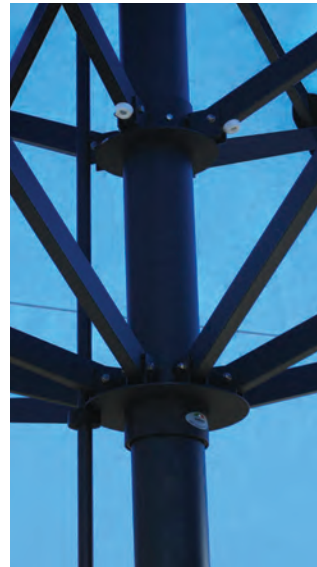

SIZE/ SHAPE	MODEL #	FINISH COLOR OPTIONS*	CENTER POST	RIBS	HEIGHT	WEIGHT
16' Sq	16SQVTPCR	Carbon	4" diam	Aluminum 13/16" x 1 9/16"	189"	810 lbs
20' Sq	20SQVTPCR		4" diam	Aluminum 13/16" x 1 9/16"	214"	840 lbs



CANTINA

EURO COLLECTION

Providing shade to multiple dining tables at restaurants or multiple chaise lounges on a pool deck, this cantilever model is an excellent choice. The 360° rotating pole allows you to move the shade throughout the day without repositioning the base. The push up handle with comfort-grip trigger lift means the 10 ft canopy can be raised and readjusted in seconds.

- 360° rotating pole and canopy – 8 rectangular aluminum ribs
- Carbon finished aluminum frame and fittings
- Hydraulic gas strut minimizes the effort to open and close the umbrella.
- Trigger lift with push up handle
- Steel cross base structure for (4) 19"x 19" granite tiles with handles
- Single, sewn-in vent and storage ties are standard
- Canopies are made of furniture grade, solution dyed acrylic. See fabric selections on pages 65-70.
- Custom top options include valance, alternating panels, banding and logos. See pages 48-51.
- Umbrella and base sold as a set

BASE DETAIL



Frame shown in closed position

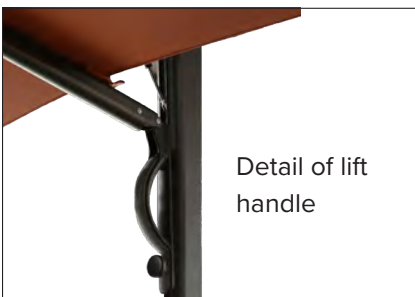

Detail of lift handle



Underside of canopy

SIZE/ SHAPE	MODEL #	FINISH COLOR OPTIONS*	OFFSET POLE	RIBS	HEIGHT	WEIGHT
10' Sq	10CANTINA-CR	Carbon	4 3/8" x 3"	Aluminum	108"	420 lbs



CANTILEVER

When your outdoor dining area would function better with an offset umbrella, our Cantilever model will provide the coverage you need without the interference of a center pole. These double vented, aluminum frame contract grade umbrellas are available in a wide array of fabrics to compliment any decor. Our 360° rotating Cantilever umbrella features a smooth-glide trigger lift mechanism and a foot activated rotator to provide 100 square feet of comfortable shade.



Detail of Trigger Lift Mechanism

- 360° rotating pole and canopy
- 8 rectangular aluminum ribs
- Bronze finished aluminum frame and fittings
- Trigger lift with crank
- Steel cross base for (4) 80 lb. granite tiles
- Double, sewn-in vent and storage ties are standard
- Canopies are made of furniture grade, solution dyed acrylic. See fabric selections on pages 65-70. Tops are also available in COM.
- Custom top options include valance, alternating panels, banding and logos. See pages 48-51.

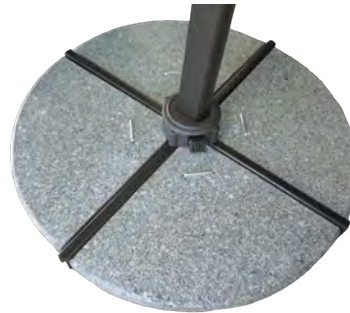

Foot Activated Lever to Rotate Pole 360°

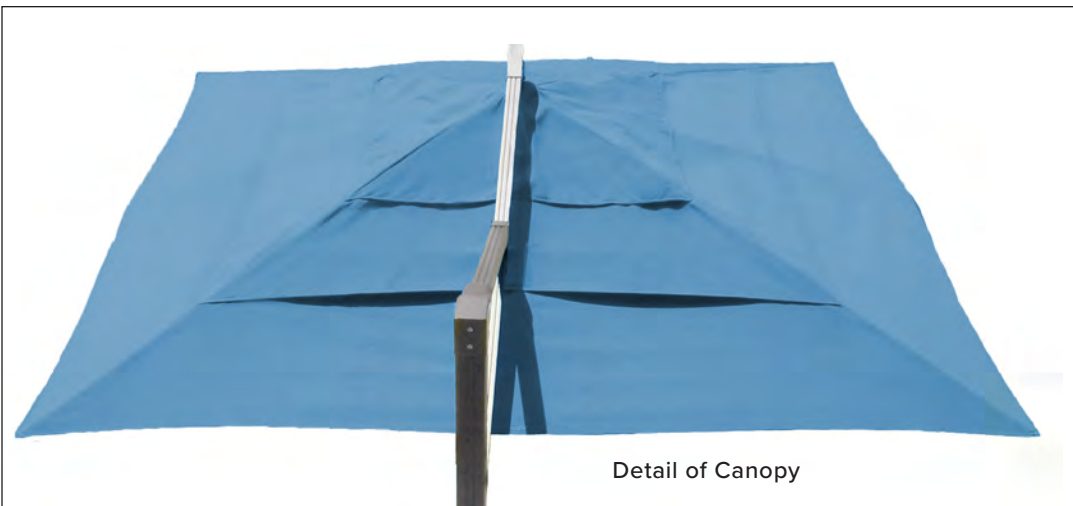

Detail of Canopy

SIZE/ SHAPE	MODEL #	FINISH COLOR OPTIONS*	OFFSET POLE	RIBS	HEIGHT	WEIGHT
10' Sq	10CANT-CB	Bronze	2 3/4" x 3 1/2"	Aluminum	111"	420 lbs



Shown with Banding, Tiebacks and Light and Fan Kit in Stainless Steel finish



Shown with Tiebacks and Light and Fan Kit in Stainless Steel finish

PAVILIONS

- Semi-permanent shade structure
- Umbrella style canopy with fiberglass ribs, molded nylon joints and end tips
- Frame available in heavy duty aluminum or FiberTeak™ simulated wood
- Welded aluminum connectors
- Legs have anchor plates with holes for mounting
- Standard canopies with double vent and valance are made of marine or furniture grade, solution dyed acrylic. Side panels are made of furniture grade fabric. See fabric selections on pages 62-70. Tops are also available in COM.
- Side panels can be zipped closed
- Velcro tie backs secure side panels to the frame
- Options include 4" band in coordinating fabric (at bottom of valance, bottom of drapes, and for tie backs)
- Optional Light and Fan Kit: 48" overall length.
- Dual 14" diam. cage fans, rotates 360 degrees for optimal circulation. Aged Bronze and Stainless Steel finishes. Battery operated remote control included.



Light and Fan Kit shown in Aged Bronze Finish

POLE FINISHES

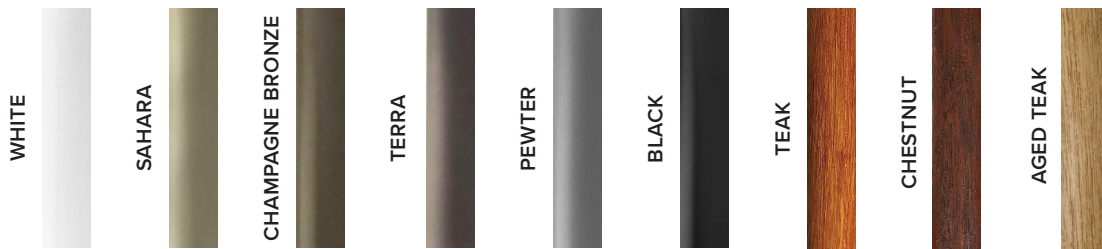

SIZE/ SHAPE	MODEL #	FINISH COLOR OPTIONS*	LEGS	RIBS	HEIGHT	WEIGHT
10' Sq	PAVR	W - White S - Sahara CB - Champ.Bronze	2" Aluminum	Aluminum	120"	130 lbs
10' Sq	PAVO	T - Terra P - Pewter K - Black	2 1/2" Aluminum	Aluminum	120"	140 lbs
10' Sq	PAVA	TK - Teak CH - Chestnut	2" FiberTeak™	FiberTeak	120"	150 lbs
10' Sq	PAVD	AG - Aged Teak	2 1/2" FiberTeak™	FiberTeak	120"	165 lbs

*Designate finish color by adding color letter abbreviation to the model number.

PORTABLE POP UP TENTS



CHOICE TENT

- Durable aluminum frame construction with aluminum ribs
- 1 1/4" hexagonal tubular aluminum legs
- Telescoping legs for adjustable height
- Nylon joints
- 300 denier polyester canopy in white



MERIDIAN TENT

- Durable aluminum frame construction with aluminum ribs
- 1 1/4" hexagonal tubular aluminum legs
- Telescoping legs for adjustable height
- Nylon joints
- Solution dyed acrylic canopy
- Optional side panels available



DELUXE TENT

- Heavy duty aluminum frame construction with aluminum ribs
- Sturdy 2 1/2" hexagonal legs
- Telescoping legs for adjustable height
- Cast aluminum joints
- Solution dyed acrylic canopy
- Optional side panels and logos available



Frame Closes to
13" x 13" x 62"

ALL TENT STYLES FEATURE:

- Easy open and set up - no tools required
- Legs have anchor plates with holes for mounting
- Standard canopies on Meridian and Deluxe models are made of marine or furniture grade, solution dyed acrylic. See fabric selections on pages 62-70. Tops are also available in COM.
- Storage bag is included

	SIZE/ SHAPE	MODEL #	FINISH COLOR OPTIONS*	LEGS	RIBS	HEIGHT	WEIGHT
CHOICE	10' Sq	TN-CH	Anodized Aluminum	1 1/4" Hex	Aluminum	122" - 130"	45 lbs
MERIDIAN	10' Sq	TN-MD	Anodized Aluminum	1 1/4" Hex	Aluminum	122" - 130"	48 lbs
	10' Sq	TN-MDX*	Anodized Aluminum	1 1/4" Hex	Aluminum	122" - 130"	74 lbs
DELUXE	10' Sq	TN-DL	Anodized Aluminum	2 1/2" Hex	Aluminum	122" - 130"	78 lbs
	10' Sq	TN-DLX*	Anodized Aluminum	2 1/2" Hex	Aluminum	122" - 130"	104 lbs

*X in model number indicates the inclusion of side panels with zipper closure and Velcro tie backs



BEACH - WOOD

- White flexible fiberglass ribs with molded nylon joints, hubs and end tips
- Rust resistant hardware
- Standard canopy is single vent with valance
- Standard tops are made of marine grade, solution dyed acrylic. See fabric selections on pages 62-64.
- Pointed end tip for easy beach set up

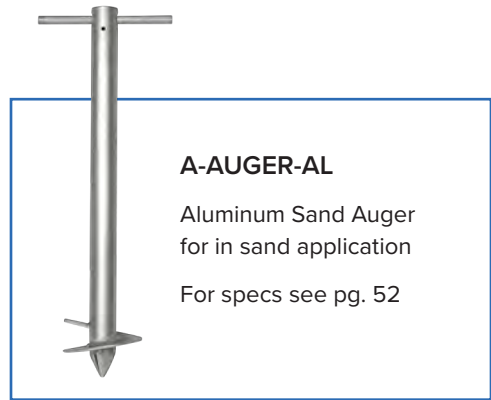

POLE FINISH



NATURAL ASH

DETAIL OF
POLE TIP

DETAIL OF 8 RIB HUB



7CAR-BAG

Optional Beach Umbrella Bag can be ordered in matching fabric color

SIZE/ SHAPE	MODEL #	FINISH COLOR OPTIONS*	POLE	FIBERGLASS RIBS	LIFT	HEIGHT	WEIGHT
7 1/2' Oct	7BPU-WASH	Natural Ash	Two piece solid hard wood, 1 1/2" diam. with pointed tip	(8) 1/2" diam	Push Up	90"	18 lbs
7 1/2' Hex	7BPU-6R-WASH		Two piece solid hard wood, 1 3/8" diam with pointed tip	(6) 3/8" diam	Push Up	90"	16 lbs



BEACH - ALUMINUM

- White flexible fiberglass ribs with molded nylon joints, hubs and end tips
- One piece, aluminum pole with .125 wall thickness
- Push up and pin lift
- Rust resistant hardware
- Standard canopy is single vent with valance
- Standard tops are made of marine grade, solution dyed acrylic. See fabric selections on pages 62-64.
- Angled end tip for easy beach set up
- Custom top options include market style canopy, alternating panels, and logos

POLE FINISH



MILLED
ALUMINUM

DETAIL OF
ANGLE END TIP

DETAIL OF 8 RIB HUB



TOP VENT AND FLAT FINIAL



SIZE/ SHAPE	MODEL #	FINISH COLOR OPTIONS*	POLE	FIBERGLASS RIBS	LIFT	HEIGHT	WEIGHT
7 1/2' Oct	7BPU-AL	Mill	One piece, 1 1/2" diam aluminum, .125 thickness	(8) 1/2" diam	Push Up & Pin	90"	27 lbs
8' Oct	8BPU-AL	Mill	One piece, 1 1/2" diam aluminum, .125 thickness	(8) 1/2" diam	Push Up & Pin	90"	28 lbs



BEACH CABANA

Provide your guests with surfside space and shade to call their own. These generously sized Cabanas are large enough for two chaise lounges and lots of beach-going supplies. An optional mesh panel is available for extra wind management.

- Size: 80"w x 67"d x 67"h
- Fits two side by side standard chaise lounges
- 3/4" and 1/2" diam. Aluminum ribs with mill finish
- Cover is made of marine grade, solution dyed acrylic. See fabric selections on pages 62-64.
- An optional open weave mesh panel for added wind resistance is also available. Consult factory.
- Aluminum hardware and foot
- For greater stability, 5" x 12" cabana foot inserts into sand
- Weight: 62 lbs.



<p>STANDARD CABANA</p> <p>Model Number CAB-8067</p>	<p>CABANA WITH MESH PANEL</p> <p>Model Number B-CABANA-M</p>
--	---



MARKET

WITH CRANK, PUSH UP & PIN AND PULLEY & PIN

This popular, budget-friendly, contract grade umbrella comes with a two piece aluminum pole, solution dyed acrylic canopy and three lift options - Crank, Push Up & Pin and Pulley & Pin.



POLE INFORMATION

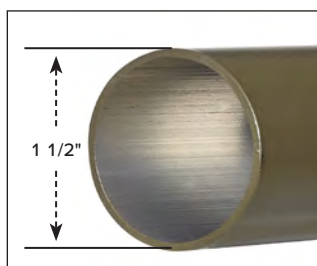

Two piece,
1 1/2" diam
aluminum,
.080 thickness

POLE FINISHES

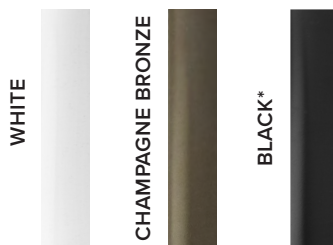

- Flexible fiberglass ribs with molded nylon joints, hubs and end tips
- Powder coated finishes
- Single vent canopies standard with vent ties and storage ties
- Custom top options include double vent, sewn vents, valance, alternating panels, trim, banding and logos. See page 48-51.
- Standard tops are made of marine or furniture grade, solution dyed acrylic. See fabric selections on pages 62-70.

HUB DETAIL WITH PUSH UP & PIN LIFT



PULLEY & PIN DETAIL

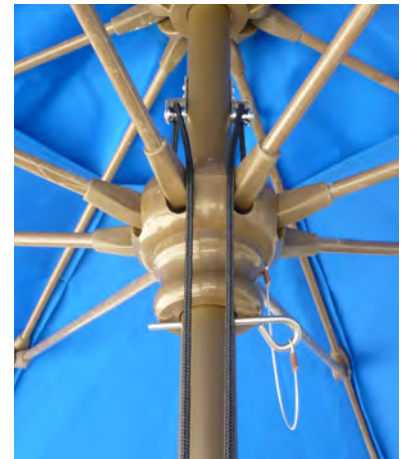

SIZE/ SHAPE	MODEL #	FINISH COLOR OPTIONS*	FIBERGLASS RIBS	LIFT	HEIGHT	WEIGHT	ACCESSORY
7 1/2' Oct	7MCRW 7MCRCB 7MCRK	White Champ. Bronze Black	1/2" diam	Crank	90"	19 lbs	
9' Oct	9MCRW 9MCRCB	White Champ. Bronze	1/2" diam	Crank	96"	22 lbs	
7 1/2' Oct	7MCRW-T 7MCRCB -T 7MCRK -T	White Champ. Bronze Black	1/2" diam	Crank	90"	19 lbs	Push Button Tilt†
9' Oct	9MCRW-T 9MCRCB -T 9MCRK -T	White Champ. Bronze Black	1/2" diam	Crank	96"	22 lbs	Push Button Tilt†

†On Tilt models lower pole has .080 wall thickness, upper pole has .065 wall thickness.

7 1/2' Oct	7MPUW 7MPUCB 7MPUK	White Champ. Bronze Black	1/2" diam	Push Up & Pin	90"	16 lbs	
9' Oct	9MPPW 9MPPCB	White Champ. Bronze	1/2" diam	Pulley & Pin	96"	22 lbs	
11' Oct	11MPPW 11MPPCB	White Champ. Bronze	1/2" diam	Pulley & Pin	102"	28 lbs	
6' Sq	6SQMPPW 6SQMPPCB	White Champ. Bronze	1/2" diam	Pulley & Pin	96"	18 lbs	
7 1/2' Sq	7SQMPPW 7SQMPPCB	White Champ. Bronze	1/2" diam	Pulley & Pin	102"	20 lbs	

RE-ENGINEERED TO BE STRONGER THAN EVER

PATIO HOME COLLECTION

- Flexible fiberglass ribs with molded nylon joints, hubs and end tips
- Powder coated finishes
- Market style canopy with single sewn-in vent
- Spun acrylic canopies
- Two piece, 1 1/2" diam aluminum pole, .080 wall thickness. Tilt models have .065 wall thickness on upper half.
- Canopies are available in 6 Spun Acrylic colors.



Specifically designed for residential use. Tilt umbrellas are not warranted for contract applications.

CANOPY COLORS



Actual colors may vary from images shown.

POLE FINISHES

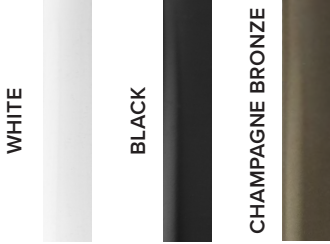

SIZE/ SHAPE	MODEL #	FINISH COLOR OPTIONS	FIBERGLASS RIBS	LIFT	HEIGHT	WEIGHT	ACCESSORY
7 1/2' Oct	7HCRW 7HRCRB 7HCRK	White Champ. Bronze Black	(8) 1/2" diam	Crank	90"	15 lbs	
7 1/2' Oct	7HCRW-T 7HRCRB-T	White Champ. Bronze	(8) 1/2" diam	Crank	90"	15 lbs	Push Button Tilt
7 1/2' Oct	7HPUCB 7HPUK 7HPUW	Champ. Bronze Black White	(8) 1/2" diam	Push Up	96"	15 lbs	
9' Oct	9HCRW 9HRCRB 9HCRK	White Champ. Bronze Black	(8) 1/2" diam	Crank	96"	17 lbs	
9' Oct	9HCRW-T 9HRCRB-T 9HCRK-T	White Champ. Bronze Black	(8) 1/2" diam	Crank	96"	17 lbs	Push Button Tilt
9' Oct	9HPUCB 9HPUW	Champ. Bronze White	(8) 1/2" diam	Push Up	96"	17 lbs	



GARDEN

HOME COLLECTION

- Flexible fiberglass ribs with molded nylon joints, hubs and end tips
- Anodized and powder coated finishes
- Valance style canopy is made of vinyl coated weave
- Two piece, 1 1/2" diam aluminum pole with .065 wall thickness

POLE FINISHES



Specifically designed for residential use.
Tilt umbrellas are not warranted for contract applications

VINYL COATED WEAVE CANOPY COLORS



Actual colors may vary from images shown.

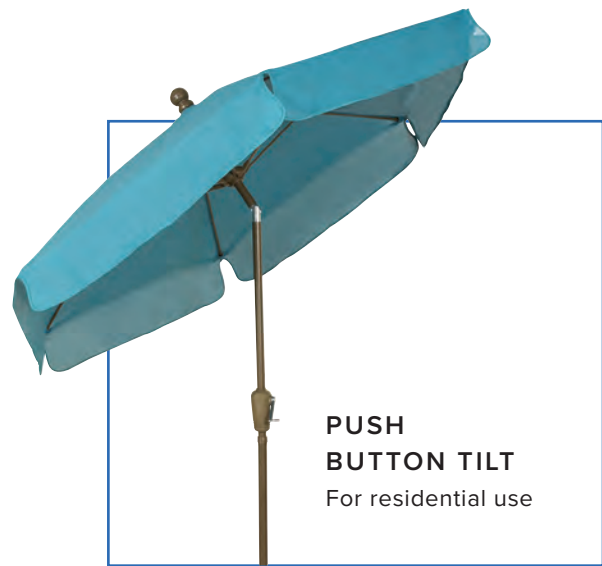

SIZE/ SHAPE	MODEL #	FINISH COLOR OPTIONS*	FIBERGLASS RIBS	LIFT	HEIGHT	WEIGHT	ACCESSORY
7 1/2' Hex	7GCRW 7GCRCB 7GCRA	White Champ. Bronze Bright Aluminum	(6) 3/8" diam	Crank	90"	15 lbs	Push Button Tilt
7 1/2' Hex	7GCRW-T 7GCRCB-T	White Champ. Bronze	(6) 3/8" diam	Crank	90"	15 lbs	Push Button Tilt
7 1/2' Hex	7GPIA 7GPICB	Bright Aluminum Champ. Bronze	(6) 3/8" diam	Push Up	90"	15 lbs	

CANOPY PATTERNS

Inquire about even greater options to customize through the use of fabrics.



standard single vent



single vent with 4" banding and 2 fabrics



double vent with (3) 4" bandings



double vent with 2 alternating vent fabrics



single vent with 4" banding



single vent with alternating panels



single vent with 2 fabrics



single vent with 1" trim

CANOPY DESIGN OPTIONS

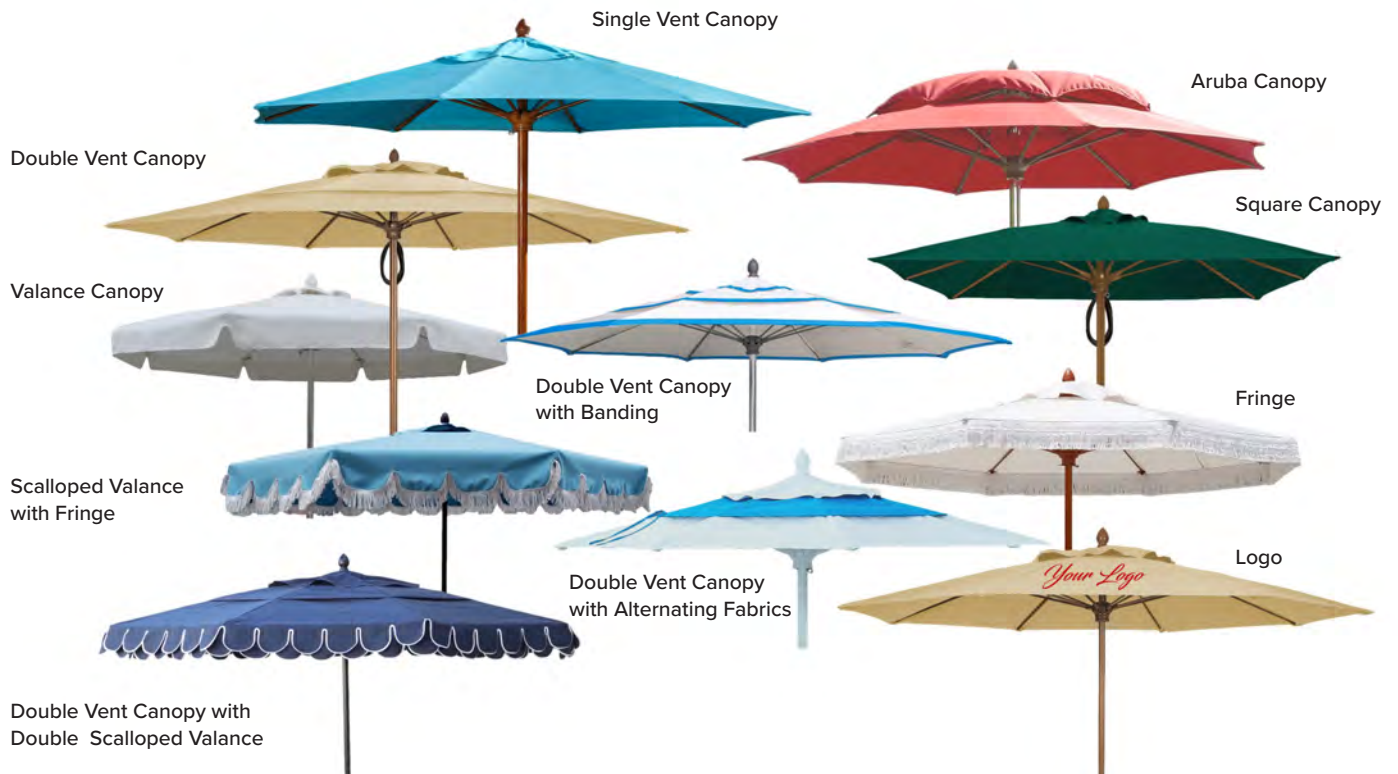

VALANCE CANOPY OPTIONS



Valance canopy with logo



Valance canopy with multiple scallops



Single Valance-VAL



Single Valance with Three Swags-VAL-S3

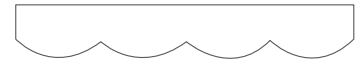

Single Valance with Four Swags-VAL-S4

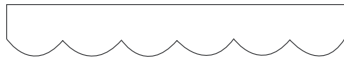

Single Valance with Six Swags-VAL-S6



Double Valance with Six Swags-VAL-SD12



Single Valance with Wave Pattern-VAL-WV



Single Dental Molding with Four Teeth - VAL-DM



Double Dental Molding with Four Teeth - VAL-DDM



Double Square Scallop-VAL-DSS8

EXAMPLES OF SCALLOPED VALANCES WITH CONTRASTING TRIM



FRINGE STYLES



Bullion Fringe



Decorative Header Fringe



Brush Fringe

ARUBA CANOPY

Available on Lucaya, Riva, Oceana, Bridgewater, Augusta, Diamante and Bambusa umbrellas

- Extra large vent designed for superior wind resistance.
- All standard options regarding canopy designs and patterns apply to these canopies.
- Standard tops are made of marine or furniture grade, solution dyed acrylic. See fabric selections on pages 62-70. Tops are also available in COM.



Detail of Fabric Covered Joint



WHEN ORDERING, ADD THE FOLLOWING CANOPY STYLE TO THE SELECTED UMBRELLA MODEL:

- ARUBA8 - for 8' diam
- ARUBA9 - for 9' diam
- ARUBA11 - for 11' diam

For example, a 9' Bridgewater with Chestnut finish and an Aruba Canopy would be: 9BPU-CH-ARUBA9

A **Double Vent Canopy** is another recommended style for umbrellas that will be used in locations prone to high or gusty winds such as seaside, lakeside, mountainous region or rooftops.

The additional vent allows more dispersal of the wind's energy. Double Vent Canopies are available on most Prestige Collection umbrellas. Canopies can either be made in all marine or furniture grade solution dyed acrylic or with the middle vent made of an open weave mesh that allows even more wind to sail through the canopy. Mesh is available in White, Pacific Blue and Forest Green.



Middle vent with Open Weave Mesh

CUSTOM LOGOS

SILK-SCREENED AND EMBROIDERED

- Silk screened logos can be applied to all umbrellas except Garden and Patio.
- Vector artwork and color specifications are required. Acceptable file formats are: AI, EPS and PSD. Note that for crisp images and fine, straight lines JPG, PNG and TIF files are not accepted for silk screening purposes.
- If vector artwork is not available, we can convert the image to the proper format for an additional charge. Charge depends on the complexity of the logo.
- On the valance, the maximum print size is 18.5" w x 4" h. Larger scale models, such as our 10ft Sq umbrellas, tents and pavilions, have larger valances and the imprint area may increase. Consult factory.
- On the panels, the print size depends on the shape of the logo. For rectangular logos, the maximum size 18.5" w x 12.5" h. For square or round logos, the maximum size 13.5" w x 11.5" h.
- In addition to panel or valance location, indicate how many times the logo is to be printed: on every side, on alternating sides (with blank panels in between), on opposite sides or once per umbrella.
- Logos can be printed with up to 4 solid colors. This is not the same as 4 color process.
- When submitting artwork, provide the PMS numbers for the colors selected. The PMS number is the color's formula.
- Logos are subject to a minimum fee. If set up & printing fees do not exceed the minimum, the minimum charge applies.
- Embroidered logos allow for different size and color specifications than silk screened. Consult factory for additional information.



Logos on Panels



Logos on Valance



Embroidered



Dye Sublimation on Deluxe Tents only

ACCESSORIES & OPTIONS



ALUMINUM SAND AUGER A-AUGER-AL

For in sand application

- 27" overall height
- 6" diam fin
- Aluminum pole with .125 wall thickness
- Mill finish
- Fits 1 1/2" diam umbrella pole
- * Removable rotator handle included



FIN DETAIL

Carved spacers allow water and sand to drain out.



Installed auger shows proper depth to sink auger into sand and umbrella pole placed in the auger after handle has been removed.



INGROUND MOUNT MTDECK-LID

- 12" overall height
- 5" diam top plate
- Schedule 40 Aluminum pipe
- Mill finish



Umbrella pole shown in inground unit.



Top View of Mounting Plate showing two screws before tightening around pole and three holes that attach to inground unit.



Side View of Mounting Plate showing screw that tightens the two halves of the plate around the pole.



Cover Plate keeps debris from clogging tube when umbrella has been removed.

LED LIGHT KIT



To create the perfect ambiance for outdoor dining after dark, add our NEW LED Lighting Kit to the ribs of your umbrella.

- Kit of 8 or 4 elements can be ordered with your umbrellas or as an aftermarket accessory
- The individual LED arms attach to the ribs and connect to the battery pack. Can be daisy chained together for larger umbrellas or greater output.
- Three settings from subdued to bright

THREE LIGHT SETTINGS

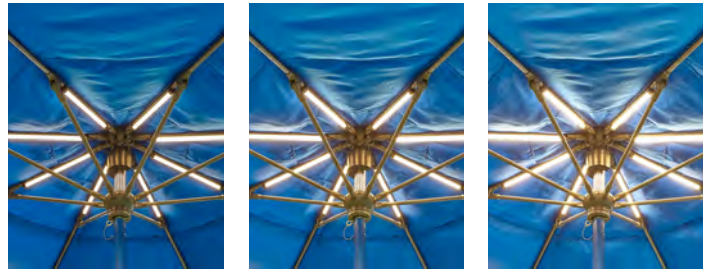

Low

Medium

Bright

- Each light uses only 1.5 watts, providing the equivalent of 125 lumens incandescent bulbs when lights are set on high
- Fully charged battery pack lasts up to 8 hours
- Fits on 1/2" and 3/4" diameter ribs
- Rechargeable battery pack fits on 2" diameter pole. Adapter clips available for 1 1/2" diameter pole.



STORAGE BAG

7STO-BAG and 9STO-BAG

With Velcro closure and two handles for Market, Garden and Patio umbrellas



PROTECTIVE COVER

Available in three sizes to accommodate pole diam from 1.5" to 2.5" diam



BAR HEIGHT BOTTOM POLE EXTENSION POLE-EXTM

For Market and Patio umbrellas. Use for in-pool Sun Shelf installation as well as Bar Height tables. Available in White, Champagne Bronze, and Black.

ALUMINUM BASES

- Contemporary smooth style
- Available in seven colors
- Base sleeve with through bolt to secure umbrella
- All models ship filled with concrete
- Instructions included. Some assembly and tools required.
- Base must be ordered with the proper sleeve size.
Add to model number:
-2 for 1 1/2" and 2" poles or -25 for 2 1/2" pole



The included cap ensures that the pole fits snugly in the base sleeve by reducing the size of the opening. The cap can be removed if the pole fits securely.



Umbrellas should be secured in the bases using the provided Through Bolt.



BASE MODEL				CANOPY SIZE					
MODEL #	WEIGHT	SIZE	OVERALL HEIGHT	7 1/2' - 8' DIAM	9' DIAM	11' DIAM	6' SQ	7 1/2' SQ	10' SQ
AB110	115	23" Diam	12"	F	F	T	F	T	
AB160	160	23" Diam	12"	F	F	F	F	F	
AB175	175	26" Diam	12"	F	F	F	F	F	F
ABW110	110	23" Diam	18"	F	F	T	T	T	
ABW175	175	26" Diam	18"	F	F	F	F	F	F

T: Umbrella is placed within a Table F: Umbrella is Freestanding

STEEL BASES

- Available in 3 weights: 85 lb, 130 lb and 200 lb
- Low profile steel base with welded base sleeve
- Galvanized and finished in silver and black
- Through bolt to secure umbrella
- Wheeled styles have “W” in model numbers
- Base must be ordered with the proper sleeve size.
Add to model number: 2 for 1.5" & 2" poles, 25 for 2.5" pole
- SBG85, SBG130 and SBG200 stationary (without wheels)
SBGW130 and SBGW200 with wheels



85 lb
SBG85



200 lb
SBG200



130 lb with wheels SBGW130
(or without wheels - SBG130)

BASE MODEL				CANOPY SIZE					
MODEL #	WEIGHT	SIZE	OVERALL HEIGHT	7 1/2' - 8' DIAM	9' DIAM	11' DIAM	6' SQ	7 1/2' SQ	10' SQ
SBG85	85	24" Sq	18"	T	T		T		
SBG130	130	24" Sq	18"	F	F	T	F	T	
SBG200	200	30" Sq	18"	F	F	F	F	F	F
SBGW130	130	24" Sq	18"	F	F	T	F	T	
SBGW200	200	30" Sq	18"	F	F	F	F	F	F

T: Umbrella is placed within a Table F: Umbrella is Freestanding

CONCRETE BASES

- Recommended for use with 7 1/2', 8' and 9' umbrellas
- CB19 available in 4 colors, CB23 and CB26 in Black only
- All bases come with black trim
- Standard black sleeve accommodates poles up to 1 3/4" in diameter
- Some assembly required



55 lbs
White CB19W



110 lbs
Black CB23K

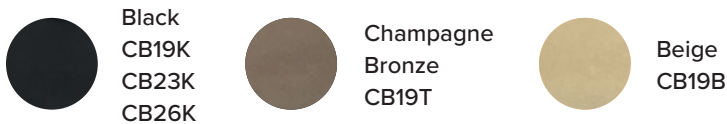

BASE MODEL				CANOPY SIZE					
MODEL #	WEIGHT	SIZE	OVERALL HEIGHT	7 1/2' - 8' DIAM	9' DIAM	11' DIAM	6' SQ	7 1/2' SQ	
CB19	55	19" Diam	14"	T	T		T		
CB23	110	23" Diam	19"	F	F		F		
CB26	154	26" Diam	22"	F	F	F	F	F	F

T: Umbrella is placed within a Table F: Umbrella is Freestanding

CUSHIONS

Our expert production staff will create high quality cushions that will restore the look and comfort of your outdoor furniture.

Replace worn, frayed or faded cushions on your existing chaises, chairs and benches or add new throw pillows, pool pillows, seat pads and cushions.

Cushions are available in a wide variety of standard sizes. For custom cushions, simply provide us with a sample or template of your existing cushions or pads and we will produce pieces in matching sizes.

For detailed instructions on how to measure cushions and furniture for replacement cushions, visit our website's Learning Center. Or scan this QR code and watch one of our helpful Youtube videos on how to properly measure existing cushions to order replacements that will fit correctly.

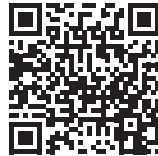

CUSHION CONSTRUCTION

Our standard construction method provides a Dacron wrap around the foam core for shape, loft and comfort.

To aid in the drying process: for all styles and fills, unzip the cushion and drain excess water and stand cushion on its side to dry. Once dry, close zipper.



CUSTOM CUSHIONS
MADE TO ORDER

Any Size
Any Shape
Any Fabric
Any Details

STANDARD REPLACEMENT CUSHION STYLES

BOX CUSHIONS

Box cushions are a versatile, fashionable and classic style approach to creating luxurious comfort for dining chairs and deep seating and chaise lounges.



Box Double Welt
Seat Cushion



Box without Welt



Box Double Welt
Seat Cushion



Box without Welt
Seat Cushion with
Pillow Back for
Deep Seating



KNIFE EDGE CUSHIONS

For a clean look, comfortable feel and affordable price, our basic knife edge cushions are the perfect solution.



Knife Edge Cushion with Box Corners and Pillow Back for Deep Seating



Knife Edge Chaise Pad with Ties



Knife Edge Bench Pad with Ties



Detail of Sewn-in Straps Connecting Seat Cushion with Pillow Back



Knife Edge with Box Corners



Knife Edge with Center Welt



Cartridge Style Knife Edge Chaise Cushion with Ties



Knife Edge Chaise Cushion with Ties

BULLNOSE CUSHIONS

Bullnose cushions are a contemporary style with a waterfall front edge. They can be used with a variety of furniture styles and create a softer profile.



Bullnose with Waterfall Edge and Welt



Bullnose with Custom Welt



CUSHION FILL OPTIONS



RETICULATED FOAM

Long lasting comfort with quick drying capabilities. Dries easily after exposure to rain or other forms of moisture and humidity. The open cell design provides maximum water drainage and air circulation allowing cushions to be back in service quickly after being wet.

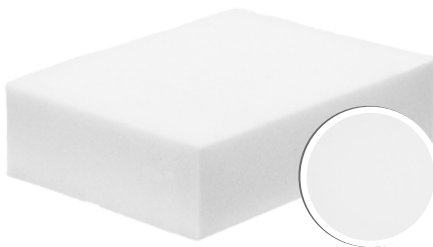

STANDARD OUTDOOR FOAM

Soft, comfortable and budget friendly. The best application for this foam is in dry climates or protected outdoor settings, such as covered patios and sunrooms.



DENSIFIED FILL

Compressed fiber filling is economical and has a low water retention level. It drains fast and dries quickly, depending on the present weather conditions at your outdoor setting.

CUSHION FEATURES AND OPTIONS

Customize your cushions to fit your furniture needs with details that suit the frame's shape.

Specify your choice of connectors to keep the cushions snugly in place.



Zipper
(a standard feature on contract cushions)



Channeled Seat Cushion with Welt and Ties



Notched Corners for Legs



Notched Corners with Ties



Notched Custom Shape

CUSHION CONNECTOR OPTIONS



Hinged Cushions



Cushion Ties



Diagonal Straps



Velcro Strap



Chaise Hood

Consult your rep or the factory to discuss any custom construction or design requirements you have.

PILLOWS AND ACCESSORIES



Pillow with Contrasting Welt



Back Cushion with Decorative Button

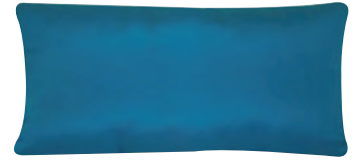

Lumbar Pillow



Round Pouf



Square Pouf



Bolsters with and without Contrasting Welt



Headrest with Velcro Strap



Throw Pillows with Contrasting Fabrics and Decorative Trim

Fabrics used for umbrella canopies and outdoor cushions need to hold up to the kinds of harsh conditions that interior fabrics never experience - direct exposure to intense sunlight, salt air, driving rain are all part of their day to day existence. Year after year they also need to

maintain their color fastness without stretching and remain stain-, mold-, mildew-resistant. For the durability our customers deserve, FiberBuilt uses only solution dyed acrylics made by industry leading manufacturers, including Sunbrella, Outdura, and Tempotest.

MARINE GRADE



GRADE A

8006 Dandelion	8600 Antique Beige	8601 Black	8602 Pacific Blue	8603 Forest Green	8604 China Red
8605 Natural White	8607 Burgundy	8608 Cardinal Red	8611 Classic Royal Blue	8612 Captains Navy	8634 Terra

MARINE GRADE



GRADE B

4600 Erin Green	4601 Pacific Blue	4604 Natural	4605 Hemlock Tweed	4606 Dubonnet Tweed	4607 Charcoal Tweed
4608 Jet Black	4610 Turquoise	4612 Aruba	4615 Smoke	4616 Mocha	4617 Royal Blue
4618 Walnut Tweed	4620 Beige	4621 True Brown	4622 Terracotta	4624 Sky Blue	4626 Navy
4628 Toast	4630 Cadet Grey	4632 Ivy	4633 Linen	4634 White	4636 Storm
4637 Forest Green	4641 Sapphire Blue	4642 Oyster	4644 Charcoal Grey	4646 Captain Navy	4648 Taupe
4651 Silver	4652 Mediterranean Blue	4653 Medit. Blue Tweed	4654 Linen Tweed	4660 Crest Birch	4662 Crest Ash
4664 Sea	4671 Fern	4672 Heather Beige	4675 Capri	4676 Cocoa	4678 Marine Blue
4679 Ocean Blue	4683 Parchment	4684 Slate	4688 Basil	4695 Tresco Linen	4696 Tresco Birch



















MARINE GRADE

GRADE B

					
T5-47 Forest Green	T6-47 Pool Green	T7-47 Olive Green	T12-47 Sunflower	T13-47 Prussian Blue	T15-47 White
					
T15/14-47 Oyster	T15/79-47 Mist	T16-47 Lime	T17/15-47 Mid Blue	T20-47 Coral Pink	T21-47 Powder Blue
					
T22-47 Shoreline	T24-47 Black	T25/15-47 Candy Pink	T53-47 Antique Pink	T71/15-47 Spa	T75-47 Navy
					
T77-47 Bluette	T87-47 Sapphire	T87/8-47 Air Force Blue	T91-47 Plum	T92-47 Indigo	T94-47 Grey
					
T94/15-47 Lead	T97-47 Charcoal	T101-47 Toast	T102-47 Cappuccino	T106-47 Toffee	T107-47 Carbon
					
T407/92-47 Driftwood Tweed	T416-47 Pacific Blue	T727/15-47 Pebble	T727/71-47 Metal	T782/87-47 Wave Tweed	T873-47 Glacier Tweed
					
T873/78-47 Lettuce Tweed	T873/151-47 Dune Tweed	T986/15-47 Ice Tweed	T986/106-47 Bisquit Tweed	T986/727-47 Pebble Tweed	T5407/6-47 Irish Green Tweed

MARINE GRADE

GRADE C

					
4602 Sunflower Yellow	4603 Jockey Red	4631 Burgundy	4666 Logo Red	4677 Tuscan	4831 Silica Caribbean
					
4833 Silica Gravel	4859 Silica Dune	4860 Silica Sesame	4861 Silica Stone	4862 Silica Silver	4896 Silica Sage
					
4897 Silica Charcoal					
					
T11-47 Red	T19-47 Sicily Orange	T55-47 Bright Orange	T72-47 Orange	T73-47 Burgundy	T426-47 Brick



MARINE GRADE



GRADE D

4746 Beaufort Sagebrush	4751 Hemlock Tweed Fancy	4752 Beaufort Cloud	4753 Beaufort Mushroom	4755 Pacific Blue Fancy	4766 Era Ash
4768 Preston Stone	4771 Beaufort Peacock	4773 Bisque Brown	4776 Choc Chip Fancy	4777 Grey/Beige Chip Fancy	4789 Manhattan Classic
4790 Forest Green Fancy	4798 Burgundy/Black/White	4799 Grey/Black/White	4806 Beaufort FGRn/Natural	4813 Eastland Redwood	4817 Westfield Mushroom
4821 Colonnade Currant	4822 Colonnade Stone	4823 Colonnade Seaglass	4835 Cooper Ash	4836 Tillman Shale	4856 Colonnade Juniper
4857 Colonnade Redwood	4868 Kiawah Spa	4876 Manhattan Fog	4884 Saxon Cascade	4885 Saxon Chili	4888 Clinton Granite
4902 Capt Navy/Natural Classic	4907 Taupe 5 Bar	4916 Navy/Taupe Fancy	4921 Mediterranean/Canvas	4923 Black Forest Fancy	4945 Taupe Tailored Bar
4946 Black/Taupe Fancy	4949 Forest Vintage Bar	4954 Heather Beige Classic	4955 Fern Classic	4959 Fern/Heather Beige	4961 Putty Regimental
4969 Henna/Fern Vintage	4985 Havelock Brick	4987 Cooper Navy	4988 Cooper Black	4989 Hatteras Raven	4992 Baycrest Sky
4993 Baycrest Pacific	4994 Eastridge Cocoa	4995 Ashford Forest	5702 Beaufort Yellow/White	5704 Beaufort Black/White	

GRADE D

T31-47 Light Blue/White Stripe	T33-47 Forest Green/White Stripe	T34-47 Navy Frost/White Stripe	T35-47 Red/White Stripe	T37-47 Yellow/White Stripe	T68-47 Black/Grey Stripe
T116-15-47 Blue/White Stripe	T242-47 Grey/White Stripe	T378-47 Aqua/White Stripe	T439-47 Dark Grey Stripe	T770-55-47 Bright Orange/Yellow Stripe	T790-47 Black/White Stripe
T966/426-47 Roasted Pepper Stripe	T967-926-47 Greco Grey Stripe	T969-47 Pearl/Grey Stripe	T5001/13-47 Royal/White Stripe	T5361/79-47 Grey Frost Stripe	T5374-47 Black Pearl Stripe



Marine Grade fabrics have a tighter weave, are stiffer to the touch, abrasion resistant, and heavier. The stiffness of the material makes is appropriate for most umbrella canopy applications.

Furniture Grade fabrics are softer, more flexible and can be used for both canopies and cushions, pillows, headrests and poufs, providing a soft hand and comfortable feel.

FURNITURE GRADE



GRADE B

					
5401 Pacific Blue	5402 Granite	5404 Natural	5408 Black	5410 Air Blue	5413 Spa
					
5414 Wheat	5415 Melon	5416 Aruba	5420 Mineral Blue	5422 Antique Beige	5424 Sky Blue
					
5425 Cocoa	5426 Capri	5428 Glacier	5438 Buttercup	5439 Navy	5446 Forest Green
					
5452 Sapphire Blue	5453 Canvas	5456 Teal	5457 Sunflower Yellow	5461 Taupe	5468 Camel
					
5471 Raven Black	5472 Bird's Eye	5476 Heather Beige	5484 Brass	5487 Fern	5488 Teak
					
5489 Coal	5492 Flax	5493 Regatta	5498 Vellum	5499 True Blue	8300 Linen Champagne
					
8304 Linen Natural	8314 Linen Straw	8318 Linen Sesame	8319 Linen Stone	8322 Linen Antique Beige	8351 Linen Silver
					
8353 Linen Canvas	14059 Haze	14066 Abyss	14067 Mushroom	40428 Cast Ash	40429 Cast Mist
					
40430 Cast Oasis	40432 Cast Shale	40433 Cast Silver	40434 Cast Slate	40456 Cast Lagoon	40483 Cast Charcoal
					
40484 Paradigm Stone	48018 Spectrum Eggshell	48019 Spectrum Sand	48020 Spectrum Mist	48022 Spectrum Cilantro	48024 Spectrum Daffodil
					
48026 Spectrum Cayenne	48027 Spectrum Grenadine	48029 Spectrum Coffee	48030 Spectrum Graphite	48031 Spectrum Mushroom	48032 Spectrum Dove

FURNITURE GRADE



GRADE B

48080 Spectrum Indigo	48081 Spectrum Peacock	48083 Spectrum Caribou	48084 Spectrum Sesame	48085 Spectrum Carbon	48086 Spectrum Denim
48091 Cast Horizon	48092 Cast Sage	48093 Cast Teak	48094 Cast Breeze	48096 Spectrum Cherry	48097 Cast Sable
48103 Cast Ocean	48108 Cast Coral	48109 Cast Moss	48112 Cast Citrus	48113 Cast Royal	48114 Cast Pumice
48135-0001 Bliss Linen	48135-0002 Bliss Sand	48135-0003 Bliss Smoke	48135-0004 Bliss Onyx	48135-0005 Bliss Clay	48135-0006 Bliss Guava
48135-0007 Bliss Lemon	48135-0008 Bliss Aspen	48135-0009 Bliss Ink	48135-0010 Bliss Pebble	48135-0013 Bliss Bark	48135-0014 Bliss Dew
48139 Cast Pomegranate	48140 Cast Harbor	48141 Cast Ivy	54048 Charcoal	56092 Frequency Ash	56093 Frequency Parchment
56094 Frequency Sand	56105 Canvas Cyan	57001 Canvas Chestnut	57003 Canvas White	57012 Cloud	57013 Persimmon
57014 Java	57015 Fawn				

FURNITURE GRADE









GRADE B

TH5-60 Forest Green	TH7-60 Olive	TH11-60 Red	TH12/15-60 Dandelion	TH13-60 Prussian Blue	TH15-60 White
TH15/151-60 Oyster	TH16-60 Lime	TH17/15-60 Mid Blue	TH19-60 Sicily Orange	TH20-60 Coral Pink	TH21/15-60 Steel Blue
TH22-60 Shoreline	TH24-60 Black	TH25/15-60 Candy Pink	TH55-60 Bright Orange	TH71/15-60 Spa	TH73/15-60 Burgundy Wine

Spectrum fabrics are recommended for use on umbrellas in residential applications only

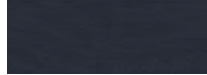





























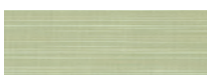







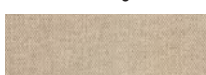

FURNITURE GRADE

GRADE B

					
TH75-60 Navy	TH77/15-60 Blue Bird	TH79/15-60 Fog	TH91-60 Plum	TH92-60 Indigo	TH94/15-60 Lead
					
TH97-60 Charcoal	TH101-60 Toast	TH102-60 Cappuccino	TH106-60 Toffee	TH107-60 Carbon	TH426/15-60 Light Brick
					
TH727/15-60 Pebble					

FURNITURE GRADE

GRADE C

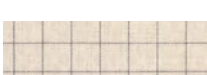
					
5403 Jockey Red	5405 Parrot	5406 Tangerine	5407 Henna	5409 Brick	5417 Tuscan
					
5429 Macaw	5432 Bay Brown	5436 Burgundy	5440 Terracotta	5462 Hot Pink	5477 Logo Red
					
8011 Dupione Sand	8015 Dupione Laurel	8016 Dupione Galaxy	8017 Dupione Walnut	8019 Dupione Deep Sea	8024 Dupione Peridot
					
8066 Dupione Latte	8067 Dupione Celeste	8068 Dupione Aloe	8076 Echo Midnight	54010 Rust	54011 Gingko
					
57005 Echo Ash	57007 Echo Dune	16001-0001 Blend Indigo	16001-0002 Blend Lagoon	16001-0004 Blend Sage	16001-0006 Blend Clay
					
16001-0008 Blend Coal	16001-0009 Blend Mist	16001-0011 Blend Nomad	16001-0012 Blend Sand	16001-0014 Blend Linen	42091-0003 Platform Indigo
					
42091-0011 Platform Cloud	42091-0013 Platform Salt	44465-0001 Model Sand	44465-0002 Model Dew	44465-0003 Model Harbor	48138-0001 Context Indigo
					
48138-0002 Context Linen					

FURNITURE GRADE

GRADE C



FURNITURE GRADE

GRADE D

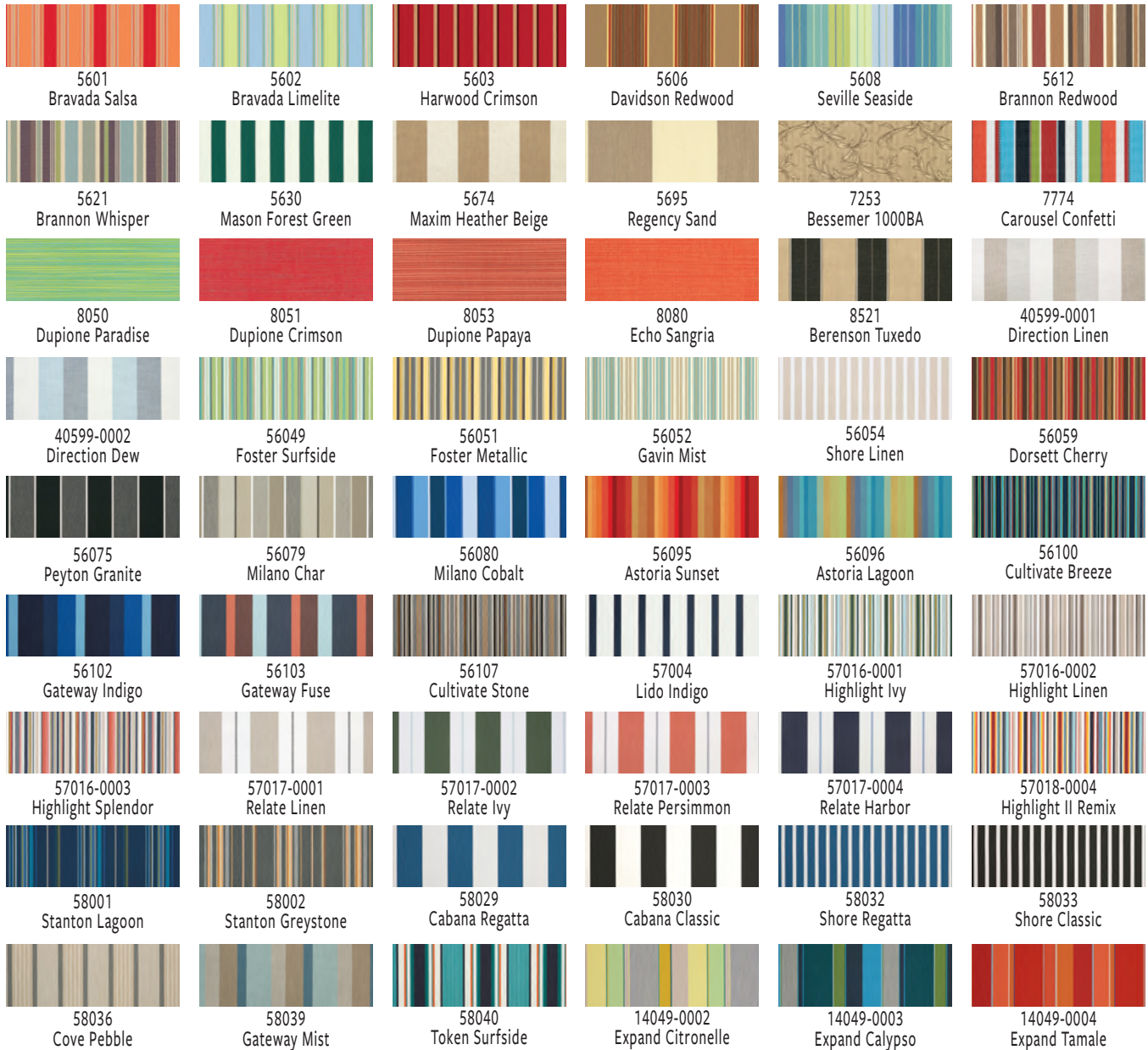

Spectrum fabrics are recommended for use on umbrellas in residential applications only

FURNITURE GRADE



GRADE D

14049-0005 Expand Dove	14050-0001 Scale Cloud	14050-0002 Scale Taupe	14050-0003 Scale Smoke	14050-0004 Scale Indigo	145844-0001 Create Smoke
145844-0002 Create Haze	145844-0003 Create Guava	145844-0004 Create Laurel	145849-0001 Embrace Pewter	145849-0002 Embrace Linen	145849-0003 Embrace Indigo
145854-0001 Calm Graphite	145854-0002 Calm Laurel	16007-0002 Depth Indigo	16007-0003 Depth Fossil	16007-0008 Depth Pumice	16008-0001 Comfort Pebble
16008-0002 Comfort Clay	40564-0001 Range Dune	40564-0002 Range Smoke	40524-0001 Trusted Fog	40524-0002 Trusted Coast	40584-0001 Surround Dusk
40584-0002 Surround Sunrise	44285-0000 Action Linen	44285-0001 Action Ash	44285-0002 Action Stone	44285-0003 Action Taupe	44385-0001 Level Sunset
44385-0002 Level Atlantis	44385-0004 Level Pumice				

FURNITURE GRADE



GRADE D

TH5413/75 Fiera Sapphire	TH5413/94 Fiera Crystal	TH5414/8 Presidio Pine	TH5414/16 Presidio Kiwi	TH5414/20 Presidio Zinnia	TH5414/87 Presidio Indigo
TH5414/926 Presidio Hemp	TH5418/11 Sorridere Arcade	TH5418/21 Sorridere Aruba	TH5418/22 Sorridere Lollipop	TH5418/58 Sorridere Autumn	TH5419/87 Casa Al Mare Arcade
TH5419/94 Casa Al Mare Oceanside	TH5419/701 Casa Al Mare Dunes	TH5420/11 Fredda Autumn	TH5420/22 Fredda Aruba	TH5420/54 Fredda Oceanside	TH5420/926 Fredda Latte
TH51352/3 Ocean Drive Margarita	TH51352/6 Ocean Drive Storm	TH51352/7 Ocean Drive Maritime	TH51352/8 Ocean Drive Candy Cane	TH51352/9 Ocean Drive Beach	TH51352/10 Ocean Drive Sunshine
TH51352/11 Ocean Drive Aruba	TH51353/3 Surfside Margarita	TH51353/6 Surfside Storm	TH51353/7 Surfside Maritime	TH51353/8 Surfside Candy Cane	TH51353/9 Surfside Beach
TH51353/10 Surfside Sunshine	TH51353/11 Surfside Aruba				

FURNITURE GRADE



GRADE E

8031 Dimone Sequoia	16009-0001 Principle Tropics	16009-0002 Principle Lagoon	18001 Heritage Ashe	18004 Heritage Granite	18006 Heritage Papyrus
18011 Heritage Leaf	42078 Hybrid Sky	42079 Hybrid Smoke	45099 Cabaret Blue Haze	56000 Dolce Mango	56001 Dolce Oasis
18009 Heritage Char	18010 Heritage Denim	145654-0001 Array Dune	145654-0002 Array Calypso	145654-0003 Array Caribbean	145654-0004 Array Dawn
145656-0001 Resonate Dune	145656-0003 Resonate Atlantis	145656-0004 Resonate Citronelle	145657-0001 Extent Sunset	145843-0001 Renew Earthen	145843-0002 Renew Mist
145853-0001 Infused Gem	145853-0002 Infused Twilight	146003-0001 Detail Linen	146003-0002 Detail Denim	146003-0003 Detail Persimmon	146003-0004 Detail Classic
146003-0005 Detail Navy	32000-0003 Sailcloth Shore	32000-0016 Sailcloth Sahara	32000-0018 Sailcloth Salt	32000-0023 Sailcloth Seagull	32000-0025 Sailcloth Shadow
32000-0026 Sailcloth Sailor	32000-0027 Sailcloth Space	42102-0001 Nurture White	42102-0002 Nurture Pebble	42102-0003 Nurture Smoke	42102-0004 Nurture Shale
42102-0005 Nurture Driftwood	42102-0006 Nurture Charcoal	69006-0006 Integrated Pewter	69006-0008 Integrated Steel	69010-0002 Adaptation Stone	69010-0004 Adaptation Indigo

FURNITURE GRADE



GRADE F

32008 Solana Seagull	45542 Blox Slate	45690 Luxe Indigo	45936 Accord II Crimson	42048-0009 Mainstreet Latte	45746-0001 Elegance Marble
45760-0002 Violetta Baltic	45837-0002 Empire Dove	45885-0000 Fischer Lagoon	45922-0000 Accord Jade	45991-0000 Fretwork Mist	45991-0001 Fretwork Flax
45991-0002 Fretwork Pewter	145256-0001 Midori Indigo	145999-0001 Sensibility Linen	145999-0002 Sensibility Spring	146000-0001 Sensibility II Splendor	146000-0002 Sensibility II Harbor

Spectrum fabrics are recommended for use on umbrellas in residential applications only

UMBRELLA WARRANTY

FiberBuilt Umbrellas & Cushions warrants our two piece fiberglass ribbed Garden, Patio, Market and Beach Umbrellas, and all Wood umbrellas, as well as all bases, Cabanas and upholstery work for a period of one (1) year from the date of purchase, to the original purchaser, against defects in materials and workmanship. Additionally, fiberglass support ribs on our Market and 8-rib Beach Umbrellas are warranted for five (5) years from the date of purchase. Our Prestige Collection Umbrellas (Augusta, Bambusa, Bridgewater, Contempo, Diamante, Flight, Gusto, Lucaya, Nitro, Oceana, Palm, Riva, Unico and Wattsun) are warranted for a period of five (5) years from the date of purchase, to the original purchaser, against defects in materials and workmanship. Fiberglass support ribs on all Prestige Collection Umbrellas are also warranted for five (5) years. Solar charging components on Wattsun are warranted for one (1) year against defects related to electrical issues (such as battery or solar panel failure) or if charging ceases to function. Our Euro Collection Umbrellas (Bali, Cantina, Edge and Venice) are warranted for a period of two (2) years from the date of purchase, to the original purchaser, against defects in materials and workmanship. For the warranty to apply, umbrellas must be secured in properly weighted bases, equal to or exceeding the weights provided in FiberBuilt's Base Weight Charts. See base pages for recommended usage.

Though our fiberglass ribbed umbrellas have successfully passed wind tests over 50 miles per hour, FiberBuilt Umbrellas & Cushions does not recommend leaving umbrellas open during storms or strong winds. Customer is responsible for taking the umbrella down when winds reach unsafe conditions. Normal care and maintenance of products is required to insure years of problem free use.

Damaged umbrellas should be immediately taken out of service. This warranty does not cover the umbrella pole, crank or tilt, normal fading of fabrics and finishes and chemical stains. This warranty does not cover any damage due to acts of God, abuse, misuse or vandalism incurred to the umbrella after purchase, nor does it cover customer's own material. For warranty to apply products must be properly cared for and maintained. Modifications made to the product after production may void warranty. This warranty does not provide coverage or reimbursement for loss of use, time, inconvenience or other damages resulting from any defect in the product. To find out more about our warranty or to file a claim, please contact our customer service department at: 866-667-8668. No returns will be accepted without prior approval.

TILT UMBRELLAS ARE NOT WARRANTED IN COMMERCIAL APPLICATIONS

FABRIC WARRANTY

Fabric options offered vary by product. Umbrella canopies made from Sunbrella, Outdura and Tempotest fabrics are warranted from the fabric mill against light fastness. This is a limited pro-rated warranty provided directly from the fabric mill for a period of five (5) years for Sunbrella and Tempotest furniture grade fabrics and for a period of ten (10) years for Sunbrella, Outdura and Tempotest marine grade fabrics. This warranty covers the fabric becoming unserviceable because of loss of color or strength from normal exposure conditions including sunlight, mildew, rot and atmospheric chemicals. It does not cover labor and installation supplied by FiberBuilt Umbrellas & Cushions or any other dealer. In the event that your fabric fails, please contact us to submit a claim and for further details. All fabric must be properly maintained and cleaned regularly for the warranty to be effective. Spun Acrylic, vinyl coated weaves and select marine grade fabrics do not carry an additional warranty.



2201 W. Atlantic Blvd. Pompano Beach, FL 33069

Toll-free 866.667.8668 Tel 954.484.9139 Fax 954.484.4654

www.fiberbuiltumbrellas.com