



# JCP.4 SERIES

- ✓ Full aluminium frame.
- ✓ Despite its weight of 305 kg, an elegant appearance. (incl. base)
- ✓ Variations in sizes, finishes and colours.
- ✓ Ideal for a lounge setting or over long dining tables.
- ✓ Belgian design.

360°



Four series is home to a variety of environments all over the world, both for private use and large projects such as hotels, public buildings, resorts and pool areas. An exceptionally sturdy outdoor sunshade with an elegant and luxurious appearance. Supported by a 245 kg base and its dimensions, this series is the perfect marriage between Belgian design, enormous strength and guaranteed quality. Every model offers a great deal of shade and is easy to operate and maintain. Choose a colour that expresses your style and personality.

- FRAME** Free pole umbrella with crank handle. Pole & ribs are aluminium powder coated.  
Pole profile: 100 x 100 x 3,5 mm, 3,9 x 3,9 x 0,2".  
Ribs profile: 32 x 32 x 1,6 mm, 1,2 x 1,2 x 0,06".
- CANOPY** 320g/m<sup>2</sup> Sunbrella® Plus, 100% solution dyed acrylic.  
⌚ Fast stock: canopies available on stock.
- BASE** Hot galvanized and powder coated steel plates.
- TILT & ROTATION** Tilt in height and can rotate 360° around its pole.
- WIND SPEED** 39 km/h, 24 mph - Maximum wind speed to which the umbrella may be exposed.



JCP.401  
370 x 370 cm

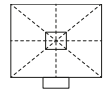

JCP.402  
300 x 425 cm



JCP.403  
ø 400 cm

CARACTÈRE

FRAME

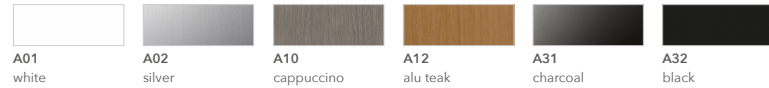

CANOPY

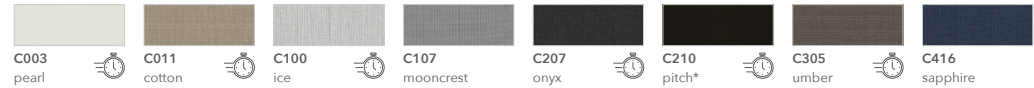

401

\*Only fast stock in combination with A32 frame.

| JCP.401 - 370 x 370 cm                                | Weight net          | Weight gross       | Packaging CBM / CCF                     | Units |
|---|---------------------|--------------------|---|-------|
| UMBRELLA FRAME & CANOPY                               | 64 kg<br>141.1 lbs  | 67 kg<br>147.7 lbs | 275 x 50 x 28 cm<br>108.3 x 19.7 x 11"  | 1     |
| <b>UFJCP.401</b><br>FRAME ONLY INCL. PROTECTION COVER | 59 kg               | 60 kg              | 275 x 50 x 28 cm<br>108.3 x 19.7 x 11"  | 1     |
| <b>UCJCP.401</b><br>CANOPY ONLY                       | 5 kg<br>11 lbs      | 7 kg<br>15.4 lbs   | 60 x 46 x 11 cm<br>23.6 x 18.1 x 4.3"   | 1     |
| <b>UBJCP.4S</b><br>BASE                               | 245 kg<br>540 lbs   | 254 kg<br>560 lbs  | 103 x 103 x 17 cm<br>40.6 x 40.6 x 6.7" | 1     |
| <b>UBIGB-JCP.4S-5S-6S</b><br>IN GROUND BASE           | 8.5 kg<br>18.7 lbs  | 10 kg<br>22 lbs    | 27 x 64 x 27 cm<br>10.6 x 25.2 x 10.6"  | 1     |
| <b>UBOGB-JCP.4S-5S-6S</b><br>ON GROUND BASE           | 6.5 kg<br>14.33 lbs | 7 kg<br>15.4 lbs   | 27 x 27 x 6 cm<br>10.6 x 10.6 x 2.4"    | 1     |
| <b>UPJCP.4S-X77</b><br>PROTECTION COVER               | 0.8 kg<br>1.8 lbs   | 1 kg<br>2.2 lbs    | 17 x 48 x 4 cm<br>6.7 x 18.9 x 1.6"     | 1     |

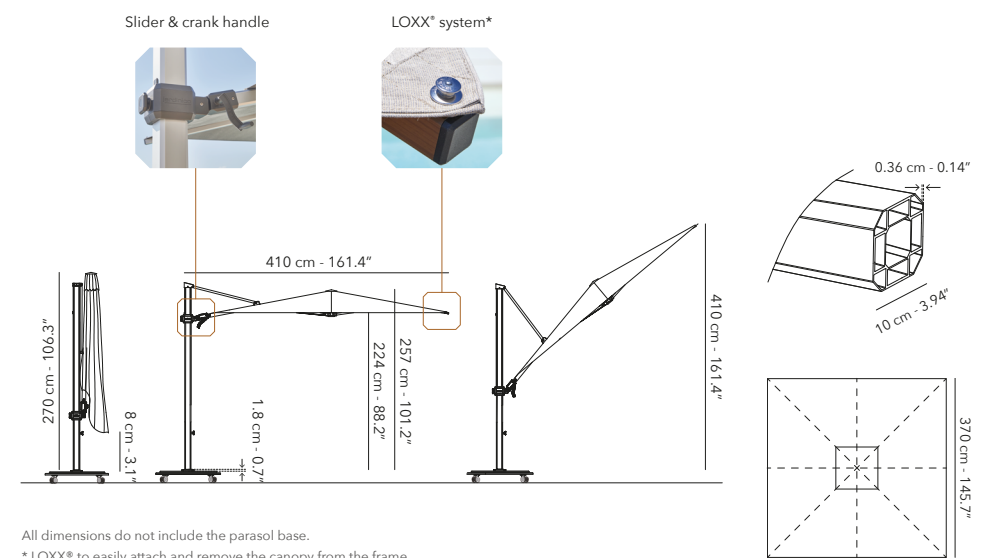
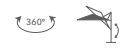

All dimensions do not include the parasol base.  
\* LOXX\* to easily attach and remove the canopy from the frame.

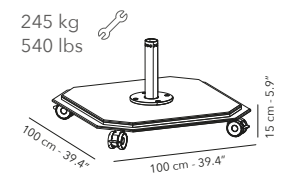
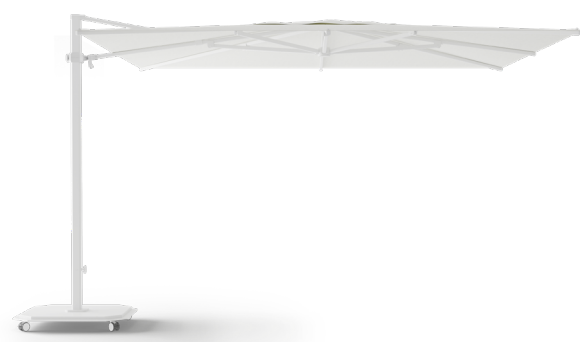

BASE

- Base with four wheels that rotate 360°, each with a brake to secure the umbrella.
- Has the same colour as the frame.
- We provide a charcoal parasol base for a frame in alu teak and cappuccino.

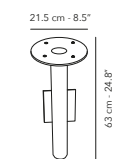

IN GROUND BASE

Anchored in the ground with concrete. Fixed and cannot be moved.

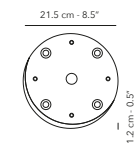

FLOOR FIXING PLATE

Anchored in the ground with concrete. Fixed and cannot be moved.

FRAME



CANOPY



402

| JCP.402 - 300 x 425 cm                         | Weight net          | Weight gross       | Packaging CBM / CCF                     | Units |
|--|---------------------|--------------------|---|-------|
| UMBRELLA FRAME & CANOPY                        | 53 kg<br>116.8 lbs  | 56 kg<br>123.5 lbs | 275 x 50 x 28 cm<br>108.3 x 19.7 x 11"  | 1     |
| UFJCP.401<br>FRAME ONLY INCL. PROTECTION COVER | 48 kg               | 49 kg              | 275 x 50 x 28 cm<br>108.3 x 19.7 x 11"  | 1     |
| UCJCP.401<br>CANOPY ONLY                       | 5 kg<br>11 lbs      | 7 kg<br>15.4 lbs   | 60 x 46 x 11 cm<br>23.6 x 18.1 x 4.3"   | 1     |
| UBJCP.4S<br>BASE                               | 245 kg<br>540 lbs   | 254 kg<br>560 lbs  | 103 x 103 x 17 cm<br>40.6 x 40.6 x 6.7" | 1     |
| UBIGB-JCP.4S-5S-6S<br>IN GROUND BASE           | 8.5 kg<br>18.7 lbs  | 10 kg<br>22 lbs    | 27 x 64 x 27 cm<br>10.6 x 25.2 x 10.6"  | 1     |
| UBOGB-JCP.4S-5S-6S<br>ON GROUND BASE           | 6.5 kg<br>14.33 lbs | 7 kg<br>15.4 lbs   | 27 x 27 x 6 cm<br>10.6 x 10.6 x 2.4"    | 1     |
| UPJCP.4S-X77 PROTECTION COVER                  | 0.8 kg<br>1.8 lbs   | 1 kg<br>2.2 lbs    | 17 x 48 x 4 cm<br>6.7 x 18.9 x 1.6"     | 1     |

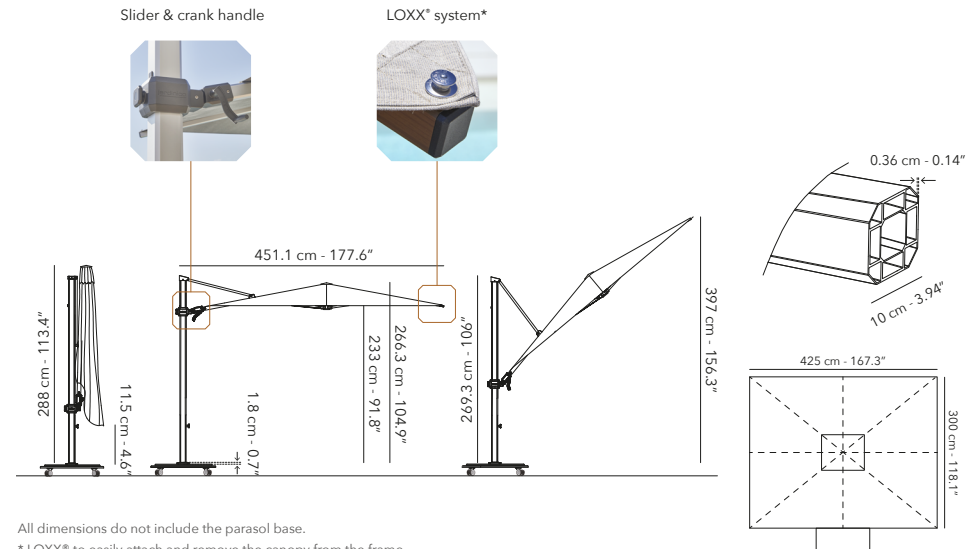
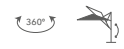

All dimensions do not include the parasol base.  
\* LOXX\* to easily attach and remove the canopy from the frame.



245 kg  
540 lbs

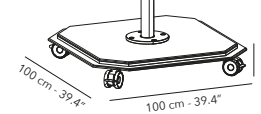

BASE

- Base with four wheels that rotate 360°, each with a brake to secure the umbrella.
- Has the same colour as the frame.
- We provide a charcoal parasol base for a frame in alu teak and cappuccino.

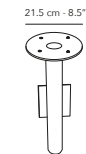

IN GROUND BASE

Anchored in the ground with concrete. Fixed and cannot be moved.

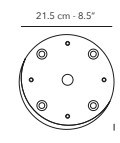

FLOOR FIXING PLATE

Anchored in the ground with concrete. Fixed and cannot be moved.

FRAME



CANOPY



| JCP.403 - ø 400 cm                                    | Weight net          | Weight gross       | Packaging CBM / CCF                     | Units |
|---|---------------------|--------------------|---|-------|
| UMBRELLA FRAME & CANOPY                               | 53 kg<br>116.8 lbs  | 56 kg<br>123.5 lbs | 275 x 50 x 28 cm<br>108.3 x 19.7 x 11"  | 1     |
| <b>UFJCP.403</b><br>FRAME ONLY INCL. PROTECTION COVER | 48 kg               | 49 kg              | 275 x 50 x 28 cm<br>108.3 x 19.7 x 11"  | 1     |
| <b>UCJCP.403</b><br>CANOPY ONLY                       | 5 kg<br>11 lbs      | 7 kg<br>15.4 lbs   | 60 x 46 x 11 cm<br>23.6 x 18.1 x 4.3"   | 1     |
| <b>UBJCP.45</b><br>BASE                               | 245 kg<br>540 lbs   | 254 kg<br>560 lbs  | 103 x 103 x 17 cm<br>40.6 x 40.6 x 6.7" | 1     |
| <b>UBIGB-JCP.4S-5S-6S</b><br>IN GROUND BASE           | 8.5 kg<br>18.7 lbs  | 10 kg<br>22 lbs    | 27 x 64 x 27 cm<br>10.6 x 25.2 x 10.6"  | 1     |
| <b>UBOGB-JCP.4S-5S-6S</b><br>ON GROUND BASE           | 6.5 kg<br>14.33 lbs | 7 kg<br>15.4 lbs   | 27 x 27 x 6 cm<br>10.6 x 10.6 x 2.4"    | 1     |
| <b>UPJCP.4S-X77</b><br>PROTECTION COVER               | 0.8 kg<br>1.8 lbs   | 1 kg<br>2.2 lbs    | 17 x 48 x 4 cm<br>6.7 x 18.9 x 1.6"     | 1     |

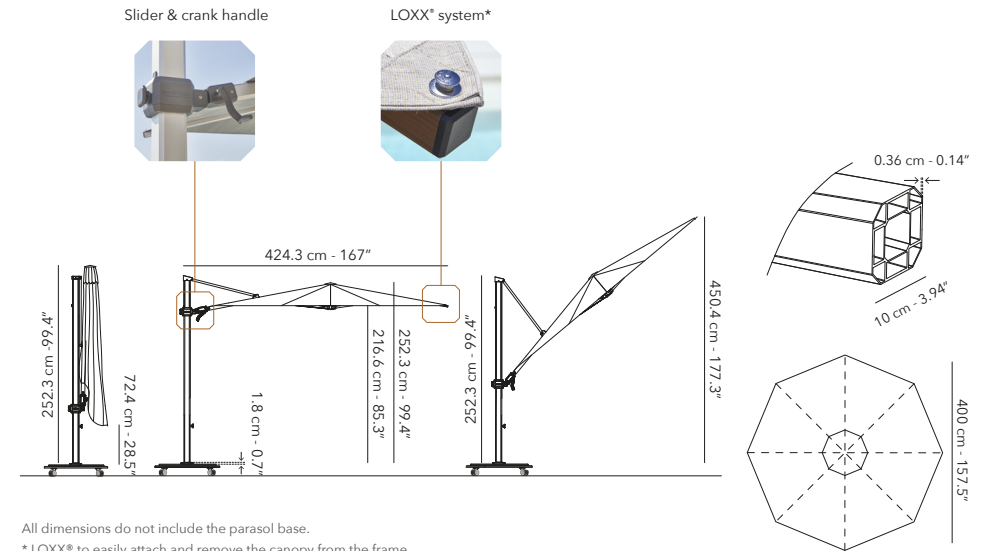
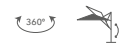

All dimensions do not include the parasol base.  
\* LOXX\* to easily attach and remove the canopy from the frame.



245 kg  
540 lbs

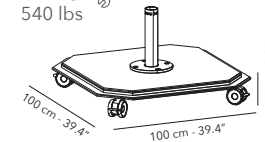

BASE

- Base with four wheels that rotate 360°, each with a brake to secure the umbrella.
- Has the same colour as the frame.
- We provide a charcoal parasol base for a frame in alu teak and cappuccino.

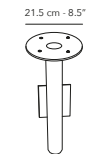

IN GROUND BASE

Anchored in the ground with concrete. Fixed and cannot be moved.

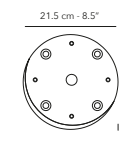

FLOOR FIXING PLATE

Anchored in the ground with concrete. Fixed and cannot be moved.



# MAINTENANCE

To enhance the durability and appearance, we recommend following our care instructions regularly.

The umbrella should never be used in strong wind or rainy conditions. An open umbrella should never be left unattended. The umbrella should be protected against blurring or damage by using its protection cover. The protection cover can be placed over the umbrella and pole. Store the umbrella in a dry place when not in use.

## FRAME & BASE

Clean the aluminium frame with a damp cloth, mild soap and water. Do not use any sharp tool to avoid scratches.



## CANOPY

Before use, you can apply an invisible film to make the canopy stain and water repellent by using a textile protector. You can maintain and clean your canopy by following a few simple steps:

- Brush off loose dirt before it becomes embedded in the fabric.
- Hose down.
- Spot clean soon after stains occur with water and mild soap or a textile cleaner (no detergents). Use a soft bristle brush to clean.
- Allow soap to soak in.
- Rinse thoroughly.
- Always let the canopy air dry completely before storing or covering.

Machine wash in cold water. Depending on wash load size, use normal amounts of mild laundry detergent and add 1 cup of bleach. Allow fabric to air dry.

NEVER SUBJECT TO EXCESSIVE HEAT, STEAM PRESS OR TUBLE DRY AS THE FABRIC WILL SHRINK.

|   |  | Weight net        | Weight gross      | Packaging CBM / CCF                  | Units |
|---|--|-------------------|-------------------|--------------------------------------|-------|
|  | <b>SPCOR-12ML CORRECTOR PEN</b><br>A01 white, A03 linen, A11 taupe,<br>A31 charcoal or A32 black   | 48 g<br>0.11 lbs  | 53 g<br>0.12 lbs  | 3 x 7 x 3 cm<br>1.2 x 2.8 x 1.2"     | 1     |
|  | <b>PT000388 FABRIC MAINTENANCE KIT</b><br>Includes 2 scrubbing sets, 3 application cloths,<br>textile protector 750 ml, textile cleaner 750 ml | 1.7 kg<br>3.7 lbs | 1.9 kg<br>4.2 lbs | 21 x 28 x 10.5 cm<br>8.3 x 11 x 4.2" | 1     |



MADE FOR **SHADE** &  
**OUTDOOR LIVING.**