



**JETSURF®**



**BORN FOR FUN**

**/ CATALOGUE**



# CONTENTS

01  
PETROL  
SURFBOARDS  
6

02  
ELECTRIC  
SURFBOARDS  
18

03  
SKATEBOARDS  
22

04  
WEAR  
30

05  
RACING  
34





# HOW YOU'VE SEEN US

2010



2012



2016



2018



2020



2021





# 01

PETROL  
SURFBOARDS





**SPORT**

**2023**



**LET THE JOURNEY COMMENCE!**

Lenght	Width	Height	Weight	Displacement	Cruising range	Mixture preparation	Certification
180 cm	60 cm	15 cm	18,5 kg	90 cc	40 min	carburetor	/

**SPORT** PRICE (without VAT) **8 490 €**

**FEATURES**



• 90 ccm engine with carburetor.



• Compatible with the Tube.



• Main and side carbon fibre fins (no FCS).



• Dual foot bindings for both riding positions – REGULAR & GOOFY.

**GRAPHIC DESIGN**



PERFECT BLUE



WHITE GREY



FLUO YELLOW



# ADVENTURE DFI

2023

ALL-NEW

## FEATURES

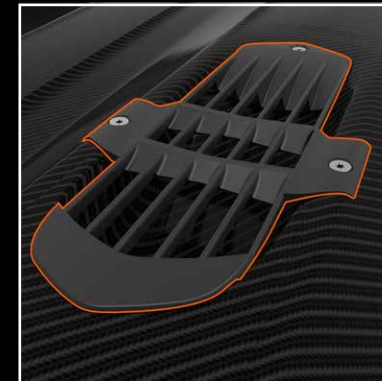

• Intake screen – protection of jet-pump from debris.



• FCS main and side fins – fast and simple click on / off system.



• Dual foot bindings for both riding positions – REGULAR & GOOFY.

## NEW GRAPHIC DESIGN



FLUO YELLOW

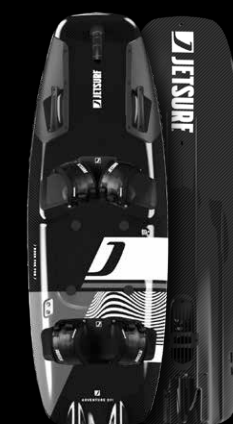

WHITE GREY



FLUO ORANGE



### CROWD FAVORITE!

Length	Width	Height	Weight	Displacement	Cruising range	Mixture preparation	Certification
180 cm	60 cm	15 cm	20 kg	100 cc	60 min	fuel injection	EPA CE

ADVENTURE DFI PRICE (without VAT) 10 490 €



# ADVENTURE DFI PLUS

2023

ALL-NEW

## FEATURES



• Intake screen – protection of jet-pump from debris.



• Alternator for charging independence.



• FCS main and side fins – fast and simple click on / off system.



• Smart carrying system for duffel & fuel tank.

## NEW GRAPHIC DESIGN

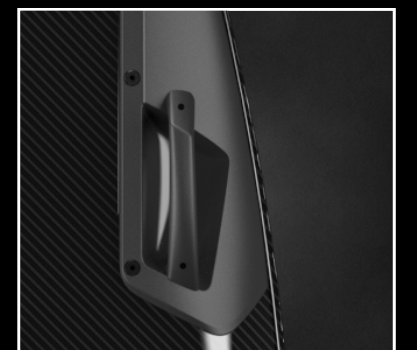

• Protective covers for more durability.



FLUO RED



### BORN TO EXPLORE!

Length	Width	Height	Weight	Displacement	Cruising range	Mixture preparation	Certification
180 cm	60 cm	15 cm	22 kg	100 cc	60 min with extra fuel canister	fuel injection	EPA CE

ADVENTURE DFI PLUS PRICE (without VAT) 11 990 €

### EXTRA EQUIPMENT INCLUDED:

- Ratchet straps
- Carbon fiber binding adjustors.
- Travel bag with wheels for easier transportation.



# RACE DFI

2022



## UNLEASH THE JOY!

Lenght	Width	Height	Weight	Displacement	Cruising range	Mixture preparation	Certification
180 cm	60 cm	15 cm	19,5 kg	100 cc	60 min	fuel injection	/

RACE DFI PRICE (without VAT) 11 990 €

## FEATURES



• New ergonomic foot pads and straps.



• Silencer - significant noise reduction.



• FCS main and side fins - fast and simple click on / off system.

## GRAPHIC DESIGN



TEAL GREY

FLUO ORANGE

FLUO YELLOW

CARBON



# TITANIUM DFI

2023



## BORN TO RACE!

Lenght	Width	Height	Weight	Displacement	Top speed	Mixture preparation	Certification
180 cm	60 cm	15 cm	18,5 kg	100 cc	64 km/h	fuel injection	/

TITANIUM DFI PRICE (without VAT) **12 990 €**

## FEATURES



• JetPump winglet – hydrodynamics flow stimulation.



• Improved engine and exhaust system setup for higher performance.



• Redesigned hull for better turning.

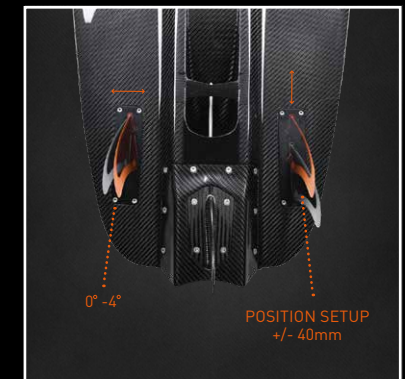

• FCS side fins with plugs for perfect fins position setup.

## GRAPHIC DESIGN



WHITE CARBON



# TITANIUM DFI RS

2023

**NEW**



## BORN TO RACE!

Lenght	Width	Height	Weight	Displacement	Top speed	Mixture preparation	Certification
180 cm	60 cm	15 cm	18,5 kg	100 cc	64 km/h	fuel injection	/

TITANIUM DFI RS PRICE (without VAT) **13 990 €**

## FEATURES

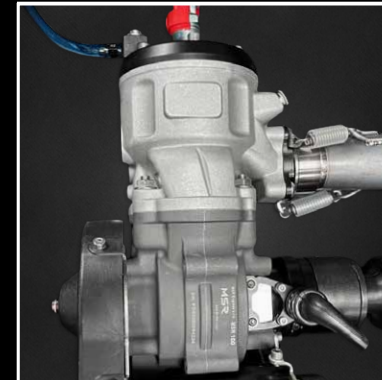

- Improved cylinder for the highest performance.



- Racing jetpump for maximum thrust.

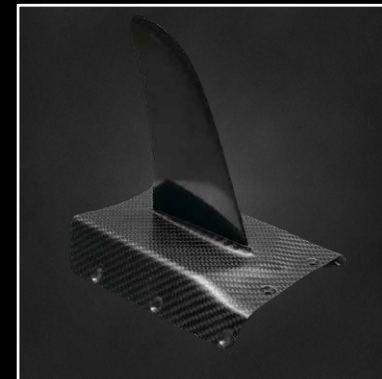

- Tougher main fin for more traction in the curve.

## NEW GRAPHIC DESIGN



WHITE CARBON



# 02

ELECTRIC  
SURFBOARDS





**ELECTRIC**

**2023**



**SILENT POWER**

Lenght	Width	Height	Weight	Cruising range	Charging time	Certification
180 cm	60 cm	15 cm	32,9 kg	25-55 min	2,5 hours	EPA CE

	With one battery included	Extra battery
<b>ELECTRIC PRICE (without VAT)</b>	<b>13 490 €</b>	<b>4 990 €</b>



**FEATURES**



- Dual foot bindings for both riding positions – REGULAR & GOOFY.



- Performance booster.



- FCS main and side fins – fast and simple click on / off system.



- Smart ventilation for easy maintenance.

**GRAPHIC DESIGN**



PROTON BLUE

- Systems for temperature, pressure, humidity and charging process monitoring
- Motor and regulator with active cooling
- Battery pack with passive cooling
- Three performance modes



# CONNECTIVITY



DOWNLOAD NOW!

# MOBILE

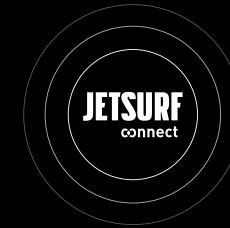
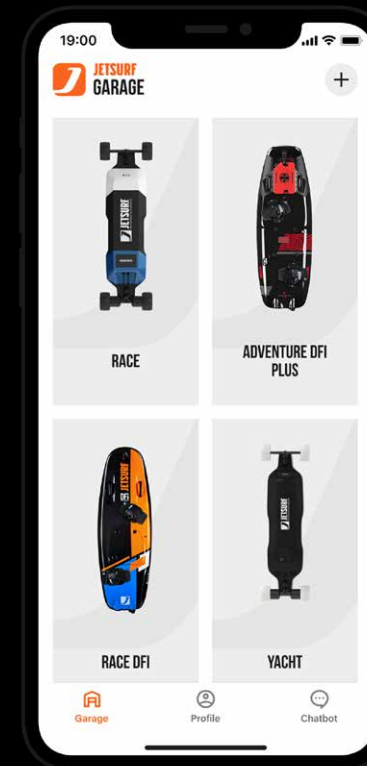

- Virtual Jetsurf garage

Be informed about your JETSURF inventory more than ever before. With the brand new app, you can easily add JETSURF devices to your garage and monitor current data in the infotainment section. The app is available on App Store & Google Play platforms or scan one of the following QR Codes.





# 03

## SKATEBOARDS





RACE

2023



UNLEASH THE JOY

Lenght	Width	Height	Weight	Max load	Top speed	Range up to
100 cm	25 cm	3 cm	11,5 kg	120 kg	50 km/h	40 km

RACE PRICE (without VAT) 1 810 €

FEATURES



- Remote controller with 3 speed modes and integrated display with all handy information about the board.

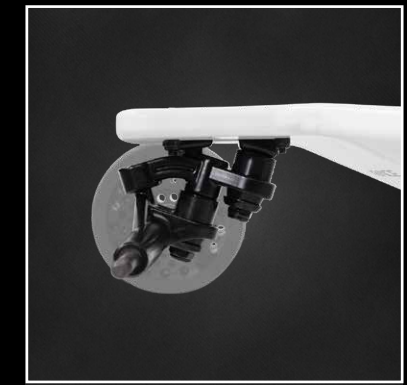

- Double kingpin trucks for high stability and ultimate carving experience.



- Enlarged 120mm AIRLESS wheels for smooth ride on all types of surfaces.

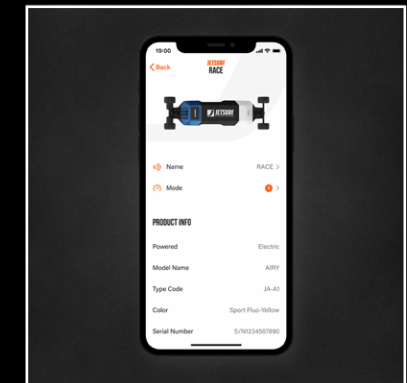

- iOS & Android compatible mobile app with the board infotainment.

GRAPHIC DESIGN





YACHT

2023

NEW



COOL RIDE!

Lenght	Width	Height	Weight	Max load	Top speed	Range up to
100 cm	25 cm	3 cm	9,9 kg	120 kg	50 km/h	40 km

YACHT PRICE (without VAT) 2 471 €

FEATURES



• Luxury remote controller with teak wood details.

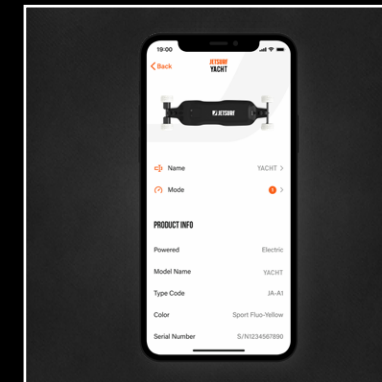

• iOS & Android compatible mobile app with the board infotainment.



• White airless wheels

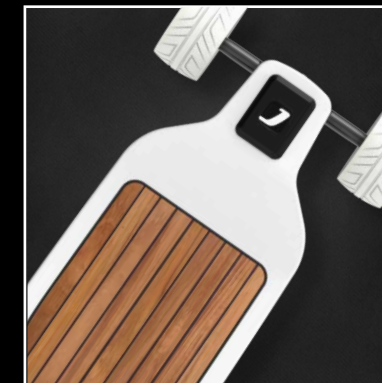

• Precisely designed grip from teak wood.

GRAPHIC DESIGN

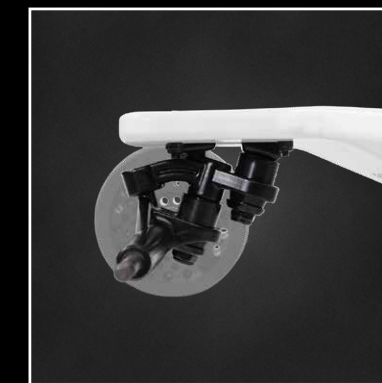

• Double kingpin trucks for high stability and ultimate carving experience.





ARI ATOLL, MALDIVES



MUMBAI, INDIA



TEL AVIV, ISRAEL



DUBAI, UAE

# JOIN THE JETSURF FAMILY



PLAYA DEL CARMEN, MEXICO



SANTA MARTA, COLOMBIA



BUSAN, KOREA



MUSKOKA, CANADA



KOH SAMUI, THAILAND



CANCÚN, MEXICO



BLACKMORE RANCH, CALIFORNIA



DUBAI, UAE



ALGARVE, PORTUGAL



ABU DHABI, UAE





# 04

WEAR





# WEAR



## HEAD WEAR



## TEES



## CREWNECK



## PONCHOS





# 05

RACING





# MOTOSURF WORLD CUP



# UIM

Since in 1922, The Union Internationale Motonautique (UIM), has been the world governing body for all powerboating activities. It is fully recognized by the International Olympic Committee (IOC). MotoSurf has been a member since 2019



# MSWC

Officially recognized sport discipline by the Union Internationale Motonautique (UIM). MotoSurf is the youngest, fastest growing and most affordable powerboating discipline.



# ECO FRIENDLY

1 TREE for every manufactured board to offset the impact





T. CORSER, AUSTRALIA



A. COLLEY, UK



L. ZÁHORSKÝ, CZECH REP.



S. KOVÁR, CZECH REP.



# READY TO RACE

A. AL-SABAH, KUWAIT



HAEM LEE, SOUTH KOREA



CH. MÜLLER, GERMANY



B. ŠULOVÁ, CZECH REP.



D. SVIRAČ, CROATIA



J. GULIANO, USA



S. GANTAR, SLOVENIA



C. CARPI, ITALY



D. KIM, SOUTH KOREA



B. JANOŠKOVÁ, CZECH REP.









BETTER THAN  
EVER BEFORE

 **JETSURF**

 [www.jetsurf.com](http://www.jetsurf.com)

 [info@jetsurf.com](mailto:info@jetsurf.com)

 +420 774 602 701

 @jetsurf\_official

 Jetsurf-official

vol.3