



# MOTION 400

---

## OWNER'S MANUAL





# CONTENTS

---

SAFETY INFORMATION	3
WHAT IS INCLUDED	6
ASSEMBLY	7
REMOTE GUIDE	10
OPERATION	11
PAIRING REMOTE	13
TROUBLESHOOTING	14
REPROGRAMMING REMOTE	15
ACCESSORIES	16
BASE HEIGHT GUIDE	17
RESOURCES	17

---

# USER INFO

Please take a moment and write down the serial number in the space provided below, in case you need to refer to it in the future. This information can be found by raising the head section of the bed.

**SKU:** GM-A4Z

**Serial Number** \_\_\_\_\_

This number will be required for future service claims.

# SAFETY INFORMATION

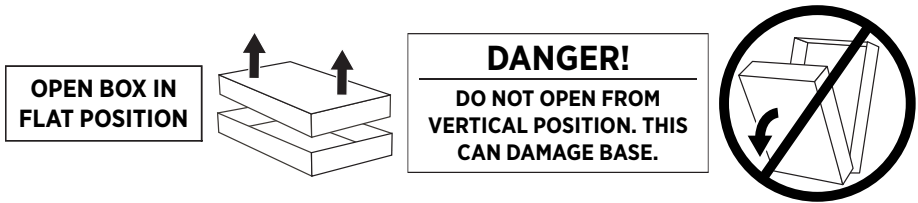

## ATTENTION!

IMPORTANT SAFETY INSTRUCTIONS. SAVE THIS MANUAL!  
PLEASE READ THESE INSTRUCTIONS THOROUGHLY BEFORE USING THIS PRODUCT.  
PROPER OPERATION OF YOUR ADJUSTABLE BED IS NECESSARY TO ENSURE THE LONG LIFE AND DURABILITY YOU EXPECT FROM A HIGH-QUALITY PRODUCT. THE MANUFACTURER HAS TESTED AND INSPECTED THIS PRODUCT PRIOR TO SHIPMENT.

### RADIO FREQUENCY IS 2.4Ghz.

This device complies with part 15 of the FCC Rules and Industry Canada's license exempt RSSs. Operation is subject to the following two conditions:

1. This device may not cause interference, and
2. This device must accept any interference received, including interference that may cause undesired operation of the device.

Any change to the antenna or the device could result in the device exceeding the RF exposure requirements and void the user's right to operate the device. The input voltage is AC100-240 50/60HZ; the output voltage is DC29V 1.8A. Total USB power output is 2 AMP.

**WARNING: TO PREVENT FIRE OR SHOCK HAZARD, DO NOT EXPOSE THIS UNIT TO MOISTURE.**

### ELECTRICAL SAFETY

Always unplug this adjustable bed from the electrical outlet before any cleaning or maintenance of the adjustable bed. To safely disconnect, remove the plug from the outlet. Keep cord away from heated surfaces. Use only indoors.

Discontinue use of this adjustable bed and contact the manufacturer for repair if:

1. It has a damaged cord or plug,
2. It is not working properly, or
3. It has been dropped or damaged.

FOR OPTIMAL SAFETY, YOUR ADJUSTABLE BED SHOULD BE PLUGGED INTO A SURGE PROTECTOR (not supplied with this adjustable bed).

### BATTERY PRECAUTIONS

Follow these precautions when using batteries in this device:

1. Warning - Danger of explosion if battery is incorrectly replaced. Replace only with the 6LR61 9V batteries and LR03 AAA batteries.
2. Be sure to follow the correct polarity when installing the batteries as indicated in the battery compartment. A reversed battery may cause damage to the device.
3. Do not mix different types of batteries together (e.g. Alkaline, Rechargeable and Carbon-zinc) or old batteries with fresh ones.
4. If the device is not to be used for a long period of time, remove the batteries to prevent damage or injury from possible battery leakage.
5. Do not try to recharge a battery not intended to be recharged; it can overheat and rupture. (Follow battery manufacturer's directions.)

# SAFETY INFORMATION

## WARRANTY WARNING!

This bed is specifically designed to require no maintenance by you, the user. Any opening or tampering with the control box, motors or hand controls (with the exception of the battery compartment, if equipped) will void the warranty. Do not attempt to alter component wiring or adjust or modify the structure of the product in any way or the warranty will be void. Only those authorized may conduct repairs or part replacement on your adjustable bed.

## IN-HOME USE ONLY

This adjustable bed is designed exclusively for in-home use.

## HOSPITAL/COMMERCIAL DISCLAIMER

This base is NOT designed for commercial or hospital use and is NOT designed to meet hospital standards. Do not use this base with TENT TYPE oxygen therapy equipment or use near explosive gases.

## PRODUCT RATINGS

### Lift Motor Restrictions:

The lift motors in this bed are NOT designed to operate continuously for more than one (1) minute over a nine (9) minute time period, or approximately 12% duty cycle. To ensure reliable functionality and full life of this product, do not attempt to exceed these limits. **NOTE: Attempting to circumvent or exceed this rating will shorten the life expectancy of the product and may void the warranty.**

### Weight Restrictions:

The recommended weight limits on our adjustable beds are:

- 1/pc King: 800 lb
- Queen: 650 lb
- Full/XL: 500 lb
- Twin/XL: 400 lb (800 lb if using two twin XLs as a King)
- 
- The structure of the bed will support the recommended weight when distributed evenly across the bed.
- **The head and foot sections are not designed to individually support or lift this amount of weight.**
- For optimal performance and integrity of structure, entering and exiting the adjustable bed with the bed in the flat position is recommended.
- **NOTE: Exceeding the recommended weight restrictions could damage your adjustable bed and void your warranty.**

# SAFETY INFORMATION

## **SMALL CHILDREN AND PETS WARNING**

Immediately dispose of all packing materials, as they can pose a smothering risk to small children and pets. Injury could also occur if children or pets are permitted to play on or under the bed. Do not allow children to operate this bed without adult supervision.

## **LUBRICATION AND CLEANING**

This product is designed to be maintenance free. The lift motors are permanently lubricated and sealed—no additional lubrication is required. Do not apply lubricant to lift motor lead screws or any nylon nuts or the base may inadvertently creep downward from the elevated position.

## **LIFT WARNING**

DO NOT SIT ON THE HEAD OR FOOT SECTIONS WHILE IN THE RAISED POSITION, OR DURING LIFT OR LOWERING CYCLES.

## **MOVING AFTER INSTALLATION**

Do not place adjustable bed base vertically on its head or foot sections. This may cause injury to persons or damage to base.

## **WARNING!**

To reduce the risk of burns, fire, electric shock, or injury to persons:

- Unplug from outlet before putting on or taking off accessories.
- Close supervision is necessary when this base is used by, or near children, invalids, disabled persons, or pets.
- Use this base only for its intended use as described in these instructions.  
Do not use attachments not recommended by the manufacturer.
- Never operate this base if it has a damaged cord or plug, is not working properly, has been dropped or damaged, or dropped in water.
- Keep the cord away from heated surfaces.
- Never drop or insert any object into any opening.
- Do not use outdoors.
- Do not operate where aerosol (spray) products are being used or where oxygen is being administered.
- To disconnect, remove plug from outlet.
- **DO NOT USE NEAR PEOPLE USING OR WEARING MEDICAL DEVICES.**  
FOR HOUSEHOLD/RESIDENTIAL USE ONLY.

# WHAT'S INCLUDED

Before discarding any packing materials, check the adjustable base shipping carton and verify the following items are included:

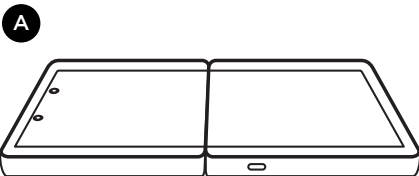

**A**

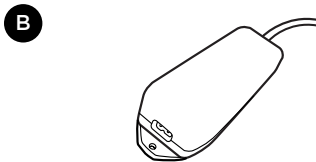

**B**

(1) Power Supply



**C**

(1) Remote Control

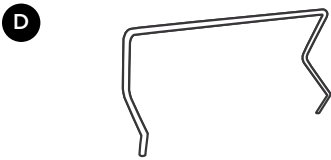

**D**

(1) Foot Mattress Retainer

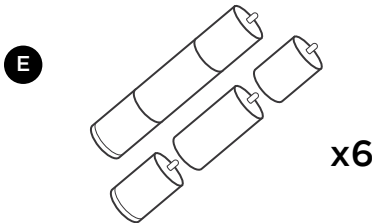

**E**

(6) Legs



**F**

(1) AC Power Cord

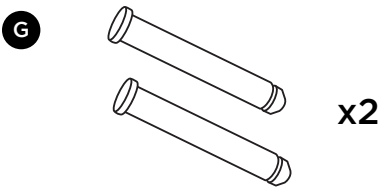

**G**

(2) Hinge Pins



**H**

(2) Retainer Clips

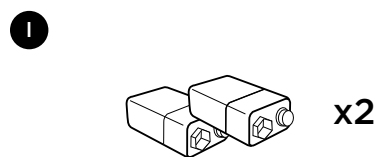

**I**

(2) 9V Batteries

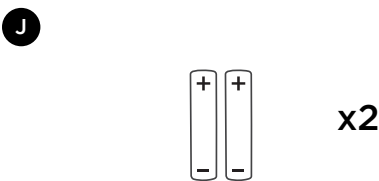

**J**

(2) AAA Batteries



**K**

(1) Sync Cable

*for use with TXL, SCK, SQ models only*

**IMPORTANT:**  
**USE 2 PEOPLE TO LIFT BASE TO AVOID DAMAGE.**

**NOTE:**  
 Carefully lift base from the shipping carton, keeping the unit's top-side down.  
 Remove the plastic wrapping from the bottom to access the base.

# ASSEMBLY

It is HIGHLY recommended to use two people for the installation of this product. To assemble, please perform the following steps:

- 1** Carefully lift the base from the shipping carton, keeping the unit's topside down. Remove the plastic wrapping from the bottom to access the bases.

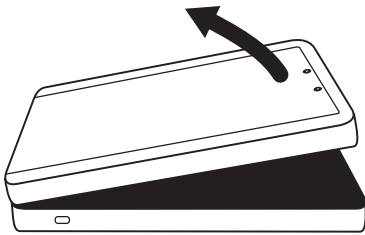

- 2** Lay base flat and unfold topside down.



**KEEP HANDS CLEAR OF HINGE PINCH POINT**  
Lay the base flat before unfolding base.

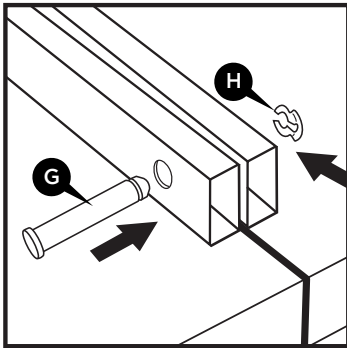
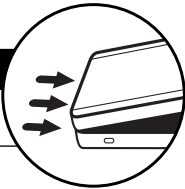

- 3** Insert hinge pins and secure with retaining clips. Repeat on both sides of base.

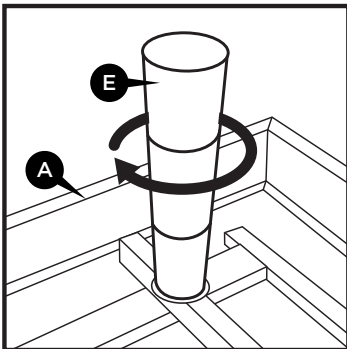

If installing on a platform base or foundation, do not install legs. Follow the instructions included in the MULTIFUNCTION BRACKET accessory kit.

- 4** Insert all 6 legs into the threaded holes and securely tighten before turning base over for use. There must not be any gap or wobble in the leg in order to avoid risk of injury or damage to the base which may void warranty.

# ASSEMBLY

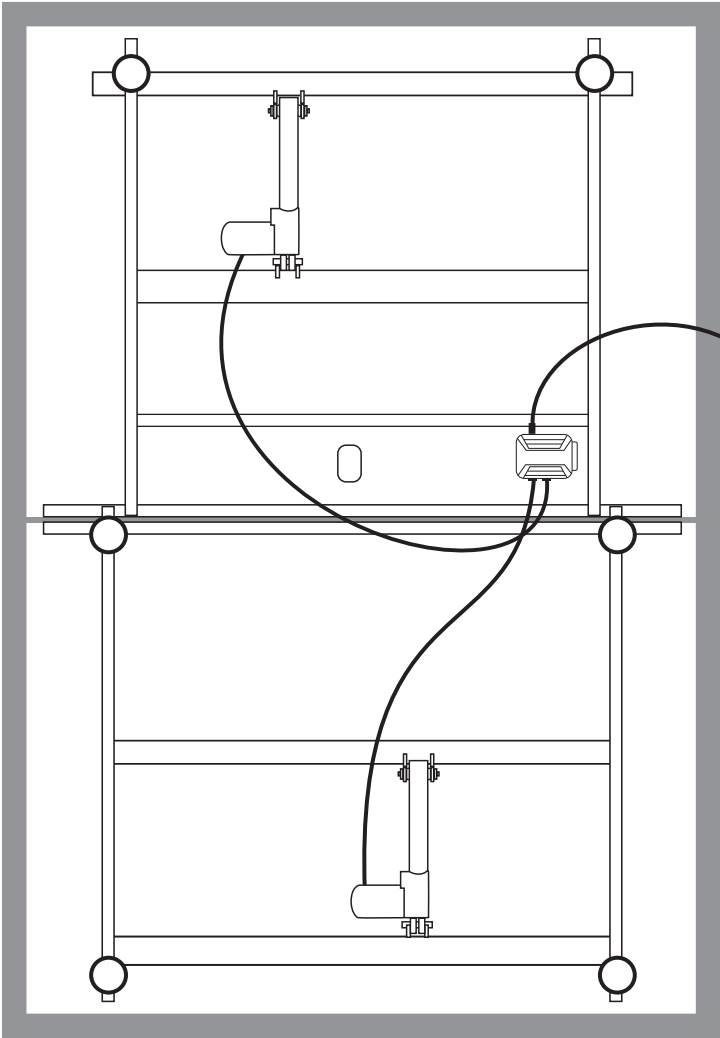

**5** Insert DC cord from base into the power supply.

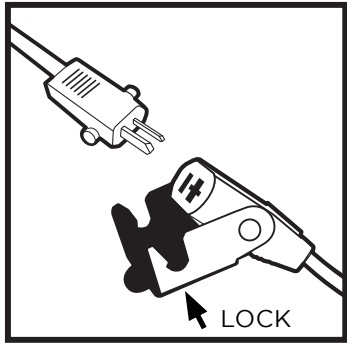

**6** Insert the AC cord into the power supply.

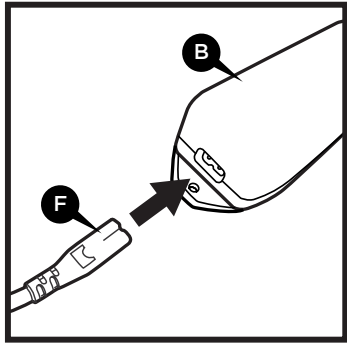

TO OUTLET

**7** Carefully rotate the base on its side, then lift and place on legs.

**WARNING**  
**DO NOT TILT or LEAN base on the installed legs when turning base over.**



# ASSEMBLY

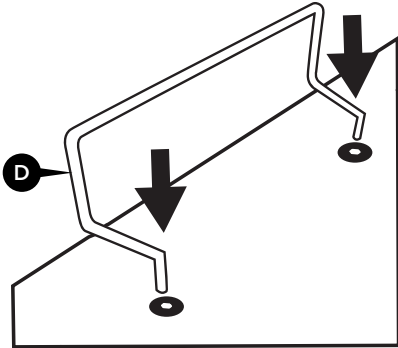

**8** Insert the mattress retainer bar upright as shown.

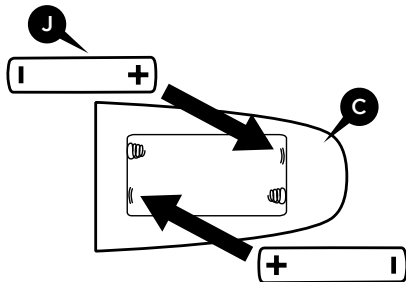

**9** Lift the battery cover and insert the two AAA size batteries (included) into the remote as shown in the figure. Replace the battery cover. Remote is already linked with the base.

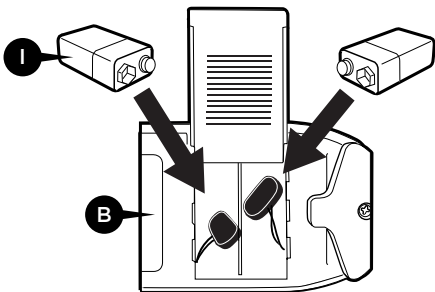

**10** Turn the power supply upside down to access the battery cover, then slide the battery cover off.

**11** Insert the two 9V batteries (included) into the compartment and slide the cover back on.

**NOTE:**  
The battery backup will allow for the bed to be lowered if a power outage occurs. It is not recommended to do anything except lower the bed, as the battery backup will not last if the features are continually used.

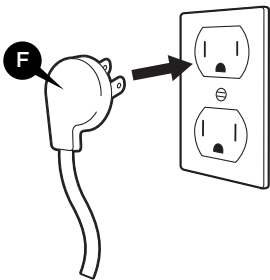

**12** Insert AC plug into an AC outlet having 100-240V AC, 50/60Hz. Avoid outlets that work only with light switch.

**NOTE:**  
If attaching headboard brackets (available separately) to the base, see the included instructions. Otherwise, place the desired mattress onto the base and enjoy your new adjustable base!

# REMOTE GUIDE

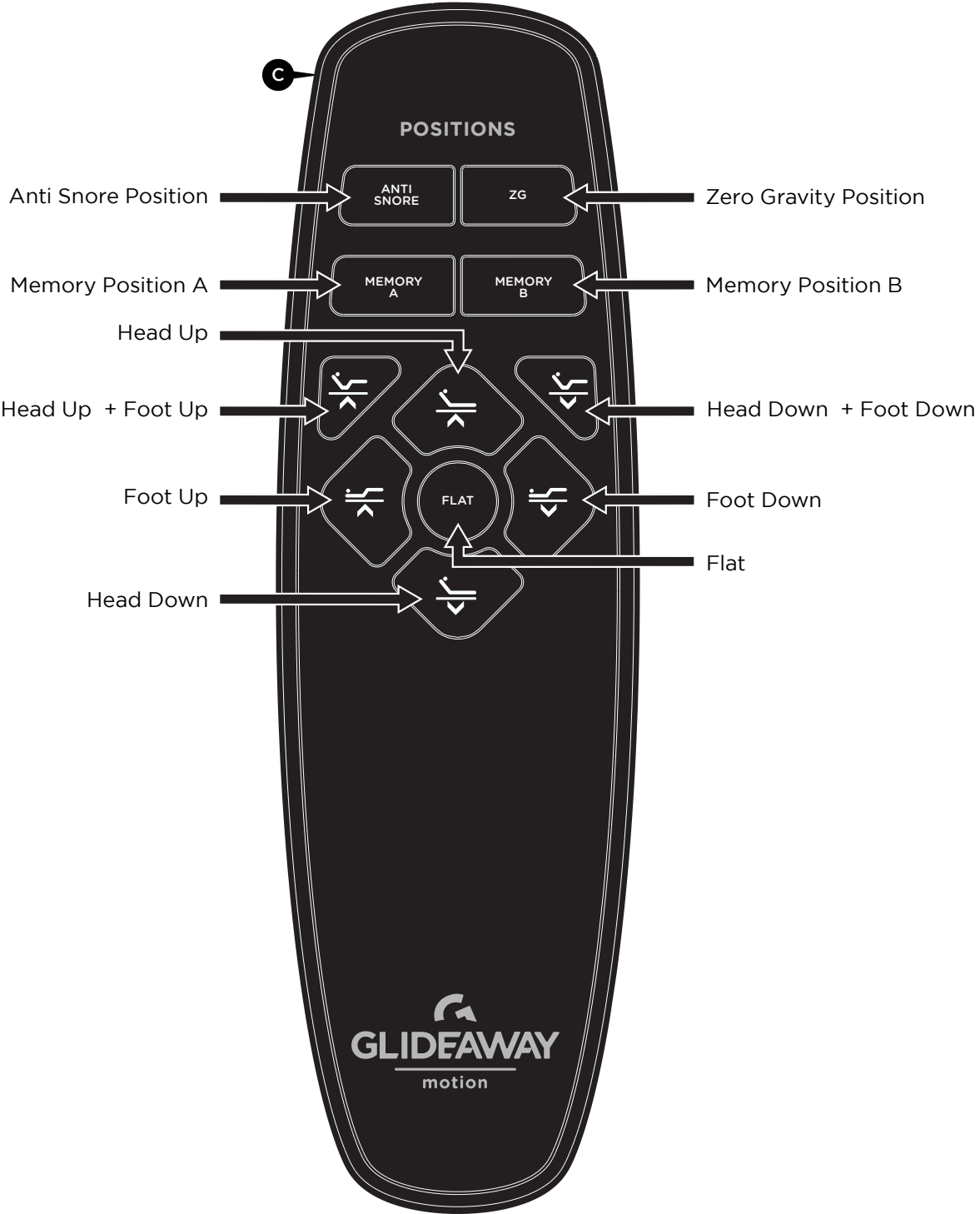

# OPERATION

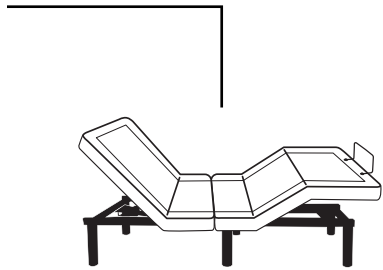
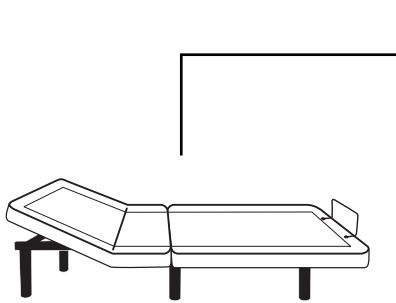

Press the ANTI-SNORE button and the head will go to the ANTI-SNORE position. This action can be stopped at any time by pressing another button.

Press the ZERO GRAVITY button to move the head and foot to the ZERO GRAVITY position. This action can be stopped at any time by pressing another button.

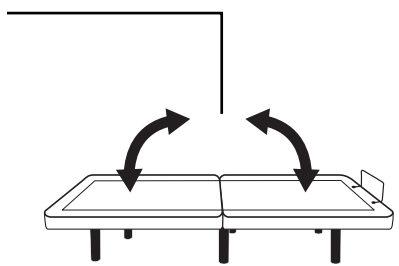
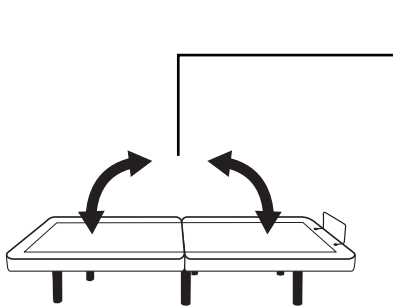

Adjust head and/or foot section(s) to desired positions. Press and hold MEMORY A button until the back-light on remote flashes. Release button and wait for flash to stop. Button has now been programmed. Repeat process if new preset position is desired.

Adjust head and/or foot section(s) to desired positions. Press and hold MEMORY B button until the back-light on remote flashes. Release button and wait for flash to stop. Button has now been programmed. Repeat process if new preset position is desired.

# OPERATION

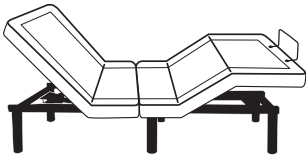

Press and hold the HEAD UP + FOOT UP button to raise the head and foot simultaneously. Release button when desired position is reached.

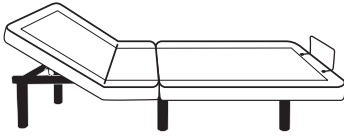

Press and hold the HEAD UP button to raise the head position. Release button when desired position is reached.

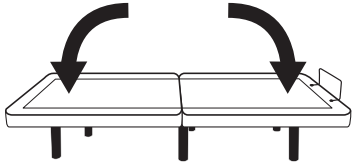

Press and hold the HEAD DOWN + FOOT DOWN button to lower the head and foot simultaneously. Release button when desired position is reached.

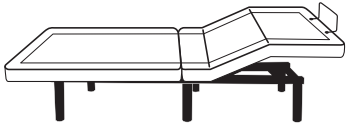

Press and hold the FOOT UP button to raise the foot position. Release button when desired position is reached.

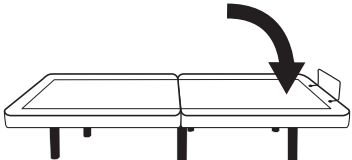
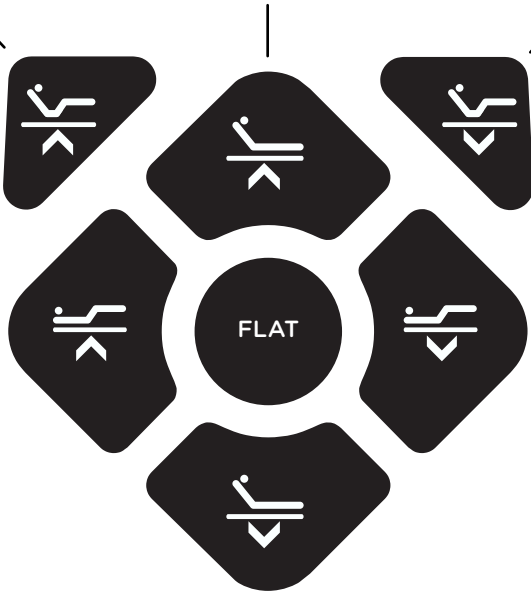

Press and hold the FOOT DOWN button to lower the foot position. Release button when desired position is reached.

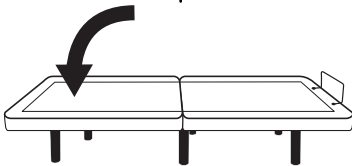

Press and hold the HEAD DOWN button to lower the head position. Release button when desired position is reached.

# PAIRING REMOTE

**NOTE:**

Your base comes with a ready-to-use, factory paired remote. Pairing instructions are for replacement remotes or trouble shooting purposes.

**PAIRING REMOTE TO BASE**

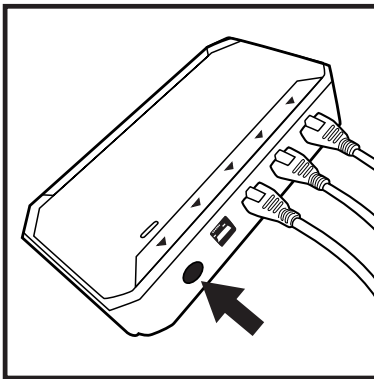

Double click the PAIR button on the control box (light will turn blue during the pairing process).

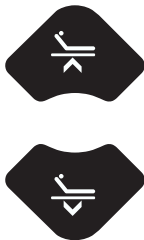

Simultaneously press and hold the HEAD UP and HEAD DOWN buttons on remote until the remote back lights flash and stay lit, then release remote buttons.

**SYNCING 2 BASES TO ACT AS ONE**  
If SYNCING 2 bases (TXL, SCK, SQ) together, follow these instructions.

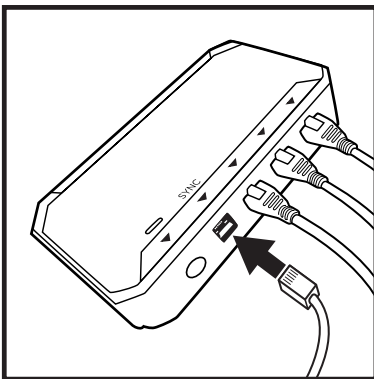

With both bases in FLAT position, connect each base to the other by inserting SYNC CABLE into each control box slot labeled sync.

# TROUBLESHOOTING

In the event the base fails to operate, investigate the symptoms and possible solutions provided below:

---

**Remote control illuminates and appears to be operable, but no features of the base will activate.**

- Unplug power cord, wait 30 seconds and plug in to reset electronic components.
- Defective surge protection device or electrical outlet. Test outlet by plugging in another working appliance.
- Electrical circuit breaker may be tripped. Check electrical service breaker box to verify.
- Re-pair the remote control (see Pairing Remote section of this manual for programming procedures).
- Replace batteries in the remote control & re-pair remote control.

---

**No features of the base will activate.**

- Unplug power cord, wait 30 seconds and plug in to reset electronic components.
- Defective surge protection device or electrical outlet. Test outlet by plugging in another working appliance.
- Electrical circuit breaker may be tripped. Check electrical circuit breaker box to verify.

---

**Remote control will not illuminate.**

- Replace batteries in the remote control.

---

**Head section will elevate, but will not return to the horizontal (flat) position.**

- Base mechanism may be obstructed. Elevate base and check for obstruction. Remove obstruction.
- Headboard may be too close to the edge of the mattress. Verify that distance between headboard brackets and mattress is sufficient. Adjust if required.

---

**Head or foot lift function has minor interference during operation.**

- Check batteries in remote, replace if necessary.
- Make sure that you are following the duty cycle of the motor (do not operate more than one (1) minute over a nine (9) minute period, or approximately a 12% duty cycle).
- Press the lift buttons squarely and accurately.
- Control box may be experiencing common Radio Frequency Interference from other radio transmitting devices (see Pairing Remote section).

---

**Reset remote to original factory settings.**

- To reset the factory ANTI-SNORE, ZERO GRAVITY, MEMORY A and MEMORY B settings, hold down the FLAT and ZERO-GRAVITY buttons until the back light blinks.

---

**Bases are not well synced to one another.**

- Refer to the REPROGRAMMING REMOTE section; page 15.

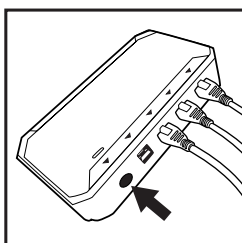

**NOTE:**  
 EMERGENCY LOWERING: If you cannot find the remote control, locate, press and hold the PAIR button located on the main control box on the bottom of the bed (shown to the left).

# REPROGRAMMING REMOTE

When syncing 2 TXL, SQ, SCK bases, the ANTI-SNORE, ZERO GRAVITY, MEMORY A and MEMORY B may need to be reprogrammed to match the 2 bases to the same program.



- 1 ANTI-SNORE**  
After connecting the sync cable into both bases, press the FLAT button on the remote.
- 2**  
Press the HEAD UP button until the 2 bases are at a 10 degree angle. Push and hold the ANTI-SNORE button until the remote back lights blink.

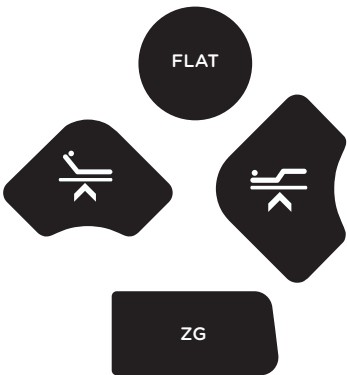

- 1 ZERO GRAVITY**  
Press the FLAT button on the remote.
- 2**  
Press the HEAD UP button until the 2 bases reach the 15 degree angle. Next, push FOOT UP button until the foot section of both bases reach the 25 degree angle. Next, press and hold the ZERO GRAVITY button until the remote back lights blink.

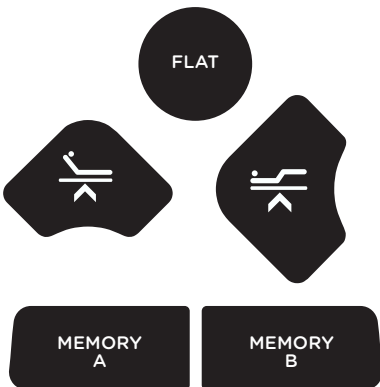

- 1 SETTING MEMORY A OR MEMORY B**  
Press the FLAT button on the remote.
- 2**  
Using the HEAD UP and FOOT UP, adjust the base to a comfortable position. Next, press and hold MEMORY A button until the remote back lights blink.

Repeat this process for the MEMORY B position.

# ACCESSORIES

**HIGH PROFILE LEG KIT**

Raise height of base to 20".  
SKU: GM6LEGEXT

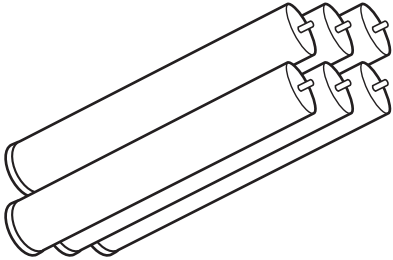

**X6**

**HEADBOARD BRACKET KIT**

Attach base to headboard.  
SKU: CB18HBBRKT

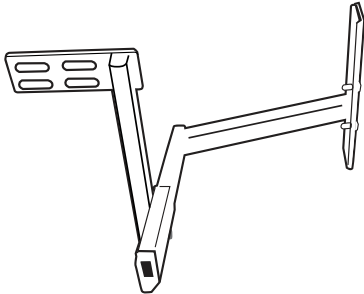

**X2**

**MULTIFUNCTION BRACKET KIT**

**NOTE:** 2 MULTIFUNCTION BRACKET KITS required for connecting 2 platform bases.  
**NOTE:** Not to be used with ELEVATION KIT.  
SKU: GM-ZCAZ-1 (TWIN and TWIN XL)  
SKU: GM-ZCAZ-2 (FULL, QUEEN and KING)

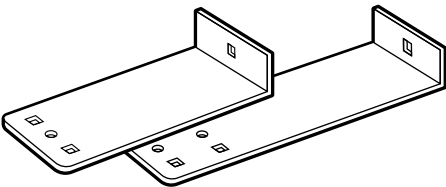

**X4**

**HI-LO LIFT KIT**

Raises and lowers bed.  
SKU: RXSYS2-TXL (TWIN XL KIT)  
SKU: RX2.AZ-TXL (TWIN XL BRACKETS)  
SKU: RXSYS2-Q (QUEEN KIT)  
SKU: RX2.AZ-Q (QUEEN BRACKETS)

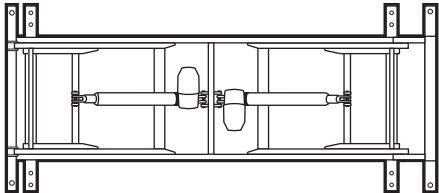

**BLUETOOTH® MODULE**

Operate your base via Bluetooth with the Glideaway Motion app.  
SKU: CB-BLUETOOTHV2

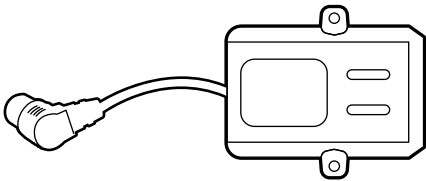



# BASE HEIGHT GUIDE

LEG CONFIGURATION	HEIGHT FROM FLOOR
NO LEG INSTALLED	4 1/2"
STANDARD 3-IN-1	15"
TWO LEG SECTIONS INSTALLED	11 1/2"
ONE LEG SECTION INSTALLED	8"
OPTIONAL HIGH PROFILE LEG	20"

# DOWNLOAD THE APP



This adjustable base\* is compatible with our Glideaway Motion for Bluetooth remote app. Go to [www.glideaway.com/app](http://www.glideaway.com/app) to learn more.

\*With Bluetooth module accessory, sold separately.

# RESOURCES

Accessory Orders and Customer Service **1-855-581-3095**  
Warranty information is available at [glideaway.com](http://www.glideaway.com)

# MOTION 400

---

SLEEP WELL. LIVE BETTER. BE YOUR BEST.

