

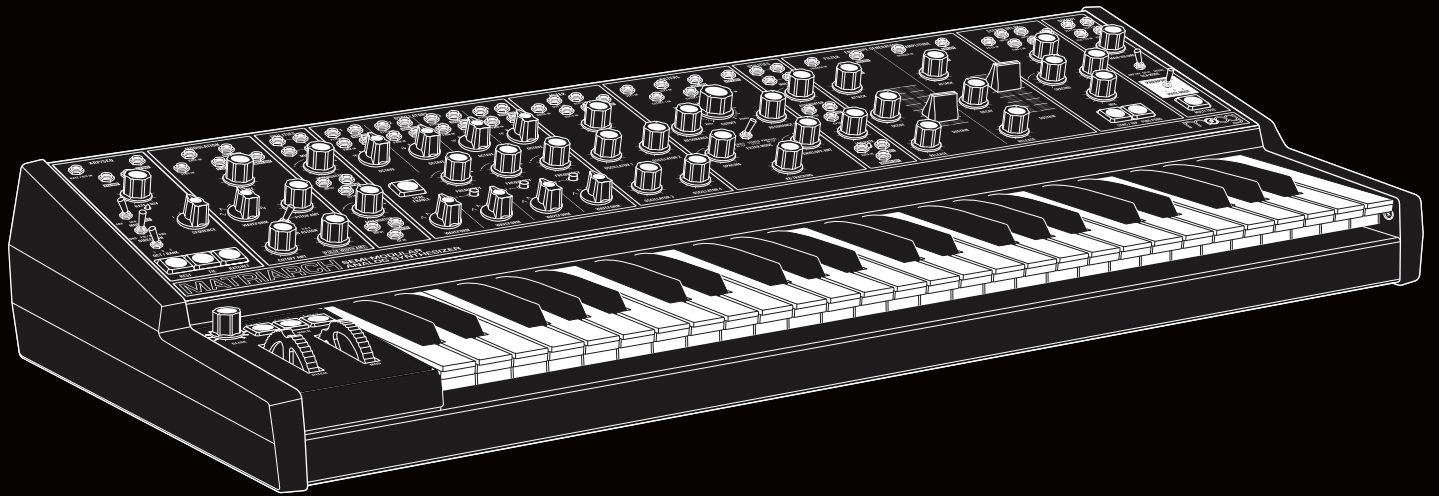

MATRIARCH DARK

USER'S MANUAL



“To be human, to be fully human, is to need music and derive nourishment from the music you hear. What you do with our instruments helps us be more human too, and I want to thank you all for that.”

- **Dr. Robert Moog** -

IMPORTANT SAFETY INSTRUCTIONS

WARNING - WHEN USING ELECTRIC PRODUCTS, THESE BASIC PRECAUTIONS SHOULD ALWAYS BE FOLLOWED:

1. Read all the instructions before using the product.
2. Do not use this product near water - for example, near a bathtub, washbowl, kitchen sink, in a wet basement, or near a swimming pool or the like.
3. This product, in combination with an amplifier and headphones or speakers, may be capable of producing sound levels that could cause permanent hearing loss. Do not operate for a long period of time at a high volume level or at a level that is uncomfortable.
4. The product should be located so that its location does not interfere with its proper ventilation.
5. The product should be located away from heat sources such as radiators, heat registers, or other products that produce heat. No naked flame sources (such as candles, lighters, etc.) should be placed near this product. Do not operate in direct sunlight.
6. The product should be connected to a power supply only of the type described in the operating instructions or as marked on the product.
7. The power supply cord of the product should be unplugged from the outlet when left unused for a long period of time or during lightning storms.
8. Care should be taken so that objects do not fall, and liquids are not spilled, into the enclosure through openings.

There are no user serviceable parts inside. Refer all servicing to qualified personnel only.

NOTE: This equipment has been tested and found to comply with the limits for a Class B digital device, pursuant to Part 15 of the FCC rules. These limits are designed to provide reasonable protection against harmful interference in a residential installation. This equipment generates, uses, and can radiate radio frequency energy and, if not installed and used in accordance with the instructions, may cause harmful interference to radio communications. However, there is no guarantee that interference will not occur in a particular installation. If this equipment does cause harmful interference to radio or television reception, which can be determined by turning the equipment off and on, the user is encouraged to try to correct the interference by one or more of the following measures:

- Reorient or relocate the receiving antenna.
- Increase the separation between the equipment and receiver.
- Connect the equipment to an outlet on a circuit different from that to which the receiver is connected.
- Consult the dealer or an experienced radio/TV technician for help.

CAUTION: Please note that any changes or modifications made to this product not expressly approved by Moog Music Inc. could void the user's authority granted by the FCC to operate the equipment.

OPERATING CONDITIONS AND STORAGE:

For optimal performance you should use your Matriarch between 50 - 95 degrees Fahrenheit or 10 - 35 degrees Celsius. Safe operating conditions are within the range of 50 - 110 degrees Fahrenheit or 10 - 43 degrees Celsius.

Your Matriarch should be stored in temperatures above 32 F (0 C) but never greater than 135 F (57 C). Do not leave your Matriarch in a vehicle on a hot day with the windows closed. Temperatures in a vehicle can exceed 175 F (80 C).

TABLE OF CONTENTS

8 UNPACKING AND INSPECTION

8 SETUP AND CONNECTIONS

9 ABOUT MATRIARCH

10 Signal Flow

10 FEATURES AND CONTROLS

10 Keyboard

11 Left-Hand Controller

13 Oscillators

14 Understanding Oscillator Sync

16 Oscillator Patch Points

17 Mixer

19 Mixer Patch Points

20 Filters

23 Filter Patch Points

25 Envelope Generators (ADSR)

27 Envelope Generator Patch Points

29 Output

30 VCA Patch Points

32 Stereo Delay

34 Stereo Delay Patch Points

36 Modulation

38 Modulation Patch Points

40 Utilities (1)

42 Utilities (2)

44 Arp / Seq

48 Arp / Seq Patch Points

49 Arp / Seq LHC Controls

50 Paraphony

52 REAR PANEL

54 Audio Jacks

56 Stereo Delay Jacks

56 Keyboard Jacks

58 Arp / Seq Jacks

59 MIDI Ports

61 GLOBAL SETTINGS

70 MIDI DOCUMENTATION

78 SIGNAL FLOW DIAGRAMS

80 BLANK PRESET SHEETS

84 SPECIFICATIONS

85 WARRANTY

85 SERVICE AND SUPPORT INFORMATION

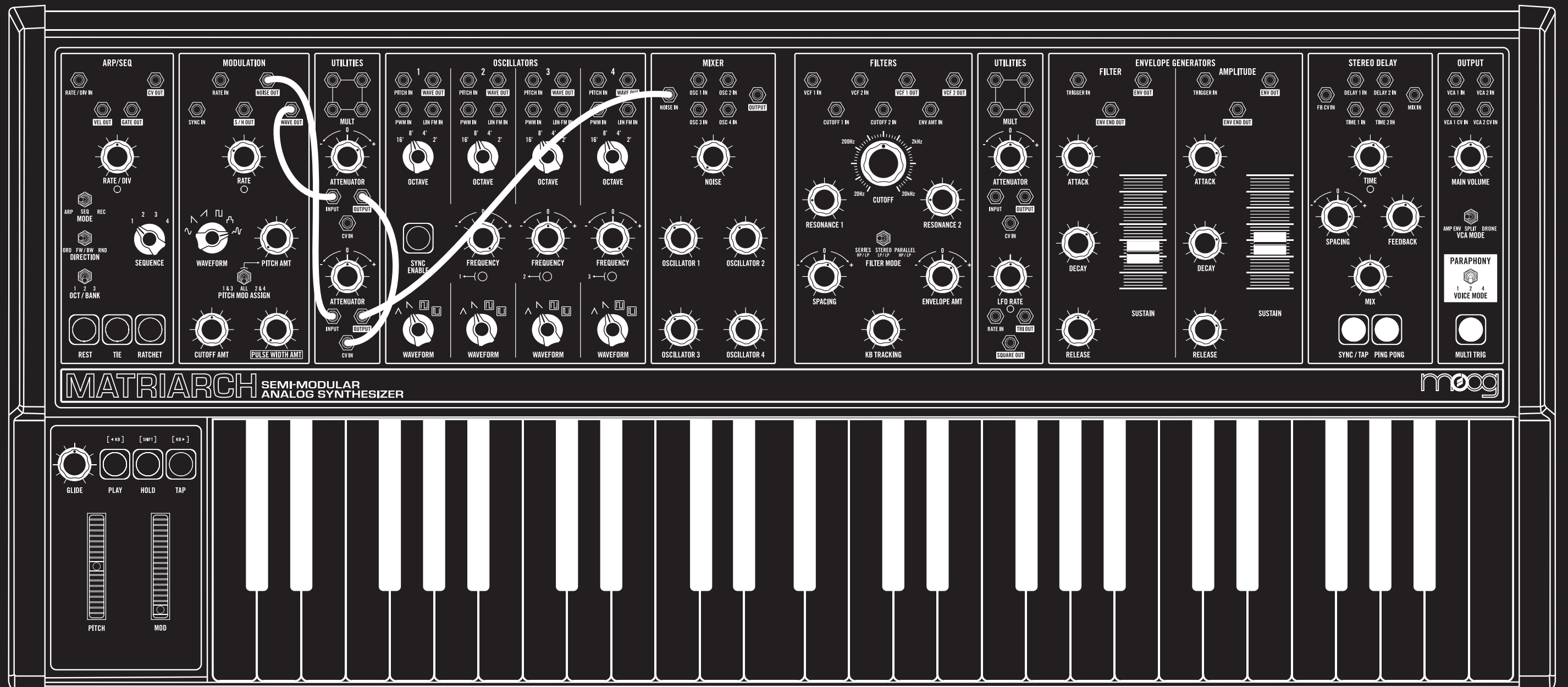

MATRIARCH

Based on the vintage circuitry of classic Moog synthesizer modules, Matriarch is a catalyst for creative ideas and a medium for multidimensional expression.

UNPACKING AND INSPECTION

Check the contents of the shipping carton. Be careful when unpacking your new Moog Matriarch so that nothing is lost or damaged. Moog recommends saving the carton and all packing materials in case you ever need to ship the instrument for any reason.

Matriarch ships with the following items:

1. Matriarch Semi-Modular Analog Synthesizer
2. Power Supply
3. Owner's Manual
4. Patch Cables
5. Registration Card

What you will need:

1. A table or surface where you can set your Matriarch. (30lbs / 13.61kg)
2. A 1/4" instrument cable and amplified speaker, or headphones with a 1/4" plug.
3. A properly wired AC outlet. (100 Volts to 240 Volts AC; 50/60 Hz)

SETUP AND CONNECTIONS



POWER

Plug the included power adapter into the 12V DC power jack on the back of your Matriarch. Plug the other end of the included power adapter into an AC outlet. Matriarch uses a universal power supply that operates with power sources from 100 Volts to 240 Volts AC; 50/60 Hz.

NOTE: Your Matriarch is an analog instrument and should be allowed 10-15 minutes to warm up before use. In cases where it has been left in a cold car overnight, for example, it may take as long as 25 minutes before oscillator tuning has stabilized. Do not operate Matriarch in direct sunlight.

AUDIO OUTPUTS

With the Matriarch **MAIN VOLUME** knob turned all the way down, plug one end of a 1/4" (TS) instrument cable into the **MAIN OUT LEFT (MONO)** jack on the rear panel to monitor the instrument in mono. To monitor the instrument in stereo, connect a second 1/4" (TS) instrument cable to the **MAIN OUT RIGHT** jack on the rear panel.

NOTE: The **MAIN OUT** jacks will work with both TS and TRS 1/4" cables.

Plug the other end(s) into an amplified speaker or mixing console line-level input. Raise the **MAIN VOLUME** knob above the 12 O'clock position, and adjust the amplifier or mixer level accordingly.

HEADPHONE OUT

Also on the rear panel is a stereo headphone jack, complete with its own **HEADPHONE VOLUME** knob for private listening or monitoring.

NOTE: This headphone jack is unaffected by the **MAIN VOLUME** knob in the Output module on the front panel.

ABOUT MATRIARCH

Matriarch sits at the pinnacle of the Moog family of semi-modular synthesizers. The patchable architecture and classic Moog circuits reward open exploration with endless sonic possibilities and unparalleled analog sound. Matriarch's four analog VCOs can be split into four notes of paraphony that can be sequenced, shifted, and stored with the instrument's intuitive 256 step Sequencer, or stacked in unison to create a massive four-oscillator mono synth.

With a deep assortment of synthesis modules based on Bob Moog's original circuit designs, Matriarch provides a 100% analog signal path spanning a dynamic sonic vocabulary - from overdriven monophonic bass to gently evolving paraphonic plucks that cycle through waveshapes into a wash of infinite delay trails. Coupling the power of vintage-designed stereo Ladder Filters, dual Envelope Generators, stereo Analog Delays, and stereo VCAs, Matriarch delivers a multi-dimensional sound that empowers the sonic exploration of both space and time.

Although Matriarch uses a semi-modular design that requires absolutely no patching, 90 modular patch points are easily accessible throughout the panel via the included 3.5mm patch cables. This powerful electronic instrument is a highly-versatile addition to any stage or studio that can effortlessly transform from a performance keyboard into a fully modular analog synthesizer at a moment's notice.

In addition to its standalone function, Matriarch is also an ideal processor of external sound sources and a powerful keyboard front-end for expanding a DFAM, Mother-32, Grandmother, or Eurorack modular system.

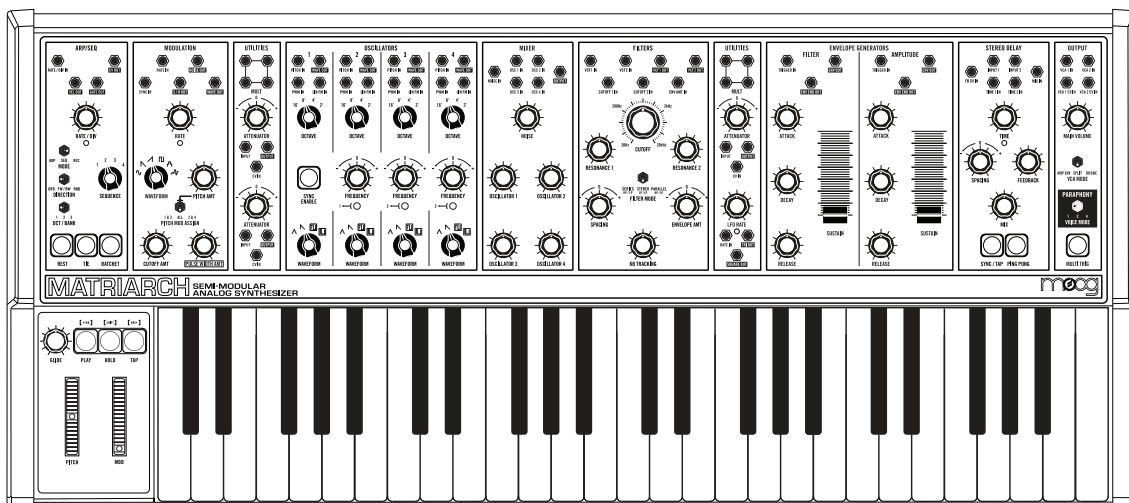

EXQUISITE EXPRESSION

49 velocity-sensing keys with aftertouch, glide, and pitch & mod wheels.

HANDS-ON INTERFACE

Dark semi-modular front panel with single-function knobs, switches, and red buttons.

PATCHABLE PERFORMER

90 modular patch points with expression pedal connectivity, external audio input, plus 5-Pin DIN & USB MIDI.

OSCILLATOR ABUNDANCE

4 analog oscillators with Hard Sync and FM capabilities.

FLEXIBLE FILTERING

Dual Ladder filters configurable in series, parallel, or stereo modes.

RHYTHMIC RECALL

Record and playback 12 unique sequences with up to 256 notes each, or arpeggiate endlessly through a random selection of held notes.

MULTIPLE MODULATORS

Dual, voltage-controlled analog LFOs with selectable waveforms and patchable routing.

ANALOG EFFECTS

Stereo analog delay with MIDI sync, ping pong, and tap tempo.

USEFUL UTILITIES

Three bipolar voltage-controlled attenuators and two 4-jack mults.

VERSATILE VOICING

Perform in mono (1-note), 2-note, and 4-note paraphonic modes.

SIGNAL FLOW

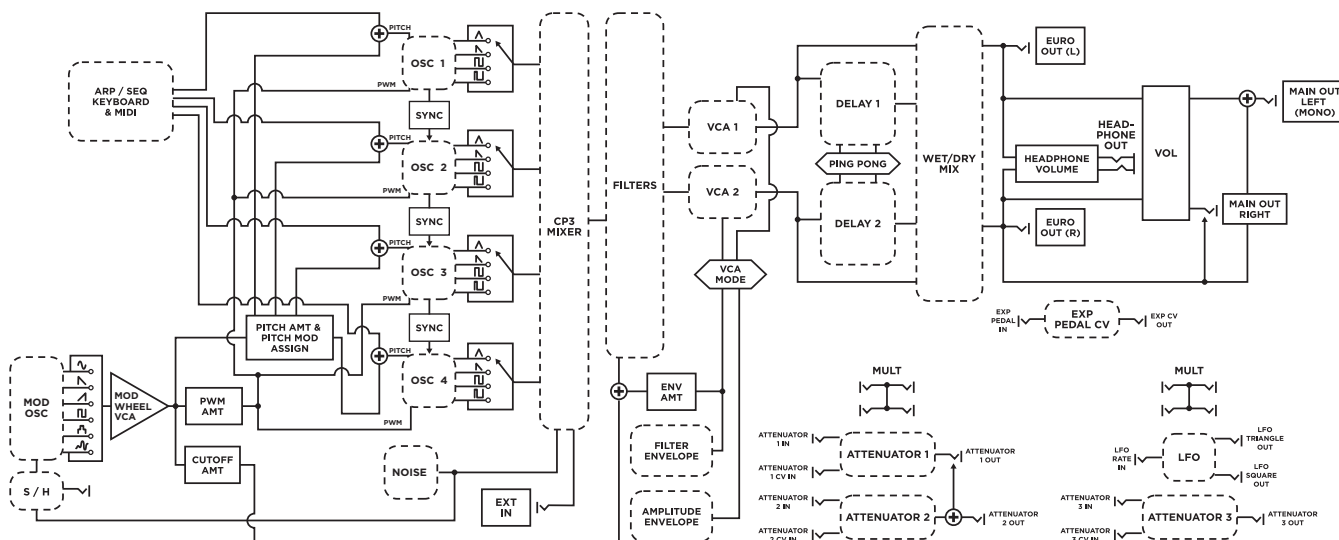

REFERENCE: To view the full Signal Flow diagram see Page 70-71.

FEATURES AND CONTROLS

Matriarch's panel is comprised largely of single-function knobs, switches, and buttons that are grouped together by module. Each module is equipped with a set of 3.5mm patch points that can be utilized to create new audio and control pathways within Matriarch. These patch points can also be used to establish synchronization and interconnectivity with other Moog synthesizers like Mother-32, DFAM, and Grandmother, or to create a completely a new instrument through deep integration with a Eurorack modular system.

NOTE: Additional patch points and connectors are available on Matriarch's rear panel.

KEYBOARD

Matriarch offers a 49-note Fatar keyboard with velocity and channel aftertouch. There are no hardwired connections for these signals; they can be easily accessed via rear-panel patch points and MIDI.

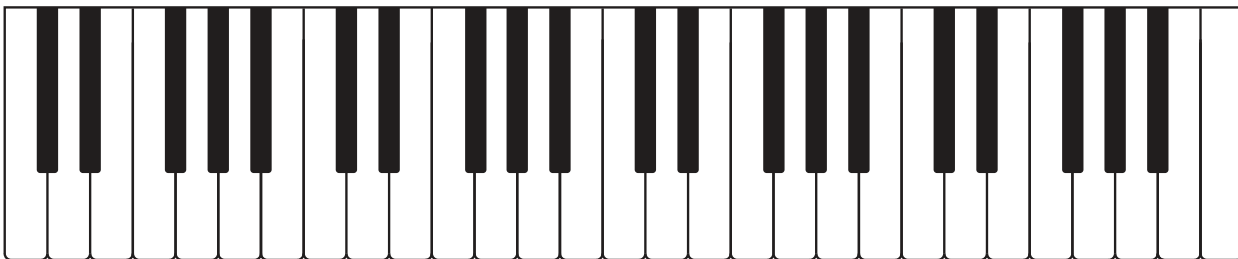

NOTE: By using the Mults and Attenuators found in the Utilities modules, multiple parameters can be affected - in varying amounts - using the Keyboard Pitch, Velocity and Aftertouch control signals.

■ LEFT-HAND CONTROLLER

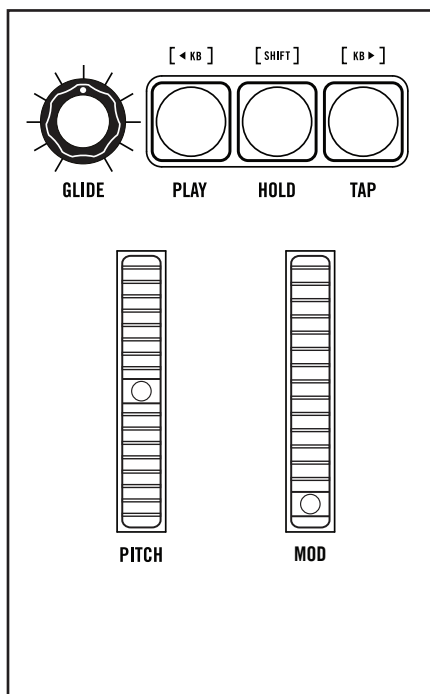

The Left-Hand Controller (LHC) is home to a number of performance-enriching controls. The **PITCH** (Pitch Bend) and **MOD** (Modulation) wheels deliver real-time expression, while the **GLIDE** knob provides enhanced articulation between notes. The Left-Hand Controller is also home to the Transport Buttons for the Arpeggiator and Sequencer, allowing instant access to these powerful features during performance.

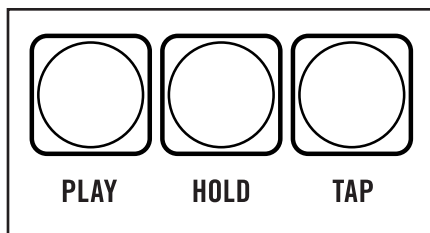

TRANSPORT BUTTONS

PLAY

The red **PLAY** button acts as a toggle, either arming or disarming the Arpeggiator or Sequencer. When this button is lit, pressing the notes to be arpeggiated, or the starting note of a sequence, will begin playback. This button will remain lit when the Sequencer or Arpeggiator is armed.

HOLD

The red **HOLD** button acts as a latch for the Arpeggiator and the Sequencer, where notes played and released remain held until new notes are played. This button will remain lit as long as the Hold function is engaged.

TAP

The playback tempo of the Arpeggiator or Sequencer can be set using a series of successive taps on this red **TAP** button. Once a Tempo has been entered using the **TAP** button, it will remain lit red. To exit Tap Tempo, simply press and hold the **TAP** button until its light goes out.

***TIP:** As long as the **TAP** button is lit red (indicating a tempo has been entered using this method), turning the **RATE** knob in the **ARP / SEQ** module will select clock divisions of this tempo.*

***NOTE:** More specific information regarding these buttons can be found in the **ARP / SEQ** chapter of this manual located on Page 49.*

LEFT-HAND CONTROLLER *(Continued)*

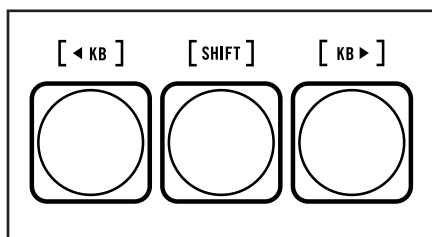

OCTAVE TRANSPOSE

The Transport Buttons can also be used to shift the pitch of the keyboard up or down in one-octave increments. This allows the range of the keyboard to be extended without changing the settings of individual oscillators. To transpose the keyboard by octave units, simply press and hold the **[SHIFT]** button, and then press the **[◀KB]** button (down one octave) or **[KB▶]** button (up one octave). The transpose range is up or down two octaves.

NOTE: Press the **HOLD**, **PLAY**, and **TAP** buttons at the same time to reset Matriarch to its default octave. Press and hold these same three buttons for one second to utilize the MIDI Panic function and silence any stuck notes.

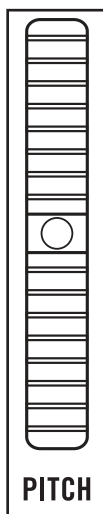

PITCH

The **PITCH** wheel (Pitch Bend) provides an intuitive method for quickly bending the pitch of the oscillators up or down during live performance.

NOTE: The **PITCH** wheel is spring-loaded and will return to center position as soon as it is released.



MOD

The **MOD** wheel (Modulation) provides an expressive way to introduce and control modulation while performing. At minimum position, no modulation is applied. As the **MOD** wheel's position is raised, more modulation is introduced. At its uppermost position, the amount of modulation is equal to the maximum values set using the **PITCH AMT** (Oscillator Pitch), **CUTOFF AMT** (Filter Cutoff Frequency), and **PULSE WIDTH AMT** (Pulse Width Modulation [PWM]) knobs in the Modulation module.

NOTE: Unlike the **PITCH** wheel, the **MOD** wheel is not spring-loaded, and will remain in position until it is moved again.

TIP: You can patch from the **MOD WHL OUT** jack on the Matriarch rear panel to any available destination for a more expressive and expansive performance.

LEFT-HAND CONTROLLER *(Continued)*

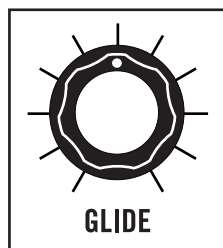

GLIDE

Glide produces a smooth, continuous change in pitch when transitioning from one note to the next. The **GLIDE** knob sets the amount of time needed to complete this transition. When the **GLIDE** knob is set to minimum, there is no Glide effect. Raising the value of the **GLIDE** knob will increase the Glide time between notes from zero to a maximum value of roughly ten seconds.

TIP: Legato Glide only produces the Glide effect when a new note is played while the previous note is still held down on the keyboard. To turn Legato Glide On, continue to press the **[SHIFT]** button while turning the **GLIDE** knob to the right. To turn Legato Glide Off, continue to press the **[SHIFT]** button while turning the **GLIDE** knob to the left. The Default setting for Legato Glide is Off.

■ OSCILLATORS

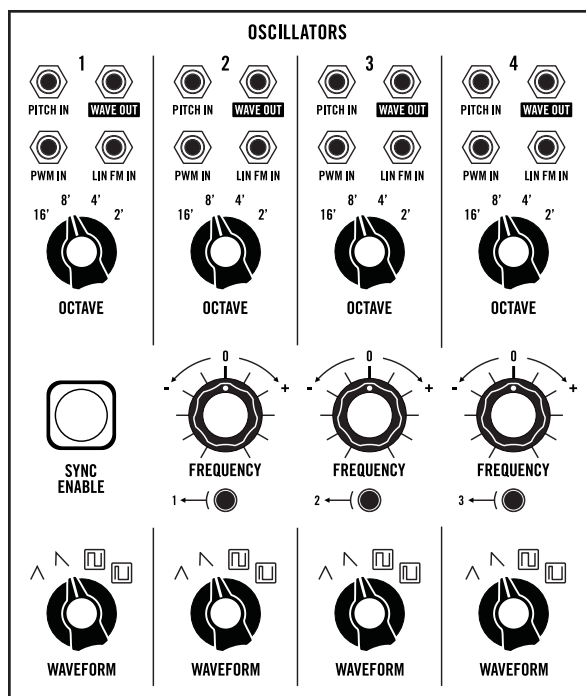

Matriarch's analog sound begins with four voltage-controlled oscillators (VCOs) of nearly identical design. Each oscillator provides individual control of the Octave and Waveform settings, while Oscillators 2, 3, and 4 also feature a **FREQUENCY** knob used for detuning from Oscillator 1.

Oscillators can be tuned in unison or set to differing intervals, octaves, and waveforms to create a vast expanse of monophonic and paraphonic sounds.

Oscillators 2, 3, and 4 can also be Hard Sync'd to the previous oscillator using the dedicated **SYNC** buttons – Oscillator 2 can be sync'd to Oscillator 1, Oscillator 3 to Oscillator 2, and Oscillator 4 to Oscillator 3.

NOTE: There is a **FINE TUNE** knob located on Matriarch's rear panel for adjusting the overall tuning of the instrument.

MODULE PROVENANCE: Matriarch's Oscillators are based on those found in the Minimoog Voyager and are descendants of the classic Moog 921 Oscillator design.

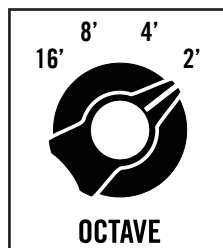

OCTAVE

This four-position switch is used to select the fundamental octave setting for each oscillator. The choices are 16', 8', 4' and 2'.

NOTE: These octave numbers originated as lengths (or footages) in the days of pipe organs.

OSCILLATORS *(Continued)*

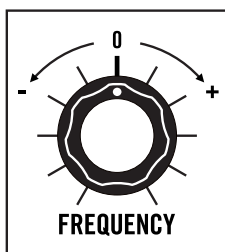

FREQUENCY (Oscillators 2, 3, & 4)

The **FREQUENCY** knob detunes each oscillator from the pitch of Oscillator 1 over a range of +/- 7 semitones (or a musical 5th). The center position (12 O'clock) tunes the oscillator in unison with Oscillator 1. Increasing the value (+) raises the pitch, while decreasing the value (-) lowers the pitch.

NOTE: The range of the **FREQUENCY** knobs can be specified in the Global Settings.

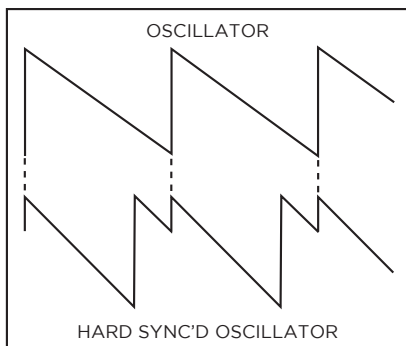

UNDERSTANDING OSCILLATOR SYNC

When two oscillators are sync'd, the first oscillator behaves normally, while the phase of the second, or sync'd oscillator, is forced to reset its cycle to match each new cycle of the first oscillator. This synchronization causes the waveform of the sync'd oscillator to take on a more complex wave shape as it works to stay aligned with the first oscillator. Sync is useful for creating sharp, metallic, and flange-like sounds, while also ensuring that the pitch of the sync'd oscillator stays locked to the pitch of the first oscillator.

TIP: Applying modulation to the pitch of a sync'd oscillator is a great way to enhance the sound of the Sync effect.

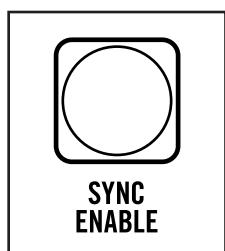

SYNC ENABLE (Main)

Pressing the main red **SYNC ENABLE** button enables the Sync functions of Oscillator 2, Oscillator 3, and Oscillator 4. The button will remain lit as long as the Sync function is On. Press the red **SYNC ENABLE** button a second time to turn the Sync function Off.

NOTE: When the frequency of the sync'd oscillator is set below that of the oscillator it is sync'd to, the sync'd oscillator will not be able to complete a full cycle before it is forced to reset, resulting in little or no sound.

INDIVIDUAL OSCILLATOR SYNC (Oscillators 2, 3, & 4)

Oscillators 2, 3, and 4 are each equipped with a dedicated button that allows it to be sync'd to the previous oscillator.

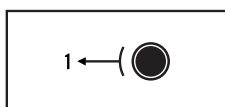

1 ← 2 SYNC

Pressing this button (On/lit red) will cause Oscillator 2 to become sync'd to Oscillator 1. In this case, changing the Frequency of Oscillator 2 will vary the degree of the Sync effect and its associated harmonic content. The range of the **FREQUENCY** knob is also greatly increased while the oscillator is sync'd.

OSCILLATORS *(Continued)*

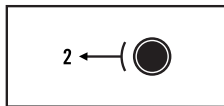

2 ← 3 SYNC

Pressing this button (On/lit red) will cause Oscillator 3 to become sync'd to Oscillator 2. In this case, changing the Frequency of Oscillator 3 will vary the degree of the Sync effect and its associated harmonic content. The range of the **FREQUENCY** knob is also greatly increased while the oscillator is sync'd.

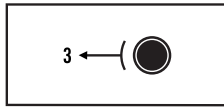

3 ← 4 SYNC

Pressing this button (On/lit red) will cause Oscillator 4 to become sync'd to Oscillator 3. In this case, changing the Frequency of Oscillator 4 will vary the degree of the Sync effect and its associated harmonic content. The range of the **FREQUENCY** knob is also greatly increased while the oscillator is sync'd.

NOTE: Remember, the main red **SYNC** button must be On (lit) for the individual Oscillator Sync functions to work.

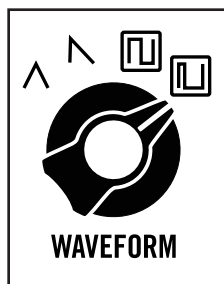

WAVEFORM (Triangle, Sawtooth, Square, Pulse)

Each waveform has unique harmonic content that is based on the number and strength of the harmonic overtones that it contains. These overtones are what impart a particular timbre, or character, to the sound of each oscillator. This four-position knob is used to select the oscillator's waveform. The choices are Triangle, Sawtooth, Square, and Narrow Pulse.

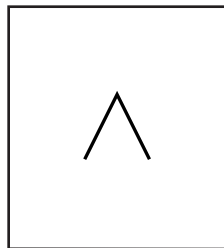

TRIANGLE

The Triangle wave has an extremely strong fundamental, and contains only odd-numbered harmonics at very low levels. This makes the Triangle wave an ideal choice for creating soft, flute-like sounds that have a relatively pure tone with little overtone activity.

TIP: Try mixing a Triangle wave from one oscillator with a more complex wave from another to emphasize one particular harmonic without adding unwanted overtones.

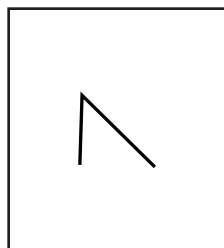

SAWTOOTH

The Sawtooth wave is the most harmonically dense of the four waveform options, containing all of the natural harmonics in relatively strong levels. In addition to creating thick, brassy sounds, the Sawtooth wave lends itself to powerful lead and bass sounds as well.

PULSE WAVES (Square & Narrow Pulse)

A Pulse wave contains only odd-numbered harmonics. Think of it as a switch that is being turned off and on hundreds or thousands of times per second. Pulse width, or duty cycle, is the percentage of time that the wave is "on." Every pulse width has its own unique harmonic structure, making a variety of basic timbres possible.

OSCILLATORS *(Continued)*

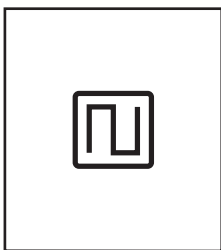

SQUARE

A Square wave is simply a Pulse wave with a 50% duty cycle, meaning that in a single cycle, it is on half of the time and off half of the time. If the frequency is 440 Hz, it turns on and off 440 times every second. Square waves have a hollow sound and provide a rich starting point for clarinet and bass sounds.

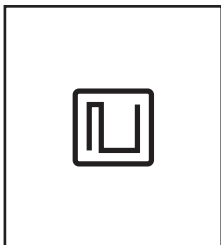

NARROW PULSE

As a Pulse wave continues to grow narrower, the resulting timbre takes on a more reedy, or nasal tone and is used to make oboe and even classic “clav” sounds.

TIP: Varying the duty cycle of the Pulse wave can result in a wide variety of lush or chorus-like sounds. With at least one oscillator set to produce a Pulse wave, try experimenting with the **PULSE WIDTH AMT** knob in the Modulation module and listen to how modulating this waveform affects the sound.

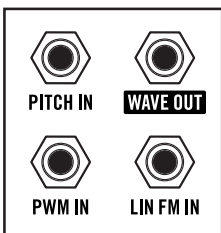

OSCILLATOR PATCH POINTS

Each Matriarch oscillator is equipped with versatile patch points, allowing for a variety of modulation possibilities, including Linear FM (Frequency Modulation) and PWM (Pulse Width Modulation).

NOTE: The patch points for each oscillator are identical.



PITCH IN (Exponential Frequency Modulation)

A control signal connected to this input will modulate the Pitch (Frequency) of a patched oscillator and all subsequent oscillators, unless a subsequent oscillator is also receiving a modulation signal via its own **PITCH IN** jack. This input voltage is added to the voltage from the note played on the keyboard.

NOTE: Connecting a modulation source to the **PITCH** input on Oscillator 1 will affect the Pitch of Oscillators 1, 2, 3, and 4. Connecting an additional modulation source to the **PITCH** input of Oscillator 2 will affect the Pitch of Oscillators 2, 3 and 4, and will prevent the modulation signal arriving at the Oscillator 1 **PITCH** input jack from modulating these oscillators.

TIP: By connecting a modulation source to the Oscillator 1 **PITCH IN** jack, and a “dead patch” to the Oscillator 2 **PITCH IN** jack, only Oscillator 1 will receive the modulation signal. A dead patch is a cable connected to a patch point with no connection on the opposite end, used to interrupt normalized signal paths.

CV INPUT: -5V to +5V Control Voltage (1V/Oct)

OSCILLATORS *(Continued)*



LIN FM IN (Linear Frequency Modulation)

Connecting an audio signal or high-frequency control signal to this input introduces Linear Frequency Modulation (FM) to a patched oscillator, which can be useful in creating brash, metallic, or bell-like tones.

CV INPUT: -5V to +5V Control Voltage (AC coupled)

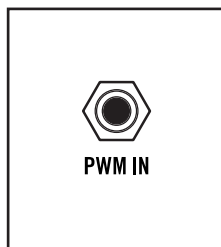

PWM IN

A control signal connected to this input will modulate the pulse width of the Square or Narrow Pulse waveform selected by a patched oscillator. Pulse Width Modulation (PWM) varies the duty cycle, or pulse width of a wave, and thereby changes its harmonic content. Among other things, PWM is often used to mimic the sound of ensemble strings and to thicken bass sounds.

CV INPUT: -5V to +5V

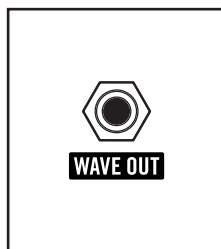

WAVE OUT

The audio signal available at this output is determined by the settings of the **OCTAVE**, **FREQUENCY**, **SYNC** and **WAVEFORM** knobs of a patched oscillator.

CV / AUDIO OUTPUT: 10V peak-to-peak

■ MIXER

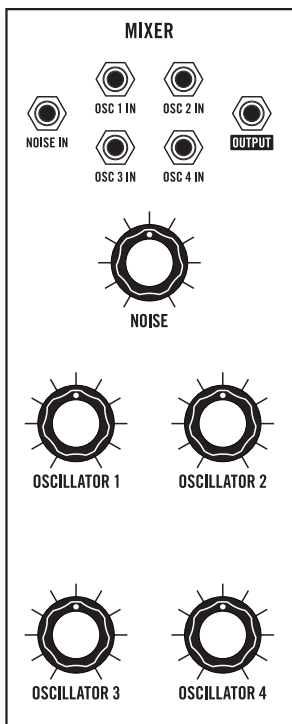

The Mixer is where all of the sound sources within Matriarch are blended together before being passed on to the Filter. Patch points in the Mixer allow each hardwired source (Oscillators 1 - 4 and Noise) to be replaced with an external audio signal. There is also a line-level Instrument Input on Matriarch's rear panel that feeds directly to the Mixer.

MODULE PROVENANCE: *Matriarch's Mixer is based on the classic Moog CP3 module.*

MIXER *(Continued)*

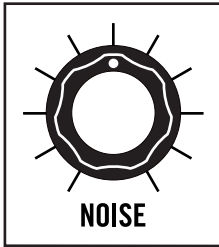

NOISE

Matriarch features a built-in White Noise generator. Noise is an unpitched sound source that can be a useful tool for creating powerful percussion sounds, or for adding a gentle breath to synthesized wind instruments such as flutes. The **NOISE** knob sets the level of the White Noise generator as it enters the Mixer. Settings above 11 O'clock will impart gentle distortion, while higher settings will result in more overdriven sounds.

NOTE: A High Pass Filter (HPF) can be applied to the noise signal using the Global Settings on page 63, allowing the color (or harmonic strength per frequency band) to be adjusted.

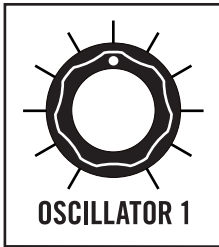

OSCILLATOR 1

The **OSCILLATOR 1** knob sets the level of Oscillator 1 as it enters the Mixer. Settings above 11 O'clock will impart gentle distortion, while higher settings will result in more overdriven tones.



OSCILLATOR 2

The **OSCILLATOR 2** knob sets the level of Oscillator 2 as it enters the Mixer. Settings above 11 O'clock will impart gentle distortion, while higher settings will result in more overdriven tones.



OSCILLATOR 3

The **OSCILLATOR 3** knob sets the level of Oscillator 3 as it enters the Mixer. Settings above 11 O'clock will impart gentle distortion, while higher settings will result in more overdriven tones.

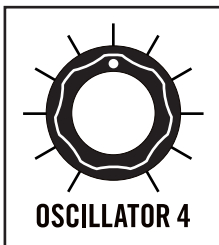

OSCILLATOR 4

The **OSCILLATOR 4** knob sets the level of Oscillator 4 as it enters the Mixer. Settings above 11 O'clock will impart gentle distortion, while higher settings will result in more overdriven tones.

MIXER (Continued)

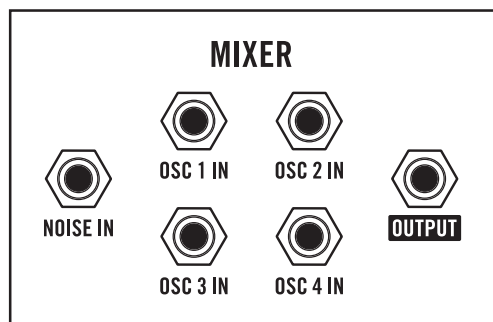

MIXER PATCH POINTS

These Mixer module patch points provide a convenient way to replace any or all of the internal sound sources entering the Mixer with an external sound source, such as a Eurorack oscillator or other electronic music devices.

TIP: Matriarch's Mixer is DC coupled, which means it can also be used to sum multiple control voltages. Combining audio signals with control signals will yield results that can be unique, bizarre, or completely undesirable.

PERFORMANCE NOTE: Mix gates are located on Oscillator channels 1-4. When in 2-Note or 4-Note Paraphonic mode, external sources will be dynamically muted just as the onboard oscillators would.

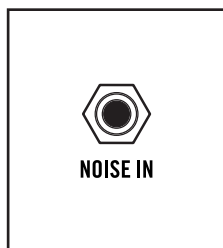

NOISE IN

When an external audio source is patched to this input, the Noise generator will be removed from the signal path, and the **NOISE** knob will control the level of the new source.

AUDIO INPUT: -5V to +5V (10V peak-to-peak)

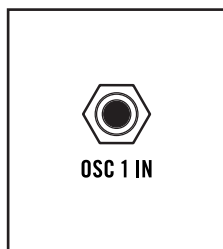

OSC 1 IN

When an external audio source is patched to this input, Oscillator 1 will be removed from the signal path, and the **OSCILLATOR 1** knob will control the level of the new source.

AUDIO INPUT: -5V to +5V (10V peak-to-peak)



OSC 2 IN

When an external audio source is patched to this input, Oscillator 2 will be removed from the signal path, and the **OSCILLATOR 2** knob will control the level of the new source.

AUDIO INPUT: -5V to +5V (10V peak-to-peak)



OSC 3 IN

When an external audio source is patched to this input, Oscillator 3 will be removed from the signal path, and the **OSCILLATOR 3** knob will control the level of the new source.

AUDIO INPUT: -5V to +5V (10V peak-to-peak)

MIXER (Continued)

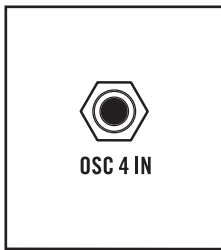

OSC 4 IN

When an external audio source is patched to this input, Oscillator 4 will be removed from the signal path, and the **OSCILLATOR 4** knob will control the level of the new source.

AUDIO INPUT: -5V to +5V (10V peak-to-peak)

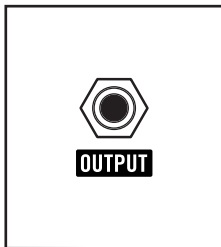

OUTPUT

The combined signal of all audio sources connected to the Mixer is available at this output.

AUDIO OUTPUT: 10V peak-to-peak

■ FILTERS

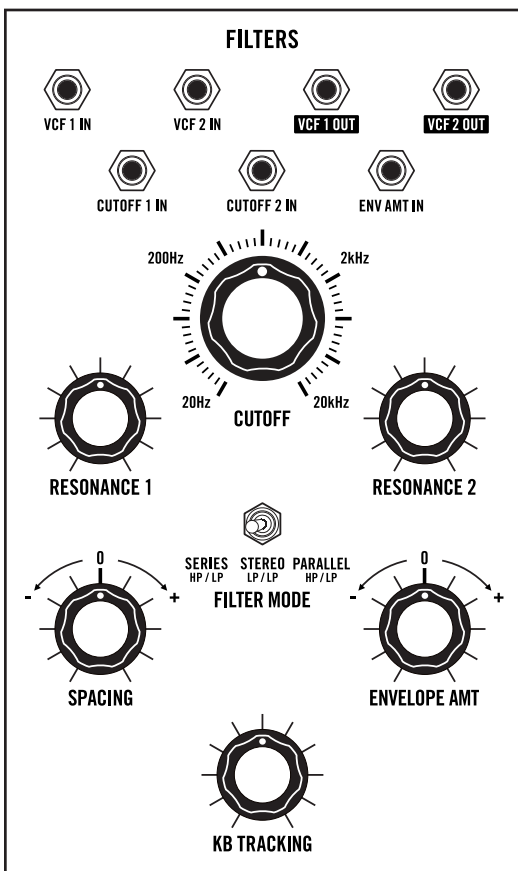

Filters are paramount in shaping the tone of your sound. While an oscillator's waveform determines the harmonic content of a raw wave, it is the filter that allows that harmonic content to be shaped, sculpted, and modulated over time to create something truly unique.

Matriarch's filters operate in one of three selectable modes; Series, Parallel, or Stereo. Depending on the current setting of the **FILTER MODE** switch, VCF 1 has the ability to operate in either High Pass or Low Pass mode, while VCF 2 maintains its Low Pass operation at all times.

NOTE: A stereo signal path is available from the filters onward.

MODULE PROVENANCE: Matriarch's filters are based on the classic Moog 904A module.

FILTERS (Continued)

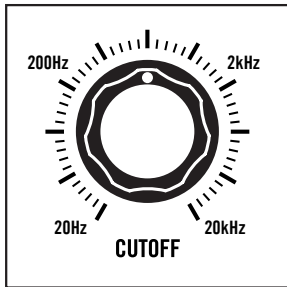

CUTOFF

Matriarch's **CUTOFF** knob specifies the Filter Cutoff frequency for both VCF 1 and VCF 2 in a linked fashion. The **SPACING** knob is used to offset the frequency of VCF 1, above or below the Cutoff Frequency of VCF 2.

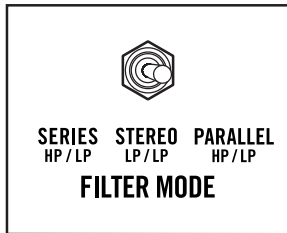

FILTER MODE

This three-position switch defines how VCF 1 and VCF 2 are configured, and how they will interact with each other.

HP / LP SERIES

In this mode, VCF 1 is configured as a High Pass filter and VCF 2 is configured as Low Pass filter. Signal passes from the Mixer module into VCF 1 (High Pass), and then is routed into VCF 2 (Low Pass). The mono output signal from VCF 2 feeds both VCA 1 and VCA 2.

NOTE: This is the foundation for creating a Band Pass filter.

LP / LP STEREO

In this mode, VCF 1 and VCF 2 function independently as Low Pass filters. Both receive the same signal from the Mixer module. VCF 1 is routed to VCA 1, and VCF 2 is routed to VCA 2. This creates a true-stereo signal path to the outputs.

HP / LP PARALLEL

In this mode, VCF 1 is configured as a High Pass filter and VCF 2 is configured as a Low Pass filter. Both receive the same signal from the Mixer module, and their outputs are combined into a monaural signal that feeds both VCA 1 and VCA 2.

NOTE: This is the foundation for creating a Notch filter.

REFERENCE: To see Filter Mode Signal Flow diagrams see Page 72-73.

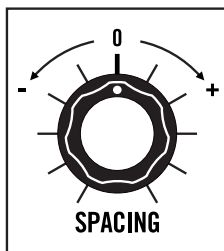

SPACING

Both VCF 1 and VCF 2 share the same Cutoff frequency value as determined by the **CUTOFF** knob. This **SPACING** knob specifies an offset in the value of the Cutoff frequency of VCF 1 in relation to the Cutoff frequency of VCF 2. This knob is bipolar; so turning this knob clockwise from center (+) increases the Cutoff frequency of VCF 1 to a value above that of VCF 2. Turning this knob counterclockwise (-) decreases the Cutoff frequency of VCF 1 to a value below that of VCF 2. In the center position, the Cutoff frequency of VCF 1 is equal to the Cutoff frequency of VCF 2.

NOTE: The **SPACING** knob only affects the Cutoff Frequency of VCF 1.

FILTERS *(Continued)*

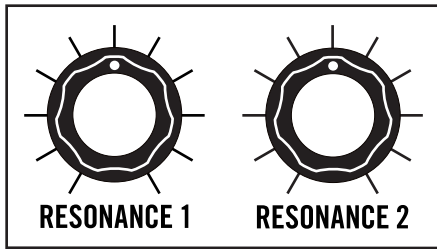

RESONANCE 1 & 2

Resonance channels a portion of the Filter's output back to the input of the Filter, creating an emphasis peak at the Filter's Cutoff frequency. This is useful for adding focus, funkiness, or "sci-fi laser blasts" to a sound.

The **RESONANCE 1** knob sets the amount of Resonance being applied to VCF 1, while the **RESONANCE 2** knob sets the amount of Resonance being applied to VCF 2.

NOTE: A **RESONANCE** knob setting of around 3 O'clock or more will cause the filter to self-oscillate.

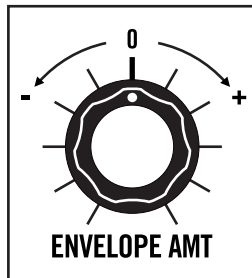

ENVELOPE AMT (Envelope Amount)

The **ENVELOPE AMT** knob determines how much of the control signal created by the Filter Envelope will be applied to the Filter's Cutoff frequency over time. This knob is bipolar, so turning the **ENVELOPE AMT** knob clockwise from center will raise the Filter's Cutoff frequency from the **CUTOFF** knob's current setting. Turning it counterclockwise from center will lower the Filter's Cutoff frequency from the **CUTOFF** knob's current setting.

NOTE: Negative (or inverse) modulation simply flips the shape of the Filter Envelope generator. Instead of the Attack parameter raising the Cutoff frequency over time, the Attack parameter will lower the Cutoff frequency by the same amount, in the same period of time.

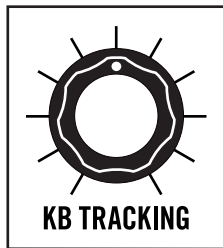

KB TRACKING (Keyboard Tracking)

Keyboard Tracking allows the note being played on the keyboard itself to be used as a modulation source for the Filter's Cutoff frequency. Higher notes on the keyboard may be perceived as being brighter than lower notes – especially when the filter is in the Low Pass mode.

When the **KB TRACKING** knob is set to its maximum value (fully clockwise), the Filter will track the keyboard using the same 1 volt/octave scheme as the oscillators. At its minimum value (fully counterclockwise), the **KB TRACKING** knob will have no effect.

TIP: Setting the **RESONANCE** and **KB TRACKING** knobs to maximum allows the keyboard to play the Filter(s) similarly to an oscillator.

FILTERS *(Continued)*

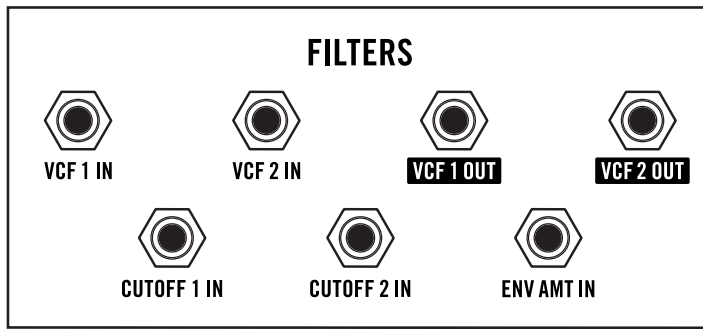

FILTER PATCH POINTS

These Filter module patch points provide a convenient way to independently modulate the Cutoff frequency of VCF 1 and/or VCF 2, and to modulate the value of the **ENVELOPE AMT** knob. In addition, audio inputs and outputs allow each filter to be used as a stand-alone processor for filtering any internal or external sound source.

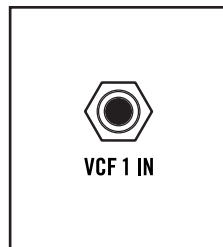

VCF 1 IN

The input to VCF 1 is connected to the output of the Mixer module. Patching an audio signal to this input overrides the Mixer signal, allowing any audio source to be processed by VCF 1.

NOTE: The path and mode of VCF 1 are determined by the **FILTER MODE** switch.

AUDIO INPUT: -5V to +5V

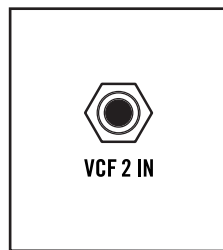

VCF 2 IN

The input of VCF 2 is connected to the output of the Mixer or VCF 1, depending on the position of the **FILTER MODE** switch. Patching an audio signal to this input overrides this signal, allowing any audio source to be processed by VCF 2 using the filter's current settings.

AUDIO INPUT: -5V to +5V

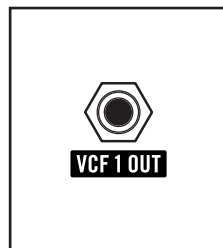

VCF 1 OUT

The audio output of VCF 1 is available via this jack, allowing it to be sent to any input on Matriarch itself, or to an external electronic music device.

AUDIO OUTPUT: 10V peak-to-peak

NOTE: VCF 1 can be used as a stand-alone audio processor.

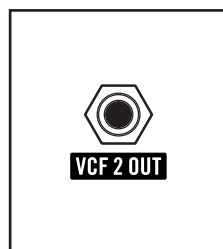

VCF 2 OUT

The audio output of VCF 2 is available via this jack, allowing it to be sent to any input on Matriarch itself, or to an external electronic music device.

AUDIO OUTPUT: 10V peak-to-peak

NOTE: VCF 2 can be used as a stand-alone audio processor.

FILTERS *(Continued)*

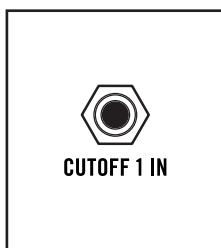

CUTOFF 1 IN

A control signal connected here will modulate the Cutoff frequency of VCF 1. This is based on the current **CUTOFF**, **SPACING**, **ENVELOPE AMT**, and **KB TRACKING** knob settings.

CV INPUT: -5V to +5V

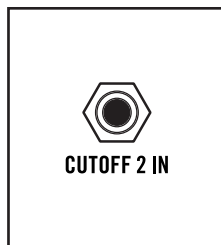

CUTOFF 2 IN

A control signal connected here will modulate the Cutoff frequency of VCF 2. This is based on the current **CUTOFF**, **ENVELOPE AMT**, and **KB TRACKING** knob settings.

CV INPUT: -5V to +5V

NOTE: A control signal arriving at the **CUTOFF 1 IN** jack is normalised to the **CUTOFF 2 IN** jack and will affect the Cutoff frequency of both VCF 1 and VCF 2. A control signal connected to the **CUTOFF 2 IN** jack will affect only the Cutoff frequency of VCF 2.

TIP: Connecting a modulation source to the **CUTOFF 1 IN** jack, and a "dead patch" to the **CUTOFF 2 IN** jack will prevent the modulation signal from reaching VCF 2. A dead patch is a cable connected to a patch point with no connection on the opposite end, used to interrupt normalized signal paths.

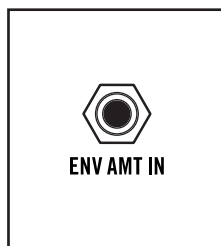

ENV AMT IN

A control signal connected here will modulate the value of the **ENVELOPE AMT** knob, thereby changing how much influence the Filter Envelope has over the Filter Cutoff frequency.

CV INPUT: -5V to +5V

■ ENVELOPE GENERATORS (ADSR)

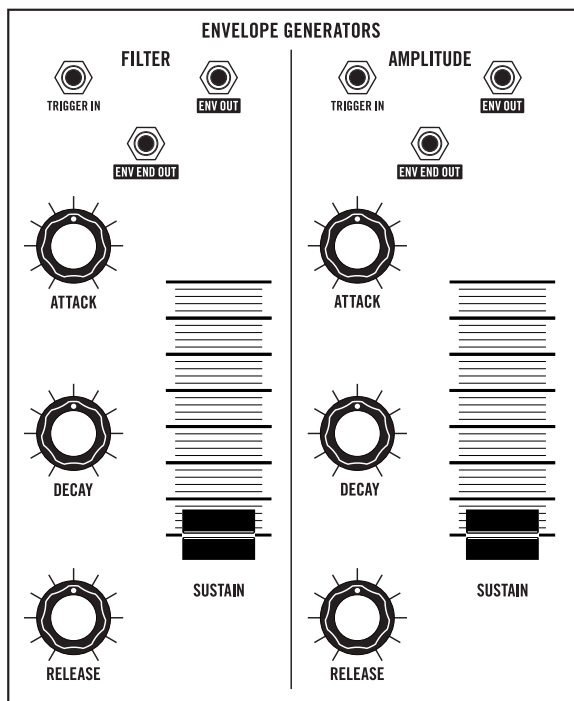

Sounds change over time. How they change over time is part of what makes each one unique. Some sounds begin abruptly, like the strike of a drum. Some sounds end just as quickly, and some linger like a held chord on a piano. We call this the envelope of a sound. Matriarch uses a pair of identical Envelope Generators to create control voltages that also change over time. This type of control voltage can be applied to the amplitude of the sound, changing its volume over time. This same type of control voltage can also be used to affect the Cutoff frequency of the Filter over time, creating changes in timbre, or tone.

NOTE: In a semi-modular synthesizer such as Matriarch, an Envelope Generator can be patched to modulate any controllable parameter over time.

MODULE PROVENANCE: Matriarch's Envelope Generators are based on the classic Moog 911 module.

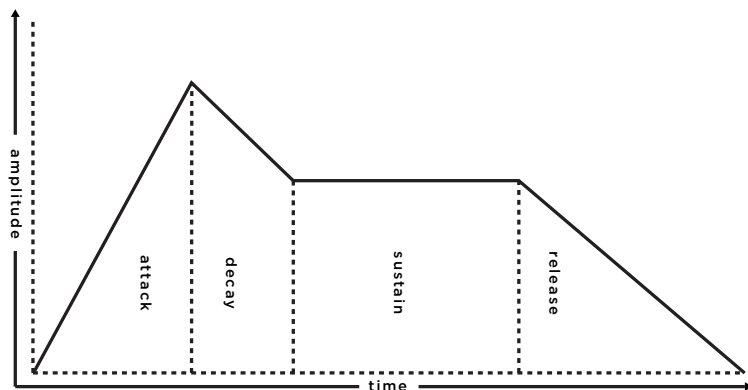

Regardless of how the Envelope is applied, there are four main stages: Attack time, Decay time, Sustain level, and Release time. These controls are identical for both Envelope Generators.

Of these four stages, three relate to time, and are controlled by rotary knobs. Only the Sustain stage relates to level; it is controlled using a slider.

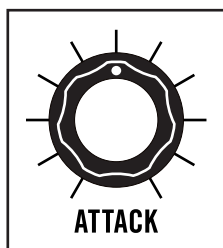

ATTACK

The **ATTACK** knob determines the amount of time required for the control signal to rise from zero to its maximum level once a key is pressed. The **ATTACK** knob has a range from 2 milliseconds to 10 seconds. Fast attacks are useful for creating plucked sounds, while slow attacks are more useful for creating bowed string sounds and swells. Brass swells will often have a faster Amplitude Attack and a slower Filter Attack.

ENVELOPE GENERATORS (ADSR) *(Continued)*



DECAY

The **DECAY** knob determines the amount of time required for the control signal to fall from the maximum level achieved by the Attack stage to the Sustain level as the key is held. The **DECAY** knob has a range from 2 milliseconds to 10 seconds. Fast decay times are useful for creating articulated lead notes, while longer decay times allow a note to fade slowly into the Sustain level.

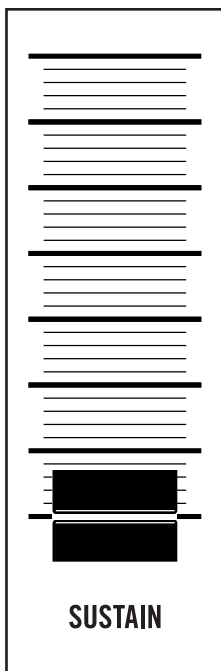

SUSTAIN

While the Attack, Decay, and Release parameters deal with time, the Sustain parameter controls level. Once the Attack and Decay stages are complete, the control signal will remain at the level set by the **SUSTAIN** slider, keeping the Amplitude and/or Filter at a steady level for as long as a key is held.



RELEASE

The **RELEASE** knob determines the amount of time required for the control signal to fall from its current level to zero once a key is released. The **RELEASE** knob has a range from 2 milliseconds to 10 seconds. Shorter settings are good for classic funk basses that end abruptly, while longer settings are good for creating smooth musical tails that ring out over time.

ENVELOPE GENERATORS (ADSR) *(Continued)*

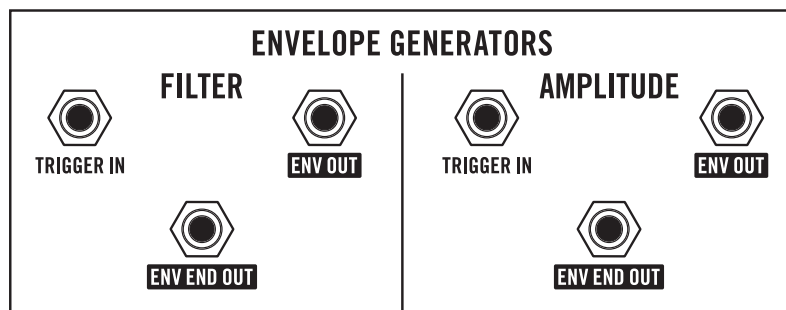

ENVELOPE GENERATOR PATCH POINTS

These patch points allow each Envelope Generator to be triggered from a source other than the Matriarch keyboard and can be used to modulate any patchable parameter internal to or external of Matriarch.

FILTER ENVELOPE GENERATOR

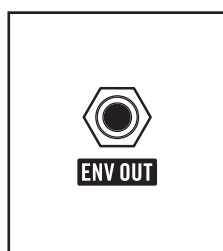

ENV OUT (Filter EG)

This output provides a control-voltage signal created by the current Filter Envelope Generator panel settings.

OUTPUT: 0V to +8V

NOTE: When the **VCA MODE** switch is set to **SPLIT**, the Filter Envelope Generator control signal also controls the level of VCA 1 (Left output).

TIP: An inverted EG signal (-ENV) can be created by patching from this **+ENV OUT** jack to an **INPUT** jack on one of three inverting Attenuators located in a Utilities module. Then, set the **ATTENUATOR** knob to its minimum position, and patch from the **OUTPUT** jack to the desired destination.

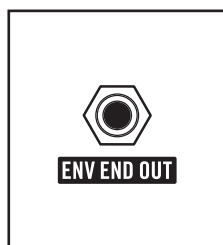

ENV END OUT (Filter EG)

Once the Filter Envelope Generator has run its course and returned to its lowest level, a Gate signal is created and continuously output via this jack until a new envelope cycle is initiated via a keyboard or trigger input. This Gate signal can be used to initiate another event, such as advancing a sequence to the next step.

TIP: Patch from the **ENV END OUT** jack to the **TRIGGER IN** jack on a single Envelope to create a looping envelope. Shorter Attack and Release settings will yield more rhythmic results.

CV OUTPUT: 0V to +5V

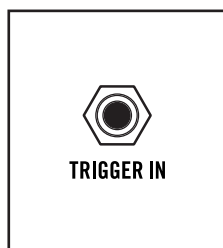

TRIGGER IN (Filter EG)

Normally, the Filter Envelope Generator is initiated by pressing a key on the keyboard. A Gate or Control Voltage > 2.3V connected to this input can be used to initiate the Filter Envelope Generator as well.

NOTE: Patching into the **TRIGGER IN** jack will override Matriarch's Keyboard Gate connection to the EG.

CV / GATE INPUT: 0V to +8V

ENVELOPE GENERATORS (ADSR) *(Continued)*

AMPLITUDE ENVELOPE GENERATOR



ENV OUT (Amplitude EG)

This output provides a control-voltage signal created by the current Amplitude Envelope Generator panel settings.

CV OUTPUT: 0V to +8V

NOTE: When the **VCA MODE** switch is set to **AMP ENV**, this signal controls the level of both VCA 1 and VCA 2. When the Output module **VCA MODE** switch is set to **SPLIT**, the Filter Envelope Generator signal controls the level of VCA 1 (Left output), and the Amplitude Envelope Generator signal controls the level of VCA 2 (Right output).

TIP: An inverted EG signal (-ENV) can be created by patching from this **+ENV OUT** jack to an **INPUT** jack on one of three inverting Attenuators located in a Utilities module. Then set the **ATTENUATOR** knob to its minimum (fully counterclockwise) position, and patch from the **OUTPUT** jack to the desired destination.

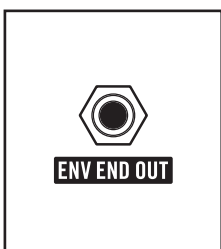

ENV END OUT (Amplitude EG)

Once the Amplitude Envelope Generator has run its course and returned to its lowest level, a Gate signal is created and continuously output via this jack until a new envelope cycle is initiated via a keyboard or trigger input. This Gate signal can be used to initiate another event, such as advancing a sequence to the next step.

TIP: Patch from the **ENV END OUT** jack to the **TRIGGER IN** jack on a single Envelope to create a looping envelope. Using shorter Attack and Release settings will yield more rhythmical results.

GATE OUTPUT: 0V to +8V

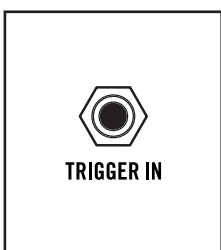

TRIGGER IN (Amplitude EG)

Normally, the Amplitude Envelope Generator is initiated by pressing a key on the keyboard. A Gate or Control Voltage > 2.3V connected to this input can be used to initiate the Amplitude Envelope Generator as well.

NOTE: Patching into the **TRIGGER IN** jack will override Matriarch's Keyboard Gate connection to the EG.

CV/GATE INPUT: 0V to +8V

■ OUTPUT

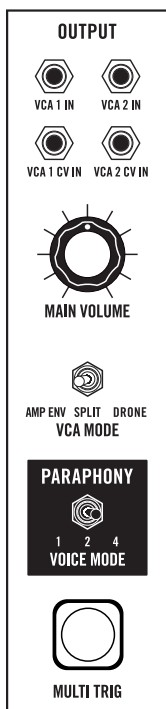

Matriarch is equipped with two Voltage-Controlled Amplifiers, VCA 1 and VCA 2. Before the sounds created by Matriarch can be output and monitored through speakers or recorded, they pass through a pair of VCAs and are brought to an appropriate level. The Output module controls will determine how the final sound is heard. By default, VCA 1 controls the Left channel output level and VCA 2 controls the Right channel output level.

MODULE PROVENANCE: Matriarch's output VCAs are based on the classic Moog 902 module.



MAIN VOLUME

The **MAIN VOLUME** knob sets the level for the **LEFT (MONO) OUT** and **RIGHT OUT** outputs jack (located in the Audio section on Matriarch's rear panel).

NOTE: The **EURORACK** and **HEADPHONE** output jacks on the rear panel are unaffected by the front panel **MAIN VOLUME** knob settings.

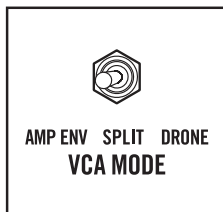

VCA MODE (Envelope, Split, Drone)

The **VCA MODE** switch determines which control signals - if any - are changing the output level of each VCA.

AMP ENV

In the **AMP ENV** position, the output level of both VCA 1 and VCA 2 will be controlled by the Amplifier Envelope Generator.

SPLIT

In the **SPLIT** position, the output level of VCA 1 is controlled by the Filter Envelope Generator, and the output level of VCA 2 is controlled by the Amplifier Envelope Generator.

DRONE

In the **DRONE** position, the output levels of the VCAs are unaffected by either EG. Instead, the output level is set by a default voltage normalled to the **VCA 1 CV IN** and **VCA 2 CV IN** patch points.

NOTE: Matriarch will continue to drone at this level, whether a key is held or not.

OUTPUT *(Continued)*

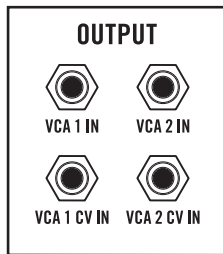

VCA PATCH POINTS

All of the VCA patch points are inputs. The upper row (**VCA 1 IN** and **VCA 2 IN**) are audio inputs, while the second row (**VCA 1 CV IN** and **VCA 2 CV IN**) are control signal inputs. Audio and control signals connected here will override, or replace, any normalised connections.

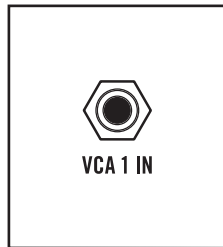

VCA 1 IN

The audio signal normally connected to the input of VCA 1 comes from the Filter module. The exact nature of the audio source is determined by the **FILTER MODE** switch located in the Filter module. Patching an audio signal to this input overrides the Filter signal, allowing any audio source to be processed by VCA 1 using the current settings.

AUDIO INPUT: -5V to +5V

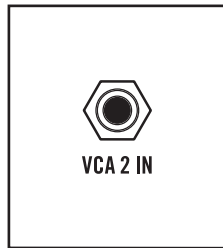

VCA 2 IN

The audio signal normally connected to the input of VCA 2 comes from the Filter module. The exact nature of the audio source is determined by the **FILTER MODE** switch located in the Filter module. Patching an audio signal to this input overrides the Filter signal, allowing any audio source to be processed by VCA 2 using the current settings.

AUDIO INPUT: -5V to +5V

NOTE: The normal input source of VCA 1 and VCA 2 is determined by the **FILTER MODE** switch. With this switch in the **HP / LP SERIES** position, the output of VCF 1 feeds into VCF 2, and the composite output of VCF 2 is sent to the input of both VCA 1 and VCA 2. In the **LP / LP STEREO** position, the output of VCF 1 is sent to the input of VCA 1, and the output of VCF 2 is sent to the input of VCA 2. In the **HP / LP PARALLEL** position, the summed output of VCF 1 and VCF 2 is sent to the input of both VCA 1 and VCA 2.

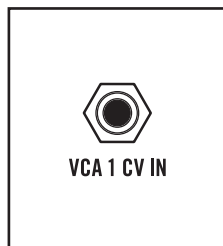

VCA 1 CV IN

A control signal connected here will determine the output level of VCA 1. Normally, this control signal comes from one of the Envelope Generators, as determined by the setting of the **VCA MODE** switch.

With the **VCA MODE** switch set to **ENV** or **SPLIT**, this jack can accept an -8V to +8V signal that will control the level of sound prior to its arrival at VCA 1. In either setting, applying an LFO to this input can be used to create a tremolo effect.

With the **VCA MODE** switch set to **DRONE**, a control signal (0V to +8V) applied here will set the level of VCA 1 from minimum (0V) to maximum (+8V) level.

CV INPUT: -8V to +8V (**VCA MODE** switch set to **ENV** or **SPLIT**); 0V to +8V (**VCA MODE** switch set to **DRONE**)

OUTPUT *(Continued)*

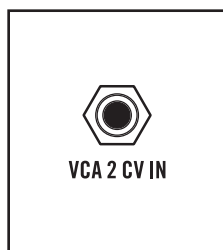

VCA 2 CV IN

A control signal connected here will determine the output level of VCA 2. Normally, this control signal comes from the Amplitude Envelope Generator.

With the **VCA MODE** switch set to **ENV** or **SPLIT**, this jack can accept an -8V to +8V signal that will control the level of the signal at the input of VCA 2. In either setting, applying an LFO to this input can be used to create a tremolo effect.

With the **VCA MODE** switch set to **DRONE**, a control signal (0V to +8V) applied here will set the level of VCA 2 from minimum (0V) to maximum (+8V) level.

CV INPUT: -8V to +8V (**VCA MODE** switch set to **ENV** or **SPLIT**); 0V to +8V (**VCA MODE** switch set to **DRONE**)

PARAPHONY

Information regarding paraphonic functionality and multi-triggering can be found on **Page 50-51**.

■ STEREO DELAY

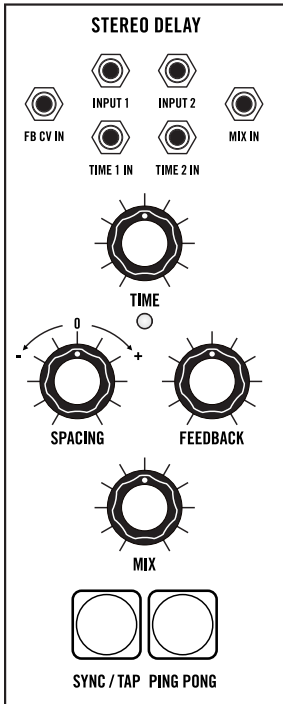

The Stereo Delay is, in fact, two individual BBD-based analog delays that share certain parameters. In the Matriarch signal path, the Stereo Delay is positioned after VCA 1 and VCA 2, and before the **MAIN AUDIO** outputs.

MODULE PROVENANCE: Matriarch's Stereo Delay module is based on the Moog 500 Series Analog Delay module.

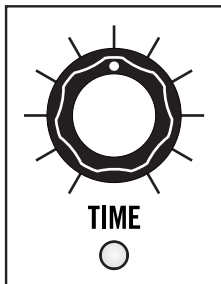

TIME

This parameter sets the initial delay time for both Delay 1 and Delay 2. The range is from 35 milliseconds with the **TIME** knob rotated fully counterclockwise, to 780 milliseconds with the **TIME** knob rotated fully clockwise. The LED indicator below the **TIME** knob will flash at the current Time setting.

TIP: Utilizing Tap Tempo or through patching, much longer Delay Times can be achieved. This will result in noisy or “lo-fi” delay trails that may or may not be desirable.

NOTE: When Matriarch is sync'd to an internal or external clock, rotating the **TIME** knob will adjust the delay time in divisions or multiplications of the clock rate (BPM).

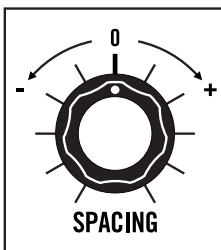

SPACING

The **SPACING** knob creates an offset in the delay time of Delay 1 relative to Delay 2. This knob is bipolar, so in the center position the timing of Delay 1 and Delay 2 remain the same. Turning this knob clockwise from center increases (+) the delay time of Delay 1 relative to Delay 2. Turning this knob counterclockwise from center decreases (-) the delay time of Delay 1 relative to Delay 2.

NOTE: When Matriarch is sync'd to an external clock, rotating the **SPACING** knob will adjust the delay time of Delay 1 in divisions or multiplications of the clock rate (BPM).

NOTE: If the **TIME** knob is already at its highest level, raising the value of the **SPACING** knob may have little effect.

STEREO DELAY *(Continued)*

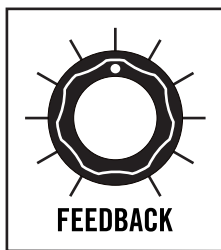

FEEDBACK

Feedback routes a portion of the Stereo Delay's output back to its input, to build multiple repeats and a cascade of delay trails. Feedback is variable from single to infinite repeats, and everything in between.

NOTE: **FEEDBACK** knob settings above approximately 2 O'clock will cause the Stereo Delay to self-oscillate, which may or may not be desirable.

TIP: Setting the **FEEDBACK** knob at the brink of self-oscillation creates a musically expansive wash of sound.

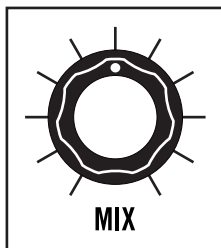

MIX

The balance between the output of the VCAs and the output of the Stereo Delay is controlled by the **MIX** knob, acting as a crossfader between the two signals before the combined signal is sent to Matriarch's many audio outputs. In the fully counterclockwise position, there is no Stereo Delay signal present in the **MAIN OUTPUTS**. In the fully clockwise position, only the output of the Stereo Delay module is heard.

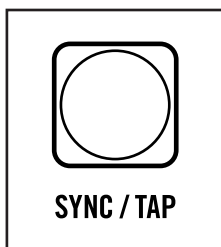

SYNC / TAP

This button has two functions, or modes of operation: **SYNC** and **TAP**.

SYNC

Press and release the red **SYNC / TAP** button to enter **SYNC** mode. When On (lit red), the delay time of the Stereo Delay module will be synchronized to an external or internal (ARP / SEQ) clock signal. While in the **SYNC** mode, the red **SYNC / TAP** button will remain lit, and the LED indicator below the **TIME** knob will switch from red to green if sync'd to the Arp / Sequencer master clock, or yellow if sync'd to an external analog signal. To exit **SYNC** mode, press and release the **SYNC / TAP** button a second time. The **SYNC / TAP** button will go dark, and the LED indicator below the **TIME** knob will return to red.

TAP

The **TAP** mode (or Tap Tempo mode) allows the delay time to be set by feel using a few button taps at the desired rate. To enter **TAP** mode, press and hold the **SYNC / TAP** button until it is lit, and release it. Then, tap the **SYNC / TAP** button three or more times in a row at a relatively consistent rate to establish a new tempo. The **SYNC / TAP** button will flash at the same tempo, while the red LED indicator below the **TIME** knob will flash at the current clock division rate. The tempo can be modified at any time by tapping the **SYNC / TAP** button a minimum of three times at the new tempo. To exit **TAP** mode, press and hold the **SYNC / TAP** button until it goes dark.

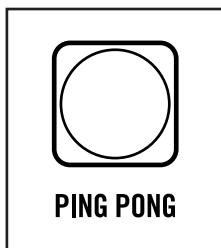

PING PONG

Pressing the red **PING PONG** button sets the Stereo Delay into Ping Pong mode, which causes the delayed signal to alternate between the Left and Right output channels, so long as Feedback is being applied. The **PING PONG** button will remain lit (red) while the Delay module is in Ping Pong mode.

NOTE: Technically, the output of Delay 1 is fed to the input of Delay 2, and the output of Delay 2 is fed back to the input of Delay 1, etc.

STEREO DELAY *(Continued)*

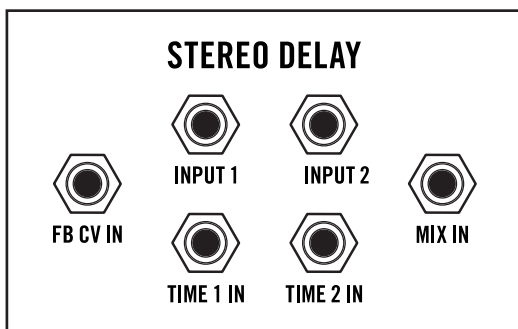

STEREO DELAY PATCH POINTS

The Stereo Delay module features both Audio and Control signal inputs. The Audio inputs override and replace the normal hardwired audio connections. The Control inputs are summed with the current value of their corresponding panel knobs.

NOTE: Additional Stereo Delay patch points are located on the rear panel.

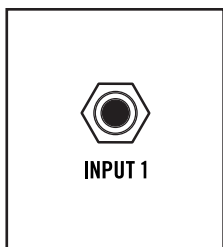

INPUT 1

Normally, the input to Delay 1 comes from VCA 1. An audio signal connected the **INPUT 1** jack replaces the VCA 1 signal, and will be processed by the first delay module (Delay 1). The output of Delay 1 will appear at the left channel of all associated outputs.

AUDIO INPUT: 10V peak-to-peak (-5V to +5V)

NOTE: The **MIX** knob controls the balance between the output of the VCAs and the output of the Stereo Delay module.

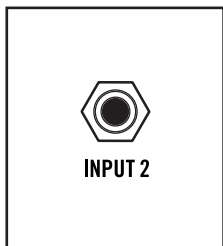

INPUT 2

Normally, the input to Delay 2 comes from VCA 2. An audio signal connected the **INPUT 2** jack replaces the VCA 2 signal, and will be processed by the second delay module (Delay 2). The output of Delay 2 will appear at the right channel of all associated outputs.

AUDIO INPUT: 10V peak-to-peak (-5V to +5V)

NOTE: The **MIX** knob controls the balance between the output of the VCAs and the output of the Stereo Delay module.



FB CV IN (Feedback Control Voltage Input)

The value of a Control signal connected to this input will be summed with the current position of the **FEEDBACK** knob to determine the amount of Feedback for Delay 1 and Delay 2.

CV INPUT: -5V to +5V

NOTE: A control signal connected to the **FB 2 CV IN** jack on the rear panel will control the Feedback amount of Delay 2 independently from Delay 1. In this case, a control signal connected to the **FB CV IN** jack on the front panel will only affect the Feedback amount of Delay 1.

TIP: Connecting a modulation source to the **FB CV IN** jack, and a "dead patch" to the **FB CV 2 IN** jack on the rear panel will prevent the modulation signal from reaching Delay 2. A dead patch is a cable connected to a patch point with no connection on the opposite end, used to interrupt normalized signal paths.

STEREO DELAY *(Continued)*



MIX IN

The value of a Control signal connected to this input will be summed with the current position of the **MIX** knob to determine the balance between the dry (unprocessed) audio signal, and the wet (processed) audio signal.

CV INPUT: -5V to +5V

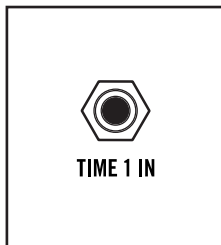

TIME 1 IN

A Control signal connected to this input will modulate the delay time of Delay 1, separate from the timing of Delay 2.

CV INPUT: -5V to +5V

NOTE: With **DELAY CV SYNC BEND** on, and Tap Tempo or Sync activated in the Delay module, a voltage applied to the **TIME 1 IN** and **TIME 2 IN** jacks will "bend" the Delay Time relative to the nominal sync'd tempo. This allows for smooth time modulation while sync'd, which creates some very interesting effects. With **DELAY CV SYNC BEND** off, and Tap Tempo or Sync engaged in the Stereo Delay Module, a control voltage applied to this input will cycle through clock divisions of the current tempo.

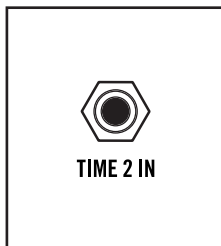

TIME 2 IN

A Control signal connected to this input will modulate the delay time of Delay 2.

CV INPUT: -5V to +5V

NOTE: With **DELAY CV SYNC BEND** on, and Tap Tempo or Sync activated in the Delay module, a voltage applied to the **TIME 1 IN** and **TIME 2 IN** jacks will "bend" the Delay Time relative to the nominal sync'd tempo. This allows for smooth time modulation while sync'd, which creates some very interesting effects. With **DELAY CV SYNC BEND** off, and Tap Tempo or Sync engaged in the Stereo Delay Module, a control voltage applied to this input will cycle through clock divisions of the current tempo.

MODULATION

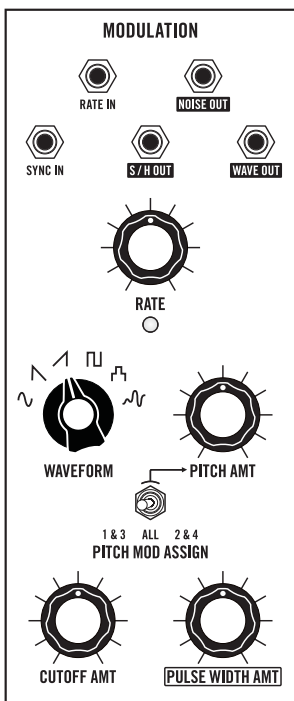

Modulation is a vital facet of synthesizer performance and sound design. In short, whenever one signal is used to change the value of another- it is known as modulation. Modulation can come from a number of sources- the Envelope Generators, Keyboard Tracking, an audio Oscillator (FM), or a dedicated Modulation oscillator such as the one found here. Based upon an analog oscillator that operates in the low-frequency range (Low Frequency Oscillator or LFO), the Modulation module can apply modulation to multiple destinations at once, and in varying amounts.

In addition to the hardwired modulation routings that can be addressed using the panel controls, Noise and S/H (Sample and Hold) are available as patchable modulation sources, as is the signal specified by the **WAVEFORM** and **RATE** knob settings.

NOTE: A second, simple LFO can be found in the Utilities 2 module.

NOTE: The **PITCH AMT**, **CUTOFF AMT**, and **PULSE WIDTH AMT** knobs are used to specify the maximum amount of modulation to be applied to specific parameters. In order to actually apply the modulation and hear the effect, the **MOD** wheel must be raised from its minimum position.

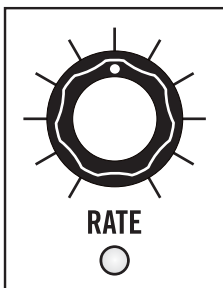

RATE

The Rate, or speed, of the Modulation oscillator can be set from .07 Hz to 1.3 kHz using the **RATE** knob. The LED indicator below this knob will flash at the current Rate setting.

TIP: Hold the **SHIFT** button while adjusting the Modulation **RATE** knob to fine-tune the Modulation rate.



WAVEFORM

This six-position knob is used to select the Waveform for the Modulation oscillator. The choices are Sine, Sawtooth, Ramp, Square, Staircase, and Smooth Random.

NOTE: The Staircase waveform is a stepped Triangle wave. While the Triangle wave itself is determined by the Modulation **RATE** knob, the stepped values are sampled and held with each rising pulse of the ARP / SEQ clock, as determined by the ARP / SEQ **RATE** knob.

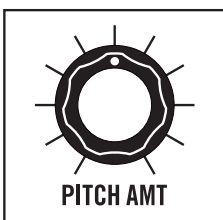

PITCH AMT (Amount)

Applying modulation to the pitch of an oscillator can create anything from a gentle vibrato to a vast cascade of notes. The **PITCH AMT** knob determines the maximum amount of modulation that will be applied to the Pitch of the selected oscillators when the **MOD** wheel is at its maximum position.

MODULATION *(Continued)*



PITCH MOD ASSIGN (1&3, All, 2&4)

Using this three-position switch, the amount of Pitch Modulation set using the **PITCH AMT** knob (above) can be assigned to all of the Matriarch oscillators, to Oscillators 1 & 3 only, or to Oscillators 2 & 4 only. The latter two options can be extremely useful in the 2-Note Paraphonic mode.

1&3

In this mode, modulation will be applied to the pitch of Oscillator 1 and Oscillator 3 only.

***TIP:** Applying modulation to Oscillators 1 and 3 only allows the other two oscillators (2 and 4) to remain firmly on pitch, preserving the tonality of the melody.*

ALL

In this mode, Modulation will be applied equally to the pitch of all Oscillators.

2&4

In this mode, Modulation will be applied to the pitch of Oscillator 2 and Oscillator 4 only.

***TIP:** The **2 & 4** selection allows two pairs of sync'd oscillators to be played in the 2-Voice Paraphonic mode. Oscillator 2 can be sync'd to Oscillator 1, and Oscillator 4 can be sync'd to Oscillator 3. Applying modulation will increase the depth of the Sync effects, without altering the pitch of Oscillator 1 and Oscillator 3.*

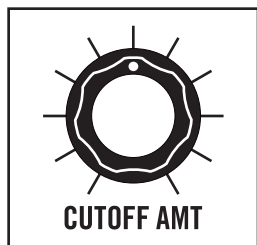

CUTOFF AMT (Amount)

The **CUTOFF AMT** knob determines the maximum amount of modulation that will be applied to the Cutoff frequency of the Filter when the **MOD** wheel is at its maximum position.

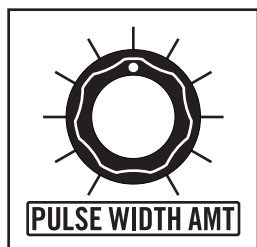

PULSE WIDTH AMT (Amount)

The **PULSE WIDTH AMT** knob determines the maximum amount of modulation that will be applied to the Pulse Width of the Square and Narrow Pulse waves in the Oscillators module when the **MOD** wheel is at its maximum position.

***NOTE:** Pulse Width Modulation (PWM) can only be applied to an oscillator when a Square or Narrow Pulse wave is selected as the current waveform. Pulse Width Modulation continuously varies the duty cycle, or pulse width, of these waves, causing the harmonic content to continuously vary as well.*

MODULATION *(Continued)*

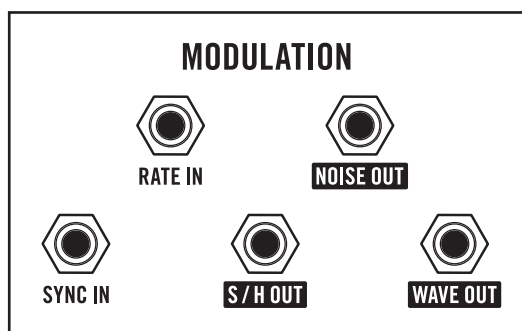

MODULATION PATCH POINTS

Control signals connected to the **RATE IN** and **SYNC IN** patch point jacks can set the rate and reset the starting point of the Modulation oscillator. In addition, three patch point output jacks deliver Noise, S/H (Sample and Hold), and the selected Wave as control sources that can be used to modulate any controllable parameter.



RATE IN

A control signal connected to the **RATE IN** jack will determine the frequency of the Modulation oscillator.

CV INPUT: -5V to +5V (1V/Oct)

TIP: Patch from the **KB OUT** jack on the rear panel to the **RATE IN** jack and adjust the **RATE** knob accordingly to allow the Modulation oscillator to be “played” like an oscillator.



SYNC IN

A gate or trigger signal received at the **SYNC IN** jack will reset the Modulation oscillator wave to its starting point, which allows for more predictable, syncopated or creative use of the Modulation oscillator.

CV INPUT: Rising signal > 2.5 Volts will create a reset trigger. (0V to +10V)

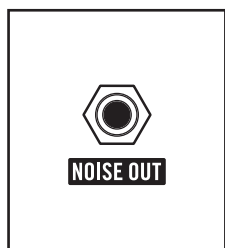

NOISE OUT

The output of the internal White Noise generator is available at the **NOISE OUT** jack, both as a modulation source, and as an audio signal.

CV/AUDIO OUTPUT: -8V to +8V

NOTE: A High Pass Filter (HPF) can be applied to the white noise signal using the Global Settings, allowing the low frequency harmonic content of the noise signal to be adjusted.



S/H OUT

Sample and Hold (S/H) is a stepped modulation effect, often used to “pulse” the Cutoff frequency of a Low Pass filter with random values. At the beginning of every modulation wave cycle, the Noise generator is sampled to acquire a random value that can be used to modulate another parameter. That stream of Sample and Hold values is available via this output.

CV OUTPUT: -8V to +8V

MODULATION *(Continued)*



S/H OUT *(Continued)*

TIP: A control or gate signal received at the **SYNC IN** jack will reset the Modulation oscillator to the beginning of its wave cycle, meaning the Sample and Hold feature can be stepped by an external trigger or gate. Try patching from the **GATE OUT** jack in the ARP / SEQ module to the **SYNC IN** jack, and set the **RATE** knob to its minimum value. This will allow you to use the keyboard to step through Sample and Hold values with each key press, or each new step of the Arpeggiator or Sequencer.

NOTE: There is no internal routing to use the Sample and Hold generator, so it must be patched from this jack to a specific destination in order for it to modulate another parameter.

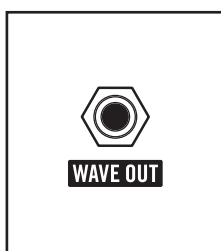

WAVE OUT

The signal available here, either as a modulation source or an audio source, is determined by the current value of the modulation **WAVEFORM** knob, the modulation **RATE** knob, and any other control signals connected to the modulation generator.

CV OUTPUT: 10V peak-to-peak (Select -5V to +5V)

■ UTILITIES (1)

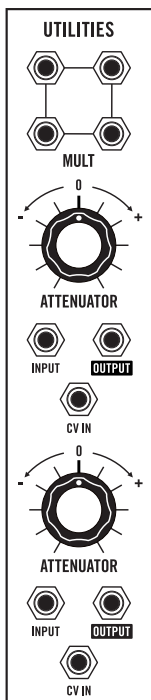

Matriarch is equipped with two Utilities modules. Each is filled with an assortment of tools that are key to the exploration of modular synthesis. A signal can be split and sent to multiple locations, multiple signals can be merged together, and individual signals can be attenuated and inverted.

This first Utilities module (1) includes a four-way **MULT** jack, and two identical inverting Attenuators.

TIP: Each Attenuator can also be used as a Ring Modulator, generating an output signal related mathematically to two input signals. Ring modulation is often used to create metallic and inharmonic sounds. Try patching from the **WAVE OUT** jack of Oscillator 1 to the Attenuator's **INPUT** jack, and from the **WAVE OUT** jack of Oscillator 2 to the same Attenuator's **CV IN** jack. The **OUTPUT** jack will provide a composite ring modulated signal. Rotate the **ATTENUATOR** knob to "tune" the ring modulation. This will change the offset value applied to the **CV IN** jack, changing the symmetry of the ring modulated signal. Set the **ATTENUATOR** knob to the 12 O'clock position for a clean, traditional ring mod sound.

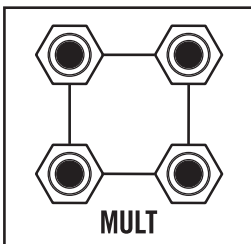

MULT (Unbuffered)

The Mult consists of four jacks wired together in parallel. Connecting an audio or control signal to one of the **MULT** jacks allows it to then be sent to three different locations. Additionally, Matriarch has been designed so that all of the audio and control signals available via the output patch points can be passively mixed using these **MULT** jacks. In this way, multiple modulation sources can be applied to a single modulation destination, for example.

MULT: Four jacks wired in parallel (Unbuffered)

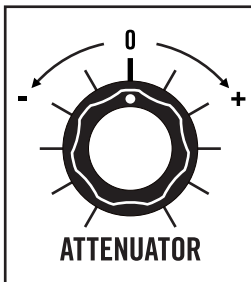

ATTENUATOR (Inverting)

An Attenuator can reduce the strength of a control signal to provide more accuracy when modulating the value of a specific parameter. Equipped with an **INPUT** jack and an **OUTPUT** jack, each Attenuator can also deliver both normal and inverted values. In the center position, the **ATTENUATOR** knob provides its full effect, and the signal arriving at the Attenuator **INPUT** jack is fully attenuated. Raising the value clockwise from center will provide less and less attenuation, until the full scale of the input signal is restored and passed through unaffected. Lowering the value counterclockwise from center will provide less and less attenuation of the inverted signal, until the full value of the inverted signal is restored at the full counterclockwise position.

NOTE: Negative (or inverse) modulation simply flips the control signal, so that any control signal previously raising the value of a parameter would now be lowering it.

UTILITIES (1) *(Continued)*

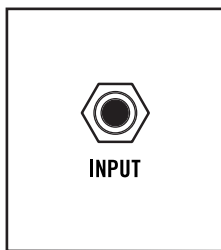

INPUT

Any audio or control signal connected to this jack will be fed into the Attenuator.

CV/AUDIO INPUT: -8V to +8V

NOTE: An 8-Volt DC source is normalled to the input of each Attenuator. With nothing connected to the **INPUT** jack, a voltage is present at the Attenuator's **OUTPUT** jack that is based on the position of the **ATTENUATOR** knob, and any control signal applied to the Attenuator **CV IN** jack.

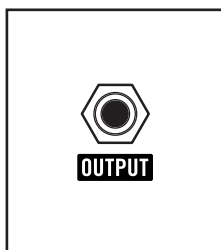

OUTPUT

This **OUTPUT** jack delivers the attenuated version of the signal connected to the Attenuator **INPUT** jack.

CV OUTPUT: -8V to +8V

NOTE: The Utilities (1) module contains two Attenuators that can act independently, or together in a cascade fashion. In most cases, you will want to patch in and out of each Attenuator separately. However, if no connection is made to the **OUTPUT** jack of Attenuator 1, the output of Attenuator 1 will be summed with the output of Attenuator 2, and a mixed signal of both outputs will be available via the Attenuator 2 **OUTPUT** jack. In this case, both Attenuators can be used together as a type of voltage-controlled bipolar mixer. Connecting a control signal to the **CV IN** jack of either Attenuator will act to control the balance of the mixed Attenuator 1 and Attenuator 2 signal available at the **OUTPUT** jack of Attenuator 2.

TIP: Each Attenuator input is normalled to an 8-Volt DC source. With no connections made to the **INPUT** jack and the **OUTPUT** jack of Attenuator 1, adjusting the **ATTENUATOR** knob of Attenuator 1 will affect the final output signal of Attenuator 2. Connecting a patch cable to the **OUTPUT** jack of Attenuator 1 will prevent the output of Attenuator 1 from reaching Attenuator 2.

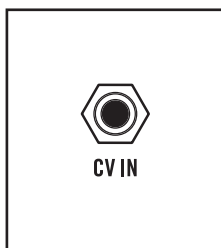

CV IN

A control signal received here is added to the value of the **ATTENUATOR** knob to determine the final amount of attenuation.

CV INPUT: -8V to +8V

■ UTILITIES (2)

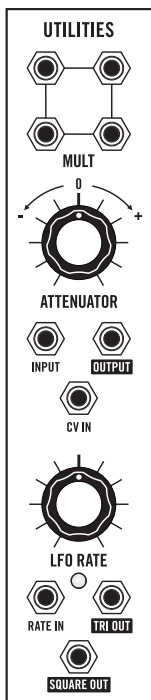

Matriarch is equipped with two Utilities modules. Each is filled with an assortment of tools that are key to the exploration of modular synthesis. A signal can be split and sent to multiple locations, multiple signals can be merged together, and individual signals can be attenuated and inverted.

This second Utilities module (2) includes a four-way **MULT** jack, one inverting Attenuator, and an auxiliary LFO (Low Frequency Oscillator) modulation source.

TIP: Each Attenuator can also be used as a Ring Modulator, generating an output signal related mathematically to two input signals. Ring modulation is often used to create metallic and inharmonic sounds. Try patching from the **WAVE OUT** jack of Oscillator 1 to the Attenuator's **INPUT** jack, and from the **WAVE OUT** jack of Oscillator 2 to the same Attenuator's **CV IN** jack. The **OUTPUT** jack will provide a composite ring modulated signal. Rotate the **ATTENUATOR** knob to "tune" the ring modulation. This will change the offset value applied to the **CV IN** jack, changing the symmetry of the ring modulated signal. Set the **ATTENUATOR** knob to the 12 O'clock position for a clean, traditional ring mod sound.

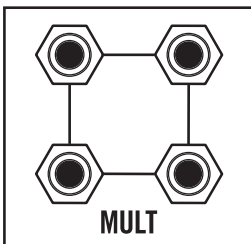

MULT (Unbuffered)

The Mult consists of four jacks wired together in parallel. Connecting an audio or control signal to one of the **MULT** jacks allows it to then be sent to three different locations. Additionally, Matriarch has been designed so that all of the audio and control signals available via the output patch points can be passively mixed using these **MULT** jacks. In this way, multiple modulation sources can be applied to a single modulation destination, for example.

MULT: Four jacks wired in parallel (Unbuffered)

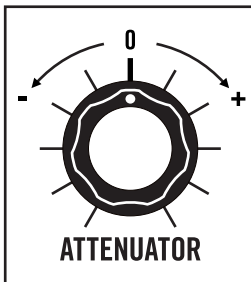

ATTENUATOR (Inverting)

An Attenuator can reduce the strength of a control signal to provide more accuracy when modulating the value of a specific parameter. Equipped with an **INPUT** jack and an **OUTPUT** jack, each Attenuator can also deliver both normal and inverted values. In the center position, the **ATTENUATOR** knob provides its full effect, and the signal arriving at the Attenuator **INPUT** jack is fully attenuated. Raising the value clockwise from center will provide less and less attenuation, until the full scale of the input signal is restored and passed through unaffected. Lowering the value counterclockwise from center will provide less and less attenuation of the inverted signal, until the full value of the inverted signal is restored at the full counterclockwise position.

NOTE: Negative (or inverse) modulation simply flips the control signal, so that any control signal previously raising the value of a parameter would now be lowering it.

UTILITIES (2) *(Continued)*

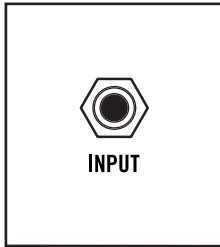

INPUT

Any audio or control signal connected to this jack will be fed into the Attenuator.

CV/AUDIO INPUT: -8V to +8V

NOTE: An 8-Volt DC source is normalled to the input of each Attenuator. With nothing connected to the **INPUT** jack, the voltage present at the Attenuator's **OUTPUT** jack is based on the position of the **ATTENUATOR** knob, and any control signal applied to the Attenuator **CV IN** jack.

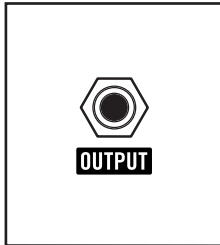

OUTPUT

This **OUTPUT** jack delivers the attenuated version of the signal connected to the Attenuator **INPUT** jack.

CV OUTPUT: -8V to +8V

NOTE: The Utilities (2) module contains one Attenuator. Two more Attenuators are available in the Utilities (1) module.

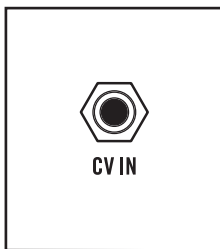

CV IN

A control signal received here is added to the value of the **ATTENUATOR** knob to determine the final amount of attenuation.

CV INPUT: -8V to +8V

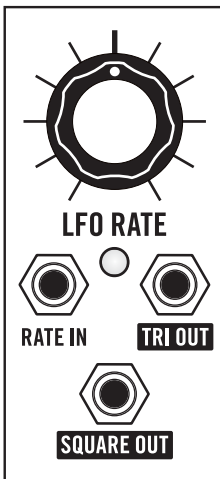

PATCHABLE LFO

This LFO (Low Frequency Oscillator) provides Matriarch with a patchable modulation source separate from the Modulation oscillator. Two waveforms, Triangle and Square, are available simultaneously, and the rate of the LFO can be modulated via control voltage.

RATE

The Rate, or speed, of the LFO can be set from .07 Hz to 520 Hz using the **RATE** knob. The LED indicator below this knob will flash at the current Rate setting.



RATE IN

A control signal connected to the **RATE IN** jack will be added to the value of the **LFO RATE** knob to determine the final LFO Rate.

CV INPUT: -8V to +8V

NOTE: Applying a control voltage to the **RATE IN** jack will allow the LFO to exceed the maximum 520 Hz available via the **LFO RATE** knob, and reach frequencies of up to approximately 620 Hz.

UTILITIES (2) *(Continued)*

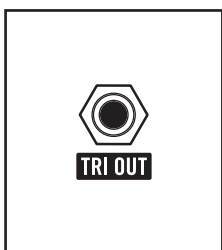

TRI OUT

The frequency of the Triangle wave available here, either as a modulation source or an audio source, is determined by the current value of the **LFO RATE** knob, plus or minus the value of any signal connected to the **RATE IN** jack.

CV OUTPUT: 10V peak-to-peak

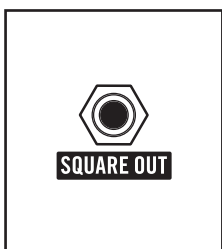

SQUARE OUT

The frequency of the Square wave available here, either as a modulation source or an audio source, is determined by the current value of the **LFO RATE** knob, plus or minus the value of any signal connected to the **RATE IN** jack.

CV OUTPUT: 10V peak-to-peak

■ ARP / SEQ

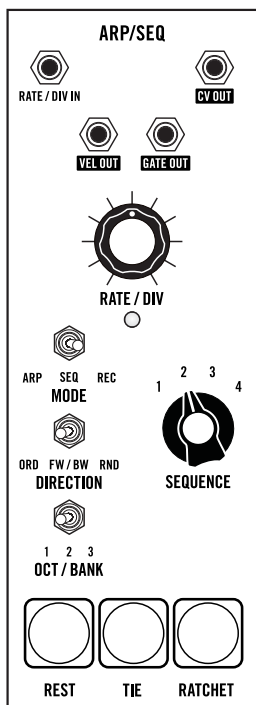

The Arpeggiator and multi-bank Sequencer are powerful tools for creation and live performance. In addition to the controls found in this module, the Arpeggiator and Sequencer also rely on the **PLAY**, **HOLD**, and **TAP** buttons located on the Left-Hand Controller panel. This module also contains the **CV OUT**, **VELOCITY OUT**, **GATE OUT**, and **ARP RATE / DIV IN** patch points.

ARPEGGIATOR

The Arpeggiator takes the notes being held on the keyboard, and plays them one at a time in a repeating, rhythmic pattern. This is useful for creating swooping cascades of notes, building a rhythmic base, or for generating new and fun musical ideas. Matriarch allows you to select the order in which the notes are played, and also provides the option of repeating the pattern in different octaves.

SEQUENCER

The step-style Sequencer can record, save and playback 12 unique sequences containing up to 256 steps per sequence. A step is comprised of up to four notes, and may also feature other musical additions, such as a Tie or Ratchets.

NOTE: Sequence memory is retained even when Matriarch is powered off.

ARP / SEQ (Continued)

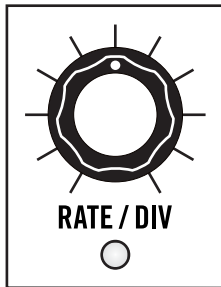

RATE

The **RATE** knob sets the playback speed of the Arpeggiator and the Sequencer, with a tempo range of 20 – 280 BPM (Beats Per Minute). The accompanying LED flashes at the current Rate setting. If Matriarch is sync'd to MIDI, External Clock, or Tap Tempo, the **RATE** knob will select timing values that are musical subdivisions of this external tempo.

TIP: The Rate of the Sequencer or Arpeggiator can also be set by pressing the **TAP** button a few times at the desired tempo. The red **TAP** button will remain lit, indicating that Matriarch is operating in Tap Tempo mode. To exit Tap Tempo mode, press and hold the **TAP** button for about one second, or until it goes dark.

NOTE: Pressing the **SHIFT** button while turning the **RATE** knob selects triplet note values.

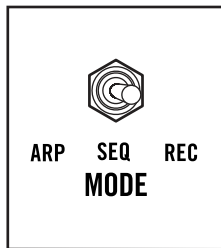

MODE

The **MODE** switch selects whether the Arpeggiator or the Sequencer is currently active. A third position places the Sequencer into Record mode.

ARP (Arpeggiator)

With the **MODE** switch in the **ARP** position, the Arpeggiator is active. Pressing the **PLAY** button on the Left-Hand Controller will arm the Arpeggiator, while pressing one or more notes will cause the Arpeggiator to begin playing.

SEQ (Sequencer)

With the **MODE** switch in the **SEQ** position, the Sequencer is active. Pressing the **PLAY** button on the Left-Hand Controller will arm the Sequencer, while pressing a note will cause the Sequencer to begin playing. The note pressed will also determine the key, or starting note of the sequenced pattern.

REC (Record)

With the **MODE** switch in the **REC** position, the Sequencer is armed for recording. Notes, Rests, Ties, and Ratchets can be entered into the current sequence.

WARNING: Sequences are automatically saved to the currently selected location. Shifting the **MODE** switch to **REC** with the Sequencer stopped, and entering a new Note or Rest will permanently overwrite the sequence previously saved to that location.

TIP: If the **MODE** switch is shifted to the **REC** position while the Sequencer is running, pressing a new note (Rest, Tie, etc.) will replace the previous data for that step, allowing a sequence to be updated in real time.

ARP / SEQ (Continued)



DIRECTION

The **DIRECTION** switch selects the order in which arpeggiated or sequenced notes are played. The same setting may have a different result based on whether the Arpeggiator or Sequencer is active.

ORD (Order) ARPEGGIATOR

Arpeggiated notes will play in the same order they were originally played on the keyboard.

SEQUENCER

Sequenced notes will play in the same order they were originally recorded.

FW / BW (Forward / Backward)

ARPEGGIATOR Mode

Arpeggiated notes will first play in the same order they were originally played on the keyboard from beginning to end. Those same notes will then be played in reverse order from end to beginning.

SEQUENCER Mode

Sequenced notes will first play in the same order they were originally recorded from beginning to end. Those same notes will then be played in reverse order from end to beginning.

***NOTE:** In the **FW / BW** position, the last note of the forward pattern will be played again as the first note of the backward pattern; the last note of the backward pattern will be played again as the first note of the forward pattern.*

RND (Random)

ARPEGGIATOR Mode

Arpeggiated notes will play back in random order.

SEQUENCER Mode

Sequenced notes will play back in random order.

***NOTE:** In the **RND** position, each sequence step is played as a random event, so steps with rests, ties, and ratchets may cause the sequence to play in an unexpected rhythmic pattern.*



OCT / BANK (Octave Range / Sequence Bank Select)

The setting of the **OCT / BANK** switch produces different results, depending on whether the Arpeggiator or the Sequencer has been selected. With the **MODE** switch set to the **ARP** position, the **OCT / BANK** switch specifies the number of octaves that will be used to play an arpeggiated pattern. With the **MODE** switch set to the **SEQ** or **REC** position, this switch specifies which of the three Banks of sequences is selected.

ARP / SEQ (Continued)



OCT / BANK (Continued)

1

ARPEGGIATOR Mode (1 Octave)

Only the original notes played will be arpeggiated.

SEQUENCER Mode (BANK 1)

BANK 1 is chosen as the sequence source.

2

ARPEGGIATOR Mode (2 Octave)

The arpeggiated pattern is played, and then repeated one octave higher than the original.

SEQUENCER Mode (Bank 2)

BANK 2 is chosen as the sequence source.

3

ARPEGGIATOR Mode (3 Octaves)

The arpeggiated pattern is played, then repeated one octave higher than the original, and then two octaves higher than the original.

SEQUENCER Mode (Bank 3)

BANK 3 is chosen as the sequence source.

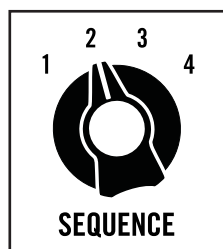

SEQUENCE

Matriarch provides a total of 12 sequence locations across three user-selectable Banks. This four-position **SEQUENCE** knob is used to select one of the four available sequences within the currently selected Bank as the active sequence.

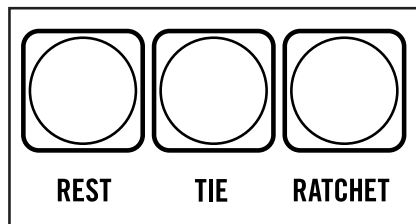

REST, TIE, RATCHET

When the **MODE** switch is set to the **REC** position, data may be entered into the currently selected sequence. Each sequence step can contain up to four notes played on the keyboard, a rest, a tie or ratchet(s), entered using these three buttons.

NOTE: The number of notes that can be entered into the Sequencer simultaneously per-step is determined by the **VOICE MODE** switch.

REST

Press the red **REST** button to enter a Rest for the current sequence step. A Rest is used to create a musical silence in place of a note for one or more steps in a sequence. The red **REST** button will stay lit until the next step is entered into the sequence. During playback, the **REST** button will light to indicate a rest step in the sequence.

(Continued on page 48)

ARP / SEQ *(Continued)*

REST, TIE, RATCHET *(Continued)*

TIE

Press the red **TIE** button to enter a Tie for the current sequence step. A Tie is used to string two or more individual sequence steps together as if they were played legato-style. The red **TIE** button will stay lit until the next step is entered into the sequence. During playback, the **TIE** button will light to indicate a tied step in the sequence.

NOTE: If the same note is tied together multiple times in a row, it will be heard during playback as if that one note is being held continuously. If different notes are tied together, the transition between notes will be heard as legato-style playing. This can be especially useful when using Legato Glide.

TIP: With the **VOICE MODE** switch set to **1** (mono mode), it is also possible to enter a Tie between notes directly from the keyboard. While recording, simply play a second note while still holding down the first note; the red **TIE** button will light, indicating a tie has been entered.

RATCHET

Press the red **RATCHET** button one or more times in a row to add Ratchets to the current sequence step. A Ratchet (sometimes referred to as note-repeat) allows a note to be played multiple times within a single sequence step. Up to eight Ratchets can be entered per sequence step. This is a powerful way to add rhythmic variation and complex timing to a sequence. During playback, the **RATCHET** button will light to indicate a Ratchet step in the sequence.

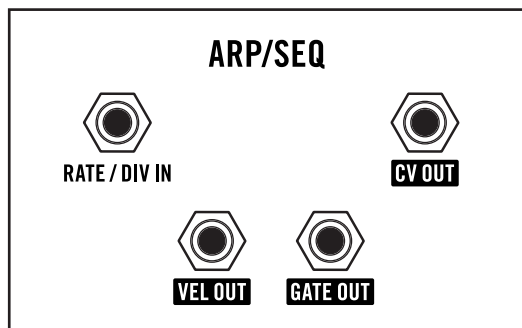

ARP / SEQ PATCH POINTS

The patch points located in the **ARP / SEQ** module relate to the note data played by the Arpeggiator and the Sequencer.

NOTE: Additional ARP / SEQ patch points are found on the rear panel.

NOTE: There are additional jacks for the Control Voltage, Gate, Velocity, and Aftertouch data generated by the Keyboard on the rear panel.

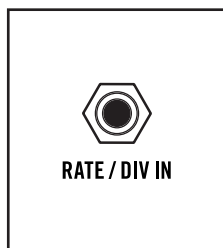

ARP RATE / DIV IN

A control signal received here modulates the value of the ARP / SEQ Rate based on the current position of the **RATE** knob.

NOTE: When sync'd, pressing the **SHIFT** button while turning the **RATE** knob selects triplet note values.

CV INPUT: -5V to +5V

ARP / SEQ *(Continued)*

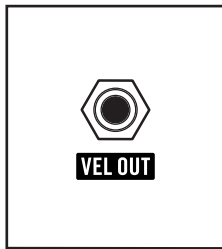

VELOCITY OUT

The control signal available at this output is based on the Velocity of the notes entered into the Arpeggiator or Sequencer with the keyboard.

CV OUTPUT: 0V to +5V (0V to +10V selectable via Global Settings)

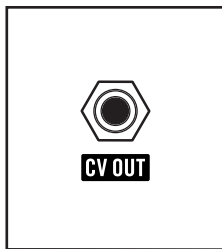

CV OUT

The control voltage available at this output jack is the same used to specify the pitch of the Oscillators being played by the Arpeggiator or Sequencer.

CV OUTPUT: -5V to +5V (0V to +10V selectable via Global Settings)

NOTE: *The Arpeggiator and Sequencer can be disconnected from the Oscillators in the Global Settings so that it can be patched independently from the keyboard.*

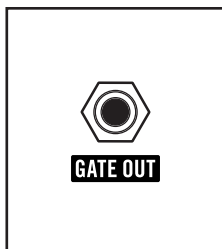

GATE OUT

During Arpeggiator or Sequencer playback, a Gate signal will be produced for the duration of each note, and available via this jack.

GATE OUTPUT: +5V (+10V selectable via Global Settings)

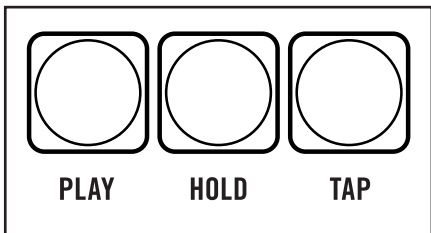

ARP / SEQ LHC CONTROLS

The Left-Hand Controller is where you will find additional controls related to the Arpeggiator and Sequencer.

PLAY

The red **PLAY** button acts as a toggle to arm and disarm the playback of the Arpeggiator or Sequencer. This button will remain lit when the Sequencer or Arpeggiator is armed. Press the notes to be arpeggiated, or the starting note of the sequence to begin playback.

HOLD

The red **HOLD** button acts as a latch for the Arpeggiator or Sequencer. This button will remain lit as long as the Hold function is engaged. When the **HOLD** button is engaged (lit), the arpeggiated or sequenced pattern will continue to play, even after your hand is lifted from the keyboard. In the Arpeggiator mode, notes played while other notes are being held on the keyboard will be added to an arpeggiated pattern. Notes played after all fingers have been lifted from the keyboard will begin a new pattern. In the Sequencer mode, playing a note on the keyboard still specifies the root note, or key, of the sequenced pattern.

ARP / SEQ (Continued)

TAP

Using the red **TAP** button, the playback tempo of the Arpeggiator or Sequencer can be entered using a series of successive button taps. Once a Tempo has been entered using the **TAP** button, this button will remain lit.

As long as the red **TAP** button is lit (indicating a tempo has been entered using this method), turning the **RATE** knob in the ARP / SEQ module will select note-value clock divisions of this tempo. Pressing the **SHIFT** button while turning the **RATE** knob selects Triplet and Dotted note values.

NOTE: If an external clock is detected and in use, the tap-tempo operation will have no effect.

■ PARAPHONY

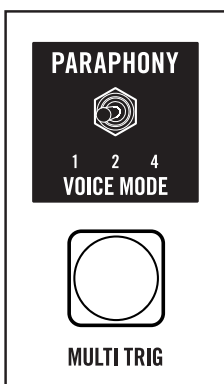

PARAPHONY

The **VOICE MODE** switch and the **MULTI TRIG** (Multiple Trigger) button determine the behavior of the Matriarch sound engine when more than one key is played on the keyboard at the same time. Matriarch can be played as a monophonic, 2-note paraphonic, or 4-note paraphonic analog instrument. Each mode has its own advantages.

ABOUT PARAPHONY

When we speak of a monophonic synthesizer, we think of an instrument with the ability to play one note at a time; when we speak of a polyphonic synthesizer, we think of an instrument capable of playing multiple notes simultaneously. Paraphonic synthesizers fall somewhere in between, allowing the pitch of each oscillator to be played independently, but with all oscillators then sharing a common signal path from the Mixer section and beyond (VCF, VCA, etc.), just as on a monophonic synthesizer.

NOTE: Each Oscillator includes a dedicated pre-mixer Gate that is triggered with each new note press, allowing the output of an oscillator to be muted when not in use.

PARAPHONIC SIGNAL FLOW

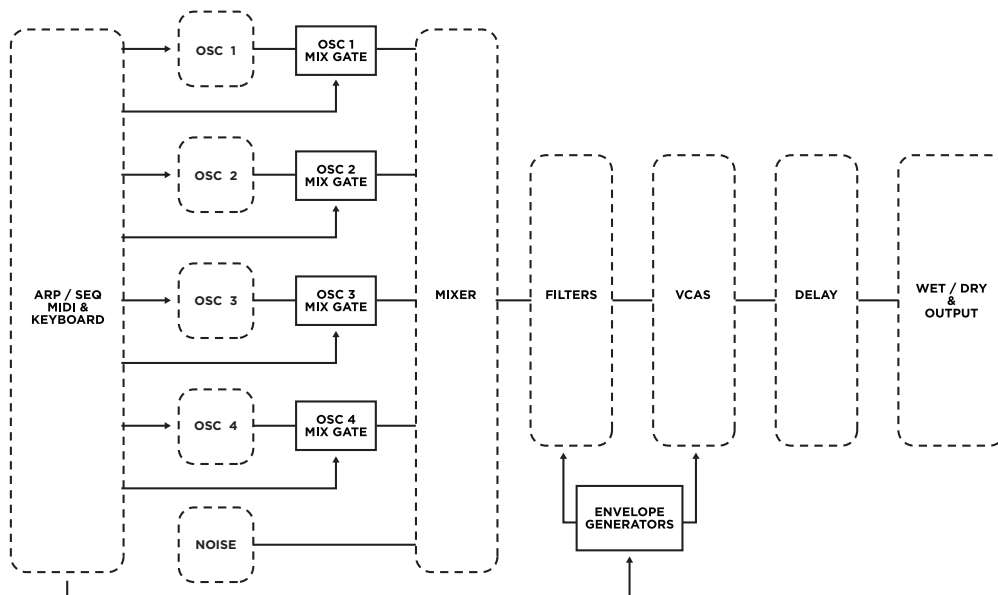

PARAPHONY *(Continued)*



VOICE MODE

The **VOICE MODE** switch selects whether Matriarch will play as a 1-Voice monophonic synthesizer, as a 2-Note paraphonic synthesizer, or as a 4-Note paraphonic synthesizer.

1 (One-Note Monophonic)

In this mode, all four oscillators are played from a single key on the keyboard.

2 (Two-Note Paraphonic)

In this mode, two keys can be played on the keyboard simultaneously. The first key pressed will play Oscillator 1 and Oscillator 2; the second key pressed will play Oscillator 3 and Oscillator 4.

***TIP:** The **PITCH MODULATION ASSIGN** switch in the Modulation module can be extremely useful in this mode. Oscillator 2 can be sync'd to Oscillator 1, and Oscillator 4 can be sync'd to Oscillator 3. Applying modulation will increase the depth of the Sync effects without altering the pitch of Oscillator 1 and Oscillator 3.*

4 (Four-Note Paraphonic)

In this mode, up to four keys can be played on the keyboard simultaneously. Each key will play only one oscillator.

***NOTE:** When all keys are released, the first new note pressed will sound Oscillator 1; the next will sound Oscillator 2, etc.*

***TIP:** Try experimenting with the **VOICE MODE** switch during Sequencer and Arpeggiator playback.*

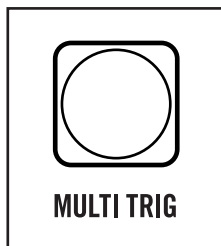

MULTI TRIG (Multiple Triggering)

This button determines how the Envelope Generators will respond to each new note press on the keyboard. When the red **MULTI TRIG** button is Off (unlit), the Envelope Generators will not retrigger until all keys on the keyboard are released, and a new key is played. If the red **MULTI TRIG** button is On (lit) the Envelope Generators will retrigger each time a new key is played on the keyboard.

***TIP:** In the One-Note Monophonic mode turn on the **MULTI TRIG** feature to eliminate legato triggering, ensuring every note played will trigger the Envelope Generators.*

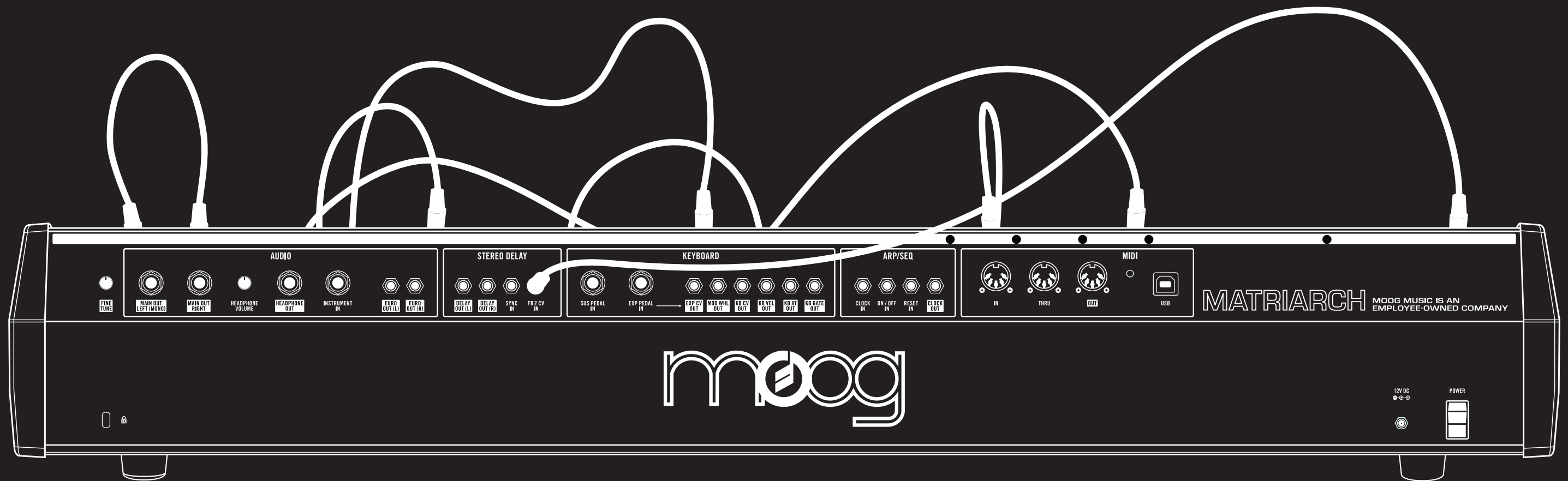

REAR PANEL

Matriarch's rear panel expands the instrument as a powerful tool for interconnective expression. Process external sound sources, grow your Moog semi-modular family, or control a Eurorack modular system with ease.

REAR PANEL

The rear panel of your Matriarch is populated with various audio, control, MIDI and USB jacks, as well as a global fine turning knob, power switch, the DC power connection jack, and a Kensington security slot.

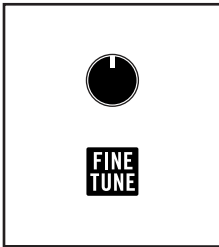

FINE TUNE

The global tuning (± 1 semitone) for all Matriarch oscillators is controlled by the **FINE TUNE** knob.

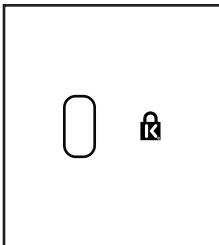

KENSINGTON SECURITY SLOT

Your Matriarch can be securely attached to a desk, stand, or other fixture by connecting a Kensington security device to this slot on the rear panel.

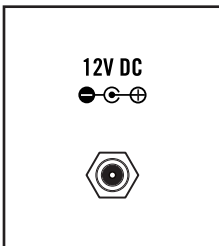

DC POWER CONNECTION JACK

The barrel end of the included power adapter plugs into this 12V DC power jack. Plug the other end of the included power adapter into a suitable AC outlet.

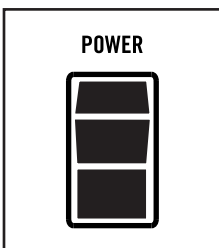

POWER SWITCH

This switch acts as a toggle, turning the power to the Matriarch On or Off. Press the top portion of the switch to turn Matriarch On; press the bottom portion of the switch to turn Matriarch Off.

AUDIO JACKS

The **AUDIO** section of the rear panel contains all of the main audio outputs in Line, Headphone, and Eurorack formats, as well as an instrument input that feeds into the Mixer module's signal path.

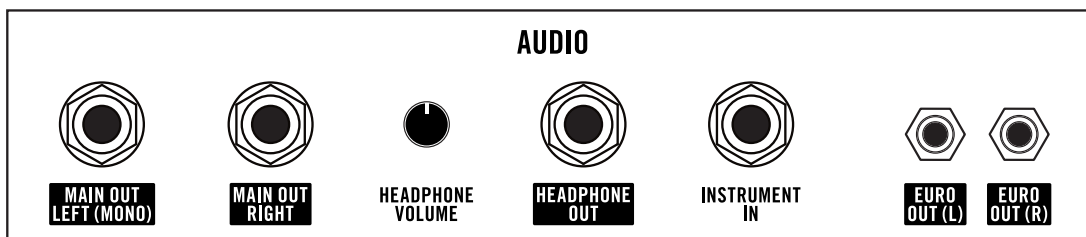

REAR PANEL *(Continued)*

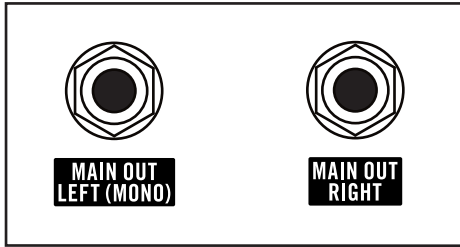

MAIN OUTS

Connect Matriarch to an amplifier, monitoring system, or audio interface using the 1/4" **MAIN OUT LEFT (MONO)** and **MAIN OUT RIGHT** jacks to enjoy sounds in stereo. If this is not possible, the **MAIN OUT LEFT (MONO)** jack is normalled to provide a mono mix of both the Left and Right channels when nothing is connected to the **MAIN OUT RIGHT** jack.

AUDIO OUTPUTS: +4dBu

NOTE: The **MAIN OUT** jacks will work with both TS and TRS 1/4" cables.

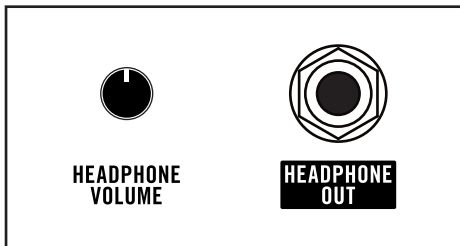

HEADPHONE VOLUME / HEADPHONE OUT

Connecting a pair of stereo headphones to the 1/4" **HEADPHONE OUT** jack allows for private listening and cueing up of new sounds in a live setting. The volume level of the **HEADPHONE OUT** jack is controlled only by the adjacent **HEADPHONE VOLUME** knob, and is unaffected by the **MAIN VOLUME** knob on the front panel.

AUDIO OUTPUT: TRS output; 1.1V into a 16 Ohm load

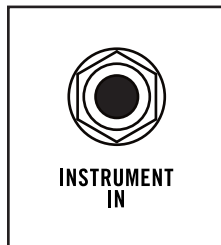

INSTRUMENT IN

A monaural audio signal from another instrument (guitar, drum machine, synthesizer, etc.) can be connected to Matriarch via this 1/4" input. An audio signal applied to this input is then fed directly into the Mixer module to be processed along with the onboard audio sources.

AUDIO INPUT: Instrument-level TS input with +20dB of gain

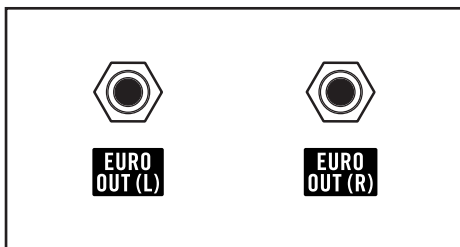

EURO OUT

These outputs provide a duplicate of the audio signal emerging from the **MAIN OUT LEFT (MONO)** and the **MAIN OUT RIGHT** jacks, but at Eurorack levels, so that Matriarch can be processed by or integrated with a Eurorack modular system.

AUDIO OUTPUTS: 10V peak-to-peak

NOTE: The **EURO OUT (L)** and **EURO OUT (R)** outputs are unaffected by the **MAIN VOLUME** knob in the Output module.

REAR PANEL *(Continued)*

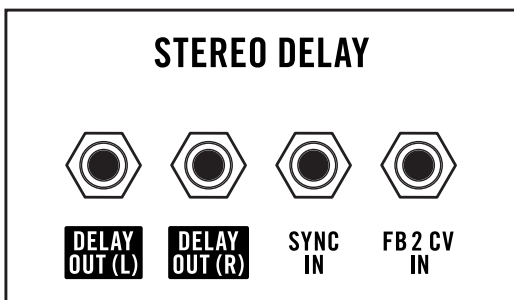

STEREO DELAY JACKS

The **STEREO DELAY** section of the rear panel relates to the operation and control of the Stereo Delay. Other jacks and controls for the Stereo Delay are found on the front panel.

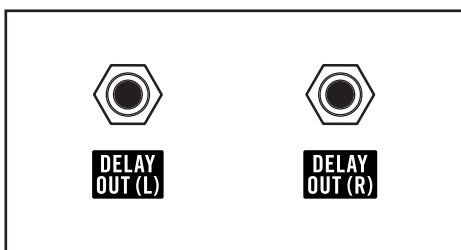

DELAY OUTS

The audio signals available at these outputs is the 100% wet output of the individual Delay modules - Delay 1 and Delay 2. By default, the output of Delay 1 is available at the **DELAY OUT (L)** jack; the output of Delay 2 is available at the **DELAY OUT (R)** jack.

AUDIO OUTPUTS: 10V peak-to-peak

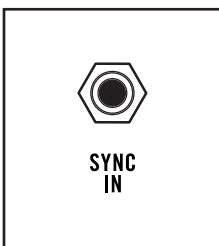

SYNC IN

With the red **SYNC** button On (lit), the Stereo Delay Time will sync to the rising edges of a clock or control signal received here. In this case, the Stereo Delay **TIME** knob on the front panel will select divisions or multiples of the sync'd clock rate.

CV INPUT: A rising signal > 3.6 Volts will create a Sync pulse.

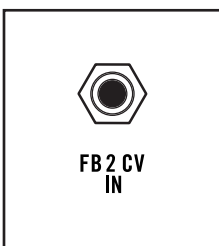

DELAY FB 2 CV IN

The value of the CV signal received via this jack is summed with the current value of the **FEEDBACK** knob in the Stereo Delay module on the front panel, and is then used to modulate the Feedback amount for Delay 2 only.

CV INPUT: 0V to +8V

NOTE: The **FB CV IN** jack on the front panel will normally modulate the Feedback amount of Delay 1 and Delay 2 by the same amount. By connecting a control signal to the **FB 2 CV IN** jack, the Feedback modulation of Delay 1 and Delay 2 can be controlled individually. The **FB CV IN** jack on the front panel will affect the Feedback amount of Delay 1, and the **FB 2 CV IN** jack on the rear panel will affect the Feedback amount of Delay 2.

KEYBOARD JACKS

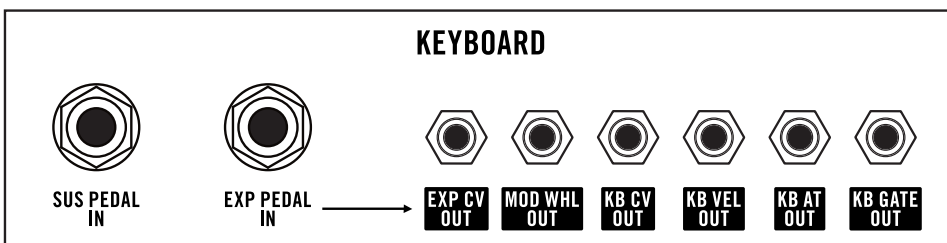

REAR PANEL *(Continued)*

KEYBOARD JACKS *(Continued)*

Matriarch both accepts and creates a number of keyboard control signals that can greatly enhance performance. In addition to jacks accepting a Sustain Pedal and an Expression Pedal, this area of the rear panel provides CV (Control Voltage) outputs for keyboard performance elements including velocity, aftertouch, gate, (mod wheel position, etc.

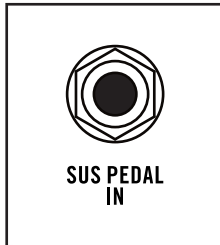

SUS PEDAL IN (Sustain Pedal Input)

When depressed, a compatible sustain pedal equipped with a 1/4" TS (Tip/Sleeve) plug and connected here will continue to hold any keys already being held down on the keyboard, even after the keys are released. The VCA EG and the VCF EG will complete their Attack and Decay stages, and hold at the Sustain level until the pedal is released, causing the Release stage to begin.

SUSTAIN INPUT: Depressing a Normally Open Sustain Pedal will short the tip to ground.

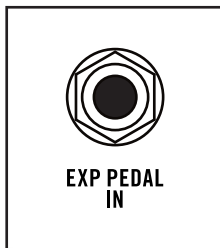

EXP PEDAL IN (Expression Pedal Input)

This 1/4" TRS (Tip/Ring/Sleeve) jack provides a +5 Volt signal on the ring connector. Operating a compatible Expression pedal - such as the Moog EP-3 - connected to this jack will attenuate this voltage so it can be used to vary any controllable parameter.

EXPRESSION INPUT: Scaled by the Expression Pedal, then buffered and scaled to come out of the **EXP CV OUT**.

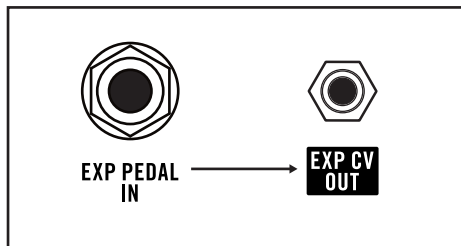

EXP CV OUT (Expression Pedal CV Out)

The signal from the expression pedal is buffered, and is then made available at the **EXP CV OUT** jack, where it can be routed to control the value of any parameter, either internal to Matriarch or on any other synthesizer or Eurorack module.

CV OUTPUT: 0V to +8V

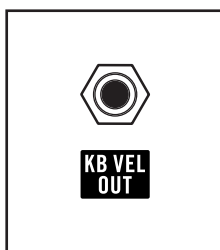

KB VEL OUT (Keyboard Velocity CV Out)

The Matriarch keyboard generates a control-voltage signal based on the Velocity of notes played on the keyboard. The signal available here can be routed to any controllable parameter, either internal to Matriarch or on any other synthesizer.

CV OUTPUT: 0V to +5V (0V to +10V selectable via Global Settings)

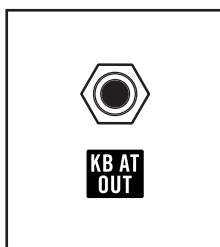

KB AT OUT (Keyboard Aftertouch CV Out)

The Matriarch keyboard generates an Aftertouch control-voltage signal based on the pressure applied to any keys that are already being held down. The signal available here can be routed to any controllable parameter, either internal to Matriarch or on any other synthesizer.

CV OUTPUT: 0V to +5V (0V to +10V selectable via Global Settings)

REAR PANEL *(Continued)*

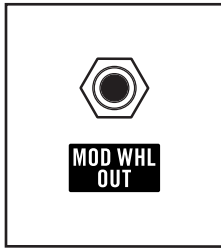

MOD WHL OUT (Modulation Wheel CV Out)

The position of the **MOD** wheel generates a control-voltage signal that is available here. The signal available here can be routed to any controllable parameter, either internal to Matriarch or on any other synthesizer.

CV OUTPUT: 0V to +5V (0V to +10V selectable via Global Settings)

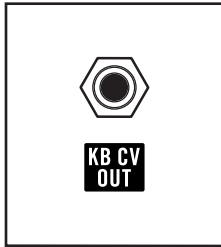

KB CV OUT (Keyboard CV Out)

The Matriarch keyboard generates a control-voltage signal based on the note being played on the keyboard. The signal available here can be routed to any controllable parameter, either internal to Matriarch or on any other synthesizer.

CV OUTPUT: -5V to +5V (0V to +10V selectable via Global Settings)

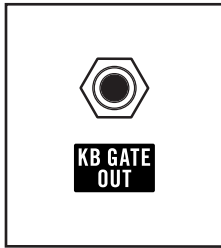

KB GATE OUT (Keyboard Gate Out)

The Matriarch keyboard generates a control-voltage signal based on the note being held on the keyboard. The signal available here can be routed to any controllable parameter, either internal to Matriarch or on any other synthesizer.

GATE OUTPUT: +5V (+10V selectable via Global Settings)

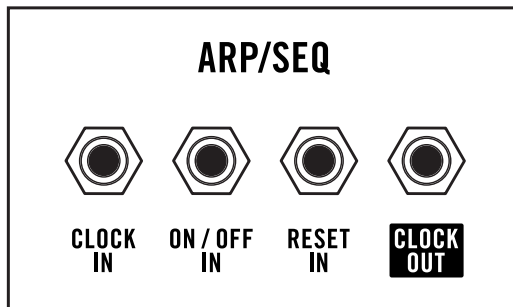

ARP/SEQ JACKS

This group of jacks is dedicated to synchronizing the Arpeggiator or Sequencer with other analog instruments.



CLOCK IN

This input allows Matriarch to be synchronized to an external clock source such as a DFAM, Mother-32, or any other instrument that outputs clock sync. When the input of a clock's rising edge is detected, the Sequencer or Arpeggiator pattern is advanced by one step. In this mode, the **RATE** knob selects timing values that are clock divisions of the external tempo.

CV INPUT: Rising signal > 3.6V will create a Sync pulse.

NOTE: Matriarch can also receive Clock information via MIDI.

REAR PANEL *(Continued)*

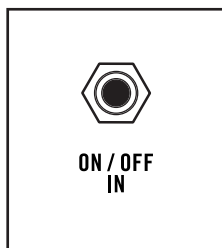

ON / OFF IN

By default, a signal received here will arm and disarm the playback of the Arpeggiator or Sequencer. Press the notes to be arpeggiated, or the starting note of the sequence, to begin playback.

CV INPUT: < 1V = Stop ; > 3.6V = Start

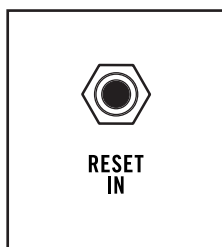

RESET IN

A signal received here will force the Arpeggiator or Sequencer to immediately reset to the first step, without stopping.

CV INPUT: A rising signal > 2.5V will create a Reset pulse

NOTE: The first step in a sequence or Arpeggiation will be played repeatedly for as long as a voltage is applied to this input.

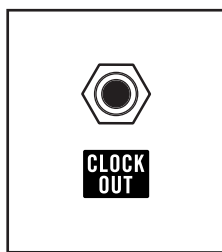

CLOCK OUT

This output allows Matriarch to transmit clock sync to other instruments while the Arpeggiator or Sequencer is running. The Clock Out rate is determined by the ARP / SEQ master tempo, and the global Clock Out PPQN setting. Accessing the Global Settings can allow the clock signal to be sent at all times.

CV INPUT: 0V to 10V

TIP: Matriarch can also send Clock information via MIDI.

MIDI PORTS

Matriarch can share MIDI signals with other MIDI-equipped devices via these 5-pin DIN style jacks. Matriarch can also share MIDI information with a computer via USB.

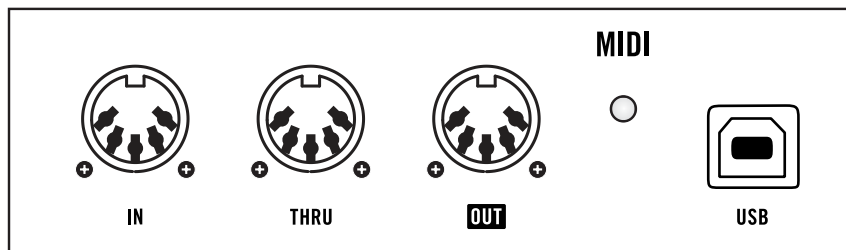

NOTE: Firmware updates are delivered via USB.

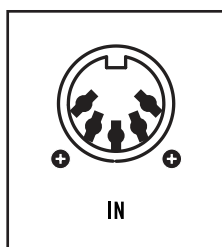

MIDI IN

The **MIDI IN** port can receive MIDI messages sent from an external source.

NOTE: The MIDI LED will blink when a MIDI signal is present at this input.

REAR PANEL *(Continued)*

MIDI PORTS *(Continued)*

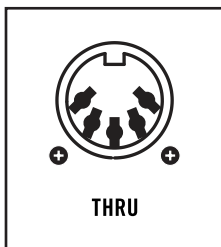

MIDI THRU

The MIDI signal received at the **MIDI IN** port is passed along unchanged via this **MIDI THRU** port.

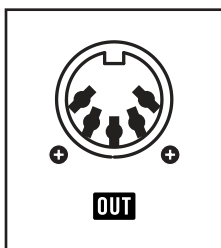

MIDI OUT

By default, MIDI signals created by and originating with Matriarch can be shared with other MIDI compatible equipment via this **MIDI OUT** port.

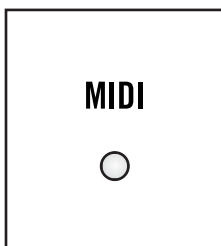

MIDI (LED)

This MIDI indicator lamp will blink to confirm that Matriarch is receiving MIDI data at the **MIDI IN** port

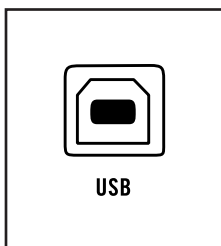

USB

Matriarch can also send and receive MIDI signals via USB, allowing integration with computer-based DAW systems, etc. In addition, Matriarch firmware updates are delivered via USB.

■ GLOBAL SETTINGS

Most Matriarch front-panel controls relate to creating sound. Below the surface, there is another level of parameters known as the Global Settings, which determine how the instrument operates, and how it can connect and interact with other electronic instruments and audio equipment.

To access Matriarch's Global Settings, simultaneously press and hold the **HOLD [SHIFT]** button located in the Left-Hand Controller and the **SYNC ENABLE** button located in Oscillator 1 until the **SYNC ENABLE** button begins to blink. This indicates that Matriarch is in the Global Settings edit mode. Now you can use the keyboard commands listed below to make any needed changes to the Global Settings. The **SYNC ENABLE** button will blink a specific number of times to indicate which Global Setting is currently selected. When you have finished making any changes, simply press the **SYNC ENABLE** button to exit the Global Settings edit mode.

Once you are in the Global Settings edit mode, you can freely select different groups and parameters using the black keys, and can switch the value of the selected parameters by using the white keys, until you press the **SYNC ENABLE** button to exit. Double-tapping on a white key will both update the setting and exit the Global Settings edit mode simultaneously.

NOTE: Global Settings are retained even when the power has been turned off.

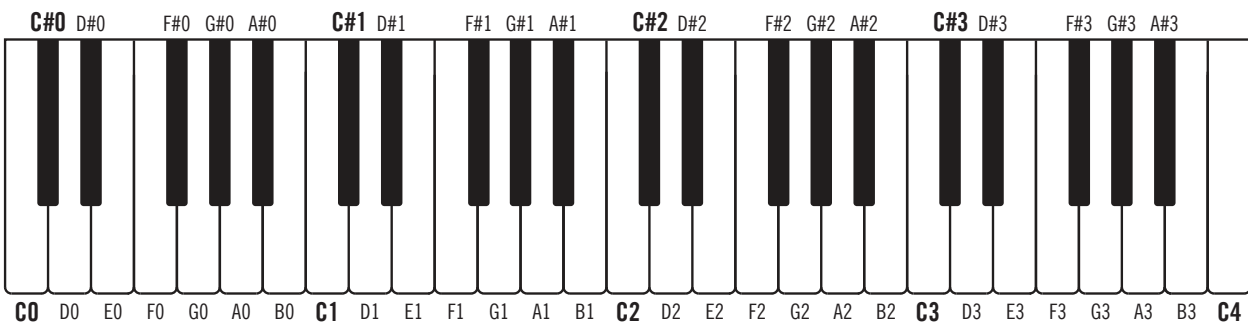

HERE'S HOW IT WORKS:

Global Settings are organized in groups of ten. An individual parameter in the chosen group is selected using one of the lower 10 black keys, starting with **C#0**. The white keys, starting with **C0**, are used to set the value of the chosen parameter. The first 10 parameters are in the default group, and no group selection is required. Additional groups are selected using one of the upper black keys, starting with **C#2**. To access these additional parameters, hold down the Group Select key while pressing the individual Parameter Select key.

Global Parameters Default Group (Group 0)	Group Select Key	Parameter Select Key	Sync Enable Button Blinks
0.1 Note Priority	(none)	C#0	1 x
Note Priority selects which note will take priority when playing the Matriarch keyboard in monophonic mode. The choices are the highest note played, the lowest note played, or the most recently played note. Use the first three white keys to select LOW (CO), HIGH (DO), or LAST (EO). The default setting is LAST.			
0.2 Glide Type	(none)	D#0	2 x
Glide Type determines the behavior of the Glide function. LCR (Linear Constant Rate): The Glide time is dependent on the interval between notes; the larger the interval, the longer the delay time. This is the most commonly used type of Glide. LCT (Linear Constant Time): The Glide time remains the same, regardless of the interval between notes. EXP (Exponential): The Glide rate follows an exponential curve that begins with a fast rate, and slows as it nears the target note. Use the first three white keys to select LCR (CO), LCT (DO), or EXP (EO). The default setting is LCR.			
0.3 Gated Glide	(none)	F#0	3 x
Gated Glide causes the gradual gliding between notes to be started and stopped by the keyboard gate. When gated glide is On, the pitch CV only glides while a key is held. When Gated Glide is Off, the pitch CV will continue gliding to the target pitch at the current Glide rate, regardless of whether or not a key is held on Matriarch. The different behaviors are more distinct at longer glide times. Use the lowest two white keys to select OFF (CO), or ON (DO). The Default is ON.			
0.4 Pitch Bend Range	(none)	G#0	4 x
The effective pitch bend range of the Matriarch PITCH wheel can be set in semitone units, from 0 to 12. Twelve semitones is equal to one octave. Use the lowest 13 white keys to select the corresponding number of semitones from zero/none (CO) to 12 (A1). The Default is 2 semitones (EO).			
0.5 Pitch Variance	(none)	A#0	5 x
Pitch Variance adds an adjustable amount of controlled randomness to the tuning of each note. The actual amount of detuning is applied randomly to each key press, from zero (no detuning), up to ± 40 cents of detuning per note. The maximum amount of detuning is set by this Pitch Variance parameter. Use any of the white keys to specify the maximum Pitch Variance value in 1.4 cent units, from zero (CO) to 40 cents (C4). The Default value is zero (CO).			
0.6 Oscillator Frequency Knob Range	(none)	C#1	6 x
The range of the Oscillator 2, 3, and 4 FREQUENCY knobs can be limited or expanded to a specific number of semitones, from zero to 24. Use the lowest 25 white keys (CO to F3) to set the range from 0 to 24 semitones (two octaves). The Default is 7 semitones (a musical Perfect Fifth).			
0.7 Square LFO Polarity	(none)	D#1	7 x
The square wave signal available from the Modulation section can be set to Unipolar - having only positive modulation above the zero line, or Bipolar - having equal amounts of both positive and negative modulation. Use the lowest two white keys to select Unipolar (CO) or Bipolar (DO). The Default is Bipolar.			

<i>(Continued)</i> Global Parameters Default Group (Group 0)	Group Select Key	Parameter Select Key	Sync Enable Button Blinks
0.8 Noise Filter Cutoff	(none)	F#1	8 x
Matriarch uses a 1-pole high-pass filter (VCF) to control the tonality and coloration of the analog Noise generator. Low-end content is removed as the filter cutoff frequency is increased. Use any of the white keys to set the cutoff frequency of the Noise Filter, from lowest (C0) to highest (C4). The Default is the lowest setting (C0).			
0.9 Delay Filter Brightness	(none)	G#1	9 x
The output of the Stereo Delay can be set to either a Bright tone or a Dark tone. Use the lowest two white keys to select Dark (C0), or Bright (D0). The Default is Bright (D0).			
0.10 Delay Sync CV Bend	(none)	A#1	10 x
The Delay Sync CV Bend parameter sets the behavior of the TIME CV inputs when the Delay is synchronized to internal or external clock. With Delay CV Sync Bend On, the TIME CV inputs “bend” the Delay Time relative to its currently synchronized tempo, up to plus-or-minus 33%. This can be useful for adding choral motion or warble to synchronized Delay effects. With Delay CV Sync Bend Off, the TIME CV inputs work identically to the front-panel TIME and SPACING knobs, selecting tempo-synced clock divisions of the of the currently synchronized tempo. Use the lowest two white keys to select OFF (C0), or ON (D0). The Default is OFF.			

Global Parameters Group 1	Group Select Key	Parameter Select Key	Sync Enable Button Blinks
1.1 MIDI Input Channel	C#2	C#0	1 x / 1 x
Matriarch can send and receive data on any MIDI Channel, from 1 to 16. Use the first 16 white keys (C0 to D2) to select the corresponding MIDI Input Channel (1 to 16).			
1.2 MIDI Output Channel	C#2	D#0	1 x / 2 x
Matriarch can send and receive data on any MIDI Channel, from 1 to 16. Use the first 16 white keys (C0 to D2) to select the corresponding MIDI output channel (1 to 16).			
1.3 MIDI Echo (USB)	C#2	F#0	1 x / 3 x
MIDI Echo USB allows MIDI data received at the USB MIDI input to be re-transmitted via the USB MIDI output, the DIN MIDI output, or both. Use the first four white keys to select OFF (C0), DIN OUTPUT (D0), USB OUTPUT (E0), or DIN & USB OUTPUTS (F0). The default is OFF (C0).			
1.4 MIDI Echo (DIN)	C#2	G#0	1 x / 4 x
MIDI Echo DIN allows MIDI data received at the DIN MIDI input to be re-transmitted via the DIN MIDI output, the USB MIDI output, or both. Use the first four white keys to select OFF (C0), DIN OUTPUT (D0), USB OUTPUT (E0), or DIN & USB OUTPUTS (F0). The default is OFF (C0).			

(Continued) Global Parameters Group 1	Group Select Key	Parameter Select Key	Sync Enable Button Blinks
1.5 MIDI Clock Input	C#2	A#0	1 x / 5 x
<p>The Matriarch Sequencer and Arpeggiator can be set to follow MIDI Clock, and can respond to Start and Stop commands received via MIDI. Depending on your setup, you may wish for Matriarch to ignore some of these commands. Use the first three white keys to select FOLLOW MIDI CLOCK + MIDI START/STOP COMMANDS (CO), FOLLOW MIDI CLOCK ONLY (Ignore MIDI Start/Stop commands) (DO), or IGNORE ALL MIDI CLOCK + MIDI START/STOP COMMANDS (EO). The Default is FOLLOW MIDI CLOCK + MIDI START/STOP COMMANDS.</p>			
1.6 MIDI Clock Output	C#2	C#1	1 x / 6 x
<p>The Matriarch Sequencer and Arpeggiator can be set to output MIDI Clock, as well as MIDI Start and Stop commands. Depending on your setup, you may wish for Matriarch to not send some of these commands. Use the first three white keys to select SEND MIDI CLOCK + MIDI START/STOP COMMANDS (CO), SEND MIDI CLOCK ONLY (Do not send MIDI Start/Stop commands) (DO), or DO NOT SEND MIDI CLOCK + MIDI START/STOP COMMANDS (EO). The Default is SEND MIDI CLOCK + MIDI START/STOP COMMANDS.</p>			
1.7 Local Control (Keyboard)	C#2	D#1	1 x / 7 x
<p>The Matriarch Keyboard, Pitch, and Modulation wheels can be disconnected from the internal synth engine, while still outputting MIDI and CV/Gate data. Use the lowest two white keys to select Local Control (Keyboard) OFF (CO), or ON (DO). The Default is ON.</p>			
1.8 Local Control (Arp / Seq)	C#2	F#1	1 x / 8 x
<p>The Matriarch Arp / Sequencer module can be disconnected from the internal synth engine while still outputting MIDI and CV/Gate data. Use the lowest two white keys to select Local Control (Arp / Seq) OFF (CO), or ON (DO). The Default is ON.</p>			
1.9 Receive Program Change	C#2	G#1	1 x / 9 x
<p>MIDI Program Change commands (Program Numbers 1 through 12) can be used to load a previously saved Matriarch sequence, and make it the active sequence. Turning this Global Setting OFF will prevent errant Program Change commands from inadvertently activating a saved sequence. Use the lowest two white keys to select OFF (CO), or ON (DO). The Default is ON.</p>			
1.10 Send Program Change	C#2	A#1	1 x / 10 x
<p>Matriarch can be set to send a MIDI Program Change command (Program Numbers 1 through 12) when the OCT / BANK switch and SEQUENCE knob on the front panel are used to select and load a previously saved sequence from memory. Turning this Global Setting OFF will prevent Program Change commands from being sent when a sequence is selected. Use the lowest two white keys to select OFF (CO), or ON (DO). The Default is OFF.</p>			

Global Parameters Group 2	Group Select Key	Parameter Select Key	Sync Enable Button Blinks
2.1 Arp / Seq Clock Input Mode	D#2	C#0	2 x / 1 x
<p>The CLOCK IN jack on the Matriarch rear panel can work in two different ways: as an analog clock input which sets the tempo of the Sequencer's internal clock, or as a step-advance trigger input, which advances the Arpeggiator or Sequencer by one step each time a rising-edge trigger is detected at the CLOCK IN jack. Use the first two white keys to select CLOCK (CO), or STEP-ADVANCE (DO). The Default is CLOCK.</p>			
2.2 Arp / Seq Clock Output	D#2	D#0	2 x / 2 x
<p>The Arp / Seq CLOCK OUT jack can be set to constantly send a clock pulse signal, or to send clock pulse signals only when the PLAY button is lit, and the playback of a sequence or Arpeggiator pattern is active. Use the first two white keys to select ALWAYS (CO), or ONLY WHEN PLAYING (DO). The Default is ONLY WHEN PLAYING.</p>			
2.3 Arp / Seq MIDI Output	D#2	F#0	2 x / 3 x
<p>Matriarch allows the note data generated by an arpeggio or sequence to be output via MIDI, or not. Use the first two white keys to select OFF (CO), or ON (DO). The Default is ON.</p>			
2.4 Sequencer Transpose Mode	D#2	G#0	2 x / 4 x
<p>The playback of a sequence can be transposed in real time via two methods. The first simply transposes the sequence so that the first note of the pattern is the note being played on the keyboard. The second method assumes Middle C is correct key, and will playback the sequence as it was recorded when Middle C is played. So to transpose the sequence up a Fourth, hold down the F key above Middle C. To transpose the sequence down a Fifth, hold down the G below Middle C. Use the first two white keys to select FIRST NOTE (CO), or MIDDLE C (DO). The Default is FIRST NOTE.</p>			
2.5 Sequence Keyboard Control	D#2	A#0	2 x / 5 x
<p>The keyboard and the Sequencer can operate together or independently. When Sequencer Keyboard Control is ON, pressing a key on the keyboard, or playing a MIDI note will start the sequence and set any transposition of the sequence. When Sequencer Keyboard Control is OFF, the Sequencer operates independently of the keyboard. The active sequence will play immediately at the original recorded pitch when the PLAY button is pressed (lit), while notes played on the Matriarch keyboard (or MIDI notes) can then play along with the Sequencer. Use the first two white keys to select OFF (CO), or ON (DO). The Default is ON.</p>			
2.6 Sequence Keyed Restart	D#2	C#1	2 x / 6 x
<p>Sequence Keyed Restart determines the behavior of the Sequencer when Sequence Keyboard Control is ON. When restarting a sequence by playing a key on the keyboard (or a received MIDI note), the sequence can restart from the first note of the sequence (ON), or the sequence can resume playback from where it left off. Use the first two white keys to select OFF (CO), or ON (DO). The Default is ON.</p>			
2.7 Arp / Seq Keyed Timing Reset	D#2	D#1	2 x / 7 x
<p>The Arp / Seq Keyed Timing Reset changes how the Arpeggiator, the Matriarch master clock, and notes played on the keyboard will interact. When OFF, the Arpeggiator will remain locked to the Master Clock so that notes played ahead of the beat (prior to the next step) will wait for the next beat, or clock step, to sound. When ON, notes played on the keyboard will sound immediately, and the master clock will reset, or sync, to the timing of when the key was pressed. Use the first two white keys to select OFF (CO), or ON (DO). The Default is OFF.</p>			

(Continued) Global Parameters Group 2	Group Select Key	Parameter Select Key	Sync Enable Button Blinks
2.8 FW / BW Repeat	D#2	F#1	2 x / 8 x
<p>When the DIRECTION switch in the Arp / Seq module is set to FW / BW, this setting will determine whether the first and last notes of an arpeggio pattern or sequence are repeated as the direction changes. This can be handy both melodically and rhythmically. If Repeat is OFF, the three-note sequence [C-E-G] would play as [C-E-G-E-C-E-G-E...]; if Repeat is ON, the same [C-E-G] sequence would now play as [C-E-G-G-E-C-C-E-G-G-E-C...]. Use the first two white keys to select OFF (CO), or ON (DO). The Default is ON.</p>			
2.9 Delay Sequence Change	D#2	G#1	2 x / 9 x
<p>The Global Setting for Delay Sequence Change determines how the Sequencer playback will transition from one sequence to another. When the Sequencer is running, changing from one sequence to another will take place instantly (Delay Sequence Change = OFF), or the active sequence will be allowed to finish before the new sequence begins (Delay Sequence Change = ON). Use the first two white keys to select OFF (CO), or ON (DO). The Default is OFF.</p>			
2.10 ARP /SEQ Swing	D#2	A#1	2 x / 10 x
<p>Adding Swing to the playback of the Arpeggiator or Sequencer causes the offbeat to arrive Early or Late, in varying amounts, to change the rhythmic feel. Use any of the white keys to set the swing amount, in 2% increments. The range of available values is from 22% (offbeat at its earliest) using key (CO), to 78% (offbeat at its latest) using key (C4). A Triplet feel, equal to a value of 66%, can be achieved using key (D3). The Default value is 50% (no swing), or key (C2).</p>			

Global Parameters Group 3	Group Select Key	Parameter Select Key	Sync Enable Button Blinks
3.1 Clock Input PPQN	F#2	C#0	3 x / 1 x
<p>In order for the Matriarch Sequencer and Arpeggiator to sync correctly to an External Clock, this Global Setting allows you to specify how many pulses are received per quarter note (PPQN). Use the first fourteen white keys to choose the number of clock pulses received per quarter note. (CO) = 1 PPQN; (DO) = 2 PPQN; (EO) = 3 PPQN; (FO) = 4 PPQN; (GO) = 5 PPQN; (AO) = 6 PPQN; (BO) = 7 PPQN; (C1) = 8 PPQN; (D1) = 9 PPQN; (E1) = 10 PPQN; (F1) = 11 PPQN; (G1) = 12 PPQN; (A1) = 24 PPQN; (B1) = 48 PPQN. The Default is 2PPQN (DO).</p>			
3.2 Clock Output PPQN	F#2	D#0	3 x / 2 x
<p>In order for an external device to sync correctly to the Matriarch Sequencer and Arpeggiator, this Global Setting allows you to specify how many pulses are sent per quarter note (PPQN). Use the first fourteen white keys to choose the number of clock pulses sent per quarter note. (CO) = 1 PPQN; (DO) = 2 PPQN; (EO) = 3 PPQN; (FO) = 4 PPQN; (GO) = 5 PPQN; (AO) = 6 PPQN; (BO) = 7 PPQN; (C1) = 8 PPQN; (D1) = 9 PPQN; (E1) = 10 PPQN; (F1) = 11 PPQN; (G1) = 12 PPQN; (A1) = 24 PPQN; (B1) = 48 PPQN. The Default is 2PPQN (DO).</p>			

(Continued) Global Parameters Group 3	Group Select Key	Parameter Select Key	Sync Enable Button Blinks
3.3 KB CV OUT Range	F#2	F#0	3 x / 3 x
<p>The Matriarch keyboard generates a specific control voltage for every note played. The voltage range of this signal appears at the KB CV OUT jack on the Matriarch rear panel, and can be set to (-5V to +5V) or (0V to +10V) in order to accommodate another synthesizer or piece of electronic music gear. Use the first two white keys to select either -5V to +5V (CO), or 0V to +10V (DO). The Default is -5V to +5V.</p>			
3.4 Arp/Seq CV OUT Range	F#2	G#0	3 x / 4 x
<p>The Matriarch Arpeggiator and Sequencer generate a specific control voltage for every note played. The voltage range of this signal appears at the CV OUT jack in the ARP / SEQ module on the front panel, and can be set to (-5V to +5V) or (0V to +10V) in order to accommodate another synthesizer or piece of electronic music gear. Use the first two white keys to select either -5V to +5V (CO), or 0V to +10V (DO). The Default is -5V to +5V.</p>			
3.5 KB VEL OUT Range	F#2	A#0	3 x / 5 x
<p>The Matriarch keyboard generates a specific control voltage based on the dynamics of every note played. The voltage range of this signal appears at the KB VEL OUT jack on the rear panel, and can be set to (0V to +5V) or (0V to +10V) in order to accommodate another synthesizer or piece of electronic music gear. Use the first two white keys to select either 0V to +5V (CO), or 0V to +10V (DO). The Default is 0V to +5V.</p>			
3.6 Arp/Seq VEL OUT Range	F#2	C#1	3 x / 6 x
<p>The Matriarch Arpeggiator and Sequencer generate a specific control voltage based on the dynamics of every note played. The voltage range of this signal appears at the VEL OUT jack in the ARP / SEQ module on the front panel, and can be set to (0V to +5V) or (0V to +10V) in order to accommodate another synthesizer or piece of electronic music gear. Use the first two white keys to select either 0V to +5V (CO), or 0V to +10V (DO). The Default is 0V to +5V.</p>			
3.7 KB AT OUT Range	F#2	D#1	3 x / 7 x
<p>The Matriarch keyboard generates a specific control voltage based on the amount of Aftertouch being applied. The voltage range of this signal appears at the KB AT OUT jack on the rear panel, and can be set to (0V to +5V) or (0V to +10V) in order to accommodate another synthesizer or piece of electronic music gear. Use the first two white keys to select either 0V to +5V (CO), or 0V to +10V (DO). The Default is 0V to +5V.</p>			
3.8 MOD WHL OUT Range	F#2	F#1	3 x / 8 x
<p>The Matriarch Modulation (MOD) Wheel generates a specific control voltage based on its current position. The voltage range of this signal appears at the MOD WHL OUT jack on the rear panel, and can be set to (0V to +5V) or (0V to +10V) in order to accommodate another synthesizer or piece of electronic music gear. Use the first two white keys to select either 0V to +5V (CO), or 0V to +10V (DO). The Default is 0V to +5V.</p>			

(Continued) Global Parameters Group 3	Group Select Key	Parameter Select Key	Sync Enable Button Blinks
3.9 KB GATE OUT Range	F#2	G#1	3 x / 9 x
<p>The Matriarch keyboard generates a specific control voltage, or gate, whenever a key is depressed. This gate voltage appears at the KB GATE OUT jack on the rear panel, and can be set to +5V or +10V, in order to accommodate another synthesizer or piece of electronic music gear. Use the first two white keys to select either +5V (CO), or +10V (DO). The Default is +5V.</p>			
3.10 Arp/Seq GATE OUT Range	F#2	A#1	3 x / 10 x
<p>The Matriarch Arpeggiator and Sequencer generate a specific control voltage, or gate, whenever a non-legato note is played. This gate voltage appears at the VEL OUT jack in the ARP / SEQ module on the front panel, and can be set to +5V or +10V, in order to accommodate another synthesizer or piece of electronic music gear. Use the first two white keys to select either +5V (CO), or +10V (DO). The Default is +5V.</p>			

Global Parameters Group 4	Group Select Key	Parameter Select Key	Sync Enable Button Blinks
4.1 Delayed Keyboard Octave Shift	G#2	C#0	4 x / 1 x
<p>The keyboard Octave Up/Down functions (SHIFT + PLAY buttons for Octave Down, and SHIFT + TAP buttons for Octave Up) can be set to take effect immediately, transposing any notes that are currently being held on the keyboard, or their effect can be delayed, meaning that any currently held notes will not be transposed, but new notes played after using the Octave Up/Down function will sound at the new octave. Use the lowest two white keys to select OFF (CO), or ON (DO). The Default is ON.</p>			
4.2 Round-Robin Mode	G#2	D#0	4 x / 2 x
<p>This voice-assignment mode uses a cyclical pattern to assign each new note to a different oscillator. There are three available values: Off (CO), On with Reset (DO), and On (EO). When the value is set to Off, each new note is always assigned to lowest-numbered available oscillator. With the value set to On with Reset, the first note played is always assigned to Oscillator 1, and additional notes are assigned to the other remaining oscillators in a rotating fashion. With the value set to On, each note played is assigned to the next available oscillator. The Default is On with Reset (DO).</p>			
4.3 Paraphonic Unison	G#2	F#0	4 x / 3 x
<p>When Paraphonic Unison is set to On, all four Matriarch oscillators will always sound, even when the PARAPHONY switch is set to VOICE MODE 2 or VOICE MODE 4, regardless of how many notes are held. When just one key is played, all four of the Matriarch oscillators will play from that key. When two keys are played, each key will play two of the Matriarch oscillators (1+2; 3+4). With the switch set to VOICE MODE 4, adding a third note assigns a new pitch to Oscillator 3, and adding a fourth note assigns a new pitch to Oscillator 4. Use the lowest two white keys to select OFF (CO), or ON (DO). The Default is OFF.</p>			

(Continued) Global Parameters Group 4	Group Select Key	Parameter Select Key	Sync Enable Button Blinks
4.4 Update Unison on Note-Off	G#2	G#0	4 x / 4 x
<p>This Global Setting is only available while the Paraphonic Unison Global Setting is set to On. When the Update Unison on Note-Off setting is on, all four oscillators are reassigned to the notes which are still playing whenever a key is released. Use the lowest two white keys to select OFF (CO), or ON (DO). The Default is OFF.</p>			
4.5 Restore Stolen Voices on Note-Off	G#2	A#0	4 x / 5 x
<p>When the PARAPHONY switch is set to VOICE MODE 2 or VOICE MODE 4, as the number of keys played exceeds the current number of available voices, older notes are “stolen” and replaced by newer notes. However, when this Global Setting is set to On, the oscillator(s) can resume playing the pitch of these stolen notes – as long as their respective keys are still being held on the keyboard. This can be very beneficial in mixing mono and poly playing techniques, such as holding a three-note chord, while using the remaining voice to play a mono-style trill. Use the lowest two white keys to select OFF (CO), or ON (DO). The Default is OFF.</p>			
4.6 Tuning Scale Select	G#2	C#1	4 x / 6 x
<p>Matriarch is fully compliant with the MIDI Tuning Standard, so you can import, save, and use tuning scales and intonation systems from around the world. Tuning scales can be accessed via MIDI messages, or by using this Global Setting to select a Tuning scale from the keyboards. The last Tuning scale selected will be remembered when the power is turned off and on again. Use any of the white keys to select a tuning table by number, from 0 (CO) to 28 (C4). Tuning table 0 (CO) is permanently set to 12-Tone Equal Temperament. The default setting is tuning table 0 (CO).</p>			
4.7 Sequence Random Repeat	G#2	D#1	4 x / 7 x
<p>This parameter controls whether the Sequencer playback in Random direction will allow the same note/pitch to repeat on adjacent steps, or not. Use the lowest two white keys to select ALLOW REPEATS (CO), or DO NOT ALLOW REPEATS (DO). The default is ALLOW REPEATS (CO).</p>			

NOTE: Tuning scales are imported into Matriarch via MIDI, and can be sent from tuning software such as Scala, or the Moog Phatty Tuner. Matriarch supports the following MIDI TUNING STANDARD message types:

- Bulk Tuning Dump (128-note scales)
- Single-Note Tuning (retunes notes individually)
- Scale/Octave Types 5, 6, 8, 9 – 1-Byte and 2-Byte formats.

The official MIDI Tuning Standard description is part of The Complete MIDI 1.0 Detailed Specification PDF document, available free of charge at www.midi.org. You will be required to register at the site in order to access this document, and other information related to MIDI.

■ MIDI DOCUMENTATION

1 - Basic Information	Transmit / Export	Recognize / Import	Remarks
MIDI Channels	1 - 16	1 - 16	
Note Numbers	0 - 127	0 - 127	
Program Change	1 - 12	1 - 12	Selects saved sequences
Bank Select Response	No	No	
Modes Supported: Mode 1: Omni-On, Poly	No	No	
Mode 2: Omni-On, Mono	No	No	
Mode 3: Omni-Off, Poly	Yes	Yes	
Mode 4: Omni-Off, Mono	Yes	Yes	
Multi Mode	No	No	
Note-On Velocity	Yes	Yes	
Note-Off Velocity	No	No	
Channel Aftertouch	Yes	Yes	
Poly (Key) Aftertouch	No	No	
Pitch Bend	Yes	Yes	
Active Sensing	No	No	
System Reset	No	No	
Tune Request	No	No	
Universal SysEx: Sample Dump Standard	No	No	
Device Inquiry	No	Yes	
File Dump	No	No	
MIDI Tuning	No	Yes	

MIDI DOCUMENTATION *(Continued)*

1 - Basic Information	Transmit / Export	Recognize / Import	Remarks
Master Volume	No	No	
Master Balance	No	No	
Notation Information	No	No	
Turn GM1 System On	No	No	
Turn GM2 System On	No	No	
Turn GM System Off	No	No	
DLS-1	No	No	
File Reference	No	No	
Controller Destination	No	No	
Key-based Instrument Ctrl	No	No	
Master Fine/Coarse Tune	No	Yes	
Other Universal System Exclusive	No	No	
Manufacturer or Non-Commercial System Exclusive	Yes*	Yes*	*No documentation for manufacturer sysex at this time (factory calibration etc)
NRPNS	No	No	
RPN 00 (Pitch Bend Sensitivity)	No	Yes	
RPN 01 (Channel Fine Tune)	No	Yes	
RPN 02 (Channel Coarse Tune)	No	Yes	
RPN 03 (Tuning Program Select)	No	Yes	Values 0-32 are valid; 0 = standard tuning (12-tone equal temperament). 1-32 are available for user storage of tunings using the MIDI Tuning Standard
RPN 04 (Tuning Bank Select)	No	No	
RPN 05 (Modulation Depth Range)	No	No	

MIDI DOCUMENTATION *(Continued)*

2 - MIDI Timing and Synchronization	Transmit / Export	Recognize / Import	Remarks
MIDI Clock	Yes	Yes	
Song Position Pointer	No	Yes	
Song Select	No	No	
Start	Yes	Yes	
Continue	No	Yes	
Stop	Yes	Yes	
MIDI Time Code	No	No	
MIDI Machine Control	No	No	
MIDI Show Control	No	No	

3 - Extensions Compatibility	Transmit / Export	Recognize / Import	Remarks
General MIDI Compatible (Level(s) / No)	No	No	
Is GM default power-up mode (Level / No)	No	No	
DLS Compatible (Level(s) / No)	No	No	
DLS File Type(s) / No	No	No	
Standard MIDI Files (Type(s) / No)	No	No	
XMF Files (Type(s) / No)	No	No	
SP-MIDI Compatible	No	No	
MIDI Machine Control	No	No	
MIDI Show Control	No	No	

MIDI DOCUMENTATION *(Continued)*

MIDI Continuous Controller (CC) Mapping:

Parameter	CC Number (MSB)	CC Number (LSB)	Values
Mod Wheel	1	33	MIN TO MAX (0 TO 16383)
Mod Rate	3	35	MIN TO MAX (0 TO 16383)
Glide Time	5	37	MIN TO MAX (0 TO 16383)
Arp Rate	8	40	MIN TO MAX (0 TO 16383)
Noise Filter Cutoff	9	41	MIN TO MAX (0 TO 16383)
Delay Time	12	44	MIN TO MAX (0 TO 16383)
Delay Spacing	13	45	MIN TO MAX (0 TO 16383)
Arp Swing	14	46	MIN TO MAX (0 TO 16383)
Arp Gate Length	15	47	MIN TO MAX (0 TO 16383)
Osc 2 Frequency	16	48	MIN TO MAX (0 TO 16383)
Osc 3 Frequency	17	49	MIN TO MAX (0 TO 16383)
Osc 4 Frequency	18	50	MIN TO MAX (0 TO 16383)
Sustain Pedal	64	-	0-63 = OFF, 64-127 = ON
Glide On	65	-	0-63 = OFF, 64-127 = ON
Arp Latch	69	-	0-63 = OFF, 64-127 = ON
Arp Play	73	-	0-63 = OFF, 64-127 = ON
Osc 1 Octave	74	-	0-31 = 16', 32-63 = 8', 64-95 = 4', 96-127 = 2'
Osc 2 Octave	75	-	0-31 = 16', 32-63 = 8', 64-95 = 4', 96-127 = 2'
Osc 3 Octave	76	-	0-31 = 16', 32-63 = 8', 64-95 = 4', 96-127 = 2'
Osc 4 Octave	77	-	0-31 = 16', 32-63 = 8', 64-95 = 4', 96-127 = 2'

MIDI DOCUMENTATION *(Continued)*

MIDI Continuous Controller (CC) Mapping:

Parameter	CC Number (MSB)	CC Number (LSB)	Values
Hard Sync Enable	80	-	0-63 = OFF, 64-127 = ON
Osc 2 Sync	81	-	0-63 = OFF, 64-127 = ON
Osc 3 Sync	82	-	0-63 = OFF, 64-127 = ON
Osc 4 Sync	83	-	0-63 = OFF, 64-127 = ON
Portamento Control	84	-	MIDI NOTE NUMBER OF A CURRENTLY-PLAYING NOTE TO TIE TO
Glide Type	85	-	0-42 = LCR, 43-84 = LCT, 85-127 = EXP.
Gated Glide	86	-	0-63 = OFF, 64-127 = ON
Legato Glide	87	-	0-63 = OFF, 64-127 = ON
Delay Ping Pong	88	-	0-63 = OFF, 64-127 = ON
Delay Sync	89	-	0-63 = OFF, 64-127 = ON
Square LFO Polarity	90	-	0-63 = UNIPOLAR, 64-127 = BIPOLAR
Arp Mode	91	-	0-42 = ARP, 43-84 = SEQ, 85-127 = REC
Arp Pattern	92	-	0-42 = ORDER, 43-84 = FW/BW, 85-127 = RANDOM
Arp Range / Bank	93	-	0-42 = 1, 43-84 = 2, 85-127 = 3
Paraphony Voice Mode	94	-	0-42 = 1 VOICE, 43-84 = 2 VOICE, 85-127 = 4 VOICE
Multi Trig	95	-	0-63 = OFF, 64-127 = ON
KB Octave	105	-	0-25 = -2, 26-50 = -1, 51-76 = 0, 77-101 = +1, 102-127 = +2

NOTES:

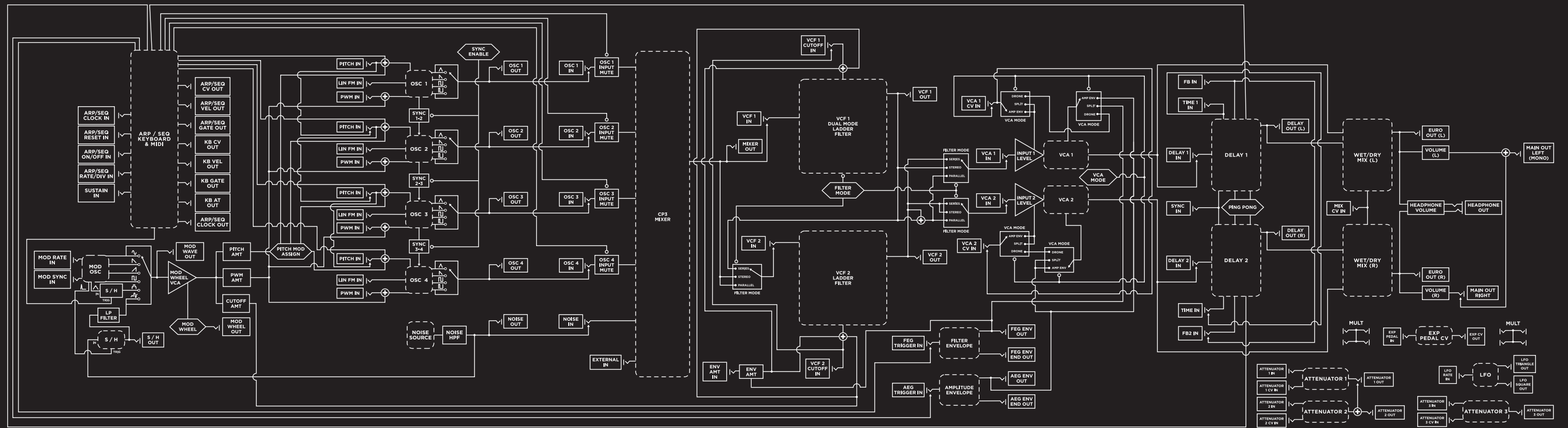

SIGNAL FLOW

KEY			
	FRONT PANEL CONTROL		NOT CONNECTED
	MODULE		CONNECTION
	AMPLIFIER		SUMMING
	JACK		NORMALLED JACK
	MODE		

■ FILTER MODE SIGNAL FLOW

NOTE: The arrows entering jacks from the bottom are normalised input connections into the associated jack.

HP / LP SERIES

In this mode, VCF 1 is configured as a High Pass filter and VCF 2 is configured as a Low Pass filter. Signal passes from the Mixer module out into VCF 1 OUT (High Pass), and then is routed into VCF 2 IN (Low Pass). The mono output signal from VCF 2 feeds both VCA 1 IN and VCA 2 IN.

NOTE: This is the foundation for creating a Band Pass filter.

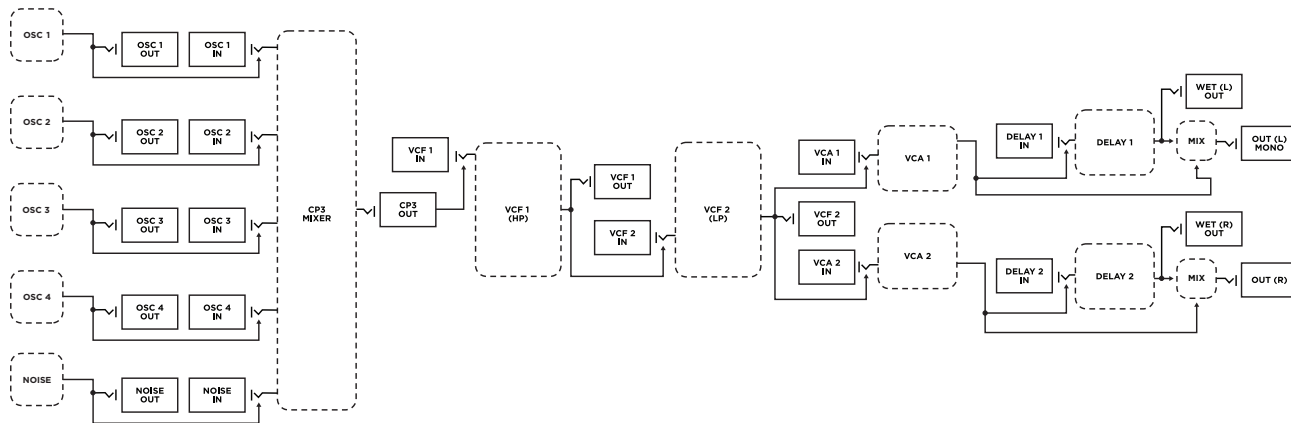

LP / LP STEREO

In this mode, VCF 1 and VCF 2 function independently as Low Pass filters. Both receive the same signal from the Mixer module out. VCF 1 OUT is routed to VCA 1 IN, and VCF 2 OUT is routed to VCA 2 IN. This creates a true-stereo signal path to the outputs.

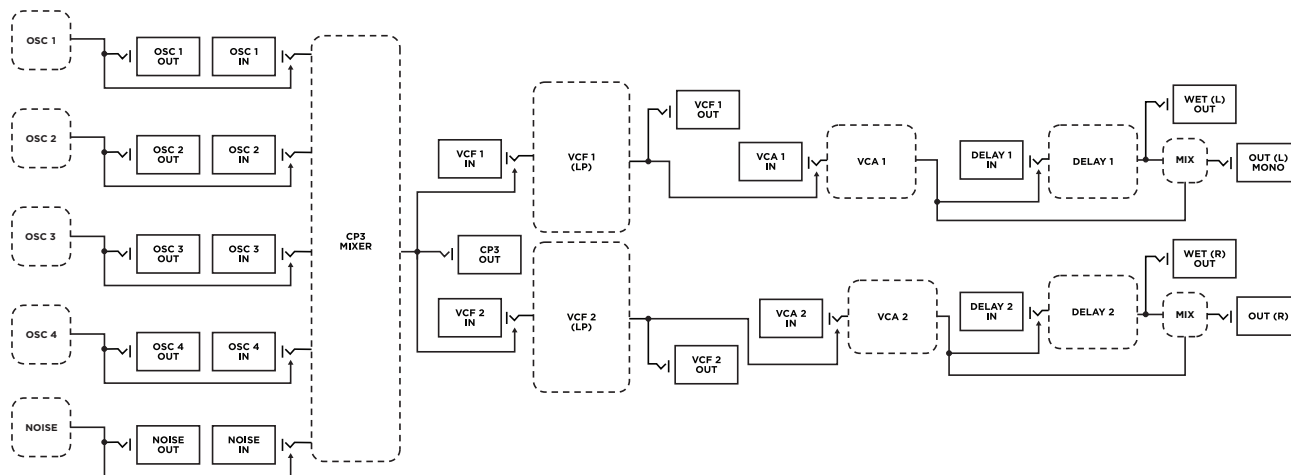

FILTER MODE SIGNAL FLOW *(Continued)*

HP / LP PARALLEL

In this mode, VCF 1 is configured as a High Pass filter and VCF 2 is configured as a Low Pass filter. Both receive the same signal from the Mixer module out, and their outputs are summed into a monaural signal that feeds both VCA 1 IN and VCA 2 IN.

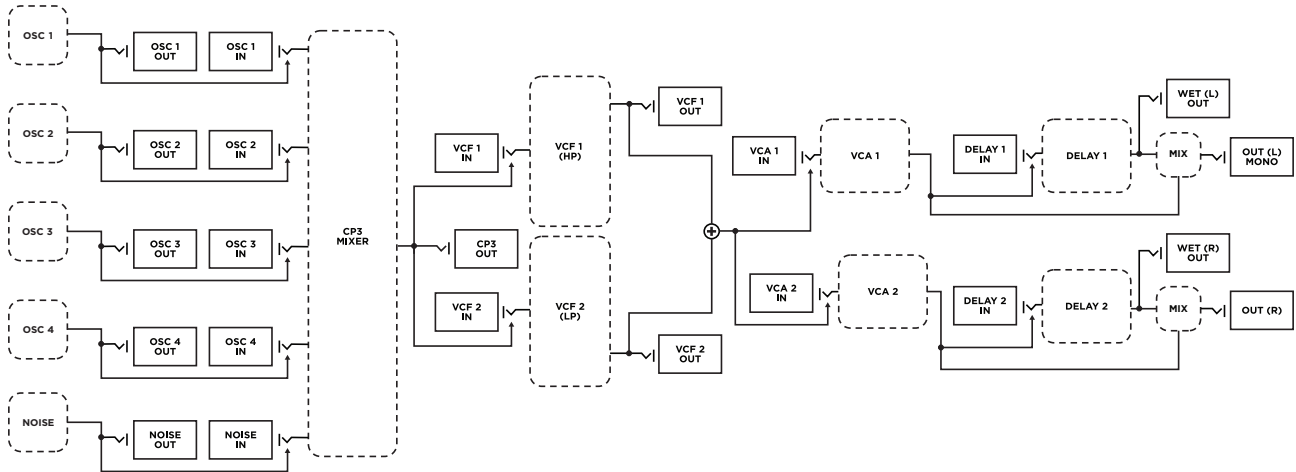

TITLE: _____

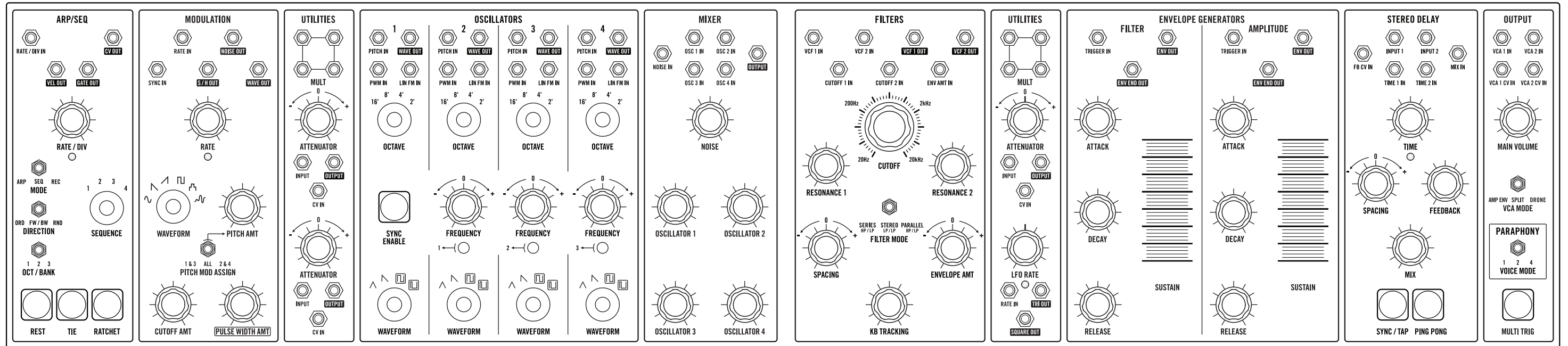

NOTES: _____

TITLE: _____

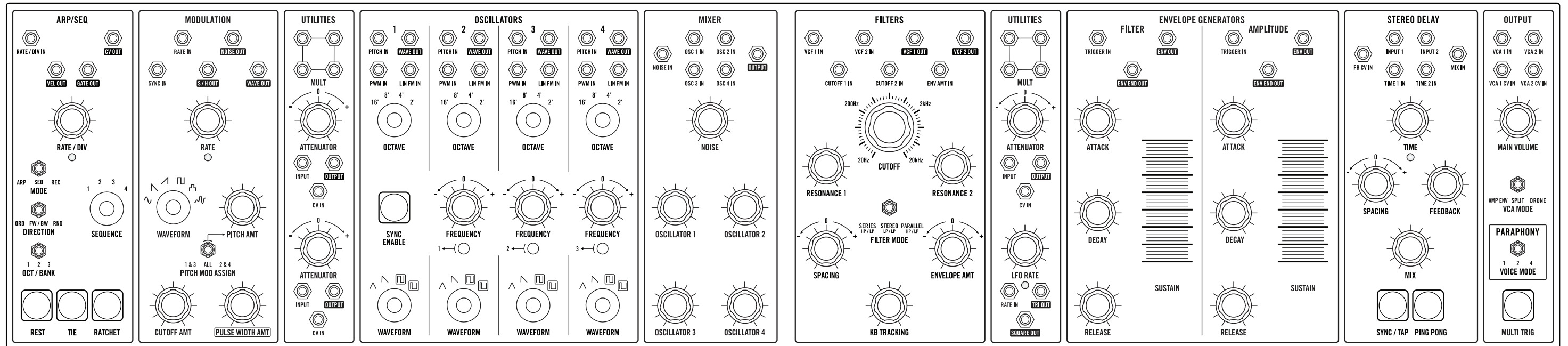

NOTES: _____

TITLE:

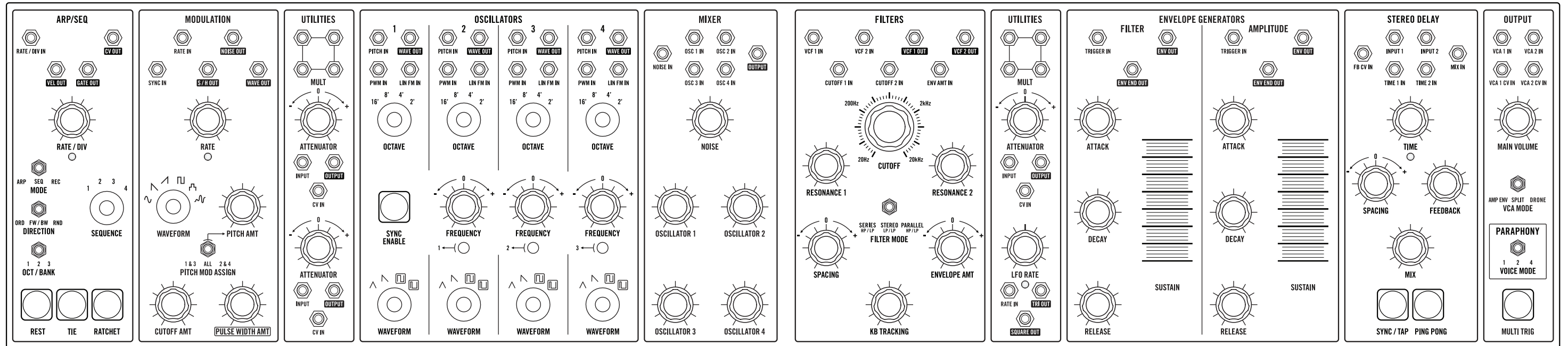

NOTES:

TITLE:

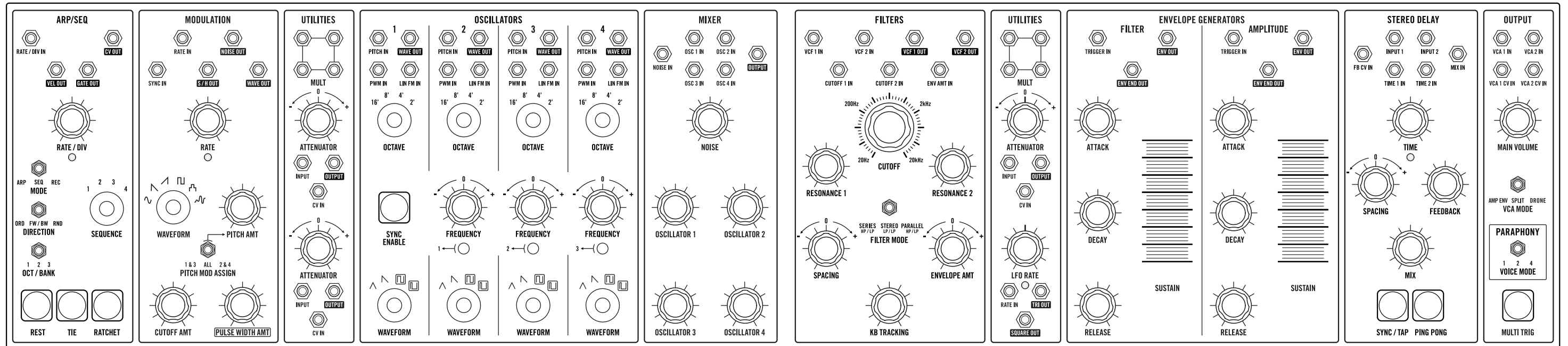

NOTES:

TITLE:

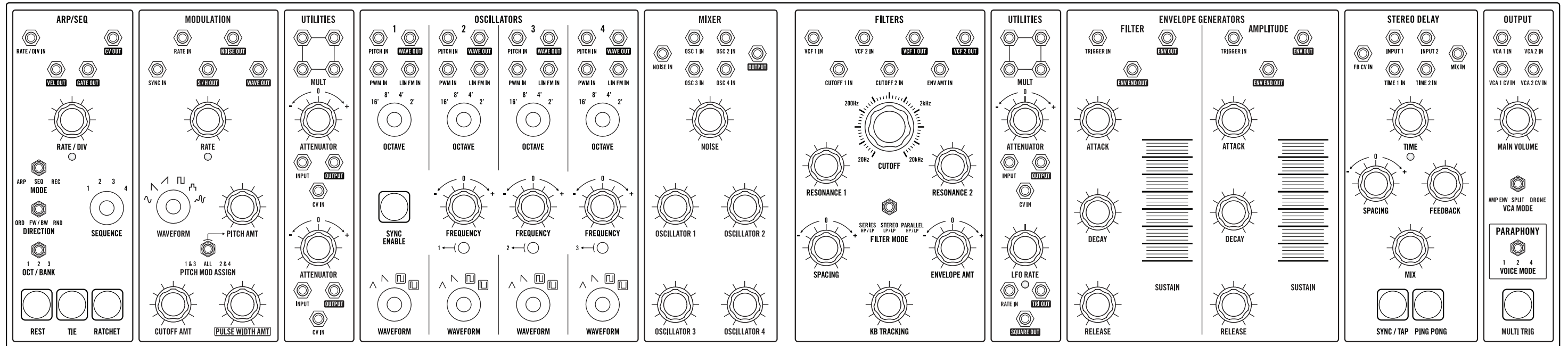

NOTES:

TITLE:

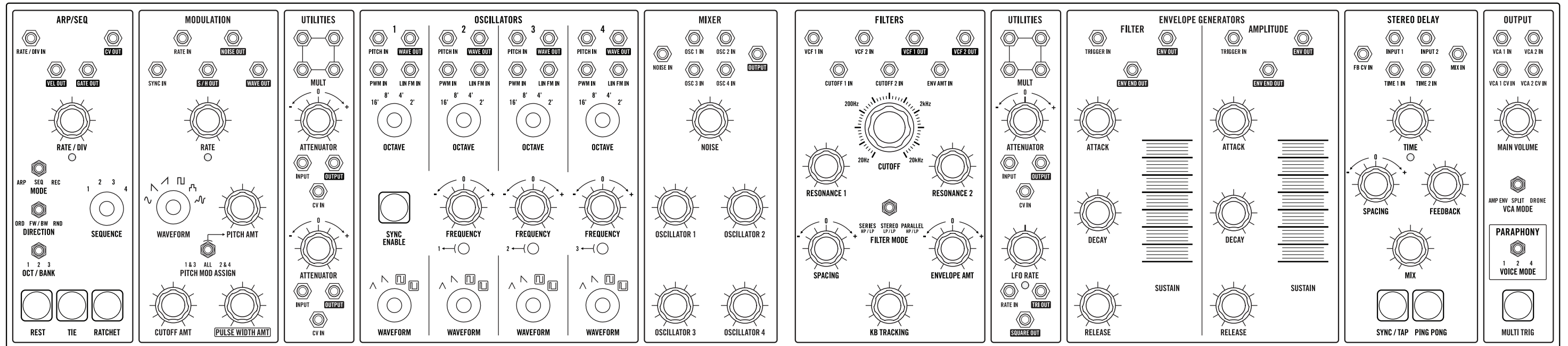

NOTES:

■ SPECIFICATIONS

TYPE: Semi-Modular Analog Synthesizer

SOUND ENGINE: Analog

NUMBER OF KEYS: 49 Full-Size Keys

TYPE OF KEYS: Velocity + Aftertouch

NOTE: *There are no hardwired connections for Velocity and Aftertouch; these control signals are available at the **KB VEL OUT** and **KB AT OUT** jacks found in the Keyboard section of the rear panel, and are also transmitted via MIDI.*

OTHER CONTROLLERS: Pitch Bend, Mod Wheel, Variable Glide

POLYPHONY: One-Note Monophonic, Two-Note Paraphonic, Four-Note Paraphonic

SOUND SOURCES: Four oscillators with selectable Waveforms and available Linear FM - Oscillators 2, 3, and 4 also support Hard Sync; White Noise Generator; External Input jack

VCF FILTERS: Two Moog Analog Ladder Filters (VCF); -24db/Octave with Resonance (Self-Oscillating); Configurable in one of three modes: Series = (VCF 1 High Pass/VCF 2 Low Pass); Stereo = (VCF 1 Low Pass/VCF 2 Low Pass); Parallel = (VCF 1 High Pass/VCF 2 Low Pass)

MOD SOURCES: Analog Modulation Oscillator (Sine, Sawtooth, Ramp, Square, Staircase, Smooth Random, S/H)

ENVELOPES: Two Four-Stage (ADSR) Envelope Generators

ATTENUATORS: Three Bipolar Voltage Controlled Amplifiers (VCA)

MULTS: Two Sets of Four Parallel-Wired, Non-Buffered Patch Points

EFFECTS: Stereo Analog Delay with Ping Pong mode and MIDI Sync

ARPEGGIATOR / STEP SEQUENCER: (256 Steps; 12 Sequence Files)

PATCH POINTS:

90 x 3.5mm (Front and Rear Panels)

49 Inputs, 33 Outputs

8 (4x2) Parallel-Wired Unbuffered Mults

AUDIO INPUT (Rear Panel): 1/4" TS

AUDIO OUTPUTS (Rear Panel): 1/4" TRS Mains [LEFT (MONO) + RIGHT] impedance balanced outputs @ +4dBu (Rear Panel); 3.5mm (1/8") Eurorack outputs [EURO OUT (L) + EURO OUT (R)] - unaffected by **MAIN VOLUME** knob setting; 3.5mm (1/8") Stereo Delay outputs [DELAY OUT (L) + DELAY OUT (R)]

HEADPHONE OUTPUT (Rear Panel): 1/4" TRS Stereo Headphone jack with dedicated HEADPHONE LEVEL knob

MIDI I/O (Rear Panel): DIN In, Out, Thru; plus MIDI over USB

PEDAL INPUTS (Rear Panel): One Sustain; One Expression

DIMENSIONS: 32" (81.28cm) Wide x 14 1/4" (36.19cm) Deep x 5 1/2" (13.97cm) High

WEIGHT: 30lbs / 13.61kg

POWER: Included Power Adapter 12V DC (Tip Positive Output), 2A; 100 Volts to 240 Volts AC, 50/60 Hz Input

■ SERVICE AND SUPPORT INFORMATION

MOOG'S STANDARD WARRANTY

Moog warrants its products to be free of defects in materials or workmanship and conforming to specifications at the time of shipment. The Warranty Period is one year from the date of purchase. If, in Moog's determination, it has been more than five years since the product shipped from our factory, it will be at Moog's discretion whether or not to honor the warranty without regard to the date of the purchase. During the Warranty Period, any defective products will be repaired or replaced, at Moog's option, on a return-to-factory basis. This warranty covers defects that Moog determines are no fault of the user.

The Moog Limited Warranty applies to USA purchasers only. Outside the USA the warranty policy and associated service is determined by the laws of the country of purchase and supported by our local authorized distributor. A listing of our authorized distributors is available at moogmusic.com.

If you purchase outside of your country, you can expect to be charged for warranty as well as non-warranty service by the service center in your country.

RETURNING YOUR PRODUCT TO MOOG MUSIC

You must obtain prior approval in the form of an RMA (Return Material Authorization) number from Moog before returning any product. Email techsupport@moogmusic.com for the RMA number or call us at (828) 251-0090. All products must be packed carefully and shipped with the Moog supplied power adapter. The Matriarch must be returned in the original inner packing including the cardboard inserts. Sorry, the warranty will not be honored if the product is not properly packed. Once you have received the RMA number and carefully packed your Moog Matriarch, ship the product to Moog Music Inc. with transportation and insurance charges paid, and be sure to include your return shipping address.

MOOG MUSIC
160 Broadway St.
Asheville NC, 28801

WHAT WE WILL DO

Once received, we will examine the product for any obvious signs of user abuse or damage as a result of transport. If the product abused, damaged in transit, or is out of warranty, we will contact you with an estimate of the repair cost. Warranty work will be performed and Moog will ship and insure your product to your United States address free of charge.

HOW TO INITIATE YOUR WARRANTY

Please initiate your warranty online at www.moogmusic.com/register. If you do not have web access, please call (828) 251-0090 to register your product.

CARING FOR MATRIARCH

Clean the Matriarch with a soft, dry cloth only – do not use solvents or abrasive detergents. Heed the safety warnings at the beginning of the manual. Do not drop the unit.

AN IMPORTANT NOTE ABOUT SAFETY: *There are no user serviceable parts in Matriarch. Refer all servicing to qualified personnel only.*

©2020 Moog Music, Inc. All rights reserved. **MOOG, MOOG (stylized with design), and the MOOG logo** are trademarks of Moog Music, Inc. Registered in U.S. Patent and Trademark Office and elsewhere. **MATRIARCH** is a trademark of Moog Music, Inc. in the United States and elsewhere.

Matriarch Dark User Manual Version 1 - August 2020

For the most up-to-date user manual and firmware updates, visit www.moogmusic.com/Matriarch.

Phone: +1 (828) 251-0090 | Email: info@moogmusic.com | Website: www.moogmusic.com

