

KORG

microSAMPLER

SAMPLING KEYBOARD



Owner's Manual

Precautions

Location

Using the unit in the following locations can result in a malfunction.

- In direct sunlight
- Locations of extreme temperature or humidity
- Excessively dusty or dirty locations
- Locations of excessive vibration
- Close to magnetic fields

Power supply

Please connect the designated AC adapter to an AC outlet of the correct voltage. Do not connect it to an AC outlet of voltage other than that for which your unit is intended.

Interference with other electrical devices

Radios and televisions placed nearby may experience reception interference. Operate this unit at a suitable distance from radios and televisions.

Handling

To avoid breakage, do not apply excessive force to the switches or controls.

Care

If the exterior becomes dirty, wipe it with a clean, dry cloth. Do not use liquid cleaners such as benzene or thinner, or cleaning compounds or flammable polishes.

Keep this manual

After reading this manual, please keep it for later reference.

Keeping foreign matter out of your equipment

Never set any container with liquid in it near this equipment. If liquid gets into the equipment, it could cause a breakdown, fire, or electrical shock.

Be careful not to let metal objects get into the equipment. If something does slip into the equipment, unplug the AC adapter from the wall outlet. Then contact your nearest Korg dealer or the store where the equipment was purchased.

THE FCC REGULATION WARNING (for USA)

This equipment has been tested and found to comply with the limits for a Class B digital device, pursuant to Part 15 of the FCC Rules. These limits are designed to provide reasonable protection against harmful interference in a residential installation. This equipment generates, uses, and can radiate radio frequency energy and, if not installed and used in accordance with the instructions, may cause harmful interference to radio communications. However, there is no guarantee that interference will not occur in a particular installation. If this equipment does cause harmful interference to radio or television reception, which can be determined by turning the equipment off and on, the user is encouraged to try to correct the interference by one or more of the following measures:

- Reorient or relocate the receiving antenna.
- Increase the separation between the equipment and receiver.
- Connect the equipment into an outlet on a circuit different from that to which the receiver is connected.
- Consult the dealer or an experienced radio/TV technician for help.

Unauthorized changes or modification to this system can void the user's authority to operate this equipment.

Notice regarding disposal (EU only)



When this "crossed-out wheeled bin" symbol is displayed on the product, owner's manual, battery, or battery package, it signifies that when you wish to dispose of this product, manual, package or battery you must do so in an approved manner.



Do not discard this product, manual, package or battery along with ordinary household waste. Disposing in the correct manner will prevent harm to human health and potential damage to the environment. Since the correct method of disposal will depend on the applicable laws and regulations in your locality, please contact your local administrative body for details. If the battery contains heavy metals in excess of the regulated amount, a chemical symbol is displayed below the "crossed-out wheeled bin" symbol on the battery or battery package.

** All product names and company names are the trademarks or registered trademarks of their respective owners.*

Regarding data

Unexpected malfunctions caused by inappropriate operation can cause the contents of memory to be lost. Please save important data to other media for safekeeping. Korg Corporation accepts no responsibility for any damages resulting from loss of data.

Regarding copyright

The use of copyrighted material for any purpose other than permitted uses such as personal or home enjoyment, constitutes copyright infringement, and may incur penalties including damages and restitution. The rights of the copyright holder also apply to recordings of, or derivative works produced using copyrighted material, meaning that reuse or distribution of such material is also a violation of copyright law. Korg Incorporated accepts no responsibility for any damages or penalties you may incur due to any copyright violation you may commit. If you have any questions regarding your rights to use copyrighted material, please consult a specialist in copyright law.

Samples and Pattern Sequences in ROM Bank;
(C) 2009 KORG Inc. - all rights reserved
Human Beatbox performed by "BEATSICK.JP" (KAZ and HIRONA)
For more information about "BEATSICK.JP" visit
<http://beatsick.jp>
<http://www.myspace.com/beatsickjp>

Table of Contents

Introduction	7
Main features.....	7
An overview of the microSAMPLER	8
Banks and memory	8
Front and rear panels.....	9
1. Front panel.....	9
2. Rear panel.....	12
Getting ready	13
Making connections.....	13
1. Connecting your monitor amp or mixer etc. to the output jacks ...	13
2. Connecting your audio device to the input jack(s)	13
3. Connecting the mic.....	13
4. Connecting your MIDI equipment and/or computer	13
Powering Up	14
1. Before you power up	14
2. Powering up	14
3. Powering down	14
Quick start	15
Listening to the ROM banks	15
1. Loading data from the ROM bank	15
2. Playing samples.....	15
3. Playing the pattern sequence data	16
Sampling	17
1. Preparations for sampling	17
2. Setting the tempo	18
3. Recording a sample.....	18

Playing the sample.....	19
Applying an effect to the sample.....	19
1. Using an effect.....	19
Pattern sequencer.....	20
1. Recording a pattern.....	20
2. Undoing or redoing pattern recording	21
3. Selecting and playing patterns	21
Reference guide.....	22
Banks.....	22
1. Basic procedure.....	22
2. Bank parameters.....	22
Sampling.....	23
1. The number of simultaneously playable samples	23
2. Maximum sampling time.....	23
3. Selecting the sampling type.....	23
4. Setting the sampling parameters.....	23
5. Sampling using Loop, One Shot, or Gate.....	25
6. Sampling using Auto Next	25
7. Sampling using Key Gate.....	26
8. Resampling.....	26
Playing samples	27
1. Loop playback	27
Editing a sample.....	27
1. Procedure.....	27
2. Sample parameters.....	28
3. DELETE SAMPLE	31
4. SWAP SAMPLE	31
5. LOAD SAMPLE.....	32

6. NORMALIZE	32	System exclusive messages	46
7. TRUNCATE.....	33	Realtime messages	46
Pattern sequencer	33	Effect parameters	47
1. About patterns	33	Appendix	64
2. Pattern recording method	33	Shift functions.....	64
3. Recording a pattern.....	33	Shortcuts	64
4. Playing a pattern	34	Parameter list.....	64
5. Recording additional material into the pattern that's playing.....	34	Error messages.....	65
6. Editing a pattern.....	34	Preset (ROM bank)	66
About the effect processor	36	1. Samples	66
1. Effect inputs and outputs	36	2. Patterns	66
2. Controlling effect parameters	36	Troubleshooting	67
3. About the delay time	36	Specifications.....	68
Global parameters	38	Index	69
Procedure	38		
Function and parameter list	38		
Saving (writing)	41		
MIDI guide	42		
Using the microSAMPLER with other MIDI devices	42		
1. Connecting a MIDI device or computer	42		
2. MIDI-related settings after connection	43		
About MIDI messages.....	44		
1. MIDI channel	44		
2. Note-on/off.....	44		
3. Pitch bend.....	45		
4. Control change	45		
5. Parameters transmitted and received as NRPN messages.....	45		

Introduction

Thank you for purchasing the **microSAMPLER** sampling keyboard. In order to take full advantage of your new instrument, please read this manual carefully and use the product as directed.

Main features

1. A new type of sampling keyboard

The **microSAMPLER** is a sampling keyboard that uses the keyboard to sample and play back. By switching the function of the keyboard, you can assign various different samples to the keyboard, or you can assign a single sample to be played by the 37-note keyboard at different pitches.

2. New types of sampling functionality

You can choose from five different sampling methods to suit your needs. For example, **KEY GATE** lets you record multiple samples consecutively by using the keys as **REC** switches. **AUTO NEXT** lets you automatically sample onto multiple keys one after the other.

3. Pattern sequencer

You can use the built-in pattern sequencer to quickly and easily record your keyboard performance in realtime and play it back. Quantization is also provided.

4. Built-in ROM bank samples

The built-in ROM bank contains 36 samples and 16 pattern sequences.

5. Effects to add the finishing touch

The **microSAMPLER** lets you apply one of 21 different types of effects to your samples.

6. Editor/Librarian software

You can connect the **microSAMPLER** to your computer via USB, and use the **microSAMPLER**'s dedicated editor/librarian software to conveniently manage samples or edit parameters.

7. Natural touch mini-keyboard

The **microSAMPLER** features a 37-note natural-touch mini-keyboard with velocity sensitivity.

An overview of the microSAMPLER

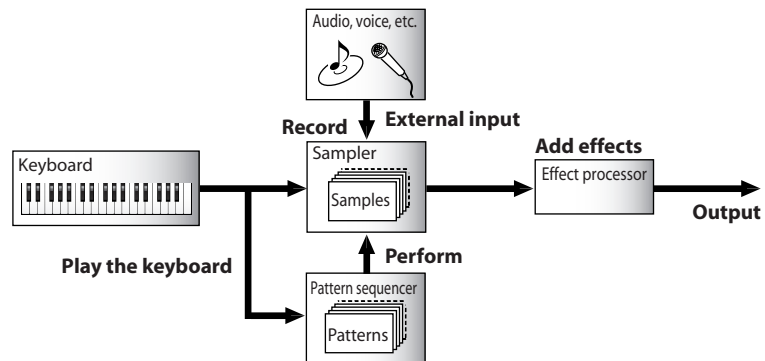

Sampler

This records (samples) sounds such as an instrumental or vocal performance, and plays it back.

Effect processor

This applies various effects to the recorded samples. You can choose from 21 different effects.

Keyboard

Use the keyboard to play the samples.

Pattern sequencer

This lets you arrange your samples into musical patterns. You can also play the samples automatically by playing back performance data.

Banks and memory

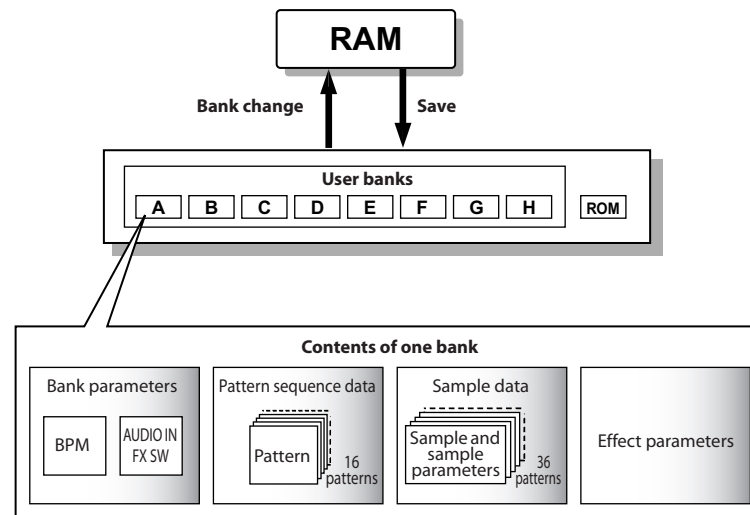

Sampling, recording into the pattern sequencer, and parameter editing operations are performed in “RAM.” All of this data will be lost when you turn off the power. If you want to keep the data, you must save it to a user bank before turning off the power (see p.41 “Saving (writing)”).

note You can't save to the ROM bank.

Front and rear panels

1. Front panel

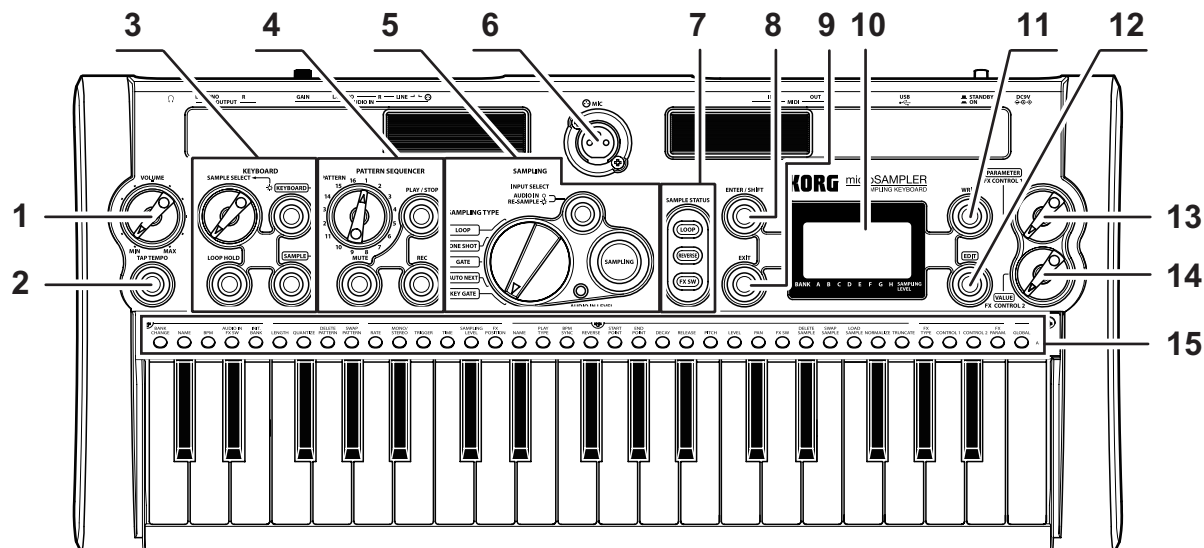

1. [VOLUME] knob

This adjusts the volume that is output from the OUTPUT [L/MONO], [R] jacks and the headphone jack.

2. [TAP TEMPO] button

You can set the tempo by pressing this button several times at the desired interval. The button will blink in time with the tempo.

3. KEYBOARD section

a. [KEYBOARD] / [SAMPLE] buttons

These buttons switch the keyboard function to Keyboard mode (☞ p.16) or Sample mode (☞ p.16).

b. [SAMPLE SELECT] knob

In Keyboard mode, this knob selects one of the samples that are assigned to Sample mode. When you operate the [SAMPLE SELECT] knob, the keyboard LED of the assigned sample will blink.

c. [LOOP HOLD] button

By holding down the [LOOP HOLD] button and pressing a key to which a sample is assigned, you can turn the Hold status on/off.

If Hold is on, playback will continue even when you take your finger off the currently-playing key.

⚠ This is available only if the sample parameter PLAY.TYPE (☞ p.28) is set to "LOOP ON."

4. PATTERN SEQUENCER section

a. [PATTERN] dial

Use this to select a pattern location in the pattern sequencer.

b. [MUTE] button

This allows you to prevent the sample of the selected key from sounding. (p.34 “Using the mute function”)

c. [PLAY/STOP] button

Starts and stops the pattern sequence.

d. [REC] button

This switches the pattern sequencer between record-ready, start, and stop.

5. SAMPLING section

a. [SAMPLING TYPE] switch

This specifies the type of sampling.

b. [INPUT SELECT] button

This selects the sampling source.

c. [SAMPLING] button

This switches between sampling setup, pause, start, and end.

d. [AUDIO IN LEVEL] LED

This will light green when there is input from the AUDIO IN [L/MONO] and [R] jacks or from the AUDIO IN [☺ MIC] jack. It will light red if the input is overloaded.

6. AUDIO IN [☺ MIC] jack

You can connect the included gooseneck or other dynamic microphone here.

To use a mic to this jack, set the rear panel AUDIO IN [☺ /LINE] switch to the “☺” position. Use the rear panel AUDIO IN [GAIN] knob to adjust the input level.

7. SAMPLE STATUS buttons

These buttons indicate and specify the state of the following three sample parameters for the current sample (p.18).

a. LOOP (p.28 “PLAY.TYPE”)

b. REVERSE (p.28 “REVERSE”)

c. FX SW (p.30 “FX SW”)

note To edit sample parameters other than the above, use the [EDIT] button to select the “SAMPLE” page. (p.28 “2. Sample parameters”)

8. [ENTER/SHIFT] button

Press this button to execute the setting you specified.

You can execute SHIFT functions by holding down this button and pressing another button. (p.64 “Shift functions”)

9. [EXIT] button

This button stops sampling, or cancels a save operation or utility operation.

10. Main display

This shows the information such as the currently selected parameter and its value, or messages.

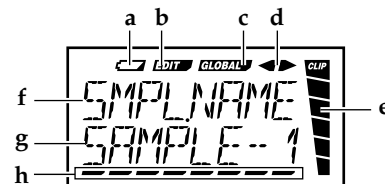

- a. Battery indicator
- b. Edit indicator
- c. Global indicator
- d. If there are multiple pages or parameters, “◀” or “▶” symbols will be shown to indicate that there are additional pages or parameters at the left or right.
- e. Sampling level meter
- f, g. These areas indicate the bank and sample, or the page and parameter.
- h. Cursor, bank number, etc.

11. [WRITE] button

Press this to save banks, samples, or performances you’ve recorded in the pattern sequencer.

12. [EDIT] button

When you want to edit a parameter, press this button; it will blink or solidly light. Select the page that contains the desired parameter, and then edit the parameter. This button will go dark if you use the [PARAMETER/FX CONTROL 1] knob or the [VALUE/FX CONTROL 2] knob to operate an assigned effect parameter.

13. [PARAMETER/FX CONTROL 1] knob

If the [EDIT] button or [WRITE] button is blinking or lit

This knob selects a parameter or page.

If the [EDIT] button or [WRITE] button is unlit

This knob controls the effect parameter assigned to FX CTRL-1 (Ⓢp.20).

14. [VALUE/FX CONTROL 2] knob

If the [EDIT] button or [WRITE] button is blinking or lit

This knob specifies the parameter value or save-destination.

If the [EDIT] button or [WRITE] button is unlit

This knob controls the effect parameter assigned to FX CTRL-2 (Ⓢp.20).

15. Keyboard LEDs

When you're in Sample mode, pressing a key will select the current sample (Ⓢp.18) and make the corresponding LED blink. If you press the right-most key, its keyboard LED will blink and you'll hear the sound that's being input from the AUDIO IN jacks (Ⓢp.18 "Listening to the sound from the AUDIO IN jacks").

When you're playing back samples, the LED of the key to which the currently-playing sample is assigned will be lit.

When you're in Keyboard mode, the LED of the key to which the sample selected in Sample mode is assigned will blink.

By holding down the [EDIT] button and pressing a key that's labeled with the name of an edit page, you can take a shortcut to that edit page.

If you've pressed the [EDIT] button to make the button light, the key that's labeled with the corresponding edit page will light when you operate the [PARAMETER/FX CONTROL 1] knob.

2. Rear panel

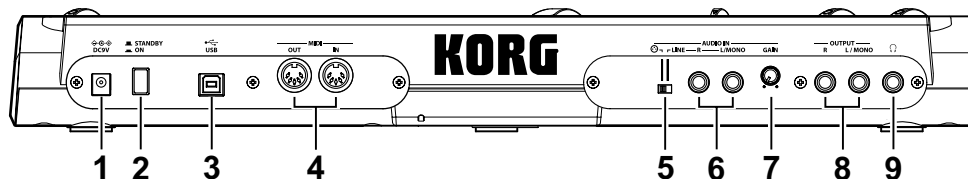

1. [DC9V] connector

Connect the included AC adapter here.

note Connect the AC adapter to the microSAMPLER first, and then plug the adapter into an AC outlet.

2. Power switch

Turns the power on/off.

3. [USB] connector

This can be connected to your computer, allowing MIDI data to be transmitted and received. You can also use editor/librarian software to edit the microSAMPLER's parameters.

note You must install the Korg USB-MIDI driver if you want to use the USB connection. Download the driver free of charge from the Korg website, and install it as directed by the included documentation.

4. MIDI

These connectors let you connect the microSAMPLER to external MIDI devices so that MIDI messages can be transmitted and received.

[MIDI IN] connector

Receives MIDI messages.

[MIDI OUT] connector

Transmits MIDI messages.

5. AUDIO IN [☺]/[LINE] switch

Set this to the "LINE" position if an audio device or rhythm machine is connected to the AUDIO IN [L/MONO] and [R] jacks. Set this to the "☺" position if a mic is connected to the front panel AUDIO IN [☺ MIC] connector.

6. AUDIO IN [L/MONO], [R] jacks

Connect these jacks to the audio device or rhythm machine you're using as a sampling source. If you're using a monaural source, connect the [L/MONO] connector.

7. AUDIO IN [GAIN] knob

This adjusts the input gain for the AUDIO IN [L/MONO], [R] jacks or the AUDIO IN [☺ MIC] jack.

8. OUTPUT [L/MONO], [R] jacks

Connect these jacks to your powered monitors, stereo amp, mixer, or multi-track recorder.

If you're using a monaural connection, connect the [L/MONO] jack.

9. Headphone jack

Connect your headphones (stereo phone plug) to this jack.

Getting ready

Making connections

The illustration below shows some typical connections for the microSAMPLER.

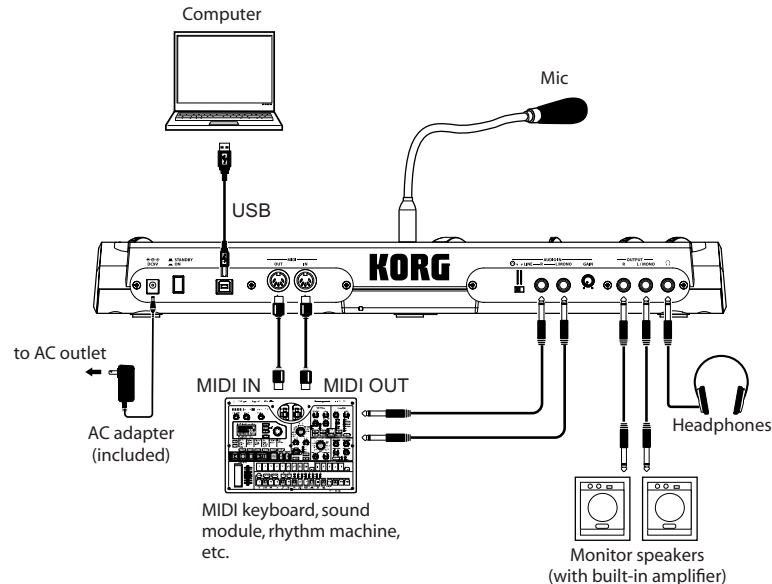

⚠ Turn off the power before you make connections. Careless operation may damage your speaker system or cause malfunctions.

1. Connecting your monitor amp or mixer etc. to the output jacks

Connect the microSAMPLER's OUTPUT [L/MONO], [R] jacks to the INPUT jacks of your mixer or powered monitors.

If you're using a monaural connection, connect the OUTPUT [L/MONO] jack.

2. Connecting your audio device to the input jack(s)

If you want to sample the sound from an audio device or rhythm machine, connect your device's OUTPUT jacks to the AUDIO IN [L/MONO], [R] jacks, and set the AUDIO IN [☺/LINE] switch to the "LINE" position (p. 12).

3. Connecting the mic

A mic is included with the microSAMPLER.

To attach the mic, connect it to the front panel AUDIO IN [☺ MIC] connector.

If you want to use a mic to sample your voice, connect the mic to the AUDIO IN [☺ MIC] jack, and set the rear panel AUDIO IN [☺/LINE] switch to the "☺" position (p. 12).

When disconnecting the mic, grasp its connector and pull it out.

- ⚠ Do not use excessive force when connecting or disconnecting the mic.
- ⚠ Do not apply excessive force to the gooseneck of the mic.
- ⚠ Be aware of the mic's output level when making connections.

4. Connecting your MIDI equipment and/or computer

Make these connections if you want to use the microSAMPLER's keyboard or controllers to control an external MIDI sound module, or if you want to use another MIDI keyboard or sequencer to play the microSAMPLER's sounds (p. 42 "Using the microSAMPLER with other MIDI devices").

Powering Up

1. Before you power up

Connect the AC adapter

1. Make sure that the microSAMPLER's power is turned off.
2. Connect the included AC adapter to the rear panel [DC9V IN] connector.
 - ⚠ Use only the included AC adapter. Using any other AC adapter may cause malfunctions.
3. Plug the AC adapter into an AC outlet.
 - ⚠ Be sure to use a AC outlet of the correct voltage as marked on the AC adapter.

Using batteries

The microSAMPLER can also be operated on batteries.

note Batteries are not included. You'll need to purchase them separately.

Installing or replacing the batteries

1. Make sure that the microSAMPLER's power is turned off.
2. Open the battery cover on the microSAMPLER's bottom panel.
3. Insert six AA alkaline batteries (sold separately).
 - ⚠ Be sure to insert the batteries in the correct direction as indicated above.
4. Replace the battery cover.

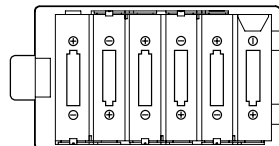

Battery empty indication

When the batteries run down, the “” indicator in the display will light. If you continue using the microSAMPLER, this indicator will begin blinking, Write Protect will be enabled automatically, and the following functionality will become unavailable.

- Saving
- Bank selection

We recommend that you replace the batteries as soon as possible, or use the AC adapter. If you are in the middle of editing when this occurs and need to save your settings, you can connect the AC adapter and then save your settings.

⚠ Unusable batteries should be immediately removed from the microSAMPLER. Leaving such batteries installed may cause malfunctions (such as battery leakage). You should also remove the batteries if you won't be using the microSAMPLER for an extended period of time.

2. Powering up

⚠ Before you power-up the microSAMPLER, make sure that your powered monitors or external output equipment is turned off.

1. Turn the microSAMPLER's [VOLUME] knob all the way toward the left.
2. Press the power switch to turn on the power.

The display will indicate the bank name.

note The bank that had been loaded when the power was last turned off will be loaded automatically.

3. Lower the volume of your powered monitors or external output equipment, and then turn them on.
4. Turn the microSAMPLER's [VOLUME] knob to an appropriate position.
5. Adjust the volume of your external output equipment.

3. Powering down

After you've finished all necessary operations such as saving, turn off the power using the following procedure.

⚠ Never turn off the power while data is being saved. Doing so may destroy the internal data.

1. Lower the volume of your powered monitors or external output equipment, and turn them off.
2. Turn the microSAMPLER's [VOLUME] knob all the way to the left, and then press the power switch to turn off the power.

Quick start

The microSAMPLER contains a wide range of functionality. To become familiar with your new equipment, please begin by working through this Quick Start section. This provides simple explanations of how to listen to the ROM banks, perform sampling, and use the pattern sequencer.

After you've finished reading the Quick Start section, you can refer to the subsequent sections for details.

Listening to the ROM banks

The microSAMPLER has a ROM bank in addition to its eight user banks (see p.8 "Banks and memory"). This ROM bank contains preset samples and pattern sequence data.

1. Loading data from the ROM bank

In order to hear the internal samples, you'll need to select a bank and load the data. In this example, we'll select the ROM bank.

Here's how to switch to the ROM bank.

1. Press the [EDIT] button to make it blink.
If it's not blinking, press the [EDIT] button several times to make it blink.
2. Turn the [PARAMETER/FX CONTROL 1] knob to select the "BANK" page.
3. Press the [EDIT] button to make it light.
4. Turn the [PARAMETER/FX CONTROL 1] knob to select the "BANK CHG" page.
5. Turn the [VALUE/FX CONTROL 2] knob to select "TO ROM."
6. Press the [ENTER/SHIFT] button.
7. When the display asks "SURE?," press the [ENTER/SHIFT] button once again. The ROM bank will be selected, and the display will indicate "COMPLETE."

- ⚠ Do not operate the microSAMPLER's knobs, buttons, or keyboard while the bank change is occurring, and never turn off the power during this time.

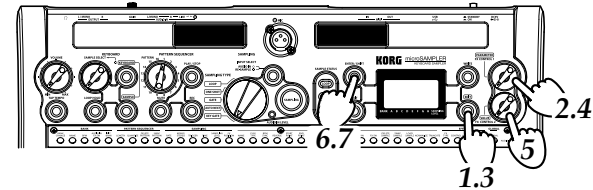

2. Playing samples

The type of playback will depend on the function that is currently selected for the keyboard.

The keyboard can function in one of two modes: Keyboard mode or Sample mode. Press the [KEYBOARD] button or [SAMPLE] button to switch between these modes.

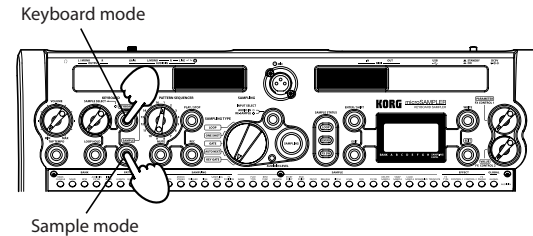

Sample mode

In this mode, 36 keys function as switches that play back the samples assigned to each key.

1. Press the [SAMPLE] button.

The keyboard will be in Sample mode.

2. Press a key to play its assigned sample.

The sample will play at its original pitch, with the playback mode you specified when capturing the sample.

The key LED for that sample will light while the sample is playing.

- ⚠ You can't assign a sample to the last key. This key is used as a gate switch for the audio signal being input from the AUDIO IN jack, so pressing it will not play a sound. (See p. 18 "Listening to the sound from the AUDIO IN jacks".)

If you press a key to which no sample is assigned

The sample assigned to the key above the key you pressed will play. The sample will be played at an adjusted speed (pitch) corresponding to the pitch of the key you pressed. The key LED for the sample that is playing will light.

Keyboard mode

In this mode, the single sample that you selected will be played by all thirty-seven keys at the corresponding pitches of the keyboard.

The sample assigned to the C4 key will play at the same pitch as when it was sampled.

1. Press the [KEYBOARD] button.

The keyboard will be in Keyboard mode.

2. Use the [SAMPLE SELECT] knob to select one of the samples that was assigned in Sample mode.

When you operate the [SAMPLE SELECT] knob, the key LEDs to which samples are assigned will blink consecutively.

3. Press the keyboard to play back the sample.

The C4 key will play the sample at its original pitch, and other keys will play the sample at correspondingly higher or lower pitches relative to C4.

The key LED for the sample assigned in Sample mode will be lit-up.

note If other samples are being played by the pattern sequencer, those key LEDs will be lit-up.

note You can't change the current sample while keys are held down in Keyboard mode.

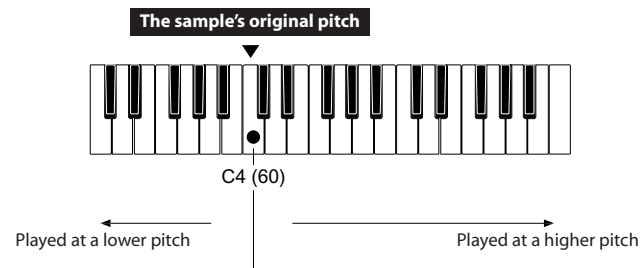

3. Playing the pattern sequence data

The ROM bank also contains 16 patterns for the pattern sequencer. Here's how to play back these patterns.

1. Use the [PATTERN] dial to select the pattern (1–16) that you want to play. For this example, we'll select pattern 1.
2. Press the [PLAY/STOP] button; the pattern will play.
3. Press the [PLAY/STOP] button once again; the pattern will stop.

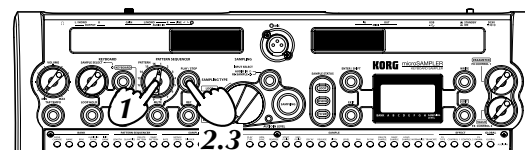

Use the [PATTERN] dial to try out other patterns.

Sampling

The illustration below shows the process of sampling, in which the level of the analog signal is read as digital data at fixed intervals along the time axis.

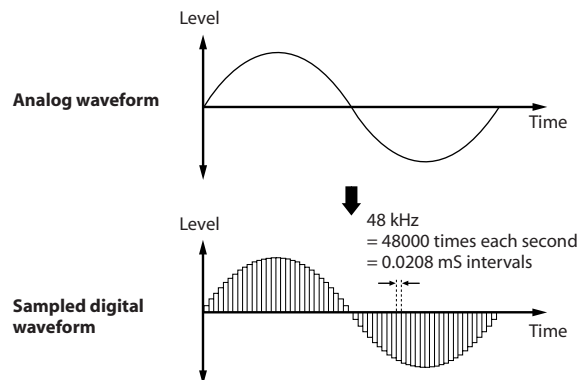

This fixed interval is the sample rate, usually stated as the sampling frequency. A sampling frequency of 48 kHz (kilohertz) means that sampling occurs 48000 times each second, so the interval would be $1 \text{ (second)} / 48000 \text{ (times)} = \text{approximately } 0.00002083 \text{ (seconds)} = \text{approximately } 0.02083 \text{ ms (milliseconds)}$.

The higher the sampling frequency, the closer the waveform will be to the original analog signal.

What is a “sample”?

The data captured into memory by the sampling process is called a “sample.” The sample consists of the actual waveform data along with sample parameters that specify how this data will be played.

What is the “sampling source”?

When capturing a sample, the sound from the audio device or microphone is called the “sampling source.”

note When you sample from a mic, the sound of operations performed on the microSAMPLER (e.g., the sound of a button being pressed) might be captured as well. If this is a problem, you can take the steps described on the pages listed below.

([p.24](#) “TRIGGER”)

([p.40](#) “STRT.TRIM/END TRIM”)

1. Preparations for sampling

In this example, we’ll sample the output from your audio device or rhythm machine.

First we’ll make preparations for inputting from the AUDIO IN [L/MONO] and [R] jacks.

1. Turn the rear panel AUDIO IN [GAIN] knob all the way to MIN, and connect your output audio device to the AUDIO IN [L/MONO] and [R] jacks.
2. Set the rear panel [☺ /LINE] switch to the “LINE” position.
3. Use the [INPUT SELECT] button to select “AUDIO IN.”

note If you want to perform resampling ([p.26](#) “8. Resampling”), select “RE-SAMPLE.”

4. Adjust the output level of your external device and the rear panel AUDIO IN [GAIN] knob so that the [AUDIO IN LEVEL] LED does not light red level.

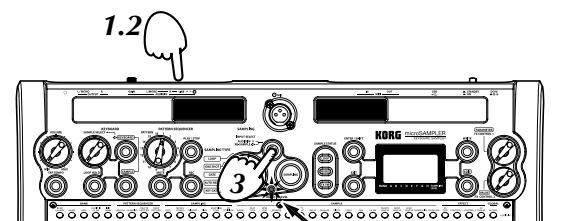

Adjust so that [AUDIO IN LEVEL] LED does not light red

Listening to the sound from the AUDIO IN jacks

The right-most key will act as a gate switch for the audio signal being input from the AUDIO IN jacks. You'll hear the input sound only while you continue holding down this key.

1. Press the [SAMPLE] button to select Sample mode.

 This function is not available in Keyboard mode.

2. Press the right-most key.

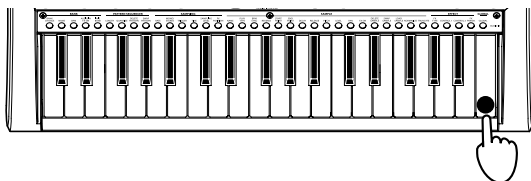

note If you hold down the [LOOP HOLD] button and press the last key, the input sound will continue to be heard even after you release the key.

2. Setting the tempo

You can specify the tempo either by using the Tap Tempo function (see p. 18 “Using the Tap Tempo function”) or by setting the Tempo parameter (see p. 22 “BPM”).

This tempo is stored as the original tempo (see p. 31 “ORIG BPM (Original BPM)”) of the sample that we’re going to sample.

Using the Tap Tempo function

You can specify the tempo by pressing a button at regular intervals in time with the beat. The tempo will change when you’ve pressed the button twice. For greater accuracy, it’s best to press the button several times.

1. Press the [TAP TEMPO] button two or more times. The interval at which you pressed the button will be detected, and shown in the display as the tempo.

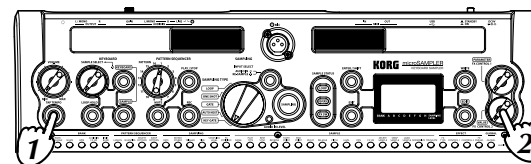

2. While the tempo is shown, you can adjust the tempo by turning the [VALUE/FX CONTROL 2] knob.

3. Recording a sample

Now that you’ve finished making preparations, let’s record a sample that we’ll play using “one-shot” playback.

1. Use the [SAMPLING TYPE] switch to select “ONE SHOT.”
2. Select either Keyboard mode or Sample mode.
3. Press the [SAMPLING] button.

The “SAMPLING” button will blink green, and you’ll be in sampling-setup mode. If you’re in Keyboard mode, switch to Sampling mode.

At this time, you’ll be able to hear the audio input for monitoring. The volume will depend on the sampling parameter LEVEL.

4. Press a key to specify the key to which the sample data will be assigned. The key LED of the key you pressed will blink. This key will be the current sample.

What is the “current sample”?

The “current sample” refers to the key to which your sampling operations will apply. This will be the key that you pressed most recently in Sample mode (the key LED will blink).

note When you turn on the power, the C4 key is selected as the current sample.

- The [EDIT] button will light; now you can set the sampling parameters (see p.23). Use the [PARAMETER/FX CONTROL 1] knob to select a sampling parameter, and use the [VALUE/FX CONTROL 2] knob to specify its value.

note The sampling parameters let you select the sampling rate, monaural or stereo, the way in which sampling will be triggered, the sampling time, the volume during sampling, and the effect position setting.

Set these parameters as shown below.

Sampling parameter	Value
RATE	48K
MONO/ST	STEREO
TRIGGER	SMPL SW
TIME	2/1
LEVEL	+0.0 dB
FX POS	MST FX

! Sampling will end automatically according to the setting of the sampling parameter TIME (see p.24). If you want to sample for a longer period of time, change the value of this parameter.

- Press the [SAMPLING] button when you want to start sampling. The [SAMPLING] button will change to blinking red, and sampling will begin.
- Sampling will end automatically when the specified sampling time has elapsed, or you can press the [SAMPLING] button or [EXIT] button to stop sampling. The [SAMPLING] button will go dark, and sampling will end.

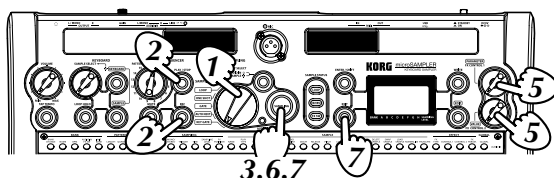

! If you turn off the power or switch to a different bank before saving, the sample you captured will be lost. If you want to keep the sample, you must save it (see p.41 "Saving").

If you want sampling to start automatically

In step 4, use the [PARAMETER/FX CONTROL 1] knob to select the TRIGGER parameter (see p.24).

Use the [VALUE/FX CONTROL 2] knob to select a value in the range of THRE 01...10, and then press the [SAMPLING] button.

The [SAMPLING] button will blink orange; the microSAMPLER will be in sample-standby mode, and sampling will begin automatically when the input reaches the threshold volume level you specified.

Playing the sample

Now let's listen to the sample you just recorded.

For details on how to play samples, refer to "2. Playing samples" (see p.15) and following.

Applying an effect to the sample

The microSAMPLER provides 21 different effects.

You can select one of these effect types and apply it to the sound.

For more details on the available effects, please refer to the "Effect parameters" (see p.47).

The effects can be turned on/off by the sample parameter FX SW (see p.30) of each parameter.

1. Using an effect

- Select one of the samples that's assigned in Sample mode, and turn its FX SW (see p.30) "ON."
- Press the [EDIT] button to make it blink. If the [EDIT] button is not blinking, press it again until it blinks.
- Use the [PARAMETER/FX CONTROL 1] knob to select the "EFFECT" page.
- Press the [EDIT] button to make it light-up.
- Use the [PARAMETER/FX CONTROL 1] knob to select the "[FX.TYPE]" page.

6. Use the [VALUE/FX CONTROL 2] knob to select the desired effect type.
7. Use the [PARAMETER/FX CONTROL 1] knob to select a parameter of the selected effect type.
8. Use the [VALUE/FX CONTROL 2] knob to edit the value of that parameter.

Using the [PARAMETER/FX CONTROL 1] knob and the [VALUE/FX CONTROL 2] knob to control effect parameters

When the [EDIT] button is unlit, you can use the [PARAMETER/FX CONTROL 1] knob and the [VALUE/FX CONTROL 2] knob to control effect parameters.

note The parameters to be controlled are dependent on the effect type selected.

Assigning effect parameters to the [PARAMETER/FX CONTROL 1] knob and the [VALUE/FX CONTROL 2] knob

In order to control effect parameters, you'll need to assign the desired effect parameters to the knobs.

For details on which parameters can be assigned, please refer to the "Effect parameters" (p.47).

Here's the procedure for making these assignments.

 If [FX.TYPE] is set to "FX OFF," you won't be able to select "[CTRL-1]" with the [PARAMETER/FX CONTROL 1] knob. Select an effect type before you continue (p.19 "1. Using an effect").

1. Press the [EDIT] button to make it blink.
If the [EDIT] button is not blinking, press it again until it blinks.
2. Use the [PARAMETER/FX CONTROL 1] knob to select the "EFFECT" page.
3. Press the [EDIT] button to make it light-up.
4. Use the [PARAMETER/FX CONTROL 1] knob to select "[CTRL-1]."
5. Use the [VALUE/FX CONTROL 2] knob to select the parameter that you want to assign to the knob.
6. Press the [EDIT] button to make it go dark.

Now you can use the [PARAMETER/FX CONTROL 1] knob to control the effect parameter that you assigned.

note If you want to assign an effect parameter to the [VALUE/FX CONTROL 2] knob, choose "[CTRL-2]" in step 4.

Pattern sequencer

The pattern sequencer is a function that records and plays back your keyboard playing in Keyboard mode or in Sample mode. In order to use this function, you must first use Sample mode to assign samples to the keyboard.

1. Recording a pattern

On the microSAMPLER, recording is done in realtime as "overdubbing"; i.e., each realtime performance is added to any material that had previously been recorded in that pattern. Until you stop recording, the number of measures you specified will continue repeating, and recording will occur on each pass. Now let's try recording a pattern.

1. Specify the tempo, either by using the [TAP TEMPO] button or by setting the tempo parameter (p.22 "BPM").
2. Use the [PATTERN] dial to select the pattern (1-16) that you want to record.
3. Press the [REC] button; you'll be in record-standby mode.
The [PLAY/STOP] button and the [REC] button will blink.
4. The [EDIT] button will light-up; use the [PARAMETER/FX CONTROL 1] knob and the [VALUE/FX CONTROL 2] knob to make the desired pattern sequencer settings.

The pattern sequencer settings (p.33 "3. Recording a pattern") consist of settings that specify the pattern length, the keyboard mode sample number, and quantization. Use the [PARAMETER/FX CONTROL 1] knob to select a parameter, and use the [VALUE/FX CONTROL 2] knob to specify the value of that parameter.

5. Press the [PLAY/STOP] button or the [REC] button to begin recording. The display will show the measure number to indicate progress during pattern playback or recording.

 Playback may be interrupted if you return to the beginning of the pattern or switch to a different pattern during pattern recording. You should stop recording before you switch patterns or return to the beginning of the pattern.

note If desired, you can enable the metronome during recording (p.38 "Function and parameter list").

- Press the [PLAY/STOP] button once again to stop recording.
If you press the [REC] button at this time, recording will stop but the pattern will continue playing.

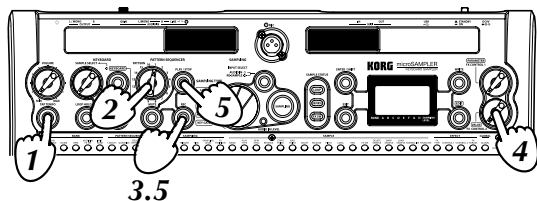

2. Undoing or redoing pattern recording

Here's how to cancel the pattern recording operation you just performed.

- Hold down the [ENTER/SHIFT] button and press the [REC] button.
You'll return to the state that you were at immediately prior to the previous operation (Undo).
note This won't occur if you haven't performed any recording operation.
- If you want to cancel the Undo (i.e., return to the result of the previous operation), once again hold down the [ENTER/SHIFT] button and press the [REC] button.

The pattern will return to its original state (Redo).

- note** By taking advantage of this function, you can easily compare an overdubbed take with the preceding take as you continue the recording process.

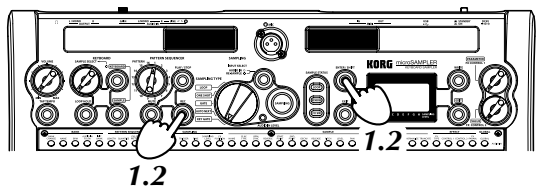

3. Selecting and playing patterns

- Use the [PATTERN] dial to select the pattern (1–16) that you want to play.
- Press the [PLAY/STOP] button to play the pattern.
note You can specify the timing where the pattern will change when you switch to a different pattern during playback (see p. 39 "PTRN CHG (Pattern change mode)").
note If you want to play from the beginning of the pattern, hold down the [ENTER/SHIFT] button and press the [PLAY/STOP] button.
- Press the [PLAY/STOP] button to stop playback.

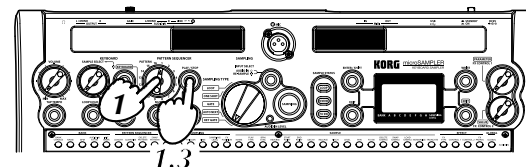

Reference guide

Banks

Each bank contains a tempo parameter, data for 16 pattern sequences, data for 36 samples, sample parameters, and effect parameters (see p.8 “Banks and memory”).

The microSAMPLER provides eight user banks that can be used to store your own data and settings.

Contents of one bank

Tempo	—
Pattern Sequence Data	16 patterns
Sample Data	36 samples
Sample Parameter	36 sets
Audio in FX SW	1 setting
FX Parameter	1 set

note You can use only one bank at a time.

1. Basic procedure

Here’s how to create settings such as BANK CHG (bank change), BANK.NAME (bank name), and BPM (tempo).

1. Press the [EDIT] button to make it blink.
If the [EDIT] button is not blinking, press it again until it blinks.
2. Use the [PARAMETER/FX CONTROL 1] knob to select the “BANK” page.
3. Press the [EDIT] button to make it light-up.
4. Use the [PARAMETER FX CONTROL 1] knob to select the desired bank parameter, and use the [VALUE/FX CONTROL 2] knob to set its value.

If you want to change banks (BANK CHG) or initialize the contents of a bank (INIT.BANK), proceed to the steps explained below.

5. Press the [ENTER/SHIFT] button.
6. When the display asks “SURE?”, press the [ENTER/SHIFT] button once again. If you decide not to execute the operation, press the [EXIT] button to return to step 4.

2. Bank parameters

BANK CHG (Bank Change)[TO A...H, TO ROM]

Here’s how to change banks.

When the bank change has been completed, the display will indicate “COMPLETE,” and will then return to the screen that had been shown prior to the bank change.

- ⚠ Do not use the microSAMPLER’s knobs, buttons, keyboard or turn off the keyboard while the bank is being switched.
- ⚠ If you’ve edited the contents of a bank, your changes will be lost if you turn off the power or switch to a different bank before saving the bank. If you want to keep the changes you made, you must write them (see p.41 “Saving (writing)”).

BANK.NAME (Bank Name)

You can specify a name for each bank.

In step 4 of the basic procedure, use the [PARAMETER/FX CONTROL 1] knob to select the character that you want to change, and use the [VALUE/FX CONTROL 2] knob to choose the desired character.

BPM[20.0...300.0]

This specifies the tempo.

You can also set this by using the tap tempo function (see p.18 “Using the Tap Tempo function”).

AUDIO IN FX SW [OFF, ON]

This specifies whether the effect will be applied to the sound from AUDIO IN.

OFF

The effect will not be applied to AUDIO IN.

ON

The effect will be applied to AUDIO IN.

- ⚠ If you’re sampling with FX POS (see p.24) set to “AUDIO IN,” the effect will be applied to AUDIO IN regardless of this setting.

INIT.BANK

This initializes the contents of the currently selected bank. The bank will be initialized, and the display will indicate “COMPLETE.”

note If you decide to cancel without initializing the bank, press the [EXIT] button.

Sampling

This section explains how to select the sampling source and capture a sample. The sampled sound is assigned to the key (C3...B5) you specify.

1. The number of simultaneously playable samples

The microSAMPLER is able to play up to 14 samples simultaneously.

note A sample whose sample parameter BPM SYNC (p.28) is set to “TIME.STRC” will require twice as many resources.

Number of simultaneously playable samples

Normally	14
When using Time Stretch	7

2. Maximum sampling time

The microSAMPLER’s maximum sampling time will depend on whether you’re sampling in monaural or in stereo. If all samples are monaural, you can sample a maximum of approximately 160 seconds in each bank.

note You can use the sampling parameter TIME (p.24) to check the remaining time.

3. Selecting the sampling type

On the microSAMPLER, you can choose one of five types of sampling. Use the [SAMPLING TYPE] switch to select the sampling type.

Sampling type	Explanation
LOOP	This mode is used for sampling entire phrases, loops or grooves; match the BPM to the tempo of the sample source for the best results.
ONE SHOT	This mode is best for sampling hits, effects, and other one-shot sounds where you want the entire sample to play even if you release the key immediately.
GATE	This mode is for more traditional instrument style sampling; the playback of the sample will be controlled by the keyboard – playback will stop when you release the key.
AUTO NEXT	This mode is used to automatically place multiple samples on successive keys. The sampling time and threshold level determine the duration and start of each sample. Match the BPM to the tempo of the sample source for the best results.
KEY GATE	Using this intuitive mode, pressing a key begins sampling and assigns the sample to the key. To cease sampling, simply release the key.

4. Setting the sampling parameters

Here’s how to specify the sampling rate, the monaural/stereo setting, the method by which sampling will begin, the sampling time, the sampling volume, and the effect position.

1. Press the [SAMPLING] button.
The [SAMPLING] button will blink green; you’re now in sampling setup mode.
2. Use the [PARAMETER/FX CONTROL 1] knob to select the desired sampling parameter, and use the [VALUE/FX CONTROL 2] knob to specify the value of that parameter.

note The sampling parameters can also be set from the [EDIT] “SAMPLING” page.

RATE [48K, 24K, 12K, 6K]

This specifies the sampling rate.

Higher values will provide better audio quality.

MONO/ST [MONO/STEREO]

This selects either monaural or stereo sampling.

This parameter is related to the global parameter AUDIO IN setting and also to the AUDIO IN [☺]/LINE] switch setting.

When the [INPUT SELECT] button indicates AUDIO IN

Global [AUDIO IN]	[☺]/LINE] switch	The sound that's sampled		
		MONO	STEREO	
			L	R
L/MONO	LINE	[L/MONO]	[L/MONO]	[L/MONO]
L/MONO	☺	[☺ MIC]	[☺ MIC]	[☺ MIC]
STEREO	LINE	[L] + [R]	[L/MONO]	[R]
STEREO	☺	[☺ MIC]	[☺ MIC]	[☺ MIC]

When the [INPUT SELECT] button indicates RE-SAMPLE

MONO

The stereo output mixed to monaural will be resampled in mono.

STEREO

Sample in stereo.

 You can't change the stereo/mono setting of a sample. You must specify the stereo/mono setting before you start sampling.

TRIGGER [SMPL SW, NOTE ON, THRE 01...10, KEY GATE]

This selects how sampling will be initiated.

SMPL SW (Sampling SW)

From sampling setup mode, press the [SAMPLING] button to begin sampling.

NOTE ON

From sampling-setup mode, press the [SAMPLING] button to enter sampling-standby mode; sampling will begin when you play the keyboard.

THRE 01...10 (Threshold 1...10)

From sampling-setup mode, press the [SAMPLING] button to enter sampling-standby mode; sampling will begin automatically when the signal exceeds the audio level you specified for Threshold 1...10.

This is convenient when you're sampling while playing another instrument, or when you want to avoid capturing the sound of the microSAMPLER being operated (e.g., the sound of a button being pressed).

 The cursor will momentarily blink when the specified audio level is exceeded while in the sampling-standby mode.

KEY GATE

This will be specified automatically if SAMPLING TYPE is set to "KEY GATE."

 If SAMPLING TYPE is set to "AUTO NEXT," settings other than THRE 01...10 cannot be selected.

TIME (Sampling Time) [1/64...8/1, 0.1...159.7 sec (at 48K)]

This specifies the sampling time. Values [1/64 through 8/1] are divisions of the beat, as determined by the current BPM setting. Values [0.1 through 159.7] are given in seconds. For Loop and Auto Next sampling, set the microSAMPLER's BPM to match the tempo of the sample source before sampling. Immediately after the power is turned on, the display will indicate the available sampling time. Once you've sampled, the new remaining time will be shown. You can specify the sampling time with this remaining time as the maximum.

LEVEL (Sampling Level) [-INF dB...+12.0 dB]

This adjusts the level for sampling.

From sampling setup mode, adjust the level so that the sampling level meter's clip indication does not light.

FX POS (Fx Position) [MST FX, AUDIO IN]

This specifies the position of the effect when sampling.

MST FX (Master FX)

Choose this if you want to resample with an effect applied to the sample. When you're not performing a sampling operation, the effect will operate as MST FX (Master FX) regardless of this setting.

AUDIO IN

Choose this if you want to sample from AUDIO IN with an effect applied.

This setting applies only in sampling-setup, sampling-standby, and during sampling.

If you choose the "AUDIO IN" setting, set the effect parameters from sampling-setup mode.

 The effect sound may be interrupted if you enter sampling-setup mode when FX POS is set to "AUDIO IN," or if you switch the FX POS setting while in sampling-setup mode.

5. Sampling using Loop, One Shot, or Gate

1. Use the [SAMPLING TYPE] switch to select “LOOP,” “ONE SHOT,” or “GATE.”
2. Use the [INPUT SELECT] button to select the sampling source. (ⓘp.17 “What is the “sampling source”?”)
3. Press the [SAMPLING] button.
The [SAMPLING] button will blink green, and you’ll be in sampling-setup mode.
4. Set the sampling parameters. (ⓘp.23 “4. Setting the sampling parameters”)
note If you set the BPM (ⓘp.22) to specify the tempo of the sampling source before you sample, you’ll be able to specify the sampling time as a note length, or you can play back in synchronization with the tempo (BPM SYNC).
5. Press the key to which you want to assign the sample data.
The corresponding key LED will blink.
6. Press the [SAMPLING] button to make it blink green.
Sampling will begin as you specified by the TRIGGER setting, and the [SAMPLING] button will light-up red.
note If the TRIGGER setting is “NOTE ON” or “THRE 01...10,” the [SAMPLING] button will blink orange (sampling-standby mode). At this time, sampling will begin according to the respective TRIGGER setting. When sampling begins, the [SAMPLING] button will light red.
7. When the duration you specified for SAMPLING TIME has elapsed, sampling will stop automatically.
If desired, you can press the [SAMPLING] button or [EXIT] button to stop sampling before the specified SAMPLING TIME has elapsed.

6. Sampling using Auto Next

Sample parameter values automatically set when using “AUTO NEXT”

Sample parameter	Automatically-set value
PLAY.TYPE (ⓘp.28)	LOOP OFF
DECAY (ⓘp.29)	127
RELEASE (ⓘp.29)	127

1. Use the [SAMPLING TYPE] switch to select “AUTO NEXT.”
2. Use the [INPUT SELECT] button to select “AUDIO IN.”
3. Press the [SAMPLING] button.
The [SAMPLING] button will blink green, and you’ll be in sampling-setup mode.
4. Set the sampling parameter TRIGGER, and other sampling parameters as necessary. (ⓘp.23 “4. Setting the sampling parameters”)
5. Press the key to which you want to assign the sample data.
Its key LED will blink. The sample you capture will be assigned to this key.

Selecting multiple keys

“AUTO NEXT” allows you to select multiple keys to which the sample data will be assigned.

Press each key to which you want to assign sample data. If you press one of the selected keys once again, its key LED will go dark, and it will be removed from the group of keys to which a sample will be assigned.

6. When you’ve finished setting the sampling parameters, press the [SAMPLING] button. The [SAMPLING] button will blink orange, and the microSAMPLER will wait for audio signal input. When the input exceeds the TRIGGER (ⓘp.24) THRESHOLD setting, sampling will begin.

Selecting multiple keys

If you’ve set the microKORG to sample on multiple keys, sampling will begin with the left-most of the selected keys. When the specified TIME (ⓘp.24 “TIME (Sampling Time)”) has elapsed, sampling on the first key will end, and the next key will be armed for sampling. Once the input again exceeds the TRIGGER (ⓘp.24) THRESHOLD, sampling will begin on the next key you had selected for sampling.

When sampling has been completed all the way to the right-most of the keys selected for sampling, sampling will continue from the left-most of the keys selected for sampling.

7. When you want to stop sampling, press the [SAMPLING] button or the [EXIT] button.

Sampling will end, and the [SAMPLING] button will go dark.

7. Sampling using Key Gate

Sample parameter values automatically set when using "KEY GATE"

Sample parameter	Automatically-set value
PLAY.TYPE (☞p.28)	LOOP OFF
DECAY (☞p.29)	127
RELEASE (☞p.29)	0

1. Use the [SAMPLING TYPE] switch to select "KEY GATE."
2. Use the [INPUT SELECT] button to select "AUDIO IN."
 - note** If you're using "KEY GATE," and want to play samples from the keyboard and resample your performance, refer to "8. Resampling" (☞p.26).
3. Press the [SAMPLING] button.

The [SAMPLING] button will blink green, and you'll be in sampling-setup mode.
4. Set the sampling parameters (☞p.23), and press the [SAMPLING] button.

The [SAMPLING] button will blink orange; the microSAMPLER is in sampling-standby mode.
5. Press the key to which you want to assign the sample; sampling will start.

While you hold down a key, the key LED and the [SAMPLING] button will light-up red, and sampling will occur.

Sampling will occur for each key whose key LED is blinking.

When the specified TIME (☞p.24) is reached, sampling will end automatically and the microSAMPLER will be in sampling-standby mode.

The microSAMPLER will also enter sampling-standby mode if you release the key before the specified TIME (☞p.24) is reached.
6. Press the [SAMPLING] button or [EXIT] button to stop sampling.

8. Resampling

Resampling is the process of directly sampling the sound that's being played by the microSAMPLER. By resampling, you can create a sample that mixes multiple samples, or create a new sample that contains an existing sample processed by an effect.

note The sample parameter LEVEL will initially be set to "+12.0 dB" for a resampled sample.

Resampling a performance on the microSAMPLER's keyboard

1. Use the [SAMPLING TYPE] switch to select the desired sampling type.
2. Use the [INPUT SELECT] button to choose "RE-SAMPLE," making the LED light.
3. Press the [SAMPLING] button.

The [SAMPLING] button will blink green, and you'll be in sampling-setup mode. If the keyboard had been in Keyboard mode, it will automatically switch to Sample mode.
4. Select the current sample (☞p.18) by pressing the key to which you want to assign the sample.
 - note** Since you'll use the microSAMPLER's keyboard to switch the key to which the sample will be assigned, resampling with "KEY GATE" means that you'll have to play the samples either by using the pattern sequencer or by receiving note-on messages from a MIDI device.
5. Make settings for the sampling parameters.
6. When you've finished setting the sampling parameters, press the [SAMPLING] button. The [SAMPLING] button will blink orange, indicating sampling-standby mode.
 - note** At this point, it's suggested to set the sampling parameter TRIGGER to "NOTE ON" so that sampling will start automatically when you play the keyboard.
7. Start sampling as specified by the TRIGGER setting.

The [SAMPLING] button will light-up red, and the key LED will change from blinking to steadily lit.
8. When you want to stop sampling, press the [SAMPLING] button or [EXIT] button.

Sampling will stop, and the key LED where the sample is assigned will blink.

Playing samples

On the microSAMPLER, you'll use the keyboard to play samples.

The microSAMPLER's keyboard can operate in one of two modes: Sample mode or Keyboard mode.

For an explanation of each mode, refer to "2. Playing samples" (p.15).

1. Loop playback

If the sample is set to LOOP ON, it will continue playing even after you take your finger off the key to which that sample is assigned.

1. Hold down the [LOOP HOLD] button, and press a key to which the sample set to LOOP ON is assigned.

When the sample plays, it will be held so that playback will continue even after you take your finger off the key.

2. To cancel the Hold status, press the [LOOP HOLD] button once again. Playback will stop, and the note will turn off.

Holding multiple samples

Hold down the [LOOP HOLD] button and press the keys that you want to hold. If a key is already being held, and you want to add the samples of other keys to the currently-playing sample, hold down the [LOOP HOLD] button and press the keys for the samples you want to add.

Alternatively, you can hold down the keys that you want to hold and then press the [LOOP HOLD] button.

Defeating the Hold status of a playing sample

When multiple samples are being held, and you want to defeat the Hold status for just one of the currently-playing samples, hold down the [LOOP HOLD] button and press the key of the sample you want to cancel. Hold will be cancelled for that key, and playback will stop.

Editing a sample

You can modify each sample in various ways, such as by specifying how it will play. This section explains how to edit the sample parameters, and describes what each parameter does.

1. Procedure

1. Press the [SAMPLE] button.
The microSAMPLER will switch to Sample mode.
2. Press the key to which the sample you want to edit is assigned; the key LED will blink.

This key will be the current sample (p.18).

note If the microSAMPLER is in Keyboard mode, the sample that you select using the [SAMPLE SELECT] knob will be the sample that is edited. The key LED of the sample to be edited will blink.

3. Press the [EDIT] button to make it blink.
If the [EDIT] button does not blink, press it again to make it blink.
4. Use the [PARAMETER/FX CONTROL 1] knob to select the "SAMPLE" page.
5. Press the [EDIT] button to make it light-up.
The microSAMPLER will be in sample edit mode, allowing you to edit the parameters. Select the sample that you want to edit.
6. Use the [PARAMETER/FX CONTROL 1] knob to select a parameter, and the [VALUE/FX CONTROL 2] knob to edit that parameter's value.
7. When you're finished editing, press the [EDIT] button to make it go dark.

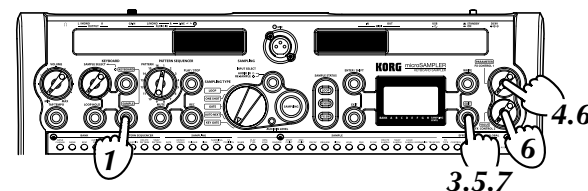

2. Sample parameters

SMPL.NAME (Sample Name)

This lets you name the sample. Use the [PARAMETER/FX CONTROL 1] knob to move the cursor to the character that you want to change, and use the [VALUE/FX CONTROL 2] knob to change the character.

PLAY.TYPE[LOOP OFF, LOOP ON]

This specifies whether playback will repeat after the sample has played to its end point.

note You can also use the [LOOP] button to change this setting.

note When playing back samples that have been recorded in [ONE SHOT] sample type and [PLAY.TYPE] is set to [LOOP OFF], the sample will play to the end once triggered regardless of whether the key is held or released. When [PLAY.TYPE] is set to [LOOP ON], the sample will continue looping until the key is released. When you release the key, playback of the sample will stop immediately.

LOOP OFF

The sample will play to its end point, and stop (one-shot playback).

LOOP ON

After the sample has played to its end point, playback will continue from the start point.

BPM SYNC[SYNC OFF, TIME.STRC, PITCH.CHG]

This lets you play the sample at the current bank tempo, rather than at the tempo at the time the sample was recorded (Original BPM).

SYNC OFF

The sample will not synchronize to the tempo.

TIME.STRC (Time Stretch)

Choose this if you want the sample playback length to match the current bank tempo without changing the sample's pitch.

note Selecting "TIME.STRC" will limit the number of notes that can be played simultaneously.

PITCH.CHG (Pitch Change)

Choose this if you want the sample playback length to match the current bank tempo by changing the sample's pitch.

In Keyboard mode, all keys will be fixed at the pitch of the sample assigned to the C4 key, so this parameter will have no effect.

REVERSE [OFF, ON]

If this is on, the sample will play backward. You can change this during playback.

note You can also use the [REVERSE] button to change this setting.

OFF

The sample will play in the normal direction.

ON

The sample will play backward.

ST POINT (Start Point)

This adjusts the sample's playback start point.

On the microSAMPLER, you can adjust the start point in terms of a percentage (%), a number of beats, or a numerical value.

As a percentage [000...100%]

You can specify the sample playback start point as a percentage of the overall length. For example if you specify "050%", playback will start at the mid-point of the sample, as shown below.

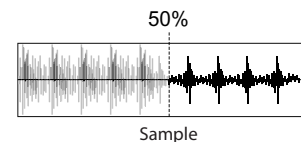

As a number of beats [000...568 BEAT]

You can specify the sample playback start point as a number of beats.

■ If you're using a sample that's 8 beats at BPM = 120

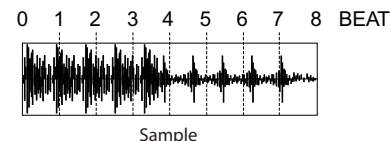

As a numerical value

You can specify the sample playback start point as a numerical value. The value can be adjusted in groups of three digits.

Use the [PARAMETER/FX CONTROL 1] knob to select the three-digit group that you want to adjust. The selected three digits are indicated by

the bar below the number. Use the [VALUE/FX CONTROL 2] knob to adjust the value.

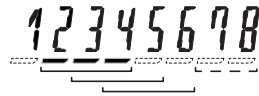

note The ones and tens place can be adjusted in two-digit groups.

END.POINT

This adjusts the point at which the sample will stop playing.

As for the start point, you can adjust this in terms of a percentage (%), a number of beats, or a numerical value.

! In some cases, the pitch may not rise above a certain level as you narrow the interval between the start point and end point.

DECAY[0...127]

This specifies the time from when the key is pressed to start playback until when the sound disappears.

The way in which the sound decays will depend on the RELEASE setting.

If DECAY is set to a value other than "127," the volume will continue decreasing as the sample plays, regardless of the LOOP setting.

For example with the following settings, the sample playback volume will change as follows.

■ With the settings DECAY = "127," RELEASE = "0"

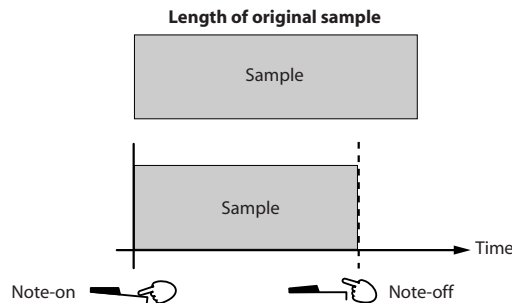

If DECAY is set to "127," the volume will not decrease until you release the key.

For example with the following settings, the sample playback volume will change as follows.

■ With the settings DECAY = "64," RELEASE = "0"

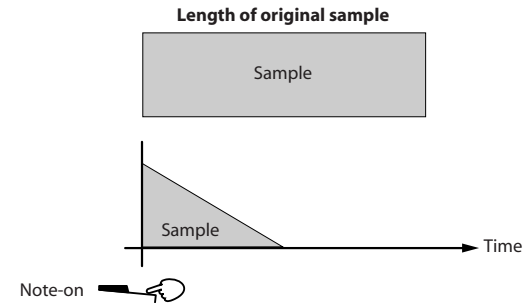

If DECAY is set to "126" or lower, the volume will decrease even if you continue holding the key.

RELEASE [0...127]

This specifies the time from when you release the key until when the sound disappears.

note The way in which the sound decays will depend on the DECAY setting.

When PLAY.TYPE is "LOOP OFF" (for one-shot samples)

■ With the settings DECAY = "127," RELEASE = "127"

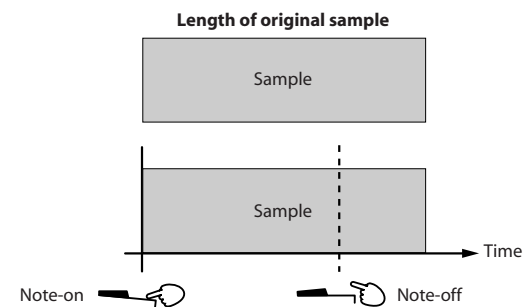

If RELEASE is set to "127," the sample will play to its end without decreasing in volume even if you release the key.

■ With the settings DECAFY = "127," RELEASE = "64"

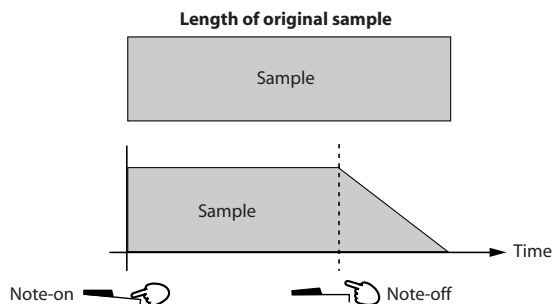

If RELEASE is set to "126" or lower, this specifies the time from when you press the key to start the sound until when the sound disappears.

note If PLAY.TYPE is "LOOP ON," the RELEASE parameter does nothing.

SEMITONE [-24...+24]

This adjusts the playback pitch in steps of a semitone (100 cents).

note If BPM SYNC is set to "TIME.STRC," the change specified by the SEMITONE and TUNE parameters will be added.

! If BPM SYNC is set to "PITCH.CHG," you won't be able to set this parameter.

TUNE [-24...+24]

This adjusts the playback pitch in steps of one cent.

note If BPM SYNC is set to "TIME.STRC," the change specified by the SEMITONE and TUNE parameters will be added.

! If BPM SYNC is set to "PITCH.CHG," you won't be able to set this parameter.

LEVEL [-INF dB...+12.0 dB]

This specifies the playback volume.

The microSAMPLER is designed with a 12 dB margin relative to the maximum digital amplitude, making it unlikely that the sound will be distorted by exceeding the maximum digital amplitude.

When one sample containing data close to the maximum amplitude is played back, and the sample parameter LEVEL is "0 dB," there will be 12 dB of margin relative to the maximum digital amplitude. If this parameter is set to "+12 dB," the sample will be played at its actual volume without this margin.

■ When VEL INT is "+0"

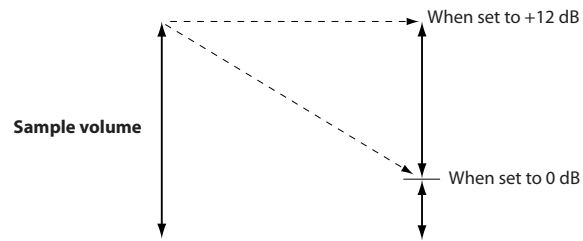

For a sample that was captured via Input Source = Audio In, the sample parameter LEVEL will automatically be set to "0 dB."

For a sample that was captured via Input Source = ReSample, the sample parameter LEVEL will automatically be set to "+12 dB" in order to reproduce the volume at the time of sampling.

In this way, the LEVEL parameter specifies the volume at which the sample will play back.

If the sample data is close to the maximum amplitude, setting this parameter to "+12 dB" will make distortion more likely if multiple samples are played simultaneously or if effects are used; in such cases, you should lower the LEVEL parameter.

VEL INT (Velocity Intensity) [-63...+63]

This specifies how the volume will be affected by the velocity used when playing the key. With higher settings of this parameter, variations in your playing dynamics will have a greater effect on the output volume.

PAN [L63...CNT...R63]

This specifies the panning used when the sample is played. For a stereo sample, this specifies the left/right balance.

note When a monaural sample is resampled in monaural, the PAN setting will affect the volume of the resampled sample.

FX SW [OFF, ON]

This specifies whether the effects will be applied during playback.

note You can also use the [FX SW] to change this setting.

OFF

The selected sample will be played without an effect.

ON

The selected sample will be played with an effect.

ORIG BPM (Original BPM)

This indicates the tempo of the sample. For a sample that was captured by the microSAMPLER, the tempo specified at the time of sampling (see p. 18 “2. Setting the tempo”) is stored as the original tempo.

ORIG.RATE (Original Rate)

This indicates the sampling rate of the sample. For a sample that was captured by the microSAMPLER, the sampling rate specified at the time of sampling (see p. 23 “RATE”) is stored as the original sampling rate.

3. DELETE SAMPLE**DEL SMPL[DEST ALL, DEST 01...36]**

This lets you delete unwanted samples from the selected bank.

1. Press the [EDIT] button to make it blink.
If the [EDIT] button is not blinking, press it again until it blinks.
2. Use the [PARAMETER/FX CONTROL 1] knob to select the “SAMPLE” page.
3. Press the [EDIT] button to make it light-up.
4. Use the [PARAMETER/FX CONTROL 1] knob to select the “DEL SMPL” page.
5. Use the [VALUE/FX CONTROL 2] knob to select the sample that you want to delete.
You can choose “DEST ALL” or “DEST 1–36.”
If you select “ALL,” all samples of the selected bank will be deleted.
6. Press the [ENTER/SHIFT] button.
7. When the display asks “SURE?,” press the [ENTER/SHIFT] button once again to confirm. If you decide to cancel, press the [EXIT] button to return to step 5.

When the sample data has been deleted, the screen will indicate “COMPLETE.”

4. SWAP SAMPLE**SWAP.SMPL[DEST 01...36]**

This lets you exchange the current sample (see p. 18) of the selected bank with the sample number that you specify.

1. Press the [EDIT] button to make it blink.
If the [EDIT] button is not blinking, press it again until it blinks.
2. Use the [PARAMETER/FX CONTROL 1] knob to select the “SAMPLE” page.
3. Press the [EDIT] button to make it light-up.
4. Use the [PARAMETER/FX CONTROL 1] knob to select the “SWAP.SMPL” page.
5. Use the [VALUE/FX CONTROL 2] knob to select the number of the sample that you want to exchange with the current sample (see p. 18).
6. Press the [ENTER/SHIFT] button.
7. When the display asks “SURE?,” press the [ENTER/SHIFT] button once again to confirm. If you decide to cancel, press the [EXIT] button to return to step 5.

When the sample data has been exchanged, the screen will indicate “COMPLETE.”



5. LOAD SAMPLE

LOAD.SMPL[FROM.BNK.A...H, R (ROM)]

LOAD.SMPL[FROM.S.AL, S.01...S.36]

This loads sample data from the specified bank into the current sample that's selected.

1. Press the [EDIT] button to make it blink.
If the [EDIT] button is not blinking, press it again until it blinks.
2. Use the [PARAMETER/FX CONTROL 1] knob to select the "SAMPLE" page.
3. Press the [EDIT] button to make it light-up.
4. Use the [PARAMETER/FX CONTROL 1] knob to select the "LOAD.SMPL" page.
5. Use the [VALUE/FX CONTROL 2] knob to select the bank that contains the sample you want to load.
6. Press the [ENTER/SHIFT] button.

note If there are no samples in the bank you selected, the display will indicate "ERROR NO.SAMPLE." Press the [EXIT] button to return to step 5, and select a different bank.

7. Use the [VALUE/FX CONTROL 2] knob to select the sample that you want to load.

FROM S.AL

All samples will be selected.

FROM S.01...S.36

Select one of the 36 samples.

note If no sample exists for the number, an "*" is shown before the sample number instead of "S."

8. Press the [ENTER/SHIFT] button.
9. When the display asks "SURE?," press the [ENTER/SHIFT] button once again to confirm. If you decide to cancel, press the [EXIT] button to return to step 7.

When the sample data has been loaded, the screen will indicate "COMPLETE."

⚠ Do not operate the microSAMPLER's knobs, buttons, or keyboard while this operation is being executed. Never turn off the power during this time.

6. NORMALIZE

NORMALIZ (Normalize)[-6...+6 dB]

This amplifies the sample's level as much as possible without causing distortion, and then applies the specified gain to the current sample (p. 18) of the selected bank.

1. Press the [EDIT] button to make it blink.
If the [EDIT] button is not blinking, press it again until it blinks.
2. Use the [PARAMETER/FX CONTROL 1] knob to select the "SAMPLE" page.
3. Press the [EDIT] button to make it light-up.
4. Use the [PARAMETER/FX CONTROL 1] knob to select the "NORMALIZ" page.
5. Use the [VALUE/FX CONTROL 2] knob to specify the gain.
6. Press the [ENTER/SHIFT] button.
7. When the display asks "SURE?," press the [ENTER/SHIFT] button once again to confirm. If you decide to cancel, press the [EXIT] button to return to step 5.

When the sample data has been normalized, the screen will indicate "COMPLETE."

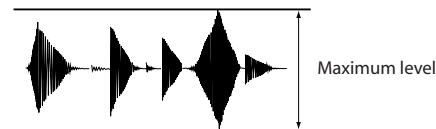

⚠ It is not possible to restore the sample to its previous state after performing the Normalize operation. If you save the sample (p. 41 "Saving (writing)") before normalizing it, you'll be able to recover the original data by executing LOAD.SAMPLE (p. 32 "5. LOAD SAMPLE") if the results are not what you expected.

7. TRUNCATE

TRUNCATE

For the current sample (p.18) of the selected bank, this operation cuts the portions before the start point and after the end point.

1. Press the [EDIT] button to make it blink.
If the [EDIT] button is not blinking, press it several times until it blinks.
2. Use the [PARAMETER/FX CONTROL 1] knob to select the "SAMPLE" page.
3. Press the [EDIT] button to make it light.
4. Use the [PARAMETER/FX CONTROL 1] knob to select the "TRUNCATE" page.
5. Press the [ENTER/SHIFT] button.
6. When the display asks "SURE?," press the [ENTER/SHIFT] button once again to confirm. If you decide to cancel, press the [EXIT] button to return to step 5.

When the sample data has been truncated, the screen will indicate "COMPLETE."

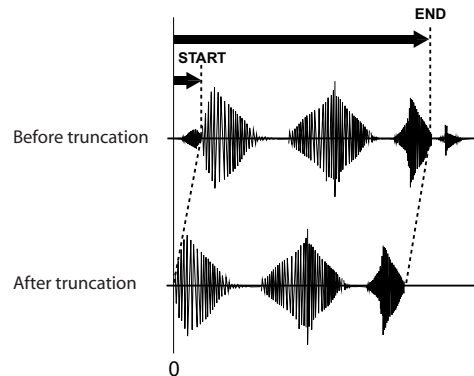

Pattern sequencer

The pattern sequencer can record and play back trigger data in Keyboard mode and Sample mode.

1. About patterns

Each bank holds sixteen patterns. Each pattern can be 1–99 measures long, and one bank can contain a total of approximately 64,000 notes (a pattern can be up to approximately 16,000 notes).

You can use patterns to create rhythm patterns by combining phrases you've sampled, or to create simple songs.

2. Pattern recording method

Patterns are recorded using "realtime recording," which records your performance just as you play it. When you record into a pattern that already contains data, the additional performance will be combined (overdubbed) together with the existing material.

3. Recording a pattern

1. Press the [REC] button so that the microSAMPLER is in standby mode. The [PLAY/STOP] button and [REC] button will blink.
2. Use the [PATTERN] dial to select the pattern (1–16) that you want to record.
3. Use the [PARAMETER/CONTROL 1] knob to select the pattern sequencer settings page, and use the [VALUE/CONTROL 2] knob to specify the value.
4. When you've finished making pattern sequencer settings, press the [PLAY/STOP] button or the [REC] button to start recording.
5. Press the [PLAY/STOP] button to stop recording and playback.

If you instead press the [REC] button at this time, recording will stop but the pattern will continue playing. To stop playback, press the [PLAY/STOP] button.

 You cannot operate with [LOOP HOLD] button.

 You can also make pattern sequencer settings by pressing the [EDIT] button to access "PTRN SEQ."

LENGTH[01...99]

This specifies the length of the pattern to be recorded, in units of measures.

KB.MD.SMPL (Keyboard Mode Sample No.) [SMPL 01...36]

For each pattern, this specifies the sample number that will be played in Keyboard mode.

QUANTIZE[“OFF,” 8, 8 TRI, 16, 16TRI, 32]

When you record a pattern by playing the keyboard, it is sometimes difficult to avoid inaccuracies in your timing. The quantize function automatically corrects these inaccuracies, making the timing perfect. By specifying the desired quantize value, you can make the notes line up with precise 8th note or 16th note timing intervals.

Parameter value	Meaning
“OFF”	Quantization will not be applied
8	Timing will be adjusted to 8th notes
8 TRI	Timing will be adjusted to 8th note triplets
16	Timing will be adjusted to 16th notes
16 TRI	Timing will be adjusted to 16th note triplets
32	Timing will be adjusted to 32nd notes

4. Playing a pattern

1. Use the [PATTERN] dial to select the pattern (1–16) that you want to play.
2. Press the [PLAY/STOP] button to play the pattern.
3. Press the [PLAY/STOP] button once again to stop playback.

Using the mute function

When playing back a performance recorded in the pattern sequencer, you can mute the samples of specific keys so that they will not be heard.

1. While holding down the “MUTE” button, press the key that you want to mute. You can mute multiple samples if desired.

The [MUTE] button will light if any keys are muted.

The sample of the key you pressed will be muted; when the pattern sequencer plays, the sample of that key will not be heard.

note Patterns can be recorded in [SAMPLE] and [KEYBOARD] modes, ensure that you have selected the appropriate mode when using the mute function.

Canceling the mute function

1. While holding down the [MUTE] button, press the key that you want to un-mute, making the button go dark. The sample of the key you pressed will be un-muted; when the pattern sequencer plays, the sample of that key will be heard.

5. Recording additional material into the pattern that’s playing

You can record an additional performance from the keyboard into the pattern that’s playing.

1. While the pattern is playing, press the [REC] button.
The [REC] button will blink, and the microSAMPLER will be in pattern record standby mode.
2. Press the [REC] button once again.
Recording will begin. Play the keys that you want to add.
3. To stop recording without stopping playback, press the [REC] button.
Recording will end, but the pattern will continue playing.
4. Once again press the [PLAY/STOP] button to stop playback.

6. Editing a pattern

Here’s how to delete unwanted key data from a recorded performance, so that the corresponding samples will not be triggered.

1. Press the [REC] button twice to make it light-up; pattern recording will start.
2. While holding down the [ENTER/SHIFT] button, press the key corresponding to the unwanted data.

DEL PTRN (Delete Pattern)[DEST ALL, DEST 01...16]

This deletes the pattern of the specified number.

1. Press the [EDIT] button to make it blink.
If the [EDIT] button is not blinking, press it again until it blinks.
2. Use the [PARAMETER/FX CONTROL 1] knob to select the “PTRN SEQ” page.
3. Press the [EDIT] button to make it light-up.

4. Use the [PARAMETER/FX CONTROL 1] knob to select the “DEL PTRN” page.
5. Use the [VALUE/FX CONTROL 2] knob to select the pattern that you want to delete.
6. Press the [ENTER/SHIFT] button.
7. When the display asks “SURE?,” press the [ENTER/SHIFT] button once again to confirm. If you decide to cancel, press the [EXIT] button to return to step 5.

The pattern will be deleted, and the screen will indicate “COMPLETE.”

SWAP.PTRN (Swap Pattern)[DEST 01...16]

This exchanges the selected pattern with the pattern you specify.

1. Press the [EDIT] button to make it blink.
If the [EDIT] button is not blinking, press it again until it blinks.
2. Use the [PARAMETER/FX CONTROL 1] knob to select the “PTRN SEQ” page.
3. Press the [EDIT] button to make it light-up.
4. Use the [PARAMETER/FX CONTROL 1] knob to select the “SWAP.PTRN” page.
5. Use the [VALUE/FX CONTROL 2] knob to select the pattern that you want to swap.
6. Press the [ENTER/SHIFT] button.
7. When the display asks “SURE?,” press the [ENTER/SHIFT] button once again to confirm. If you decide to cancel, press the [EXIT] button to return to step 5.

The patterns will be exchanged, and the screen will indicate “COMPLETE.”

LOAD.PTRN (Load Pattern)[FROM.BNK.A...H, R (ROM)]

LOAD.PTRN (Load Pattern)[FROM.PT.AL, PT.01...16]

This loads a pattern from the specified bank into the currently selected pattern.

1. Press the [EDIT] button to make it blink.
If the [EDIT] button is not blinking, press it several times until it blinks.
2. Use the [PARAMETER/FX CONTROL 1] knob to select the “PTRN SEQ” page.
3. Press the [EDIT] button to make it light-up.

4. Use the [PARAMETER/FX CONTROL 1] knob to select the “LOAD.PTRN” page.
5. Use the [VALUE/FX CONTROL 2] knob to select the bank containing the pattern you want to load.
6. Press the [ENTER/SHIFT] button.

note If there are no patterns in the bank, the display will indicate “ERROR NO.SAMPLE.” Press the [EXIT] button to return to step 5, and select a different bank.

7. Use the [VALUE/FX CONTROL 2] knob to select the pattern you want to load.
8. Press the [ENTER/SHIFT] button.
9. When the display asks “SURE?,” press the [ENTER/SHIFT] button once again to confirm. If you decide to cancel, press the [EXIT] button to return to step 7.

The pattern will be loaded.

 Do not use the microSAMPLER's knobs, buttons, or keyboard while this operation is in progress. Never turn off the power during this time.

About the effect processor

The microSAMPLER lets you choose one of twenty-one different types of full-digital effects. These effects are categorized as follows.

Filter and dynamics effects	Compressor, Filter, 4Band EQ, Distortion, Decimeter
Reverb and delay effects	Reverb, Delay, L/C/R Delay, Auto Panning Delay, Modulation Delay, Tape Echo
Pitch and modulation effects	Chorus, Flanger, Vibrato, Phaser, Tremolo, Ring Modulator, Grain Shifter, Pitch Shifter, Talking Modulator, Looper

1. Effect inputs and outputs

In the DRY/WET balance, the “DRY” signal (the direct sound unprocessed by the effect) will output the stereo input as stereo output without any processing. The way in which the WET signal (the signal processed by the effect) is output will depend on the type of effect; the three possibilities are shown below.

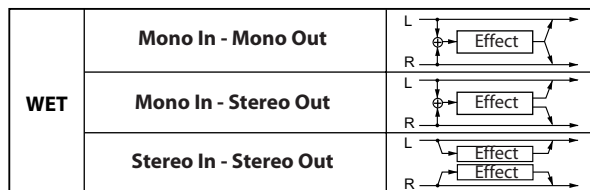

The block diagrams in the table above show the input/output configuration for each effect type.

In order to obtain the best audio quality, adjust the input level to the effect by using the sampling parameter LEVEL (p.24) and each effect’s TRIM parameter so that the level is as high as possible without clipping. Then use the effect’s DRY/WET balance and OUT.LEVEL setting to adjust the output level of the effect.

- Some effect types do not have TRIM, OUT.LEVEL, or DRY/WET parameters.
- There is no input level meter that indicates the input level to the effect. If the input level is insufficient, the signal/noise ratio will be poor. If the input level is excessive, clipping will occur.

2. Controlling effect parameters

You can use the front panel [PARAMETER/FX CONTROL 1] knob and [VALUE/FX CONTROL 2] knob to control effect parameters in realtime. The parameters assigned to these knobs can also be controlled from an external MIDI device.

Noise may be heard if a parameter to which a knob cannot be assigned is operated during playback.

note The parameters that can be assigned will depend on the effect that type you’re using.

note For details on how to assign a parameter to a knob, please refer to “1. Using an effect” (p.19).

3. About the delay time

TM RATIO (Time Ratio)

For delay effects, the actual delay time will be the delay time setting multiplied by the “TM RATIO” setting.

For example:

- If BPM SYNC: “OFF,” L DELAY: “800 ms,” R DELAY: “400 ms,” and TM RATIO: “50%,” the actual delay will be “400 ms” for the left channel and “200 ms” for the right channel.
- If BPM SYNC: “ON,” L DELAY: “♩1/4,” R DELAY: “♩1/8,” and TM RATIO: “50%,” the actual delay time will be “1/8” for the left channel and “1/16” for the right channel.

Delay time when BPM SYNC is off

If BPM SYNC is off, you can specify the delay time in msec (millisecond) units.

If the delay time multiplied by TM RATIO would exceed the allowable range of the setting, a “” symbol is shown at the right of the TM RATIO and delay time value, and the delay time will be the maximum allowable value.

Delay time when BPM SYNC is on

If BPM SYNC is on, the delay time will synchronize to the tempo you specified using the [TAP TEMPO] button or the "BPM" (⌘p.22) setting, or to external MIDI clock data. This is useful for live performances.

If BPM SYNC is on, you can specify the delay time as a note value.

For example:

- If BPM SYNC: "ON," TM RATIO: "100%," L DELAY: "♪ 1/8," and R DELAY: "♪. 3/16," the left channel delay time will be an 8th note and the right channel delay time will be a dotted 8th note.

⚠ If the delay time multiplied by TM RATIO would exceed the allowable range of the setting, a "⏸" symbol is shown at the right of the TM RATIO, and the delay time will be half the specified value. If half the specified value would still exceed the allowable range, the delay time will be 1/4th, 1/8th, 1/16th etc. of the specified value.

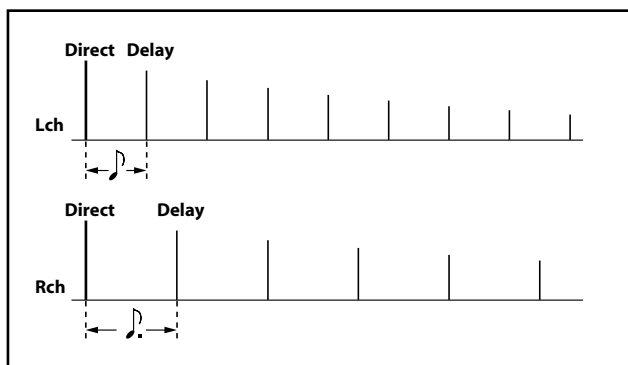

Global parameters

These parameters let you adjust settings such as metronome, MIDI channel, and memory protect.

Procedure

1. Press the [EDIT] button to make it blink.
If the [EDIT] button is not blinking, press it again until it blinks.
2. Use the [PARAMETER/FX CONTROL 1] knob to select the “GLOBAL” page.
3. Press the [EDIT] button to make it light.
Use the [PARAMETER/CONTROL 1] knob to select the desired global parameters, and make settings that apply to the entire microSAMPLER.

note The **GLOBAL** indicator will appear when you select the “GLOBAL” page.

Function and parameter list

METRONOME (Metronome) [“OFF,” REC 0, REC 1, REC 2, REC ON]

This specifies how the metronome will function. It’s convenient to use the metronome when you record into the pattern sequencer.

“OFF”

The metronome will not be heard.

Pattern sequencer recording will start without a count.

REC 0, 1, 2

Specify the number of measures before recording will begin.

When you press the [REC] button from the pattern sequencer record-standby mode, there will be a count for the specified number of measures at the current tempo, and then pattern sequencer recording will begin.

The metronome will be heard during recording.

With the REC 0 setting, pattern sequencer recording will start without a count.

ON

The metronome will be heard during pattern sequencer playback or recording.

Pattern sequencer recording will start without a count.

LCD.LIGHT (LCD backlight mode) [“OFF,” AUTO, ON]

This specifies the display backlight mode.

“OFF”

The backlight will be off.

AUTO

The backlight will illuminate when you operate a knob or press a button. After a time, the backlight will turn off.

ON

The backlight will remain on constantly.

PROTECT (Memory protect) [OFF, ON]

The memory protect setting lets you disable writing into memory, in order to keep data from being accidentally rewritten. If you want to save the data you’ve edited, you’ll need to turn memory protect off.

OFF

Samples and pattern sequences can be saved.

ON

Samples and pattern sequences cannot be saved.

AUDIO IN (Audio in mode) [L/MONO, STEREO]

This switches the audio input mode.

The input from the AUDIO IN [R] jack is enabled only if you select STEREO.

note If the rear panel AUDIO IN [⊙/LINE] switch is at “⊙”, the microSAMPLER will function as if this parameter were set to “L/MONO” even if you’ve selected STEREO (see p.24 “MONO/ST”).

note If you set this to “L/MONO,” the input from the AUDIO IN [L/MONO] jack and AUDIO IN [R] jack will be mixed and sampled in monaural if the rear panel AUDIO IN [⊙/LINE] switch is at “LINE” (see p.24 “MONO/ST”).

PTRN CHG (Pattern change mode) [PTRN END, BAR LINE]

This specifies the timing when the selected pattern will begin when you switch patterns while the pattern sequencer is playing.

PTRN.END

The newly selected pattern will start when the pattern that's currently playing has played to its end.

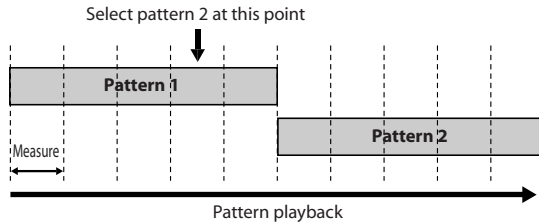

BAR LINE

The newly selected pattern will start when the pattern that's playing reaches the end of its current measure.

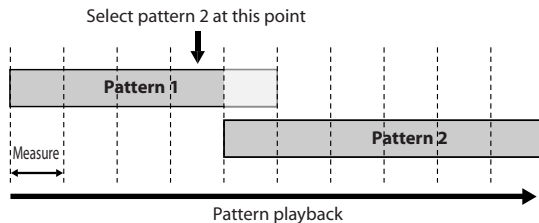

AUDIO IN LVL (Audio In Level) [+0 dB, +6 dB, +12 dB]

This specifies the output volume of the audio input signal when you play the right-most key in Sample mode (see p. 18 "Listening to the sound from the AUDIO IN jacks").

note This setting does not affect the volume of the input sound that you hear automatically when in sample-ready mode (see p. 18 "3. Recording a sample").

GLOBAL.CH (Global MIDI Channel) [1...16]

This specifies the MIDI channel used for Sample mode and for controlling the pattern sequencer.

KB.MIDI.CH (Keyboard MIDI Channel) [1...16]

This specifies the MIDI channel that MIDI messages such as note-on/off are received when in Keyboard mode.

LOCAL (MIDI Local Control) [OFF, ON]

This turns Local Control on/off.

OFF

The microSAMPLER's keyboard and controllers will be disconnected from its sound generator section.

When the microSAMPLER is connected to an external sequencer, this setting prevents the double triggering that would otherwise occur due to echo-back from your sequencer (performance data that is played on the microSAMPLER's keyboard and then re-transmitted from the sequencer back to the microSAMPLER).

ON

Choose this setting when using the microSAMPLER by itself.

MIDI.ROUT (MIDI Routing) [USB+MIDI, USB, MIDI]

This selects the connector(s) used to transmit and receive MIDI messages.

USB+MIDI

The MIDI connectors and USB connector will be used to transmit and receive MIDI messages. For reception, the MIDI messages from both MIDI and USB connectors are mixed, and the MIDI messages that were received later will be given priority. For transmission, the same MIDI messages will be transmitted from both MIDI and USB connectors.

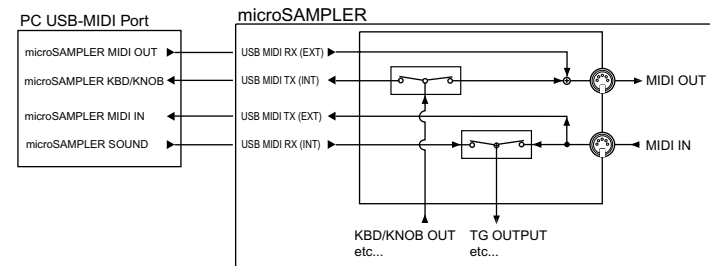

USB

Only the USB connector will be used to transmit and receive MIDI messages.

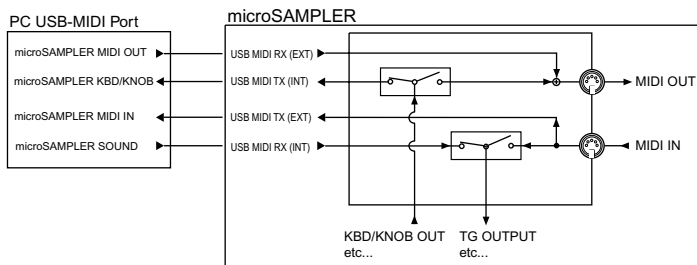

MIDI

Only the MIDI connectors will be used to transmit and receive MIDI messages.

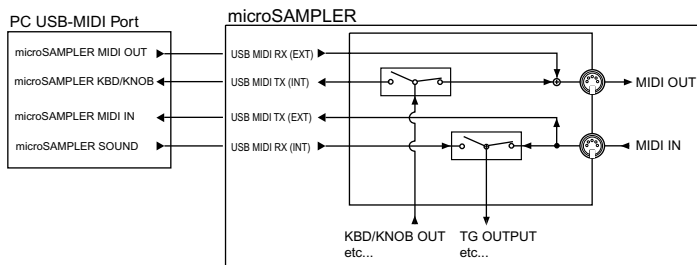

MIDI CLK (MIDI Clock) [AUTO, INT, EXT USB, EXT MIDI]

This specifies how the microSAMPLER will synchronize with a connected external MIDI device.

AUTO

If MIDI clock data is being received from an external MIDI device connected to the MIDI IN connector (or USB connector), the microSAMPLER will automatically operate as with the “EXT MIDI” (or “EXT USB”) setting. If no such data is being received, it will operate using the “INT” setting.

INT (Internal)

The microSAMPLER’s pattern sequencer etc. will operate according to its own internal clock setting (specified by the [TAP TEMPO] button or the tempo parameter). Choose this setting if you’re using the microSAMPLER as the master device to control an external MIDI device.

EXT USB (External USB)

The microSAMPLER’s pattern sequencer etc. will operate according to MIDI clock data received from the computer that’s connected to the USB port.

EXT MIDI (External MIDI)

The microSAMPLER’s pattern sequencer etc. will operate according to MIDI clock data received from an external MIDI device that’s connected to the MIDI IN connector.

note For details on synchronization-related settings for your external MIDI device, refer to its owner’s manual.

STRT.TRIM (Start Point Auto Trimming) [OFF...200 msec]

END TRIM (End Point Auto Trimming) [OFF...100 msec]

When you sample with the mic, the unwanted noises produced by pressing the microSAMPLER’s sampling button or keys to start or stop sampling can be automatically trimmed off by the length of time you specify with these two settings.

If you choose “OFF,” sampling will start or stop the instant you perform the operation.

note This setting is ignored if the rear panel AUDIO IN [☺]/[LINE] switch is set to “LINE.”

note The STRT.TRIM setting is ignored if the sampling parameter TRIGGER is set to “NOTE ON” or “THRE01...10.”

Saving (writing)

If you’ve edited a bank, captured or edited a sample, or created pattern sequencer data, this new data will be lost if you turn off the power or switch to a different bank without saving. You must save the data if you want to use it again.

 Do not use the microSAMPLER’s knobs, buttons, or keyboard while data is being saved, and never turn off the power during this time. The data may be lost if you do so.

 You can’t save data to the ROM bank.

1. Press the [WRITE] button to make it blink. The “WRITE” page will appear in the display.
2. Use the [PARAMETER/CONTROL 1] knob to select the data that you want to save (bank, sample, pattern, or global), and press the [WRITE] button to confirm your choice. If you select “GLOBAL,” the display will indicate “COMPLETE” when the data has been written, and you will return to the previous screen.

If you decide to cancel without writing, press the [EXIT] button.

3. If you select bank, sample, or pattern data, use the [VALUE/FX CONTROL 2] knob to specify the save-destination.

WRITE BANK [A...H]
Select the save-destination bank.

WRITE SAMPLE [All, SAMPLE 01...36]
Select all samples or a specific sample.

WRITE PATTERN [All, PTRN 01...16]
Select all patterns or a specific pattern.

4. To write the data, press the [WRITE] button.
When the data has been written, the display will indicate “COMPLETE” and you will return to the previous screen.

If you decide to cancel without writing, press the [EXIT] button.

 If the display indicates “ERROR” when you press the [WRITE] button, the memory protect setting is turned on. Press the [EXIT] button to cancel the Write operation, and then turn off memory protect (p.38 “PROTECT (Memory protect”).

MIDI guide

Using the microSAMPLER with other MIDI devices

MIDI stands for Musical Instrument Digital Interface, and is a world-wide standard for exchanging performance-related data between electronic musical instruments and computers.

When a MIDI device is connected to another MIDI device (or computer) via MIDI cables (or USB), the devices can exchange performance data even if they were made by different manufacturers.

The microSAMPLER's pattern sequencer and effect delay time can synchronize to MIDI clock data from an external MIDI sequencer.

note The "MIDI Implementation" including details on the MIDI exclusive format can be downloaded from the Korg website.

1. Connecting a MIDI device or computer

Controlling an external MIDI sound module from the microSAMPLER

If you want to use the microSAMPLER's keyboard, controllers, and pattern sequencer to play or control an external MIDI sound module, use a MIDI cable to connect the microSAMPLER's MIDI OUT connector to your external MIDI sound module's MIDI IN connector.

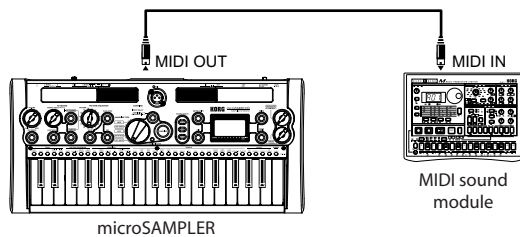

Controlling the microSAMPLER from an external MIDI device

If you want to use another MIDI keyboard or sequencer to play or control the microSAMPLER's sound generator, use a MIDI cable to connect your external MIDI device's MIDI OUT connector to the microSAMPLER's MIDI IN connector.

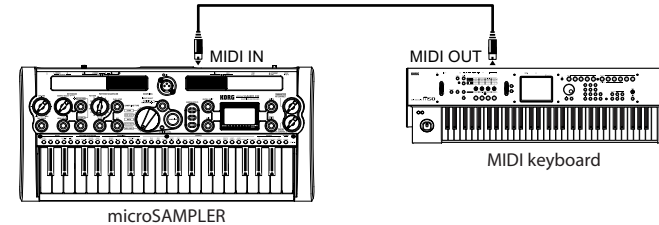

Connecting the microSAMPLER to a computer via USB

You can use a USB cable to connect the microSAMPLER directly to a computer that has a USB connector.

If you're using the editor/librarian software, you'll need to use the faster USB connection since a large amount of data will be transmitted and received.

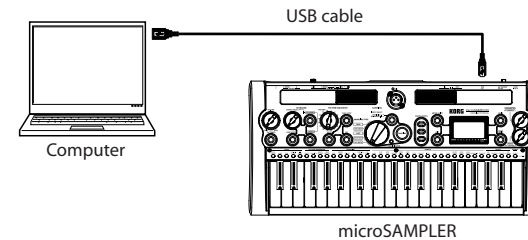

note In order to use a USB connection, the Korg USB-MIDI driver must be installed on your computer. Download the Korg USB-MIDI driver from the Korg website, and install it as directed by the accompanying documentation.

⚠ If either the MIDI connection or USB connection does not work correctly, check the "GLOBAL" page MIDI.ROUT setting (see p.39 "MIDI.ROUT (MIDI Routing)").

Connecting the microSAMPLER to an external MIDI sequencer or computer

If you want to record your keyboard performance from the microSAMPLER onto an external MIDI sequencer or computer (connected via a MIDI interface), and use the microSAMPLER to monitor or play back your recording, or if you want to use the microSAMPLER as an input keyboard and MIDI sound module, connect the microSAMPLER to the MIDI OUT and MIDI IN connectors of your external MIDI sequencer or computer.

⚠ Some MIDI interfaces may be unable to transmit and receive the microSAMPLER's MIDI exclusive messages.

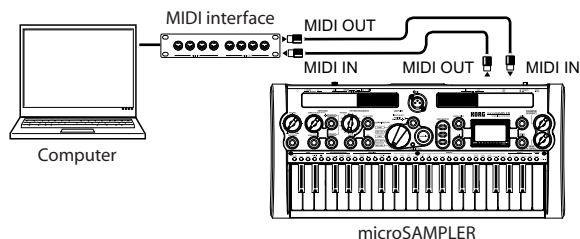

2. MIDI-related settings after connection

MIDI channel

In order to exchange data with a connected external MIDI device, the microSAMPLER's MIDI channel must match the external MIDI device's MIDI channel.

Setting the microSAMPLER's MIDI channel

Use the global parameters "GLOBAL.CH" (p.39) and "KB.MIDI.CH" (p.39) to set the channel.

MIDI Local setting when connected to an external MIDI sequencer or computer

If the microSAMPLER is connected to an external MIDI sequencer or computer, and the external MIDI sequencer or computer's Echo Back setting is on while the microSAMPLER's Local Control setting is also on, the perfor-

mance data produced when you play the microSAMPLER's keyboard will be transmitted to the external MIDI sequencer and then "echoed-back" to play the microSAMPLER, thus sounding each note twice. To prevent this, turn the microSAMPLER's Local Control setting off (p.39 "LOCAL (MIDI Local Control)").

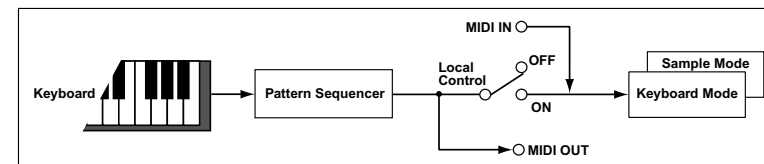

Recording the microSAMPLER pattern sequencer's MIDI output onto an external MIDI device

Connect the microSAMPLER's MIDI OUT connector to the MIDI IN connector of your external MIDI sequencer or computer, and connect the microSAMPLER's MIDI IN connector to the MIDI OUT connector of your external MIDI sequencer or computer.

Then turn the microSAMPLER's Local Control setting off ("GLOBAL" page LOCAL: OFF), and turn on the Echo Back setting of your external MIDI sequencer or computer (p.39 "LOCAL (MIDI Local Control)").

Pattern sequencer synchronization

The "GLOBAL" page MIDI CLK setting (p.40) specifies whether the microSAMPLER's pattern sequencer will operate as master (the controlling device) or slave (the device being controlled).

⚠ For details on synchronization-related settings for your external MIDI device, please refer to its owner's manual.

Using the microSAMPLER as the master and the external MIDI device as the slave

1. Connect the microSAMPLER's MIDI OUT connector to your external MIDI device's MIDI IN connector.
2. Press the [EDIT] button to make it blink, and use the [PARAMETER/FX CONTROL 1] knob to select the "GLOBAL" page.

3. Press the [EDIT] button to make it light-up, and use the [PARAMETER/FX CONTROL 1] knob to select “MIDI CLK.” Then use the [VALUE/FX CONTROL 2] knob to select “INT.” The microSAMPLER will be the master device, and will transmit MIDI timing clock messages (ⓘp.40 “MIDI CLK (MIDI Clock”).
4. Set your external MIDI device to receive incoming MIDI clock data. The external MIDI device (e.g., sequencer or rhythm machine) will operate using the tempo specified by the microSAMPLER.

Using the external MIDI device as the master and the microSAMPLER as the slave

1. Connect the microSAMPLER’s MIDI IN connector to your external MIDI device’s MIDI OUT connector.
2. Press the [EDIT] button to make it blink, and use the [PARAMETER/FX CONTROL 1] knob to select the “GLOBAL” page.
3. Press the [EDIT] button to make it light, and use the [PARAMETER/FX CONTROL 1] knob to select “MIDI CLK.” Then use the [VALUE/FX CONTROL 2] knob to select “EXT MIDI” so that the microSAMPLER will operate as the slave device. Set your external MIDI device to transmit MIDI timing clock messages as the master device (ⓘp.40 “MIDI CLK (MIDI Clock”).
4. The microSAMPLER’s pattern sequencer and delay effect tempo will synchronize to the tempo of the external MIDI device (e.g., sequencer or rhythm machine).

note If the “GLOBAL” page MIDI CLK parameter is set to “AUTO,” the microSAMPLER will automatically work using the “EXT MIDI” setting when MIDI clock messages are being received from an external MIDI device connected to the microSAMPLER’s MIDI IN connector. Otherwise, the microSAMPLER will operate using the “INT” setting.

About MIDI messages

1. MIDI channel

There are sixteen MIDI channels (1–16). MIDI messages will be received if the channel of the receiving device matches the channel of the transmitting device.

The way in which channels are handled will depend on the microSAMPLER’s settings.

• Global MIDI channel setting

This is set by the “GLOBAL” page GLOBAL.CH parameter (ⓘp.39 “GLOBAL.CH (Global MIDI Channel”).

• Keyboard MIDI channel setting

This is set by the “GLOBAL” page KB.MIDI.CH parameter (ⓘp.39 “KB.MIDI.CH (Keyboard MIDI Channel”).

note The global MIDI channel is the basic MIDI channel that the microSAMPLER uses to transmit and receive MIDI messages.

note In Sample mode, MIDI messages are transmitted and received on the global MIDI channel.

2. Note-on/off

Note-on [9n, kk vv], Note-off [8n, kk, vv]

(n: channel, kk: note number, vv: velocity)

Note-on/off messages are transmitted when you play the microSAMPLER’s keyboard. The note-off velocity is transmitted with a fixed value of 64, but is not received.

3. Pitch bend

Pitch bend change [En, bb, mm]

(n: channel, bb: lower byte of value, mm: upper byte of value)

In Keyboard mode, pitch bend change messages can be received to control the pitch (the range is fixed at 1 octave).

In this case, the pitch is controlled in the range from -8192 to +8191, with mm=64 and bb=00 as the zero value (center). (This message is received on the channel specified by the “GLOBAL” page KB.MIDI.CH parameter.)

note Pitch bend change messages cannot be received in Sample mode.

4. Control change

Knob control change assignment [Bn, cc, vv]

(n: channel, cc: control change number, vv: value)

Control change messages will be transmitted when you operate the [PARAMETER/FX CONTROL 1] knob (CC#12) or the [VALUE/FX CONTROL 2] knob (CC#13).

If you’ve assigned effect parameters to these knobs, incoming messages of the control change number assigned to a knob will control the corresponding effect parameter.

note These messages are transmitted and received on the global MIDI channel.

Volume (CC#07) [Bn, 07, vv]

In Keyboard mode, volume messages can be received to control the volume.

note Volume messages cannot be received in Sample mode. This message is received on the keyboard MIDI channel.

Panpot (CC#10) [Bn, 0A, vv]

In Keyboard mode, panpot messages can be received to control the pan position.

note Panpot messages cannot be received in Sample mode. This message is received on the keyboard MIDI channel.

All note off (CC#123) [Bn, 7B, 00] (value is 00)

When an All Note Off message is received, notes that are playing on that channel will turn off. Depending on the settings, the release portion of the notes may still be heard.

All sound off (CC#120) [Bn, 78, 00] (value is 00)

When an All Sound Off message is received, all sound being produced by that channel will turn off. While the All Note Off message allows the release portion of the notes to be heard, the All Sound Off message will silence the sound immediately.

These messages are intended for use in emergencies such as when “stuck notes” occur. They are not used during normal performance.

Reset all controllers (CC#121) [Bn, 79, 00] (value is 00)

When a Reset All Controllers message is received, all controller values being used on that channel will be reset.

5. Parameters transmitted and received as NRPN messages

NRPN (Non Registered Parameter Number) messages are assigned to the microSAMPLER’s knobs and buttons that are not covered by the controllers discussed above. Each musical instrument manufacturer or device is free to use NRPN messages as desired.

To edit using NRPN messages, use the following procedure.

1. Transmit NRPN MSB (CC#99) [Bn, 63, mm] and NRPN LSB (CC#98) [Bn, 62, register] messages (n: channel, mm, rr: upper and lower bytes of the parameter number) to specify the desired parameter.
2. Transmit a data entry MSB (CC#6) [Bn, 06, mm] message (n: channel, mm: parameter value) to set the value of the specified parameter.

note The microSAMPLER uses only the data entry MSB.

By sending the following NRPN messages to the microSAMPLER you can make various settings for the pattern sequencer or the sampler. These messages are received on the global MIDI channel. The table below shows how the parameter values of the message correspond to the microSAMPLER's actual parameter values.

- [PATTERN] dial: [Bn, 63, 20, Bn, 62, 01, Bn, 06, mm]
- [REC] button: [Bn, 63, 20, Bn, 62, 02, Bn, 06, mm]
- [SAMPLING] button: [Bn, 63, 20, Bn, 62, 11, Bn, 06, mm]
- [INPUT SELECT] button: [Bn, 63, 20, Bn, 62, 12, Bn, 06, mm]

	MSB (Hex)	LSB (Hex)	Value (received)
[PATTERN] dial	32 (20)	01 (01)	0...7: 1, 8...15: 2, 16...23: 3, 24...31: 4, 32...39: 5, 40...47: 6, 48...55: 7, 56...63: 8, 64...71: 9, 72...79: 10, 80...87: 11, 88...95: 12, 96...103: 13, 104...111: 14, 112...119: 15, 120...127: 16
[REC] button	32 (20)	02 (02)	127: SETUP/REC STANDBY, REC/REC END
[SAMPLING] button	32 (20)	17 (11)	127: SETUP/SAMPLING STANDBY, SAMPLING/SAMPLING END
[INPUT SELECT] button	32 (20)	18 (12)	0...63: AUDIO IN, 64...127: RE-SAMPLE

System exclusive messages

microSAMPLER format

F0: Exclusive status
 42: Korg ID
 3n: [n=0–F] MIDI channel
 7F: microSAMPLER model ID
 nn: Function ID (type of message)
 –
 F7: End of exclusive

Universal system exclusive

Some system exclusive messages have officially defined uses. These are called “universal system exclusive messages.”

Of these universal system exclusive messages, the microSAMPLER is able to receive the Master Volume message.

Master volume [F0, 7F, nn, 04, 1, vv, mm, F7]

(vv: lower byte of value, mm: upper byte of value. Volume is at maximum when ‘mm’ and ‘vv’ are both 7F. Volume is zero when ‘mm’ and ‘vv’ are both 00.)

When a Master Volume message is received, the microSAMPLER's overall volume will be adjusted.

Realtime messages

Synchronizing the pattern sequencer

If you want to synchronize the microSAMPLER's pattern sequencer to a connected external MIDI device, use the system realtime messages Start and Stop to control the pattern sequencer.

Start [FA]

If a Start [FA] message is received when the pattern sequencer is stopped, the pattern sequencer will start playing.

If a Start [FA] message is received during playback, the pattern sequencer will reset to the beginning of the pattern.

Stop [FC]

If a Stop [FC] message is received, the pattern sequencer will stop.

Effect parameters

[Parameter name] **Ⓜ**: This is a parameter that can be assigned to a front panel knob. (Ⓜp.36 “2. Controlling effect parameters”)

1. COMPRESR (Stereo Compressor)

This effect compresses the input signal to make it more consistent and give it more punch. It is particularly good for sounds with a strong attack.

You can link the left and right channels, or make them operate independently if desired.

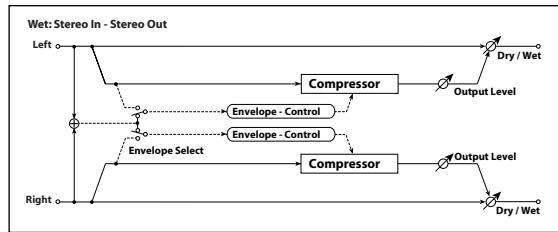

DRY/WET **Ⓜ** [DRY, 99:1...1:99, WET]

Adjusts the balance between the effect sound and the direct sound.

ENV SEL (Envelope Select) [LR MIX, LR INDIV]

With the “LR MIX” setting, the left and right channels will be linked, and the envelope of the mixed left and right signals will be used to control both simultaneously.

With the “LR INDIV” setting, the left and right channels will be controlled independently.

SENS (Sensitivity) **Ⓜ** [1...127]

Adjusts the sensitivity of the compressor. Increasing this value will cause lower-level sounds to be boosted. Since raising the SENS value will increase the overall volume, use OUT.LEVEL to adjust the final volume.

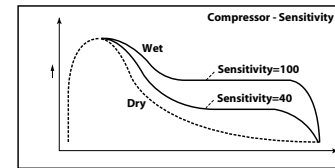

ATTACK **Ⓜ** [0.1...500.0 ms]

Adjusts the strength of the compressor’s attack.

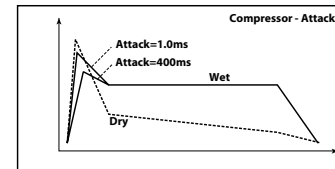

OUT.LEVEL (Output Level) [0...127]

Adjusts the output level of the compressor.

2. FILTER (Stereo Filter)

This is a stereo filter.

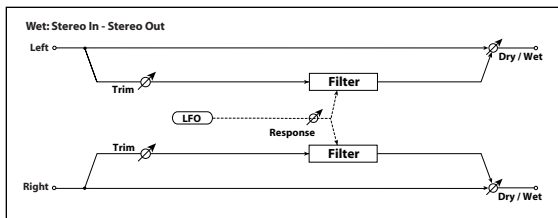

DRY/WET [0...127] [DRY, 99:1...1:99, WET]

Adjusts the balance between the effect sound and the direct sound.

FLT TYPE (Filter Type) [LPF24 (-24 dB/oct), LPF18 (-18 dB/oct), LPF12 (-12 dB/oct), HPF12 (-12 dB/oct), BPF12 (-12 dB/oct)]

Selects the filter type.

CUTOFF [0...127] [0...127]

Specifies the filter's cutoff frequency.

RESO (Resonance) [0...127] [0...127]

Adjusts the filter's resonance.

TRIM [0...127] [0...127]

Adjusts the input level to the effect.

MOD.DEPTH (Modulation Depth) [-63...+63] [-63...+63]

Adjusts the depth of modulation produced by the LFO.

RESPONSE (Modulation Response) [0...127] [0...127]

Adjusts the response of the modulation effect.

With a setting of 0, the response will be slow.

LFO SYNC (LFO Tempo Sync) [OFF, ON] [OFF, ON]

Specifies whether the LFO cycle will be synchronized to the tempo specified by "BPM" (p.22) or to MIDI clock.

OFF

The LFO will function according to the frequency specified by LFO FREQ.

ON

The LFO will synchronize to the tempo or to MIDI clock.

note If MIDI CLK (p.40) is set to "INT," the LFO will synchronize to the tempo specified by "2. Setting the tempo" (p.18). With the "EXT USB" or "EXT MIDI" setting, the microSAMPLER will synchronize to MIDI clock messages received from a MIDI device.

LFO FREQ (LFO Frequency) [0.01...100.00 Hz]

This specifies the LFO frequency. Higher settings will make the rate faster.

If you assign this parameter to a knob, turning LFO SYNC "ON" will change the assignment to SYNC.NOTE.

SYNC.NOTE (LFO Sync Note) [8/1...1/64]

Specifies the ratio of the LFO frequency relative to the tempo specified by "BPM" (p.22). Relative to the tempo, the length of the specified value (note value) will be one LFO cycle.

For example with a setting of 1/4, one beat will be one cycle. With a setting of 3/4, three beats will be one cycle.

If you assign this parameter to a knob, turning LFO SYNC off will change the assignment to LFO FREQ.

LFO WAVE (LFO Waveform) [SAW, SQUARE, TRIANGLE, SINE, S&H]

Selects the LFO waveform.

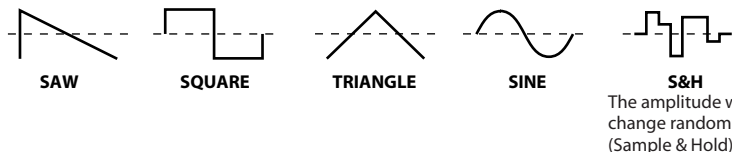

LFO.SHAPE [-63...+63] [-63...+63]

Adjusts the LFO waveform.

KEY SYNC (LFO Key Sync) [OFF, ON]

Specifies whether the LFO will be reset at note-on.

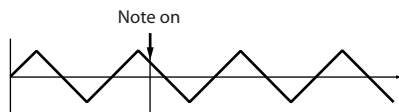

OFF

The LFO's phase will not be reset at note-on.

ON

The first note-on from a state in which no keys are pressed will reset the LFO to the phase specified by INI.PHASE. For subsequent note-ons, modulation is applied at that phase.

This is valid when a note-on occurs on the global MIDI channel.

INI.PHASE (LFO Init Phase) [0...180°]

Specifies the starting point of the LFO waveform.

With a setting of 0°, the LFO will start at the beginning of the waveform when note-on occurs.

With a setting of 180°, the LFO will start at the mid-point of the waveform when note-on occurs.

This parameter is visible and can be edited if KEY SYNC is "ON."

3. BAND EQ (4Band EQ)

This is a stereo EQ that allows you to select the type independently.

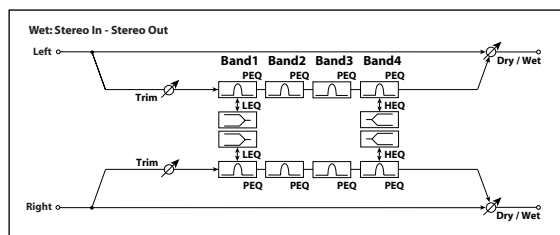

DRY/WET [DRY, 99:1...1:99, WET]

Adjusts the balance between the effect sound and the direct sound.

TRIM [0...127]

Adjusts the input level to the equalizer.

B1 TYPE [PEAKING, SHELV LO]

Selects the equalizer type for band 1.

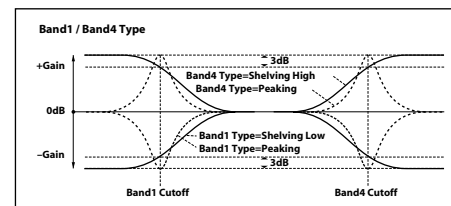

B1 FREQ (B1 Frequency) [20 Hz...20.00 kHz]

Specifies the center frequency of band 1.

B1 Q [0.5...10.0]

Specifies the width of band 1.

This parameter will be visible and editable if B1 TYPE is set to "PEAKING."

B1 GAIN [-18.0...+18.0 dB]

Adjusts the gain of band 1.

B2 FREQ (B2 Frequency) [20 Hz...20.00 kHz]

Specifies the center frequency of band 2.

B2 Q [0.5...10.0]

Specifies the width of band 2.

B2 GAIN [-18.0...+18.0 dB]

Adjusts the gain of band 2.

B3 FREQ (B3 Frequency) [20 Hz...20.00 kHz]

Specifies the center frequency of band 3.

B3 Q [0.5...10.0]

Specifies the width of band 3.

B3 GAIN [-18.0...+18.0 dB]

Adjusts the gain of band 3.

B4 TYPE [PEAKING, SHELV HI]

Selects the equalizer type for band 4.

B4 FREQ (B4 Frequency)[20 Hz...20.00 kHz]

Specifies the center frequency of band 4.

B4 Q [0.5...10.0]

Specifies the width of band 4.

note This parameter is visible and can be edited if B4 TYPE is set to "PEAKING."

B4 GAIN [-18.0...+18.0dB]

Adjusts the gain of band 4.

4. DISTORT (Distortion)

This is a distortion effect that lets you use a 3-band EQ to obtain a wide range of variation.

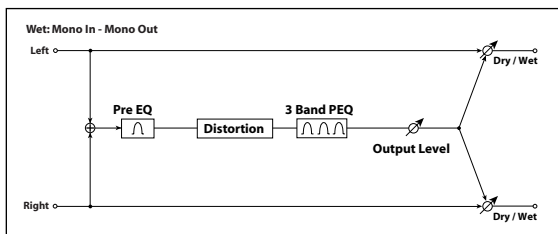

DRY/WET [DRY, 99:1...1:99, WET]

Adjusts the balance between the effect sound and the direct sound.

GAIN[0...127]

Specifies the degree of distortion.

PRE FREQ (Pre EQ Frequency)[20 Hz...20.00 kHz]

Specifies the center frequency of the PreEQ.

PRE Q (Pre EQ Q) [0.5...10.0]

Specifies the band width of the PreEQ.

PRE GAIN (Pre EQ Gain)[-18.0...+18.0 dB]

Adjusts the gain of the PreEQ.

B1 FREQ (B1 Frequency)[20 Hz...20.00 kHz]

Specifies the center frequency of band 1.

B1 Q [0.5...10.0]

Specifies the width of band 1.

B1 GAIN [-18.0...+18.0 dB]

Adjusts the gain of band 1.

B2 FREQ (B2 Frequency) [20 Hz...20.00 kHz]

Specifies the center frequency of band 2.

B2 Q [0.5...10.0]

Specifies the width of band 2.

B2 GAIN [-18.0...+18.0 dB]

Adjusts the gain of band 2.

B3 FREQ (B3 Frequency) [20 Hz...20.00 kHz]

Specifies the center frequency of band 3.

B3 Q [0.5...10.0]

Specifies the width of band 3.

B3 GAIN [-18.0...+18.0 dB]

Adjusts the gain of band 3.

OUT. LEVEL (Output Level) [0...127]

Adjusts the output level.

5. DECIMATR (Stereo Decimator)

By lowering the sampling frequency and bit depth, this effect reproduces the rough sound of an inexpensive sampler. It simulates the distinctive noise produced by such samplers.

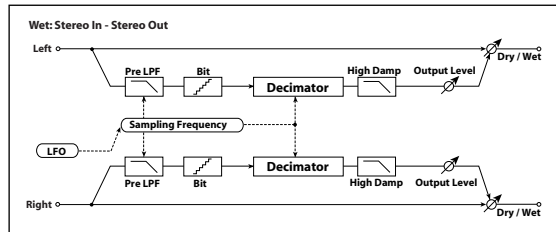

DRY/WET [DRY, 99:1...1:99, WET]

Adjusts the balance between the effect sound and the direct sound.

PRE LPF [OFF, ON]

Specifies whether the aliasing noise produced by lowering the sampling rate will be heard.

On samplers that have a low sampling frequency, inputting frequencies that are too high to be reproduced will generate pitches that are unrelated to the original sound. By turning PRE LPF "ON," you can prevent such noise from being generated.

By setting FS to about "3 kHz" and turning PRE LPF "OFF," you can produce a sound reminiscent of a ring modulator.

HI DAMP [0...100%]

Adjusts the high-frequency damping.

FS [1.0...48.0 kHz]

Specifies the sampling frequency.

BIT [4...24 bit]

Specifies the bit depth of the data.

Lower settings will make the sound rougher and more distorted. Some settings may change the volume, so adjust OUT.LEVEL if necessary.

OUT.LEVEL (Output Level) [0...127]

Adjusts the output level.

FS.MOD.INT (Mod Intensity) [-63...+63]

Adjusts the depth of the modulation applied by the LFO to the sampling frequency.

LFO SYNC (LFO Tempo Sync) [OFF, ON]

p.48 "LFO SYNC (LFO Tempo Sync)"

LFO FREQ (LFO Frequency) [0.01...100.00 Hz]

p.48 "LFO FREQ (LFO Frequency)"

note This parameter will be visible and editable if LFO SYNC is "OFF."

SYNC. NOTE (LFO Sync Note) [8/1...1/64]

p.48 "SYNC.NOTE (LFO Sync Note)"

note This parameter will be visible and editable if LFO SYNC is "ON."

LFO WAVE (LFO Waveform) [SAW, SQUARE, TRIANGLE, SINE, S&H]

p.48 "LFO WAVE (LFO Waveform)"

LFO. SHAPE [-63...+63]

Adjusts the LFO waveform.

KEY SYNC (LFO Key Sync) [OFF, ON]

p.49 "KEY SYNC (LFO Key Sync)"

INI.PHASE (LFO Init Phase) [0...180°]

p.49 "INI.PHASE (LFO Init Phase)"

note This parameter will be visible and editable if "KEY SYNC" is ON.

6. Reverb

This effect simulates the reverberant ambience of a hall or similar space.

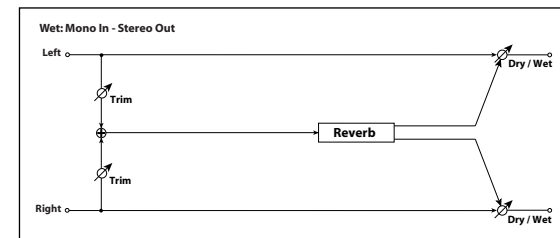

DRY/WET  [DRY, 99:1...1:99, WET]

Adjusts the balance between the effect sound and the direct sound.

TYPE [HALL...BRIT.ROOM]

Selects the reverb type.

HALL

A hall-type reverb that produces the reverberation of a medium-to-large concert hall or ensemble hall.

SMTH.HALL

A hall-type reverb that produces the reverberation of a large hall or stadium. The release portion of the reverberation is particularly smooth.

WET.PLATE

A plate reverb that produces a warm and dense reverberation.

DRY.PLATE

A plate reverb that produces a dry and light reverberation.

ROOM

A tight-sounding room-type reverb that emphasizes the early reflections.

BRIT.ROOM

A reverb that emphasizes the early reflections, with a brighter feel than ROOM.

REV TIME (Reverb Time)  [0.1...10.0 sec]

Specifies the reverberation time.

The available range will depend on the TYPE setting.

HALL-DRY.PLATE: 0.1-10 sec

ROOM, BRIT.ROOM: 20-3000 ms

HI DAMP [0...100%]

Specifies the amount of high-frequency damping.

LO DAMP [0...100%]

Specifies the amount of low-frequency damping.

PREDELAY [0...70 ms]

Specifies the delay time from the direct sound until the delayed sound is heard.

TRIM [0...127]

Adjusts the input level to the effect.

7. DELAY (Stereo Delay)

This is a stereo delay. By changing the feedback connection, you can also use this as a cross-feedback delay in which the delay sound alternates between left and right sides.

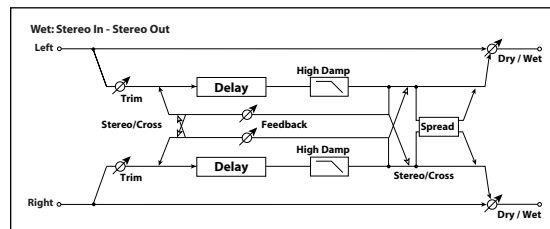

DRY/WET  [DRY, 99:1...1:99, WET]

Adjusts the balance between the effect sound and the direct sound.

TYPE [STEREO, CROSS]

Selects the delay time.

STEREO

A conventional stereo delay.

CROSS

A cross-feedback delay in which the delay sound alternates between left and right.

BPM SYNC (Delay Time Tempo Sync) [OFF, ON]

Specifies whether the delay time will be synchronized.

If this is ON, the delay time will synchronize to the tempo or to MIDI clock.

TM RATIO (Time Ratio)  [BPM SYNC OFF: 0.5...400.0% (OVER) / BPM SYNC ON: 12.5...400.0% (OVER)]

Specifies the proportion of each delay time relative to the L DELAY and R DELAY values.

The range will be different depending on whether BPM SYNC is "ON" or "OFF." For example if TM RATIO is "50%" and L DELAY is "500 ms," setting R DELAY to "1200 ms" will mean that the delay times will be "250 ms" and "600 ms" respectively.

note If the settings for each delay time and TM RATIO would exceed the allowable range, a "🚫" symbol will be shown for TM RATIO.

L DELAY, R DELAY (L, R Delay Time)[0...1400 ms, 1/64...1/1]

Specify the delay times for the left and right channels.

The delay times are determined by these settings in conjunction with the TM RATIO setting.

If BPM SYNC is "OFF," the range will be "0–1400 ms."

If BPM SYNC is "ON," the delay times are specified by the resolution relative to the tempo specified by BPM (p.22) or by MIDI clock.

FEEDBACK (F)[0...127]

Adjusts the amount of feedback for the left and right channels.

The right-channel feedback amount will change proportionally to the left and right delay times in order to keep the decay times fixed for the left and right channels.

HI DAMP [0...100%]

Specifies the amount of high-frequency damping.

TRIM[0...127]

Adjusts the input level to the effect.

SPREAD[0...127]

Specifies the width that the effect sound will be panned.

A setting of 127 produces the maximum width.

With a setting of 0, the effect sound of both channels will be output from the center.

8. LCR.DELAY (L/C/R Delay)

This is a multi-tap delay in which three taps are output from the left, center, and right. You can adjust the left/right spread of the delay sound.

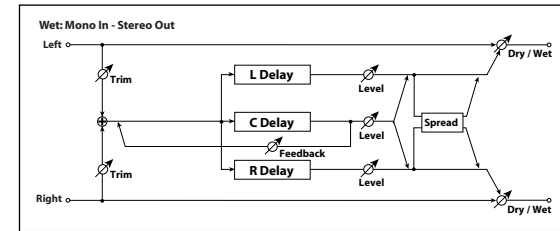

DRY/WET (D) [DRY, 99:1...1:99, WET]

Adjusts the balance between the effect sound and the direct sound.

BPM SYNC (Delay Time Tempo Sync) [OFF, ON]

p.52 "BPM SYNC (Delay Time Tempo Sync)"

TM RATIO (Time Ratio) (T) [BPM SYNC OFF: 0.5...400.0% (OVER) /BPM SYNC ON: 12.5...400.0% (OVER)]

p.52 "TM RATIO (Time Ratio)"

L DELAY, C DELAY, R DELAY (L, C, R Delay Time) ...[0...1400 ms, 1/64... 1/1]

Adjusts the delay times for the L, C, and R taps.

p.53 "L DELAY, R DELAY (L, R Delay Time)"

L LEVEL, C LEVEL, R LEVEL (L, C, R Delay Level) [0...127]

Adjusts the output level for the L, C, and R taps.

C FEEDBK (C Feedback) (F) [0...127]

Adjusts the amount of feedback for the C tap.

TRIM [0...127]

Adjusts the input level to the effect.

SPREAD [0...127]

Specifies the width that the effect sound will be panned.

A setting of 127 produces the maximum width.

With a setting of 0, the effect sound of both channels will be output from the center.

9. PAN.DELAY (Stereo Auto Panning Delay)

This is a stereo delay that uses an LFO to pan the delay sound to left and right.

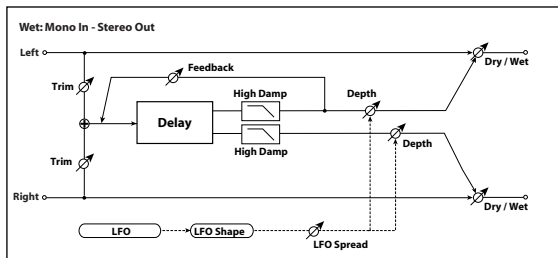

DRY/WET [DRY, 99:1...1:99, WET]

Adjusts the balance between the effect sound and the direct sound.

BPM SYNC (Delay Time Tempo Sync) [OFF, ON]

p.52 "BPM SYNC (Delay Time Tempo Sync)"

TM RATIO (Time Ratio) [BPM SYNC OFF: 0.5...400.0% (OVER) /BPM SYNC ON: 12.5...400.0% (OVER)]

p.52 "TM RATIO (Time Ratio)"

L DELAY, R DELAY (L, R Delay Time)[0...1400ms, 1/64... 1/1]

p.53 "L DELAY, R DELAY (L, R Delay Time)"

FEEDBACK[0...127]

p.53 "FEEDBACK"

MOD.DEPTH[0...127]

Adjusts the depth of modulation.

LFO SYNC (LFO Tempo Sync) [OFF, ON]

p.48 "LFO SYNC (LFO Tempo Sync)"

LFO FREQ (LFO Frequency)[0.01...100.00 Hz]

p.48 "LFO FREQ (LFO Frequency)"

SYNC.NOTE (LFO Sync Note)[8/1...1/64]

p.48 "SYNC.NOTE (LFO Sync Note)"

LFO WAVE (LFO Waveform) [SAW, SQUARE, TRIANGLE, SINE, S&H]

p.48 "LFO WAVE (LFO Waveform)"

LFO.SHAPE [-63...+63]

Adjusts the shape of the LFO waveform.

KEY SYNC (LFO Key Sync) [OFF, ON]

p.49 "KEY SYNC (LFO Key Sync)"

INI.PHASE (LFO Init Phase) [0...180°]

p.49 "INI.PHASE (LFO Init Phase)"

LFO SPRD (LFO Spread) [-180...+180°]

Specifies the LFO phase difference between the left and right channels.

HI DAMP [0...100%]

Specifies the amount of high-frequency damping.

TRIM [0...127]

Adjusts the input level to the external device.

10. MOD.DELAY (Stereo Modulation Delay)

This is a stereo modulation delay.

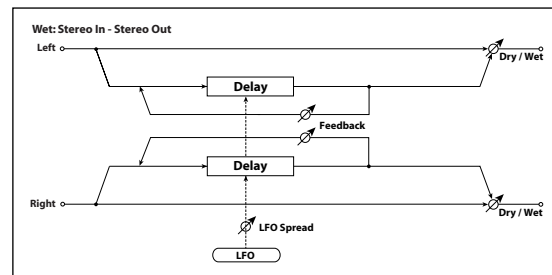

DRY/WET [DRY, 99:1...1:99, WET]

Adjusts the balance between the effect sound and the direct sound.

BPM SYNC (Delay Time Tempo Sync) [OFF, ON]

p.52 "BPM SYNC (Delay Time Tempo Sync)"

TM RATIO (Time Ratio) [BPM SYNC OFF: 0.5...400.0% (OVER) /BPM SYNC ON: 12.5...400.0% (OVER)]

p.52 "TM RATIO (Time Ratio)"

L DELAY, R DELAY (L, R Delay Time) [0...1400 ms, 1/64... 1/1]
 ☞p.53 “L DELAY, C DELAY, R DELAY (L, C, R Delay Time)”

FEEDBACK  [0...127]
 ☞p.53 “FEEDBACK”

MOD.DEPTH  [0...127]
 Adjusts the depth of modulation.

LFO FREQ (LFO Frequency)  [0.01...100.00 Hz]
 Specifies the LFO frequency. Higher values will make the LFO faster.

LFO SPRD (LFO Spread) [-180...180°]
 Specifies the LFO phase difference between the left and right channels.

11. TAPE.ECHO

This effect simulates a tape echo. It reproduces the distortion and tonal change that are characteristic of magnetic tape.

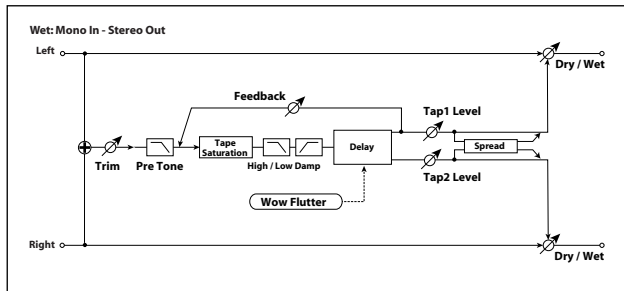

DRY/WET  [DRY, 99:1...1:99, WET]
 Adjusts the balance between the effect sound and the direct sound.

BPM SYNC (Delay Time Tempo Sync) [OFF, ON]
 ☞p.52 “BPM SYNC (Delay Time Tempo Sync)”

TM RATIO  [BPM SYNC OFF: 0.5...400.0% (OVER)
 /BPM SYNC ON: 12.5...400.0% (OVER)]

☞p.52 “TM RATIO (Time Ratio)”

TAP1 DLY,TAP2 DLY(Tap1,Tap2 Delay Time) [0...1400 ms, 1/64...1/1]
 Specify the delay times for tap 1 and tap 2. The delay time is determined by these values in conjunction with the TM RATIO value.

TAP1 LVL,TAP2 LVL (Tap1 Level,Tap2 Level)  [0...127]
 Adjust the output levels of tap 1 and tap 2.

FEEDBACK  [0...127]
 Adjusts the amount of feedback for tap 1.

HI DAMP [0...100%]
 Specifies the amount of high-frequency damping.

LO DAMP [0...100%]
 Specifies the amount of low-frequency damping.

TRIM [0...127]
 Adjusts the input level to the effect.

SATURATN (Tape Saturation)  [0...127]
 Adjusts the amount of distortion in the effect sound.

WOW FREQ (WOW Flutter Frequency) [0.01...100.00 Hz]
 Adjusts the speed of pitch change in units of Hz.

WOW.DEPTH (WOW Flutter Depth) [0...127]
 Adjusts the depth of pitch change.

PRE TONE [0...127]
 Adjusts the tone of the input sound.

SPREAD [0...127]
 ☞p.53 “SPREAD”

12. CHORUS (Stereo Chorus)

This effect adds depth and warmth to the sound by modulating the delay time of the input signal. You can control the spaciousness by skewing the LFO for the left and right signals.

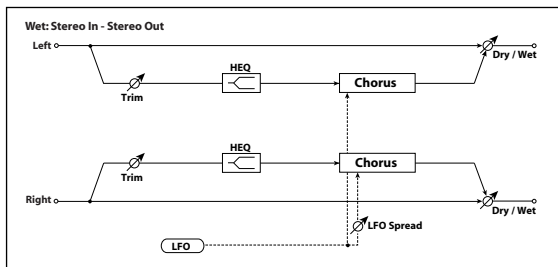

DRY/WET [DRY, 99:1...1:99, WET]

Adjusts the balance between the effect sound and the direct sound.

MOD.DEPTH (Modulation Depth)[0...127]

Adjusts the depth of modulation produced by the LFO.

LFO FREQ (LFO Frequency)[0.01...100.00 Hz]

Specifies LFO frequency. Higher values will make the LFO faster.

LFO SPRD (LFO Spread)[-180...+180°]

Specifies the LFO phase difference between the left and right channels.

PREDLY L, PREDLY R (PreDelayL, PreDelayR)[0.0...50.0 ms]

Specify the delay times for the left and right channels.

TRIM[0...127]

Adjusts the input level to the effect.

HI.EQ.GAIN (High EQ Gain)[-15.0...+15.0 dB]

Adjusts the gain of the high-frequency equalizer.

13. FLANGER (Stereo Flanger)

This effect gives the sound intense modulation with a sense of changing pitch. It is particularly effective when applied to sounds that contain a rich overtone structure. It's a stereo effect that allows you to control the spaciousness by skewing the LFO for the left and right signals.

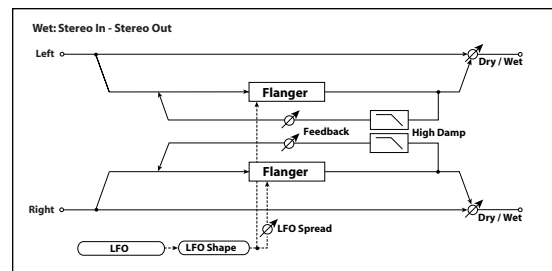

DRY/WET [DRY, 99:1...1:99, WET]

Adjusts the balance between the effect sound and the direct sound.

DELAY [0.0...30.0 ms]

Specifies the delay time in msec units.

MOD.DEPTH (Modulation Depth) [0...127]

Adjusts the depth of modulation produced by the LFO.

FEEDBACK [0...127]

Adjusts the amount of feedback for the left and right channels.

PHASE [+ , -]

Switches the phase of the output and feedback.

LFO SYNC (LFO Tempo Sync) [OFF, ON]

p.48 "LFO SYNC (LFO Tempo Sync)"

LFO FREQ (LFO Frequency)[0.01...100.00 Hz]

p.48 "LFO FREQ (LFO Frequency)"

SYNC.NOTE (LFO Sync Note)[8/1...1/64]

p.48 "SYNC.NOTE (LFO Sync Note)"

LFO WAVE (LFO Waveform)[SAW, SQUARE, TRIANGLE, SINE, S&H]

p.48 "LFO WAVE (LFO Waveform)"

LFO.SHAPE [-63...+63]

Adjusts the LFO waveform.

KEY SYNC (LFO Key Sync) [OFF, ON]

☞p.49 “KEY SYNC (LFO Key Sync)”

INI.PHASE (LFO Init Phase) [0...180°]

☞p.49 “INI.PHASE (LFO Init Phase)”

LFO SPRD (LFO Spread) [-180...+180°]

Specifies the LFO phase difference between the left and right channels.

HI DAMP [0...100%]

Specifies the amount of high-frequency damping.

14. VIBRATO (Stereo Vibrato)

This effect cyclically modulates the pitch of the input signal. It’s a stereo effect that allows you to control the spaciousness by skewing the LFO for the left and right signals.

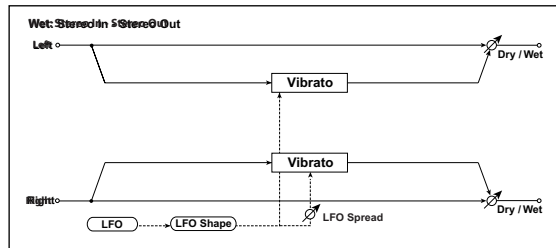

DRY/WET [DRY, 99:1...1:99, WET]

Adjusts the balance between the effect sound and the direct sound.

MOD.DEPTH (Modulation Depth) [0...127]

Adjusts the depth of modulation produced by the LFO.

LFO SYNC (LFO Tempo Sync) [OFF, ON]

☞p.48 “LFO SYNC (LFO Tempo Sync)”

LFO FREQ (LFO Frequency) [0.01...100.00 Hz]

☞p.48 “LFO FREQ (LFO Frequency)”

SYNC.NOTE (LFO Sync Note) [8/1...1/64]

☞p.48 “SYNC.NOTE (LFO Sync Note)”

LFO WAVE (LFO Waveform) [SAW, SQUARE, TRIANGLE, SINE, S&H]

☞p.48 “LFO WAVE (LFO Waveform)”

LFO.SHAPE [-63...+63]

Adjusts the LFO waveform.

KEY SYNC (LFO Key Sync) [OFF, ON]

☞p.49 “KEY SYNC (LFO Key Sync)”

INI.PHASE (LFO Init Phase) [0...180°]

☞p.49 “INI.PHASE (LFO Init Phase)”

LFO SPRD (LFO Spread) [-180...+180°]

Specifies the LFO phase difference between the left and right channels.

15. PHASER (Stereo Phaser)

This effect produces modulation by cyclically shifting the phase. It’s a stereo effect that allows you to control the spaciousness by skewing the LFO for the left and right signals.

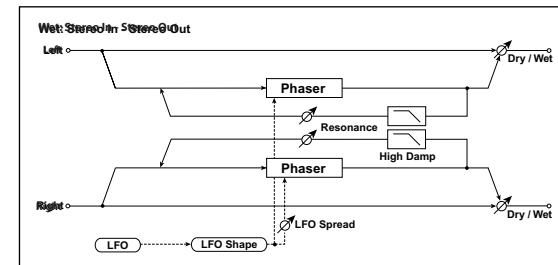

DRY/WET [DRY, 99:1...1:99, WET]

Adjusts the balance between the effect sound and the direct sound.

TYPE [BLUE, U-VB]

Selects the type of phaser.

MANUAL [0...127]

Adjusts the frequency at which the effect is applied.

MOD.DEPTH (Modulation Depth) [0...127]

Adjusts the depth of modulation produced by the LFO.

RESO (Resonance) [0...127]

Adjusts the amount of resonance.

PHASE [+ , -]

Switches the phase of the output and the feedback.

LFO SYNC (LFO Tempo Sync) [OFF, ON]

 p.48 “LFO SYNC (LFO Tempo Sync)”

LFO FREQ (LFO Frequency) [0.01...100.00 Hz]

 p.48 “LFO FREQ (LFO Frequency)”

SYNC.NOTE (LFO Sync Note) [8/1...1/64]

 p.48 “SYNC.NOTE (LFO Sync Note)”

LFO WAVE (LFO Waveform) [SAW, SQUARE, TRIANGLE, SINE, S&H]

 p.48 “LFO WAVE (LFO Waveform)”

LFO.SHAPE [-63...+63]

Adjusts the LFO waveform.

KEY SYNC (LFO Key Sync) [OFF, ON]

 p.49 “KEY SYNC (LFO Key Sync)”

INI.PHASE (LFO Init Phase) [0...180°]

 p.49 “INI.PHASE (LFO Init Phase)”

LFO SPRD (LFO Spread)[-180...+180°]

Specifies the LFO phase difference between the left and right channels.

HI DAMP [0...100%]

Specifies the amount of high-frequency damping.

16. TREMOLO (Stereo Tremolo)

This effect modulates the volume of the input signal. It’s a stereo effect, and it moves the sound between left and right by skewing the LFO for the left and right signals.

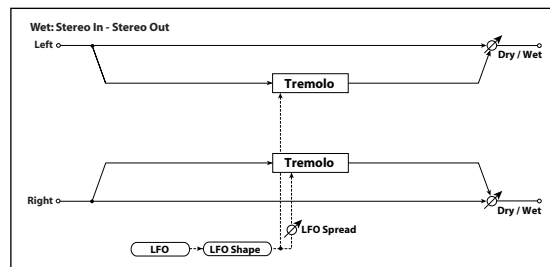

DRY/WET  [DRY, 99:1...1:99, WET]

Adjusts the balance between the effect sound and the direct sound.

MOD.DEPTH (Modulation Depth)  [0...127]

Adjusts the depth of modulation produced by the LFO.

LFO SYNC (LFO Tempo Sync) [OFF, ON]

 p.48 “LFO SYNC (LFO Tempo Sync)”

LFO FREQ (LFO Frequency) [0.01...100.00 Hz]

 p.48 “LFO FREQ (LFO Frequency)”

SYNC.NOTE (LFO Sync Note) [8/1...1/64]

 p.48 “SYNC.NOTE (LFO Sync Note)”

LFO WAVE (LFO Waveform)[SAW, SQUARE, TRIANGLE, SINE, S&H]

 p.48 “LFO WAVE (LFO Waveform)”

LFO.SHAPE [-63...+63]

Adjusts the LFO waveform.

KEY SYNC (LFO Key Sync) [OFF, ON]

 p.49 “KEY SYNC (LFO Key Sync)”

INI.PHASE (LFO Init Phase) [0...180°]

 p.49 “INI.PHASE (LFO Init Phase)”

LFO SPRD (LFO Spread)[-180...+180°]
 Specifies the LFO phase difference between the left and right channels.

17. RING MOD (Stereo Ring Modulator)

This effect produces a metallic tone by multiplying the input signal with an oscillator. By modulating the oscillator with an LFO you can produce extremely drastic modulation. By making the oscillator frequency follow the note number, you can produce ring modulation effects that have correct pitches.

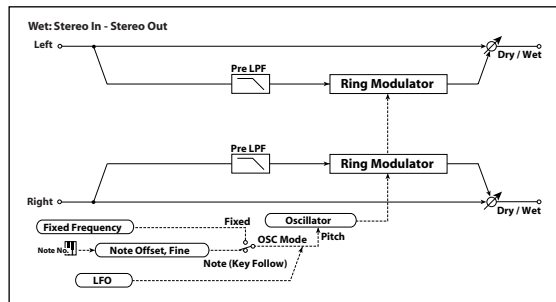

DRY/WET [DRY, 99:1...1:99, WET]
 Adjusts the balance between the effect sound and the direct sound.

OSC MODE [FIXED, NOTE]
 Specifies whether the oscillator frequency will follow the note number. With the NOTE setting, the oscillator frequency will follow the note number of the input signal.

FIXD.FREQ (Fixed Frequency) [0 Hz...12.00 kHz]
 Specifies the oscillator frequency when OSC MODE is set to "FIXED."

note If this parameter is assigned to a knob, the assignment will change to NOTE.OFST if you change OSC MODE to "NOTE."

NOTE.OFST (Note Offset) [-48...+48]
 Adjusts the pitch difference in semitones relative to the input note when OSC MODE is set to "NOTE."

NOTE.FINE [-100...+100]
 Adjusts the pitch difference in cents relative to the input note when OSC MODE is set to "NOTE."

note By using NOTE.OFST and NOTE.FINE to make the oscillator frequency track the input note, you can obtain a ring modulation effect that preserves the correct scale.

OSC WAVE (OSC Waveform) [SAW, TRIANGLE, SINE]
 Selects the oscillator waveform.

LFO INT (LFO Intensity) [-63...+63]
 Adjusts the depth of modulation produced by the LFO.

LFO SYNC (LFO Tempo Sync) [OFF, ON]
 p.48 "LFO SYNC (LFO Tempo Sync)"

LFO FREQ (LFO Frequency) [0.01...100.00 Hz]
 p.48 "LFO FREQ (LFO Frequency)"

SYNC.NOTE (LFO Sync Note) [8/1...1/64]
 p.48 "SYNC.NOTE (LFO Sync Note)"

LFO WAVE (LFO Waveform) [SAW, SQUARE, TRIANGLE, SINE, S&H]
 p.48 "LFO WAVE (LFO Waveform)"

LFO.SHAPE [-63...+63]
 Adjusts the LFO waveform.

KEY SYNC (LFO Key Sync) [OFF, ON]
 p.49 "KEY SYNC (LFO Key Sync)"

INI.PHASE (LFO Init Phase) [0...180°]
 p.49 "INI.PHASE (LFO Init Phase)"

PRE LPF [0...127]
 Specifies the amount of high-frequency attenuation applied to the sound that is input to the ring modulator. The effect sound will tend to be muddy if the input signal contains numerous overtones, so you may wish to use this parameter to cut the high frequency range.

18. GRAIN.SFT (Grain Shifter)

This effect samples the sound at extremely brief intervals and loops the playback. This is particularly good with sounds that are constantly changing, such as an external audio input.

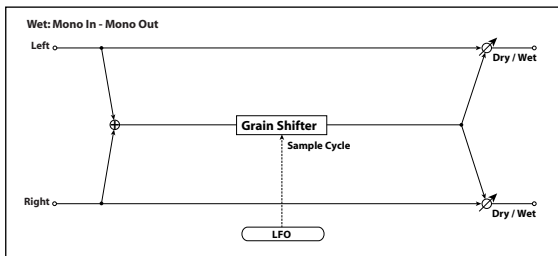

DRY/WET [DRY, 99:1...1:99, WET]
Adjusts the balance between the effect sound and the direct sound.

BPM SYNC (Duration Tempo Sync) [OFF, ON]
Specifies whether the looped playback of the waveform will be synchronized.

If this is “ON,” the looped playback of the waveform will synchronize to the tempo or to MIDI clock.

TM RATIO (Time Ratio) [BPM SYNC OFF: 0.5...400.0% (OVER) /BPM SYNC ON: 12.5...400.0% (OVER)]

Specifies the length of the waveform’s looped playback as a proportion of the DURATION setting.

DURATION[0...350ms, 1/64...1/1]
Specifies the length of the waveform that will be played.

The actual length played is determined by this setting together with the TM RATIO setting.

If BPM SYNC is “OFF,” you can set this in a range of “0–350 ms.”

If BPM SYNC is “ON,” you can set this as a resolution relative to the tempo specified by “2. Setting the tempo” (p.18) or by MIDI clock.

note If the combined DURATION and TM RATIO settings would exceed the allowable limit, a “” symbol is shown at the right of the DURATION and TM RATIO values.

LFO SYNC (LFO Tempo Sync) [OFF, ON]
p.48 “LFO SYNC (LFO Tempo Sync)”

LFO FREQ (LFO Frequency)[0.01...100.00Hz]
This specifies the rate in Hz units at which the waveform will be switched if LFO SYNC is “OFF.”

The length of waveform specified by DURATION will be played as a loop, and the waveform will switch to the next length at each cycle of the LFO.

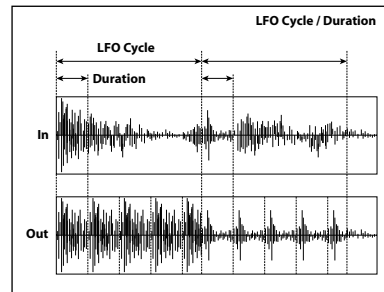

For some settings of the LFO FREQ and SYNC.NOTE parameters, it may take some time before the effect sound is output when you switch the FX POS setting (p.24) while in sampling-setup mode.

note If this parameter is assigned to a knob, turning LFO SYNC ON will change the assignment to SYNC.NOTE.

SYNC.NOTE (LFO Sync Note)[8/1...1/64]
p.48 “SYNC.NOTE (LFO Sync Note)”

KEY SYNC (LFO Key Sync) [OFF, ON]
p.49 “KEY SYNC (LFO Key Sync)”

INI.PHASE (LFO Init Phase) [0...180°]
p.49 “INI.PHASE (LFO Init Phase)”

19. PITCH.SFT (Pitch Shifter)

This effect changes the pitch of the input signal. You can choose one of three types: fast response, minimal change in tonal character, and mid-way between the first two types. This effect also provides a feedback delay that lets you create special effects such as a pitch that keeps rising (or falling).

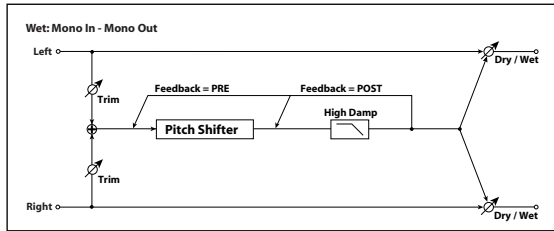

DRY/WET [DRY, 99:1...1:99, WET]
Adjusts the balance between the effect sound and the direct sound.

PITCH (Pitch Shift) [-24...+24]
Adjusts the amount of pitch shift in semitone steps.

FINE [-100...+100]
Adjusts the amount of pitch shift in steps of one cent.

BPM SYNC (Delay Time Tempo Sync) [OFF, ON]
p.52 "BPM SYNC (Delay Time Tempo Sync)"

TM RATIO (Time Ratio) [BPM SYNC OFF: 0.5...400.0% (OVER)
/BPM SYNC ON: 12.5...400.0% (OVER)]
p.52 "TM RATIO (Time Ratio)"

DELAY (Delay Time) [0...500 ms, 1/64...1/1]
The delay time is determined by this value and the TM RATIO value.
If BPM SYNC is "OFF," this can be adjusted in a range of "0-500 ms."
If BPM SYNC is "ON," the delay time is specified by the resolution you select here relative to the tempo specified by BPM (p.22) or MIDI clock.

FB POS (FB Position) [PRE, POST]
Switches the feedback connection.

FEEDBACK [0...127]
Adjusts the amount of feedback.

MODE [SLOW, MEDIUM, FAST]
Selects the pitch shifter's operating mode.

The "SLOW" setting produces minimal change in tonal character. The "FAST" setting allows fast response to pitch change. The "MEDIUM" setting is mid-way between these two settings. Try using "FAST" if you need only a small amount of pitch change, or use "SLOW" if you need to shift the pitch by a substantial amount.

HI DAMP [0...100%]
Specifies the amount of high-frequency damping.

TRIM [0...127]
Adjusts the input level to the effect.

20. TALK MOD (Talking Modulator)

This effect gives the input signal the characteristic of a person speaking.

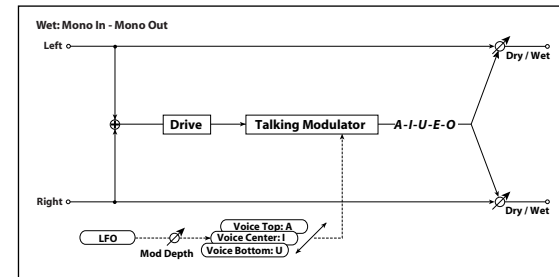

DRY/WET [DRY, 99:1...1:99, WET]
Adjusts the balance between the effect sound and the direct sound.

VO CTRL (Voice Control) [BOTTOM, -62...-01,
CENTER, +01...+62, TOP]
Controls the voice pattern.

VO TOP (Voice Top) [A, I, U, E, O]
Specifies the vowel at the top of the control range.

VO.CENTER (Voice Center) [A, I, U, E, O]
Specifies the vowel at the center of the control range.

VO.BOTTOM (Voice Bottom) [A, I, U, E, O]

Specifies the vowel at the bottom of the control range.

Example:

when VO TOP is "A," VO.CENTER is "I," and VO.BOTTOM is "U"

If MOD.DEPTH= "+63," varying the modulation source value will shift the vocal character through the vowels "Aaa" (Voice Top) → "Eee" (Voice Center) → "Uuu" (Voice Bottom).

If MOD.DEPTH= "-63," the vocal character will be shifted through the vowels "Uuu" (Voice Bottom) → "Eee" (Voice Center) → "Aaa" (Voice Top).

If MOD.DEPTH= "0," the vocal character will be fixed at "Eee" (Voice Center).

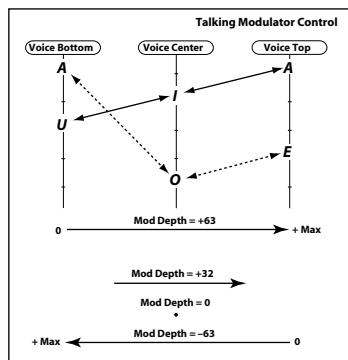

RESO (RESONANCE) [0...127]

Adjusts the strength of resonance for the voice pattern. Increasing this value will make the voice more distinctive.

DRIVE [0...127]

Adjusts the degree of distortion.

MOD.DEPTH (Modulation Depth) [-63...+63]

Adjusts the depth of modulation produced by the LFO.

RESPONSE (Mod Response) [0...127]

Adjusts the response of the modulation effect. Response will be slow at a setting of 0.

LFO SYNC (LFO Tempo Sync) [OFF, ON]

p.48 "LFO SYNC (LFO Tempo Sync)"

LFO FREQ (LFO Frequency) [0.01...100.00 Hz]

p.48 "LFO FREQ (LFO Frequency)"

SYNC.NOTE (LFO Sync Note) [8/1...1/64]

p.48 "SYNC.NOTE (LFO Sync Note)"

LFO WAVE (LFO Waveform) [SAW, SQUARE, TRIANGLE, SINE, S&H]

p.48 "LFO WAVE (LFO Waveform)"

LFO.SHAPE [-63...+63]

Adjusts the LFO waveform.

KEY SYNC (LFO Key Sync) [OFF, ON]

p.49 "KEY SYNC (LFO Key Sync)"

INI.PHASE (LFO Init Phase) [0...180°]

p.49 "INI.PHASE (LFO Init Phase)"

21. LOOPER

This effect records the samples assigned to the FX bus in stereo, and plays it back repeatedly in stereo. It also provides an OVERDUB mode that lets you layer additional material onto the recorded sound.

SWITCH [REC, LOOP.PLAY, OVERDUB]

Switches the LOOPER mode.

REC

The samples assigned to the FX bus will be recorded. Only the direct sound will be output.

LOOP.PLAY

The recorded phrase will be played back as a loop. If DIRECT.SW is "ON," the samples assigned to the FX bus will be mixed with the playback for output.

OVERDUB

While continuing to play back the recorded phrase as a loop, the samples assigned to the FX bus plus the recorded phrase will be re-recorded as a phrase.

 If you switch the FX POS setting (see p.24) while in sampling-setup mode, the phrase that was being recorded will be deleted, and the SWITCH parameter will automatically be set to "REC."

 The samples assigned to the FX bus that had been recorded until the moment you switched the mode from "REC" to "LOOP.PLAY" or to "OVERDUB" will be played back.

LENGTH [1/32...4/1]

Specifies the length of the phrase that will be played as a loop.

For example if you specify "1/1," one beat will be specified as the LENGTH.

 If the BPM does not match the phrase being recorded, LENGTH will not be specified correctly. Set the BPM to match the phrase you're recording before you change SWITCH to "LOOP.PLAY" or "OVERDUB."

 The BPM you specify will change the maximum value for LENGTH. The maximum LENGTH will be "4/1" if the BPM is higher than "80," "2/1" if the BPM is "80" or less, and "1/1" if the BPM is "40" or less. LENGTH will be re-specified according to the BPM only if LENGTH was set to the maximum value. For example if BPM is "120" and LENGTH is "4/1," and you change the BPM to "60," the LENGTH will automatically be changed to "2/1."

SPEED  [-1.000...+16.000]

Specifies the speed that the looped phrase will be played back.

Positive (+) settings will make the phrase play forward, and negative (-) settings will make it play backward. You can set the speed in a range of "0.01–16.00" times normal speed for forward playback, or in a range of "0.01–1.0" times normal speed for backward playback. The playback pitch of the phrase will change accordingly.

 This can be operated only when SWITCH is set to "REC" or "LOOP.PLAY."

DIRECT.SW [OFF,ON]

Turns the input signal on/off when SWITCH is set to "LOOP.PLAY."

Appendix

Shift functions

You can access Shift functions by holding down the [ENTER/SHIFT] button and pressing one of the following buttons or a specific key on the keyboard.

LOOP HOLD	[LOOP HOLD] button
	Holds all keys whose PLAY.TYPE is set to "LOOP ON." (☞ p.27 "1. Loop playback")
MUTE	[MUTE] button
	Mutes the samples of all keys. When you play back the pattern sequencer, none of the samples assigned to the keys will sound. (☞ p.34 "Using the mute function")
PLAY/STOP	[PLAY/STOP] button
	Plays the selected pattern sequence from the beginning of the pattern. (☞ p.21 "3. Selecting and playing patterns")
REC	[REC] button
	Executes Undo/Redo for the pattern recording operation. (☞ p.21 "2. Undoing or redoing pattern recording")
KEYBOARD	Keyboard
	Deletes the keyboard performance data recorded in the pattern. (☞ p.34 "6. Editing a pattern")
EXIT	[EXIT] button
	Executes an All Sound Off command. All sounds that are playing will stop.
FX SW	[FX SW] button
	If the selected sample is off, the [FX SW] of all keys will turn on. If the currently selected sample is on, the [FX SW] of all keys will turn off.

Shortcuts

You can use a shortcut to an edit page by holding down the [EDIT] button and pressing a key that's labeled with the name of the edit page.

Parameter list

Bank parameters	
BANK CHG (Bank Change)	☞ p.22
BANK.NAME (Bank Name)	☞ p.22
BPM	☞ p.22
AUDIO IN FX SW	☞ p.22
INIT.BANK	☞ p.23
Sampling parameters	
RATE	☞ p.23
MONO/ST	☞ p.24
TRIGGER	☞ p.24
TIME (Sampling Time)	☞ p.24
LEVEL (Sampling Level)	☞ p.24
FX POS (Fx Position)	☞ p.24
Sample parameters	
SMPL.NAME (Sample Name)	☞ p.28
PLAY.TYPE	☞ p.28
BPM SYNC	☞ p.28
REVERSE	☞ p.28
ST POINT (Start Point)	☞ p.28
END.POINT	☞ p.29
DECAY	☞ p.29
RELEASE	☞ p.29
SEMITONE	☞ p.30
TUNE	☞ p.30

Sample parameters	
LEVEL	☞ p.30
VEL INT (Velocity Intensity)	☞ p.30
PAN	☞ p.30
FX SW	☞ p.30
ORIG BPM (Original BPM)	☞ p.31
ORIG.RATE (Original Rate)	☞ p.31
DEL SMPL	☞ p.31
SWAP.SMPL	☞ p.31
LOAD.SMPL	☞ p.32
NORMALIZ (Normalize)	☞ p.32
TRUNCATE	☞ p.33

Pattern sequencer	
LENGTH	☞ p.34
KB.MD.SMPL (Keyboard Mode Sample No.)	☞ p.34
QUANTIZE	☞ p.34
DEL PTRN (Delete Pattern)	☞ p.34
SWAP.PTRN (Swap Pattern)	☞ p.35
LOAD.PTRN (Load Pattern)	☞ p.35

Global parameters	
METRONOME (Metronome)	☞ p.38
LCD.LIGHT (LCD backlight mode)	☞ p.38
PROTECT (Memory protect)	☞ p.38
AUDIO IN (Audio in mode)	☞ p.38
PTRN CHG (Pattern change mode)	☞ p.39
AUDIO IN LVL (Audio In Level)	☞ p.39
GLOBAL.CH (Global MIDI Channel)	☞ p.39
KB.MIDI.CH (Keyboard MIDI Channel)	☞ p.39
LOCAL (MIDI Local Control)	☞ p.39
MIDI.ROUT (MIDI Routing)	☞ p.39
MIDI CLK (MIDI Clock)	☞ p.40
STRT.TRIM (Start Point Auto Trimming)	☞ p.40
END TRIM (End Point Auto Trimming)	☞ p.40

Global parameters	
WRITE BANK	☞ p.41
WRITE SAMPLE	☞ p.41
WRITE PATTERN	☞ p.41

Error messages

Indication	BUSY
Cause	The operation cannot be executed because the microSAMPLER is in sampling-standby mode, currently sampling, or the sequencer is running.
Action	Stop the operation that's currently running.

Indication	BATT LOW
Cause	The data cannot be saved because the battery is low.
Action	Connect the AC adapter.

Indication	SIZE.OVER
Cause	The data size was too large to be loaded or saved.
Action	Check the data size, and reduce it.

Indication	NO.SAMPLE
Cause	The target sample was not found.
Action	Re-specify the sample.

Indication	MEM.PRTCT
Cause	Memory protect is turned on. (☞ p.38)
Action	Turn off memory protect.

Indication	ROM.BANK
Cause	When attempting to WRITE SAMPLE or WRITE SEQ, the current bank is the ROM bank.
Action	Use WRITE BANK to save all of the data.

Preset (ROM bank)

1. Samples

Key	Sample Name	Comment	
C3	HBB BD1	One Shot Samples	
C#3	HBB BD2		
D3	HBB SD1		
D#3	HBB SD2		
E3	HIPHOPBD		
F3	CLAP		
F#3	HBB HHCL		
G3	HBB TOM		
G#3	HBB HHOP		
A3	HBBHOLLW		
A#3	HBBHORN1		
B3	RESAMPL1		One Shot Re-Sample
C4	BOOSTSAW		Keyboard Samples
C#4	AC BASS		
D4	E PIANO		
D#4	ORGAN		
E4	CLAV		
F4	BRASS		
F#4	UNISYNTH		
G4	HBB BASS		
G#4	HBBHORN2	Keyboard Re-Sample	
A4	RESAMPL2		
A#4	EP LOOP		Loops
B4	GTR LOOP		
C5	BEATSICK		
C#5	MICROSMP		
D5	HIP HOP1		
D#5	REGGAETN		
E5	HIP HOP2		
F5	R&B		

Key	Sample Name	Comment
F#5	HOUSE	Loops
G5	DUBSTEP	
G#5	DR HOUSE	
A5	DR BREAK	
A#5	PERC	
B5	RESAMPL3	Full Re-Sample
C6	(AUDIO IN)	Audio In Trigger

2. Patterns

1	REGGAE
2	HIPHOP1
3	HIPHOP2
4	HOUSE1
5	HOUSE2
6	HOUSE3
7	SOUL
8	FUNK1
9	BALLAD
10	ROCK
11	BREAK
12	HBB
13	FUNK2
14	RESAMPL1
15	RESAMPL2
16	RESAMPL3

Troubleshooting

Before you suspect a malfunction, please check the following items.

Power does not turn on

- ❑ Is the AC adapter connected to an outlet? (p.14)
- ❑ Is the power switch set to the on position (pressed inward)? (p.14)
- ❑ If you're using batteries, are the batteries properly inserted? (p.14)

No sound

- ❑ Is your power amp or headphones connected to the correct connector? (p.13)
- ❑ Is your connected power amp or other system powered-on, and is the volume turned up?
- ❑ Is the [VOLUME] knob turned up so that sound will be audible?
- ❑ Is the "GLOBAL" page LOCAL setting turned "ON"? (p.39)

Sound does not stop

- ❑ If a problem occurs and a note becomes stuck, press the [ENTER/SHIFT] button and the [EXIT] button simultaneously to execute an All Sound Off.

Duplicate notes are sounded

- ❑ Is the "GLOBAL" page LOCAL setting turned "OFF"? (p.39)
If a sequencer is connected, duplicate notes may be sounded by the echo back from the sequencer (i.e., the performance data transmitted when you play the microSAMPLER is being sent back to the microSAMPLER).

The sound or operation differs from when you edited the setting

- ❑ Did you save your changes after editing? (p.41)
After editing, you must save your changes before you switch to a different bank or turn off the power.

Can't input sound

- ❑ Is your input source correctly connected to the AUDIO IN [L/MONO],[R] jacks or to the [MIC] jack? (p.13)
- ❑ If you're using the AUDIO IN [MIC] jack, is the AUDIO IN [LINE] switch set to the "MIC" position? (p.13)
- ❑ Is the AUDIO IN [GAIN] knob level turned up? (p.12)

Can't save

- ❑ Is the "GLOBAL" page "PROTECT" setting turned "OFF"? (p.38)
- ❑ If you're using batteries, could the batteries have run low? (p.14)

The microSAMPLER does not respond to MIDI data from an external device

- ❑ Is the MIDI cable or USB cable connected correctly? (p.13)
- ❑ Does the MIDI channel of the data being sent from your external MIDI device match the microSAMPLER's MIDI channel? (p.39)
- ❑ Is the "GLOBAL" page MIDI.ROUT setting correct? (p.39)

Operational noises are recorded in the sample

- ❑ When you sample a sound that's being input from the mic, the sounds of button pressing or keyboard playing might be recorded. If so, you can try either of the following two actions.

1. Automatically trim off the noises by a specified length of time. (p.40 "STRT.TRIM/END TRIM")
2. Start sampling by setting the sampling parameter TRIGGER to "THRE01-10." (p.24 "TRIGGER")

note If the sampling type is "KEY GATE," this method cannot be used since you won't be able to select "THRE01-10."

Operational noises of the microSAMPLER are a problem when using the included mic

- ❑ If operational noises are a problem when using microSAMPLER with the included mic, we recommend that you use a conventional commercially available dynamic mic mounted on a mic stand, or use a commercially available headset mic.

Specifications

Keyboard	37-note (natural-touch mini-keyboard, velocity sensitive)
Banks	8 user banks (A-H), 1 ROM bank
Sampler	
Sampling types	LOOP / ONE SHOT / GATE / AUTO NEXT / KEY GATE
Sampling sources	Audio input (☺ MIC/LINE) Resampling
Sampling rates	48 kHz / 24 kHz / 12 kHz / 6 kHz
Sampling time	Approximately 160 seconds per bank (159.7 seconds for mono, sampling rate 48 kHz)
Sample playback	
Polyphony	Maximum 14 notes (7 notes if using time stretch playback)
Playback sampling rate	48 kHz
Pattern sequencer	
Number of patterns	16 patterns per bank
Maximum number of notes	Maximum of approximately 64,000 notes per bank (maximum of approximately 16,000 notes per pattern)
Resolution	96 ticks per quarter note
Number of measures in a pattern	1-99
Recording method	Realtime recording
Effects	
Structure	One master effect During sampling, choose either one master effect or audio-in insert effect
Effect types	Choose one of 21 types

Inputs	
AUDIO IN [L/MONO], [R] jacks - rear panel	Connector: 1/4" phone jack (unbalanced) Maximum input level: -17 dBu @ GAIN: max Input impedance: 7 kΩ
AUDIO IN [☺ MIC] jack - front panel	Connector: XLR jack Maximum input level: -40 dBu @ GAIN: max Input source impedance: 14 kΩ
Output	
OUTPUT [L/MONO], [R] jacks	Connector: 1/4" phone jack (unbalanced) Maximum output level: +4 dBu @ 10 kΩ load Output impedance: 1 kΩ
Headphone jack	Connector: 1/4" stereo phone jack Maximum output level: 10 mW + 10 mW @ 32Ω load Output impedance: 10Ω
MIDI connectors	IN, OUT
USB connector	B-type connector
Display	Custom LCD
Power supply	DC9V When using batteries: six AA alkaline batteries Battery life: approximately 3 hours
Dimension (W x D x H)	516 x 238 x 65 mm / 20.31 x 9.37 x 2.56 inches
Weight	1.9 kg / 4.19 lbs
Included items	AC adapter Mic Owner's manual

* Specifications and appearance are subject to change without notice for improvement.

Index

A

AC adapter	14
All note off	45
All sound off	45
AUDIO IN.....	17, 24, 38, 39
AUDIO IN jacks.....	18
Auto Next.....	25

B

Backlight.....	38
Bank parameters.....	22
Banks	22
Banks and memory	8
Batteries	14
BPM SYNC	36, 37

C

Connection.....	13, 42
Control change	45
Current sample	18

D

Delay time.....	36
DELETE SAMPLE.....	31

E

Effect	19
Effect parameters.....	22, 36, 47
Effect processor.....	8, 36

G

Gate	25
Global MIDI channel	45

H

Holding.....	27
--------------	----

K

Key Gate	26
Keyboard	8
Keyboard LEDs	11
Keyboard mode.....	16

L

Load	32, 35
LOAD SAMPLE	32
Local Control.....	39, 43
Loop	25
Loop playback	27

M

Master volume.....	46
Memory protect.....	38
Metronome	38
Mic (included)	13
MIDI.....	42
MIDI channel	39, 43, 44
MIDI clock	40
MIDI messages	44
Mute function	34

N	
NORMALIZE	32
Note-on/off	44
NRPN	45
O	
One Shot	25
Original tempo	31
P	
Pattern	20, 33, 34, 66
Pattern length.....	34
Pattern sequence	16
Pattern sequencer	7, 8, 20, 33, 43
Pattern sequences data.....	22
Pitch.....	30
Pitch bend.....	45
Playing.....	15, 16, 27, 34
Preset	66
Q	
Quantize	34
R	
Realtime messages	46
Redo	21
Resampling.....	26
Reset all controllers.....	45
ROM bank.....	7, 15
S	
Sample.....	15, 17, 18, 19, 27, 66
Number of samples.....	23
Sample mode.....	16
Sample parameters.....	22, 28
Sampler	8
Samples data.....	22
Sampling.....	17, 23
Sampling parameters.....	23
Sampling rate	23, 31
Sampling source.....	17
Sampling time	23
Sampling type	23
Saving	41
Shift functions	64
Shortcuts	64
SWAP SAMPLE.....	31
Synchronization	43, 46
System exclusive messages.....	46
T	
Tap Tempo function.....	18
Tempo.....	18, 22, 31
Tempo parameter	22
TM RATIO.....	36
TRUNCATE.....	33
U	
Undo	21
USB	42
V	
Velocity	30
Volume.....	30

IMPORTANT NOTICE TO CONSUMERS

This product has been manufactured according to strict specifications and voltage requirements that are applicable in the country in which it is intended that this product should be used. If you have purchased this product via the internet, through mail order, and/or via a telephone sale, you must verify that this product is intended to be used in the country in which you reside. **WARNING:** Use of this product in any country other than that for which it is intended could be dangerous and could invalidate the manufacturer's or distributor's warranty. Please also retain your receipt as proof of purchase otherwise your product may be disqualified from the manufacturer's or distributor's warranty.