

## Welcome!

Congratulations and thank you for your purchase of the ENSONIQ ASR-10 Advanced Sampling Recorder, another milestone in digital sampling keyboards. The ASR-10 revolutionizes the way sampling is integrated into a workstation, by including 24-bit dynamic effects processing and allowing the stereo audio input to be monitored, sampled, and resampled through the effects. And only ENSONIQ offers all the expressive control that turns a sampler into a truly musical instrument.

## Sampling

The ASR-10 features true stereo Sigma-Delta (one-bit) 64 times oversampling technology with a selectable sample rate of 30kHz or 44.1 kHz. Samples can be recorded from a variety of input sources including: the stereo audio inputs, the optional DI-10 Digital I/O Board (consumer AES/EBU digital interface) or the ASR-10's own Main Audio Output (for resampling). The ASR-10 can sample while the sequencer is playing, and can even sample its own sequencer playback. CD quality output circuitry provides state of the art playback performance. The ASR-10 has all the on-board editing functions you'll ever need. Autolooping, volume smoothing, gain normalization, and multiple types of crossfading provide complete control over your sampled sounds.

An advanced Time Compression/Expansion function allows you to change the length or tempo of a sample without affecting the pitch, a necessity for dance music or broadcast needs.

## Synthesis Functions

Not only does the ASR-10 provide superb stereo sampling, it is also a full function synthesizer, allowing you to reshape your sampled sounds with maximum flexibility. 31 voice polyphony, multiple filters and envelopes, and a comprehensive modulation matrix gives the ASR-10 the power to manipulate your WaveSamples into many exciting new sounds.

## Effects

The ASR-10 incorporates effects processing into a sampler in new and exciting ways — with 50 different 24-bit effect algorithms, the ASR-10 provides a complete arsenal of signal processing and conditioning tools for your use. State-of-the-art Reverbs, Chorusing, Flanging, Phasing, Distortion, Digital Delays, and Speaker Effects, will make your sampled sounds and sequenced music sound totally professional. Signal conditioning effects, like EQ, Compression, and Ducking can be used to process sounds as they are being sampled to get the perfect sound every time.

The ASR-10 offers continuous audio monitoring of the stereo audio inputs on two dedicated Audio Tracks. The audio inputs can be monitored through the effects and if desired, audio input can be sampled through the effects. Audio Tracks also allow live external signals to play through the effects processor, so that you can use the ASR-10's high quality effects on other instruments in your rig, or allow fellow musicians to plug right in and play — no mixer required! The ASR-10 also has the ability to resample sounds with effects in real time. For example: add reverb to a drum sample, resample it, then reuse the effects processor to further color your music.

## Sequencing

The ASR-10 is also a 16-track sequencing workstation with complete mixdown capabilities. You can record and edit your performances with a wealth of creative tools. And only ENSONIQ sequencers allow you to audition your changes to decide which version to keep. This flexible combination of high fidelity sampling and synthesis, versatile effects processing, and sequencing is what makes the ASR-10 unique.

## Audio Track Recording Capability

Version 2 O.S. adds two tracks of *digital audio recording* capability to the ASR-10. Audio Tracks can be recorded directly into RAM (RAMTracks™) or directly to a SCSI storage device (hard disk, removable media, etc.) via the optional SP-3 SCSI Interface (DiskTracks™). Now you can combine live performances with MIDI sequenced tracks for full production recording within the ASR-10. Sing, play your guitar, blow your horn — add whatever live performances you wish. Recognizing that you want to get up and running quickly, we strongly recommend that you try the section titled “An Audio Track Tutorial” in *Section 18 — Audio Track Applications* to get a feel for the Audio Track recording process.

## Support for the Optional DI-10 Digital I/O Interface

ASR-10 Version 2 supports the optional DI-10 Digital I/O Interface. When installed, the DI-10 provides direct digital input and output connection to and from the ASR-10 using RCA-type connectors. The **Digital Output** will provide 44.1 kHz digital output of the Main Out mix when the current effect uses a 44.1 kHz sample rate. The **Digital Input** can be used for direct digital sampling from an external digital audio source at 44.1 or 48 kHz.

The Digital Input and Output conforms to the S/PDIF standard (Sony/Phillips Digital Interface Format). S/PDIF is a digital audio communication standard for digital hardware devices. Be sure that any digital devices used with the DI-10 conform to this standard. For more information about using the DI-10 Digital I/O Interface, refer to the DI-10 Manual.

**Note:** If you wish to record the 44.1 kHz digital output of the ASR-10 to a DAT recorder, the DAT recorder must be able to record from its digital input at 44.1 kHz. Some older/consumer DAT recorders do not record at 44.1 kHz as a copy protection scheme: *These DAT recorders will not record the ASR-10's 44.1 kHz digital output.*

## Additional 44.1 kHz Effect Algorithms

The O.S. disk also includes 12 additional effect algorithms, designed exclusively for the ASR-10, that use the 44.1 kHz system sample rate (note: polyphony is reduced to 23 voices). Audio Tracks recorded at the 44.1 kHz sample rate can be output directly from the ASR-10's Digital I/O Output jack (which requires the optional DI-10 Digital I/O Interface). For a complete description of all the effect algorithms, see later in this document.

## Clean Up and Maintenance

Only clean the exterior of your ASR-10 with a soft, lint-free, dry (or slightly damp) cloth. You can use a slightly dampened cloth (with a mild neutral detergent) to remove stubborn dirt, but make sure that the ASR-10 is thoroughly dry before turning on the power. Never use alcohol, benzene, volatile cleaners, solvents, abrasives, polish or rubbing compounds.

## About The Manual

The Musician's Manual is your guide to unlocking the full power of the ASR-10. At this point, you're probably anxious to plug in your ASR-10 in and get playing. The rest of this section contains important information about power, grounding, amplification and care of the floppy drive. We recommend that you read through it, and then follow the Tutorial. The Tutorial is designed to provide step-by-step procedures for performing basic operations on the ASR-10.

After the initial “I just gotta hear it” phase has passed and you're ready to utilize the full potential of the ASR-10, please take the time to read through the sections in this manual on sampling, programming, sequencing, effects, and storage. The Musician's Manual is designed to be used as a reference tool. Both manuals provide valuable information and tips that will speed up the learning process and ensure your maximum enjoyment of this powerful musical instrument.

Thank-you again for choosing ENSONIQ. Enjoy the music!

## Power

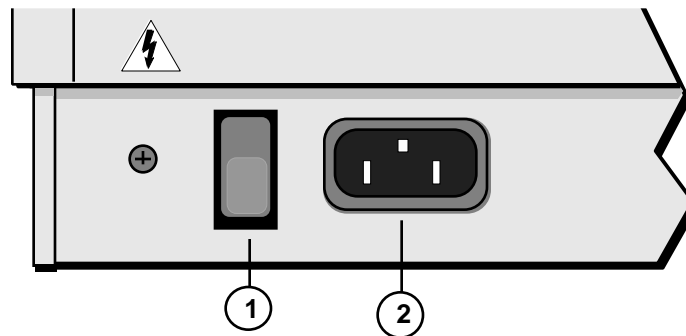

Insert the line cord into the line receptacle on the back of the ASR-10 (2), next to the power switch (1). Plug the other end of the cable into a grounded AC outlet. The proper voltage for your ASR-10 is listed on the Serial Number label on the rear panel. Turn the ASR-10 power on and make sure the display lights up. If not, check your connections and power source.

## Power — Polarization and Grounding

Like many modern electrical devices, your ASR-10 has a three-prong power cord with earth ground to ensure safe operation. Some products have power cords with only two prongs and no earth ground. To ensure safe operation, modern products with two-prong power cords have polarized plugs that can only be inserted into an outlet the proper way. Some products, such as older guitar amplifiers, do not have polarized plugs and can be connected to an outlet incorrectly. This may result in dangerous high voltages on the audio connections that could cause you physical harm or damage any properly grounded equipment to which they are connected, such as your ENSONIQ product.

**To avoid shock hazards or equipment damage, we recommend the following precautions:**

- If you own equipment with two pronged power cords, check to see if they are polarized or non-polarized. You might consider having an Authorized Repair Station change any non-polarized plugs on your equipment to polarized plugs to avoid future problems.

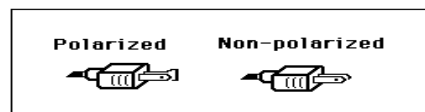

- Exercise caution when using extension cords or plug adapters. Proper polarization should always be maintained from the outlet to the plug. The use of polarized extension cords and adapters is the easiest way to maintain proper polarity.
- Whenever possible, connect all products with grounded power cords to the same outlet ground. This will ensure a common ground level to prevent equipment damage and minimize hum in the audio output.

AC outlet testers are available from many electronic supply and hardware stores. These can be used to check for proper polarity of outlets and cords.

## Ground Loops

Sometimes currents flowing through the ground line generate a signal seen by another part of the circuit sharing the same ground. In other words, if there are two identical signal paths within a circuit, they can form a loop which can result in hum and/or noise. If you are using equipment that has 3-prong “grounded” AC power cords, you may suffer from a ground loop resulting from the interconnection of this equipment. The following diagram shows how cascading or “chaining” the output of one 3-prong grounded system into the input of another 3-prong grounded system with a standard unbalanced 2 conductor cord (like a 1/4” guitar cable) can result in a ground loop.

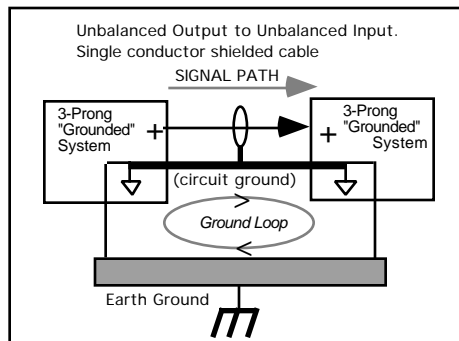

FIG. 1

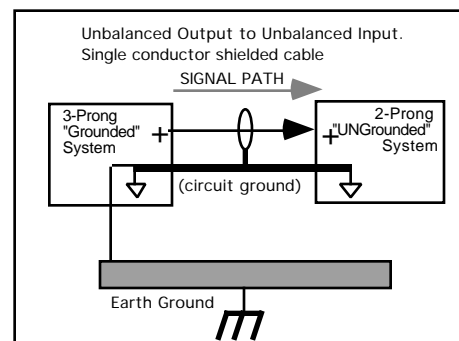

FIG. 2

Fig. 1 depicts a system interconnection where a ground loop can exist. Fig. 2 depicts a system interconnection where a ground loop does NOT exist. When interconnecting 3-prong grounded systems, you can use signal isolation transformers to prevent ground loops. This coupling transformer effectively isolates two interconnected system signal grounds, while still allowing the signal to pass through.

## AC Line Conditioning

As is the case with any computer device, the ASR-10 is sensitive to sharp peaks and drops in the AC line voltage. Lightning strikes, power drops or sudden and erratic surges in the AC line voltage can scramble the internal memory and, in some cases, damage the unit's hardware. Here are a few suggestions to help guard against such occurrences:

- **A Surge/Spike Suppressor.** The cheaper of the options, a surge/spike suppressor absorbs surges and protects your gear from all but the most severe over-voltage conditions. You can get multi-outlet power strips with built-in surge/spike suppressors for little more than the cost of unprotected power strips, so using one is a good investment for all your electronic equipment.
- **A Line Conditioner.** This is the best, but by far the more expensive, way to protect your gear. In addition to protecting against surges and spikes, a line conditioner guards the equipment against excessively high or low line voltages. If you use the ASR-10 in lots of different locations with varying or unknown AC line conditions, you might consider investing in a line conditioner.

## Amplification

Connect the Main Audio Outputs of the ASR-10 to the line level inputs of a mixer, instrument amplifier, stereo, or any other sound system, using 1/4 inch audio cables. If your system is stereo, connect the Left and Right Main Outputs to two channels of your mixer, stereo, etc. If it's mono, use either of the Main Audio Outputs, but make sure nothing is plugged into the other output. For listening through headphones, plug the phones into the rear panel jack marked **Phones**. If you're running the ASR-10 through a mixer, in stereo, be sure to pan the left input channel on the mixer fully left, and the right input channel fully right.

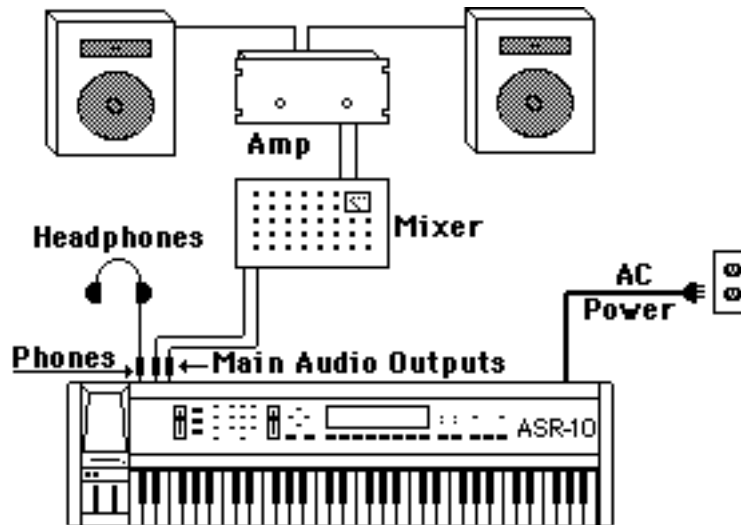

It is a good idea to make sure your audio system is turned off (or down) when making connections, to avoid damaging speakers or other components.

**Note:** The ASR-10 outputs are line-level, and are intended to be connected only to line-level inputs, such as those on a mixer, stereo pre-amp, keyboard amp, etc. Connecting the ASR-10 audio outputs to a mic-level input, such as a guitar amp or the microphone jacks on a tape deck, is not recommended, and might result in damage to the device input.

Move the **Volume Slider** all the way up. As with any digital musical instrument, the ASR-10 will give the best results if you keep the **Volume Slider** full on, and use the volume control on your mixer or amp to adjust its level.

Switch the audio system on, and adjust the amplifier volume for normal listening levels. If you hear no sound while playing the keyboard, switch the audio system off and check your connections.

## Running Your ASR-10 Through a Home Stereo System

If you are thinking about amplifying your ASR-10 through your home stereo, a word of caution is in order. A home stereo is great for playing CD's, albums, tapes — the dynamic range of these media is limited, and your speakers aren't usually subjected to extreme volume changes and frequency transients. While the dynamic range of CD's is significantly greater than LP's or tapes, the output of a CD player is still conservative compared to the uncompressed, unlimited line-level output of a pro-level keyboard. Running your ASR-10 — or any pro-level keyboard through a home stereo at high volume levels can damage your speakers, not to mention the impedance mis-match this can create. If your only means of amplification is your home stereo, then try to keep your levels on the conservative side.

## Care and Feeding of the Disk Drive

The ASR-10's built-in disk drive is used to store all your Instruments, Banks, and Sequencer data, as well as System Exclusive messages from other MIDI devices. The ASR-10 uses a Quad-density disk drive that can store 1600 Kilobytes of data on a Double-Sided High-Density (DSHD) 3.5" micro-floppy disk and 800 Kilobytes of data on a Double-Sided Double-Density (DSDD) 3.5" micro-floppy disk. The disks are enclosed in a protective plastic carrier with an automatic shutter to protect the diskette from physical damage. It is important not to alter this carrier in any way.

The 3.5" disks have a sliding write-protection tab so that you can protect your sounds and sequences against accidental erasure. Sliding the write-protection tab in the lower left corner of the disk so that the window is closed will allow you to store information on the disk. Sliding the tab so that the window is open will protect the disk against being accidentally reformatted or having files deleted. Double-Sided High Density disks can be easily identified because they have an additional window (with no write-protection tab) located on the lower right corner of the disk.

### Double-Sided High-Density (DSHD)

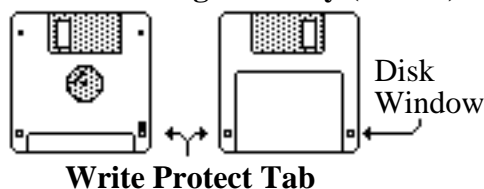

### Double-Sided Double-Density (DSDD)

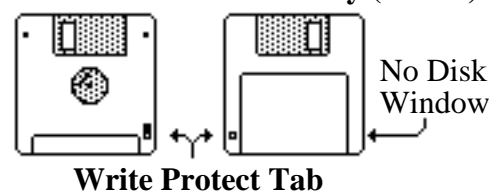

Floppy disks are a magnetic storage medium, and should be treated with the same care you'd give important audio tapes. Just as you would use high quality audio tapes for your important recording needs, we recommend using high quality floppy disks for your ASR-10. Here are a few Do's and Don't's concerning disks and the disk drive.

### Do's:

- Use either Double-Sided High-Density (DSHD) or Double-Sided Double-Density (DSDD) 3.5 inch Micro-floppy disks. Both types are available from almost any computer store and many music stores carry them as well.
- Keep your disks and the disk drive clean and free of dust, dirt, liquids, etc.
- Label your disks and keep a record of what is saved on each.
- Only transport your unit with nothing in the drive.

### Don't's:

- Don't use Single-Sided (SSDD or SSSD) disks. These disks have not passed testing on both sides. While a single-sided disk might work successfully with the ASR-10, it is possible that you will eventually lose important data to a disk error if you try using Single-Sided disks.
- Don't put anything other than a disk or the plastic sheet in the disk drive.
- Don't transport the unit with a disk in the drive.
- Don't expose disks to extremes of temperature. Temperatures below 50° F and above 140° F can damage the plastic outer shell.
- Don't expose your disks to moisture.
- Don't dry your disks in a microwave oven.
- Don't subject disks to strong magnetic fields. Exposure to magnetic energy can permanently damage the information on the disk. Keep disks away from speaker cabinets, tape decks, power cables, airline x-ray equipment, power amplifiers, TV sets, and any other sources of magnetic energy.
- Don't eject the disk while the drive is operating (i.e. when the disk drive light is on).

### Backing-up the O.S. Disk

Since floppy disks are vulnerable to the affects of magnetic fields, we highly recommend making back-up copies of your O.S. disk. Doing so can save time and frustration in the unlikely event that the O.S. disk becomes damaged. Since the tutorial files and the additional 44.1 kHz effect algorithms are on the O.S. disk, you will need a HD (high density) disk to save all of the information. We'll use the COPY FLOPPY DISK command to back up the disk. Here's how:

1. Slide open the plastic write-protect tab on the original O.S. disk (you should be able to see through the little square hole) so that the disk is write-protected (protected from being written to). This is an extra precaution to safeguard the data.
2. Press **Command**, then **System•MIDI**, and scroll to the COPY FLOPPY DISK command.
3. Press **Enter•Yes**.  
The display shows INSERT SOURCE DISK (the one you want to copy).
4. Insert the source disk, then press **Enter•Yes**.  
The drive will engage and the display will flash READING SOURCE DISK. Once the drive stops, the display will change to show INSERT DEST DISK.
5. Insert the destination disk (the one you want to copy to) and press **Enter•Yes**.  
If the destination disk is unformatted, the display will ask ERASE AND FORMAT DISK?  
Press **Enter•Yes** to format the disk. When formatting is complete, the drive will engage and the display will flash WRITING DEST DISK.  
After writing to the destination disk, the display will read VERIFYING DEST DISK. If the copy is complete, the display will read DISK COMMAND COMPLETED.

If you do not want to copy all of the tutorial files or the 44.1 kHz effect algorithms, use the **Command/System•MIDI**, COPY O.S. TO DISK command (as described in *Section 2 — System•MIDI*).

We recommend that you use the copied O.S. disk for daily use, and store the original O.S. disk in a safe place. If your O.S. disk becomes damaged and you do not have a back-up copy made, your local Authorized ENSONIQ Dealer can make a new copy for you (you must supply the disk).



## Accessories

These optional accessories are available from your Authorized ENSONIQ Dealer:

- **OEX-6sr Output Expander** — The OEX-6sr gives the ASR-10 six additional outputs, grouped in three stereo pairs in addition to the built-in stereo outputs. Each WaveSample, or an entire instrument/track can be assigned to any of the stereo pairs and panned within the stereo field.
- **SP-3 SCSI Kit** — This SCSI (Small Computer Serial Interface) allows the ASR-10 to communicate with a hard drive, CD ROM player, or computer. Hard drives provide a faster, more convenient way to store instrument, sequencer, bank, and MIDI files. The SP-3 *must* be installed by an Authorized ENSONIQ Repair Station.
- **DI-10 Digital I/O Board (S/PDIF)** — Allowing digital input and output using RCA-type connectors. The DI-10 *must* be installed by an Authorized ENSONIQ Repair Station.
- **Model CVP-1 CV PEDAL** — A *Control Voltage Foot Pedal* which can be assigned as a modulator within the voice section of the ASR-10 or used as a volume pedal.
- **ENSONIQ Model SW-10 Dual Foot Switch** — Can be used for hands-free patch select control (when plugged into the Patch Select jack) or used for modulation control, voice sustain, or starting, stopping, and continuing the internal sequencer (when plugged into the Foot Switch jack).
- **ENSONIQ Model SW-6 Foot Switch** — A single damper piano style foot switch, for sustain, or to function as the right patch select button.
- **CDR Series** — These CD ROMs offer a vast array of instruments, banks, and sequence/song arranged in directories by file types. The CDR Series also features Direct Macros, which allows instant access (direct-dial) to any instrument file.
- **AS -Series Sound Libraries** — The AS sound libraries are designed exclusively for the ASR-10, provided on five High Density disks.
- **SL, SLT, and ESS Sound Libraries** — The ASR-10 can read all of the disks designed for the EPS Series. These disks offer the largest, most accurate, responsive, and musical sampled sounds available anywhere. These sounds are divided into three separate libraries: SL, a series of five-disk sets featuring sounds specifically designed for the EPS-16 PLUS, but fully compatible with the ASR-10; SLT, a series of ten-disk packs originally designed by top sound programmers for the EPS, also compatible with the ASR-10; and ESS, three-disk “Signature Series” sets designed by renowned industry performers and producers like Joey DeFrancesco, Jason Miles, Maurice White, The System, Nile Rodgers, David Hentschel, and others.

## An Important Note About Non-ENSONIQ Accessories and Your ENSONIQ

### Warranty

ENSONIQ highly recommends that users who wish to add SCSI or a Digital I/O Interface to their ASR-10 use ENSONIQ-made accessories. However, for those who wish to purchase a non-ENSONIQ product, there are some important things to know about non-ENSONIQ products and your ASR-10's warranty:

- **ENSONIQ will not approve any Non-ENSONIQ SCSI kits or Digital I/O Interfaces for the ASR-10.**
- If your ASR-10 requires servicing, and a non-ENSONIQ accessory is installed, ASR-10 owners will pay a service fee to have it removed so that a technician can diagnose the base unit.
- **If it is determined that the use of an unapproved Non-ENSONIQ product caused damage, then the repair of that damage is not covered by the ENSONIQ warranty.** Any non-ENSONIQ product which requires opening the case must be installed by an Authorized ENSONIQ Repair Station.
- In addition, if it is found that continued use of a non-ENSONIQ product causes damage to your ASR-10, any future service that your unit might require may not be covered under the ENSONIQ warranty.

## Need More Help?

Whether you're an aspiring programmer looking for additional information about basic sampling techniques and MIDI theory, or a professional sound designer working with advanced applications, you may want more detailed information that is beyond the scope of this manual. The following books can help enhance your understanding of sampling, synthesis, MIDI, and related topics. These, in addition to the numerous monthly magazines, provide a wealth of information. While we don't endorse any one of these publications, we offer this partial list as a resource for you to draw on.

### The Mix Bookshelf

For prices and more information call: 1-800-233-9604

#### MIDI

*MIDI FOR MUSICIANS*, Craig Anderton  
*THE MIDI MANUAL*, David Huber  
*THE MIDI HOME STUDIO*, Howard Massey  
*THE NEXT MIDI BOOK*, Rychner & Walker  
*THE MIDI BOOK*, Steve De Furia, Joe Scacciaferro  
*THE MIDI RESOURCE BOOK*, Steve De Furia, Joe Scacciaferro  
*HOW MIDI WORKS*, Dan Walker  
*MIDI SYSTEMS & CONTROL*, Francis Rumsey  
*USING MIDI*, Helen Casabona, David Frederick  
*MIDI, THE INS, OUTS AND THURUS*, Jeff Rona

#### SAMPLING

*THE SAMPLING BOOK*, Steve De Furia, Joe Scacciaferro  
*SAMPLING BASICS*, Bobby Maestas

#### SYNTHESIZERS

*GUITAR SYNTH & MIDI*, Guitar Player Magazine  
*SECRETS OF ANALOG AND DIGITAL SYNTHESIS*, Steve De Furia  
*SYNTHESIZER PERFORMANCE & REAL TIME TECHNIQUES*, Jeff Pressing  
*SYNTHESIZER BASICS*, Dean Friedman  
*MUSIC & TECHNOLOGY*, H.P. Newquist  
*A SYNTHESIST'S GUIDE TO ACOUSTIC INSTRUMENTS*, Howard Massey

### Alfred Publishing Company

For prices and more information call 1-818-891-5999

#### MIDI

*ADVANCED MIDI APPLICATIONS*, GPI  
*BASIC MIDI APPLICATIONS*, GPI  
*WHAT IS MIDI?*, GPI

#### SYNTHESIZERS

*BEGINNING SYNTHESIZER*, GPI  
*PLAYING SYNTHESIZERS*, GPI  
*SYNTHESIZER PROGRAMMING*, GPI

### Hal Leonard Publishing

For prices and more information call 1-414-774-3630

*MIND OVER MIDI*, GPI  
*SYNTHESIZER TECHNIQUE (REVISED)*, GPI

## **Monthly Magazines**

The following magazines offer many specific articles and columns that can provide a plethora of useful information.

### **THE TRANSONIQ HACKER**

For prices and more information about this independent news magazine for ENSONIQ Users, call 1-503-227-6848

### **KEYBOARD**

For subscription rates and more information call 1-800-289-9919

### **ELECTRONIC MUSICIAN**

For subscription rates and more information call 1-800-888-5139

### **HOME & STUDIO RECORDING**

For subscription rates and more information call 1-818-407-0744

### **MIX**

For subscription rates and more information call 1-800-888-5139

### **EQ**

For subscription rates and more information call 1-212-213-3444

# Section 1 — Controls & Architecture

This section provides an introduction to the ASR-10's many controls and rear panel connections, a conceptual overview of the system, a guide to understanding memory, and a discussion of editing various types of parameters. We suggest you read this section carefully — it will help you get the most out of your ASR-10.

## Rear Panel Connections

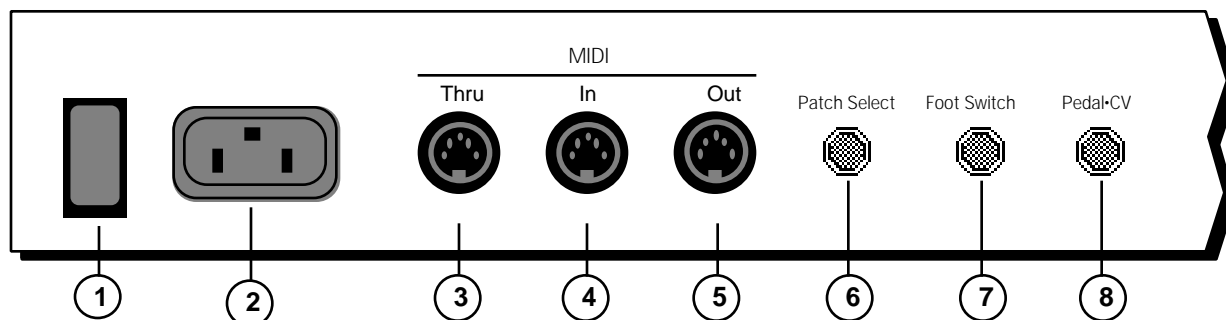

### 1) Power

The power switch turns the ASR-10 on and off. When you turn the power on, the display lights up and shows “PLEASE INSERT DISK,” which is the prompt to load the operating system.

### 2) AC Line In

The supplied line cord connects here. The correct voltage for the ASR-10 is on the rear panel along with the serial number. If you travel, remember the ASR-10 will only operate on the listed voltage.

### 3) MIDI Thru

This jack “passes on” all MIDI (Musical Instrument Digital Interface) information received by the ASR-10 to other MIDI devices. Information generated by the ASR-10 itself does not go to this jack — the Thru jack merely echoes what comes into the MIDI In jack.

### 4) MIDI In

This jack receives MIDI information from other MIDI instruments or computers.

### 5) MIDI Out

This jack transmits MIDI information generated by the ASR-10 keyboard and/or sequencer to other instruments and computers.

### 6) Patch Select (Foot Switch)

If you connect the optional SW-10 Dual Foot Switch in this jack, it duplicates the function of the Patch Select buttons, allowing hands-free patch select changes. This jack requires a dual foot switch and *will not* work properly with a single foot switch (SW-2 or SW-6).

### 7) Foot Switch

This jack supports either one or two foot switches depending on what is plugged into it:

- If you plug the ENSONIQ Model SW-2 Foot Switch (which came with your ASR-10) into this jack, it will act as a Sustain pedal. Holding it down will cause notes to continue to sustain after the key has been released.
- Or you can connect the optional ENSONIQ Model SW-10 Dual Foot Switch here. The SW-10 is a dual (piano-type) foot switch with two separate pedals. When the SW-10 is connected, the Right Foot Switch will act as a sustain pedal and the Left Foot Switch is assignable.

**Note:** If you are using a single foot switch (SW-2 or SW-6), the Edit/System•MIDI, LEFT FOOT SW parameter should be set to OFF. This will prevent unexpected behaviour. Remember that the Foot Switch jack is optimized for use with a dual foot switch (SW-10), and when a single foot switch is connected, it behaves like the Right Foot Switch.

When the SW-2 is connected to the Foot Switch jack:



It acts as the Sustain Pedal.

When the SW-10 is connected to the Foot Switch jack:

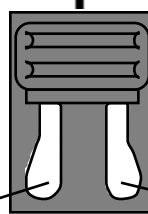

The Left Foot Switch is assignable.

The Right Foot Switch acts as the Sustain Pedal.

A parameter on the Edit/System•MIDI page (press **Edit**, then **System•MIDI**, then scroll until the display reads “LEFT FOOT SW=OFF”) determines the function of the Left Foot Switch.

- Tip:** The Sustain pedal can be used to dynamically “latch” the current amount of pressure being exerted on the keyboard. Here's how:
- 1) Select a sound that responds to pressure. Choose a sustaining sound like an organ.
  - 2) Play a key and press into the keyboard until you can hear the pressure modulation affect the sound of the note.
  - 3) Press and hold the Sustain pedal.
  - 4) Release the key. You will hear that the sound continues to be modulated by pressure at the depth to which you were pressing.
  - 5) Play a different key. Notice that the new note is not modulated. You can now press into the keyboard and modulate the new note independent of the note that is sustained. When the current pressure output exceeds the latched level, pressure on the new note will modulate both notes.
  - 6) To release the “latched” pressure value on the sustained note, either press the “latched” key again, or release the Sustain pedal.

**8) Pedal•CV**

This jack is for connecting an optional ENSONIQ Model CVP-1 Control Voltage Foot Pedal, which is assignable as a modulator to various parameters within the ASR-10. The pedal gives you a handy alternative modulation source when, for example, you would want to use the Mod Wheel but both hands are busy.

ENSONIQ  
CVP-1  
Control Voltage Foot Pedal



A CV pedal plugged into this jack can also act as a Volume pedal, controlling the volume of the currently selected **Instrument•Sequence Track(s)**. A parameter on the Edit/System•MIDI page (press **Edit**, then **System•MIDI**, then scroll until the display reads PEDAL=VOLUME MIDI=7), determines whether the CV pedal will act as a modulator or as a volume pedal. Set to PEDAL=VOLUME to use the CV pedal to control volume.

Pedal/CV Specs: 3-conductor (Tip= control voltage input, Ring=510 ohm resistor to +5 Volts, Sleeve= ground). 36 KOhm input impedance, DC coupled. Input voltage range=0 to 3 volts DC. Scan rate=32mS (maximum recommended modulation input= 15 Hz). For use with an external control voltage, use a 2-conductor cable with the voltage on the tip and the sleeve grounded.

## Rear Panel Connections Cont'd.

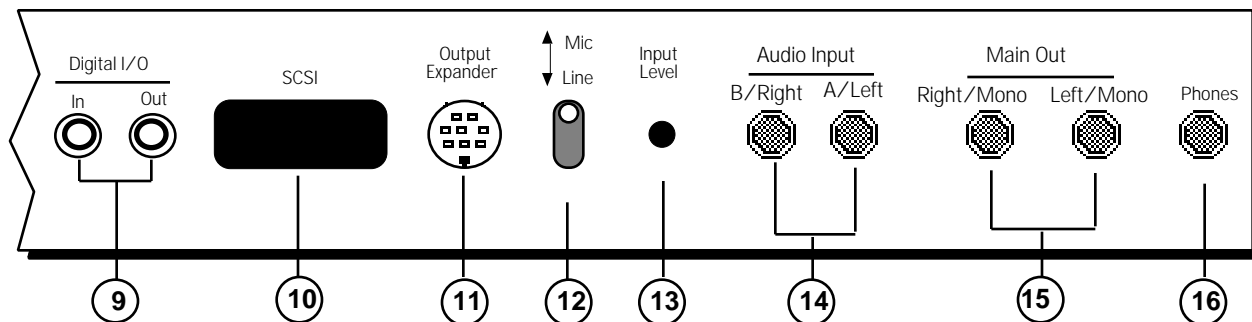
**9) Digital I/O — Input/Output**

The DI-10 Digital I/O Interface (S/PDIF) provides direct Digital Input and Output connection to and from the ASR-10 using RCA-type connectors. The Digital Output will provide direct 44.1 kHz digital audio output of the Main Output mix when the current effect uses a 44.1 kHz sample rate. The Digital Input can be used for direct digital sampling from an external digital audio source at 44.1 or 48 kHz.

The Digital Input and Output conforms to the S/PDIF standard.

**Note:** If you wish to record the 44.1 kHz digital output of the ASR-10 to a DAT recorder, the DAT recorder must be able to record from its digital input at 44.1 kHz. Some older/consumer DAT recorders do not record at 44.1 kHz as a copy protection scheme: *these DAT recorders will not record the ASR-10's 44.1 kHz digital output.*

**10) SCSI Interface**

This space is for the optional SP-3 SCSI kit that allows the ASR-10 to transfer data to and from a SCSI-compatible hard disk, CD ROM player, or exchange information with computers at very high speed.

**11) Output Expander (AUX 1, 2, 3)**

This multi-pin connector is used to connect the optional OEX-6sr Output Expander box, which provides the ASR-10 with three pairs of stereo outputs (or 6 individual outs) *in addition* to the built-in stereo outputs. Each WaveSample, or an entire **Instrument • Sequence Track**, can be assigned to any of the three AUX stereo pairs and can be independently panned within the stereo field.

**12) Mic/Line Switch**

This switch is used to change between either a mic (up) or a line (down) level input source.

**13) Input Level Trim Control**

This knob allows you to amplify the level of the external signal source.

**14) Audio Input — B/Right and A/Left**

These jacks are the Right and Left Audio Inputs into the ASR-10 for sampling or Audio Track monitoring of external analog audio sources.

SPECS: 140 KOhm input impedance, AC coupled. The Audio Inputs have 2 ranges: Line and Mic. With the Mic/Line switch set to Line, the ASR-10 will accommodate signals from +15.5dBV (Input Level Trim control fully counterclockwise) to -16.5dBV (Input Level Trim control fully clockwise). With the Mic/Line switch set to Mic, the ASR-10 will accommodate signals from -11.5dBV (Input Level Trim control fully counterclockwise) to -43.5dBV (Input Level Trim control fully clockwise). Matching the appropriate input level with the correct settings of the Mic/Line switch and Input Level Trim control will bring the external signal source up to clipping level.

**15) Main Out — Right/Mono and Left/Mono**

To operate the ASR-10 in stereo, connect these outputs to two discrete channels of your mixer and pan the mixer channels right and left. Note that *either* of the audio outputs can be used as a mono output. If you want to listen to the output in mono, make sure that only one of the output jacks is connected.

**16) Phones**

To listen to the ASR-10 in stereo through headphones, plug the phones into this jack. The phones output contains a mix of the signal from the main outputs. Headphone volume is controlled by the volume slider on the front panel. Note that plugging headphones into this jack *does not* automatically turn off the audio in the right and left outputs.



## Front Panel Controls

Almost everything you do on the ASR-10 — whether it's selecting a sound, editing that sound, adjusting the tuning, etc. — is controlled from the front panel using the following controls:

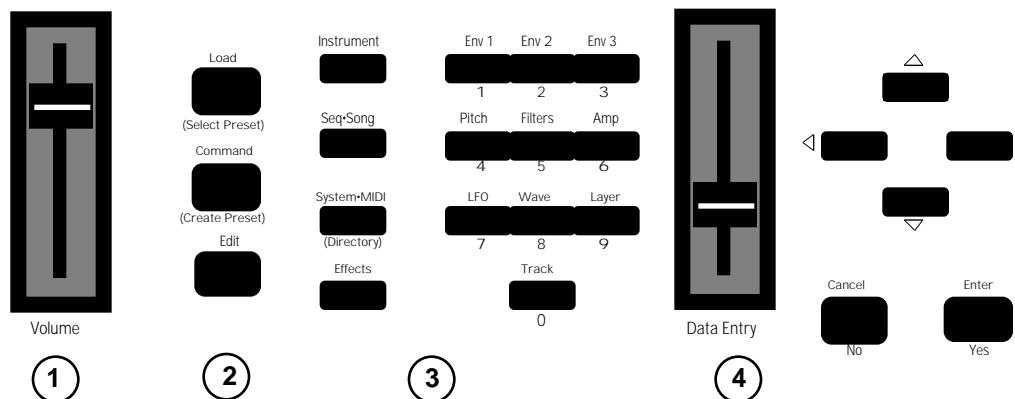

### 1) Volume Slider

This controls the overall volume of the ASR-10 audio outputs.

### 2) Mode Buttons

These three buttons are the key to finding your way around the ASR-10. The ASR-10 is *always* in one of these three *Modes* — LOAD, COMMAND, or EDIT. The current mode is selected by pressing the appropriate mode button. The highlighted word in the upper left corner of the display tells you which is the current mode.

- LOAD mode is the one you will be in most often — since the ASR-10 lets you continue playing while loading sounds and sequences, LOAD mode also doubles as the “Performance” mode. When the LOAD indicator is flashing, the display is showing you disk files for loading. When the LOAD indicator is lit but not flashing, the display is showing you the name(s) of the instruments in the Internal Memory.

**Tip:** In flashing LOAD mode (when the LOAD indicator is flashing), successive presses of the **Instrument**, **Seq•Song**, **System•MIDI**, or **Effects** buttons will scroll through the available files of that type on the selected storage device.

- COMMAND mode is used to execute a wide variety of commands, such as: saving instruments, banks, and sequences to disk; copying instruments, layers, and WaveSamples from one internal location to another; creating and modifying sequences and songs; and manipulating WaveSamples and their loops in various ways... just to name a few.

**Tip:** In COMMAND mode, successive presses of each of the 14 page buttons will scroll through the Command screens, one at a time.

- EDIT mode is used to select and modify a great many variables — or parameters — ranging from the volume of a WaveSample, to the velocity response of the instrument, to the MIDI In Mode. Edit mode is also the mode in which all sequence recording and mixing is done.

**Tip:** In EDIT mode, successive presses of each of the 14 page buttons will scroll through the Edit screens, one at a time.

### 3) Page Buttons

Within each mode, the available disk files, commands, and parameters are organized into *Pages*. A page is selected by pressing one of these fourteen page buttons. Once you are on the correct page, you use the **Data Entry Controls** to scroll through the files, commands or parameters on the page. A given page will have different functions depending on the current mode. Each mode has a different set of pages available. Not all fourteen page buttons are active in all three modes.

The ten *numbered* page buttons also double as a numeric keypad for “direct-dialing” a given disk file, command, or parameter or for sending MIDI Program Changes.

### 4) Data Entry Controls

Once you are in the desired mode and have selected the proper page, you use the controls in the data entry section to: locate and load the desired file (in Load mode); locate and execute the desired command (in Command mode); or locate and modify the value of the desired parameter (in Edit mode).

- The **Data Entry Slider** and the **Up** and **Down Arrow** buttons will: move through the files on the current disk or directory (in flashing LOAD mode); change the value of the current parameter (in Edit mode); or respond when the ASR-10 asks you for further input during the execution of a command (in Command mode).
- The **Left** and **Right Arrow** buttons are used primarily to move to the next parameter or command on the current page.

**Tip:** To advance by screens (instead of by parameters), while holding down the **Right Arrow** button, press the **Up Arrow** button, or while holding down the **Left Arrow** button, press the **Down Arrow** button.

- The **Enter•Yes** and **Cancel•No** buttons are used to either proceed with or cancel the function currently showing on the display.

**Tip:** When editing any parameter, pressing **Cancel•No** will reset the parameter to the value it was set to before it was last edited.

**Tip:** In Load mode, successive presses of the **Cancel•No** button will alternate between solid and flashing Load modes.

**Tip:** When editing any parameter that has a center value, there is an easy way to reach that value. While holding down the **Down Arrow** button, press the **Up Arrow** button, then quickly release both buttons.

## Parametric Programming

The method used to modify or edit programs, presets and system parameters is called Page-driven Parametric Programming, which sounds like a mouthful, but don't worry. Once you've grasped a few basic concepts you'll find that operating the ASR-10 is quite simple, given its many capabilities.

It is likely that you have already encountered some form of parametric programming on other synthesizers or samplers. What this means is that instead of having a separate knob or slider for each function, you have one master **Data Entry Slider** and the **Up/Down** and **Left/Right Arrow** buttons, which adjust the value of whichever parameter you select.

This approach has many advantages, the most obvious is that it greatly reduces the amount of hardware — knobs, switches, faders, etc. needed to control a wide variety of functions. If the ASR-10 had a separate control for each function, it would literally have hundreds of knobs.

## Additional Front Panel Controls

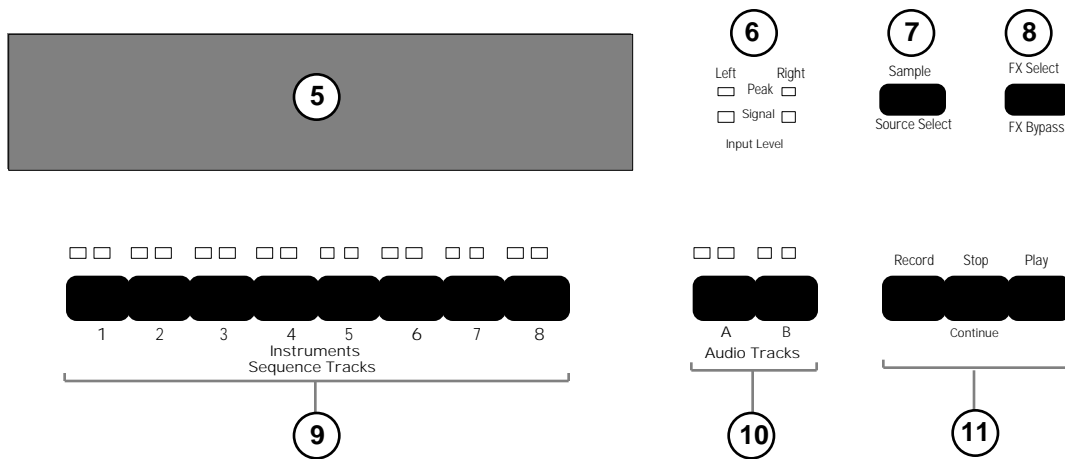

### 5) Display

The ASR-10 Display is divided into two main sections: the *Indicator Lights* in the top half of the window and the *22-character Alphanumeric Display* at the bottom of the window.

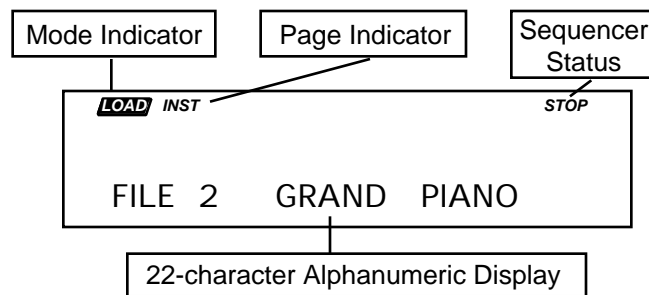

The indicator lights will tell you which mode the ASR-10 is in (Load, Command, or Edit); which page it is on; and the sequencer status (Stop, Play, Record, etc.). The 22-character alphanumeric display is used to show you information about specific files, commands, parameters, etc. It will also ask you for additional input when necessary, such as which track you want to load an instrument into, or which WaveSample you want to edit.

### 6) Input Level LED Meters

These 2 dedicated Input Level meters provide separate Left/Right metering of the Audio Input levels, pre-FX, at all times. The green Signal LEDs light at -24 dB. The red Peak LEDs light at 6 dB below clipping.

### 7) Sample•Source Select Button

This button is used to initiate sampling (digitally recording sounds) by the ASR-10. The Record Source selected on this page will determine the audio signal that will be monitored on the Audio Tracks.

**8) FX Select • FX Bypass Button**

This button acts as the “master” control switch for the built-in effects, determining which, if any effect will be used and how it will interact with the instruments that reside in the internal memory. The controls on this page also determine the current sample rate and polyphony.

**9) Instrument • Sequence Track Buttons — 1 through 8**

These eight buttons are used to select, deselect, and “stack” the various instruments that are loaded into the internal memory of the ASR-10. For each of the eight locations, the two LEDs above the button indicate whether an instrument is *Loaded* into that location (red LED lit) and whether it is *Selected* (yellow LED lit). See “*Playing Instruments*” later in this section for a full discussion of the **Instrument • Sequence Track** buttons.

Each instrument location is also a sequencer track — that is, whatever is recorded on track 1 of a sequence will play the instrument that is loaded into location #1. When you are recording, editing or mixing sequences and songs, you use these buttons to select the current track.

**10) Audio Track Buttons — A and B**

Audio Tracks are used to record RAMTracks and DiskTracks. The two **Audio Track** buttons control audio monitoring of the stereo audio inputs through effects (if desired), enabling you to monitor during sampling, sing along (or play a guitar) to sequencer playback, or record your performance to the Audio Tracks. Each Audio Track has its own Edit/Track MIX, PAN, and OUT bus assignment. The signal monitored on Audio Tracks is the signal that will be sampled or recorded to the Audio Tracks.

Each **Audio Track** button contains 2 LEDs:

- The left LED is red, and is labelled “Source Monitor.” When lit, it indicates that the Audio Track Record Source (set on the Sample • Source Select page, REC SRC parameter) can be monitored on the Audio Track, and that a voice is being used to monitor this audio signal. When the Source Monitor LED is off, the Audio Track is muted and inaudible.

When REC SRC= MAIN-OUT, the audio inputs are disabled, and both Source Monitor LEDs remain off at all times. This happens because REC SRC= MAIN-OUT recording is all ASR-10 generated audio that is routed to BUS1, 2, or 3, and the Source Monitor voices are not needed to monitor this REC SRC, as it is always audible out the Main Outs.

- The right LED is yellow, and is labelled “SELECTED.” When lit, it indicates that the track is selected for parameter editing and/or Audio Track Recording, and that the Audio Signal Source being monitored on the track is selected for sampling. When the SELECTED LED is off, the track’s Edit/(audio) Track parameters cannot be edited, and the Audio Signal Source being monitored on the track will not be sampled and will not be recorded to Audio Tracks.

See *Section 12 — Sequencer and Audio Track Concepts* for more information on Audio Tracks.

**11) Sequencer “Transport Controls”**

These three buttons are used to control the ASR-10’s internal multi-track sequencer.

## Performance Controllers

The ASR-10 features a number of real-time performance *controllers* that can modify sounds as you play for maximum expressiveness. Three of the most important controllers are located to the left of the keyboard:

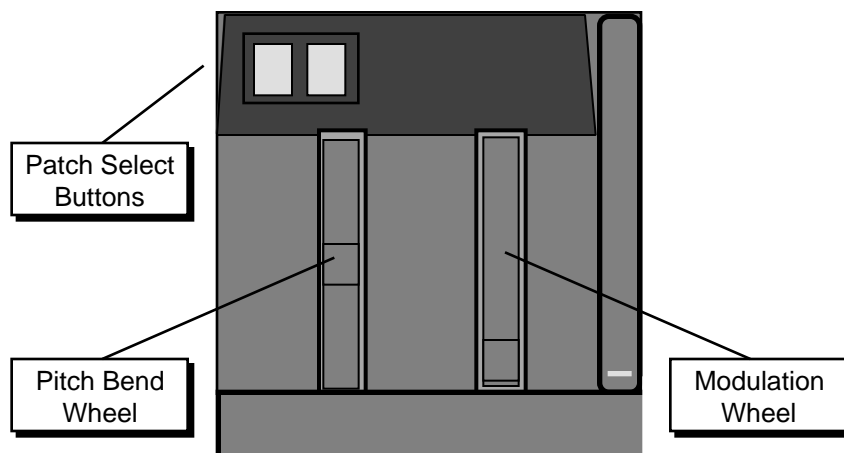

- **PATCH SELECT BUTTONS** — These two buttons are used to select alternate groups of voices (called *Layers*) within a sound. The ASR-10 can be programmed so that the sound changes (sometimes in subtle ways, sometimes radically) when you play notes with one or both Patch Select buttons held down. As you play instruments on the ASR-10, make sure you explore what these buttons do to each sound.
- **PITCH BEND WHEEL** — This wheel bends the pitch of a note up or down. The wheel is normally centered, where it has no effect on the pitch — moving the wheel up or down will bend the note by the amount specified in the Bend Range parameters contained on the Edit/System • MIDI page (for GLOBAL BEND RANGE) and on the Edit/Pitch page (for an individual WaveSample's BEND RANGE).
- **MODULATION WHEEL** — Perhaps the most common use of the Mod Wheel is to add vibrato, but it can also be assigned as a modulator anywhere within the ASR-10 voice architecture to alter the pitch, brightness, volume and a great many other aspects of the sound.

## Pressure (After-touch)

Another important controller is *Pressure*. Pressure (often called after-touch) is a modulator that allows you to change the sound in various ways by pressing down harder on a key or keys after the initial keystroke. The ASR-10 keyboard is capable of generating two types of pressure — *Channel Pressure* and *Poly-Key™ Pressure*.

Like the mod wheel or foot pedal, pressure is a modulator and can be chosen wherever a modulator is selected in the programming section (see *Section 9 — WaveSample and Layer Concepts*) of the ASR-10. Pressure can be assigned to alter the pitch or volume of voices, filter cutoff frequency, LFO rate or depth, pan location, etc.

There are two types of Pressure:

- Channel Pressure, also called Mono pressure, affects all notes that are playing when you exert pressure on any of the keys. For example, if you play a three note chord, pressing down harder on any of the three notes of the chord will modulate *all three notes*. This type of pressure is the more common of the two types.

Most MIDI instruments that currently implement pressure send and receive only channel pressure. If you are playing such an instrument from the ASR-10, you should set the ASR-10 to send channel pressure. (Note that some devices, including *all* ENSONIQ products, respond to both types of pressure.)

- Poly-Key™ Pressure, also referred to as polyphonic pressure, is a more sophisticated and expressive type of pressure. Poly-Key pressure affects each key independently. For example, if you play a three-note chord, pressing down harder on any of the three notes of the chord will modulate *only that note*. The other two notes will remain unaffected.

Each **Instrument•Sequence Track** can be programmed to generate Poly-Key pressure, channel pressure or none at all. If you wish to change the pressure type for a given track, you can do so on the Edit/Instrument page.

**Tip:** Poly-Key pressure generates a tremendous amount of data and will consume sequencer memory much faster than other types of events, such as notes and program changes. You should turn pressure off when sequencing instruments which do not respond to pressure, such as piano and drum sounds.

## Architecture

### “Booting” the ASR-10

Insert the power cord into the line receptacle on the back of the ASR-10, next to the power switch. Plug the other end of the cable into a grounded AC outlet. The proper voltage for your ASR-10 is listed on the Serial Number label on the rear panel. Turn the ASR-10 power on and make sure the display lights up. If not, check your connections and power source.

The ASR-10 Operating System (O.S.) — the computer program that tells the hardware what to do — is “disk based.” This means that each time you turn the ASR-10 on, the first disk you insert must be one containing an ASR-10 Operating System (see the disk label). This is called “booting” the machine. Insert the disk with the label facing up and the sliding metal door facing away from you. The display will read **LOADING SYSTEM** while the O.S. is being loaded. You should always use the latest (highest-numbered) Operating System. If the first disk you put in the drive doesn't contain the ASR-10 Operating System — the display will flash **O.S. NOT ON DISK** or **DISK NOT FORMATTED**. Just remove that disk and insert a proper ASR-10 O.S. disk.

**Note:** We recommend that you use a *copy* of the original O.S. Disk for daily use, and store the original O.S. Disk in a safe place. For more information, see the *Preface*.

Right after the ASR-10 is finished loading the Operating System, and before it puts itself into **LOAD** mode, it will calibrate its keyboard. During calibration the software scans each key and optimizes its velocity and pressure response. The display will briefly read **TUNING KBD - HANDS OFF**. It is important that you don't play or hold down any keys during this time (see below).

Once it has “booted” the ASR-10 is ready to operate, but it won't make any sound until you **LOAD** an instrument into its internal memory and then select that instrument by pressing its **Instrument•Sequence Track** button. These functions will be covered later in this section.

### Keyboard Calibration

Each time you switch it on, the ASR-10 will go through a boot-up routine that includes calibrating the keyboard — a process by which the ASR-10 software is able to scan the entire keyboard and optimize the response of each key. This ensures that the keyboard is always fine tuned for the best possible response. The calibration process only takes about three seconds.

#### **Never play the keyboard while it's calibrating:**

After you turn on the ASR-10 and insert the Operating System in the drive, the display will show **LOADING SYSTEM**, then **TUNING KBD - HANDS OFF**. You should not play the keyboard while this message is on the display. After about three seconds, the display will automatically switch to show the instrument files on the current disk and the ASR-10 is ready for use.

#### **If you do play the keyboard while it's calibrating:**

Playing keys during calibration will cause the display to show **KBD FAILED - RETRY?** Press **Enter•Yes** to allow it to calibrate again, taking care not to play keys this time. In short, you should make it a point not to play keys during the first few moments after turning the unit on.

#### **If the KBD FAILED message appears without touching the keys:**

If the display repeatedly shows **KBD FAILED RETRY?** even when you are not touching keys during calibration, this would indicate a hardware problem and the unit should be serviced by an Authorized **ENSONIQ** Repair Station.

#### **Using the ASR-10 as a sound module only, after getting repeated KBD FAILED messages:**

If you want to use the unit as a sound module after the display shows repeated **KBD FAILED RETRY?** messages, press **Cancel•No**. This will disable the Poly-Key™ keyboard completely, but the ASR-10 will respond normally to all button presses and incoming MIDI information from another MIDI instrument.

## Memory

### Disk Memory vs. Internal Memory

The instruments, banks, and sequences that the ASR-10 plays are stored on 3.5" micro-floppy disks. The ASR-10 uses a high-density (HD) drive, allowing you to use both Double-Sided High-Density and Double-Sided Double-Density disks:

Disk Type	High-Density	High-Density	Double-Density	Double-Density
Format (Sector Offset)	ENSONIQ (offset 0)	COMPUTER (offset 1)	ENSONIQ (offset 0)	COMPUTER (offset 1)
Kilobytes	1600	1440	800	720
Sample Words	800k	720k	400	360k
Blocks	3176	2863	1585	1426

A Block is a handy unit that the ASR-10 uses to measure Internal and Disk memory — 1 Block=256 sample words; 4 Blocks=1k sample words.

Sounds and sequences must be loaded from the disk into the internal memory of the ASR-10 before they can be played. Once it's loaded into memory, an ASR-10 sound or sequence is completely independent of the copy on the disk — you can do anything you want to it without harming the version on the disk, unless you intentionally save the changes. You should feel free to experiment as much as you like with the instrument, layer, and WaveSample parameters of any sound that came with the ASR-10. As long as you have it safely on the disk, you can just reload it and start over if your experiments go awry.

#### Important:

The data in the ASR-10 internal RAM Memory is **not** retained when the power is turned off. Anything in memory, whether Instruments, Banks, or sequencer data, *must* be saved to disk before you switch the power off, or it will be gone forever.

#### Warning!

If you are unfamiliar with installing SIMMs, or do not want to risk the possibility of causing damage to the SIMMs or your ASR-10, we highly recommend having an Authorized ENSONIQ Dealer install them. We also recommend reading all of the SIMM information before attempting to install SIMMs in your ASR-10.

#### Purchasing SIMMs

Here is some important information you should know about purchasing the proper SIMMs:

- The ASR-10 was designed to use 1m x 8 or 4m x 8 (Macintosh) non-parity SIMMs (not 1m x 9 or 4m x 9 parity SIMMs). We highly recommend using this type of SIMMs.
- We do not recommend using parity SIMMs (designed for IBM PC compatibles). These SIMMs may not operate properly, and may cause damage to the ASR-10.
- We recommend using SIMMs with an access speed of 80 nanoseconds or faster.



### What is a SIMM?

SIMM is an acronym which stands for Single In-line Memory Module. SIMMs have become the industry standard used by most computers (both IBM and Mac compatible) to expand the computer's memory. Because of this, SIMMs are readily available in most computer software stores, and from mail order organizations. The ASR-10 memory, like a computer, is also expanded using SIMMs.

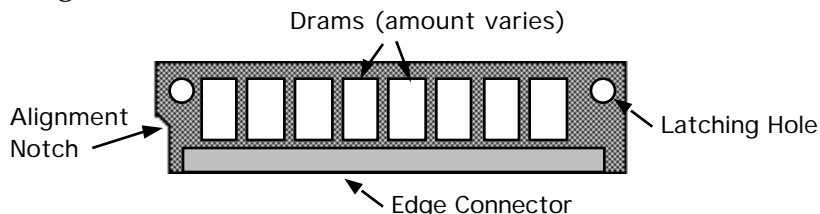

### Internal Memory

As it comes out of the box, the ASR-10 contains 2 MegaBytes or 1 MegaWord of internal memory (a word is one single sample, or 16 bits). That's enough for 31.5 (mono) or 15.75 (stereo) seconds of sampling at a 29.8 KHz sample rate, or about 400,000 notes of sequencer memory.

This internal memory is shared by sounds and the sequencer. The memory is distributed dynamically between instruments and sequences, which means that the more sounds you have in memory, the less sequencer memory you have, and vice versa.

### Expanding the ASR-10 Memory

If you want to expand the memory, the ASR-10 can address up to 16 MegaBytes/8 MegaWords, using industry standard 1m x 8 or 4m x 8 non-parity SIMMs. There are five different memory allocations, as shown below:

SIMMS	1m x 8 (standard)	4m x 8	1m x 8	1m x 8 & 4m x 8	4m x 8
SIMMS Used	two	two	four	two & two	four
MegaBytes	2	8	4	10	16
MegaWords	1	4	2	5	8
Blocks	3,800*	16,000*	7,900*	20,000*	31,000*

\* Actual block count may vary due to different O.S. Versions.

### Accessing SIMMs

To access the SIMMs in your ASR-10, make sure all cables, especially the power cable, are unplugged from the ASR-10. Turn the unit upside down on a soft surface with the keys facing away from you. Remove the two screws holding the trap door and remove the trap door from the bottom of the ASR-10. As it comes from the factory, the ASR-10 would look like this underneath the trap door:

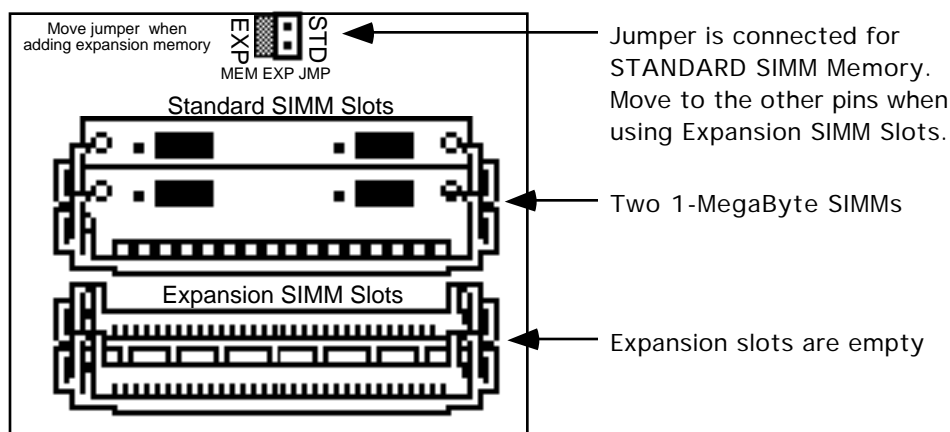

You will notice that there are two slots with SIMMs installed, and two slots that are empty. These empty slots are called Expansion SIMM Slots, and are used for adding additional SIMMs (when expanding the memory). Directly above the Standard SIMM Slots, you will find the Memory Expansion Jumper.

**About the Memory Expansion Jumper**

The Memory Expansion Jumper allows you to access the information in the Expansion SIMM Slots. It must be moved to the EXP (Expansion) pins in order for any SIMMs plugged into the expansion slots to be recognized. If you do not have any SIMMs plugged into the Expansion slots, the Memory Expansion Jumper must be installed on the STD (Standard) pins, or the ASR-10 will not boot up (display will be blank).

**Installing SIMMs**

Memory is user-installable in 1, 2, 4, 5, and 8 MegaWord configurations, with 1 and 4 MegaByte SIMMs, as shown below. There are only five possible memory configurations available on the ASR-10, as shown in the diagram:

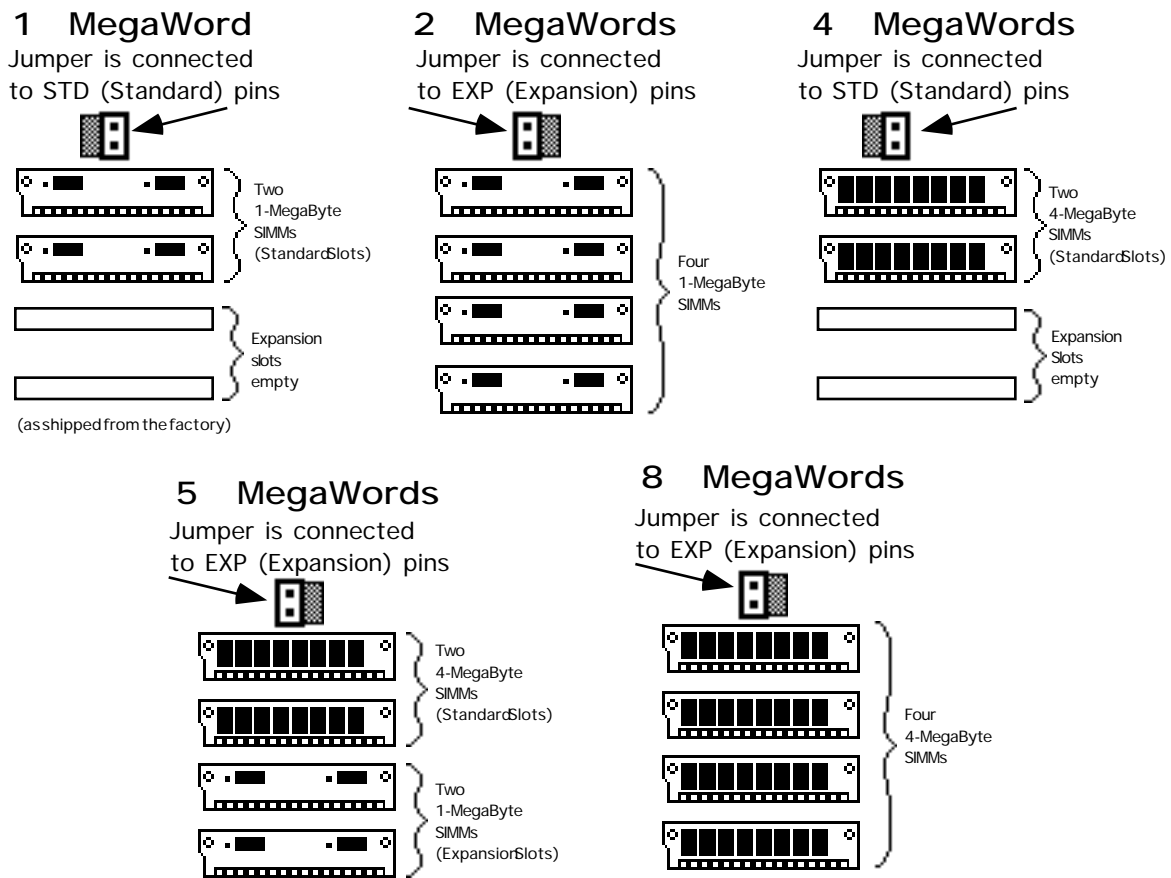

**THESE ARE THE ONLY CONFIGURATIONS THAT WILL WORK PROPERLY!** Any other configurations will not yield the maximum memory available, or provide the optimal performance.

### About the SIMM Socket

The SIMM socket uses the pins on the end of the latching posts to hold the SIMM in place. The alignment notch on the SIMM prevents it from being installed backwards. Once installed, the retaining posts hold the SIMM in place securely, preventing it from dropping out of the socket inside the ASR-10.



### To Remove a SIMM from a SIMM Socket:

Bend the two retaining posts out of the way...

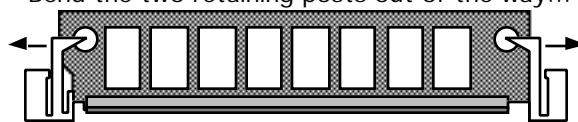

just far enough to remove the SIMM

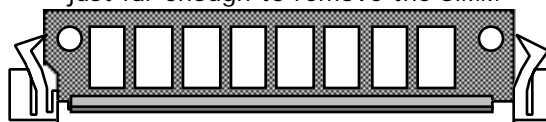

- *Carefully* spread open the retaining posts found on each end of the SIMM. Only spread the posts as far apart as needed to clear the board; these posts can easily break if too much force is applied. If broken, it will be very difficult to secure a new SIMM back into that socket. We suggest spreading one post at a time; that way it's easier to control the amount of pressure being applied to remove the SIMM.
- Once the retaining posts are out of the way, tilt the SIMM toward you, and lift up and out of the socket.

### To Install a SIMM into a SIMM Socket:

#### SIMM Installation - Side View

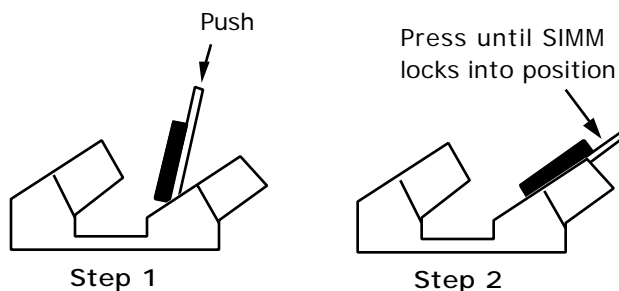

- Place the connector edge of the SIMM into the SIMM Socket, pressing down slightly. The latching holes on each end of the SIMM will line up with the latching posts when the SIMM is seated properly.
- Tilt the SIMM back into the socket until the retaining posts snap in front of the SIMM. A properly installed SIMM should look like this:

### Proper SIMM Installation

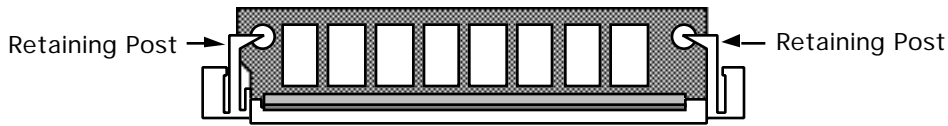

- Reinstall the trap door with the original screws. To verify that you've expanded your memory correctly, after powering up the ASR-10, press **Edit**, then **System • MIDI** and scroll until the display shows **FREE SYSTEM BLOCKS=** (expanded memory amount in blocks). See the memory allocation chart (found earlier) for the proper number of blocks for each configuration.

### Warning

The ASR-10 was designed to use 1m x 8 or 4m x 8 non-parity SIMMs (not 1m x 9 or 4m x 9 parity SIMMs). We do not recommend using parity SIMMs. These SIMMs may not operate properly, and may cause damage to the ASR-10.

### Important Information about SIMMs

- When adding memory, only install D-RAM SIMMs in the expansion slots. The ASR-10 will not accept static RAM or ROMs.
- If SIMMs are installed in a less than optimal configuration, the display will read **SIMMS IN WRONG SOCKETS** after booting. If this message is displayed, you should power off and check the SIMMs configuration. Here is a example of what could be the most likely installation mistake:

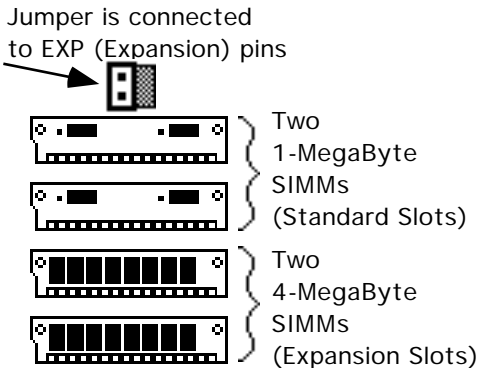

### Incorrect Configuration

This configuration can cause continuous noise and distortion on sounds or when sampling/monitoring Audio Tracks.

- Any configuration which does not use two or four SIMMs will not work (the system will not even boot up).
- Any combination of SIMMs in which there are two different kinds of SIMMs in the standard slots and/or two different kinds of SIMMs in the expansion slots will not work properly. The following diagram shows some examples of incorrect configurations:

### Incorrect Configurations

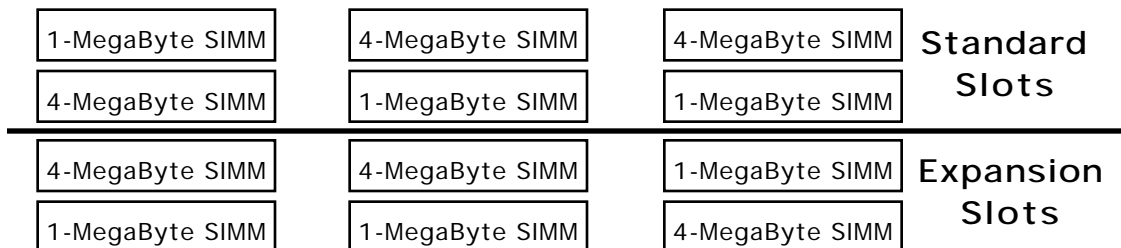

- These incorrect configurations of 1 and 4 MegaByte SIMMs could produce inaccurate

information concerning the number of blocks, or noise and distortion.

- If the jumper is not moved from the “STD” position to the “EXP” position, no memory in the expansion slots will be recognized. The wrong number of blocks will be displayed on the Edit/System•MIDI page.
- If the jumper is moved from the “STD” to the “EXP” position and there are no SIMMs in the expansion slots, the system will not boot up (display will be blank).
- 1m x 9 or 4m x 9 parity SIMMs (for IBM PC compatibles) should not be used. Only 1m x 8 or 4m x 8 (Macintosh) SIMMs should be used.

### Troubleshooting Memory Expansion

If the correct number of blocks is not displayed on the Edit/System•MIDI page:

1. Make sure that there is no mix-up between 4m x 8 and 1m x 8 SIMMs (or that the store did not sell you the wrong parts).
2. Check that the jumper is in the correct position.
3. Check that you are using one of the five proper configurations. Improper configurations may work, but they will not work properly.

Make sure that you are careful when removing the SIMMs. If the plastic retaining posts are broken, the SIMMs will not stay in place, and the main board will have to be replaced at an Authorized ENSONIQ Repair Station (a costly error).

### An Important Note About ElectroStatic Discharge

SIMMs are susceptible to ElectroStatic Discharge (ESD) commonly known as “static.”

ElectroStatic Discharge can destroy or damage SIMMs. In order to minimize the possibility of causing ESD damage, here are some procedures you can follow when installing SIMMs:

1. Before installing SIMMs, you should be grounded by using a ground strap to discharge any static electric charge built up on your body. The ground strap attaches to your wrist and a ground source allowing your hands to be free to work.
2. Avoid any unnecessary movement, such as scuffing your feet when handling SIMMs, since most movement can generate additional charges of static electricity.
3. Minimize the handling of the SIMMs. Keep them in their static free packages until needed. Only transport or store the SIMMs in their protective packages.
4. When handling the SIMMs, avoid touching the connector pins. Try to handle the SIMMs by the edges only.

If you have any questions concerning the use of SIMMs, the ASR-10, or for additional technical support, please contact ENSONIQ Customer Service at (610) 647-3930 Monday through Friday 9:30 a.m. to 12:15 p.m. and 1:15 p.m. to 6:30 p.m. Eastern Time.

## About Instruments

We refer to ASR-10 sounds as *Instruments*. A grand piano, an electric bass, a multi-sampled drum set, a complete string section — each of these would be an example of an instrument. You can load up to eight instruments into the ASR-10, memory permitting, and have instant access to any or all of them.

Each instrument contains four different *Patches* that are selected with the *Patch Select* buttons. These patches allow a single instrument to have four different inflections, voicings, tunings, or synth-type program variations all available at the press of a button.

An instrument can be any size (within the limits of memory) — one instrument might consist of a single WaveSample that plays over the entire keyboard, while another might have as many 127 different WaveSamples.

For controlling remote devices, you can create an instrument that contains no samples at all and assign it to play *only* out MIDI, on a particular MIDI Channel.

## Loading an Instrument

You can load up to eight different instruments into the ASR-10 at once (within the limits of memory). First, insert a disk containing one or more instrument files into the disk drive.

- Press **Load**. The LOAD indicator flashes.
- Press **Instrument**. The display looks like this:

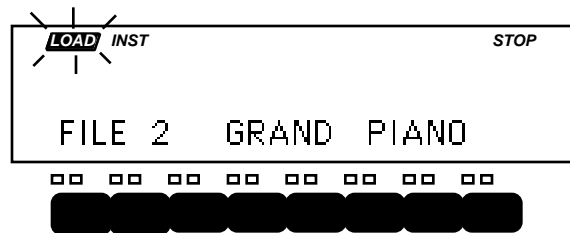

When the LOAD indicator is flashing, the ASR-10 is showing you disk files (think of it as a question mark — the ASR-10 is saying “Load the file showing on the display?”). Pressing the **Up/Down Arrow** buttons takes you through the files on the disk. If there are none, the display will read “NO INST OR BANK FILES.”

Whenever a disk file is displayed as above, you can press the **Left** or **Right Arrow** button to see the size of that file in *Blocks* (a Block is 256 samples; 4 Blocks=1K sample words). Press the **Left** or **Right Arrow** button again to return to the file name.

- Use the **Data Entry Slider** or the **Up/Down Arrow** buttons to view the various instrument files on the disk. Each file has its own File Number. When an instrument file is showing, the INST indicator is lit. The BANK Indicator will light when a bank file is showing.
- Find the instrument you want to load, and press **Enter•Yes**. The display will say PICK INSTRUMENT BUTTON. The ASR-10 is asking in which instrument location you want to load the sound into.
- Press any of the eight **Instrument•Sequence Track** buttons. The ASR-10 will begin immediately loading the instrument into the selected location. The display reads LOADING FILE... and the left red LED *flashes* while the instrument is being loaded.

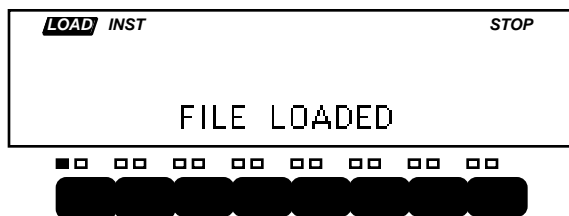

Once the instrument has been loaded, the display briefly shows “FILE LOADED.” The left red LED above the **Instrument•Sequence Track** button stops flashing and remains solidly lit, indicating that there is now an instrument loaded in that location which can be selected by pressing that button.

If you tell the ASR-10 to load an instrument into a location that already has an instrument loaded (left red LED lit), the new instrument will be loaded into that location and the one that was there will be automatically deleted.

### If You Run Out of System Memory

You might have to delete an instrument(s) before loading the new one. If there are already one or more instruments loaded into the ASR-10, there might not be enough free memory to load the new one. In this case, the display will say PICK INST TO DELETE. At this point you have three choices. You can:

1. Press any loaded **Instrument•Sequence Track** button. That instrument will be deleted from memory and the new one will be loaded; or,
2. Press **Enter•Yes**. The ASR-10 will delete an instrument (or instruments, as needed) for you, starting from the highest-numbered one in memory; or,
3. Press **Cancel•No**. The load command will be canceled with no harm done.

**Note:** You can continue to select and play existing instruments while the new one loads. No more “down-time” waiting for the next sound to load. With the ASR-10, you can be loading the next sound you need while continuing to play the currently selected sound.

### Deleting an Instrument from the Internal Memory

Sometimes you will want to delete an instrument from memory — to free up some memory for sampling, for instance. Make sure you have saved the instrument to disk before deleting it. Here's how:

- Verify that the instrument you want to delete is selected.
- Press **Command**, then **Instrument**.
- Press the **Right Arrow** button repeatedly until the display reads DELETE INSTRUMENT.
- Press **Enter•Yes**. The display asks DELETE <INST NAME>?
- Press **Enter•Yes** (or press **Cancel•No** to abort the procedure).

**Tip:** There is a “shortcut” method for deleting an instrument from internal memory. First, press the **Instrument•Sequence Track** button of the instrument you would like to delete. Then, while holding down the **Instrument•Sequence Track** button, press **Cancel•No**.

## About Banks

Banks provide a way to load a whole group of instruments and sequences into the ASR-10 with a few button presses. When you save a bank to disk, it is like taking a “snapshot” of the contents of the ASR-10 Internal memory — the bank file contains information about which instruments are loaded into which of the eight **Instrument•Sequence Track** locations, and which song and sequences (if any) are currently loaded in Internal Memory. When you load a bank, the ASR-10 will set up Internal Memory in the same state it was in when you saved the bank file, loading those instruments into the same locations and, if you choose, loading the song with its related sequences. A bank will also save any Performance Presets you have created.

For example, you might have a piano loaded into **Instrument•Sequence Track 1**, a bass in **Instrument•Sequence Track 2**, and drums in **Instrument•Sequence Track 3**, and you have created a number of Performance Presets containing different keyboard configurations of those instruments. Let’s say you also have in memory a song, which is composed of 12 sequences. If you now save the contents of memory as a bank, you can later call up this exact setup by loading the bank.

The bank file on a disk doesn’t contain the actual instrument and sequence files — it is just a set of instructions telling the ASR-10 what files to load and where to load them. All the instruments and the song in a bank must be saved to disk individually before saving the bank.

**Note:** Any instruments already loaded into locations not used by the bank will be left intact (memory permitting). You can select and play such instruments while the bank loads.

### To Load a Bank

- Press **Load**, then **Instrument**.
- Use the **Up/Down Arrow** buttons to view the different files.



When a bank file is showing, the **BANK** indicator lights on the display along with the **INST** indicator.

- Once a bank file is showing, press **Enter•Yes**. The ASR-10 will begin loading the instruments and the song data. As it loads each instrument the display tells you what it’s doing. As soon as any of the instruments are finished loading, you can select that instrument and play while the rest of the bank loads.

At some point in the loading process, you may encounter the following message:



This prompt is informing you that an instrument or song saved as part of the bank is on a different disk than the disk currently in the drive. When this occurs:

- Eject the current disk in the disk drive and replace it with the disk that matches the Disk Label ID requested by the ASR-10.



- Press **Enter**•**Yes**. The ASR-10 will resume loading until completed, or until the point when it needs another disk.
- When it has finished loading the instruments, the ASR-10 will load the song (if any) and then set up any copied instruments included in the bank.

## Playing Instruments

- First, press **Load** until **LOAD** is solidly lit in the display to make sure you are in **LOAD Mode**.

Now we'll look at the eight **Instrument**•**Sequence Track** buttons and how they function in **LOAD Mode**.



### Instrument•Sequence Track Buttons

These buttons represent a location or “slot” into which an instrument can be loaded. The two LEDs above each button tell you if there's an instrument loaded into that location and whether it's selected, deselected or “stacked.”

- The red LED lights to indicate that an instrument is loaded into that location and can be selected by pressing that button. In the illustration above, we see that instruments are loaded into locations 1, 2, 3, and 4. If none of the red LEDs are lit, no instruments are loaded. The red LED *flashes* while an instrument is being loaded from disk.
- The yellow LED lights when the instrument is selected (i.e. active on the keyboard). You select an instrument by pressing its **Instrument**•**Sequence Track** button. Pressing the button a second time “deselects” the instrument, turning off the yellow LED. In the illustration, **Instrument #2** is selected. If none of the yellow LEDs are lit, that means that no instruments are selected, and playing the keyboard won't make any sound.
- The yellow LED flashes when the instrument is “Stacked” with one or more instruments. An instrument that is stacked will play simultaneously with any other instruments that are selected or stacked. You stack an instrument by pressing its button *twice in rapid succession* (or “double-click” on the **Instrument**•**Sequence Track** button, to borrow a term from those computers that use a “mouse”). In the illustration above, **Instrument**•**Sequence Track** # 3 is stacked with **Instrument**•**Sequence Track** #2. You will hear both instruments when you play the keyboard (wherever their keyboard ranges overlap, that is).
- Select a loaded instrument (one whose red LED is lit) by pressing its **Instrument**•**Sequence Track** button. The display now looks like this:



Once you have loaded one or more instruments, select the instrument you want to play by pressing the appropriate **Instrument**•**Sequence Track** button. The **LOAD** indicator stops flashing, and the ASR-10 shows you the name of the selected instrument, and its volume setting.

You can adjust the volume of the instrument with the **Data Entry Slider** or the **Up/Down Arrow** buttons. This lets you easily balance the levels of several instruments when splitting the keyboard or stacking sounds. If any other instruments are loaded, you can select them in the same way and adjust their volumes. Each time you select an instrument, its name and volume setting will appear in the display.

**Note:** Instruments can be played from an external MIDI controller, without being selected, when Edit/System•MIDI, MIDI IN MODE=MULTI or MONO-B see Section 2 — System•MIDI for details.

**Tip:** When TRANSMIT ON = INST CHAN, on the Edit/System•MIDI page, editing the VOLUME value will transmit MIDI Volume messages (Controller #7) on the selected Instrument•Sequence Track’s MIDI OUT CHANNEL (on the Edit/Instrument page).

**Tip:** To adjust the volume of each loaded Instrument without selecting them, first select one instrument, and then use the **Left/Right Arrow** buttons to view the volumes of the other Instruments that are loaded.

- Try selecting different instruments. Try “double-clicking” to stack instruments. Click once on a selected or stacked instrument to deselect it.
- Pressing the **Load** button again returns you to viewing disk files (LOAD flashing). You can also press **Cancel•No** to toggle back and forth between looking at disk files (LOAD flashing) and looking at instruments in the internal memory (LOAD indicator lit but not flashing).

### Keyboard Range (How Instruments Share the Keyboard in Load Mode)

Whenever the ASR-10 is in Load Mode (which is the normal performance mode) you are not limited to one instrument on the keyboard at a time (or two, or three for that matter). Each instrument has a *Keyboard Range*, which is the section of the keyboard that it will occupy when selected.

The range of an instrument can be as much as the full 127 keys of the MIDI Specification (for playing the ASR-10 from an external controller via MIDI) or as little as a single key. Up to eight instruments can inhabit the keyboard in a way that might be termed a “Pile o’ Instruments.”

Imagine four pieces of paper, each a different size, piled on top of each other:

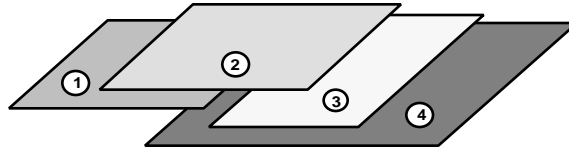

In the picture above, sheet #2 is on top of the pile — all of it is showing. The other three sheets are partially covered up. Now suppose we could magically bring sheet #3 up to the top of the pile. The pile would look like this:

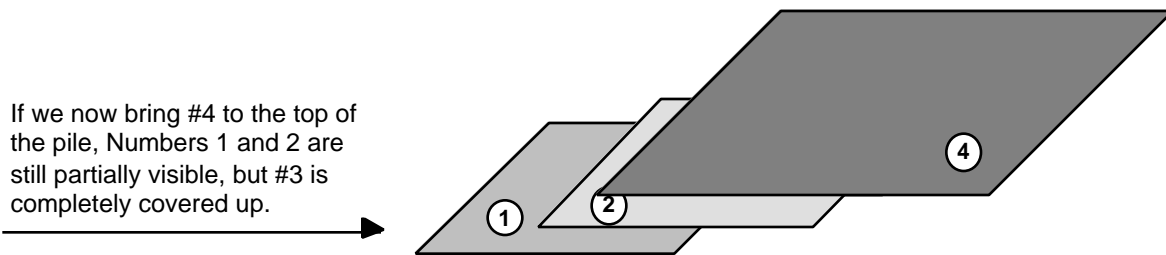
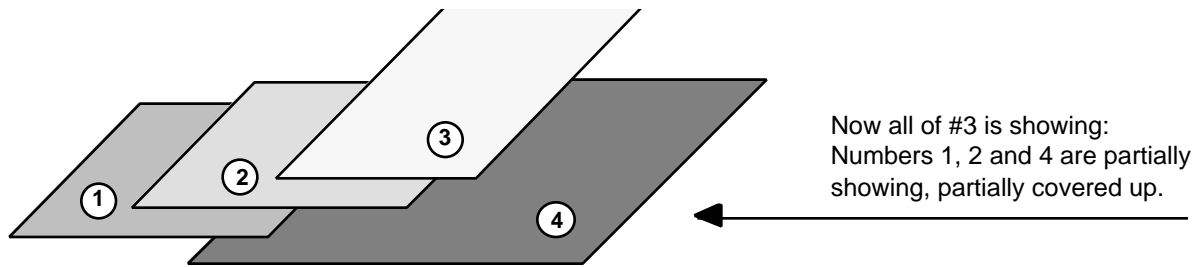

So it is with instruments loaded into the ASR-10 in Load mode. When you select an instrument, it is *brought to the top of the pile*. That is, you will hear the most recently selected instrument over its whole range when you play the keyboard. Any previously selected or stacked instruments will be “covered up” wherever their ranges overlap with that of the newly selected one.

Wherever an instrument is not “covered up,” it will continue to play on the keyboard. So you can see that “splitting” the keyboard is as easy as selecting two or more instruments with different (or overlapping) ranges.

- All instruments that are selected (yellow LED lit) are “on the pile,” even if they are partially covered up by another instrument.

Now let's try the “sheets of paper” analogy in terms of instruments on the keyboard. Suppose you have two instruments loaded into the ASR-10:

- Instrument #1 is a piano sound, whose range is the entire keyboard;
- Instrument #2 is a bass sound, whose range is only the bottom two octaves.

The ranges of the two instruments can be shown like this:



If you select the piano, it will play over the whole keyboard, covering up the bass entirely:

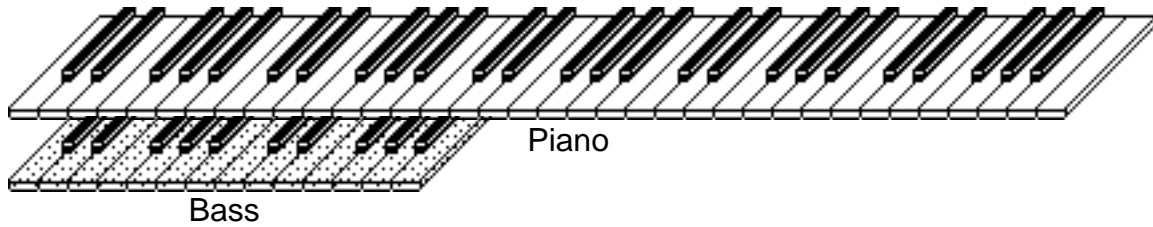

Now you select the bass. This brings it to the top of the pile, and it covers up the piano, but only in the region where their ranges overlap (the bottom two octaves):

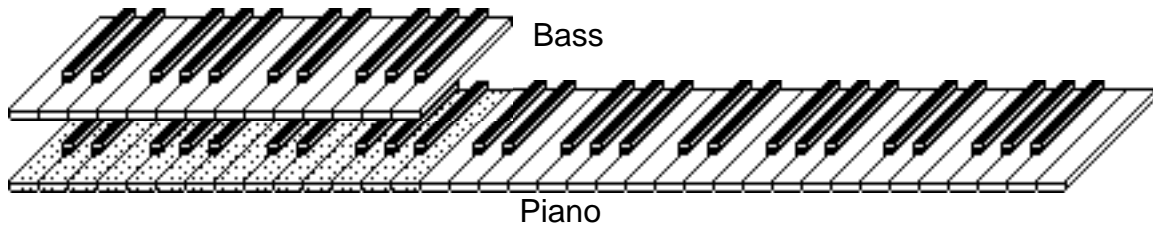

If you play now, you will hear the bass in the bottom two octaves and the Piano over the rest of the keyboard. If you deselect the bass (by pressing its instrument button again) its yellow LED goes out and it returns the whole keyboard range to the piano.

This same logic applies no matter how many instruments are loaded and selected. Whichever one you select comes to the “top of the pile.”

**Note:** The “Pile” described here only exists in Load Mode. In Edit and Command modes, only *one* instrument can be selected at a time.

### Stacking Instruments

With either the bass or the piano selected, double-click the other **Instrument • Sequence Track** button. Now in the lower two octaves you hear the bass *and* the piano.

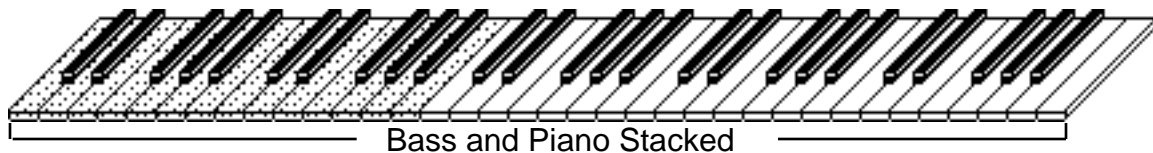

Instruments that you “stack” by double-clicking their instrument buttons will play *simultaneously* with whatever other instruments are on the pile. Selecting another instrument (by pressing its **Instrument • Sequence Track** button and not by double-clicking), will bring that instrument to the top, covering up any stacked instruments as well as any selected ones. Up to all eight instruments can be stacked at once.

#### Additional Notes:

- Whenever a selected instrument is covered up completely by the selection of another, its yellow LED goes out — it is automatically deselected.
- Up to all eight instruments can be selected and can play on some part of the keyboard at once, as long as none is covered up completely.
- You can reset any instruments key range. This is done on the Edit/Instrument page.

## Loading Sequencer Data

There are two ways that ASR-10 Sequencer data can be stored on a disk:

- **SONG File.** A song file contains a song *and* all its related sequences. Loading a song file from disk will completely erase the current contents of the ASR-10 sequencer memory, replacing whatever is there with the song and sequences from the disk file.
- **SINGLE SEQUENCE File.** This type of file contains just one sequence. Loading a single sequence file will *not* erase the sequencer data already in memory — the new sequence simply becomes one more sequence in the internal memory which can be selected or used as a step in a song. There can be up to 80 sequences in memory at once.

### Loading a Song or a Single Sequence from Disk

Both types of sequencer files are accessed from the Load/Seq•Song page.

- Press **Load**, then press **Seq•Song**.  
The LOAD indicator flashes, meaning that the ASR-10 is showing you disk files.
- Press the **Up** or **Down Arrow** button until the file you want to Load is showing on the display:



When a Song file is showing, the SONG indicator lights next to the SEQ indicator.



When a single Sequence file is showing, only the SEQ indicator lights.

- Press **Enter•Yes** to load the sequencer file showing on the display. After you have loaded a song or sequence, it is automatically selected.

### Important:

Remember that loading a song or sequence does not ensure that the right instruments are loaded into the proper **Instrument•Sequence Track** locations. Each track of each sequence will play whatever instrument is in that location at the time. The way to make sure everything is in the right place is to save the contents of memory (including the song) as a bank.

## Selecting a Sequence/Song

Press the **Edit** button, then the **Seq•Song** button. The following screen will appear:

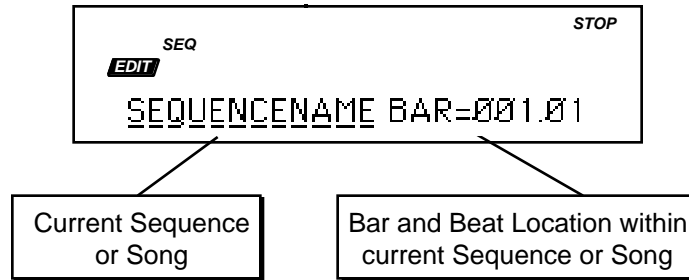

This screen is where you select a sequence or the song. With the selected sequence or song underlined (as shown above), use the **Up/Down Arrow** buttons or the **Data Entry Slider** to select a different sequence or song. You can always get back to this screen by double-clicking the **Seq•Song** button (when in Edit mode). The display will indicate whether a song is selected:

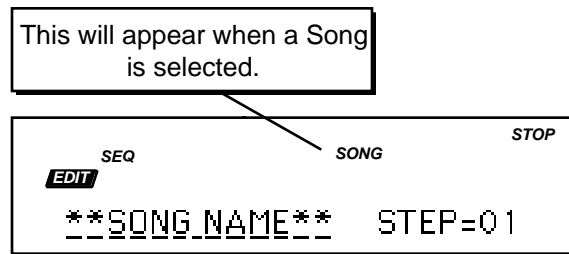

## Playing a Sequence/Song

Try selecting a sequence, and pressing the **Play** button in the sequencer section, to the right of the display. The selected sequence will begin to play.

While one sequence is playing you can select another one. You will see the name of the new sequence in the display, but the original one will continue to play. When the first sequence is finished, the sequencer will switch to the new sequence, and it will play. In this fashion you can string sequences together in real time, as they play.

Press the **Stop•Continue** button or the Left Foot Switch to stop the current sequence.

## Saving Sequencer Data

### Saving a Single Sequence to Disk

Use the SAVE CURRENT SEQUENCE command to save a single sequence.

- On the Edit/Seq•Song page, select the sequence you want to save.
- Insert a formatted disk into the drive.
- Press **Command**, then press **Seq•Song**.
- Press the **Left** or **Right Arrow** button until the display reads SAVE CURRENT SEQUENCE.
- Press **Enter•Yes**.
- Edit the Sequence Name (if needed):

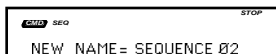

The display shows the current name of the sequence, with a cursor (underline) beneath the first character. If you want to give the sequence a new name, do so at this time. Use the **Data Entry Slider** or the **Up/Down Arrow** buttons to change the underlined character, then press the **Left/Right Arrow** buttons to move the underline. Repeat until the display shows the name you want (if you don't need to rename the sequence, just skip this step).

- Press **Enter•Yes**. The display will read SAVING <FILE NAME> while the sequence is being saved.
- If there is already a sequence file with the same name on the disk, the display will ask DELETE OLD VERSION? Press **Enter•Yes** to save the sequence, replacing the one on the disk. Or press **Cancel•No** to abort the procedure.
- If there is not enough free space on the disk, the display will say NOT ENOUGH DISK SPACE. Save the sequence to another disk (or delete some files from the disk).
- If you try to SAVE CURRENT SEQUENCE while the song is selected, the ASR-10 will not execute the command, responding USE SAVE SONG + ALL. Again, make sure the sequence is selected before trying to save it.

## Saving a Song (along with all Sequences) to Disk

Once you have created a song or made changes to an existing one, you can save the song to a formatted ASR-10 disk. In addition to saving the song itself, the SAVE SONG + ALL SEQS command saves all the individual sequences currently in memory (whether they are part of the song or not). To save a song:

- Insert a formatted disk into the drive.
- Press **Command**, then press **Seq • Song**.
- Press the **Left** or **Right Arrow** button until the display reads SAVE SONG + ALL SEQS.
- Press **Enter • Yes**.
- Edit the song name (if needed):



The display shows the current name of the song, with a cursor (underline) beneath the first character. If you want to give the song a new name, do so at this time. Use the **Data Entry Slider** or the **Up/Down Arrow** buttons to change the underlined character, then press the **Left/Right Arrow** buttons to move the underline. Repeat until the display shows the name you want (if you don't need to rename the song, just skip this step).

- Press **Enter • Yes**. The display will read SAVING <SONG NAME> while the song is being saved.
- If there is already a song file with the same name on the disk, the display will ask DELETE OLD VERSION? Press **Enter • Yes** to save the song, replacing the one on the disk. This is for updating songs to which you have made changes. Or press **Cancel • No** to abort the procedure.
- If there is not enough free space on the disk, the display will say NOT ENOUGH DISK SPACE. Save the song to another disk (or delete some files from the disk).
- Note that the song and all sequences in memory are saved as one file. You cannot extract a single sequence from a song file and load it separately. If you want access to a sequence individually, you must first load the song into the internal memory, and then save the individual sequence using the SAVE CURRENT SEQUENCE command.

## Deleting a File from Disk

Deleting of disk files is done from Load mode. To delete (erase) a file from a disk:

- Press **Load**, followed by the page button (**Instrument**, **Seq • Song**, **System • MIDI**, or **Effects**) for the type of file you want to delete.
- Press the **Up** or **Down Arrow** button until the file you want to delete is showing on the display.
- While holding down the **Load** button, press **Cancel • No**. The display will ask DELETE <FILE NAME>?
- Press **Enter • Yes**. Press **Cancel • No** to abort this procedure.



## Managing Your System Headroom

The ASR-10's 16-bit stereo output converters provide 96dB of dynamic range. This figure of 96dB is referred to as the *system headroom*. Since the ASR-10 is capable of playing 31 notes of polyphony, this 96dB of system headroom must be divided amongst these 31 voices. If the output level of all sustaining voices exceeds 96dB, this will result in clipping. As a result, normal sample playback is attenuated by 12dB to allow multiple voices to sustain simultaneously without clipping, as shown below:

### With Attenuation (BOOST=OFF)

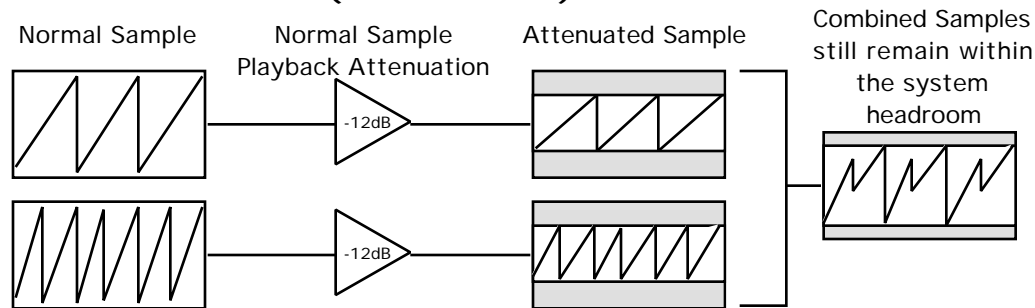

### Without Attenuation (BOOST=ON)

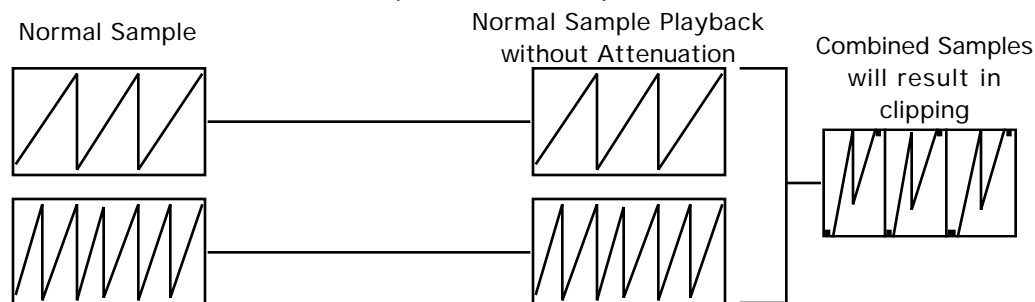

There may be times that this attenuated level does not offer enough perceived loudness for a certain type of sound. For example, percussion sounds only play at their peak volume for a brief instant before decaying quickly to a lower volume. As a result, it is often desirable to have that peak volume be even louder than the loudest attenuated level. This is the purpose for the Edit/Amp BOOST parameter. It provides a 12dB boost in volume to allow a WaveSample to use all 96dB of headroom. Since it is unlikely that two percussion sounds will both use the entire 96dB of headroom at the same exact instant, it is a relatively safe assumption that turning boost on for multiple percussion sounds will not result in clipping.

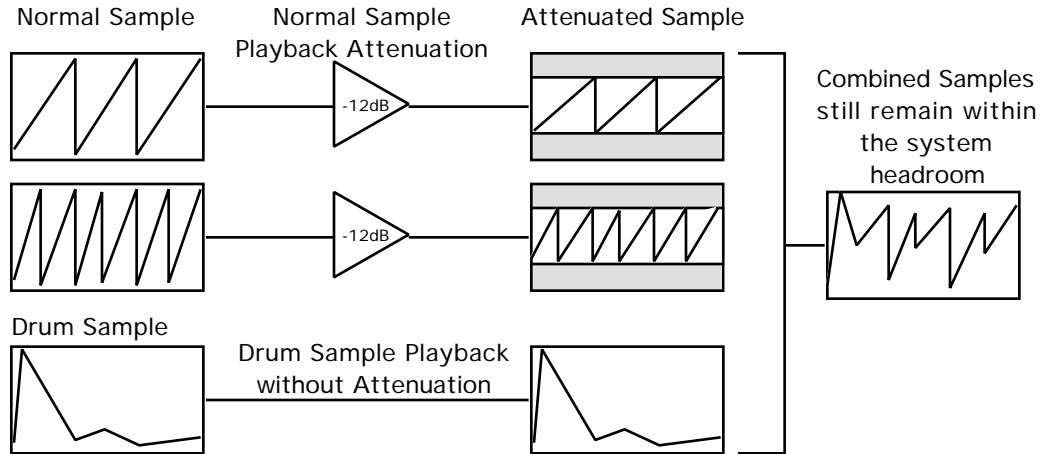

The *BOOST* parameter should not be turned on for all WaveSamples.

Sustaining sounds can remain at their peak volume for as long as a key is held down. As a result, if boost is turned on for a sustaining sound, it is *very* likely that playing multiple notes will result in clipping, even if the notes are not all started at the same time.

After sampling with REC SRC= MAIN-OUT, the Edit/Amp BOOST parameter is automatically set to ON for the new WaveSample. This is done because you have sampled a signal that was attenuated by 12dB and now the sample will be played back attenuated by another 12dB. Turning BOOST= ON, compensates for this effect. As a final step, after sampling the MAIN OUT, it is recommended that you optimize your use of headroom by setting the Edit/Amp BOOST= OFF, and performing the Command/Amp NORMALIZE GAIN command on the new WaveSample.

The key to managing your headroom is to determine which non-sustaining sounds will be the loudest, and set the BOOST parameter ON only for those sounds.

### Audio Track Headroom

The Audio Tracks are permanently set to BOOST= ON. To prevent clipping, the Edit/Track MIX parameter for the Audio Tracks defaults to MIX= 60. When MIX= 99, the Audio Track will use the entire 96dB dynamic range. If you hear clipping when monitoring audio input on an Audio Track, first adjust the Mic/Line Switch and the Input Level trim control so that the red Input Level Peak LEDs only light occasionally (the red Peak LEDs light at 6dB below clipping), and then set the Edit/Track MIX parameter to a lower value.

## Parameter Illustrations

The ASR-10 accesses parameters and commands through *Pages*. Each page is accessed by two button presses, the first being a Mode button and the second a Page button. Most parameters will also have a *Direct-Dial* number. This number can be pressed immediately after pressing the proper Mode and Page button to get to a specific parameter directly, bypassing scrolling with the **Left/Right Arrow** buttons.

When describing parameters or commands in this manual, parameter illustrations are used to communicate the location of the parameter and how to get there. For example:

Page Name m	Parameter Name(s) and description(s) m
<i>EDIT</i>	<b>PATCH (Layer Enable/Disable)</b>
<i>INST</i>	Press Edit / Instrument / 0

i

Directions to locate

These illustrations not only help to divide the manual into easy to locate sections for each screen, they also provide the following three important pieces of information about the parameter being discussed:

- **Page Name** — The page in which the parameter resides. In this case, it is the Edit/System • MIDI page.
- **Parameter(s)** — This tells you the name of the parameter or parameters as they're listed in that screen.
- **Directions to Locate** — This tells you how to get to the parameter screen. The directions will contain the Direct-Dial number for the parameter if one exists. If not, it will advise you to scroll to the parameter.

# Section 2 — System•MIDI

These pages contain parameters and commands that affect the ASR-10 as a whole.

## Edit/System•MIDI Page

This page contains global system and MIDI parameters. Due to the large number of parameters on this page, not all parameters have a direct dial number. Those that do will have that number listed in its parameter illustration. Parameters without direct dial numbers can be accessed with the **Left/Right Arrow** buttons.

**Tip:** By double-clicking the **System•MIDI** button in Edit mode, you can toggle between the first System Parameter and the first MIDI parameter.

**Note:** The settings for most of these parameters will be saved to the O.S. disk when you perform the SAVE GLOBAL PARAMETERS command (defined earlier).

## System Parameters

<i>EDIT</i>	<b>FREE SYSTEM BLOCKS</b>
<i>SYSTEM•MIDI</i>	Press Edit / System•MIDI / 0

This page shows the amount of available internal memory (in blocks).

<i>EDIT</i>	<b>FREE DISK BLOCKS</b>
<i>SYSTEM•MIDI</i>	Press Edit / System•MIDI / scroll using the arrow buttons

This page shows the amount of available memory (in blocks) on the disk currently in the drive (or on whatever SCSI Storage Device is selected as the storage device).

<i>EDIT</i>	<b>MASTER TUNE</b>
<i>SYSTEM•MIDI</i>	Press Edit / System•MIDI / 1

Adjusts the overall master tuning of the keyboard up or down as much as one semitone. A value of +0 will set the ASR-10 to concert A=440 tuning.

Range: -99 to +99 cents

<i>EDIT</i>	<b>GLOBAL BEND RANGE</b>
<i>SYSTEM•MIDI</i>	Press Edit / System•MIDI / scroll using the arrow buttons

Use this parameter to adjust the pitch bend range. The bend range is adjustable in one-semitone increments from 0 to 12. Each ASR-10 WaveSample can have its own bend range (which will override the global bend range) or can use this global bend range.

Range: 0 to 12 semitones

**Note:** When MASTERTUNE and GLOBAL BEND RANGE are edited, the ASR-10 will transmit the current value as a Registered Parameter Select message, on the MIDI BASE CHANNEL.

<i>EDIT</i>	<b>TOUCH (Velocity and Pressure Response)</b>
<i>SYSTEM•MIDI</i>	Press Edit / System•MIDI / scroll using the arrow buttons

Allows you to adjust both the pressure *and* velocity response of the keyboard to match your playing style and technique. For each of the four velocity settings SOFT, MED, FIRM, HARD there are four pressure thresholds 1, 2, 3, 4, for a total of 16 available settings. The pressure threshold can be varied between 1 (minimum force required to bring in pressure) and 4 (maximum force required to bring in pressure).

- SOFT 1, SOFT 2, SOFT 3, SOFT 4 — This is for someone with a light touch. On any of these settings, a minimum of velocity is required to reach the maximum level of any velocity-controlled parameter. The pressure threshold is adjustable from SOFT 1 to SOFT 4 as described above.
- MED 1, MED 2, MED 3, MED 4 — Slightly harder keystrokes are required to reach maximum velocity levels. The pressure threshold is adjustable from MED 1 to MED 4 as described above.
- FIRM 1, FIRM 2, FIRM 3, FIRM 4 — These settings represent average velocity sensitivity. One of these settings should be right for the player with an average touch. The pressure threshold is adjustable from FIRM 1 to FIRM 4 as described above.
- HARD 1, HARD 2, HARD 3, HARD 4 — These settings are for the strong player who strikes the keys hard. It provides the widest possible range of velocity sensitivity. The pressure threshold is adjustable from HARD 1 to HARD 4 as described above.

<i>EDIT</i>	<b>PEDAL (VOLUME / MOD)</b>
<i>SYSTEM•MIDI</i>	Press Edit / System•MIDI / 2

The optional CV Pedal (model CVP-1) can be used as a volume pedal or as a modulator. When PEDAL= VOLUME, the pedal will only affect the volume of the selected **Instrument • Sequence Track(s)**, and it will be transmitted via MIDI as MIDI controller #7. When PEDAL=MOD, it will affect any modulation destination that has PEDAL selected as a modulator, and it will be transmitted via MIDI as MIDI controller #4. When PEDAL= VOLUME the ASR-10 will still receive PEDAL (MIDI controller #4) messages via MIDI.

**Note:** Some Yamaha™ TX modules (depending on the software version) receive MIDI controller #4 as volume. If PEDAL=MOD MIDI=4, and the pedal is not plugged in, the MIDI controller #4 value transmitted will default to 0, which could shut down the volume of the TX.

- When set to PEDAL=VOLUME MIDI=7 the optional CV Pedal acts as a volume pedal for the selected **Instrument • Sequence Track(s)**.
- When set to PEDAL=MOD MIDI=4 the optional CV Pedal acts as a modulation pedal, and will cease to act as a volume pedal.

<i>EDIT</i>	<b>LEFT FOOT SW</b>
<i>SYSTEM•MIDI</i>	Press Edit / System•MIDI / scroll using the arrow buttons

When the optional SW-10 Dual Foot Switch is plugged into the rear panel Foot Switch jack, this page allows the Left Foot Switch to perform a variety of assignable functions. The Right Foot Switch is permanently dedicated to function as the Sustain pedal.

- **OFF** — This setting makes the ASR-10 ignore the Left Foot Switch. If you are using the single foot switch (SW-2) which came with the ASR-10, then you should keep this parameter set to OFF (the SW-2 will only function as a sustain pedal).
- **FX MODSRC** — This setting allows the left foot switch to function as an effects modulation source, assignable to any modulation destination in any effect.
- **SAMPL YES** — This setting allows you to initiate sampling with the Left Foot Switch. After pressing the **Sample•Source Select** button, successive presses of the Left Foot Switch will behave as though the **Enter•Yes** button has been pressed.
- **STOP/CONT** — When set to STOP/CONT, the left pedal of the SW-10 duplicates the action of the **Stop•Continue** button. When in standby record, pressing the Left Foot Switch will initiate recording.

**Note:** If you are using a single foot switch (SW-2 or SW-6), this parameter should be set to OFF to prevent unexpected behaviour.

**Note:** If you want the SW-10 to duplicate the behavior of the Patch Select buttons, plug it into the Patch Select jack located on the rear panel. The Patch Select jack requires a dual foot switch and *will not* work properly with a single foot switch (SW-2 or SW-6).

<i>EDIT</i>	<b>AUTO-LOOP FINDING (ON/OFF)</b>
<i>SYSTEM•MIDI</i>	Press Edit / System•MIDI / 3

This parameter enables or disables the “Expert-System” auto-loop function. If the auto-loop function is enabled, the ASR-10 will automatically go to zero crossings (with matching wave direction) whenever you move the loop start or end pointer. This is a very useful feature because finding zero crossings is essential to creating glitch-free loops. If the auto-loop function is disabled, the loop start and end parameters will move in one-sample increments.

**Note:** AUTO-LOOP FINDING will not function on a WaveSample that exists in a stereo layer (i.e. a layer in which STEREO LAYER LINK = ON).

## MIDI Parameters

Few developments in recent years have had as great an impact on the way we make music as has the emergence of MIDI. Whether you are simply linking two keyboards together, playing a synth from a guitar controller, or driving a rack of samplers from a drum pad controller, MIDI makes it all possible. The evolution of MIDI has facilitated the merging of existing technologies and has inspired the creation of new technologies. ENSONIQ has always been an industry leader in MIDI development, and the ASR-10 embodies the latest advances in a state-of-the-art sequencer, controller keyboard, and multi-timbral sound generator.

<i>EDIT</i>	<b>MIDI BASE CHANNEL</b>
<i>SYSTEM•MIDI</i>	Press Edit / System•MIDI / 5

Selects the Base Channel on which the ASR-10 transmits and receives MIDI messages. The base channel is used to receive MIDI data while the ASR-10 is in POLY and MONO A modes. This is the MIDI channel that the ASR-10 will transmit on when Edit/System • MIDI, TRANSMIT ON=BASE CHANNEL. System Exclusive messages are always sent and received on the base channel.

Any of 16 MIDI channels may be selected as the base MIDI channel of the ASR-10. The effect of setting the base channel varies depending on the setting of the TRANSMIT ON= parameter, the MIDI Mode and whether data is being transmitted or received.

**Receive** In POLY mode, keys, controllers, and program changes are only recognized if received on the base channel. In MONO A mode, program changes are received only on the base channel. The base channel is also used in MONO A mode as the first channel of the 8 channel range.

**Transmit** The ASR-10 has two different MIDI transmitting schemes, depending on the setting of the TRANSMIT ON= parameter. When TRANSMIT ON=BASE CHAN, the ASR-10 always transmits only on the base channel. When TRANSMIT ON=INST CHAN, the ASR-10 always transmits on the Edit/Instrument, MIDI OUT CHANNEL for each Instrument.

Range: MIDI channels 1 through 16.

<i>EDIT</i>	<b>TRANSMIT ON (INST CHAN/BASE CHAN)</b>
<i>SYSTEM•MIDI</i>	Press Edit / System•MIDI / 6

- When set to INST CHAN, each of the eight ASR-10 instruments will send on its own MIDI channel (or not at all, if assigned LOCAL status). Each instrument will have its own MIDI program number and its own PRESSURE setting.
- When set to BASE CHAN, the ASR-10 will always transmit notes, controllers and program changes on the Base MIDI channel and *only* on that channel, no matter what Instrument • Sequence Tracks are selected or stacked.

<i>EDIT</i>	<b>BASECHAN PRESSURE</b>
<i>SYSTEM•MIDI</i>	Press Edit / System•MIDI / scroll using the arrow buttons

When TRANSMIT ON=BASE CHAN, the ASR-10 will send either Key or Channel pressure or no pressure at all, depending on the setting of this parameter. When TRANSMIT ON=INST CHAN, this setting is ignored and each instrument transmits pressure according to its own Edit/Instrument PRESSURE MODE setting.

- When BASECHAN PRESSURE=OFF, no pressure will be transmitted via MIDI.
- When BASECHAN PRESSURE=KEY, the ASR-10 will transmit the most expressive type of pressure — key pressure via MIDI. The ASR-10's Poly-Key™ Pressure lets you modulate each note independently. If you press down on any given key within a chord, only that note will be affected by pressure—all other notes remain unmodulated.
- When BASECHAN PRESSURE=CHAN, the ASR-10 will transmit the most common type of pressure—channel pressure, via MIDI. With channel pressure, after a note is played, pressing down harder on the key will modulate every note currently playing. Like a mod wheel, channel pressure is “global,” it affects the entire keyboard when activated.

You can consult the MIDI implementation chart of the MIDI device you will be using with the ASR-10, to see which, if any, type of pressure it responds to. Set this parameter to the appropriate value when playing or sequencing a particular device from the ASR-10.

EDIT SYSTEM•MIDI	<b>MIDI IN MODE</b>
	Press Edit / System•MIDI / 7

This parameter determines how MIDI information will be *received* by the ASR-10 and its various Instruments. MIDI In Mode has no effect on what MIDI information is transmitted.

There are five MIDI modes implemented in the ASR-10:

- OMNI — In this mode the ASR-10 will receive on all 16 MIDI channels. This mode is useful when you are only using a few instruments, and you are not concerned with setting up different channels for each device.
- POLY — In this mode the ASR-10 will receive only on the Base MIDI channel. MIDI information on all other channels will be ignored.
- MULTI — An ENSONIQ innovation, MULTI mode is the key to unlocking the potential of the ASR-10 as a multi-timbral receiver from an external MIDI sequencer. In MULTI mode, the 8 tracks of the current song or sequence, and the 8 individual instruments, can receive MIDI information independently and polyphonically on up to 8 different MIDI channels.
- MONO A — This mode is optimized for use with a MIDI guitar controller.
- MONO B — This mode is optimized for use with a MIDI guitar controller, with the added benefit of assigning a different instrument to each string.

**Note:** In OMNI, POLY and MONO A modes, incoming MIDI will only play those **Instrument•Sequence Tracks** that are “Selected” or “Stacked.”

**Note:** In MULTI and MONO B modes, independent of what **Instrument•Sequence Tracks** are “Selected” or “Stacked” on the front panel, the sounds you will hear when notes are received via MIDI will depend entirely on what MIDI channel(s) the MIDI data is received on.

**Note:** In MULTI and MONO B modes, different MIDI receive channels must be selected for each **Instrument•Sequence Track** that you want to receive via MIDI. The MIDI receive channel for each **Instrument•Sequence Track** is set with the Edit/Track, MULTI-IN MIDI CHAN parameter. If more than one sequence track is set to the same MULTI IN MIDI CHAN, only the lowest numbered **Instrument•Sequence Track** will receive via MIDI.

**Note:** In MULTI and MONO B modes, notes played on the ASR-10's own keyboard are not affected by incoming MIDI Controller messages. Only the ASR-10's own controllers will affect notes played on the ASR-10's keyboard.



## MONO Modes

MONO modes are particularly useful for driving the ASR-10 from a guitar controller, or any other application where having up to eight independent, monophonic channels is desirable. The ASR-10 offers two types of MONO mode operation:

- MONO A is the mode you will probably use most often. This is the mode to use when you want to play the same sound on all the strings of your guitar controller. In MONO A, the ASR-10 receives on eight consecutive MIDI channels (the MIDI BASE CHANNEL through MIDI BASE CHANNEL +7) and will play whatever **Instrument•Sequence Track** (s) are selected or stacked on the front panel. In other words, the ASR-10 behaves as it does in POLY or OMNI modes, except that it receives monophonically on multiple MIDI channels. This provides the advantage of multiple tracks that will respond independently to controllers received on multiple channels, but you do not have to set up the instruments for each track separately.
- MONO B is the mode to use if you want to be able to play a different sound on each string of your guitar controller. In MONO B, each **Instrument•Sequence Track** receives on its own Edit/Track MULTI-IN MIDI channel. In other words, the ASR-10 behaves as it does in MULTI mode, except that each **Instrument•Sequence Track** receives monophonically on multiple MIDI channels. This is the only way to get a different sound on each string when using a MIDI guitar controller.

## Global Controllers in MONO A and B Modes

Global controllers are controllers sent on one channel that affect all other channels simultaneously. They can be useful in reducing the number of MIDI events required to achieve particular effects, and can thereby reduce the delays sometimes associated with overloading MIDI. Some guitar controllers can transmit global controllers, and the ASR-10 can respond to them.

In MONO mode (A or B) the base channel minus one becomes the MIDI channel for global controllers (pitch bend, pressure, etc.). For example, if the base channel is channel 3, any controllers received on channel 2 will be interpreted as global controllers and will affect *all* voices being played. If the base channel is channel 1, channel 16 becomes the channel for global controllers. Each track will also respond independently to controllers sent on its own channel. For example, each guitar string on a MIDI guitar can send independent pitch bend, while the “whammy bar” controller could be sent on the global channel to affect all voices.

**Note:** The ASR-10 will not receive note data via MIDI on the base channel minus one in MONO A and B modes. Therefore, we recommend that the MIDI BASE CHANNEL parameter on the Edit/System•MIDI page be set to the same channel as the **Instrument•Sequence Track** with the lowest numbered Edit/Track MULTI-IN MIDI CHAN number.

For more information on using MULTI and MONO modes, see *Section 17 — Sequencing/MIDI Applications*.

EDIT SYSTEM•MIDI	<b>MIDI CONTROLLERS (ON/OFF)</b>
	Press Edit / System•MIDI / scroll using the arrow buttons

This determines whether the ASR-10 will send *and* receive MIDI controllers — pitch bend, mod wheel, pressure, volume, sustain, etc. When OFF, the ASR-10 will not transmit or receive MIDI controllers.

<i>EDIT</i>	<b>MIDI SYS-EX (ON/OFF)</b>
SYSTEM•MIDI	Press Edit / System•MIDI / scroll using the arrow buttons

This parameter determines whether the ASR-10 will send *and* receive MIDI System Exclusive messages, such as remote programming instructions or WaveSample dumps. When OFF, the ASR-10 will neither transmit nor receive System Exclusive messages.

**Note:** This parameter does not have to be ON for the ASR-10 to record and store Sys-Ex messages from external devices using the MIDI SYS-EX RECORDER function on the Command/System•MIDI page.

<i>EDIT</i>	<b>MIDI PROG CHANGE (ON/OFF)</b>
SYSTEM•MIDI	Press Edit / System•MIDI / 8

This parameter enables (ON) or disables (OFF) ASR-10 reception of program changes via MIDI (the default is ON).

### To Send a MIDI Program Change from the ASR-10:

- Hold down an **Instrument•Sequence Track** button.
- *While holding down* the **Instrument•Sequence Track** button, “type in” the number (from 1-128) of the desired program change on the numeric keypad buttons of the ASR-10; then
- Release the **Instrument•Sequence Track** button. When the button is released, the program change is sent.

If the ASR-10 has been set to TRANSMIT ON= INST CHAN, the program change will be sent on the MIDI channel of the instrument whose button you held down while typing in the number. If it is set to TRANSMIT ON= BASE CHAN, the program change will always be sent on the base channel.

MIDI program changes can also be sent by setting TRANSMIT ON=INST CHAN and then editing the Edit/Instrument, MIDI OUT PROGRAM value.

When **Instrument•Sequence Tracks** are selected in solid LOAD mode, the ASR-10 will transmit the MIDI OUT PROGRAM number for the selected **Instrument•Sequence Track(s)**.

### Receiving Program Changes

What the ASR-10 does when it receives a program change depends on the current MIDI IN MODE.

**If the MIDI IN MODE = OMNI, POLY, or MONO A**, incoming program changes 1-24 will *Select, Deselect, or Stack* the eight **Instrument•Sequence Tracks** of the ASR-10 in the following fashion:

- Program changes 1-8 will *Select* ASR-10 Instruments 1-8 (center yellow LED will light), if received by an instrument which is not selected.
- Program changes 1-8 will *Deselect* Instruments 1-8 (center yellow LED will go out), if received by an instrument which is already selected.
- Program changes 9-16 will *Stack* Instruments 1-8 (center yellow LED will flash).
- Also, program changes 17-24 will select Performance Presets 1-8.

**If the MIDI IN MODE = MULTI or MONO B**, incoming program changes are used to load Instruments as well as Banks into **Instrument•Sequence Track** locations and to enter and exit directories. To load a given file into an **Instrument•Sequence Track** location, press the **Load**

button, and send the ASR-10 a program change that is the file number +1 on the **Instrument • Sequence Track's** Edit/Track MULTI-IN MIDI CHANNEL. To load a Bank file, send the ASR-10 a program change that is the Bank file number +1. When a program change is received, the ASR-10 will load the appropriate file from the currently selected storage device (FLOPPY, SCSI 0-7). Incoming MIDI program changes 101-128 will invoke Macros 0-27.

**Note:** In MULTI and MONO B modes, program change 1 has a special function, which is to EXIT TO the previous directory. This is particularly useful for moving around a SCSI Storage Device from a remote MIDI controller or computer.

<i>EDIT</i>	<b>MIDI SONG SELECT (ON/OFF)</b>
<i>SYSTEM•MIDI</i>	Press Edit / System•MIDI / scroll using the arrow buttons

When this parameter is ON, a remote sequencer or drum machine can be instructed to select a new song when you load a new song into the ASR-10, or when the currently loaded song is selected (the default is ON). The song can be assigned a MIDI Song Select number from 0 through 127. MIDI Song Select numbers 0 through 127 are transmitted via MIDI when you load a new song into the ASR-10, or when the currently loaded song is selected.

When the song is selected, MIDI Song Select numbers can be assigned as follows:

- Press **Command**, then **Seq•Song**. Scroll to SEQUENCER INFORMATION.
- Press **Enter•Yes**. Scroll left until the display reads MIDI SONG SELECT=##.
- Select a MIDI Song Select number 0 through 127 using the Data Entry Controls.

MIDI Song Select numbers are stored with the song when you save the song to disk.

<i>EDIT</i>	<b>MIDI XCTRL NUMBER</b>
<i>SYSTEM•MIDI</i>	Press Edit / System•MIDI / 9

Range: 0 to 127

Most controllers on a synthesizer — mod wheel, breath controller, or foot pedal, for example — have a MIDI controller number that can be assigned to this parameter. Doing so will make a particular external controller available as a modulator to any of your programs.

One modulation source that can be selected is XCTRL (external controller). When the ASR-10 receives MIDI Controller messages corresponding to this controller number, they will be routed to all parameters that have been programmed with XCTRL as a modulation source. Suppose, for example, you are playing the ASR-10 from a keyboard with a breath controller (or want to use a breath controller as a modulator when playing the ASR-10 keyboard). You can set up a WaveSample on the ASR-10 in which the filter cutoff frequency is modulated by XCTRL. If you then set "XCTRL=02," the breath controller can modulate the filter, or any other parameter that has its modulation source set to XCTRL.

The following controller numbers are commonly supported:

Number	Controller	Number	Controller
1	Modulation Wheel	64	Sustain
2	Breath Controller	66	Sostenuto
4	Foot (Pedal) Controller	70	Sound Variations (Patch Selects)
6	Data Entry	71	Harmonic Content (Timbre)
7	Volume	72	Release Time
10	Pan	73	Attack Time
		74	Brightness

Although the range of this control is from 0 to 127, many of the values other than those listed above have no “approved” function, yet. They exist to provide flexibility and to accommodate future MIDI standards.

<i>EDIT</i>	<b>MULTI CONTROLLERS</b>
<i>SYSTEM•MIDI</i>	Press Edit / System•MIDI / scroll using the arrow buttons

This parameter determines whether local controllers (such as the patch select buttons, volume pedal, mod wheel, etc.) will affect all tracks or only the selected track(s). Setting this to ON is useful if you are playing the ASR-10 from an external drum pad or guitar controller in MULTI or MONO B modes and want local controllers to affect all the tracks.

- ON — Local controllers will affect all **Instrument•Sequence Tracks** when the ASR-10 is in MULTI or MONO B modes.
- OFF — Local controllers will affect only the **Instrument•Sequence Tracks** selected or layered from the front panel, no matter what is being received via MIDI.

<i>EDIT</i>	<b>ENTER PLAYS KEY</b>
<i>SYSTEM•MIDI</i>	Press Edit / System•MIDI / scroll using the arrow buttons

This parameter determines the note value (A0 to C8) that pressing **Enter•Yes** on this screen (or on the Edit Context page) will play. In other words, pressing **Enter•Yes** on either the Edit Context page, or on this screen will be the equivalent of playing a note on the keyboard, at a velocity of 127. This provides a way to manually trigger notes from the front panel of the ASR-10 without playing the keyboard. See *Section 16 — Instrument Programming Applications* for more information.

## Command/System•MIDI Page

Due to the large number of commands on this page, not all commands have a direct dial number. Those that do will have that number listed in its command illustration. Commands without direct dial numbers can be accessed with the **Left/Right Arrow** buttons.

CMD	<b>FORMAT FLOPPY DISK</b>
SYSTEM•MIDI	Press Command / System•MIDI / 0

Before you can save ASR-10 instruments, banks, or sequences to a disk it must be formatted. You can use a blank disk or one that was previously formatted by a different device, such as a computer. Note that formatting will completely erase anything on the disk.

- Insert the disk to be formatted into the drive.
- Press **Command**, then **System** and scroll to **FORMAT FLOPPY DISK**.
- Press **Enter•Yes**. The display will read **DISK LABEL=DISK000**

Use the **Data Entry Slider** and the **Arrow** buttons to give the disk a unique name by which you can identify that disk. This is very *important*, as the ASR-10 will ask you for this disk by name if an instrument or song on the disk is used in a bank. Also, make sure you write the Disk Label name on the outside of each disk after you are done formatting it. After assigning a Disk Label, you can change the default prompt from DISK000 to the last label you assigned by using the "SAVE GLOBAL PARAMETERS" command (discussed later in this section). In doing this, you can ensure that all of your personal disks will have the same first four characters.

- Press **Enter•Yes**.  
The display will read **FORMAT TYPE**. Here you select which type of formatting you would like to use to format your floppy disk:

**ENSONIQ** — this standard format allows the ASR-10 to read the disk, and offers the largest amount of free blocks (DSDD disks format to 800k and DSHD disks format to 1600k).

**COMPUTER** — this unique format provides a lower disk capacity, but by having the first sector labelled sector 1, allows MAC and IBM computers that are running the appropriate translation software to read the disks.

- After choosing a format type, press **Enter•Yes**.  
The display will read **ERASE AND FORMAT DISK?**
- Press **Enter•Yes**.

While the disk is being formatted, the display reads **FORMATTING...** When it's done the display says **FORMAT COMPLETE**. If the format fails, the display will read **FORMAT FAILED**. Try again with a different disk.

**Note:** After formatting a disk you can, if you want, copy the ASR-10 Operating System (O.S.) onto that disk (see below). Having the O.S. on your sound disks can be convenient. However, putting the O.S. on a disk leaves a little less space for saving instruments and sequences.

<i>CMD</i>	<b>COPY O.S. TO DISK</b>
<i>SYSTEM•MIDI</i>	Press Command / System•MIDI / 1

Use this command to put the ASR-10 Operating System (O.S.) on a new disk that you have formatted, or to update the Operating System on an existing disk with a newer version.

**Note:** The Operating System can only be copied to a blank disk, or a disk (with or without sounds and sequences) that has an existing operating system on it. You cannot copy the Operating System to a disk that only has instruments or sequences. Attempts to do so will result in an error message.

This procedure requires erasing whatever is in the ASR-10 Internal Memory, so make sure that any important data has been saved to disk. Also, you'll need a disk containing the Operating System that you want to copy.

- Insert the disk containing the O.S. you want to copy (the source disk) into the drive.
- Select COPY O.S. TO DISK.
- Press **Enter•Yes**.  
The display says MUST ERASE MEMORY, OK? If you need to save any sounds or sequences, press **Cancel•No** and save the data before proceeding.
- Press **Enter•Yes**. The display says INSERT MASTER O.S. DISK. Make sure the source O.S. disk is in the drive.
- Press **Enter•Yes**. The display says READING O.S. INTO MEMORY, and then INSERT FORMATTED DISK.
- Insert the disk onto which you want to copy the O.S. (the destination disk) into the drive.
- Press **Enter•Yes**. The display reads WRITING O.S. TO DISK while the O.S. is being copied to the disk.

When it's done, the display reads COPY O.S. DONE. ANOTHER? If you want to copy the same O.S. to another disk, insert another formatted disk and press **Enter•Yes**. You can repeat this procedure as many times as you like. This makes it easy to update all your O.S. disks when a new ASR-10 Operating System is released.

- When you are done, press **Cancel•No**.

<i>CMD</i>	<b>SAVE GLOBAL PARAMETERS</b>
<i>SYSTEM•MIDI</i>	Press Command / System•MIDI / 2

The SAVE GLOBAL PARAMETERS Command saves the settings for the following parameters:

- All Edit/System•MIDI parameters
- All Sample•Source Select parameters
- The current FX Select•FX Bypass page setting
- All Edit (audio) Track parameter settings
- The MULTI-IN MIDI CHAN settings on the Edit/Track page
- The Edit/Seq•Song CLOCK SOURCE, CLICK settings, and SEQ COUNTOFF mode
- The Source Monitor status for the audio tracks

These parameters are global to the ASR-10 and are not saved with the instruments, sequences, or banks. For example, if you have a firm playing style, it would be convenient to set the ASR-10 always to respond to your particular playing style. You would set TOUCH=FIRM 4 on the Edit/System•MIDI page, then perform the SAVE GLOBAL PARAMETERS command to a disk containing the current Operating System.

- Select SAVE GLOBAL PARAMETERS. Make sure you have a formatted, non-write-protected disk containing the most recent Operating System in the disk drive.
- Press **Enter•Yes**. The display reads DISK COMMAND COMPLETED.

The next time you “boot” the ASR-10 with that disk, the new settings will be loaded in as the defaults.

**Tip:** If you use several different MIDI reception configurations in your studio, make several copies of the O.S. disk, and save different GLOBAL PARAMETERS on each one. You can then use the LOAD GLOBAL PARAMETERS command (Command/System•MIDI page) to load the different configurations from each O.S. disk.

<i>CMD</i>	<b>LOAD GLOBAL PARAMETERS</b>
<i>SYSTEM•MIDI</i>	Press Command / System•MIDI / 3

This command allows you to load global parameters from disk, without having to reboot the ASR-10.

- Select LOAD GLOBAL PARAMETERS. Make sure you have the disk containing the global parameters and operating system loaded into the disk drive.
- Press **Enter•Yes**. The display reads DISK COMMAND COMPLETED.

<i>CMD</i>	<b>CREATE DIRECTORY</b>
<i>SYSTEM•MIDI</i>	Press Command / System•MIDI / 4

Use this command to create a new directory on the current disk. Directories are not generally necessary when working with floppy disks, as it is unlikely that you will fit more than 38 files on a floppy. However, a hard disk (which can be used with the optional SP-3 SCSI Interface) can hold hundreds of files, and directories are a necessary part of managing and organizing those files. See the *Small Computer System Interface (SCSI) Manual*, included with the optional SP-3 Small Computer System Interface, for details.

<i>CMD</i>	<b>CHANGE STORAGE DEVICE</b>
<i>SYSTEM•MIDI</i>	Press Command / System•MIDI / 5

Use this command to determine whether the ASR-10 will use floppy disk or an external SCSI Storage Device.

- Select CHANGE STORAGE DEVICE. Press **Enter•Yes**.
- Select LOAD DEVICE=FLOPPY/SCSI 0 through 7.
- You must press **Enter•Yes** to change the storage device. Otherwise, you will get the COMMAND ABORTED message.
- Press **Enter•Yes**. The display reads COMMAND COMPLETED.

<i>CMD</i>	<b>SAVE MACRO FILE</b>
<i>SYSTEM•MIDI</i>	Press Command / System•MIDI / 6

Macros provide a way to move quickly from one place in the directory structure to another. They are primarily for use with a SCSI Storage Device.

- Press **Enter•Yes**. The display will read FILENAME= MACROFILE 1.  
Use the **Data Entry Slider** and the **Arrow** buttons to name the macro file. This will help you to identify your files quickly. After you've named your macro file,
- Press **Enter•Yes**.  
The display will read SAVING (macro file name), then it will show COMMAND COMPLETED.

See **Macros** later in this section for more information.

<i>CMD</i>	<b>COPY FLOPPY DISK</b>
<i>SYSTEM•MIDI</i>	Press Command / System•MIDI / 7

The COPY FLOPPY DISK command lets you duplicate the contents of one entire disk (the *source disk*) onto another disk (the *destination disk*). This function will only work if both disks are the same size (**both** High Density disks or **both** Double Density disks). It is a good practice to regularly back up your valuable data — including the O.S. disk that came with the ASR-10 — in this way. You can use either blank or formatted disks. During the COPY FLOPPY DISK command, the ASR-10 will ask you if you want to format the blank disk. Make sure the formatted destination disks do not contain any files that you want to keep because they will be erased. It is also a good idea to *write-protect* the source disk, so there's no chance of losing data.

**Note:** This procedure uses the internal memory to temporarily hold the information while copying it between disks. The fewer files you have loaded in the internal memory before you start, the fewer times you will have to swap disks during the copy procedure. You will only have to swap disks if the size of the source disk you are copying is greater than the amount of free internal memory.

To Make a Backup Copy of a Disk:

- Slide open the plastic write-protect tab on the source disk (the original) so that the disk is write protected (you can see through the hole). This is an extra precaution to safeguard the data.
- From the COPY FLOPPY DISK command, press **Enter•Yes**. The display shows INSERT SOURCE DISK (the one you want to copy).
- Insert the source disk, then press **Enter•Yes**.
- The drive will engage and the display will flash READING SOURCE DISK. Once the drive stops, the display will change to show INSERT DEST DISK.
- Insert the destination disk (the one you want to copy to), and then press **Enter•Yes**. If the



destination disk is unformatted, the display will ask ERASE AND FORMAT DISK? Press **Enter•Yes** to format the disk. When formatting is complete, the drive will engage and the display will flash WRITING DEST DISK.

- After writing to the destination disk, the display will read VERIFYING DEST DISK. If the copy is complete, then the display will read DISK COMMAND COMPLETED.
- If the size of the source disk you are copying is greater than the amount of free internal memory, the display will change to show INSERT SOURCE DISK again. Repeat the preceding four steps as prompted by the ASR-10 display until the display

**Note:** When a disk is copied, the Disk Label Number is copied from the source disk to the destination disk.

COPY FLOPPY messages:

- DISK WRITE-PROTECTED — When asked for the destination disk you inserted a write-protected disk. The destination disk must have the write-protect tab closed (so you can't see through the hole).
- DISK IS NOT SOURCE DISK or DISK IS NOT DESTINATION DISK — You put the wrong disk in the drive when prompted for a certain disk. This is not fatal; it doesn't abort the copy procedure. Just insert the requested disk and proceed.

<i>CMD</i>	<b>MIDI SYS-EX RECORDER</b>
<i>SYSTEM•MIDI</i>	Press Command / System•MIDI / 9

The ASR-10 can be used to receive, store, and send MIDI System Exclusive (Sys-Ex) messages. These Sys-Ex messages can be saved to and loaded from disk. *Since the ASR-10 erases the Internal Memory to "buffer" incoming Sys-Ex signals, you should make sure that any important data has been saved to disk before performing this command.*

The MIDI Sys-Ex recorder in the ASR-10 lets you store to disk things like:

- The program (patch) memory of any MIDI synth,
- Patterns from a drum machine,
- The sequence memory of a MIDI sequencer,
- Sample data dumps from samplers and sampling drum machines, and
- The preset memory of any MIDI effects device.

### SAVING System Exclusive Data from an External Device

- Connect the MIDI Out of the sending device to the MIDI In of the ASR-10.
- Make sure that the ASR-10 O.S. disk is in the disk drive.
- Select MIDI SYS-EX RECORDER.
- Press **Enter•Yes**. The display reads MUST ERASE MEMORY OK?
- Press **Enter•Yes**. The display reads WAITING... The ASR-10 is ready to record any System Exclusive message that it receives.
- Send the Sys-Ex data from the external device to the ASR-10. The display will flash RECEIVING while the Sys-Ex data is being received by the ASR-10. If the Sys-Ex data have been received successfully, the ASR-10 will display CANCEL=QUIT ENTER=SAVE.

At this point, you can send the ASR-10 another Sys-Ex message (from a different device, for example) which will be stored right after the first one. You can save as many different messages as memory permits in a single Sys-Ex block. Each time a message is received, the display will flash RECEIVING and then return to CANCEL=QUIT ENTER=SAVE. When the data is later retransmitted, all the messages will be sent out in the order they were received. In this way you could load new data into all your devices with a single Sys-Ex Load command from the ASR-10.

To save the Sys-Ex file to disk:

- Insert a formatted disk into the ASR-10.
- Pressing **Enter•Yes** displays FILENAME=SYS-EX FILE. You can name your Sys-Ex file by using the data entry controls, if you wish.
- Press **Enter•Yes**. The display reads SAVING <filename>, then DISK COMMAND COMPLETED.
- Pressing **Cancel•No** aborts the command.

### LOADING System Exclusive Data from Disk and SENDING to an External Device

- Connect the MIDI Out of the ASR-10 to the MIDI In of the receiving device.
- Press **Load**, then **System•MIDI**. Scroll until the desired Sys-Ex file is selected. The display looks something like this:

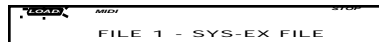

A screenshot of the ASR-10 display showing the text "FILE 1 - SYS-EX FILE" centered on the screen. The display has a dark background with light-colored text.

- Press **Enter•Yes**. The display reads LOADING <filename>.
- The display then reads CANCEL=QUIT ENTER=SEND.
- Press **Enter•Yes** to send the Sys-Ex file to a receiving device, or
- Press **Cancel•No** to abort the command.

After you have sent your MIDI Sys-Ex file to a receiving device, the CANCEL=QUIT ENTER=SEND screen returns. You can retransmit the data by pressing **Enter•Yes**, in case it was not properly received the first time for some reason.

- Once the data has been successfully received by the external device, you can, if you wish, make a back-up copy of the file onto a different disk.
- Press **Cancel•No**. The ASR-10 asks RESAVE FILE TO DISK?
- Press **Enter•Yes** to save the Sys-Ex file to disk, or **Cancel•No** if you don't want to make a backup.

CMD	<b>WRITE DISK LABEL</b>
SYSTEM•MIDI	Press Command / System•MIDI / scroll using the arrow buttons

This command is used to label ASR-10 disks with a unique seven character Disk I.D. These labels are used to give each of your ASR-10 disks a unique identity, thereby allowing banks to load from multiple disks.

To label an ASR-10 disk:

- Select WRITE DISK LABEL.
- Press **Enter•Yes**.  
The display will read USE CURRENT LABEL? Pressing the **Enter•Yes** allows you to use the disk label from the last disk read by the drive. This can speed up the labelling process, as it is likely you'll want to keep the same first four alpha-numeric characters, changing only the three-digit number at the end of the label. If not, pressing **Cancel•No** defaults to DISK000.
- Use the data entry controls to label the disk. Be sure to give it a unique label that is not used on any of your other disks.
- Press **Enter•Yes**. The display briefly reads DISK COMMAND COMPLETED, then returns to the Command/System•MIDI page.

CMD	<b>COPY SCSI DRIVE</b>
SYSTEM•MIDI	Press Command / System•MIDI / scroll using the arrow buttons

This command enables you to copy the data from one SCSI Storage Device to another of the same capacity (they must have exactly the same capacity for the process to work) or copy data from one cartridge of a removable SCSI Storage Device to another cartridge. This command does *not* de-fragment the files as it copies them from the source drive to the destination drive. It merely copies the data sector by sector.

### SCSI Drive Hook-Up

When using the COPY SCSI DRIVE command to copy data between two drives of the same size, connect a SCSI cable between one port of one drive to the SCSI connector on the rear of the ASR-10. Then, run a second SCSI cable from the first drive's remaining SCSI port to a port on the second drive. The order of the drives does not matter. However, each drive must have a different SCSI ID number in order for the ASR-10 to differentiate between the source and destination drives. Also, it is time to stress again that the two drives must be the same size (in memory capacity) for the process to work properly. The easiest way to ensure this is to use the same model by the same manufacturer for both drives. However, several manufacturers use the same drive mechanism in their drives, which will also work. Call the drive manufacturer to get complete details on your specific drive(s).

**Note:** If you're hooking up multiple drives, refer to the *Small Computer System Interface (SCSI) Manual* for instructions on how to correctly set termination for each individual drive.

For copying data between two cartridges of a removable drive, connect a SCSI cable between one of the SCSI ports on the drive and the SCSI connector on the ASR-10.

### Using the COPY SCSI DRIVE Command

The following procedure is the basic method for copying data between two SCSI Storage Devices of the same size or two cartridges of a removable drive.

- With the drive(s) connected as stated above, press **Command**, followed by **System•MIDI**. This places you on the Command/System•MIDI page.
- Use the data entry controls to scroll to the COPY SCSI DRIVE command. Press **Enter•Yes**.
- The display reads FROM DRIVE=SCSI #. Use the **Up/Down Arrow** buttons to set the SCSI ID number to that of the source drive (the drive that contains the data you wish to copy). For more information on SCSI ID number, refer to the *Small Computer System Interface (SCSI) Manual* that you received when SCSI was installed on your ASR-10. Press **Enter•Yes**.
- The display now reads TO DRIVE=SCSI #. Use the **Up/Down Arrow** buttons to set the SCSI ID number to that of the destination drive (the drive to which you wish to copy the data). If copying between two cartridges of a removable drive, set the TO DRIVE and FROM DRIVE parameters to the same number. Press **Enter•Yes**.
- If the destination drive needs to be formatted, the ASR-10 will display the message FORMAT SCSI DRIVE. Pressing **Enter•Yes** will cause the drive to be formatted. Immediately afterward, the ASR-10 begins copying the data from the source drive to the destination drive.

**Note:** When using a removable drive, the ASR-10 will issue prompts for inserting the source and destination disks. These refer to the separate cartridges, and are switched in the same manner as floppy disks in the COPY FLOPPY command. It is also very important to let the drive "spin-up" each time you switch between Source and Destination cartridges *before* hitting the **Enter•Yes** button to continue.

CMD SYSTEM•MIDI	<b>BACKUP/RESTORE</b>
	Press Command / System•MIDI / scroll using the arrow buttons

The BACKUP/RESTORE command allows you to make a backup copy of all of the information on a SCSI Storage Device. If the drive later fails and must be reformatted, or if you are switching to another drive, you can restore the drive from the backup copy.

- Press **Command**, then **System•MIDI**, and scroll until “BACKUP/RESTORE” appears in the display.
- Press **Enter•Yes**. The ASR-10 will show:

```

  CMD          SYSTEM          STOP
  _____
  FUNCTION=BACKUP

```

This allows you to select either the BACKUP or RESTORE function. Use the **Up/Down Arrow** buttons or the **Data Entry Slider** to select the correct function.

- Press **Enter•Yes**, and the ASR-10 will display:

```

  CMD          SYSTEM          STOP
  _____
  DEVICE=SCSI 0

```

This allows you to select the device that you want to backup or restore. You may only select SCSI 0 through 7. Press **Enter•Yes**. The ASR-10 will display:

```

  CMD          SYSTEM          STOP
  _____
  STORAGE DEVICE=FLOPPY

```

This allows you to select the device that you want to use to store the backup data. You may select SCSI 0 through 7, or the FLOPPY drive. Press **Enter•Yes**, and the ASR-10 will proceed with either BACKUP or RESTORE.

## BACKUP

**Note:** If you are using removable cartridges as your backup storage device, you must boot the ASR-10 with a formatted cartridge in the drive. Otherwise, the ASR-10 will not recognize the drive as a valid device. Subsequent cartridges need not be formatted beforehand; they will be automatically formatted as part of the backup procedure.

The BACKUP utility first scans the SCSI Storage Device to see how many disks (or cartridges) will be necessary to hold the backup data. While this scan occurs, you will see the names of directories appear briefly in the display. When the scan is finished, the ASR-10 displays:

YOU NEED nn DISKS, OK? (“nn” is the number of disks needed to hold the backup data).

- If you press **Cancel • No**, the command will abort without copying any data.
- If you have enough disks (or cartridges), press **Enter • Yes**.

If the SCSI Storage Device contains an ASR-10 Operating System, the ASR-10 will first copy the operating system onto the backup storage device. Next, the ASR-10 saves a file that contains a “snapshot” of the directory structure for the SCSI Storage Device. This file is named BACKUP FILE, and appears as a SYSTEM EXCLUSIVE file; however, it contains no valid Sys-Ex data. After these two files, the ASR-10 proceeds to copy each file on the SCSI Storage Device. Whenever a new disk (or cartridge) is necessary, the ASR-10 will prompt:



```

  GMD          SYSTEM          STOP
  INSERT NEXT BACKUP DISK

```

Insert a disk and press **Enter • Yes**. If you insert an unformatted disk (or cartridge), the ASR-10 will automatically format it. If the disk is not blank, the ASR-10 will erase the files on the disk before proceeding to copy files to it. As you insert each disk, be sure to write the disk number somewhere on the disk label. If the ASR-10 encounters errors reading from or writing to the SCSI Storage Device, it will display a descriptive error message and wait for you to press **Enter • Yes**. After you press **Enter • Yes**, the ASR-10 will display CONTINUE ?

If you press **Enter • Yes**, the ASR-10 will move on to the next file and proceed with the backup. When all of the files have been copied, the ASR-10 will go back to the Command page, displaying BACKUP/RESTORE. The actual backup may take more or less disks than the original estimate, depending upon errors reading files and bad sectors encountered writing files.

## RESTORE

The RESTORE utility first checks the SCSI Storage Device to see if it needs formatting or erasing. If so, it will automatically format and erase the disk. Next, the ASR-10 displays:



After you insert the first backup disk (or cartridge) and press **Enter•Yes**, the ASR-10 copies the OS (if necessary) from the backup disk. Then, it loads the BACKUP FILE and recreates all of the directories on the SCSI Storage Device. When completed, if you are restoring to a different SCSI device number than the one you backed up, the ASR-10 will display TRANSLATE SCSI x TO y ?

Where x is the SCSI ID of the storage device you backed up, and y is the SCSI ID of the storage device you are restoring. Pressing the **Enter•Yes** button here will cause the ASR-10 to change all BANKS and MACRO files that contained file paths for x to file paths which point at y. Pressing **Cancel•No** here will not abort the command; it merely answers “no” to the question.

**Note:** If you restore to a different device than the one you backed-up, and you answer “no” to the translate question, most of your banks will probably be useless.

The ASR-10 will restore the files one at a time. You will be prompted to insert each disk when necessary. If you insert the wrong-numbered disk, the ASR-10 will show WRONG DISK INSERTED.

If this happens, insert the correct disk and press **Enter•Yes**.

### Notes About BACKUP/RESTORE

The RESTORE utility will automatically defragment the SCSI Storage Device, resulting in faster access times for some files.

If you have backed-up your SCSI Storage Device and you accidentally erase a file, you don't need to restore the entire drive to get back that one file. Any of the copied files may be loaded directly from the backup disks without going through the restore process.

If you are backing up to removables, and it is your experience that they are faster when formatted with an INTERLEAVE other than 1, pre-format the necessary cartridges using the FORMAT command that allows you to specify the INTERLEAVE.

CMD SYSTEM•MIDI	<b>CONFIGURE AUDIO TRACKS</b>
	Press Command / System•MIDI / scroll using the arrow buttons

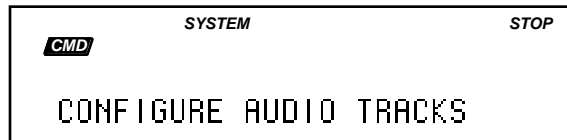

This command enables and disables Audio Track playback and recording. It also determines whether Audio Tracks will be recorded direct-to-disk via the SCSI port, or whether they will reside in RAM and must be manually saved to disk as part of a SONG + ALL SEQs file.

For details about using this command, see *Section 12 — Sequencer and Audio Track Concepts*.

CMD SYSTEM•MIDI	<b>FORMAT SCSI DRIVE</b>
	Press Command / System•MIDI / scroll using the arrow buttons

This command is for formatting a SCSI Storage Device for use with the optional SP-3 Small Computer System Interface. See the *Small Computer System Interface (SCSI) Manual* for details.

## Macros

### What Is a Macro?

It may have occurred to you that with the large number of files that a SCSI Storage Device can contain, it would be nice to be able to get directly to a directory or specific file quickly rather than having to scroll through all your files. Macros allow you to do this. In the ASR-10, a macro is a shortcut command that allows you to get to a file or directory on your SCSI Storage Device (or floppy) with just two or three button presses.

Complete understanding and utilization of macros is very important to the effective use of your SCSI Storage Device. Spend time to make sure that these concepts are clear to you, and that you set up macros to get you to all the directories and files that you use often.

Organizing your files in directories makes it easier to locate an individual file, but moving up and down through directories can become tedious if you are working with a specific set of files that are in different directories. Macros allow you to assign a number (1-28) to an individual file location. You use or invoke the macro by holding down **Load** while entering the macro number (using the numeric keypad), and when you release **Load**, the ASR-10 will automatically go to the correct directory for the requested file and display its name.

The group of up to 28 currently defined macros may be stored as a *Macro File*. These macro files appear along with directories on the Load/System•MIDI page. You can have many macro files on disk, but the only macros that are in effect are the macros from the most recently loaded macro file. Only one can be loaded in at a time, giving you access to twenty-eight macros. The best place to save these files is in the root directory. The default macro file created by the formatting procedure is located in the Root Directory of the SCSI Storage Device, and is called MACROFILE 1. A macro file having this or any other name will be automatically loaded at bootup if it is found as file number 5 in the Root Directory. If you want to use other macros, the first thing you should do is load the desired macro file after you boot from the SCSI Storage Device.

The macro file created by the formatting procedure, named MACROFILE 1, contains macros predefined for getting to the various directories in the default directory structure, as follows:

<b>1</b> FLOPPY DRIVE	<b>2</b> FACTORY SNDS	<b>3</b> MY SOUNDS
	<b>5</b> FACTORY SEQs	<b>6</b> MY SEQUENCES
	<b>8</b> FACTORY BNKS	<b>9</b> MY BANKS
<b>0</b> MACRO FILE		



**Note:** All macro operations are performed with the **Load** button held down, and take effect when the **Load** button is released.

### Loading a Macro File

- Press **Load** then **System•MIDI**, and scroll to the macro file that you wish to load.
- Press **Enter•Yes** to load a new set of 28 macros into the ASR-10.

### Creating a Macro

- Find the file or directory to which you want to assign a macro. Press and hold the **Load** button, type any number from 1 to 28, while still holding **Load**, press **Enter•Yes**, then release **Load**. The macro assignment will remain in effect until another macro file is loaded or the ASR-10 is rebooted.

### Invoking a Macro

- Press and hold the **Load** button, type and release the number of the desired macro. When you release the **Load** button, the ASR-10 will go to the file that is assigned to the macro. If the file is a directory, you will need to press **Enter•Yes** to actually enter the directory. If no file is assigned to the macro, the macro number will be displayed, and nothing else will happen. In **MULTI** and **MONO B** modes, incoming MIDI program changes 101-128 will invoke Macros 0-27.

### Saving a Macro File

- First, invoke macro 0 (zero) to get back to the proper directory for the currently loaded macro file (macro 0 is a special macro that is always automatically assigned to the currently loaded macro file and cannot be reassigned. It is used to allow you to easily get back to the directory where the macro file that you last loaded is located. This makes saving your modified macro files easier).
- Press **Command**, then **System•MIDI**, and scroll to the **SAVE MACRO FILE** command and press **Enter•Yes**. The name of the current macro file will be displayed.
- The display will show **FILE NAME = MACROFILE 1**. If you want to create a new macro file, edit the name of the file, and press **Enter•Yes** when you are ready. The new macro file will be saved in the same directory as the old macro file(s).
- If you wish to update the old file, just press **Enter•Yes**. When the ASR-10 displays **DELETE OLD VERSION?** press **Enter•Yes** only if you wish to replace the old macro file with the new set of macros. This will save your newly defined set of macros into the macro file that was last loaded.

You can have as many different macro files as you want by giving them different names. You may also save them into any directory, although it is a good idea to save them in the root directory so that they are easy to load when you boot up. Remember that macros can take you to any file or directory, no matter how far down the file path. Also remember that you must resave the macro file any time you add new macros and want them to be there the next time you boot the ASR-10.

**Tip:** A good example of the use of macros would be to assign macro 11 to a directory consisting solely of bank files. Now, whenever you want to save your current group of instruments (and any saved song file) as a bank, simply invoke macro 11 that selects your bank directory, and then use the **SAVE BANK** command (press **Command**, then **Instrument**, and scroll to **SAVE BANK**). This saves you from having to locate your bank directory each time. Another useful application of macros is the transfer of files from floppy disks onto your SCSI Storage Device.

### “Direct Dialing” on CD-ROMs with Direct Macros

ENSONIQ formatted CD-ROMs have a unique Direct-Macro number assigned to each individual file location (see the CD-ROM manual for Direct-Dial listings), and can be “direct dialed” — accessed directly through the use of its four-digit “Direct Macro” number. Note that these Direct Macros are used exclusively for locating Instrument files. Demos, banks, effects, songs, and sequences can be located in the normal way.

The Direct Macros perform in a straightforward way. The first digit of the Direct Macro takes you into the corresponding root directory, the second digit takes you into the corresponding sub-directory, and the last two digits take you to the corresponding Instrument file within that sub-directory. For example, using the ENSONIQ CDR-3 disk, Direct Macro 1201 will take you into root directory 1 (the STRINGED directory), sub-directory 2 (the ACOUSTC GUIT sub-directory) file 01 (the GUILD TWELVE Instrument).

### Invoking a Direct Macro

You can directly locate any Instrument on a CD-ROM disk by entering its Direct Macro number:

- Find the Instrument you wish to locate in the CD-ROM Manual and note the four-digit Direct Macro number directly to the left of the Instrument name.
- Press and hold the **Load** button on the ASR-10.
- While continuing to hold the **Load** button, enter the four-digit Direct Macro number on the ASR-10 keypad.
- Release the **Load** button. As soon as the ASR-10 has located the Instrument on the CD-ROM disk it will display the Instrument name.
- Load the sound in the normal way — press the **Enter • Yes** button, then select the location into which you want the Instrument loaded by pressing one of the eight **Instrument • Sequence Track** buttons.

In addition, you can enter a root directory without entering a sub-directory by using a Direct Macro that ends with the digits “000”. For example, you can enter the PERCUSSION directory (without entering any of its sub-directories) by holding the **Load** button, typing 3000, then releasing the **Load** button.

**Note:** You do not need to manually select the CD-ROM as the storage device to make the Direct Macros work properly — the Direct Macros handle that for you.

**Tip:** You can quickly move to the root level directory from anywhere else by invoking Direct Macro 1000. Hold the **Load** button, type 1000, release the **Load** button, and hit **Enter** in response to the EXIT TO ROOT prompt in the ASR-10 display.

#### Important!

*All Direct Macro operations are performed with the **Load** button held down, and take effect when the **Load** button is released.*

## Section 3 — Instrument, Bank, & Preset Concepts

This section offers a basic overview of the concepts involved in selecting, creating, editing, and understanding Instruments, Banks and Performance Presets. For more detailed descriptions of the actual parameters, refer to the following section.

### Instruments

The ASR-10 keeps all its sounds in a format called an *Instrument*. This format is used for all disk storage. The internal structure of an Instrument has three levels: Instrument, Layer, and WaveSample. Up to 127 WaveSamples are grouped together into layers, and there can be up to eight layers in the instrument. Their relationship is shown in the following diagram:

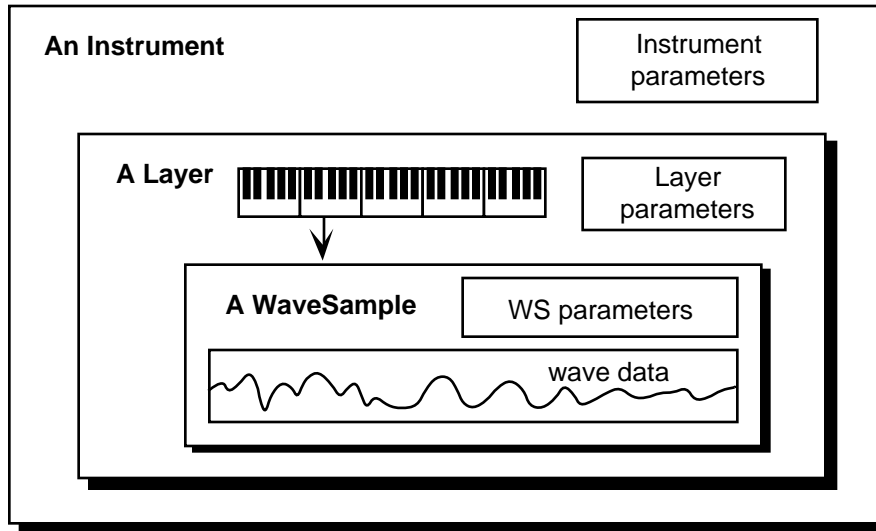

At the instrument level, there are parameters that affect the whole instrument: for example the MIDI functions and the patch select settings. These parameters are found on the Edit/Instrument page. Parameters that affect each layer are found on the Edit/Layer page. Each distinct area of WaveSample editing (i.e. Pitch, Filter, Amp) has its own Edit page.

## Loading an Instrument

You can load up to eight different instruments into the ASR-10 at once (within the limits of memory). First, insert a disk containing one or more instrument files into the disk drive.

- Press **Load**. The LOAD indicator flashes.
- Press **Instrument**. The display looks like this:

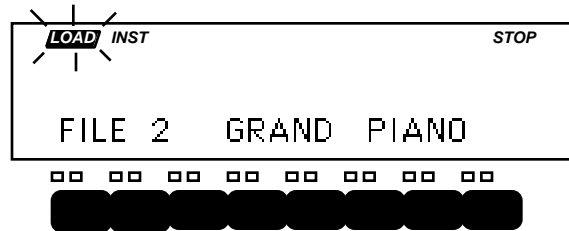

When the LOAD indicator is flashing, the ASR-10 is showing you disk files (think of it as a question mark — the ASR-10 is saying “Load the file showing on the display?”). Pressing the **Up/Down Arrow** buttons takes you through the files on the disk. If there are none, the display will read “NO INST OR BANK FILES.”

Whenever a disk file is displayed as above, you can press the **Left** or **Right Arrow** button to see the size of that file in *Blocks* (a Block is 256 samples; 4 Blocks=1K sample words). Press the **Left** or **Right Arrow** button again to return to the file name.

- Use the **Data Entry Slider** or the **Up/Down Arrow** buttons to view the various instrument files on the disk. Each file has its own File Number. When an instrument file is showing, the INST indicator is lit. The BANK Indicator will light when a bank file is showing.
- Find the instrument you want to load, and press **Enter•Yes**. The display will say PICK INSTRUMENT BUTTON. The ASR-10 is asking in which instrument location you want to load the sound into.
- Press any of the eight **Instrument•Sequence Track** buttons. The ASR-10 will begin immediately loading the instrument into the selected location. The display reads LOADING FILE... and the left red LED *flashes* while the instrument is being loaded.



Once the instrument has been loaded, the display briefly shows “FILE LOADED.” The left red LED above the **Instrument•Sequence Track** button stops flashing and remains solidly lit, indicating that there is now an instrument loaded in that location which can be selected by pressing that button.

If you tell the ASR-10 to load an instrument into a location that already has an instrument loaded (left red LED lit), the new instrument will be loaded into that location and the one that was there will be automatically deleted.

## Saving an Instrument to Disk

After you have created a new ASR-10 instrument, or made changes to an existing instrument, you can save the instrument to a formatted ASR-10 disk with the following steps:

- Insert a formatted disk into the drive. If you don't have a formatted disk, format one before proceeding.
- Press **Command**, then **Instrument**. This puts you on the Command/Instrument page, that contains all the instrument-related commands. Check to make sure that the instrument you want to save is selected. If not, press its **Instrument•Sequence Track** button to select it.
- Press the **Left** or **Right Arrow** button until the display reads SAVE INSTRUMENT (or use this shortcut — after pressing **Command**, double-click on the **Instrument** button).
- Press **Enter•Yes**.
- Edit the Instrument Name (if needed):

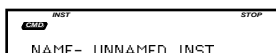

The display shows the current name with a cursor (underline) beneath the first character. If you want to give the instrument a new name, do so at this time. Use the **Data Entry Slider** or the **Up/Down Arrow** buttons to change the underlined character, then press the **Left** or **Right Arrow** button to move the underline. Repeat until the display shows the name you want (if you don't need to rename the instrument, just skip this step).

- Press **Enter•Yes**.  
The display will read SAVING <INST NAME> while the instrument is being saved. Note that you can continue playing the keyboard while the instrument is being saved, and you can select other instruments. You cannot get out of COMMAND mode until the save procedure is done.
- If there is already an instrument file with the same name on the disk, the display will ask DELETE OLD VERSION? Press **Enter•Yes** to save the instrument, replacing the one on the disk. This is for updating instruments to which you have made changes. Or press **Cancel•No** to abort the procedure.
- If there is not enough free space on the disk for the instrument, the display will say NOT ENOUGH DISK SPACE. Save the instrument to another disk (or delete some files from the disk).

## Banks

Banks provide a way to load a whole group of instruments and sequences into the ASR-10 with a few button presses. When you save a Bank to disk, it is like taking a “snapshot” of the contents of the ASR-10 internal memory. The Bank file stores the following information:

- Which instruments are loaded into each **Instrument•Sequence Track** location
- Which song and its related sequences are loaded into the internal memory
- Up to eight discrete Performance Presets
- The Bank Effect and its parameter settings
- The Edit/Track MIX, PAN, OUT, and EFFECT MOD CONTROL setting for each **Instrument•Sequence Track**

For example, you might have a piano loaded into **Instrument•Sequence Track 1**, a bass in **Instrument•Sequence Track 2**, and drums in **Instrument•Sequence Track 3**, and you have created a number of performance presets containing different keyboard configurations of those instruments. Let's say you also have a song in memory, that is composed of 12 sequences. If you now save the contents of memory as a Bank, you can later call up this exact setup by loading the Bank.

## Important Notes About Banks

- The Bank file on a disk doesn't contain the actual instrument and song files — it is just a set of

instructions telling the ASR-10 what to load and where to load it. All the instruments and the song in a Bank must be saved to disk separately (or loaded in from a disk with a proper Disk Label ID) *prior* to saving the Bank.

- Any instruments already loaded into locations not affected by the Bank will be left intact (memory permitting). You can select and play such instruments while the Bank loads. Also, any instruments included in the Bank that are already in memory will be left there and not reloaded, even if they are in different **Instrument•Sequence Track** locations in the new Bank. In such a case the ASR-10 will simply move the instrument to the new location.
- The instrument and song files referred to by a Bank can be on many different disks. Each time you load an Instrument or Song, the ASR-10 “remembers” what disk it was loaded from. When you load a Bank file, the ASR-10 will ask by name for any disks it needs to load the files included in the Bank. This is why it is very important that you give each of your disks a unique name (Disk Label ID) and write that name on the disk itself.
- If there was a song in memory when the Bank was saved, the ASR-10 will automatically load the song as part of the Bank. If you want the Bank to load without a song, erase the contents of the sequencer memory before saving the Bank to disk.

### To Load a Bank

- Press **Load**, then **Instrument**.
- Use the **Up/Down Arrow** buttons to view the different files.

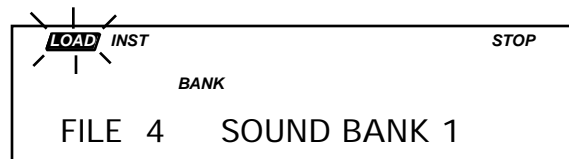

When a Bank file is showing, the BANK indicator lights on the display along with the INST indicator.

- Once a Bank file is showing, press **Enter•Yes**. The ASR-10 will begin loading the instruments and the song data. As it loads each instrument the display tells you what it's doing. As soon as any of the instruments are finished loading, you can select that instrument and play while the rest of the Bank loads.

At some point in the loading process, you may encounter the following message:



This prompt is informing you that an instrument or song saved as part of the Bank is on a different disk than the disk currently in the drive. When this occurs:

- Eject the current disk in the disk drive and replace it with the disk that matches the Disk Label ID requested by the ASR-10 (you are writing these names on your disks, aren't you?).
- Press **Enter•Yes**. The ASR-10 will resume loading until completed, or until the point when it needs another disk.
- When it has finished loading the instruments, the ASR-10 will load the song (if any) and then set up any copied instruments included in the Bank.

### Saving the Contents of Memory as a Bank

Saving a bank is like taking a “snapshot” of the contents of the ASR-10 memory. When you later load a bank, the ASR-10 “looks” at that snapshot and tries to recreate what was in memory when the bank was saved. You can use banks to automatically load a new group of instruments and/or a new song.

Banks are valuable for this reason: ASR-10 songs and sequences have no way of knowing which instruments are loaded into various **Instrument•Sequence Track** locations. Suppose, for example, you record a track with a piano instrument, but then load a kazoo sample into the instrument location where the piano was. The track will now play on the kazoo. By using banks you load instruments into their “proper” location. The Bank file stores the following information:

- Which instruments are loaded into each **Instrument•Sequence Track** location
- Which song and its related sequences are loaded into the internal memory
- Up to eight discrete Performance Presets
- The Bank Effect and its parameter settings
- The Edit/Track MIX, PAN, OUT, and EFFECT MOD CONTROL setting for each **Instrument•Sequence Track**

It’s easy to save the contents of the ASR-10 memory as a bank. Just remember that any instruments in the internal memory, as well as the song, must be saved separately before they can be saved as a bank.

- Save any instruments in memory to disk using the SAVE INSTRUMENT command on the Command/Instrument page.
- Save the song to disk (if you want a song as part of the bank) using the SAVE SONG + ALL SEQs command on the Command/Seq•Song page.
- Press **Command**, then **Instrument**.
- Press the **Left** or **Right Arrow** button until the display reads SAVE BANK.
- Press **Enter•Yes**. The display shows:

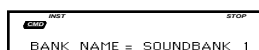

The screenshot shows a rectangular display area with a thin border. At the top left corner, there is a small 'CMD' indicator. At the top right corner, there is a small 'STOP' indicator. The main text in the center of the display reads 'BANK NAME = SOUNDBANK 1'. A horizontal cursor (underline) is positioned beneath the first character, 'S', in the word 'SOUNDBANK'.

The display shows the current name with a cursor (underline) beneath the first character. If you want to give the bank a new name, do so at this time. Use the **Data Entry Slider** or the **Up/Down Arrow** buttons to change the underlined character, then press the **Left** or **Right Arrow** button to move the underline. Repeat until the display shows the name you want. (If you are updating an existing bank, don’t rename the bank; just press **Enter•Yes** and then press **Enter•Yes** once more in response to the question DELETE OLD VERSION?).

- Press **Enter•Yes**.

**Note:** It’s not necessary for the instruments and song to be saved on the same disk as the bank. Each instrument, the song, and bank can be saved on separate disks, but make sure the disks are labelled (WRITE DISK LABEL command found on Command/System•MIDI page) so that the bank can locate the information properly.

## Performance Presets

Once you have a number of instruments loaded into the ASR-10, there are so many possible combinations for selecting, stacking, mixing, and manipulating the ranges of those instruments that it can get a bit hard to manage during a performance. That is where Performance Presets come in.

For each bank, you can create eight performance presets which allow you to store different keyboard configurations. By selecting a performance preset you can instantly recreate the state of the “pile” at the time the preset was created. These eight performance presets are saved with the bank, and are loaded each time a bank is loaded.

Within each preset, the following information is saved for instant recall:

- Which instruments are selected, deselected, or stacked (on the “pile” in Load mode)
- The current “locked in” status of the patch select buttons for each **Instrument • Sequence Track**
- The Edit/Track MIX (volume level), PAN, OUT Bus routing, and EFFECT MOD CONTROL settings for each **Instrument • Sequence Track**
- The Edit/Instrument MIDI OUT CHANNEL number, MIDI OUT PROGRAM number, PRESSURE mode setting, MIDI STATUS setting, PATCH SELECT MODE setting, INST (key) RANGE, and XPOS (transpose) settings for each **Instrument • Sequence Track**

## Selecting Performance Presets

When the ASR-10 is in Load mode (the LOAD indicator solidly lit), pressing the *Page* buttons numbered 1-8 (not the **Instrument • Sequence Track** buttons) will select the eight performance presets once they've been created.

**Tip:** To select Performance Presets when in Edit, Command, or (flashing) Load mode:

- While holding down **Load**, press and release **Instrument**.
- The display will show:



Press a number (page) button to select a Performance Preset. After pressing a number button, the display will return to (solid) Load mode.

This function is labeled on the front panel as (Select Preset) under the Load button.

If there are no Performance Presets defined, the display will briefly show the following message and then return to (solid) Load mode:



If a selected Performance Preset has not been defined, the display will briefly show the following message and then return to (solid) Load mode:

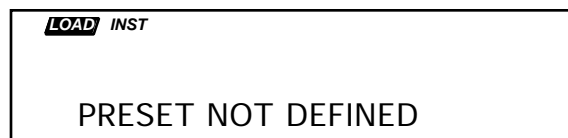



**Note:** When the LOAD indicator is flashing, the display is showing you disk files for loading. When the LOAD indicator is lit but not flashing, the display is showing you the name(s) of the of instruments in the Internal Memory.

### Important Notes about Performance Presets

- Pressing Page button #0 will deselect all the instruments in memory and return them to the original settings for INST (key) RANGE, XPOS (transpose), MIX, etc. that were in effect when they were loaded (or most recently saved to disk). This will undo the effects of any presets currently in effect. You can press Page button #0 at any time (whether a preset is in effect or not) to return all your instruments to their “starting points.”
- If you save an instrument to disk while a preset is in effect, all the current values will be saved with the instrument. Be careful that you don’t accidentally save an instrument with some strange values that you had meant to be part of a temporary setup. You can select Page button #0 before saving the instrument to avoid this.
- If no preset has been created for one of the eight possible locations, pressing that number will have no effect.

### Creating a Performance Preset

Whenever you have set up some configuration of instruments (in Load mode) that you want to preserve for later recall, you can save that configuration as a performance preset with the following steps:

- In Load mode, set up the instruments in memory in some configuration you want to preserve.
- Press **Command**, then **Instrument**.
- Press the **Left** or **Right Arrow** button until the display shows CREATE PRESET.
- Press **Enter** • **Yes**. The display shows:

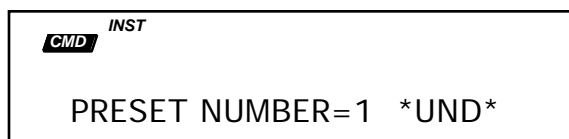

In this example, preset number 1 is undefined (\*UND\* will only appear when a preset is undefined).

**Tip:** In (solid) Load mode, there is a quick way to get to this screen. First set up the Instruments in memory in the configuration that you want to preserve. While holding down the **Command** button, press and release the **Instrument** button.

- Use the **Data Entry Slider** or the **Up** and **Down Arrow** buttons to select a preset number 1-8. This will determine where (of the eight possible performance preset locations) the current keyboard configuration will be saved.
- Press **Enter** • **Yes**. The display reads COMMAND COMPLETED and the preset is made.
- Press **Load** to return to the “Pile.” Pressing the number that you selected for the preset will now instantly recall this keyboard configuration. Repeat this procedure for each performance preset you want to create, selecting a new number (from 1-8) for each.

**Note:** Performance presets are saved to disk only when you save the contents of memory as a bank. When you load a bank, any presets that were present at the time the bank was saved will be recreated.

### Suggested Uses for Performance Presets

The most obvious use for performance presets is to have instant access to different combinations of instruments selected, stacked, and mixed in various ways. Here are some other possibilities:

- Easier access to patch select variations. Suppose you have selected the piano sound and “locked in” some patch variation (by holding down the desired combination of patch select buttons, and then pressing an **Instrument•Sequence Track** button). By creating a preset while the alternate patch is “locked in,” you can later return to that sound just by selecting the preset.
- Controlling remote MIDI devices. Suppose you have created one or more MIDI instruments for sequencing remote MIDI devices from the ASR-10. Each performance preset can store a different MIDI OUT PROGRAM number, VOLUME setting, INST (key) RANGE and XPOS (transpose) amount for each of those remote MIDI devices. When you select a preset, each instrument that has a status of MIDI or BOTH (SEND KEYS TO= on the Edit/Instrument page) will transmit a program change and MIDI volume message on its designated MIDI OUT CHANNEL (assuming TRANSMIT ON = INST CHAN on the Edit/System•MIDI page) to the appropriate remote device. Performance presets let you store up to eight totally different configurations. This allows you to easily recall stacks and combinations of remote MIDI devices.

### Performance Tip — Creating Keyboard Splits

One of the most common uses of presets is a keyboard split, in which your left hand plays an “accompaniment” sound and your right hand plays a “solo” sound. This is easy to set up on the ASR-10 by stacking the two sounds and assigning them different INST (key) RANGES. You can save this arrangement as a preset so that any time you select that preset, you’ll recall the keyboard split. In fact, using this method you can create up to eight split points across the keyboard.

Since each **Instrument•Sequence Track** in the keyboard split has its own XPOS (transpose) value, you are not limited to bass notes on the piano just because it’s on the bottom of the keyboard. On the Edit/Instrument page, set the INST (key) RANGE to the keys you want to play and then transpose the sound up or down until it’s playing in the range you want.

---

## Section 4 — Instrument, Bank, & Preset Parameters

---

This section offers detailed descriptions of the commands and parameters used in selecting, creating, and editing Instruments, Banks and Performance Presets. For an overview of the concepts involved, refer to the previous section.

### Edit/Instrument Page

The parameters on this page are used to modify the individual Instrument(s). To access these parameters press **Edit**, then **Instrument**.

**Tip:** When Edit/Instrument parameters are displayed, pressing a loaded **Instrument•Sequence Track** button will display the Edit/Instrument values for the selected Instrument. This feature provides quick access to the same parameter for different instruments when setting instrument parameter values relative to one another.

<i>EDIT</i>	<b>PATCH (Layer Enable/Disable)</b>
<i>INST</i>	Press Edit / Instrument / 0

### Using the Patch Select Buttons

The two patch select buttons above and to the left of the wheels can be programmed to provide instant access to up to four completely different sounds within each instrument. The alternate sound might be a different set of samples, or the same samples with different envelopes, or a chorused version of the sound, or perhaps a different range of an instrument.

What you are doing when you press either or both of the patch select buttons is selecting different layers to play. A layer is a group of wave samples spread across the keyboard — each instrument can have up to eight layers. For each of the four possible patches, any of these eight layers can be made to play or to remain silent.

- The patch select buttons are “momentary” — an alternate patch will play only on notes played while the button is held down unless you “lock in” a Patch.
- To “lock in” a particular patch so that it will play without having to hold any buttons: while holding down the patch select button(s) corresponding to the patch you want to “lock in,” simply press the **Instrument•Sequence Track** button.
- To return to the default patch (neither patch button down) after you have “locked in” one of the other patches, press the **Instrument•Sequence Track** button again (with neither of the patch select buttons held down).

Here's how a typical instrument might react when you press the different patch select buttons:

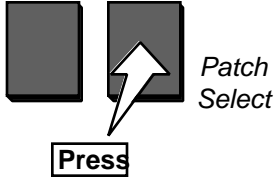
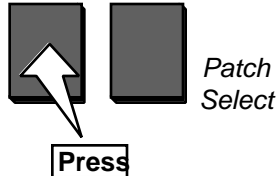
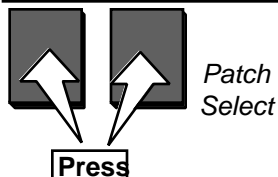
With neither Patch Select button pressed:	The Display shows:	00 PATCH= <u>1</u> 2 3 4 - - - -
 Patch Select Press	The Display shows:	0* PATCH= <u>1</u> - - - - -
 Patch Select Press	The Display shows:	*0 PATCH= <u>2</u> - - - - -
 Patch Select Press	The Display shows:	** PATCH= <u>1</u> 2 - - - - -

- A number means that a given layer is enabled, and will play in that patch;
- A dash means that the layer is disabled for that patch and will not play.

### Programming Patches

The PATCH parameter allows you to program a layer—or combination of layers—to either play or not play depending on which patch select buttons are pressed.

To program patches:

- Select the instrument on which you would like to program patches.
- Select the 00 PATCH parameter (no patch select button pressed).
- With no patch select buttons pressed, use the **Left/Right Arrow** buttons to select the individual layers and the **Up/Down Arrow** buttons to enable and disable them. This will program the default patch (the one that will play with no patch select buttons pressed).
- Once the default patch is programmed, press the left patch select button. Notice that the left hand character in the display is now an asterisk, rather than a zero. This indicates the status of the particular patch select button.
- With the left patch select button held down, use the **Left/Right Arrow** buttons to select the individual layers and the **Up/Down Arrow** buttons to enable and disable them, as you did with the default patch.
- Repeat the procedure with the right hand patch select button held down, then with both patch select buttons held down.
- Remember to resave the instrument after you've made any changes.

The Patch Select buttons are transmitted and received over MIDI as MIDI controller #70.

<i>EDIT</i>	<b>KEYDOWN LAYERS</b>
<i>INST</i>	Press Edit / Instrument / 1

This parameter determines which layer(s) will be triggered when the keyboard is played.

- Select KEYDWN LAYERS=#####. Use the cursor and the **Up/Down Arrow** buttons to select either a number (layer enabled on keydown) or a dash (layer disabled on keydown) for each layer.

<i>EDIT</i>	<b>KEYUP LAYERS</b>
<i>INST</i>	Press Edit / Instrument / 2

This parameter determines which layer(s) will be triggered when a key is released. A good example of this would be the “thunk” sound made by a harpsichord when you release a key. This release sound can be sampled separately and placed in a layer that you designate as a keyup layer. If you want a layer to be triggered *only* when keys are released, be sure to turn that layer off with the KEYDWN LAYERS parameter.

- Select KEYUP LAYERS=#####. Use the cursor and the **Up/Down Arrow** buttons to select either a number (layer enabled on keyup) or a dash (layer disabled on keyup) for each layer.

<i>EDIT</i>	<b>MIDI OUT CHANNEL</b>
<i>INST</i>	Press Edit / Instrument / 3

Use this parameter to determine which MIDI channel the instrument will transmit on, *if* the TRANSMIT ON= parameter on the EDIT/System•MIDI page is set to INST CHANNEL. Any of the 16 MIDI channels can be selected.

If TRANSMIT ON=BASE CHANNEL, the ASR-10 will only transmit on the Base MIDI channel (also on the EDIT/System•MIDI page) no matter which MIDI channel is selected.

Also, if the instrument has been assigned LOCAL status, it won't matter what MIDI channel you assign here — playing that instrument will not transmit any MIDI information.

**Note:** Sequence playback will always transmit on the MIDI OUT CHANNEL, even if Edit/System•MIDI, TRANSMIT ON=BASE CHAN.

Range: MIDI channels 1 to 16

<i>EDIT</i>	<b>MIDI OUT PROGRAM</b>
<i>INST</i>	Press Edit / Instrument / 4

This parameter allows you to choose which program change number will be transmitted via MIDI when the instrument is selected. If the instrument's Edit/Instrument MIDI STATUS is set to LOCAL, it won't matter what this parameter is set to because the instrument will not transmit program changes. The MIDI OUT PROGRAM for each instrument is stored in the eight performance presets, so you can use presets to transmit new program changes from any instrument that has its MIDI STATUS set to BOTH, MIDI or EXT. Editing this value will transmit the program change number that is displayed.

Range: 1 to 128

**Tip:** MIDI OUT PROGRAM numbers can be entered directly from the numeric keypad from any mode. Here's how:

- While holding down the appropriate **Instrument•Sequence Track** button (the one that will transmit on the desired MIDI channel), use the numeric keypad (page buttons) to type in the program number that you want to transmit.
- Release the **Instrument•Sequence Track** button when you want to transmit the program change that you have entered. The program change will be transmitted *at the moment the button is released*.

<i>EDIT</i>	<b>PRESSURE MODE</b>
<i>INST</i>	Press Edit / Instrument / 5

If TRANSMIT=INST CHAN (on the Edit/System•MIDI page) then this parameter determines which type of pressure—channel or Poly-Key™, or no pressure at all—will be transmitted on the instrument's MIDI OUT CHANNEL. If the instrument MIDI STATUS= LOCAL or BOTH, this parameter determines what type of pressure (if any) the instrument will respond to when you play the keyboard.

When PRESSURE MODE=OFF:

- Local voices played from the keyboard or the sequencer will not respond to pressure.
- The sequencer will not record pressure into any tracks you record.
- The sequencer will not play back any key or channel pressure messages recorded on the track.
- The instrument will not transmit or receive pressure of either type via MIDI.

**Note:** You should select PRESSURE MODE=OFF whenever you don't want or need pressure for a given instrument, particularly when sequencing. Pressure data eats up sequencer memory rapidly, so whenever you record a track (whether it plays LOCALLY, via MIDI or BOTH), with a sound that doesn't respond to pressure, set this parameter to OFF. This will avoid wasting valuable sequencer memory, and will avoid clogging up the MIDI data stream with a lot of unnecessary pressure information.

When PRESSURE MODE=KEY:

- Local voices played from the ASR-10 keyboard will respond to key pressure only.
- The sequencer will record key pressure into any tracks you record.
- The sequencer will play back any key pressure messages recorded on the track, and will ignore any channel pressure on the track.
- The ASR-10 keyboard will only transmit key pressure out via MIDI; however,
- Either channel pressure or key pressure will be received via MIDI.

When PRESSURE MODE=CHAN:

- Local voices played from the ASR-10 keyboard will respond to channel pressure only.
- The sequencer will record channel pressure into any tracks you record.
- The sequencer will play back any channel pressure messages recorded on the track, and will ignore any key pressure on the track.
- The ASR-10 keyboard will only transmit channel pressure out via MIDI, however.
- Either channel pressure or key pressure will be received via MIDI.

**Note:** When SEQ REC SOURCE = MULTI on the Edit/Seq•Song page, the ASR-10 sequencer will always record both channel and key pressure (received via MIDI), no matter what the PRESSURE MODE parameter is set to.

At present, channel pressure is recognized by more MIDI devices than key pressure. If you are playing or sequencing an external MIDI device from the ASR-10 and pressure doesn't seem to have an effect, it could be the ASR-10 is set to transmit key pressure and the receiving instrument only recognizes channel pressure. In this case, set this parameter to PRESSURE MODE= CHAN when playing or sequencing that instrument.

EDIT	<b>MIDI STATUS</b>
INST	Press Edit / Instrument / 6

This parameter will determine whether the instrument will play LOCALLY (only on the ASR-10), or via MIDI, or BOTH. There are four possible settings:

- BOTH — The instrument will be played locally and will transmit via MIDI when the instrument is played from the keyboard or the sequencer. In addition, incoming MIDI will play internal voices.
- LOCAL — The instrument will only play local (internal) voices, and will not transmit via MIDI. Incoming MIDI will also play local voices.
- MIDI — Keys, controllers, etc. will be transmitted via MIDI when the instrument is played from the keyboard or the sequencer. The keyboard or the sequencer will not play ASR-10 voices at all. However, incoming MIDI will play internal voices. This is comparable to Local Off on some keyboards. Use this status when you want to create MIDI-only instruments for playing or sequencing Remote MIDI Devices.
- EXT — This mode is similar to MIDI, except that incoming MIDI will *not* play internal voices.

**Note:** These settings are in effect only when TRANSMIT ON=INST CHANNEL on the Edit/System•MIDI page.

TRACK STATUS =	BOTH	LOCAL	MIDI	*EXT*
Playing the keyboard plays local voices	Yes	Yes	No	No
Playing the keyboard transmits via MIDI	Yes	No	Yes	Yes
Playing the sequencer track (pressing <b>Play</b> ) plays local (internal) voices	Yes	Yes	No	No
Playing the sequencer track (pressing <b>Play</b> ) transmits via MIDI	Yes	No	Yes	Yes
Incoming MIDI data plays local voices	Yes	Yes	Yes	No

<i>EDIT</i>	<b>SIZE (in blocks)</b>
<i>INST</i>	Press Edit / Instrument / 7

This display shows how much internal memory the instrument occupies. This is a *readout only* and can't be modified. Size is shown in *Blocks*. One Block=256 samples (or words). Four Blocks=1k sample/word.

When you want to know if there's enough room to save a particular instrument to a particular disk, you can compare the instrument size (shown here), to the FREE DISK BLOCKS shown on the Edit/System•MIDI page.

<i>EDIT</i>	<b>INST NAME</b>
<i>INST</i>	Press Edit / Instrument / 8

You can use this parameter to change the name of an existing instrument, or name a new one that you've just created. The display shows the twelve-character name of the instrument with a cursor beneath the first character. Newly sampled or created instruments are given the default name UNNAMED INST.

- Select NAME=####. Use a combination of the **Arrow** buttons and **Data Entry Slider** to name/rename the instrument.

<i>EDIT</i>	<b>PATCH SELECT MODE</b>
<i>INST</i>	Press Edit / Instrument / 9

This parameter differs from the PATCH parameter (earlier in this section) in that this parameter allows you to permanently "lock in" one of the four patch variations, or to select a special HELD mode. The PATCH parameter, on the other hand, programs which combinations of layers will play for each of the four patch select button assignments.

<b>Setting</b>	<b>Patch used by track</b>
LIVE	uses the current state of the buttons to select a patch
-00-	always uses the 00 patch
-0*-	always uses the 0* patch
-*0-	always uses the *0 patch
._**_	always uses the ** patch
HELD	uses the patch set by the first key hit while pressing the patch buttons

The HELD setting is special because it lets you easily hold a patch select variation by playing a key on the keyboard while pressing the patch select button(s). The first key you play after pressing the patch select buttons will hold that patch select variation as the current patch for the track. You may then continue to play without having to press the patch select buttons, thus making two-handed playing easier. If you wish to return to the 00 patch, press either of the patch select buttons and release it *before* you play the next note. This will hold the 00 patch.



EDIT	<b>INST (Key) RANGE</b>
INST	Press Edit / Instrument / scroll using the arrow buttons

This parameter allows you to set the keyboard range of the instrument. Keyboard ranges are very important in the creation of keyboard splits and layers. The ASR-10 allows you to set the keyboard range in a very easy fashion.

- Select the LO=\_\_ half of Instrument Key Range parameter, then:

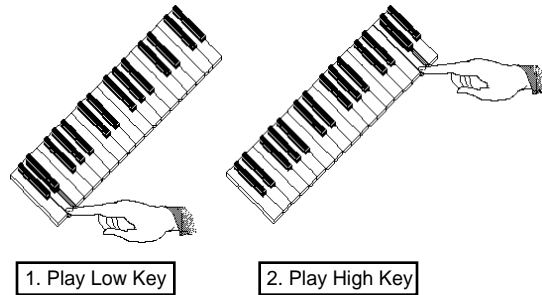

Make sure after you've set the ranges that you change screens before playing the keyboard again. The Instrument key range parameter is always active when shown on the display. You can also use the **Data Entry Slider** and the **Up/Down Arrow** buttons to set the key range.

Range: KY0 to K11, C0 to G9

**Note:** Keys in the octave below C0 are displayed as KY0 through K11. These values are only accessible when the instrument is transposed up.

**Note:** If you set the Low Key *higher* than the High Key, the instrument is in effect turned off and will make no sound. If you do this, simply reset the parameters.

EDIT	<b>XPOS OCT - SEMI (Transpose)</b>
INST	Press Edit / Instrument / scroll using the arrow buttons

Each instrument can have its pitch transposed (raised or lowered) by octaves and semitones within an eight octave range. The transpose setting affects both the pitch played by Local ASR-10 voices and the key number transmitted via MIDI.

The **Left/Right Arrow** buttons will toggle the underline (showing the active field) between octave and semitone.

Octave Range: -4 to +4 octaves

Semitone Range: -11 to +11 semitones

**Tip:** It is possible to extend the transposition outside of the normal range by using the **Up/Down Arrow** buttons to edit the semitone value to a maximum of + or - 9 octaves and 11 semitones, although this may cause unexpected results.

## Command/Instrument Page

<i>CMD</i>	<b>CREATE NEW INSTRUMENT</b>
<i>INST</i>	Press Command / Instrument / 0

Use this command to create a new instrument. This is useful for creating instruments that will only play out via MIDI (MIDI Instruments).

- Select CREATE NEW INSTRUMENT.
- Press **Enter•Yes**. The display reads SELECT UNUSED INSTR=##.
- Press one of the unused **Instrument•Sequence Track** buttons.
- Press **Enter•Yes**. The display reads COMMAND COMPLETED.

<i>CMD</i>	<b>COPY INSTRUMENT</b>
<i>INST</i>	Press Command / Instrument / 1

Use this command to copy the selected instrument. This is useful for making copies of an instrument in several tracks for sequencing. The copies don't use any internal memory, they just "point to" the data in the original instrument.

- Select COPY INSTRUMENT.
- Press **Enter•Yes**. The display reads SELECT UNUSED INST=##.
- Press one of the unused **Instrument•Track** buttons.
- Press **Enter•Yes**. The display reads COMMAND COMPLETED.

**Tip:** Try the following shortcut to copy an Instrument:

- Make sure the instrument you want to copy is selected.
- While holding down the empty **Instrument•Track** button that you want to copy the selected instrument to, press **Enter•Yes**.

<i>CMD</i>	<b>DELETE INSTRUMENT</b>
<i>INST</i>	Press Command / Instrument / 2

Use this command to delete the selected instrument from the Internal Memory. Note that this command has no effect on disk files, only on the Internal RAM Memory.

- Select DELETE INSTRUMENT.
- Press **Enter•Yes**. The display reads DELETE <name of Instrument>?
- Press **Enter•Yes**. The display reads COMMAND COMPLETED.

**Tip:** Try the following shortcut to delete an Instrument:

- Make sure the instrument you want to delete is selected.
- While holding down the **Instrument•Track** button of the instrument you want to delete, press **Cancel•No**.

<i>CMD</i>	<b>SAVE INSTRUMENT</b>
<i>INST</i>	Press Command / Instrument / 3

Use this command to save the selected instrument to floppy disk (or to a SCSI device). This is important because the ASR-10 does not save any Instruments, Banks, Presets or Sequence/Songs internally — if you were to power down, you would lose any unsaved information.

- Insert a formatted disk into the drive. If you don't have a formatted disk, format one before proceeding.
- Check to make sure that the instrument you want to save is selected. If not, press its **Instrument•Sequence Track** button to select it.
- Press the **Left** or **Right Arrow** button until the display reads SAVE INSTRUMENT (or use this shortcut — after pressing **Command**, double-click on the **Instrument** button).
- Press **Enter•Yes**.
- The display shows the current name with a cursor (underline) beneath the first character. If you want to give the instrument a new name, do so at this time. Use the **Data Entry Slider** or the **Up/Down Arrow** buttons to change the underlined character, then press the **Left** or **Right Arrow** button to move the cursor. Repeat until the display shows the name you want (if you don't need to rename the instrument, just skip this step).
- Press **Enter•Yes**.  
The display will flash SAVING <INST NAME> while the instrument is being saved. Note that you can continue playing the keyboard while the instrument is being saved, and you can select other instruments. You cannot get out of Command mode until the save procedure is done.
- If there is already an instrument file with the same name on the disk, the display will ask DELETE OLD VERSION? Press **Enter•Yes** to save the instrument, replacing the one on the disk. This is for updating instruments to which you have made changes. Or press **Cancel•No** to abort the procedure.
- If there is not enough free space on the disk for the instrument, the display will say NOT ENOUGH DISK SPACE. Save the instrument to another disk (or delete some files from the disk).

<i>CMD</i>	<b>SAVE BANK</b>
<i>INST</i>	Press Command / Instrument / 4

Use this command to save the current Bank. Banks provide a way to load a whole group of instruments and sequences into the ASR-10 with a few button presses. When you save a Bank to disk, it is like taking a “snapshot” of the contents of the ASR-10 internal memory. The Bank file stores the following information:

- Which instruments are loaded into each **Instrument•Sequence Track** location
- Which song and its related sequences are loaded into the internal memory
- Up to eight discrete Performance Presets
- The Bank Effect and its parameter settings
- The Edit/Track MIX, PAN, OUT, and EFFECT MOD CONTROL setting for each **Instrument•Sequence Track**

It's easy to save the contents of the ASR-10 memory as a bank. Just remember that any instruments in the internal memory, as well as the song, must be saved separately before they can be saved as a bank.

- Save any instruments in memory to disk using the SAVE INSTRUMENT command.
- Save the song to disk (if you want a song as part of the bank) using the SAVE SONG + ALL

- SEQS command on the Command/Seq•Song page.
- Select SAVE BANK.
- Press **Enter•Yes**. The display shows:

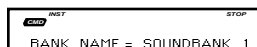

The display shows the current name with a cursor (underline) beneath the first character. If you want to give the bank a new name, do so at this time. Use the **Data Entry Controls** to name the bank (as explained earlier in SAVE INSTRUMENT). (If you are updating an existing bank, don’t rename the bank; just press **Enter•Yes** and then press **Enter•Yes** once more in response to the question DELETE OLD VERSION?).

- Press **Enter•Yes**.

**Note:** It’s not necessary for the instruments and song to be saved on the same disk as the bank. Each instrument, the song, and bank can be saved on separate disks, but make sure the disks are labeled with a unique disk label (see the WRITE DISK LABEL command found on Command/System•MIDI page) so that the bank knows which disk the files are saved on, and can locate the information properly.

CMD	<b>CREATE PRESET</b>
INST	Press Command / Instrument / 5

This command is used to create each of the eight Performance Presets within a Bank.

Within each preset, the following information is saved for instant recall:

- Which instruments are selected, deselected, or stacked (on the “pile” in Load mode)
- The current “locked in” status of the patch select buttons for each **Instrument•Sequence Track**
- The Edit/Track MIX (volume level), PAN, OUT Bus routing, and EFFECT MOD CONTROL settings for each **Instrument•Sequence Track**
- The Edit/Instrument MIDI OUT CHANNEL number, MIDI OUT PROGRAM number, PRESSURE mode setting, MIDI STATUS setting, PATCH SELECT MODE setting, INST (key) RANGE , and XPOS (transpose) settings for each **Instrument•Sequence Track**
- In Load mode, set up the instruments in memory in some configuration you want to preserve.
- Press **Command**, then **Instrument**.
- Press the **Left** or **Right Arrow** button until the display shows CREATE PRESET.
- Press **Enter•Yes**. The display shows:

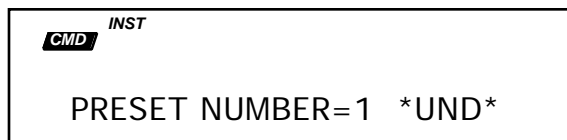

In this example, preset number 1 is undefined (\*UND\* will only appear when a preset is undefined).

**Tip:** There is a quick way to get to this screen in any mode. First set up the Instruments in memory in the configuration that you want to preserve. While holding down the **Command** button, press and release the **Instrument** button.

- Use the **Data Entry Slider** or the **Up** and **Down Arrow** buttons to select a preset number 1-8. This will determine where (of the eight possible performance preset locations) the current keyboard configuration will be saved.
- Press **Enter•Yes**. The display reads COMMAND COMPLETED and the preset is made.

- Press **Load** to return to the “Pile.” Pressing the number that you selected for the preset will now instantly recall this keyboard configuration. Repeat this procedure for each performance preset you want to create, selecting a new number (from 1-8) for each.

This function is labeled on the front panel as (Create Preset) under the Command button.

**Note:** Performance presets are saved to disk only when you save the contents of memory as a bank. When you load a bank, any presets that were present at the time the bank was saved will be recreated.

<i>CMD</i>	<b>DELETE INST EFFECT</b>
<i>INST</i>	Press Command / Instrument / 6

This command deletes the Effect portion of an instrument. This is a handy “memory saver.” If memory is tight and you’re using several instruments through a single BANK effect, deleting the effect from each of the individual instruments in memory can free up enough memory to squeeze in that final track. Deleting the effect from an instrument trims about three blocks from its size.

- Select the **Instrument•Sequence Track** that has the effect that you want to delete.
- Select **DELETE INST EFFECT**.
- Press **Enter•Yes**.
- The display shows **COMMAND COMPLETED**.

After performing this command, the instrument itself will contain no effect. However, the instrument can still use the BANK or ROM effects.

# Section 5 — Effect Concepts

---

This section offers a basic overview of the concepts involved in selecting, creating, editing, and understanding Effects. For more detailed descriptions of the actual parameters, refer to the following section.

## Understanding ASR-10 Effects

The ASR-10 has a powerful built in signal processor that can produce an extraordinary variety of effects. What is more important, its functions are integrated with, rather than added onto, the rest of the sampler. The flexible bus routing scheme and the extensive real-time control give the ASR-10 its *dynamic* effects capability.

The ASR-10 offers continuous audio monitoring of the stereo audio inputs on two dedicated Audio Tracks. The audio inputs can be monitored through the Effects, and if desired, audio input can be sampled through the Effects. The ASR-10 also has the ability to resample sounds with effects in real time. For example: add reverb to a drum sample, resample it, then reuse the effects processor to further color your music.

The ASR-10's advanced digital signal processing system is based on the ENSONIQ Signal Processor (ESP) chip. The ESP is designed specifically for digital audio signal processing, and in the ASR-10 it works in tandem with a fourth generation version of the Digital Oscillator Chip (DOC IV, a.k.a. OTTO) and an external 16-bit digital-to-analog converter, to provide a very high-quality output signal.

The digital effects processing has been designed to complement the advanced performance features of the ASR-10, and many of the effects can have specific parameters modulated by various performance controls such as the modulation wheel, Poly-Key™ pressure, and others.

The effects are fully programmable and may be customized for particular applications. Effects are most often stored as part of an Instrument, although each bank has its own independent effect. Each of these types of effects is treated a little differently and will be described individually later in this section.

The ASR-10 has three distinct types of effects: Instrument Effects, Bank Effects, and ROM Effects, all of which behave in different ways.

**Note:** In this manual you may notice the term algorithm. An algorithm is the basic signal processing building block in the ASR-10. The word “effect” could be used instead of algorithm, but some algorithms can produce several sonic effects simultaneously. Each algorithm has a set of parameters used to control the effect(s) it produces.

### INST (Instrument) Effects

Each instrument that you load into the ASR-10 contains an effect and a complete set of parameter values that determine how that effect will sound. The effect is present even if none of the voices in the instrument are routed through the effect (e.g. all voices are sent to the AUX 1, 2, or 3 destination busses), or FX= OFF, BANK, or ROM on the FX Select•FX Bypass page. Whenever you save an instrument, the effect settings are also saved with the instrument.

The current Instrument effect is displayed by pressing the **FX Select•FX Bypass** button and scrolling with the **Data Entry Slider** or the **Up/Down Arrow** buttons until the display shows FX= INST, and edited by pressing **Edit**, then **Effects**.

**Note:** To delete an instrument's effect, use the Command/Instrument **DELETE INST EFFECT** Command.

**Tip:** When the FX Select•FX Bypass page is displayed, and FX= INST, pressing a loaded **Instrument•Sequence Track** button will display that instrument's effect. This feature provides a quick way to view which effect is assigned to each instrument.

### BANK Effect

Each bank contains an effect and a complete set of effect parameters. When selected, this effect applies to all instrument/tracks (or their instrument voices) that are routed to BUS 1, 2, or 3. You can think of Instrument Effects as *individual* effects and Bank Effect as a *global* effect.

The Bank Effect is saved with each bank. It will remain unaffected until a new bank is loaded, unless it is specifically edited. Switching instruments within the bank will not select a new effect.

Whenever an independent effect file (one that is not attached to either an instrument or a bank) is loaded from disk into the ASR-10, it is placed in the Bank Effect location.

The Bank Effect is displayed by pressing the **FX Select•FX Bypass** button and scrolling with the **Data Entry Controls** until the display shows FX= BANK, and edited by pressing **Edit**, then **Effects**.

### ROM Effect

In addition to the Bank Effect, that can be changed by loading in a new effect from disk, or Command/Effect, **COPY CURRENT EFFECT** command (more on that later in the section), there are a large number of additional ROM Effects.

ROM Effects are similar to the Bank Effect in that they perform globally, affecting all instruments residing in memory. However, they differ in the fact that while the Bank Effect can be replaced, the ROM Effects are stored in *Read Only Memory* and will always reside in the ASR-10. Even after turning off the ASR-10, the ROM Effects will stay in memory.

The ROM Effects are displayed by pressing the **FX Select•FX Bypass** button and scrolling with the **Data Entry controls**. If you edit any of the parameters of a ROM effect (on the **Edit/Effects** page), that effect is instantly copied into the Bank Effect location.

**Tip:** To return to the ROM Effect location after editing any parameters (after the ROM effect has become the Bank Effect), from the FX Select•FX Bypass page, press **Cancel•No**. This function can also serve as a handy "MIDI panic button" (all notes off) to stop any droning notes received via MIDI.

## Selecting Effects

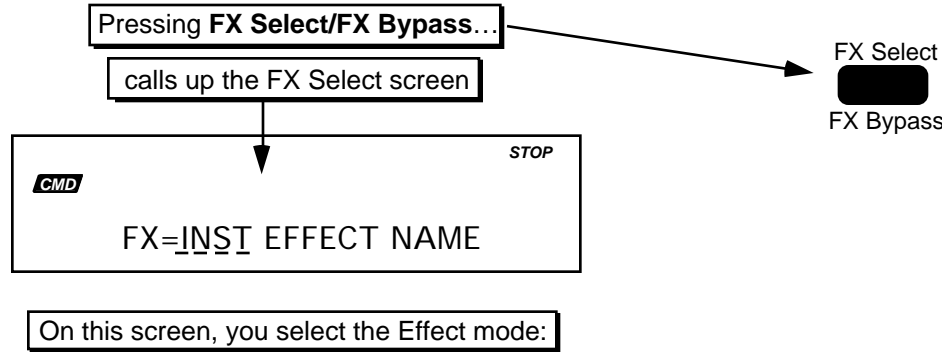

On this screen, you select the Effect mode:

FX=	OFF	INST	BANK/ROM#
		<input type="checkbox"/> <input type="checkbox"/> <input type="checkbox"/> <input type="checkbox"/> <input type="checkbox"/> <input type="checkbox"/> <input type="checkbox"/> <input type="checkbox"/> <input type="checkbox"/> <input type="checkbox"/>	
		1 2 3 4 5 6 7 8	
	When OFF is selected, all sounds are dry, regardless of their output setting.	When INST is selected, the instruments control the effect. In this mode, each time an instrument is selected, its related effect is loaded into the ASR-10. Any stacked instruments will use the primary instrument's effect.	Both BANK and the ROM effects are GLOBAL effects. When selected, they become the effect for all instruments. Each instrument still has control over its Output Bus and Mix controls.

The main parameter of the FX Select/FX Bypass page is the effects selector. Changing this parameter causes a new effect to be selected, which in turn changes the type of parameters that will be available on the Edit/Effects page. This parameter may also change the Effect Type, which will affect how individual instruments within the internal memory will interact with the effect (see the preceding discussion on effect types). Selecting a new effect will automatically set all of the effect parameters to their default values for the new effect. The ROM Effects, those that always reside within the internal memory of the ASR-10, are selected here.

### ROM Effects List

These are the available ROM Effects within the ASR-10:

- |               |   |
|---------------|---|
| HALL REVERB   | Hall, left to right (transverse) reflections  |
| 44KHZ REVERB  | A hall reverb utilizing the 44KHZ playback rate   |
| ROOM REVERB   | A reverb featuring a shorter, room-like decay   |
| DUAL DELAYS   | A dual delay with separate left and right delay times   |
| 44KHZ DELAYS  | A dual delay utilizing the 44KHZ playback rate  |
| CHORUS+REVRB  | Four-voice chorus combined with reverb  |
| PHASER+REVRB  | Phase shifter combined with reverb  |
| FLANGER+REV   | Flanger combined with reverb  |
| ROT. SPKR+REV | Rotating speaker simulator with reverb and distortion   |
| CHOR+REV+DDL  | Chorus with reverb plus digital delay   |
| CMP+DIST+REV  | Compression, Distortion, and Reverb. Great for guitar and amp simulation with acoustic feedback |
| DIST+CHO+REV  | Distortion with chorus and reverb   |
| WAH+DIST+REV  | “Volume-Wah” effect with distortion and reverb  |



SMALL ROOM	An ambient room reverb
LARGE ROOM	A room reverb with larger ambience
HALL REVERB2	This hall reverb offers a large acoustic space
SMALL PLATE	A tight sounding plate reverb
LARGE PLATE	Simulates a larger plate reverb
REVRSE REVRB	A reverb that gradually increases, simulating a backwards sound
REVRSE REVB2	Like REVRSE REVRB, this algorithm will retrigger by a controllable input signal level
GATED REVERB	The popular gated reverb sound
NLIN REVRB 1	Non linear reverb with a short duration time
NLIN REVRB 2	Non linear reverb with a long duration time.
NLIN REVRB 3	Similar to NLIN REVRB 1, with less stereo movement
MULTITAP DDL	Four independent controllable delays
EQ+DELAY LFO	A stereo delay with LFO modulation
VCF+DISTORT	Combines a voltage control filter and a raspy distortion.
GUITAR AMP1	The warm sound of a Hard Rock guitar amp
GUITAR AMP2	The “bluesy” sound of a guitar amp
GUITAR AMP3	An inverse expander with a bright distortion amp for lead sounds
SPKR CABINET	Simulates an open back speaker
TUNABLE SPKR	An EQ controllable speaker sound
EQ+CHOR+DDL	EQ with chorus plus digital delay
EQ+VIBR+DDL	EQ with vibrato plus digital delay
EQ+FLNGR+DDL	EQ with flanger and digital delay
EQ+TREM+DDL	EQ with tremolo and digital delay
PHASER+DDL	Phaser with a digital delay
8-VOICE CHOR	A rich chorus with eight different voices
PITCH SHIFT	Splicer type pitch shifter
PITCH+DDL	A pitch shifter and a digital delay
FAST PITCHSH	Pitch shifter designed for pitch correction
EQ+COMPRESSOR	EQ with a compressor
EXPANDER	Performs downward expansion of input signals
KEYED EXPNDR	An expander that is triggered from another source
INVRS EXPNDR	Creates sustain by expanding low signal levels
DE-ESSER	Compresses sibilant frequencies
DUCKER	One signal controls the volume of another signal by compression
RUMBLE FILTR	High pass filter in cascade with a low pass filter
PARAM EQ	Minimum phase four band parametric EQ
VAN DER POL	Adds synthetic high harmonics, brightening the overall sound

## Sample Rate

Each Effect has a defined number of voices that it can play, based on its sample rate. To view the current sample rate, from the FX Select screen, press the **Left Arrow** button. The display shows:



Pressing the **Right Arrow** button will return you to the FX Select screen.

**Note:** Changing the Effect could change the sample rate that will be viewed in sample mode. A lower sample rate gives you a longer sample time, because it takes fewer samples per second. A higher sample rate allows you to sample with increased fidelity (because it takes more samples per second). Changing the sample rate also affects the polyphony:

If the sample rate is...	then polyphony is...	and the sample time is...
30 kHz	31 voices	longer
44 kHz	23 voices	shorter

**Note:** When the optional DI-10 Digital Interface is installed, the Digital Output will provide digital audio output of the Main Output mix, if the current effect uses a 44.1 KHz sample rate

## Instruments and Banks

The complete effects setup, including the values of all effect parameters, is saved when you save an instrument. It is *also* saved with each bank. The ASR-10 is smart about switching effects, since all sound must stop for an instant when it changes effects.

### When are New Effects Loaded Into the ESP chip?

- When you select an instrument from one of the **Instrument • Sequence Track** buttons with FX=INST on the FX Select/FX Bypass page, the effect saved in that instrument will be loaded into the ESP, and you will hear the sound with its associated effect.
- When you load a new Bank, a new Bank Effect is loaded into the ESP.
- When you load an individual effect (one that is not part of a Bank or an Instrument), it is loaded into the ESP and becomes the new Bank Effect.
- When you select or layer instrument/tracks with FX=BANK or FX=ROM on the FX Select/FX Bypass page, the effect is *not* changed.

Whenever a new effect is loaded into the ESP, the audio output will pause briefly, allowing the instructions that create the new effect algorithm to be loaded into the ESP. If an effect differs only by variation in parameter values, then this pause will not occur.

## Loading and Saving ASR-10 Effects

### Loading an Effect File

You can load an effect from disk into the internal memory of the ASR-10. The effect will load into the Bank effect location, replacing whatever effect was there previously.

First, insert a disk containing one or more effect files into the disk drive.

- Press **Load**. The LOAD indicator flashes.
- Press **Effects**. The display looks something like this:



When the LOAD indicator is flashing, the ASR-10 is showing you disk files. Pressing the **Up/Down Arrow** buttons takes you through the effect files on disk. If there are none, the display will read NO EFFECT FILES.

Whenever a disk file is displayed as above, you can press the **Left** or **Right Arrow** button to see the size of that file in *Blocks* (a Block is 256 samples; 4 Blocks=1K samples). Press the **Left** or **Right Arrow** button again to return to the file name.

- Use the **Data Entry Slider** or the **Up/Down Arrow** buttons to view the various effect files on the disk. Each file has its own File Number.
- Find the effect you want to load, and press **Enter•Yes**. The ASR-10 will load that effect into the BANK effect slot. When finished, the display will read DISK COMMAND COMPLETED.

### Saving an Effect to Disk

Use the SAVE BANK EFFECT command to save an effect to disk. If you wish to save, as a separate effects file, either a ROM effect or an INST effect, you must first copy the effect into the BANK effect using the COPY CURRENT EFFECT parameter on the Command/Effects page (see Section 6 — Effect Parameters) and then save it.

- Insert a formatted disk into the drive.
- Press **Command**, then press **Effect**.
- Press the **Left** or **Right Arrow** button until the display reads SAVE EFFECT.
- Press **Enter•Yes**.
- Edit the effect name (if necessary):

The display shows the current name of the effect, with a cursor (underline) beneath the first character. If you want to give the effect a new name, do so at this time. Use the **Data Entry Slider** or the **Up/Down Arrow** buttons to change the underlined character, then press the **Left/Right Arrow** buttons to move the underline. Repeat until the display shows the name you want. If you are saving a ROM effect, the name will not be able to be edited (if you don't need to rename the effect, just skip this step).

- Press **Enter•Yes**. The display will read SAVING <FILE NAME> while the effect is being saved.
- If there is already an effect file with the same name on the disk, the display will ask DELETE OLD VERSION? Press **Enter•Yes** to save the effect, replacing the one on the disk. Or press **Cancel•No** to abort the procedure.
- If there is not enough free space on the disk, the display will show NOT ENOUGH DISK SPACE. Save the effect to another disk (or delete some files from the disk).

## Programming Effects

The ASR-10 effects are highly programmable. Each effect has a wide variety of parameters for editing. The FX Select/FX Bypass page contains the parameter for selecting which effect will be used. This page controls how all of the other effect screens (found on the Edit/Effects page) will be configured and displayed. When this parameter is changed, a new effect is selected which causes several important things to occur:

- a new effect is loaded, causing a brief pause in the audio output
- the number of voices and the system sample rate may change
- the effect parameters are redefined for the particular effect selected
- the effect parameter values are reset to their default settings

## Effect Variations

The first parameter screen is similar for all of the effects (the display shows VAR=). It selects one of four Effect Variations, which feature various “preset” patches, letting you quickly access several set-ups within the same effect. Each of these four variations is individually editable and can act as four effect edit buffers. Each Effect Variation can have two different Modulation Sources, Destination parameters, and defined modulation ranges (for a total of eight different modulatable parameters).

## The Effects Busses

The output of every voice in the ASR-10 is assigned to a stereo bus. A bus, like the bus of a mixing board, mixes together all the voices assigned to that bus into a single stereo pair. Of the six busses on the ASR-10, three are inputs into the signal processor (BUS1, BUS2, and BUS3), and three are direct paths to the AUX outputs on the optional Output Expander, bypassing all effect processing (dry). The Destination Bus assignment for each WaveSample is set on the Edit/Amp page. The voice settings in the sound can be overridden for each bank from the FX Select/FX Bypass page.

## Effects Mixing

All effects have separate mixing controls for the BUS1, BUS2, and BUS3 (when not used as a DRY path) busses. They are found on three screens within the Edit/Effects page, and will have slightly different wording depending on the effect they're contained within.

When an effect having a single processing function (such as reverb only) is selected, both busses BUS1 and BUS2 are routed to it. When using a dual or multi-effect, BUS1 will generally route the signal through both or all effects, with BUS2 routing only through the second effect. In most cases, the BUS3 bus is reserved as a DRY path to the main outputs.

### Single Function Effect Mixer

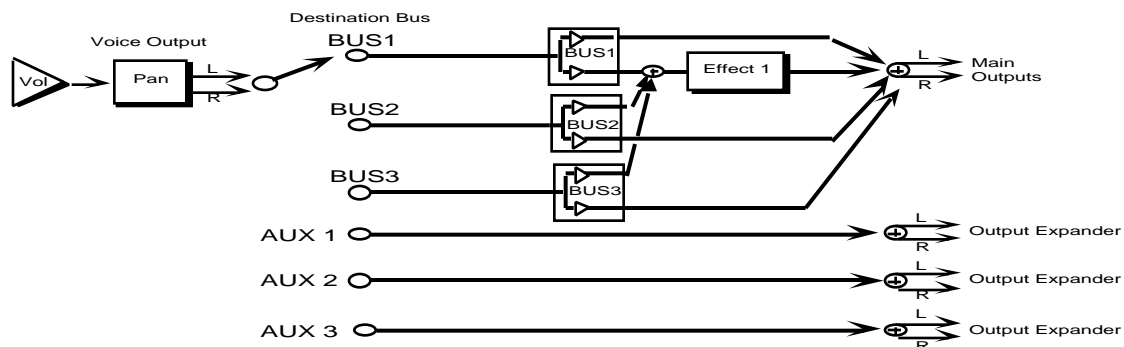

The above diagram shows the effects busses and the output mixing. Every voice is assigned to one of the four stereo busses, which go around or through the effects processing. The heavy lines are stereo paths. Some effects, such as HALL REVERB, also have a Dry/Wet mix of BUS3 into Effect 1.

### Dual Function Effect Mixer

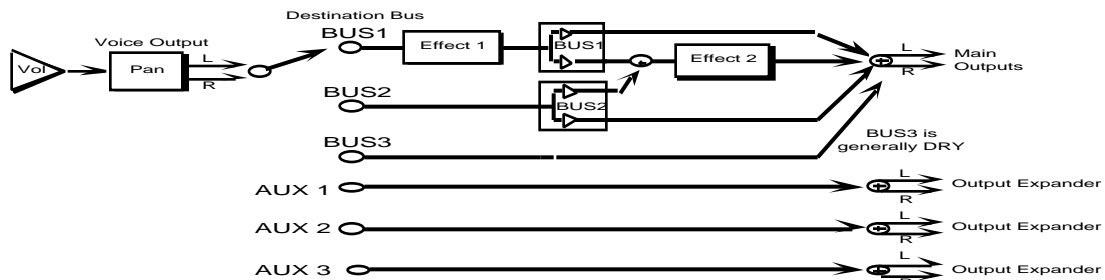

When the selected effect is a *combined effect* that has more than one signal processing function (such as chorus and reverb), the BUS 1 bus feeds Effect 1 and Effect 2, and the BUS2 bus feeds Effect 2 only. Within effects there may also be Dry/Wet mixes (such as the Chorus Mix within the CHORUS+REVERB effect).

## Triple Function Effect Mixer

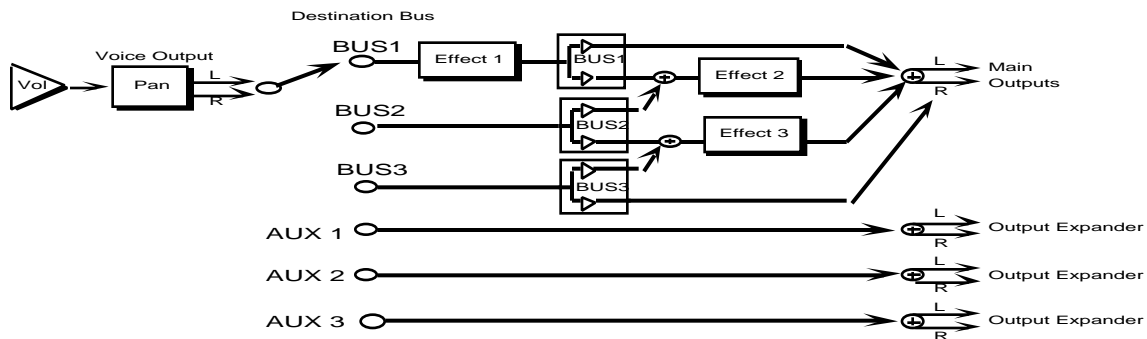

Some effects, such as DIST+CHO+REV, use the above mixing scheme. Effect 1 and Effect 2 usually have a Dry/Wet mix within them. This mixer can be configured as three independent effects, or three effects in a series.

## Performance Control of Tracks When Using Bank Effects

When using a Bank Effect, all the instruments in the internal memory are always routed through the same global effect. In order to gain some individual control for each instrument, two parameters on the Edit/Track page determine how each instrument will interact with the Bank Effect.

- **OUT** — This parameter determines which of the Busses the instrument will be sent through. The options are: WAVESAMPLE, BUS1, BUS2, BUS3, AUX1, AUX2, and AUX3. By using this parameter you can give individual instruments different Dry/Wet or multiple effect mixes. The WAVESAMPLE output bus is not available for Audio Tracks.
- **EFFECT MOD CONTROL** — This parameter determines whether the controllers of a particular instrument will be routed to control the effect. This is an important setting when using a Bank Effect: since all instruments are routed through the same effect, it could be confusing to have multiple instruments sending conflicting controller information to the effect.

### Predefined Effect Modulation Parameters

Several of the effects allow real-time control of a single predefined parameter within the effect, such as the Reverb Mix or Flanger Feedback. Each of these effects will have its own Modulator Select screen, where the modulator and mod amount are selected. Each Effect Variation can have a different assigned Modulation Source and Amount (for a total of four different modulatable parameters). This screen will look different from effect to effect, but it will always be the last screen on the Edit/Effect page. The screen has two parameters:

- **Mod Source** — This selects the source for modulating the defined parameter within the selected effect.
- **Mod Amount (Mix)** — This sets the amount the Mod Destination will be modulated by the Mod Source.

The following modulation sources can alter the effects in performance:

<u>Mod Source</u>	<u>Modulation effect derived from</u>
WHEEL	the value of the mod wheel
PBEND	the value of the pitch wheel (50% output at rest)
PRESS	the channel pressure value for the selected track
PEDAL	the value of the Pedal/CV input
XCTRL	uses the value of the assignable external MIDI controller, set on the Edit/System•MIDI page
KBD	the number of the last key played
VEL	average velocity of all keys played simultaneously
KEYDN	ON when any keys are held down, otherwise OFF
SUSTN	ON when sustain pedal is held down; otherwise OFF
FSW-L	uses the left foot switch of the optional SW-10 Foot Switch; ON when held down, otherwise OFF (Edit/System•MIDI LEFT FOOT SW must be set to FX MODSRC for this to function as an FX modulator)
PATCH	four discrete values, ranging from off (no patch select buttons held) to full ON (both patch selects held)
OFF	no modulation

## Selectable Effect Modulation Parameters

Most of the effects allow real-time control of selectable parameters and share common modulation control parameters. Within these effects, each Effect Variation can have two different Modulation Sources, Destination parameters, and defined modulation ranges (for a total of eight different modulatable parameters). The Modulation Control Parameters are always the last eight parameters on the Edit/Effect page:

- **MOD SRC 1 — Modulation Source 1**
- **MOD SRC 2 — Modulation Source 2**

Sources: WHEEL, PBEND, PRESS, PEDAL, XCTRL, KBD, VEL, KEYDN, SUSTN, FSW-L, PATCH, or OFF

These parameters select the modulation sources used to modulate the parameter Destinations. Each Effect Variation has a choice of two discrete mod sources.

- **DST 1 — Mod1 Destination Parameter**
- **DST 2 — Mod2 Destination Parameter**

Ranges: various (selected parameter name)

The Destination parameters select which effect parameters will be modulated by the modulation sources. The choice of parameters varies depending on the selected effect. Any parameter within an algorithm can be selected. Each Effect Variation has a choice of two different mod destinations.

**Tip:** Once the destination has been defined, you can toggle between the DST (Destination) parameters and the actual parameter that is selected to be modulated, by alternate presses of the **Enter•Yes** button. When the parameter being modulated is displayed, you can watch the actual value change as the mod source output changes. You cannot edit a parameter when it is assigned as a modulator destination. Disabling modulation of a parameter will restore its saved value.

- **MIN 1 — Mod 1 Param Range Minimum**
- **MAX1 — Mod 1 Param Range Maximum**
- **MIN 2 — Mod 2 Param Range Minimum**
- **MAX2 — Mod 2 Param Range Maximum**

Ranges: 0 to 99

These four parameters set the minimum and maximum amount (based on a percentage of the selected parameter's range) that the Mod Destination will be modulated by the Mod Source. Inverting the amounts will also invert the Mod effect.

### Remember

In order for the effect modulation to work, the EFFECT MOD CONTROL parameter on the Edit/Track page must be set to ON for the selected **Instrument•Sequence Track**.



# Section 6 — Effect Parameters

---

This section offers detailed descriptions of the commands and parameters used in selecting, creating, and editing effects. For a basic overview of the concepts involved, refer to the previous section.

## Command/Effects Page

The commands on this page allow you to copy and save effects.

<i>CMD</i>	<b>SAVE BANK EFFECT</b>
<i>EFFECTS</i>	Press Command / Effects / 0

This parameter is used to save the BANK effect to disk (or SCSI device) as a separate file that can be loaded at any time. Only the BANK effect can be saved directly to disk. Conversely, when you load an effect file from disk, it is always loaded into the BANK effect location. If you wish to save either a ROM effect or an INST (instrument) effect as a separate effects file, you must first copy the effect into the BANK effect (see below) and then save it.

- Select SAVE BANK EFFECT.
- Press **Enter•Yes**. The display shows the file name associated with the current BANK effect. You can rename the effect using the **Arrow** buttons and the **Data Entry Slider** if you wish.
- Press **Enter•Yes** to save the effect file to disk.

<i>CMD</i>	<b>COPY CURRENT EFFECT</b>
<i>EFFECTS</i>	Press Command / Effects / 1

This command is used to copy an effect either from the bank to an instrument, or the other way around. It can also be used to copy one of the ROM effects into an instrument or to the BANK effect. The effect that is copied (the source effect) is always the one currently selected on the FX Select•FX Bypass page.

- Select COPY CURRENT EFFECT.
- Press **Enter•Yes**. The display shows the DIRECTION parameter. Using the **Up/Down Arrow** buttons, select either COPY TO BANK to take the effect from the currently selected instrument and copy it into the BANK effect, or COPY TO INST to take the effect currently displayed on the FX Select•FX Bypass page and copy it to one of the instruments in the internal memory.
- Press **Enter•Yes**. If you've selected COPY TO BANK in the previous step, the display will briefly read COMMAND COMPLETED and the procedure will be done. However, if COPY TO INST was selected, use the **Instrument•Sequence Track** buttons to select which instrument you wish to copy the BANK effect into. Once the destination instrument has been selected, press **Enter•Yes**.

## Edit/Effects Page

Each of the effects has multiple screens containing a particular set of parameters associated with that effect. Press the **Edit** button, followed by the **Effects** button to access these parameters.

## Effect Variations

The first parameter screen is similar for all of the effects (the display shows VAR= ). It selects one of four Effect Variations, which feature various “preset” patches, letting you quickly access several set-ups within the same effect. Each of these four variations is individually editable and can act as four effect edit buffers. Each Effect Variation can have two different Modulation Sources, Destination parameters, and defined modulation ranges (for a total of eight different modulatable parameters). Subsequent screens are variable, and contain pertinent parameters that provide the flexibility for customizing the effects.

### ROM-01 HALL REVERB

### ROM-02 44KHZ REVERB

### ROM-03 ROOM REVERB

These effects algorithms provide studio-quality stereo reverb. The BUS1, BUS2, and BUS3 parameters can be routed into the effect with different Dry/Wet mixes. HALL REVERB is a reverb with a long decay, featuring left to right (transverse) reflections. 44KHZ REVERB is a hall reverb utilizing the 44KHZ system sample rate (polyphony is reduced to 23 voices). ROOM REVERB features a shorter, room-like decay.

The parameters available in these three effect algorithms are:

**DECAY TIME** Range: 0 to 99  
Controls the amount of time it takes for the reverberation to decay to a low level (-60 dB) after the input signal stops.

**LOW FREQ DECAY** Range: -99 to +99  
This control will boost or cut the rate at which low frequencies will decay.

**DIFFUSION**  
Range: 0 to 99  
This parameter determines whether the early reflections will appear as a series of discrete echoes (lower values) or will be more diffused (higher values).

**HI FREQ DAMPING** Range: 0 to 99  
This parameter controls the rate of attenuation of high frequencies in the decay of the reverberation. As natural reverb decays, some high frequencies tend to get absorbed by the environment. Increasing the value of this parameter will filter out increasing amounts of high frequency energy.

**HI FREQ BANDWIDTH** Range: 0 to 99  
The High Frequency Bandwidth parameter acts as a low pass filter on the signal going into the reverb, controlling the amount of high frequencies that will pass into the effect. The higher the setting, the more high frequencies are allowed to pass.

**DETUNE RATE** Range: 0 to 99  
This parameter controls the LFO rate of detuning incorporated within the reverb. Detuning creates a slight pitch shift into the reverberated signal, giving it a more natural sounding decay by breaking up resonant nodes.

**DETUNE AMT** Range: 0 to 99  
 This parameter controls the depth of the detuning, that is, how much the pitch will change. Low values yield a metallic sound. Some voices sound best with very low values.

**PRE-DELAY TIME** ROOM and HALL REVERB Range: 0 to 500  
 44KHZ REVERB Range: 0 to 340  
 This parameter creates a delay in the amount of time it takes before the original signal is fed into the reverb. The range is based in milliseconds.

## ROM-04 DUAL DELAYS

## ROM-05 44KHZ DELAYS

A professional quality stereo digital delay. DUAL DELAYS uses the standard 30KHZ (31 voice) system sample rate, while 44KHZ DELAYS utilizes the 44KHZ system sample rate (polyphony is reduced to 23 voices). Both algorithms have identical parameters. Both BUS1 and BUS2 can have different Mix, Feedback, and Delay Time settings. BUS3 is dry.

**BUS1 (and 2) DELAY MIX** Range: 0 to 99  
 This parameter controls the mix between the original signal and the delay. Setting this parameter to 0 will allow only the unprocessed signal to be heard, while a setting of 99 will eliminate it completely, with only the delay portion remaining.

**BUS1 (and 2) FEEDBACK** Range: 0 to 99  
 Determines the amount of signal that will be fed from the output of the right delay back into the input, increasing the number of repeats in the delay.

**BUS1 (and 2) DELAY TIME** Dual Delays Bus1 Range: 0 to 2000  
 44 KHZ Delays Bus1 Range: 0 to 1300  
 Bus2 Range: 0 to 150  
 Determines the amount of the amount of time between delays. Each value increases the delay time by 1 millisecond. The Left and Right channels are independently adjustable.

## ROM-06 CHORUS+REVRB

This effect combines a four-voice chorus with the standard reverb. Assign a voice to BUS1 to get both chorus and reverb, or use BUS2 for reverb only. Use BUS3 to bypass the effect (dry).

**BUS1 REV AFTER CHOR** Range: 0 to 99  
 This parameter determines how much of the signal that is sent to BUS 1 (the chorus) will also go to the reverb — it is a Reverb Mix for the chorused signal.

**BUS2 REVERB MIX** Range: 0 to 99  
 This parameter controls the Dry/Wet mix of the Reverb for voices sent to BUS2.

**REVERB DECAY TIME** **HI FREQ BANDWIDTH**  
**LOW FREQ DECAY** **REVERB DETUNE RATE**  
**DIFFUSION** **REVERB DETUNE AMT**  
**HI FREQ DAMPING**  
 See the descriptions under HALL REVERB.

- EARLY REFLECTION LEV** Range: 0 to 99  
Controls the level of pre-echoes of the input signal added directly to the reverb output.
- CHORUS RATE** Range: 0 to 99  
This parameter controls the four rates of modulation of the delay time of the chorus. The delay modulation produces vibrato and tremolo.
- CHORUS AMT** Range: 0 to 99  
This parameter controls the depth of vibrato and tremolo.
- CHORUS MIX** Range: 0 to 99  
This parameter controls the Dry/Wet mix within the chorus itself.
- CHORUS FEEDBACK** Range: -99 to +99  
This parameter controls the amount of feedback applied to the chorus. The sign of the value determines the polarity of the feedback. Feedback accentuates the complexity of the “swept” signal.

## **ROM-07 PHASER+REVRB**

A 12-pole phase shifter with reverb. Assign a sound to BUS1 for phaser plus reverb; to BUS2 for just reverb; and to BUS3 to bypass the effect (dry).

- BUS1 REVERB MIX** Range: 0 to 99  
This parameter controls the Dry/Wet mix of the Phaser into the Reverb.
- BUS2 REVERB MIX** Range: 0 to 99  
This parameter controls the Dry/Wet mix of the Reverb.
- REVERB DECAY TIME**                      **HI FREQ BANDWIDTH**  
**LOW FREQ DECAY**                      **REVERB DETUNE RATE**  
**DIFFUSION**                              **REVERB DETUNE AMT**  
**HI FREQ DAMPING**  
See the descriptions under HALL REVERB.
- EARLY REFLECTION LEV**  
See the description under Chorus+Reverb.
- PHASE CENTER** Range: 0 to 99  
This parameter controls the center of the phaser width.
- PHASE RATE** Range: 0 to 99  
This parameter controls the rate of modulation of the phaser poles.
- PHASE WIDTH** Range: 0 to 99  
This parameter controls the amount of modulation applied to phaser poles.
- PHASE FEEDBACK** Range: -99 to +99  
This parameter controls the amount of feedback applied to the phaser. The sign of the value determines the polarity of the feedback.

**PHASE DEPTH** Range: 0 to 99  
This parameter controls the depth of the notches created by the phasing.

## ROM-08 FLANGER+REV

The FLANGER+REV algorithm is similar to the Chorus+Reverb algorithm with a single LFO. Assign a voice to BUS1 to get the flanger plus reverb, and use BUS2 for reverb only. BUS3 is dry.

**BUS1 REVERB MIX** Range: 0 to 99  
This parameter controls the Dry/Wet mix of the Flanger into the Reverb.

**BUS2 REVERB MIX** Range: 0 to 99  
This parameter controls the Dry/Wet mix of the Reverb for signals sent to BUS2.

<b>REVERB DECAY TIME</b>	<b>HI FREQ BANDWIDTH</b>
<b>LOW FREQ DECAY</b>	<b>REVERB DETUNE RATE</b>
<b>DIFFUSION</b>	<b>REVERB DETUNE AMT</b>
<b>HI FREQ DAMPING</b>	

See the descriptions under HALL REVERB.

**EARLY REFLECTION LEV**  
See the description under Chorus+Reverb.

**FLANGE CENTER** Range: 0 to 99  
This parameter controls the center of the flanger width.

**FLANGE RATE** Range: 0 to 99  
This parameter controls the rate of modulation of the flanger effect.

**FLANGE WIDTH** Range: 0 to 99  
This parameter controls the range of the high to low frequency sweep in the flanger effect.

**FLANGE FEEDBACK** Range: -99 to +99  
This parameter controls the amount of feedback applied to the flanger. The sign of the value determines the polarity of the feedback.

**FLANGE DEPTH** Range: 0 to 99  
This parameter controls the depth of the notches created by the flanging effect.

## ROM-09 ROT. SPKR+REV

A rotating speaker simulation with reverb and distortion. Assign a voice to BUS1 to get both rotary speaker with distortion and reverb, and use BUS2 for reverb only. BUS3 is a dry bus (no effect). There are selections on the Variations screen for the Rotary Speaker without Distortion.

**BUS1 REV AFTER ROTO** Range: 0 to 99  
This parameter controls the Dry/Wet reverb mix of the Rotary Speaker.

**BUS2 REVERB MIX** Range: 0 to 99  
This parameter controls the Dry/Wet mix of the Reverb from signals sent to BUS2.

**REVERB DECAY TIME****DIFFUSION****HI FREQ DAMPING**

See the descriptions under Hall Reverb.

**ROTOR FAST**

Range: 0 to 99

Determines the rate of the rotary speaker when in the “Fast” setting. The higher the value, the faster the rate.

**ROTOR SLOW**

Range: 0 to 99

Determines the rate of the rotary speaker when in the “Slow” setting. ROTOR SLOW determines the manual level for the rotary speaker rate when FAST-SLOW SWITCH= OFF, or when the selected modulator is at zero output level. Again, the higher the value, the faster the rate.

**ROTOR INERTIA**

Range: 0 to 99

Determines how long it will take for the rotor effect to speed up and slow down after switching from fast to slow or vice versa. Adjust this parameter to simulate the effect of the rotary speaker gradually picking up speed.

**FAST-SLOW SWITCH**

Range: see below

Determines how the rotary speaker will switch between slow and fast speeds. The behavior of the switch accurately reflects an actual rotary speaker, taking time to speed up or slow down, based on the value of the ROTOR INERTIA parameter above. Any effect modulator can act as the FAST-SLOW SWITCH. How the modulators will switch the rotor speed fall into two categories:

- WHEEL, PBEND, PRESS(ure), PEDAL, XCTRL, KBD, and VEL — These modulation sources act like a switch to turn on or off the fast rotor speed. To reverse the polarity of the switch, set ROTOR SLOW faster than ROTOR FAST.
- KEYDN, SUSTN, FSW-L, PATCH — These modulation sources toggle the rotor speed between slow and fast. Every time the modulation source moves from zero in a positive direction, the rotating speaker effect changes speeds from slow to fast or fast to slow.

**DIST GAIN IN/OUT**

In and Out Range: 0 to 99

The IN parameter determines the input signal gain into the amplifier simulation, creating a tube-like overdrive.

The OUT parameter controls the *output* of the amplifier distortion. There is a (fixed) clean path in parallel with the distortion. Therefore, to eliminate distortion, set this parameter to zero.

**SPEAKER GAIN**

Range: 0 to 99

Controls the level of the signal (distorted or not) applied to the rotary speaker. High gain will simulate a broken speaker. Also use higher settings when using little or no distortion, because distortion raises the signal level to the speaker.

**DISTORTION FILTER**

Range: 0 to 99

A three-pole, low pass filter following the amplifier simulation. This parameter controls the filter cutoff resulting in a brighter sound (for higher values) or a darker sound (low values).

## ROM-10 CHOR+REV+DDL

Chorus with digital delay and reverb. Assign a voice to BUS1 for Chorus and Reverb, BUS2 for Reverb only, and BUS3 for Digital Delay (DDL).

**BUS1 REV AFTER CHOR**  
**BUS2 REVERB MIX**  
**REVERB DECAY TIME**  
**LOW FREQ DECAY**  
**HI FREQ DAMPING**

**REVERB DETUNE RATE/AMT**  
**CHORUS RATE/AMT**  
**CHORUS MIX**  
**CHORUS FEEDBACK**

See the descriptions under Chorus+Reverb.

**BUS3 DDL MIX**

Range: 0 to 99

The BUS3 DDL Mix determines the Dry/Wet mix of the Digital Delay.

**DDL TIME L/R**

Range: 0 to 1500

This parameter determines the delay time for the left and right channels independently. It is adjustable from 0 to 1500 in 1 millisecond increments.

**DDL FEEDBACK**

Range: 0 to 99

The DDL Feedback parameter controls the amount of feedback applied to the Digital Delay.

## ROM-11 CMP+DIST+REV

A screaming guitar-and-amp simulator that features not only compression, distortion, and reverb, but flanging and EQ as well. BUS1 routes the signal through each of these effect processors, while BUS2 is used for reverb only. BUS3 is dry.

### CMP+DIST+REV Signal Routing

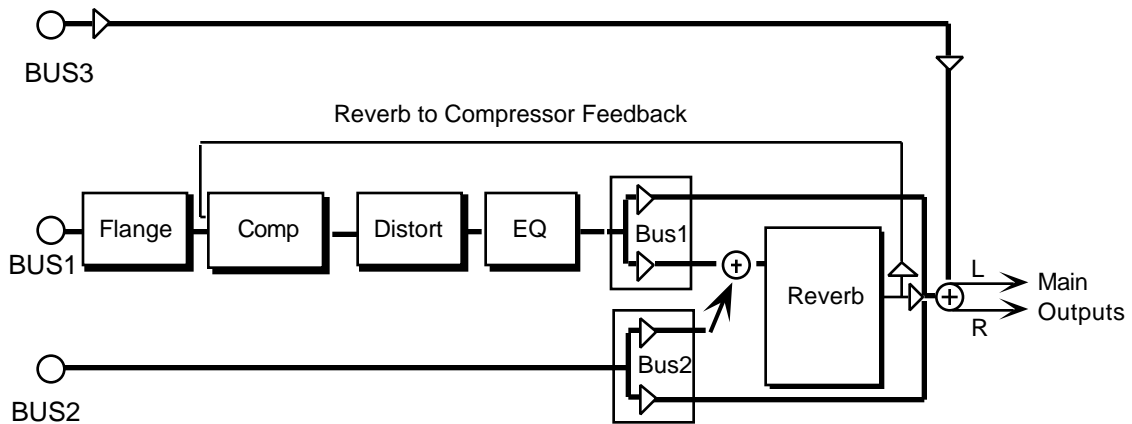

**BUS1 REV AFTER DIST**

Range: 0 to 99

This parameter controls the Dry/Wet mix of the Distortion.

**BUS2 REVERB MIX**

**HI FREQ DAMPING**

**REVERB DECAY TIME**

See the descriptions under HALL REVERB.

**COMPRESSOR THRESHLD**

Range: 0 to 99

This parameter controls the threshold level for the compressor. As the input signal dies away below the threshold, the compressor will increase the gain of the system, causing feedback to increase as well. Normal compression is “72.”

**DIST GAIN IN and OUT**

Ranges: 0 to 99

These two parameters control the levels going into and coming out of the distortion effect. For more distortion, use a high input level and turn the output level down to keep the volume under control. For less distortion, use a low input level and a higher output level.

**DIST LPF/HPF**

Range: 0 to 99

The DIST LPF parameter filters out high frequencies after the distortion signal path. The lower the value, the less high frequencies pass through. The DIST HPF parameter filters out low frequencies after the distortion signal path. The higher the value, the less low frequencies pass through.

**DIST FLANGE RATE**

Range: 0 to 99

This parameter controls the rate of modulation of the notches due to the flanger effect. A setting of 0 effectively turns the flanger off.

**SYSTEM FEEDBACK**

Range: -99 to +99

This parameter controls the amount of signal applied from the output of the reverb back into the input of the compressor. The sign of the value determines the polarity of the feedback.

**Note:** Since the feedback level is taken from BUS1, if BUS1 is set to +0 or a low value, feedback will have little or no consequence. Also, it is important to note that since the signal is being taken from the reverb, that is also fed by BUS2, voices sent to BUS2 will enter the feedback loop along with the BUS1 signals.

## ROM-12 DIST+CHO+REV

A brighter guitar-and-amp simulator that features distortion, chorus, and reverb, but without the compressor. The three effects can be run in a serial or parallel configuration, depending on how the three BUS parameters are set. This effect uses the triple function effect mixing scheme.

**BUS1 DIST INTO CHOR MIX**

Range: 0 to 99

This parameter determines how much of the output from the distortion bus will be fed into Bus2 for added chorusing. Setting this parameter to 0 will cause the output from the distortion bus to go directly to the main outputs.

**CHOR INTO REV MIX**

Range: 0 to 99

This parameter determines how much of the output from the chorus bus will be fed into Bus3 for added reverb. Setting this parameter to 0 will cause the output from the chorus bus to go directly to the main outputs.

**BUS3 REVERB MIX**

Range: 0 to 99

Sets the Dry/Wet mix of the reverb.

**DIST GAIN IN and OUT**

Ranges: 0 to 99

See the description under CMP+DIST+REV.

**DIST FILTER FC**

Range: 0 to 99

This determines the filter cutoff frequency (brightness) of the distortion.

**DIST FILTER Q**

Range: 1 to 25

This parameter determines the level of the resonant peak at the filter cutoff point. While the FILTER FC parameter determines where (at what frequency) this peak will occur, the Q setting controls the presence of the peak.



**DISTORTION MIX** Range: 0 to 99  
Determines the Dry/Wet, or in this case, dirty/clean mix of the signal. A value of 0 yields a clean signal; 99 yields an all distortion signal.

**REVERB DECAY TIME** **HI FREQ BANDWIDTH**  
**LOW FREQ DECAY** **REVERB DETUNE RATE/AMT**  
**HI FREQ DAMPING**

See the descriptions under HALL REVERB.

**EARLY REFLECTION LEV** **CHORUS MIX**  
**CHORUS RATE/AMT**

See the descriptions under CHORUS+REVERB.

## ROM-13 WAH+DIST+REV

A guitar and amp simulator, featuring distortion, compression, reverb, and a resonant filter following the amplitude of the signal. Assign a sound to BUS1 for Wah distortion and reverb; use BUS2 for reverb only. BUS3 is dry.

**BUS1 REV AFTER DIST** Range: 0 to 99  
This parameter controls the Dry/Wet mix of the Distortion.

**BUS2 REVERB MIX** **REVERB DAMPING**  
**REVERB DECAY TIME**  
See the descriptions under HALL REVERB.

**COMPRESSOR THRESHLD** **DIST GAIN IN and OUT**  
See the descriptions under CMP+DIST+REV.

**WAH FILTER CENTER** Range: 0 to 99  
Determines where the resonant peak of the wah will occur. Higher values create a higher pitched wah.

**WAH RANGE** Range: -99 to +99  
Controls how much depth the wah will have. This is analogous to how far you move a wah-wah pedal back and forth.

**SYSTEM FEEDBACK**  
See the descriptions under CMP+DIST+REV.

**ROM-14 SMALL ROOM****ROM-15 LARGE ROOM****ROM-16 HALL REVERB2**

These three algorithms offer a studio quality reverb that can be controlled with a high degree of precision. The BUS1 and BUS2 parameters can be routed into the effect with different Dry/Wet mixes. BUS3 is a dry path. SMALL ROOM provides ambience; LARGE ROOM provides a larger ambience, and HALL REVERB2 is a large acoustic space providing a high density reverb.

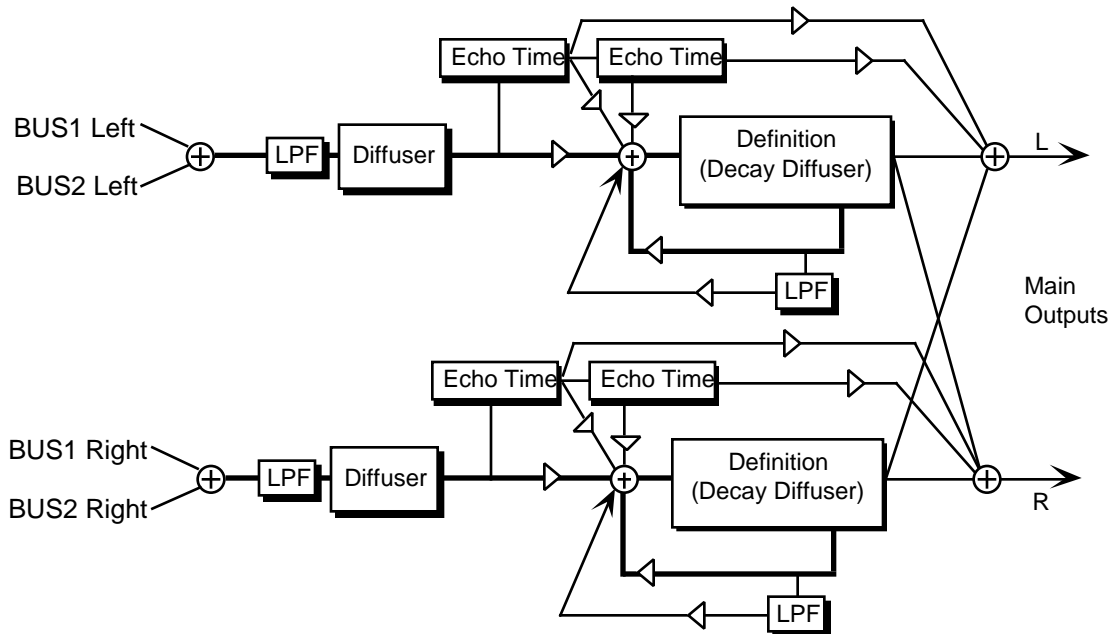
**SMALL ROOM, LARGE ROOM, HALL REVERB2 Signal Routing**

These three reverb algorithms share essentially the same signal routing topology. The signal enters a low pass filter and goes directly through the diffusers which smear the signal. The signal is then routed to a larger decay diffuser, known as Definition, and is diffused over a period of time (creating a decay). There are taps from both the left and right Definition that are routed to the output to create a synthesized stereo output. A signal from the Definition goes through a low pass filter followed by a low frequency decay parameter, which controls the rate of decay of the low frequencies. There is also a parameter at this stage that controls the decay time of both the left and right signals. The left and right signals are routed back into the Definition. There are two echo times between the diffuser and the definition that can be routed directly to the output, or sent back through the definition. The BUS1 and BUS2 MIX parameters allow you to create a Dry/Wet mix. BUS3 (not shown) is a dry signal.

The parameters available for these three algorithms are:

**DECAY TIME**

Small Room Range: 0.20 to 100.0 sec.

Large Room Range: 0.20 to 150.0 sec.

Hall Reverb2 Range: 0.70 to 250.0 sec.

Controls the amount of time it takes for the reverberation to decay away to a very low level after the input signal stops. In the room reverbs we don't recommend higher settings, which tend to create an infinite and unnatural sustain. Since most rooms don't naturally have a large decay, set this low for the best sound. However, higher values are recommended for the hall reverb.

- PREDELAY TIME** Range: 0 to 450 ms  
Controls the amount of time it takes for the original signal to be presented to the reverb. Higher values denote a longer delay.
- LF DECAY TIME** Range: -99 to +99  
This parameter acts like a tone control and will boost (positive values) or cut (negative values) the rate at which low frequencies will decay.
- HF DAMPING** Range: 0 to 99  
This parameter controls the rate of attenuation of high frequencies in the decay of the reverberation. As natural reverb decays, some high frequencies tend to get absorbed by the environment. Increasing the value of this parameter will gradually filter out (dampen) more and more high frequency energy.
- HF BANDWIDTH** Range: 1 to 99  
The high frequency bandwidth acts as a low pass filter on the signal going into the reverb, controlling the amount of high frequencies that will pass into the effect. The higher the setting, the more high frequencies are allowed to pass. This functions like a tone control on a guitar.
- DIFFUS1** Range: 0 to 99  
This parameter smears the input signal transients, to *diffuse* and smooth the sound. Lower values will cause impulse sounds to appear as a series of discrete echoes, while higher values tend to increase the smear (smoother sounding with fewer discrete echoes). We recommend settings of 50 for starters.
- DIFFUS2** Range: 0 to 99  
This parameter, similar to and in series with Room Diffusion1, performs the same way but controls lower frequency ranges. Experiment with different levels between the diffuser parameters to find the settings that are right for your source.
- DECAY DEFINITION** Range: 0 to 99  
This parameter controls the rate at which echo density is increased with time. Setting this parameter too high can cause the echo density to build at a rate which exceeds the decay rate. A general rule of thumb: DECAY DEFINITION should not exceed the LF DECAY TIME added to the DECAY TIME.
- DETUNE RATE** Range: 0 to 99  
This parameter controls the LFO rate of detuning introduced into the reverberation decay. Detuning creates a slight oscillating pitch shift into the decay, giving it a more natural sound by breaking up resonant modes.
- DETUNE DEPTH** Range: 0 to 99  
This parameter controls the depth of the detuning, that is, how much the pitch will change. Low values yield a metallic sound. Some sounds may require very low values, while others sound more natural with higher values.
- PRIMARY SEND LEVEL** Range: -99 to +99  
This parameter controls the level of the diffused input signal into the reverb definition.
- REFL 1 TIME** Range: 0 to 120 milliseconds  
This parameter controls the delay time for the first pre-echo. Pre-echoes are the first sounds that have been reflected back from the walls or reflective “live” surfaces. Higher values delay the diffused signal more.

**REFL 1 LEVEL** Range: 0 to 99  
This parameter controls the level of the first pre-echo. This pre-level controls the echo send to the Definition.

**REFL 1 SEND** Range: 0 to 99  
This parameter controls the level of the first pre-echo, with the echo routed directly to the output.

**REFL 2 TIME** Range: 0 to 120 milliseconds  
This parameter controls the delay time for the second pre-echo.

**REFL 2 LEVEL** Range: 0 to 99  
This parameter controls the level of the second pre-echo. As a signal continues to bounce off the different reflective surfaces (walls), it decreases in volume. This parameter should not be set too high, to create a natural sounding echo.

**REF 2 SEND** Range: 0 to 99  
This parameter controls the level of the second pre-echo, with the echo routed directly to the output.

**POSITN BAL (1 to 3)** Ranges: -99 to +99  
The Position Balance parameters simulate the depth of the room/hall. Think of these parameters as three different microphones placed at various distances within the room/hall (the first is closest to the front, the third is farthest from the front). When the range (volume) is higher for POSITN BAL (1), the sound appears closer to the front, whereas a higher setting for POSITN BAL (3) appears farther from the front, suggesting a deeper (wetter) room/hall.

<b>MOD SRC 1</b>	<b>MOD SRC 2</b>
<b>DST 1</b>	<b>DST 2</b>
<b>MIN 1</b>	<b>MIN 2</b>
<b>MAX 1</b>	<b>MAX 2</b>

These modulation parameters are explained in detail in *Section 5 — Effect Concepts*.

## ROM-17 SMALL PLATE

## ROM-18 LARGE PLATE

A plate reverb takes the vibrations from a metal plate and uses them to create a metallic sounding reverb. **SMALL PLATE** is a tight sounding plate reverb, and **LARGE PLATE** simulates a larger plate reverb. Small plate reverbs are most often used in the studio for drums and percussion, while large plate reverbs are often used to enhance a vocalist's performance.

### Small Plate, Large Plate Reverb Signal Routing

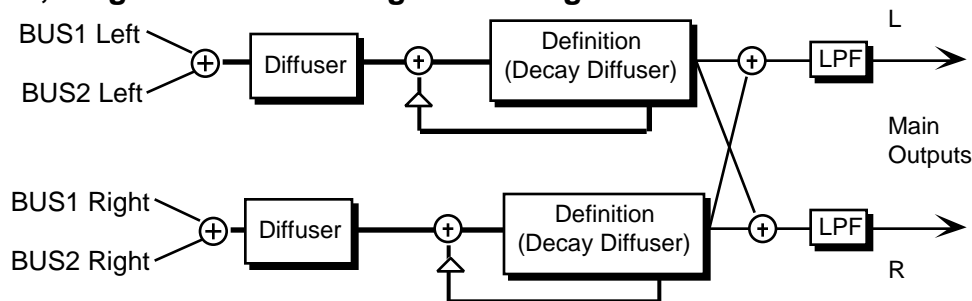

The two plate reverb algorithms share exactly the same signal routing topology. The internal

values of the components (not user programmable) differentiate the large and small plate reverbs. The signal goes directly through the diffusers which smear the signal. The signal is then routed to a larger diffuser, known as Decay Definition, and is diffused over a period of time (creating a decay). The signal is then routed to the output, and then goes through a low pass filter. There is a parameter that controls the Decay Time of both the left and right signals (shown as triangles above). This signal is then routed back into the definition. There is also an external dry signal (not shown) that goes directly from the input to the output (BUS3). The BUS1 and BUS2 MIX parameters can be routed into the effect for different Dry/Wet mixes.

The user-controllable parameters for the plate reverbs algorithms are:

**DECAY TIME**

Small Plate Range: 0.2 to 100.0 sec.

Large Plate Range: 0.4 to 140.0 sec.

This parameter controls the amount of time it takes for the reverberation to decay. Percussion sounds best using SMALL PLATE. High values of decay time sound good on these algorithms.

**PREDELAY TIME**

Small Plate Range: 0 to 500 ms

Large Plate Range: 0 to 430 ms

This parameter controls the amount of time it takes for the input signal to be presented to the plate reverb. A value of 0 would offer no delay.

**HF DAMPING**

Range: 0 to 99

Increasing the value of this parameter will gradually filter out increasing amounts of high-frequency energy. Higher values yield an abrupt decay. This parameter controls the cut off of a low pass filter in series with the decay within the definition.

**HF BANDWIDTH**

Range: 1 to 99

This parameter acts as a low-pass filter on the output of the plate reverbs, controlling the amount of high frequencies present. The higher the setting, the more high frequencies are allowed to pass through, offering a brighter ringing sound. Some interesting effects can be created by using a mod controller over a large range.

**DIFFUS1**

Range: 0 to 99

The DIFFUS1 parameter smears the input signal to create a smoother sound. Lower values will cause impulse sounds to appear as a series of discrete echoes, while higher values tend to increase the smear, making the echoes less apparent.

**DIFFUS2**

Range: 0 to 99

This Diffuser, similar to and in series with the previous one, offers control over lower frequency ranges. Plate Reverbs tend to sound metallic, and the diffusers help to smear the signal, eliminating the metallic sound.

**DECAY DEFINITION**

Range: 0 to 99

This parameter controls the rate at which echo density increases with time. Higher values can cause the echo density to build at a rate that exceeds the decay rate. Try to select the highest value that works with your sound source for the best performance.

**ER LEV (1 to 4)**

Ranges: -99 to +99

These parameters control four early reflection levels. Setting these levels to lower values will produce a wetter sound. These four reflection levels are close to the input of the DECAY DEFINITION.

**L/R BALANCE**

Range: -99 to +99

This parameter controls the left/right stereo balance of the plate reverb signal. A setting of -99 would offer hard left, whereas a setting of +99 would offer hard right. A setting of +0 would place the reverb in the center of the stereo spectrum.

**MOD SRC 1****MOD SRC 2****DST 1****DST 2****MIN 1****MIN 2****MAX 1****MAX 2**

These parameters are explained in detail in *Section 5 — Effect Concepts*.

**ROM-19 REVRSE REVRB**

REVRSE REVRB produces a reverberation that gradually increases, simulating a backwards sound with a maximum duration of several seconds. When a signal enters this algorithm, the plate reverb (from which this algorithm is derived) is almost instantaneously turned on, and then the output volume is ramped up. This algorithm will only trigger one time. REVERSE REVERB is triggered by an input signal level (THRESHOLD) determined by the user. Once triggered, the reverse envelope will proceed to completion, and ignore subsequent trigger levels. If you are looking for a reverse effect that will retrigger, try using REVRSE REVB 2. The topology of the Reverse Reverb is similar to the Plate Reverb. The BUS1 and BUS2 MIX parameters offer different dry/wet mixes.

The parameters available for this algorithm are:

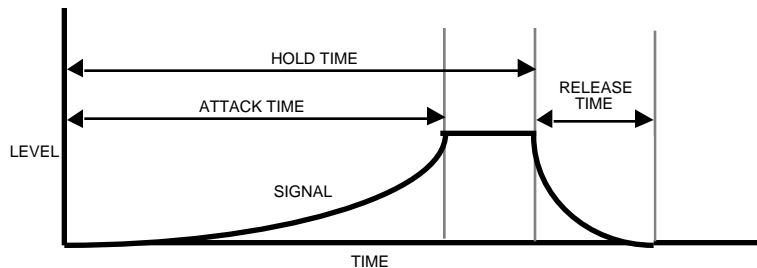
**HOLD TIME**

Range: 1ms to 10.0s

This parameter controls the amount of time that the reverse envelope will sound after it has been triggered. Rule of thumb: don't set the HOLD TIME much longer than the ATTACK TIME.

**ATTACK TIME**

Range: 1ms to 10.0s

This parameter sets the duration over which the reverb builds. It is recommended that you set this value less than the HOLD TIME.

**RELEASE TIME**

Range: 1ms to 10.0s

This parameter determines the release time after the HOLD TIME has elapsed. Generally this time is very short. Lower values offer an abrupt cutoff.

**TRIGGER THRESHOLD**

Range: -96 to +0 dB

Set this parameter as low as possible to work with your particular sound source. To eliminate false triggering, it should not be set too low. When the input signal rises above this threshold, the reverse envelope will begin.

- HF DAMPING** Range: 0 to 99  
This parameter sounds best when set to low values. It has the same function as in the Plate Reverb, which is to filter out more and more high frequency energy. For the most natural sounding reverse effect, we recommend a setting of 0.
- DIFFUS1** Range: 0 to 99  
DIFFUS1 smears the input signal making a smoother sounding reverb. This parameter controls the high frequency ranges. For percussion sounds, high values are recommended.
- DIFFUS2** Range: 0 to 99  
Similar to and in series with DIFFUS1, this parameter controls lower frequency ranges.
- DECAY DEFINITION** Range: 0 to 99  
The DECAY DEFINITION controls the rate at which echo density is increased with time. If set too high, the echo density will build at a rate that exceeds the decay rate. This can be used for a special effect.
- SLAPBACK TIME** Range: 0 to 530ms  
This parameter controls the delay time of an internal dry signal to create a slapback. This effect helps to simulate a backwards reverb, since now the dry signal appears at the end. In general we recommend the BUS Mixes be set all wet (99) for this effect. Rule of thumb: Set this parameter at about the same value as the HOLD TIME.
- SLAPBACK LEVEL** Range: 0 to 99  
This parameter adjusts the volume of the slapback (internal dry) signal. A value of 0 would eliminate audible slapback.
- |                  |                  |
|------------------|------------------|
| <b>MOD SRC 1</b> | <b>MOD SRC 2</b> |
| <b>DST 1</b>     | <b>DST 2</b>     |
| <b>MIN 1</b>     | <b>MIN 2</b>     |
| <b>MAX 1</b>     | <b>MAX 2</b>     |
- These parameters are explained in detail in *Section 5 — Effect Concepts*.

## ROM-20 REVRSE REVB2

REVRSE REVB2 is identical to REVRSE REVRB, except this algorithm will retrigger by an assigned input signal level (threshold) determined by the user. Once triggered, the reverse envelope will proceed to completion, unless retriggered by subsequent input signals. If you are looking for a reverse effect that will not retrigger, try using the previous reverse reverb algorithm. The BUS1 and BUS2 MIX parameters are used to select different Dry/Wet mixes.

The parameters available for this algorithm are:

- HOLD TIME** Range: 1ms to 10.0s  
This parameter controls the amount of time that the reverse will sound after it has been triggered. Rule of thumb: Don't set the HOLD TIME much longer than the ATTACK TIME.
- ATTACK TIME** Range: 1ms to 10.0s  
This parameter sets the duration over which the reverb builds. It is recommended that you set this value less than the HOLD TIME.

**RELEASE TIME** Range: 1ms to 10.0s  
 This parameter determines the RELEASE TIME after the HOLD TIME has elapsed. Generally this time is very short. Lower values offer an abrupt cutoff.

**TRIGGER THRESHOLD** Range: -96 to +0 dB  
 Set this parameter as low as possible to work with your particular sound source. To eliminate false triggering, it should not be set too low. When the input signal rises above this threshold, the reverse envelope will begin.

**PRE-TRIGGER TIME** Range: 0 to 530 ms  
 This parameter is used to capture transients that occur before the trigger. This parameter is critical to the sound quality. The user determines how much pretrigger sound will be injected into the reverse reverb tank.

**HF DAMPING** Range: 0 to 99  
 This parameter sounds best when set to low values. Its function is to filter out more and more high frequency energy. For the most natural sounding reverse effect, we recommend a setting of 0.

**DIFFUS1** Range: 0 to 99  
 DIFFUS1 smears the input signal making a smoother sounding reverb. This parameter controls the high frequency ranges. For percussion sounds, high values are recommended.

**DIFFUS2** Range: 0 to 99  
 Similar to and in series with DIFFUS1, this parameter controls lower frequency ranges.

**DECAY DEFINITION** Range: 0 to 99  
 DECAY DEFINITION controls the rate at which echo density is increased with time. If set too high, the echo density will build at a rate that exceeds the decay rate. This can be used for a special effect.

**MOD SRC 1**  
**DST 1**  
**MIN 1**  
**MAX 1**

**MOD SRC 2**  
**DST 2**  
**MIN 2**  
**MAX 2**

These parameters are explained in detail in *Section 5 — Effect Concepts*.

## ROM-21 GATED REVERB

GATED REVERB provides an excellent gated reverb. When a reverb is muted part way through, it creates a gated sound. To achieve this gated effect, both the Gated and Reverse reverbs must gate a number of internal parameters, not just the output amplitude envelope. It is however, the output amplitude over which the user has control. The ASR-10 offers a highly controllable gated reverb, optimized for percussive instruments, but useful for any input signal. The gate is first opened when the input signal passes the trigger threshold. This trigger threshold is set as low as possible by the user, so that none of the input signal is missed. The gated reverb is distinguished from the reverse reverb by retriggering whenever the input signal passes a retrigger (user programmable) threshold (see diagrams). The gate will stay open as long as the input signal remains above the retrigger threshold, and all the input signals will be accumulated under this gate until the total input signal level falls below the retrigger threshold. When this happens, the Hold Time will begin (as shown in the diagram below). The reason there are two thresholds is to eliminate false retriggering and to ensure precise hold time durations. If you desire a separate gate on each note, use the Non Lin reverbs. The topology for the Gated Reverb is derived from the Plate Reverb. The



BUS1 and BUS2 parameters can be routed into the effect with different Dry/Wet mixes.

### Gated Reverb with a High Retrigger Threshold

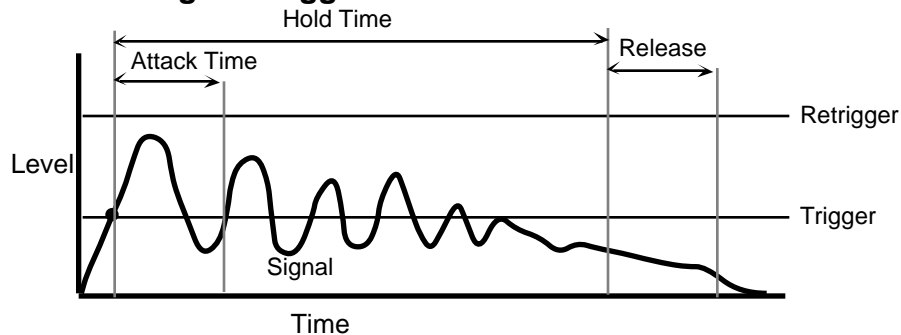

### Gated Reverb with a Low Retrigger Threshold

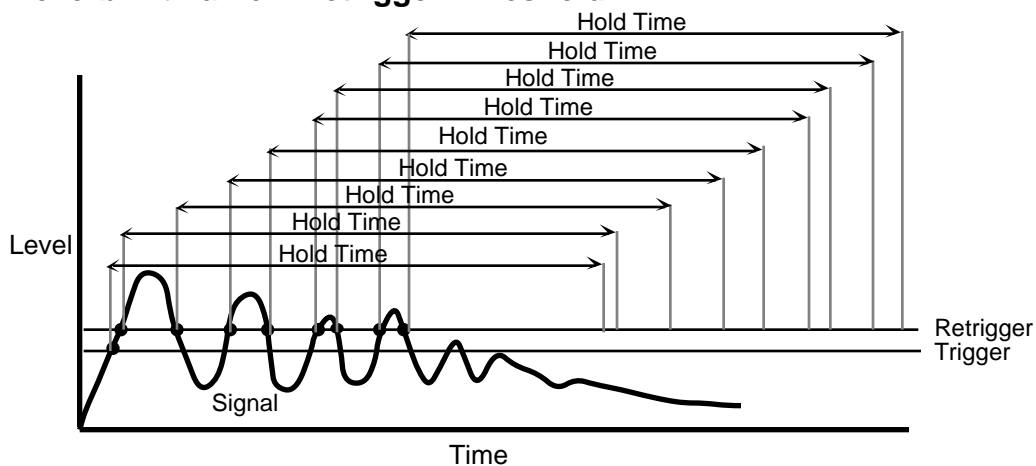

The parameters available for the Gated Reverb algorithm are:

#### ATTACK TIME

Range: 1ms to 10.0s

This parameter sets the ATTACK TIME of the gated reverb once the incoming signal has reached the trigger level. Generally the attack should be short and not set longer than the HOLD TIME. This parameter should not be used to achieve a reverse reverb envelope, because here the attack volume increases whereas in the Reverse Reverb the attack volume accelerates.

#### HOLD TIME

Range: 1ms to 10.0s

This parameter sets the amount of time that the reverb will hold after the retrigger and before the release. The HOLD TIME will begin again if retriggered.

#### DECAY TIME

Range: 0.2 to 100.0 sec.

This parameter controls the amount of time it takes for the reverberation to decay.

#### RELEASE TIME

Range: 1ms to 10.0s

This parameter sets the amount of time after the HOLD TIME has elapsed for the gated reverb to shut down. Generally these times are very short.



**ROM-22 NLIN REVRB 1****ROM-23 NLIN REVRB 2****ROM-24 NLIN REVRB 3**

Non Lin Reverbs can be used to obtain blooming reverb, gated reverb, reverse reverb and early reflections. In general, they do not produce an exponentially decaying reverb. Unlike the Hall, Room and Plate reverbs, NLIN REVRB 1, 2, and 3 pass the input signal through the reverb diffusers only once. For this reason the reverb diffusers are called *Density*, to distinguish them from the other reverb diffusers (called Definition). Density controls the *amount* of echo density, as opposed to the rate of increase of echo density. Other reverbs give limited control of early reflections. The Non Lin reverbs purposely impose a coloration on the resulting sound. The BUS1 and BUS2 parameters can be routed into the effect with different Dry/Wet mixes.

- NLIN REVRB 1 is optimized for shorter duration effects (approx. 0.5 sec.)
- NLIN REVRB 2 offers approx. a 1.5 sec. duration
- NLIN REVRB 3 is sonically similar to NLIN REVRB 1, but there is less stereo movement, making it better suited for drum tracks

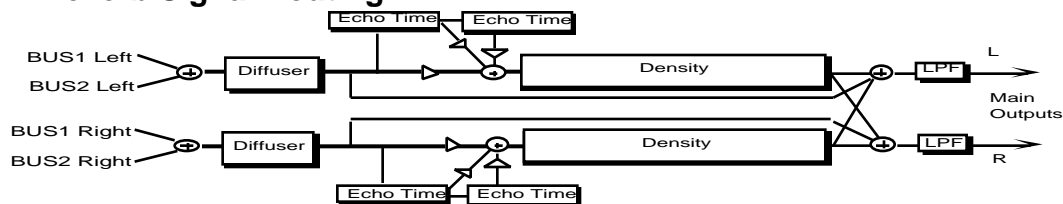
**Non Lin Reverb Signal Routing**

The signal goes directly through a diffuser which smears the signal. The signal is then routed to a decay diffuser, known as Density, and is diffused over a period of time. Within the density the signal goes through a high-frequency damper. The signal is then routed to the output. After the density, the signal passes through a low pass filter. There are two echo times between the diffuser and the density. There is also an external dry signal (not shown) that goes directly from the input to the output (BUS3). The BUS1 and BUS2 MIX parameters can be routed into the effect with different Dry/Wet mixes.

The parameters available for the Non Lin Reverbs are:

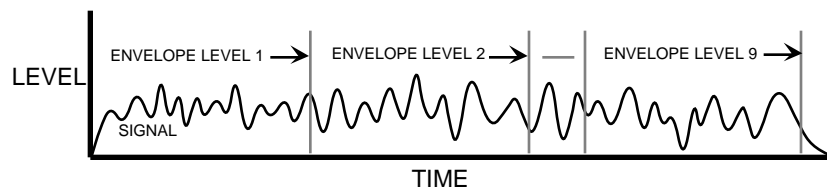
**ENV LEV (1 to 9)**

Ranges: 0 to 99

These parameters control the output tap levels sequenced in time across the density from input to output. Envelope Level 1 is tapped right after the diffusers and before the echoes (see the diagram). If this is undesirable, set ENV LEV1 to 0. Envelope Levels 8 and 9 are positioned at the very end of the Density; setting these too high can cause excessive ringing. Envelope Levels 8 and 9 are also very dry. Set all nine tap levels to find the envelope for your application. We recommend the average Envelope Level not to exceed a value of 45 to prevent overdriving these reverbs.

**HF DAMPING**

Range: 0 to 99

HF DAMPING is located within the density. This parameter selects the amount of high



**ROM-25 MULTITAP DDL**

MULTITAP DDL produces four independent controllable delays. The BUS1, BUS2, and BUS3 MIX parameters can be routed into the effect with different dry/wet mixes. This algorithm sounds best with a mix of wet and dry.

**DLY 1 TIME**

Range: 0 to 2186 ms

This parameter sets the amount of delay time for the independent delays. Experiment with different settings to find the right mix for your sound source and application. Some interesting effects can be implemented by using a real time modulation controller for these parameters.

**DLY 1 RGN**

Range: 0 to 99

This parameter determines the amount of signal that will be fed from the output back into the input, increasing the number of repeats in the delays. A setting of 99 would offer an infinite delay.

**DLY 1 LEVEL**

Range: 0 to 99

This parameter adjusts the volume of the delayed signals against the original dry signal. A level of 0 will offer no audible delay.

**DLY 1 PAN**

Range: -99 to +99

This parameter determines the location of the delays in the stereo spectrum. A value of -99 is panned far left, and +99 is far right.

**DLY 2 TIME****DLY 3 TIME****DLY 4 TIME****DLY 2 RGN****DLY 3 RGN****DLY 4 RGN****DLY 2 LEVEL****DLY 3 LEVEL****DLY 4 LEVEL****DLY 2 PAN****DLY 3 PAN****DLY 4 PAN**

Each of the four discrete delays has identical parameters and ranges as described above.

**REGEN DAMPING**

Ranges: 0 to 99

This parameter controls the cutoff of a low pass filter on the feedback signal, which adjusts the amount of damping to the feedback signals. The higher the number, the more the signals are dampened.

**MOD SRC 1****MOD SRC 2****DST 1****DST 2****MIN 1****MIN 2****MAX 1****MAX 2**

These parameters are explained in detail in *Section 5 — Effect Concepts*.

**ROM-26 EQ + DELAY LFO**

EQ + DELAY LFO features a stereo digital delay that provides LFO modulation of a wide range of delays. This algorithm sounds great with an electric piano, but try it with any source!

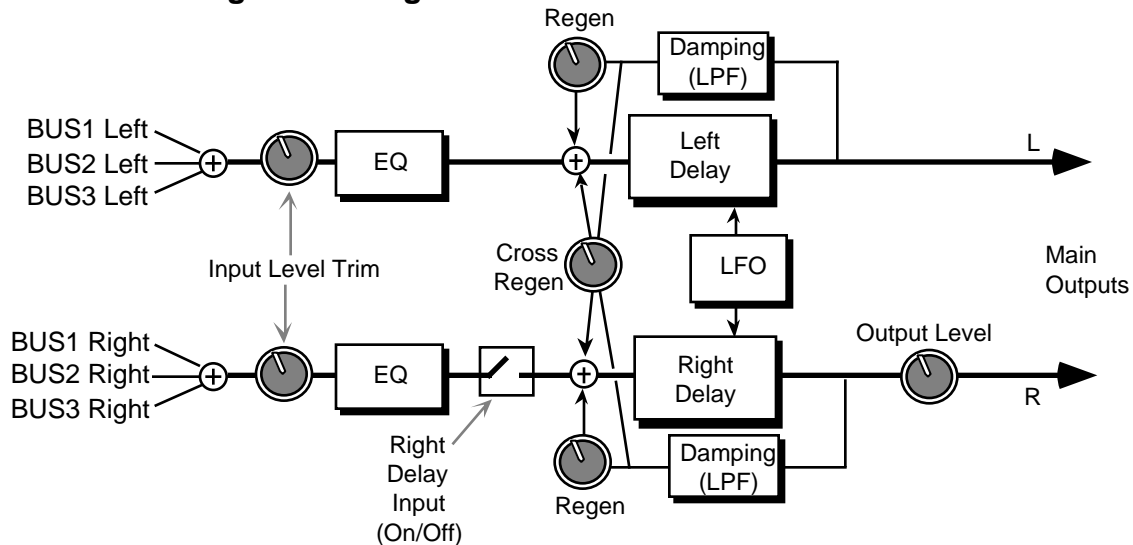
**EQ+DELAY LFO Signal Routing**

The BUS1, BUS2, and BUS3 MIX parameters can be routed into the effect with different Dry/Wet mixes.

The parameters available for this algorithm are:

- DLY TIME L** Range: 0 to 845 ms  
This parameter determines the amount of time between the input signal and the left delay output.
- DLY TIME R** Range: 0 to 845 ms  
This parameter determines the amount of time between the input signal and the right delay output. Set this differently from the left delay time to achieve dotted 1/8th note type effects.
- LFO RATE** Range: 0 to 99  
This parameter controls the rate of pitch modulation which is the LFO. To achieve a chorusing effect, this rate must be very slow.
- LFO WIDTH** Range: 0 to 99  
This parameter controls the excursion of pitch modulation. Since the rate is usually very slow, then the width is usually large.
- L/R LFO** Range: OUT-OF-PHASE or IN-PHASE  
When this parameter is IN-PHASE, the left and right choruses will modulate their detunes together. When set to OUT-OF-PHASE, the detune on the left channel will go up while the detune on the right will go down.
- DELAY REGEN** Range: -99 to +99  
This parameter controls the amount of regen (regeneration) applied to the delay time taps. The sign of the value determines the polarity of the regen.

**DLY CROSS REGEN**

Range: -99 to +99

This parameter allows you to feedback the delayed signals to their opposite sides; the left voice crosses to the right voice, and the right voice crosses to the left voice. A setting of +99 or -99 will cause infinite delay. Be careful, if the delay regen is set too high, it may cause this parameter to “blow up.”

**REGEN DAMPING**

Range: 0 to 99

This parameter adjusts the cutoff of a low pass filter on the feedback signal, which controls the amount of damping to the feedback signals. The higher the number, the more the signals are damped.

**R DELAY INPUT**

Range: OFF or ON

This parameter disables the input into the right side delay line. The right delay line will still get input from the DDL CROSS REGEN. This allows a ping-pong delay effect.

**R OUTPUT LEVEL**

Range: 0 to 99

This parameter controls the right output signal level.

**BASS FC**

Range: 0 to 1000 Hz

This parameter sets the cutoff frequency of the lower frequency band shelving filter.

**GAIN**

Range: -48 to +24 dB

This parameter sets the amount of boost or cut applied to the low shelving filter.

**TREBLE FC**

Range: 1KHz to 15KHz

This parameter sets the cutoff frequency of the high shelving filter.

**GAIN**

Range: -48 to +24 dB

This parameter sets the amount of boost or cut applied to the high shelving filter.

**EQ TRIM**

Range: -24 to +0 dB

This parameter allows you to adjust the input volume of the EQs to eliminate the possibility of clipping boosted signals.

**MOD SRC 1****MOD SRC 2****DST 1****DST 2****MIN 1****MIN 2****MAX 1****MAX 2**

These parameters are explained in detail in *Section 5 — Effect Concepts*.

## ROM-27 VCF+DISTORT

VCF+DISTORT combines a voltage control filter and a raspy distortion. Three effects can be obtained: Distortion, Wah-wah, and Auto-wah. The last two functions use the same VCF. These filters can be disabled or used as EQ if desired. There is a second VCF that exists after the distortion. It can be set to act like a simple speaker simulator, or it can be modulated in parallel with the pre-distortion VCF.

### VCF+DISTORT Signal Routing

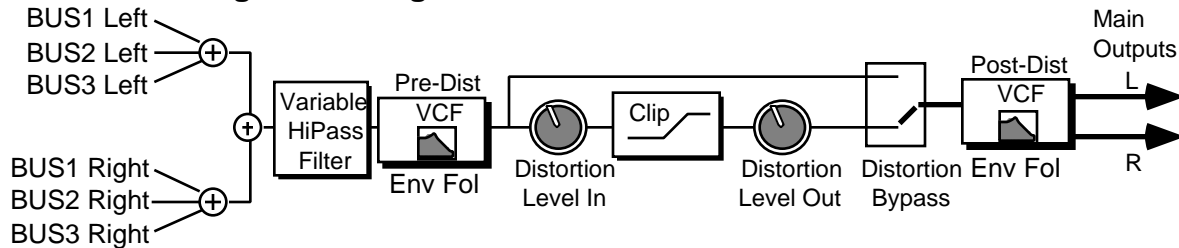

The BUS1, BUS2, and BUS3 MIX parameters can be routed into the effect with different Dry/Wet mixes.

The parameters available for this algorithm are:

**DIST LEVEL IN** Range: 0 to 99

This parameter controls the gain going into the distortion effect. DIST LEVEL IN will boost the signal level up to 48 dB. For more distortion, use a high input level gain and turn the DIST LEVEL OUT down to keep the volume under control. For less distortion, use a low gain input level and a higher output volume.

**DIST LEVEL OUT** Range: 0 to 99

This parameter controls the gain coming out of the distortion effect. Generally, if the DIST LEVEL IN is set high, set this parameter lower to control the volume.

**PRE-DIST VCF FC** Range: 1 to 99

This parameter determines the filter cut off frequency before the distortion. Higher values have a brighter sound. This parameter can be modulated, using a CV Pedal for a wah-wah pedal effect. To disable the distortion filter, set this parameter to 99. To use as an EQ, set the desired value and make sure PRE-DIST ENV FOL is +0. To use as the auto-wah, set this parameter close to 1 (lower values) and turn on PRE-DIST ENV FOL.

**PRE-DIST VCF Q** Range: 1 to 25

This parameter determines the level and width of the resonant peak at the filter cutoff point. While the PRE-DIST VCF FC parameter determines where (at what frequency) this peak will occur, the PRE-DIST VCF Q setting controls the *presence* of the peak. This setting is important for the auto-wah effect.

**PRE-DIST ENV FOL** Range: -99 to +99

This parameter determines how much the amplitude of the incoming signal will modify the distortion filter cutoff frequency. When set to +0, no modification will occur. When set to mid positive values, the PRE-DIST VCF FC will go high, but then come down to its nominal setting. When set to negative mid values, the PRE-DIST VCF FC will go low, and then go back up to its nominal setting. How quickly it does so is determined by the ATTACK and RELEASE parameters. This sound is the auto-wah; positive values will boost the high frequencies, offering an “oww-oww” sound, and negative values will cut the high frequencies, producing a “dweep-dweep” sound.



**POST-DIST VCF FC**

Range: 01 to 99

This parameter determines the filter cut off frequency *after* the distortion. Higher values have a brighter sound. This parameter can also be modulated, using a CV Pedal for a wah-wah pedal effect. To disable the post-distortion filter, set this parameter to 99.

**POST-DIST VCF Q**

Range: 1 to 25

This parameter determines the level and width of the resonant peak at the filter cutoff point. While the FC (filter cutoff) parameter determines where (at what frequency) this peak will occur, the Q setting controls the presence of the peak. This setting is important for the auto-wah effect.

**POST-DIST ENV FOL**

Range: -99 to +99

This parameter determines how much the amplitude of the incoming signal will modify the distortion filter cutoff frequency. When set to +0, no modification will occur. When set to mid positive values, FC will go high, but then come down to its nominal setting. When set to negative mid values, FC will go low, and then go back up to its nominal setting. How quickly it does so is determined by the ATTACK and RELEASE parameters. This sound is the auto-wah; positive values will boost the high frequencies, offering an “oww-oww” sound, and negative values will cut the high frequencies, producing a “dweep-dweep” sound.

**ATTACK**Range: 50 $\mu$ s to 10.0s

This parameter sets the attack of the envelope follower (i.e. determines how closely the attack is followed) once the incoming signal has been detected. Generally the attack should be short.

**RELEASE**

Range: 1ms to 10.0s

This parameter sets the amount of time after the incoming signal has ceased for the envelope follower to shut down. Generally these times are longer than the attack times.

**DISTORTION BYPASS**

Range: OFF or ON

This parameter allows you to bypass the distortion (as shown on the signal routing diagram).

**PRE-EQ HP FC**

Range: 0 to 1000 Hz

This parameter filters out the low frequencies before the EQ. The higher the value, the less low frequencies will pass through.

**MOD SRC 1****MOD SRC 2****DST 1****DST 2****MIN 1****MIN 2****MAX 1****MAX 2**

These parameters are explained in detail in *Section 5 — Effect Concepts*.

**ROM-28 GUITAR AMP 1****ROM-29 GUITAR AMP 2**

These algorithms recreate the warm sound of a guitar amplifier. They do this by emulating tube distortion characteristics. These algorithms are good for all stringed instruments. GUITAR AMP 1, designed for Hard Rock, offers more distortion than GUITAR AMP 2, which is optimized for “bluesy” type sounds. The BUS1 and BUS2 MIX parameters can be routed into the effect with different Dry/Wet mixes.

The parameters available for this algorithm are:

- PREAMP GAIN** Range: -48 to +48 dB  
This parameter adjusts the amount of boost or cut applied to the incoming signal. We recommend a setting of +0 dB, since these emulations were optimized for distortion there. Lower preamp gains will result in less distortion, while higher preamp gains will yield clipping distortion. For low preamp gain, it may be desirable to use low tube bias values.
- OUTPUT LEVEL** Range: 0 to 99  
This parameter controls the output level of the main amp before the output EQ.
- TUBE BIAS** Range: 0 to 99  
For preamp gains approximately 0 dB, this parameter controls the emphasis of even to odd harmonics which determines the tone of the amp; mid values emphasize even harmonics and offer a warmer (“glowing tube”) sound, while the highest values may sound like tubes going bad. Tube bias and preamp gain are independent parameters. For low preamp gain, it may be desirable to use low tube bias values, because this more closely imitates the operation of a real amplifier.
- PRE-EQ TRIM** Range: -24 to +0 dB  
This parameter controls the input level to the pre-amp EQ to eliminate the possibility of clipping boosted signals.
- PRE-EQ HIGH** Range: 4 to 1000 Hz  
This parameter filters out the low frequencies before the preamp. The higher the value, the less low frequencies pass through.
- PRE-EQ FC** Range: 0 to 9999 Hz  
This parameter determines the center frequency of the parametric filter before the preamp. Higher values have a brighter sound.
- PRE-EQ GAIN** Range: -48 to +24 dB  
This parameter adjusts the amount of boost or cut applied to the parametric filter in front of the preamp.
- PRE-EQ Q** Range: 1 to 18  
This parameter determines the width of the resonant peak at the parametric filter center frequency. While the Filter center parameter determines where (at what frequency) this peak will occur, the Q setting controls the presence of the peak.
- GATE OFF** Range: -96 to +0 dB  
This parameter sets the lower threshold level at which the noise gate shuts off the audio.
- GATE ON** Range: -96 to +0 dB  
This parameter sets the upper threshold level at which the noise gate passes the audio. The higher second threshold prevents false “turn ons.”
- GATE RELEASE** Range: 1ms to 10.0s  
This parameter sets the amount of time after the signal has elapsed for the noise gate to shut down. For a longer sustain, set this parameter higher.
- HIGH PASS FC** Range: 4 to 1000 Hz  
This parameter filters out the low frequencies of the main amp prior to the speaker. The higher the value, the less low frequencies pass through.



- PRE-EQ FC** Range: 0 to 9999 Hz  
This parameter determines the filter center frequency of the parametric in the preamp stage. Higher values have a brighter sound.
- PRE-EQ GAIN** Range: -48 to +24 dB  
This parameter adjusts the amount of boost or cut applied to the preamp parametric.
- PRE-EQ Q** Range: 1 to 18  
This parameter determines the width of the resonant peak at the filter center. While the Filter center parameter determines where (at what frequency) this peak will occur, the Q setting controls the presence of the peak.
- EXPANSION RATIO** Range: 1:1 to 40:1, infinity  
This parameter sets the amount of inverse expansion. Expansion occurs below the threshold. If this is set to 3:1 for example, it will expand the change in signals below the threshold by three times in an attempt to make the signal amplitude approach the threshold level.
- THRESHOLD** Range: -96 to +0 dB  
This parameter sets the inverse expander threshold level. Signals beneath this level will be expanded, while signals that are above will be unaffected. As the input signal dies away below the threshold, the expander will increase the gain of the signal.
- GATE OFF** Range: -96 to +0 dB  
This parameter sets the lower threshold level at which the noise gate shuts off the audio.
- GATE ON** Range: -96 to +0 dB  
This parameter sets the upper threshold level at which the noise gate passes audio. This higher second threshold prevents false “turn ons.”
- GATE RELEASE** Range: 1ms to 10.0s  
This parameter sets the amount of time after the signal has elapsed for the noise gate to shut down. For a longer sustain, set this parameter higher.
- HIGH PASS FC** Range: 4 to 1000 Hz  
This parameter filters out the low frequencies of the main amp prior to the speaker. The higher the value, the less low frequencies pass through.
- EQ1 FC** Range: 0 to 9999 Hz  
This parameter determines the filter center frequency of the parametric in the main amp stage. Higher values have a brighter sound.
- GAIN** Range: -48 to +24 dB  
This parameter adjusts the amount of boost or cut applied to the main amp parametric.
- EQ1 Q** Range: 1 to 18  
This parameter determines the width of the resonant peak at the filter center. While the Filter center parameter determines where (at what frequency) this peak will occur, the Q setting controls the presence of the peak.
- EQ2 FC** Range: 0 to 9999 Hz  
This parameter determines the filter center frequency of the second parametric in the main amp stage. Higher values have a brighter sound.

**GAIN** Range: -48 to +24 dB  
This parameter adjusts the amount of boost or cut applied to the second main amp parametric.

**EQ2 Q** Range: 1 to 18  
This parameter determines the width of the resonant peak of the second filter center.

**LOW PASS FC** Range: 2.0 to 15.0 KHz  
This parameter filters out the high frequencies of the speaker. The lower the value, the less high frequencies pass through. True speaker emulations are provided as separate algorithms.

<b>MOD SRC 1</b>	<b>MOD SRC 2</b>
<b>DST 1</b>	<b>DST 2</b>
<b>MIN 1</b>	<b>MIN 2</b>
<b>MAX 1</b>	<b>MAX 2</b>

These parameters are explained in detail in *Section 5 — Effect Concepts*.

## ROM-31 SPKR CABINET

SPKR CABINET simulates the warm sound of an opened back speaker cabinet. Speaker Cabinet is fabulous for a guitar, bass or any other stringed instrument. This algorithm contains the resonances and the nonlinearity of a real musical instrument speaker. The BUS1 and BUS2 parameters can be routed into the effect with different Dry/Wet mixes. For a brighter speaker emulation, try using TUNABLE SPKR.

The parameters available for this algorithm are:

**OUTPUT GAIN** Range: -48 to +24 dB  
Since speaker cabinets are “lossy,” output gain is required to compensate losses in perceived volume. Setting this gain too high will cause clipping of the output signal.

<b>MOD SRC 1</b>	<b>MOD SRC 2</b>
<b>DST 1</b>	<b>DST 2</b>
<b>MIN 1</b>	<b>MIN 2</b>
<b>MAX 1</b>	<b>MAX 2</b>

These parameters are explained in detail in *Section 5 — Effect Concepts*.

## ROM-32 TUNABLE SPKR

Tunable Speaker offers an EQ controllable speaker sound that is brighter than SPKR CABINET. By tuning three parametric filters, you can simulate many different speaker cabinet sounds that are used in all styles of music. The BUS1 and BUS2 parameters can be routed into the effect with different Dry/Wet mixes. The parameters available for this algorithm are:

**MID1 FC** Range: 0 to 9999 Hz  
This parameter sets the center of the mid-frequency parametric. Higher values have a brighter sound.

**GAIN** Range: -48 to +24 dB  
This parameter sets the amount of cut (negative values) or boost (positive values) applied to this mid-frequency parametric.

**MID1 Q** Range: 1 to 18  
This parameter is a bandwidth control that determines the width of the resonant peak at the center of the frequency band. By raising the value, you can produce a narrower bandwidth.

MID2 FC  
GAIN  
MID2 Q

MID3 FC  
GAIN  
MID3 Q

These parameters are identical to the previous ones, but can be assigned to control different bandwidths within the mid-range.

INPUT TRIM

Range: -24 to +0 dB

This parameter allows you to adjust the input level before the EQs to eliminate the possibility of clipping boosted signals.

OUTPUT GAIN

Range: -48 to +24 dB

Since speaker cabinets are “lossy,” output gain is required to compensate losses in perceived volume. Setting this gain too high will cause clipping of the output signal.

MOD SRC 1

MOD SRC 2

DST 1

DST 2

MIN 1

MIN 2

MAX 1

MAX 2

These parameters are explained in detail in *Section 5 — Effect Concepts*.

## ROM-33 EQ+CHOR+DDL

EQ+CHOR+DDL combines an EQ with a chorus and a digital delay. This is the industry standard chorus effect, designed with very long delays to provide a modulated detune effect. This algorithm sounds great with a guitar, but try it with any source!

### EQ+CHOR+DDL Signal Routing

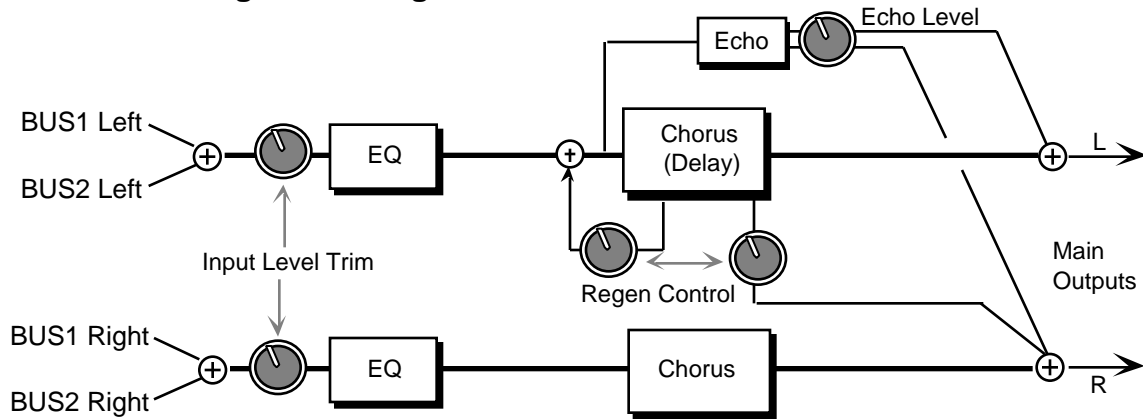

The signal enters a programmable EQ, which is preceded by an input level trim (EQ TRIM). The signal is then routed to the chorus which is heard directly at the output. There is also a delayed unchorused signal (sharing the same delay lines) that is routed back into the chorus. There is also a second signal from the delay line that is routed to the right side. There are two discrete echo times tapped out before the chorus delay line. These are unchorused echoes. The signal from the echoes is routed directly to the outputs. There is also a dry signal (not shown) that goes directly from the input to the output (BUS3). The BUS1 and BUS2 MIX parameters can be routed into the effect with different Dry/Wet mixes.

The parameters available for the EQ+CHOR+DDL are:

- CHOR RATE** Range: 0 to 99  
This parameter controls the rate of pitch modulation which is the chorus. To achieve chorusing, this rate must be very slow.
- CHOR WIDTH** Range: 0 to 99  
This parameter controls the excursion of pitch modulation. Since the rate is usually very slow, then the width is usually very large.
- CHORUS CENTER** Range: 0 to 99  
This parameter controls the nominal delay time of the chorus about which the delay modulation occurs. Adjusting this parameter will change the tonal character of the effect. This delay time is not related to the regen delays or the echo delays.
- L/R LFO** Range: OUT-OF-PHASE or IN-PHASE  
When this parameter is IN-PHASE, the left and right choruses will modulate their detunes together. When set to OUT-OF-PHASE, the detune on the left channel will go up while the detune on the right will go down.
- DLY TIME L** Range: 0 to 1500 ms  
This parameter controls the time delay for the left channel regen delay, and has nothing to do with the chorus effect.
- DLY TIME R** Range: 0 to 1500 ms  
This parameter controls the time delay for the right channel regen delay, and has nothing to do with the chorus effect.
- DELAY REGEN** Range: -99 to +99  
This parameter controls the amount of regeneration applied to the delay time taps. The sign of the value determines the polarity of the regen.
- ECHOTIME L** Range: 0 to 1500 ms  
This parameter controls the chorus echo time for the left side. Higher settings yield a deeper echo. There are two discrete echoes, one to the left and one to the right.
- ECHOTIME R** Range: 0 to 1500 ms  
This parameter controls the chorus echo time for the right side. Higher settings yield a deeper echo.
- ECHO LEVEL** Range: 0 to 99  
This parameter controls the volume of the discrete echo for both the left and right sides. Higher values offer louder echo, while a value of 0 will eliminate the echo. For sustained sounds, mid echo levels yield a “poor man’s reverb.”
- BASS FC** Range: 0 to 1000 Hz  
This parameter sets the cutoff frequency of the lower frequency band shelving filter.
- GAIN** Range: -48 to +24 dB  
This parameter sets the amount of boost or cut applied to the low shelving filter.
- TREBLE FC** Range: 01KHz to 15KHz  
This parameter sets the cutoff frequency of the high shelving filter.

**GAIN** Range: -48 to +24 dB  
This parameter sets the amount of boost or cut applied to the high shelving filter.

**EQ TRIM** Range: -24 to +00 dB  
This parameter allows you to adjust the input volume of the EQs to eliminate the possibility of clipping boosted signals.

**MOD SRC 1**  
**DST 1**  
**MIN 1**  
**MAX 1**

**MOD SRC 2**  
**DST 2**  
**MIN 2**  
**MAX 2**

These parameters are explained in detail in *Section 5 — Effect Concepts*.

## ROM-34 EQ+VIBR+DDL

EQ+VIBR+DDL combines a vibrato effect (a pitch shifter modulating over a very small range) with EQ and digital delay. Many vintage guitar amplifiers offered a vibrato control, but don't feel that this effect is limited to guitars, try this with other sources as well. There is a sample & hold parameter that doesn't hold the instantaneous pitch shift, but if set properly will provide a "chirping" effect when acting on the input signal.

### EQ+VIBR+DDL Signal Routing

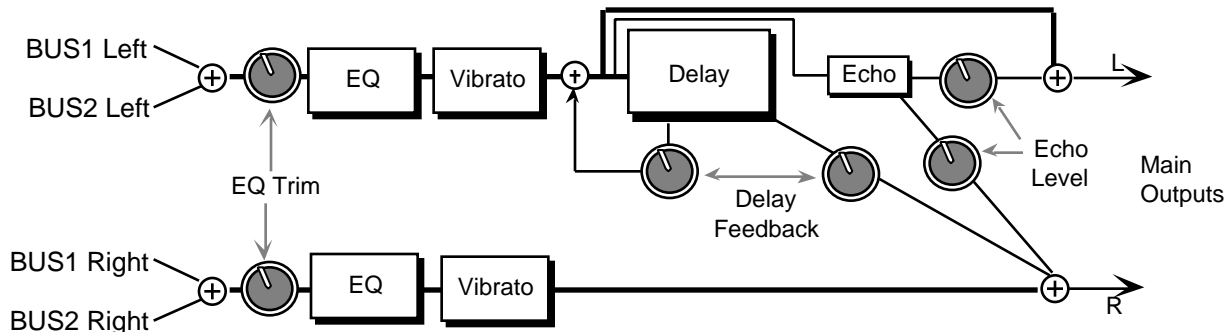

In this effect the signal enters a programmable EQ, which is preceded by an input level trim. The signal is then routed to the vibrato. The vibrato is routed directly to the output. The vibrato also passes through the delay which is then regenerated back into the delay. A different delay signal is routed to the output on the right side. This constitutes a "ping-pong" delay effect. The Delay Feedback parameter between the delay sends controls the delay feedback amount. There are also two echoes that are sent to the left and right outputs respectively. The signal from the two echoes has one level control. There is also an external dry signal (not shown) that goes directly from the input to the output (BUS3). The BUS1 and BUS2 MIX parameters can be routed into the effect with different Dry/Wet mixes.

The parameters available for this algorithm are:

**VIBR RATE** Range: 0 to 99  
This parameter sets the amount of modulation. Higher values create a faster vibrating rate.

**WIDTH** Range: 0 to 99  
This parameter sets the width (adjusts the amount) of the modulation.



**L/R LFO** Range: OUT-OF-PHASE or IN-PHASE  
This parameter controls the vibrato pitch direction of the left and right channels. When OUT-OF-PHASE, the quadrature pitch change on the left channel will lag 90° from the right. When IN-PHASE, both channels will change pitch together.

**SAMPLE/HOLD RATE** Range: 0 to 100  
This parameter controls the sample rate of a sample and hold network. This is applied to the LFO within the vibrato. When in hold (low values), it causes rhythmic chirps in the pitch of the audio signal. Higher values will increase the number of holds per second, making the vibrato flow more smoothly. The sample and hold function is turned off when set to 0.

**DELAY TIME L** Range: 0 to 1500 ms  
This parameter controls the time delay on the left regenerated delay.

**DELAY TIME R** Range: 0 to 1500 ms  
This parameter controls the time delay on the right nonregenerated delay.

**DELAY FEEDBACK** Range: -99 to +99  
This parameter controls the amount of positive or negative feedback applied to the regenerated delay. The sign of the value determines the polarity of the feedback. A value of +0 will eliminate any feedback. This parameter controls both left and right levels.

**ECHOTIME L** Range: 0 to 1500 ms  
This parameter controls the echo time for the left side. Higher settings yield a deeper echo. There are two discrete echoes, one to the left and one to the right.

**ECHOTIME R** Range: 0 to 1500 ms  
This parameter controls the echo time for the right side.

**ECHO LEVEL** Range: 0 to 99  
This parameter controls the volume of the discrete echo for both the left and right sides. A setting of 0 will eliminate any audible echo.

**BASS FC** Range: 0 to 1000 Hz  
This parameter selects the cutoff frequency of the low shelving filter.

**BASS GAIN** Range: -48 to +24 dB  
This parameter sets the amount of boost or cut applied to the low shelving filter.

**TREBLE FC** Range: 01KHz to 15KHz  
This parameter selects the cutoff of the upper frequency band high shelving filter.

**TREBLE GAIN** Range: -48 to +24 dB  
This parameter sets the amount of boost or cut applied to the high shelving filter.

**EQ TRIM** Range: -24 to +0 dB  
This parameter allows you to adjust the input volume before the EQs to eliminate the possibility of clipping boosted signals.

**MOD SRC 1**                                      **MOD SRC 2**  
**DST 1**    **DST 2**  
**MIN 1**    **MIN 2**  
**MAX 1**    **MAX 2**

These parameters are explained in detail in *Section 5 — Effect Concepts*.

**ROM-35 EQ+FLNGR+DDL**

EQ+FLNGR+DDL combines an EQ with a flanger and a digital delay. Use flanging to get that “jet aircraft woosh” effect.

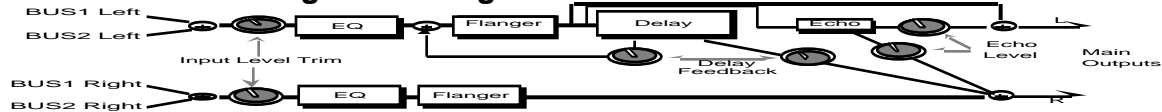
**EQ+FLANGER+DDL Signal Routing**

In this algorithm the signal enters an input level trim (EQ TRIM) followed by a programmable EQ, and then is routed to the flanger. The flanger is routed directly to the output. The left channel signal passes through the delay and is routed back into the flanger. Another signal from the delay is routed to the output on the right side. The DELAY FEEDBACK parameter controls both delay levels. There are two discrete echoes that are sent to the left and right outputs respectively. The signal from both echoes has one level control (ECHO LEVEL). There is also an external dry signal (not shown) that goes directly from the input to the output (BUS3). The BUS1 and BUS2 MIX parameters can be routed into the effect with different Dry/Wet mixes.

The parameters available for this algorithm are:

- FLANGE RATE** Range: 0 to 99  
This parameter controls the rate of modulation of the flanger effect.
- WIDTH** Range: 0 to 99  
This parameter controls the range of the high to low frequency sweep in the flanger effect.
- FLANGE CENTER** Range: 0 to 99  
This parameter controls the sweep center of the flanger effect. The larger the flanger center, the wider will be the available width.
- FLANGE FEEDBACK** Range: -99 to +99  
This parameter controls the amount of feedback applied from the output to the flanger input. The sign of the value determines the polarity of the feedback.
- NOTCH DEPTH** Range: -99 to +99  
This parameter controls the depth of the notches created by the flanging effect. A setting of +0 will disable the flanging effect. A setting of +0 will also provide a doppler effect for wide moderately slow LFO rates.
- L/R LFO** Range: OUT-OF-PHASE or IN-PHASE  
This parameter determines whether the flanger on the left and right channels is modulating IN-PHASE or OUT-OF-PHASE.
- SAMPLE/HOLD RATE** Range: 0 to 100  
This parameter controls the sample rate of a sample and hold network. This is applied to the LFO within the flanger. When in hold, the effect will be to create momentarily fixed notches within the frequency spectrum (if the notch depth is not +0). A setting of 1 will have the largest space between samples. Higher values will increase the number of holds per second, making the flanging flow more smoothly. The sample and hold function can be turned off (when set to 0).
- DLY TIME L** Range: 0 to 1500 ms  
This parameter controls the time delay for the left channel regen delay. This is the “ping.”
- DLY TIME R** Range: 0 to 1500 ms

This parameter controls the time delay for the right channel regen delay. This is the “pong.”

**DELAY FEEDBACK**

Range: -99 to +99

This parameter controls the level of the delay time taps. The sign of the value determines the polarity of the feedback.

**ECHO TIME L**

Range: 0 to 1500 ms

This parameter controls the flanger echo time for the left side. Higher values yield a deeper echo.

**ECHO TIME R**

Range: 0 to 1500 ms

This parameter controls the flanger echo time for the right side.

**ECHO LEVEL**

Range: 0 to 99

This parameter controls the volume of the discrete echoes for both the left and right sides. A setting of 0 would eliminate any audible echo.

**BASS FC**

Range: 0 to 1000 Hz

This parameter sets the cutoff frequency of the lower frequency band shelving filter.

**GAIN**

Range: -48 to +24 dB

This parameter sets the amount of boost or cut applied to the low shelving filter.

**TREBLE FC**

Range: 1KHz to 15KHz

This parameter selects the cutoff of the upper frequency band high shelving filter.

**GAIN**

Range: -48 to +24 dB

This parameter sets the amount of boost or cut applied to the high shelving filter.

**EQ TRIM**

Range: -24 to +0 dB

This parameter allows you to adjust the input volume of the EQs to eliminate the possibility of clipping boosted signals.

**MOD SRC 1****MOD SRC 2****DST 1****DST 2****MIN 1****MIN 2****MAX 1****MAX 2**

These parameters are explained in detail in *Section 5 — Effect Concepts*.

**ROM-36 EQ+TREM+DDL**

EQ+TREM+DDL combines a tremolo effect, which is a pulsating change in volume, with an EQ and a digital delay.

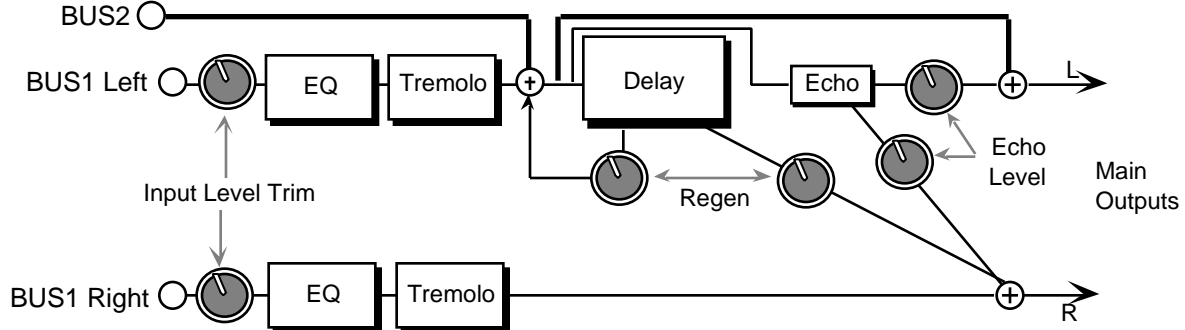
**EQ+TREM+DDL Signal Routing**

The signal enters an input level trim (EQ TRIM) followed by a programmable EQ, and is then routed to the tremolo. The tremolo is routed directly to the output. The left channel signal passes through the digital delay and is routed back into the delay. There is another signal from the delay that is routed to the output on the right side. One regen parameter (DELAY FEEDBACK) between the delay sends controls the left and right delay level. This constitutes the “ping-pong” effect. There are two echoes that are sent to the left and right outputs respectively. The signal from the two discrete echoes has one level control. There is also an external dry signal (not shown) that goes directly from the input to the output (BUS3). The parameters available for this algorithm are:

**BUS1 DLY AFT TREM**

Range: 0 to 99

This parameter determines how much of the signal that is sent to BUS 1 (the tremolo) will also go to the delay — it is a delay mix for the tremolo signal.

**BUS2 DELAY MIX**

Range: 0 to 99

This parameter controls the Dry/Wet mix of the delay for voices sent to BUS2. There is no tremolo routed to BUS2 (see diagram).

**TREM RATE**

Range: 0 to 99

This parameter sets the rate of modulation. Mid values create a faster wavering sound. This parameter, when used in conjunction with the SAMPLE/HOLD RATE parameter, can create some interesting staccato effects.

**DEPTH**

Range: 0 to 99

This parameter sets the depth of amplitude modulation.

**L/R LFO**

Range: OUT-OF-PHASE or IN-PHASE

This parameter controls whether the left and right channels of the stereo tremolo will modulate IN-PHASE or OUT-OF-PHASE.

**SAMPLE/HOLD RATE**

Range: 0 to 100

This parameter controls the sample rate of a sample and hold network applied to the LFO within the tremolo. When in “Hold,” the effect will be to fix the instantaneous amplitude (if the depth is not 0). A setting of 1 will have the largest space between holds. Lower settings create a staccato effect, whereas higher values will increase the amount of samples, making the tremolo flow more smoothly. This parameter can also be turned off (when set to 0).

- DLY TIME L** Range: 0 to 1500 ms  
This parameter controls the time delay for the left channel regen delay, and has nothing to do with the tremolo effect.
- DLY TIME R** Range: 0 to 1500 ms  
This parameter controls the time delay for the right channel regen delay.
- DELAY FEEDBACK** Range: -99 to +99  
This parameter controls the amount of regen applied to the delay time taps. The sign of the value determines the polarity of the regen. A value of +0 will eliminate the audible delay.
- ECHO TIME L** Range: 0 to 1500 ms  
This parameter controls the tremolo echo time for the left side. Higher settings yield a deeper echo.
- ECHO TIME R** Range: 0 to 1500 ms  
This parameter controls the tremolo echo time for the right side.
- ECHO LEVEL** Range: 0 to 99  
This parameter controls the volume of the discrete echo for both the left and right sides.
- BASS FC** Range: 0 to 1000 Hz  
This parameter selects the cutoff frequency of the lower frequency band shelving filter.
- GAIN** Range: -48 to +24 dB  
This parameter sets the amount of boost or cut applied to the low shelving filter.
- TREBLE FC** Range: 1KHz to 15KHz  
This parameter selects the cutoff frequency of the upper frequency band high shelving filter.
- GAIN** Range: -48 to +24 dB  
This parameter sets the amount of boost or cut applied to the high shelving filter.
- EQ TRIM** Range: -24 to +0 dB  
This parameter allows you to adjust the input volume of the EQs to eliminate the possibility of clipping boosted signals.
- MOD SRC 1**                      **MOD SRC 2**  
**DST 1**                              **DST 2**  
**MIN 1**                             **MIN 2**  
**MAX 1**                             **MAX 2**

These parameters are explained in detail in *Section 5 — Effect Concepts*.

## ROM-37 PHASER+DDL

PHASER+DDL combines a phaser with a digital delay. The phaser creates non-harmonically spaced moving notches in the signal spectrum, whereas a flanger creates harmonic spacing. This phaser implements a stereo twelve pole phasing network to achieve time delay which is a function of frequency; this is what differentiates the phaser from the flanger. The phasing effect is achieved within the Phaser topology, so it does not depend upon the external mix. A delay is included at the left output of the phaser that feeds back into the phaser (see the diagram). Setting the phaser DELAY FEEDBACK parameter (shown at the knobs) to 0 will disable this delay function. The DELAY FEEDBACK also controls the delay feed forward level of another tap sent

to the right channel. This delay topology achieves a 1.5 second ping-pong effect, and is very effective as a “poor man’s reverb.” The BUS1 and BUS2 parameters can be routed into the effect with different Dry/Wet mixes. BUS3 (not shown) is a dry path.

### Phaser+DDL Signal Routing

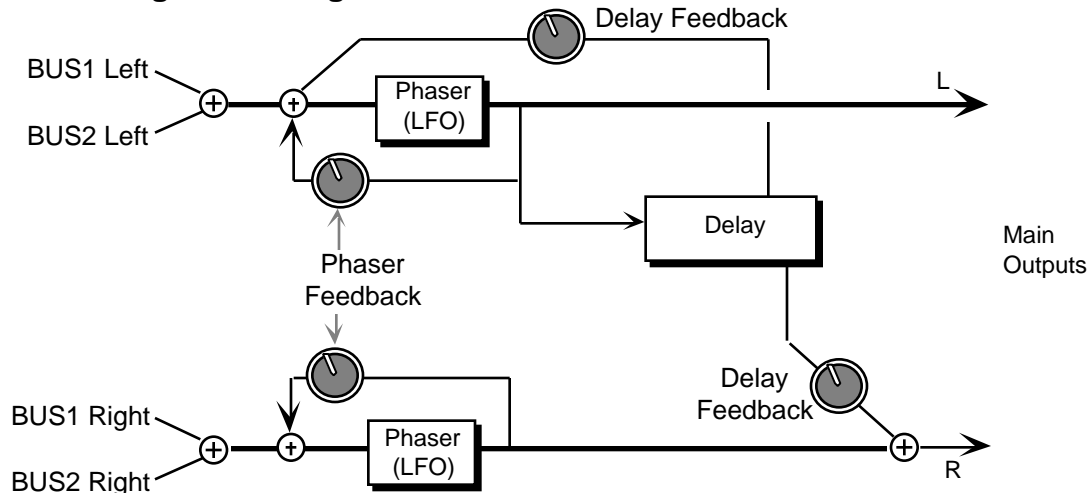

The parameters available for this algorithm are:

- PHASE RATE** Range: 0 to 99  
The LFO is within the phaser network. This parameter controls the rate of modulation of the phaser poles. The higher the value the faster the rate. Lower values work best with sustained signals.
- WIDTH** Range: 0 to 99  
This parameter controls the width of the notch excursion. For large excursions set this parameter to 99 which can give a very high “woosh” and a very low “woosh.”
- PHASE CENTER** Range: -99 to +99  
This parameter controls the phaser pole center. High values raise the nominal spectral location of the “woosh” sound, while low values lower the “woosh.” The range from high to low is controlled with the phaser width.
- PHASER FEEDBACK** Range: -99 to +99  
This parameter controls the amount of feedback applied to the left and right channel phaser. The sign of the value determines the polarity of the feedback.
- NOTCH DEPTH** Range: -99 to +99  
This parameter controls the depth of the notches created by the phasing. Deep notches occur in the phased spectrum when the parameter is set to 99. When this parameter is set to +0, there exists no phasing (i.e. notches), but there is a doppler effect with higher phase rates.
- L/R LFO** Range: OUT-OF-PHASE or IN-PHASE  
This parameter determines whether the phaser on the left and right channels is modulating IN-PHASE or OUT-OF-PHASE.

**SAMPLE/HOLD RATE**

Range: 0 to 100

This parameter controls the sample rate of a sample and hold network applied to the LFO within the phaser. When in hold, the effect will be to create momentarily fixed notches within the frequency spectrum (if the notch depth is not +0). A setting of 1 will have the largest space between samples. Higher values will increase the number of holds per second, making the phasing flow more smoothly. The sample and hold function can be turned off (when set to 0).

**DLY TIME L**

Range: 0 to 1600 ms

This parameter sets the delay time for the left side. This is the “ping.”

**DLY TIME R**

Range: 0 to 1600 ms

This parameter controls the feed forward delay time for the right side. This is the “pong.”

**DELAY FEEDBACK**

Range: -99 to +99

This parameter controls the feedback amount for the delay effect. The sign of the value determines the polarity of the feedback. A value of +0 will eliminate the delay effect. This parameter also controls the feed forward level.

**MOD SRC 1****MOD SRC 2****DST 1****DST 2****MIN 1****MIN 2****MAX 1****MAX 2****MAX 2**

These parameters are explained in detail in *Section 5 — Effect Concepts*.

**ROM-38 8-VOICE CHOR**

8-VOICE CHOR offers a symphonic chorused sound having eight different voices and using eight separately randomized LFOs. This algorithm also offers a user programmable stereo delay in a cross coupled configuration between the left and right chorused outputs (see diagram). This algorithm is good for creating an ensemble of instruments from single sources (there is no internal filtering applied to any of the chorused voices). The BUS1 and BUS2 parameters can be routed into the effect with different Dry/Wet mixes. BUS3 (not shown) is a dry path. For this algorithm we recommend a Mix of around 50 for a starting point.

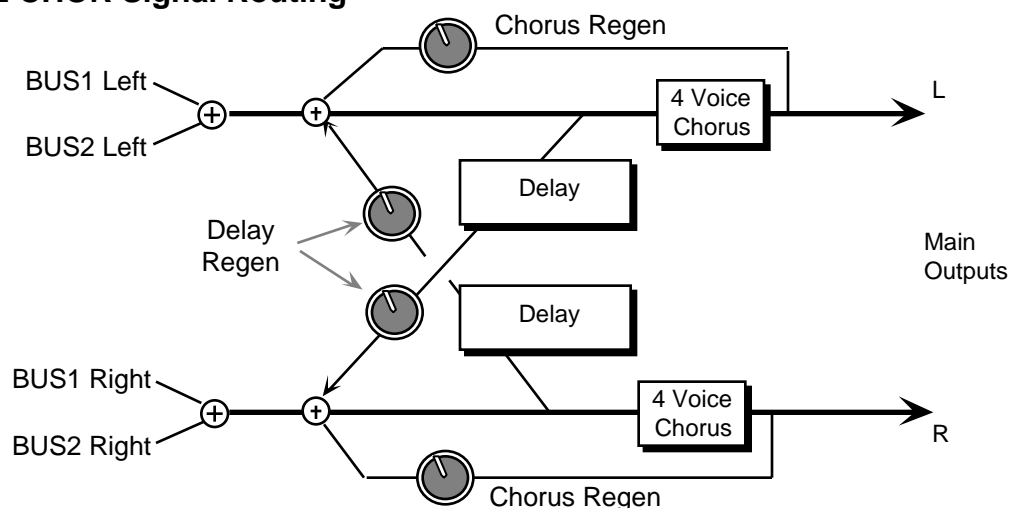
**8-VOICE CHOR Signal Routing**

- LFO RATE** Range: 0 to 99  
This parameter controls the eight ganged rates of modulation of the respective voices. This modulation produces an effect similar to both vibrato and tremolando occurring at the same time.
- WIDTH** Range: 0 to 99  
This parameter controls the excursion of the vibrato of all the individual voices.
- STEREO SPREAD** Range: 0 to 99  
This parameter offers a synthesized stereo field. The highest value is true stereo, intermediate values have the left and right signals mixed on both sides, and the lowest value yields only the left input channel from the right and left outputs. This parameter, though not a stereo pan, provides some interesting stereo effects when controlled by a modulation source.
- CHORUS REGEN** Range: 0 to 99  
This parameter determines the amount of signal that will be fed from the output of the chorus back into the input of the chorus. A value of 0 will eliminate the regeneration effect.
- L REGEN TIME** Range: 0 to 800 ms  
This parameter controls the amount of time that the non-chorused signal will delay for the left channel.
- R REGEN TIME** Range: 0 to 800 ms  
This parameter controls the amount of time that the non-chorused signal will delay for the right channel.
- DELAY REGEN** Range: 0 to 99  
This parameter determines the amount of signal that will be fed from the delay output back into the chorus input, increasing the number of repeats in the delay for high values. A value of 0 will eliminate the delay effect.
- |                  |                  |
|------------------|------------------|
| <b>MOD SRC 1</b> | <b>MOD SRC 2</b> |
| <b>DST 1</b>     | <b>DST 2</b>     |
| <b>MIN 1</b>     | <b>MIN 2</b>     |
| <b>MAX 1</b>     | <b>MAX 2</b>     |
- These parameters are explained in detail in *Section 5 — Effect Concepts*.

## ROM-39 PITCH SHIFT

The Pitch Shifters allow you to change the pitch of a signal to any pitch desired within a range of one octave in either direction. The ASR-10 offers three different pitch shift algorithms, each designed with a different purpose:

- PITCH SHIFT offers a 1 unit splicer type pitch shifter.
- PITCH+DDL combines a pitch shifter with a DDL (described later).
- FAST PITCHSH is a 1 unit pitch shifter designed for pitch correction.

These algorithms sound best with a Mix of wet and dry. Try using a modulation controller for the Mix parameter to bring in or fade out the pitch shifted signal. Try the different pitch shifters until you find the one that works best with your sound source, and for your application. This first algorithm is a “splicer type” of pitch shifter, which means that it drops or adds small sections of the original signal to the effect. PITCH SHIFT does not incorporate zero crossing detection. This pitch shifter is best used for a doubling effect. Splicer type pitch shifters are



popular because for low pitch shift ratios, splicing is infrequent. These pitch shifters can create very interesting stereo fields by panning each of two pitch shifted voices selectively, and because of the inherent time delay modulation of the algorithm. The BUS1 and BUS2 parameters can be routed into the effect with different Dry/Wet mixes. BUS3 (not shown) is a dry path.

The parameters available for this algorithm are:

- VC 1 SEMI** Range: -12 to +12  
This parameter allows you to adjust the pitch of Voice 1 up to an octave above or below the original pitch in semi-tones (half steps).
- VC 1 FINE** Range: -99 to +99  
This parameter allows you to fine tune the pitch of Voice 1.
- VC 1 VOL** Range: 0 to 99  
This parameter allows you to adjust the volume of Voice 1. A setting of 0 would eliminate any audible pitch shift.
- VC 1 PAN** Range: -99 to +99  
This parameter allows you to assign the location of Voice 1 in the stereo field. A value of -99 would be far left, and +99 would be far right.
- VC 2 SEMI** Range: -12 to +12  
This parameter allows you to adjust the pitch of Voice 2 up to an octave above or below the original pitch in semi-tones.
- VC 2 FINE** Range: -99 to +99  
This parameter allows you to fine tune the pitch of Voice 2.
- VC 2 VOL** Range: 0 to 99  
This parameter allows you to adjust the volume of Voice 2. A setting of 0 would eliminate any audible pitch shift.
- VC 2 PAN** Range: -99 to +99  
This parameter allows you to assign the location of Voice 2 in the stereo field. A value of -99 would be far left, and +99 would be far right.
- QUALITY** Range: LONG/SMOOTHER or SHORT/COARSER  
This parameter allows you to choose between a long/smooth setting, or a short/coarse setting. A smooth setting would sound best with slower sustaining chords, whereas a coarse setting would enhance a rapidly played musical passage. Depending on your sound source and musical needs, set this parameter accordingly. This parameter actually controls the effect transport delay; smooth yields a long transport delay, coarse yields a short transport delay.
- LFO RATE** Range: 0 to 99  
This parameter controls the rate of pitch modulation that creates a chorusing effect. To achieve chorusing, this rate must be very low.
- WIDTH** Range: 0 to 99  
This parameter controls the excursion of pitch modulation. Since the rate is usually very low, then the width is usually very large.

**MOD SRC 1**  
**DST 1**  
**MIN 1**  
**MAX 1**

**MOD SRC 2**  
**DST 2**  
**MIN 2**  
**MAX 2**

These parameters are explained in detail in *Section 5 — Effect Concepts*.

**Note:** When KBD is selected as a MOD SRC, and VC1 SEMI or VC2 SEMI is selected as the DST (destination), the pitch will increase one semitone at a time above middle C (C4), and decrease one semitone at a time below middle C (Middle C being zero). After each octave, the pitch shift will “wrap” and start again (the pitch can’t be modulated more than one octave in either direction).

## ROM-40 PITCH+DDL

PITCH+DDL combines a pitch shifter with a digital delay. PITCH+DDL uses a continual crossfading technique of pitch shifting. This technique maintains the stereo field exactly. This pitch shifter works best for large pitch shift ratios, in some circumstances. Another feature of this algorithm is a digital delay that feeds back into the pitch shift. This feature allows spiraling upward or downward pitch shifts. The BUS1 and BUS2 parameters can be routed into the effect with different Dry/Wet mixes. BUS3 (not shown) is a dry path. This algorithm sounds best with a Mix of wet and dry. Try using a modulation controller for this parameter to fade in or fade out the pitch shifted signal.

### PITCH+DDL Signal Routing

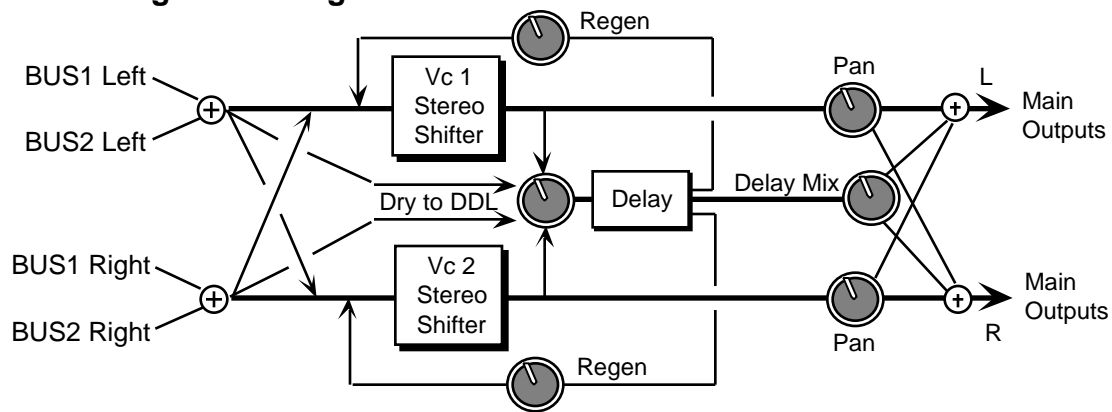

The parameters available for this algorithm are:

**VC 1 SEMI**

Range: -12 to +12

This parameter allows you to adjust the pitch of Voice 1 up to an octave above or below the original pitch in semi-tones.

**VC 1 FINE**

Range: -99 to +99

This parameter allows you to fine tune the pitch of Voice 1.

**VOICE 1 VOL**

Range: 0 to 99

This parameter adjusts the volume of Voice 1.

**VOICE 1 PAN**

Range: -99 to +99

This parameter allows you to assign the location of Voice 1 in the stereo field. A value of -99 would be far left, and +99 would be far right.

**VC 2 SEMI** Range: -12 to +12  
 This parameter allows you to adjust the pitch of Voice 2 up to an octave above or below the original pitch in semi-tones.

**VC 2 FINE** Range: -99 to +99  
 This parameter allows you to fine tune the pitch of Voice 2. Slight shifts create something like a chorused effect.

**VOICE 2 VOL** Range: 0 to 99  
 This parameter adjusts the volume of Voice 2.

**VOICE 2 PAN** Range: -99 to +99  
 This parameter allows you to assign the location of Voice 2 in the stereo field. A value of -99 would be far left, and +99 would be far right.

**DRY LEVEL TO DDL** Range: 0 to 99  
 This parameter allows you to bypass the pitch shifter with an internal dry signal, and send it through the digital delay. Higher values would send more of the dry signal to the delay. The purpose of this parameter is to mix the dry signal appropriately with the pitch shifted delay signals.

**DLY TIME L** Range: 0 to 1500 ms  
 This parameter controls the amount of time for the pitch shifted signal to delay from the left input.

**DLY TIME R** Range: 0 to 1500 ms  
 This parameter controls the amount of time for the pitch shifted signal to delay from the right input.

**DLY MIX** Range: 0 to 99  
 This parameter controls the mix between the delay signal and the pitch shifted signal. A setting of 0 would be all pitch shifter, and no delay. A setting of 99 will be all delay and no direct pitch shift.

**DLY REGEN** Range: -99 to +99  
 This parameter controls the amount of feedback from the output of the delay back into the input of the pitch shifter. This allows you to create special effects with ascending/descending delays.

**MOD SRC 1**  
**DST 1**  
**MIN 1**  
**MAX 1**

**MOD SRC 2**  
**DST 2**  
**MIN 2**  
**MAX 2**

These parameters are explained in detail in *Section 5 — Effect Concepts*.

## ROM-41 FAST PITCHSH

FAST PITCHSH has a transport delay of only 10 ms and a maximum detune ratio of one semitone. Try shifting the voices slightly in both positive and negative values to create a fat sound. This algorithm should be used for pitch correction (for instance, try using the mod wheel as a pitch controller). The BUS1 and BUS2 parameters can be routed into the effect with different Dry/Wet mixes. BUS3 is a dry path. Depending on its usage, this algorithm generally sounds best with a Mix of dry and wet. Try using the modulation wheel for the Mix parameter to bring in or fade out the pitch shifted signal.

The parameters available for this algorithm are:

**VOICE 1 FINE** Range: -99 to +99

This parameter allows you to fine tune the pitch of Voice 1.

**VOICE 1 VOL** Range: 0 to 99

This parameter allows you to adjust the volume of Voice 1. A setting of 0 would eliminate any audible pitch shift.

**VOICE 1 PAN** Range: -99 to +99

This parameter allows you to assign the location of Voice 1 in the stereo field. A value of -99 would be far left, and +99 would be far right.

**VOICE 2 FINE** Range: -99 to +99

This parameter allows you to fine tune the pitch of Voice 2.

**VOICE 2 VOL** Range: 0 to 99

This parameter allows you to adjust the volume of Voice 2. A setting of 0 would eliminate any audible pitch shift.

**VOICE 2 PAN** Range: -99 to +99

This parameter allows you to assign the location of Voice 2 in the stereo field. A value of -99 would be far left, and +99 would be far right.

**LFO RATE** Range: 0 to 99

This parameter controls the rate of pitch modulation that creates a chorusing effect. To achieve chorusing, this rate must be very low.

**WIDTH** Range: 0 to 99

This parameter controls the excursion of pitch modulation. Since the rate is usually very low, then the width is usually very large.

**MOD SRC 1**

**DST 1**

**MIN 1**

**MAX 1**

**MOD SRC 2**

**DST 2**

**MIN 2**

**MAX 2**

These parameters are explained in detail in *Section 5 — Effect Concepts*.

## ROM-42 EQ+COMPRESSOR

EQ+COMPRESSOR combines an EQ with a full feature compressor. For high compressor ratios, this algorithm functions as a limiter. This algorithm operates by compressing (attenuating) signals above the threshold and passing the signals below the threshold. For higher ratios and lower thresholds, this algorithm can be used to create sustain. EQ exists in both signal and side chain paths, in contrast to the EXPANDER that has filtering in only the side chain path.

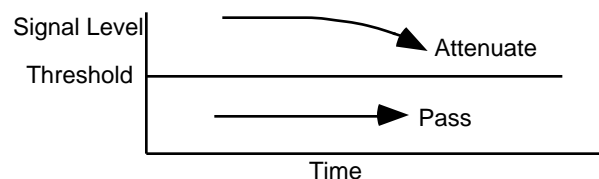

The parameters available for this algorithm are:

- COMP GAIN** Range: -48 to +48 dB  
This parameter boosts the compressed signal level.
- COMP RATIO** Range: 1/1 to 40/1, infinity  
This parameter sets the amount of compression. The range is based on decibels (dB) above the threshold. If this is set to 4/1 for example, it will compress changes in signals above the threshold by one quarter. When this is set to infinity, it acts as a limiter.
- COMP THRESHOLD** Range: -96 to +0 dB  
This parameter sets the threshold level. Signals that exceed this level will be compressed, while signals that are below will be unaffected. To turn off the compressor, set the level to +0 dB.
- COMP ATTACK** Range: 50µs to 100ms  
This parameter determines the attack rate after the initial signal has been detected and before the compression takes affect.
- COMP RELEASE** Range: 1ms to 10.0s  
This parameter determines how long it takes for the compression to be fully deactivated after the input signal drops below the threshold level. This is generally chosen longer than the attack time.
- GATE OFF** Range: -96 to +0 dB  
This parameter sets the lower threshold level at which the noise gate shuts off the audio.
- GATE ON** Range: -96 to +0 dB  
This parameter sets the upper threshold level at which the noise gate passes audio. This higher second threshold prevents false “turn ons.”
- GATE RELEASE** Range: 1ms to 10.0s  
This parameter determines how long it takes for the gate to be fully released after the input signal drops below the threshold level. Lower settings yield a quick gate.
- BASS FC** Range: 0 to 1000 Hz  
This parameter sets the cutoff frequency of the lower frequency band shelving filter.
- GAIN** Range: -48 to +24 dB  
This parameter sets the amount of boost or cut applied to the low shelving filter.
- TREBLE FC** Range: 1KHz to 15KHz  
This parameter sets the cutoff frequency of the upper frequency band high shelving filter.
- GAIN** Range: -48 to +24 dB  
This parameter sets the amount of boost or cut applied to the high shelving filter.
- EQ TRIM** Range: -24 to +0 dB  
This parameter allows you to adjust the input volume of the EQs, to eliminate the possibility of clipping boosted signals.
- MOD SRC 1**                      **MOD SRC 2**  
**DST 1**                            **DST 2**  
**MIN 1**                          **MIN 2**  
**MAX 1**                          **MAX 2**

These parameters are explained in detail in *Section 5 — Effect Concepts*.

**ROM-43 EXPANDER**

EXPANDER performs downward expansion of input signals. For high expansion ratios this algorithm functions as a gate. This algorithm operates by expanding (attenuating) signals below the threshold and passing the signals above the threshold. The Threshold is a parameter defined by the user. This algorithm can be used to eliminate noise. There is no EQ in the audio path; high and low pass filtering is provided on the side chain only. This algorithm possesses two unique features:

- 1) The ADSR in this algorithm has Attack, Sustain, and Release (the sustain is called the HOLD TIME).
- 2) This algorithm contains a trigger mask function. This function is used primarily to extract a click track from drum tracks. Once triggered, this function inserts a zero signal level into the side chain detector for an amount of time determined by the user. This function becomes triggered if TRIGGER MASK is enabled and if the side chain signal falls below the Trigger MASK THRESHOLD.

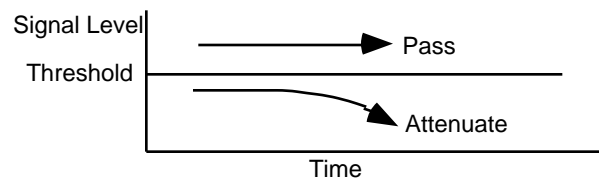
**EXPANSION RATIO**

Range: 1/1 to 1/40, INF

This parameter sets the amount of expansion. The range is based on decibels (dB) below the threshold. If this is set to 1/4 for example, it will expand changes in signals below the threshold by a factor of four. When this is set to infinity, it acts as a gate. A setting of 1/1 offers no expansion.

**THRESHOLD**

Range: -96 to +0 dB

This parameter sets the threshold level. Signals that exceed this level will be unaffected, while signals that are below will be expanded. To turn off the expander, set the level to -96 dB.

**ATTACK TIME**Range: 50 $\mu$ s to 100ms

This parameter determines the attack rate after the initial signal has been detected and before the expansion takes affect.

**RELEASE TIME**

Range: 1ms to 10.0s

This parameter determines the release rate after the signal has been detected below the threshold level. This is generally chosen longer than the ATTACK TIME.

**HOLD TIME**

Range: 1ms to 10.0s

This parameter is the detection sustain time in the ADSR that constitutes attack, sustain, and release.

**EQ GAIN**

Range: -48 to +48 dB

This parameter controls the amount of boost applied to the output signal of the high/low pass filter. This accounts for insertion loss through those filters.

**HIGH PASS FC**

Range: 4 to 8000 Hz

This sets the cutoff frequency of the lower frequency band high pass shelving filter.

**LOW PASS FC**

Range: 100 Hz to 15 KHz

This parameter sets the amount of boost or cut applied to the low pass filter.

**TRIGGER MASK** Range: OFF or ON  
 This parameter enables the trigger mask function. Once triggered, the side chain detector will see no input signal for a duration specified by the TRIGGER TIME.

**TRIGGER TIME** Range: 1ms to 10.0s  
 This parameter sets the duration over which the side chain detector will be blacked out. This parameter is useful for isolating the first bar of a drum track.

**MASK THRESHOLD** Range: -96 to +0 dB  
 This parameter sets the trigger mask threshold level. Signals that fall below this level will trigger the mask function. The trigger mask function uses the (expander) THRESHOLD as upward hysteresis. Therefore, the MASK THRESHOLD should always be set lower than the (expander) THRESHOLD.

**OUTPUT GAIN** Range: -48 to +48 dB  
 This parameter sets the amount of cut (negative values) or boost (positive values) applied to the expander on the output volume. We recommend a starting application of +0 dB.

<b>MOD SRC 1</b>	<b>MOD SRC 2</b>
<b>DST 1</b>	<b>DST 2</b>
<b>MIN 1</b>	<b>MIN 2</b>
<b>MAX 1</b>	<b>MAX 2</b>

These parameters are explained in detail in *Section 5 — Effect Concepts*.

## ROM-44 KEYED EXPNDR

KEYED EXPNDR operation is identical to the Expander. The only difference is that the left signal (BUS1 or BUS2 hard left) is expanded as determined by the key. The key is the right channel signal (BUS1 or BUS2 hard right). Make sure your sources are routed this way in order for this effect to work properly. BUS3 is a dry path.

### KEYED EXPANDER Signal Routing

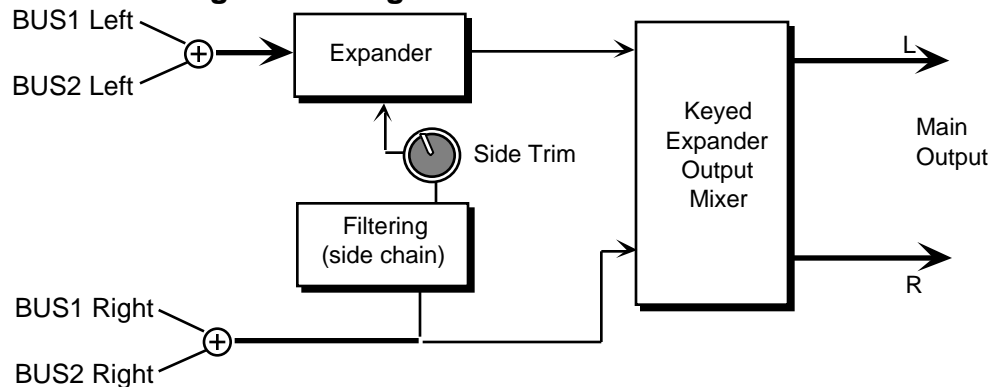

**EXPANSION RATIO** Range: 1/1 to 1/40, INF  
 This parameter sets the amount of expansion. The range is based on decibels (dB) below the threshold. If this is set to 1/4 for example, it will expand changes in signals below the threshold by a factor of four. When this is set to infinity, it acts as a gate. A setting of 1/1 offers no expansion.





**ROM-45 INVRS EXPNDR**

INVRS EXPNDR creates sustain by expanding the signal so that the signal levels above threshold are passed and levels below threshold are boosted to create a more even sound. A traditional expander would have the opposite effect: that is a signal level below threshold would be attenuated. An inverse expander is much like a compressor in so far as they both can be used to create sustained sounds, and de-emphasize transient signals. EQ exists in both signal and side chain paths, in contrast to the Expander that has filtering in only the side chain path.

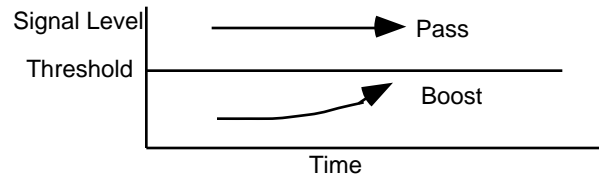

The parameters available for this algorithm are:

- EXPANSION RATIO** Range: 1/1 to 40/1, INF  
 This parameter sets the amount of expansion. The range is based on decibels (dB) below the threshold. If this is set to 3/1 for example, it will expand the changes in signals that are below the threshold level by three times. We recommend starting with settings near 1/1 (a setting of exactly 1/1 disables expansion).
- THRESHOLD** Range: -96 to +0 dB  
 This parameter sets the threshold level. Signals below this level will be boosted, while signals that are above will be unaffected. As the input signal dies away below the threshold, the expander will increase the signal gain. To turn off the inverse expander, set the threshold to -96dB.
- ATTACK TIME** Range: 50 $\mu$ s to 100ms  
 This parameter determines the time after the initial signal amplitude has been detected for the expansion to take affect.
- RELEASE TIME** Range: 1ms to 10.0s  
 This parameter determines how long it takes for the expansion to be fully deactivated after the input signal rises above the threshold level. This is generally longer than the ATTACK TIME.
- GATE OFF** Range: -96 to +0 dB  
 This parameter sets the lower threshold level at which the noise gate shuts off the audio.
- GATE ON** Range: -96 to +0 dB  
 This parameter sets the upper threshold level at which the noise gate passes audio. This second parameter provides hysteresis.
- BASS FC** Range: 0 to 1000 Hz  
 This parameter sets the cutoff frequency of the lower frequency band shelving filter.
- GAIN** Range: -48 to +24 dB  
 This parameter sets the amount of boost or cut applied to the low shelving filter.
- TREBLE FC** Range: 1KHz to 15KHz  
 This parameter sets the cutoff frequency of the upper frequency band high shelving filter.





## ROM-47 DUCKER

The DUCKER algorithm is a compressor that automatically lowers the level of a signal (such as music) when another signal (like an announcer voice-over) comes in. When the voice-over leaves, the level of the original signal is restored. This algorithm is useful for voice-overs, Rap, and DJ work. In order for this algorithm to work properly, the music (audio source to be ducked) must be sent to BUS1 or BUS2 hard left, and the voice-over is sent to BUS1 or BUS2 hard right. In this set up, BUS1 or BUS2 (hard right) is considered the side chain to a traditional compressor. This algorithm employs an internal mixer that mixes left and right inputs to a mono output.

The gate function is achieved for high compression ratios. In this application a transient signal source, such as a snare drum, can gate on and off some other music signal, to achieve an externally controllable staccato effect.

### DUCKER Signal Routing

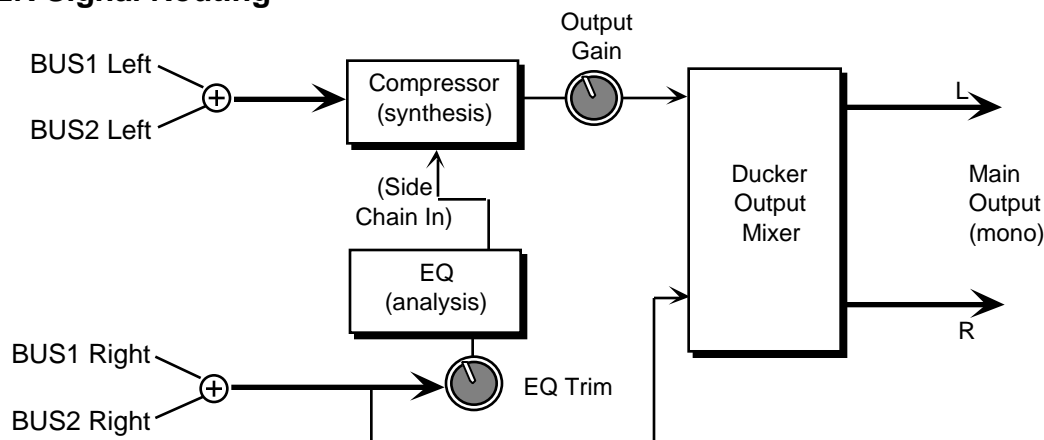

#### OUTPUT GAIN

Range: -48 to +48 dB

This parameter sets the amount of cut (negative values) or boost (positive values) applied to the ducker on the output volume. We recommend a starting application of +0 dB.

#### OUTPUT MIX

Range: 0 to 99

This parameter mixes the output of the music signal (BUS1 or BUS2 hard left) with the output of the ducker (voice-over) signal (BUS1 or BUS2 hard right) to a mono output. This is the Ducker Output Mixer that is shown in the diagram.

#### COMP RATIO

Range: 1/1 to 40/1, INF

This parameter sets the amount of compression. The range is based on decibels (dB) above the threshold. If this is set to 4/1 for example, it will compress changes in signals above the threshold by one quarter. When this is set to infinity, it acts as a limiter.

#### THRESHOLD

Range: -96 to +0 dB

This parameter sets the threshold level. Signals that exceed this level will be compressed, while signals that are below will be unaffected.

#### ATTACK TIME

Range: 50 $\mu$ s to 100ms

This parameter determines the attack rate after the initial signal has been detected and before the compression takes affect.





**TREBLE FC** Range: 1 to 15 KHz  
This parameter sets the center frequency of the high frequency parametric.

**GAIN** Range: -48 to +24 dB  
This parameter sets the amount of boost or cut applied to this high frequency parametric.

**EQ TRIM** Range: -24 to +0 dB  
This parameter allows you to adjust the input level trim to the EQs to eliminate the possibility of clipping boosted signals.

<b>MOD SRC 1</b>	<b>MOD SRC 2</b>
<b>DST 1</b>	<b>DST 2</b>
<b>MIN 1</b>	<b>MIN 2</b>
<b>MAX 1</b>	<b>MAX 2</b>

These parameters are explained in detail in *Section 5 — Effect Concepts*.

## ROM-50 VAN DER POL

VAN DER POL Filter adds synthetic high harmonics to the input signal, brightening the overall sound. This newly designed algorithm is most often used in the studio for vocalists, but feel free to experiment with this algorithm using your favorite instrument as well. This algorithm features prominent transient enhancement that makes it ideal for “plucked” sounds. The filter in this algorithm operates on the signal prior to enhancement. Set the filter to enhance the frequency region that you desire. Then use the BUS1 MIX parameter to mix the enhanced signal with the dry signal. For this algorithm we recommend mid values of the Mix.

The parameters available for the Van Der Pol Filter are:

**HIGH PASS FC** Ranges: 4 to 8000 Hz  
This parameter controls the boost or cut of the high pass filter frequency applied to the input signal.

**LOW PASS FC** Ranges: 100 Hz to 15 KHz  
This parameter controls the boost or cut of the low pass filter frequency applied to the input signal.

**FILTER GAIN** Ranges: -48 to +48 dB  
Because the cascade of high pass with low pass causes an insertion loss, this parameter allows you to boost the filtered output signal.

<b>MOD SRC 1</b>	<b>MOD SRC 2</b>
<b>DST 1</b>	<b>DST 2</b>
<b>MIN 1</b>	<b>MIN 2</b>
<b>MAX 1</b>	<b>MAX 2</b>

These parameters are explained in detail in *Section 5 — Effect Concepts*.



# Section 7 — Sampling/Signal Source Concepts

This section provides an overview of the sampling process. For a complete list of the sampling parameters, refer to the following section.

## What is Sampling?

Before getting into talking about samples and sampling, let's begin with a simple explanation of sound. A sound begins as a series of vibrations, or pressure waves, in the air. When these vibrations reach the diaphragm of a microphone, they cause it to move back and forth. This creates a fluctuating electrical signal that rises and falls around a center, or zero line.

A simple sound wave, once it has been converted into an electrical signal, might look like this:

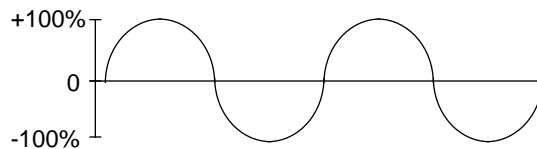

A conventional analog tape recorder would record this signal by converting the electrical fluctuations into magnetic fluctuations and then imprinting a continuous (or “analog”) copy onto the magnetic surface of the tape.

A digital sampling system, such as the ASR-10 or a digital tape recorder, works a little differently. When you digitally record the sound, the level of the signal is measured (or “sampled”) thousands of times per second, and each number is recorded as a number in memory. If the same signal that was shown in the analog recording illustration above was recorded digitally, it would look like this:

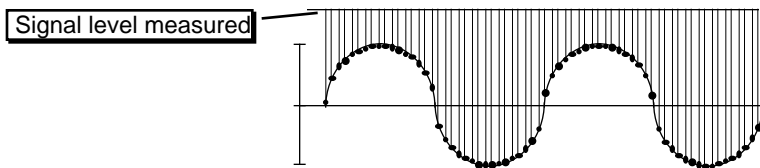

The digital sampler does not record the actual sound but rather encodes a series of discrete numbers, each of which represents the level of the signal at a given instant in time.

On playback, the ASR-10 reconstructs the original signal by “connecting the dots,” producing an output voltage that corresponds to the numbers in its memory (shown below). This voltage can then be amplified and sent to speakers, which turn it back into pressure waves in the air so that we can hear it.

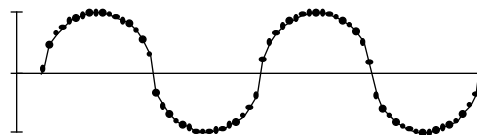

## Sample Rate

The sample rate determines how often the signal is measured (that is, how close together the dots would be in the illustration above). A sample rate of 30 kHz, for example, means that the ASR-10 is sampling the signal 30,000 times each second. A higher sample rate will yield a more accurate picture of the waveform and better high frequency response. But keep in mind that a higher sample rate also will use up the ASR-10 memory more quickly, since you are generating more numbers per second that have to be stored in memory.

The ASR-10 can sample at either 30 kHz (actually 29,761.9 samples per second) or 44 kHz (44,100.0 samples per second). To give you some frame of reference, Compact Discs are also recorded at 44.1 kHz, and Digital Audio Tape (DAT) is recorded at 48 kHz. You can adjust the ASR-10 sample rate by changing the current effect algorithm on the FX Select • FX Bypass page.

**Note:** When the current system sample rate is 44.1 kHz, the Digital Output will provide direct digital audio output of the Main Output mix, when the optional DI-10 Digital I/O Board is installed.

## Aliasing

A digital sampler can only accurately record frequencies up to one half that of the sample rate. This frequency (half the sample rate) is known as the *Nyquist frequency*, named after the fellow who figured that out. Trying to sample sounds that contain frequencies above half the sample rate will result in *aliasing*, the creation of false (or “alias”) low-frequency tones, when playing the sound back.

Suppose we were to sample the wave from our previous example at a much lower sample rate (fewer times per second), like this:

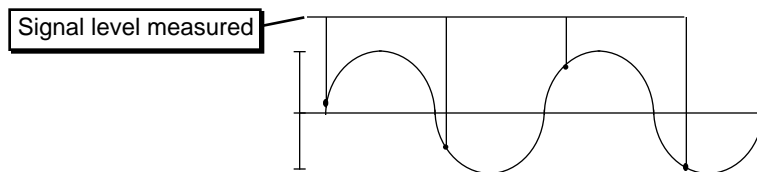

When the ASR-10 tries to reproduce this sound (to connect the dots, as it were) the resulting wave bears little resemblance to the original, because there are not enough sample points to accurately recreate it:

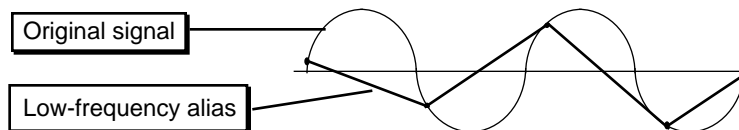

To prevent aliasing, the ASR-10 has a 64 times oversampling, one-bit Sigma-Delta, stereo A/D input converter, which offers superior audio fidelity.

## Getting Ready to Sample

Here are a few things you can do that will result in your getting better quality samples.

- **Start with the cleanest possible signal** — This may seem obvious, but a sample (or any recording) can only be as good as the original signal, so you should pay attention to the signal path. For example, if you are feeding the audio input of the ASR-10 from a mixer, using a direct out from the individual channel is better than using an auxiliary send because there are fewer preamps (and thus less noise) in the chain. If you do use an auxiliary or a main send, make sure *only* the channel(s) you intend to sample are turned up in that send.
- **Record the sound on tape and sample from the tape** — This is not always possible, but it tends to yield better results because now the sound is repeatable. This is important when adjusting the input level — before sampling you can play the sound as many times as necessary, watching the meter and adjusting the level of the signal into the ASR-10, until you have just the right level — high enough to get the best possible dynamic range, yet low enough to avoid clipping. The other good reason for sampling from tape also has to do with repeatability. Suppose you are sampling a horn section live, directly into the ASR-10, and suddenly they play that one excruciatingly perfect note that you've been waiting for all your life. But after making the sample you discover that the input level was a little too high and the sample is clipped. Or, you want to put a slightly different EQ on it, or maybe some reverb. Unfortunately, you will never get them to play that note just the same way again, so the moment is lost. If you had it on tape, you could simply make your adjustments and sample it again.

## Easy Sampling

Let's try a simple one-shot sample. First we need a source. For example, a microphone — but any source, such as a synthesizer, the output of a mixer, a guitar, etc. could be used. That sound source should be connected to one of the Audio Input jacks of the ASR-10.

The rear panel Mic/Line switch is used to set the ASR-10's Audio Input to accept either a *line-level* signal (such as that from a mixer, guitar, or a synthesizer) when in the down position, or a *mic-level* signal (from a microphone) when in the up position.

Adjust the ASR-10 sample rate by changing the current effect algorithm on the FX Select • FX Bypass page (or select 23 VOICE 44K or 31 VOICE 30K to monitor the signal source dry). A higher sample rate will yield a more accurate sample with better high frequency response, but will use up memory more quickly. The ASR-10 can sample at either 30 kHz (actually 29,761.9 samples per second) or 44 kHz (44,100.0 samples per second).

To initiate sampling press the **Sample • Source Select** button to the right of the display. The display shows:

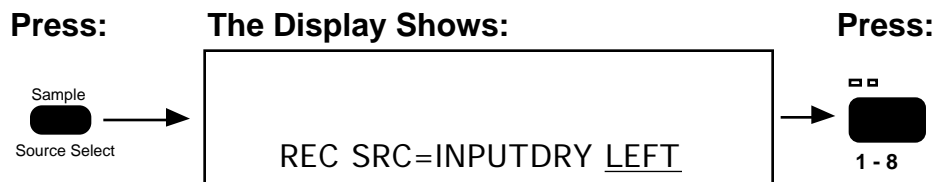

The RECORD SOURCE parameter has 2 fields. Field 1 determines which Audio Source will be sampled. Field 2 determines whether the Audio Source will be sampled in stereo or mono.

The available REC SRC Field 1 values are:

- **INPUTDRY** — This is the base setting, and it allows you to sample Audio Inputs dry (with no effect). **Audio Track A** monitors the left channel of the REC SRC, and **Audio Track B** monitors the right channel. You can hear how the dry signal will sound through the currently selected effect as it is monitored on the Edit/(audio) Track OUT bus.
- **INPUT+FX** — This value allows you to sample Audio Inputs wet (with the currently selected effect) on BUS1. All other voices are dry. Any WaveSamples, Instrument•Sequence Tracks or Audio Tracks that were routed to BUS1, 2, or 3 will all show OUT=DRY- -FX BUS IN USE on their Edit/Amp or Edit/Track, OUT bus screens.

When REC SRC= INPUT+FX, the ESP chip is dedicated to processing the Audio Inputs, and the audio tracks monitor the direct output of the ESP chip. The left effects channel is monitored on **Audio Track A** and the right channel on **Audio Track B**. The Wet/Dry mix is set on the Edit/Effects page. Note that when the current effect is gain-dependent (for example distortion or compression), the effect output may not sound the same as it would if REC SRC= INPUTDRY. This happens because when the REC SRC= INPUT+FX, the audio input source is routed directly into the effects processor at full level. To compensate, adjust the volume of the external audio source.

- **MAIN-OUT** — This allows you to resample any ASR-10-generated audio routed to OUT BUS1, 2, or 3. In VU mode, instruments can be Selected and Stacked in any combination before sampling. The “pile” is playable from the keyboard, or via MIDI. You can also press **Play** to start the sequencer and sample sequences and songs. The current effect also remains unchanged. For the optimal signal-to-noise ratio, the Volume Slider should be at maximum when sampling the MAIN-OUT.

**Tip:** When REC SRC= MAIN-OUT, you can use the volume slider in real time to sample volume fade-ins and outs.

**Tip:** After sampling the MAIN OUT, the Edit/Amp BOOST parameter is automatically set to ON in order to match the level between the original WaveSample and the resampled WaveSample. As a final step, after you're happy with the resampled results, you can further optimize the WaveSample by setting the Edit/Amp BOOST parameter to OFF, and performing the Command/Amp NORMALIZE GAIN command.

- **DIGITAL** — Sample the Digital Input (requires the optional DI-10 Digital I/O interface). If no digital interface is installed, this setting is not available.

The available REC SRC Field 2 values are:

- **LEFT** — Sample the LEFT channel of the REC SRC in MONO
- **RIGHT** — Sample the RIGHT channel of the REC SRC in MONO
- **L+R** — Sample both the LEFT and RIGHT channels of the REC SRC simultaneously in STEREO

### Using the Audio Tracks During Sampling

Pressing the **Audio Track** buttons will also change the REC SRC Field 2 value to reflect the current combination of selected Audio Tracks. For instance, if you press the **Audio Track A** button, the REC SRC Field 2 value changes to LEFT. If you press **Audio Track B**, the REC SRC Field 2 value changes to RIGHT. If you press **Audio Track A** and while holding it down press **Audio Track B**, the REC SRC Field 2 value changes to L+R. When both Audio Tracks are selected (both yellow LEDs lit), holding one **Audio Track** button and pressing the other one will change the REC SRC Field 2 value to LEFT. Both Audio Tracks will become Source Monitor disabled (no red LEDs lit).

For more information about Selecting, Enabling, and Disabling Audio Tracks, see *Section 12 — Sequencer and Audio Track Concepts*.

**Note:** Whenever the **Sample • Source Select** button is pressed, the current FX settings remain unchanged.

Once you've selected the Record Source field values for your signal source, press either an unloaded (no red LED lit) **Instrument • Sequence Track** button (the recommended way to select a destination Instrument) or press the **Enter • Yes** button. If the **Enter • Yes** button is pressed, the display will ask:

PICK SAMPLE INSTRUMENT

- Press an unloaded (no left red LED lit) **Instrument • Sequence Track** button. If you select an **Instrument • Sequence Track** where there is already an instrument loaded, the ASR-10 will display the multisampling screen. Don't do that yet.

After you've pressed an unloaded **Instrument • Sequence Track** button, the ASR-10 goes into Level-Detect (or VU) mode:

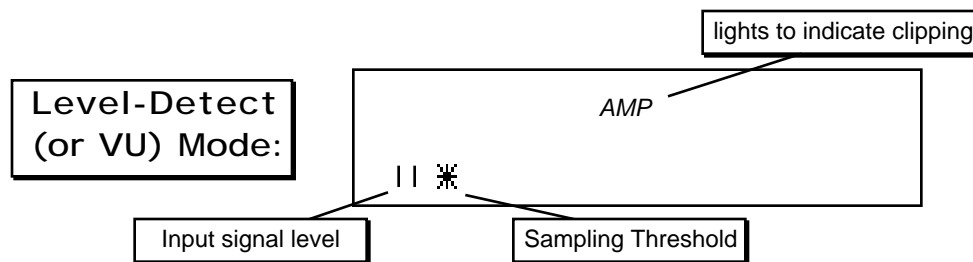

In Level-Detect mode the display acts like a peak-reading VU meter. The vertical bars on the display lighting from left to right show the level of the incoming signal. The *star* represents the sampling threshold — the ASR-10 will not begin recording until the signal crosses this level. The sampling threshold provides a way to make the ASR-10 “wait” until the signal reaches a certain level before it begins to record. The ASR-10 offers twenty possible sampling threshold levels. Pressing the **Up Arrow** button raises the threshold; pressing the **Down Arrow** button lowers it.

The AMP indicator light will flash if the input source clips (i.e. if the dynamic range of the input source exceeds the 96 dB dynamic range of the ASR-10).

**Tip:** While in Level-Detect Mode, you can select, deselect and stack (double-click) **Instrument • Sequence Tracks**, and can play them from the keyboard and/or via incoming MIDI, even during sampling. You can also press **Play** and **Stop • Continue** to sample along with sequence playback, or even to sample sequence playback when REC SRC= MAIN-OUT. This way, what you are about to sample can “sync-up” to what you've already sequenced or sampled (pitch, timing, etc.). If you scroll right or left to view any of the other sampling screens, you will only hear the destination instrument (the instrument into which you are sampling).

Before you proceed, there are a number of sampling parameters you can adjust. These parameters are explained in detail in *Section 8 — Sampling/Signal Source Parameters*.

### Setting the Input Level

As mentioned previously, optimizing the input level is crucial in sampling. Record at too low a level and you don't use all the bits of resolution that are available in the system — the sample will be too quiet and overly noisy. Record at too high a level and you will introduce clipping, which tends to be extremely harsh and unpleasant. For the sake of this and the examples that follow, we will assume that you are using an input signal from a repeatable source, such as a tape player, record, CD or synthesizer, whose level you can adjust.

- When REC SRC= INPUTDRY or INPUT+FX, the software VU meter is supplemented by two hardware Signal and Peak Input Level LED meters. These two dedicated Input Level meters provide separate Left/Right metering of the Audio Input levels, pre-FX, at all times. The green Signal LEDs light at -24 dB. The red Peak LEDs light at 6 dB below clipping.

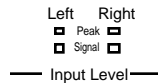

- Play the signal into the ASR-10. Watch the display to see if the AMP indicator lights (this light indicates overload, or clipping). If it does light, turn the signal down a bit. If the AMP indicator does not light when you play the sound, turn the signal up a little. Now play the sound into the ASR-10 again, watching the indicator and adjusting the signal accordingly.
- Repeat this until you have found the point just barely *below* where the AMP indicator lights. This is the optimum recording level. With a little practice you can quickly get a good level every time.

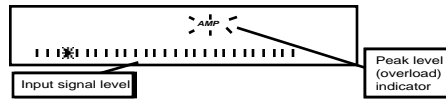

Once you have the level adjusted:

- Press **Enter•Yes** or press the Left Foot Switch to initiate sampling. The display will show WAITING... until the threshold is exceeded. During sampling the display shows:

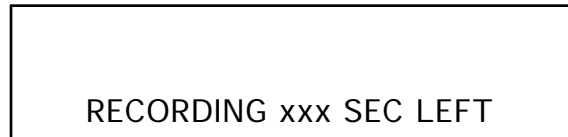

The xxx value (range 000 to 999) will count down in real time when sampling. Remember that if the sampling threshold (the star) is set higher than the input signal level (the vertical bars), the ASR-10 will not begin sampling until the input signal crosses the threshold. Pressing **Cancel•No** while the sampling screen reads WAITING... will abort sampling, and the ASR-10 will return to Level-Detect mode.

- Play the sound to be sampled; play the synth, start the recording, or speak into the microphone.
- Press **Cancel•No** or press the Left Foot Switch to stop sampling. If you don't stop it by pressing **Cancel•No** or the Left Foot Switch, the ASR-10 will continue sampling until it has used up all the available memory.

**Note:** In order to use the Left Foot Switch to start and stop sampling, the LEFT FOOT SW parameter on the Edit/System•MIDI page must be set to LEFT FOOT SW= SAMPL YES.

After you have stopped sampling (or the memory is full) the display will flash the following message:

PLAY ROOT KEY OR ENTER

The Root Key is the note on the ASR-10 keyboard from which the sample will play back at “unity” (the same pitch as the original input signal). Whichever key you press in response to the PLAY ROOT KEY OR ENTER prompt is the key that will play back exactly what you sampled.

**Tip:** You can also press the **Enter•Yes** button in response to the PLAY ROOT KEY OR ENTER prompt. This assigns the root key to the same number that the Edit/System•MIDI ENTER PLAYS KEY parameter is set to — allowing you to record samples without using the keyboard or MIDI input. Remember, you can assign different WaveSample ranges and change the pitch using the Edit/Instrument parameters.

### Normalizing Gain

After you've recorded a satisfactory sample, you should then perform the Command/Amp NORMALIZE GAIN command, to optimize use of the full dynamic range of the ASR-10. To do this:

- Press **Command**, then **Amp** and scroll until the display reads NORMALIZE GAIN.
- Press **Enter•Yes** to invoke the command. The display will read DATA BEING PROCESSED, followed by COMMAND COMPLETED.

For more information on the NORMALIZE GAIN command, see *Section 10 — Wave Data Parameters*.

### Default Output Routings

- When REC SRC= MAIN-OUT, and a new WaveSample is created, its Edit/Amp, OUT value will be set to BUS3 (Dry).
- When REC SRC= INPUT+FX, and a new WaveSample is created, its Edit/Amp, OUT value will be set to BUS3 (Dry).
- When REC SRC= INPUTDRY, and a new WaveSample is created, its Edit/Amp, OUT value will be set to the same value as the Edit/(audio) Track, OUT parameter for the Audio Track through which the RECORD SOURCE was monitored.
- When REC SRC= DIGITAL, and a new WaveSample is created, its Edit/Amp, OUT value will be set to the same value as the Edit (audio) Track, OUT parameter for the Audio Track through which the RECORD SOURCE was monitored.

## MultiSampling

Many sounds require that you make more than one sample, with each sample covering a different range of the instrument. This is because if you transpose a sound too far (up or down) from its original pitch it begins to sound unnatural. Another application for making multiple samples is when you are sampling something like a drum set, where you want several entirely different sounds on the keyboard at once.

The ASR-10 makes it easy to “multisample” — which is what we call this process of making several samples within one Instrument.

- Make your first sample as described above in “Easy Sampling.”
- Press the **Sample•Source Select** button.
- Press the **Instrument•Sequence Track** button of the instrument you just sampled.

When you select an existing instrument from the REC SRC screen, the following multisampling screen (also called the Sampling Context screen) appears:

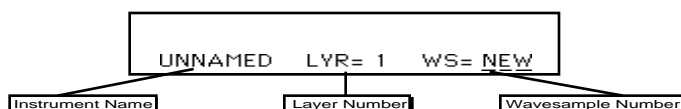

Here you see:

- The first eight letters of the instrument name (which is always UNNAMED for newly sampled sounds);
- The number of the current layer; and
- Which WaveSample will be sampled after you press **Enter•Yes**. The default here is NEW, meaning that a new WaveSample will be created in the same layer of the instrument.
- Press **Enter•Yes**. This puts you back in Level-Detect mode. Now proceed to sample the new WaveSample just as you did the first one:
- Adjust the incoming level so that it doesn't clip.
- Press **Enter•Yes** or the Left Foot Switch to begin sampling.
- Play the sound to be sampled.
- Press **Cancel•No** to stop sampling.
- Play the new Root Key — the key at which you want the new sample to play back.

Once you have assigned a Root Key to the new sample, the ASR-10 automatically adjusts the split point to be midway between the Root Keys of the two samples.

Follow the exact same procedure to continue making multiple samples within the instrument.



## Sampling Over an Existing WaveSample

Let's suppose you have made four multisamples of some instrument, and you want to go back and redo the third one. The procedure is almost the same as that for making a new multisample: instead of pressing **Enter•Yes** while **WS=NEW**, you will first pick one of the existing WaveSamples by playing it on the keyboard.

- Press **Sample•Source Select**, then select the instrument into which you want to sample. The multisampling screen appears as before.
- Move the cursor (underline) to **WS =\_\_**. The cursor should be beneath the WaveSample select parameter (**WS=\_\_**). If it's not, use the **Right Arrow** button move it there.
- Play the keyboard to select the WaveSample to redo. As you play notes you will see the word **NEW** replaced by the number of the WaveSample you are hearing. As you play different notes, the WaveSample number is updated. When you hear the one you want to redo, and see its number on the display, it is selected to be sampled over. Or you can scroll to the WaveSample number you want to redo using the **Up/Down Arrow** buttons, or the **Data Entry Slider**.

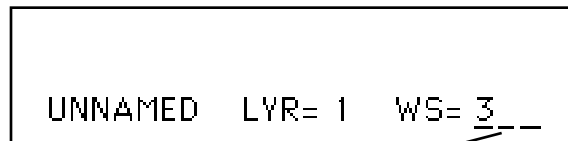

UNNAMED LVR= 1 WS= 3

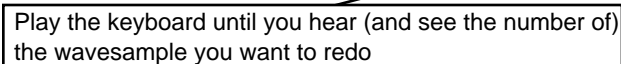

Play the keyboard until you hear (and see the number of) the wavesample you want to redo

- Press **Enter•Yes** and continue with sampling as before. The original WaveSample will be erased, and will be replaced by the new one.

When you sample over an existing WaveSample, the ASR-10 will preserve the keyboard range, all WaveSample parameters (envelopes, etc.) and, when possible, the loop points of the original sample.

**Note:** When you sample into a layer that already contains WaveSamples, the existing WaveSamples in that layer will not be audible if the Instrument is selected in **VU** mode.

## Stereo Sampling

The ASR-10 offers true stereo sampling, through Effects if desired. The ASR-10 also allows real time stereo resampling of notes played on the keyboard, or received via MIDI. Here's how to sample in stereo:

- Press the **Sample•Source Select** button. The display shows:

REC SRC=INPUTDRY L+R

When only one Audio Track is Selected, holding one Audio Track button and pressing the other one will change the REC SRC Field 2 value to L+R (as shown above), selecting both Audio Tracks and enabling stereo sampling. The Audio Track button that is held (i.e. pressed first) will become Solidly-Selected, and the other track will become Flashing-Selected. Now both Audio Tracks will operate as a paired (stereo) unit.

**Tip:** You can also use the Data Entry controls to select both Audio Tracks (L & R). ATRK-A (Audio Track A) will become Solidly-Selected, and ATRK-B (Audio Track B) will become Flashing-Selected.

Once you've selected the Record Source field values for your signal source, press either an **Instrument** button (the recommended way to select a destination Instrument) or press the **Enter•Yes** button. If the **Enter•Yes** button is pressed, the display will ask:

PICK SAMPLE INSTRUMENT

- Press an unused (no left red LED lit) **Instrument•Sequence Track** button. The ASR-10 goes into Level-Detect (or VU) mode:

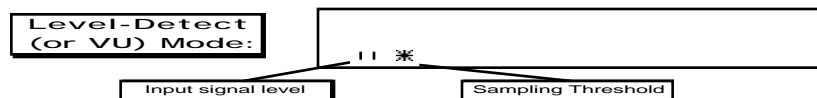

In this mode, when recording in stereo, the VU meter will monitor the louder of the two channels signals. Once you have the level adjusted:

- Press **Enter•Yes** or press the Left Foot Switch to initiate sampling. The display will show WAITING... until the threshold is exceeded. The AMP annunciator will light if the Input Source clips. During sampling the display shows:

RECORDING xxx SEC LEFT

The xxx value (range 000 to 999) will count down in real time when sampling. Press any button to stop sampling. Remember that if the sampling threshold (the star) is set higher than the input signal level (the vertical bars), the ASR-10 will not begin sampling until the input signal crosses the threshold. Pressing **Cancel•No** while the sampling screen reads WAITING will abort sampling, and the ASR-10 will return to Level-Detect mode.

- Play the sound to be sampled; play the synth, start the recording, or speak into the microphone.
- Press **Cancel•No** or press the Left Foot Switch to stop sampling. If you don't stop it by pressing **Cancel•No** or the foot switch, the ASR-10 will continue sampling until it has used up all the available memory.

After you have stopped sampling (or the memory is full), the display flashes **PLAY ROOT KEY OR ENTER**. The Root Key is the note on the ASR-10 keyboard from which the sample will play back at “unity” (the same pitch as the original input signal). Whichever key you press in response to the **PLAY ROOT KEY OR ENTER** prompt is the key that will play back exactly what you sampled. The samples you've just created are stored in companion layers.

**Tip:** You can also press the **Enter•Yes** button in response to the **PLAY ROOT KEY OR ENTER** prompt. This assigns C4 as the root key, and allows you to record samples without using the keyboard. Remember, you can assign different WaveSample ranges and change the pitch using the Edit/Instrument parameters.

### Companion Layers

Stereo Samples are stored in pairs of adjacent *Layers* (1&2, 3&4, 5&6, or 7&8), with the **LEFT** channel always stored in an odd numbered Layers (1, 3, 5 or 7), and the **RIGHT** channel stored across the same Key-Range in the next higher even numbered Layer. These are called *companion* layers.

The Edit/Layer parameter **STEREO LAYER LINK=xxx** is automatically set to **ON** after a Stereo Sample is recorded. When this parameter is turned **ON** in the selected Layer, it is simultaneously turned **ON** in the companion layer. When **STEREO LAYER LINK=ON**, simultaneous editing of both channels of a Stereo Sample is enabled (see below).

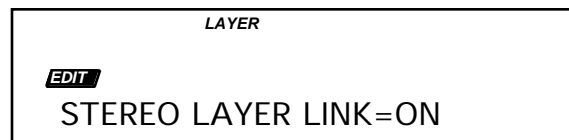

The Stereo Layer Link parameter is located at Edit/Layer screen address “99”, and can be quickly accessed by double-clicking the **Layer** button after pressing the **Edit** button.

- When **STEREO LAYER LINK=ON**, editing Layer or WaveSample parameters in one layer will edit the same parameters in the companion layer. Editing with the **Data Entry Slider** will set the current parameter in both layers to the same absolute value. Editing with the **Up/Down Arrow** buttons will edit parameter values in both layers relative to one another.
- When **STEREO LAYER LINK=OFF**, you can independently edit layers that contain one channel of a Stereo Sample.
- If the companion layer does not exist, **STEREO LAYER LINK** cannot be turned **ON** in the Selected Layer.

## Looping

One of the fundamental challenges of sampling is to make efficient use of the sampler's memory. You simply cannot sample the entire duration of every event. Plus, you usually want a sound to continue playing as long as you're holding the key down, regardless of how long the original event was. This is why we employ *Looping*.

When we loop a segment of sound, what we are doing is playing through to the end of the looped segment and then instantly starting back at the beginning of the loop, as if playing one continuous sound. It's a lot like a tape loop — a segment of recording tape with the two ends spliced together so that it cycles repeatedly.

Consider that a low note on a grand piano can last 30 seconds or more from the time the key is struck to the time it decays into silence. Sampling this entire event does not make sense because:

- You could use up all your sampling memory on one note, leaving no memory for multisampling; and
- After the initial attack transients die down, the sound of the piano string settles into what is essentially a repeating waveform. This means that you can select one cycle of this repeating waveform and *loop* it (play it over and over). All the data after the loop can then be removed (truncated) because you don't need it. This conserves memory.

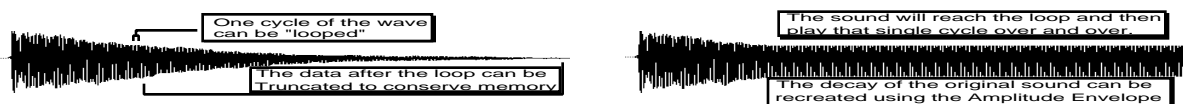

A piano, solo violin, guitar, or woodwind are all sounds that you could loop in this way. However, there are other sounds that do not settle into a repeating waveform. A full pipe organ, string section or a choir would be good examples of such sounds. These sounds remain extremely complex throughout their duration. Using a single-cycle loop on a choir sample would cause the sound to suddenly become very static and one dimensional when it reaches the looped section. These complex, ever-changing sounds require that we employ longer loops — repeating a large segment of the sound rather than just a single wave cycle.

Generally, successful loops fall into one of two categories — single-cycle loops, which we refer to as short loops, and loops of about a second or more, which we call long loops. Which type to use depends on the sound. If the sound settles into something relatively static, use a short loop. If the sound is composed of many elements that constantly chorus and interact with each other over time, you will need to use a long loop.

### Auto-Loop Finding

When you loop a sample, it is important that the beginning and end of the loop “match up” to form a continuous wave shape — otherwise the loop will pop or click each time it reaches the splice point. For this reason, the best loop points are those which occur where the wave crosses the zero line (called a “zero crossing”) and where the direction of the wave at the loop start matches that at the loop end.

The ASR-10 has a system parameter called AUTO-LOOP FINDING that, when ON, allows you to choose only loop start and loop end points which meet these criteria.

Press **Edit**, then **System • MIDI**, and scroll until the display shows AUTO-LOOP FINDING = <ON,OFF>, and set it to ON. Now, whenever you move the loop start of any WaveSample, the ASR-10 will automatically jump to the next zero crossing which matches the wave direction at the

loop end, and vice versa. This does not, in itself, guarantee a good loop but it will save you lots of time and trouble by ruling out all those splice points which definitely *won't* work.

### Short (Single-Cycle) Loops

As discussed previously, a short (single-cycle) loop is appropriate when the sustain portion of the sound is a more or less repeating wave. The best way to find out if a short loop is right for a given sound is to try it and see if it works. In fact, the best way to learn about looping generally is to experiment with moving both the loop start and the loop end around in a WaveSample and listening to the results.

There is a simple technique for finding a short loop. For this example we will sample some sound with a simple sustain, such as a clean guitar or bass sound, or a synth patch without a lot of chorusing.

First press **Edit**, then **System•MIDI** and make sure **AUTO-LOOP FINDING=ON**.

Next connect the signal source to the ASR-10 Audio In, set the input level, and sample the sound. After you have played the root key to conclude the sampling process, the ASR-10 puts you on the **Edit/Wave** page, which is just where you want to be to turn the loop on.

- Press the **Up Arrow** button twice to select **MODE=LOOP FORWARD**. Now hold down a key and listen to the sound. The default settings for a new WaveSample are **LOOPSTART=00%**, **LOOPEND=99%**, meaning that the whole sample is currently looping over and over.
- Scroll right to the **LOOP START** parameter, underlining the coarse adjust (the number to the right, in parentheses). Use the **Data Entry Slider** to move the loop start up, past the beginning of the sound. Try a setting of (25) to start. This puts the loop start 25% of the way into the WaveSample. Play the sound and listen.
- Scroll right to the **LOOP END** parameter, again underlining the coarse adjust (the number in parentheses) which should be at (99). Use the **Data Entry Slider** to move the loop end down as far as it can go. It will stop at (25) or wherever you set the loop start to, because you cannot adjust the loop end before the loop start. The loop start and loop end are now at the same place in the WaveSample. Play the sound. When it hits the loop, it will go supersonic because the ASR-10 is trying to loop on just one sample.
- Scroll two steps to the left to select the loop end fine adjust (the number just after **LOOPEND=**). Press the **Up Arrow** button once and play the sound. The pitch of the loop should be a little lower—you have moved the loop end away from the loop start to the first potentially good splice point.
- Press the **Up Arrow** button again and listen to the sound. With each press of the **Up Arrow** button, the pitch of the loop should go down as the ASR-10 moves the loop end to the next zero crossing. Keep pressing the **Up Arrow** button, one press at a time, until the loop sustains at the same pitch as the sound before the loop. This is a single-cycle loop.
- After you've found a good loop, you should move the sample end back to the same point as the loop end, then truncate the WaveSample to reclaim the memory that is no longer needed. (**TRUNCATE WAVESAMPLE** is found on the **Command/Wave** page.)

## Adjusting Loop Position

Before truncating the WaveSample, you may decide that the loop occurs too early in the sound (before all the attack transients have died down) or too late (wasting memory). The ASR-10 has a way to move the whole loop (start and end) around while keeping its relative length intact.

- While still on the EDIT/Wave page (press **Edit**, then **Wave** if you are not) scroll until the display shows LOOPPOS= ## (##). This is the loop position parameter. The number shown here is that of the loop start, but adjusting this parameter will move both loop start and loop end together, leaving the length (and thus the pitch) of the loop unaffected.
- Underline the loop position coarse adjust (the number in parentheses) and try moving the loop position around while listening to the sound. Find the place where the loop works most naturally with the rest of the sound. Note that you might have to readjust the loop end slightly after moving the loop position, particularly if the sound has pitch variations in it.
- Again, once you've found a loop you like, move the SAMPLE END back to the loop end, and truncate the WaveSample.

## Long Loops

If a single-cycle loop doesn't work for a particular sound, try a longer loop. The idea is the same — a segment of the sound is repeated again and again, but the long loop encompasses many cycles of the sound. Long loops retain the tonal complexity and sense of "movement" in the original sound, and will therefore work better for sounds like vocals, strings, flutes, stacked synth sounds, etc.

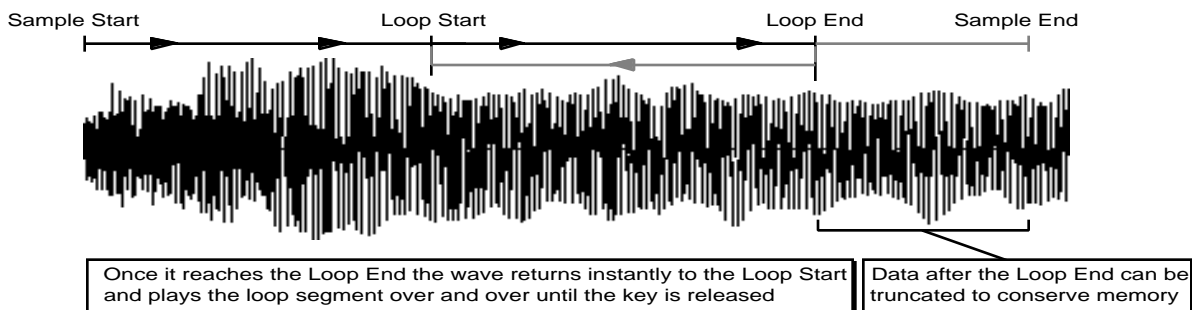

There is no one simple procedure for getting a perfect long loop every time — it all depends on the sound. Some sounds are easy to loop; other sounds seem to defy all attempts to find a good loop. Especially difficult to loop are those sounds whose timbre and volume change radically over time. You'll find, however, that the ASR-10 provides a wide variety of tools for getting the best possible results with even the most difficult sounds. By following the guidelines below (and not being afraid to experiment) you should be able to get an acceptable loop on virtually any sample.

- The AUTO-LOOP FINDING parameter should be on when looking for a long loop.
- Sample a sound, play the root key, and set the loop mode to MODE=LOOP FORWARD.
- Scroll to the LOOP START parameter, underlining the coarse adjust (in parentheses), and move the loop start forward past the initial attack of the sound. Try starting with a value somewhere between 15 and 40 percent. Hold down a key and listen to the loop.
- Scroll to the LOOP END parameter, again underlining the coarse adjust. While holding down a key, use the **Data Entry Slider** to move the loop end back towards the loop start. The closer to the loop start it gets (that is, the shorter the loop) the more noticeable the loop will sound. The idea is to find the shortest possible loop (to conserve memory) which doesn't sound obviously "looped."

- While holding down a key you can scroll back and forth between the LOOP START and LOOP END, changing the coarse and fine adjust for each, listening to how different parts of the sound loop.
- Most often you will find a loop that works fairly well except that the splice point is noticeable. In this case, try performing one (or more) of the cross fades contained on the Command/Wave page. Crossfading can smooth out the timbral differences between LOOP START and LOOP END, making the transition less abrupt.
- A loud bump or “pop” at the splice point usually indicates a volume difference between loop start and loop end. Try using the Command/Wave, VOLUME SMOOTHING command on the loop before doing a cross fade.
- Again, once you have a good loop, move the sample end back and then truncate the WaveSample.

# Section 8 — Sampling/Signal Source Parameters

This section describes the sampling and signal source parameters. For a general overview of the concepts involved, refer to the previous section.

## Sampling Parameters

There are a number of sampling parameters you can adjust. These parameters are accessed by pressing the **Left/Right Arrow** buttons while in Level-Detect mode. To enter Level-Detect mode:

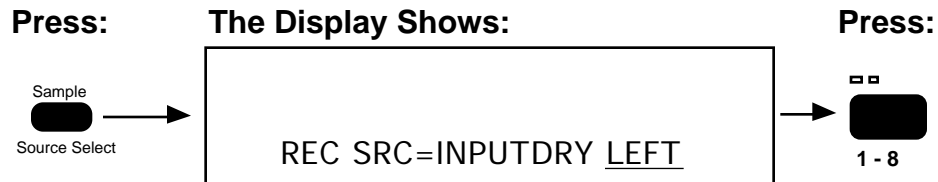

- Press the **Sample • Source Select** button to the right of the display. This is the Record Source parameter screen. The RECORD SOURCE parameter has 2 fields. Field 1 determines which Audio Source will be sampled. Field 2 determines whether the Audio Source will be sampled in stereo or mono. For more information about these fields, see *Section 7 — Sampling/Signal Source Concepts*.
- Press an unused (no left red LED lit) **Instrument • Sequence Track** button.

<i>Sample Inst•Track</i>	<b>SAMPLING THRESHOLD LEVEL</b>
	Press Sample•Source Select / Instrument•Sequence Track

After you've pressed an unused **Instrument • Sequence Track** button, the ASR-10 goes into Level-Detect (or VU) mode:

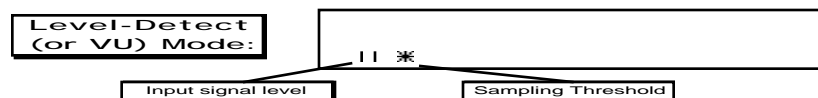

In Level-Detect mode, the display acts like a peak-reading VU meter. The vertical bars on the display lighting from left to right show the level of the incoming signal. The star represents the sampling threshold — the ASR-10 will not begin recording until the signal crosses this level. The Sampling Threshold provides a way to make the ASR-10 “wait” until the signal reaches a certain level before it begins to record. The ASR-10 offers 21 possible sample threshold levels.

### To Adjust the Sampling Threshold Level:

- Press the **Up Arrow** button to raise the threshold, or the **Down Arrow** button to lower it. When the sampling threshold is set to minimum (the star all the way to the left of the display) the ASR-10 will begin sampling as soon as you hit **Enter • Yes**. The higher (further to the right) you set the threshold, the higher the input signal will have to be before the ASR-10 begins recording.

**Tip:** By adjusting the sampling threshold level, you can avoid recording a lot of empty space (silence) at the beginning of your sample.



Sample Inst•Track	<b>SAMPLE RATE</b>
	Press Sample / Instrument•Track / Scroll using the Left/Right Arrow buttons

This read-only parameter shows the current system sample rate, as determined by the current effect on the FX Select•FX Bypass page. If you attempt to edit this parameter using the Data Entry Controls, the display shows either CURRENT EFFECT IS 30K or CURRENT EFFECT IS 44K.

Read-only Range: 29.7619 or 44.1000 KHZ

Now press the **Right Arrow** button again.

Sample Inst•Track	<b>PRE TRIGGER</b>
	Press Sample / Instrument•Track / Scroll using the Left/Right Arrow buttons

Range: 0 to 119 ms (30kHz) or 0 to 39 ms (for 44kHz)

This lets the ASR-10 start the sample *before* the sampling threshold is reached. The problem with using a high sampling threshold is that you can sometimes chop off low-level information at the beginning of the sound (below the threshold), making it sound clipped and unnatural. That's where the PRE TRIGGER parameter comes in.

The ASR-10 initially records the sample into a “buffer memory” of up to 119 milliseconds. You determine the length of this buffer with the pre trigger amount. Now when you press **Enter•Yes**, you get the benefits of being able to use a higher threshold without chopping off the beginning of the sound.

After the sampling threshold is reached, the ASR-10 will “back up” the SAMPLE START by the amount of the time selected in the PRE TRIGGER parameter. This allows sound just below the threshold level (which would otherwise be lost) to be retained, as shown below:

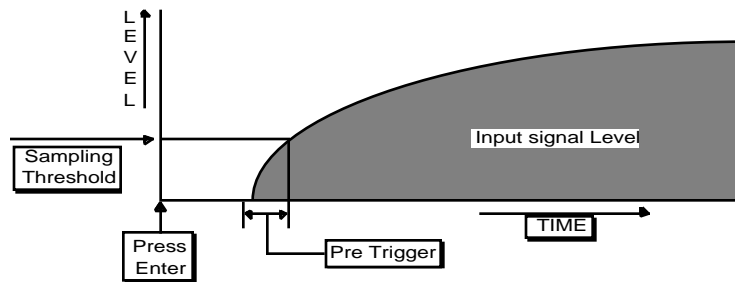

A pre-trigger amount of 10 to 20 ms should be adequate in most cases. You could set it higher to ensure that you don't miss any of the sound, or when using a very high sample threshold. In any case, a little silence in front of the sound is better than clipping it short, because you can later move the sample start forward to eliminate the dead space, and then truncate the WaveSample.

- Press the **Right Arrow** button again.

<i>Sample Inst•Track</i>	<b>SAMPLE TIME</b>
	Press Sample / Instrument•Track / Scroll using the Left/Right Arrow buttons

Range: Various

This tells you how much sampling time is available, taking into account the current system sample rate and the amount of free Internal Memory. This is a read-only parameter and can not be adjusted (though changing the system sample rate on the FX Select•FX Bypass page will cause this number to change).

- Pressing the **Right Arrow** button once more returns you to the Level-Detect mode.

## Additional Multi-Sampling Parameters

When you begin multi-sampling (making several samples within one instrument), there are three additional parameters that appear on the multi-sampling screen. These parameters allow you to record a new (additional) sample, sample over (replace) an already existing sample, or select a new/different layer within an already existing instrument.

Once you've recorded your first sample and you want to make a second sample within the same Instrument:

- Press the **Sample•Source Select** button.
- Press the **Instrument•Sequence Track** button of the instrument you just sampled.

When you select an existing instrument from the REC SRC screen, the following multi-sampling screen (also called the Sampling Context screen) appears:

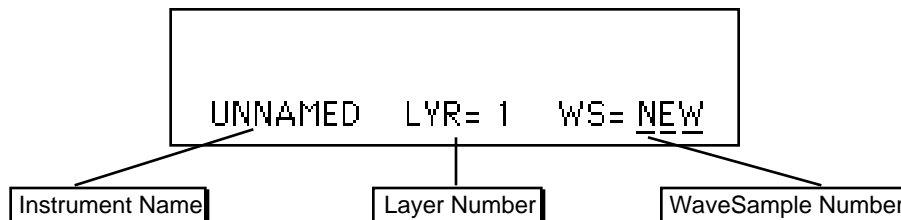

The multi-sampling parameters are:

- **Instrument Name** — The first eight letters of the instrument name (which is always UNNAMED for newly sampled instruments) are shown. This is a read-only parameter and cannot be adjusted.
- **Layer Number** — This parameter shows the number of the current layer. Use the **Left/Right Arrow** buttons to select this parameter, and the **Up/Down Arrows** to choose an already existing layer, or a new layer (LYR=N). Remember, each instrument can have up to eight different layers.

If you've recorded a stereo sample, the layer parameter will show either an **L** or an **R** following the layer number, indicating that they contain the **Left** or **Right** channels of a stereo sample.

- **WaveSample Number** — This parameter determines which WaveSample will be sampled after you press **Enter•Yes**. The default here is NEW, meaning that a new WaveSample will be created. You can however, select an existing WaveSample to sample over by using the **Up/Down Arrow** buttons, the **Data Entry Slider**, or by pressing a key on the keyboard.

When you sample over an existing WaveSample, the ASR-10 will preserve the keyboard range, all WaveSample parameters (envelopes, etc.) and, when possible, the loop points of the original sample.

**Note:** When an illegal layer (such as an existing mono layer) is chosen as the destination for stereo samples, the following message will be briefly displayed:

SELECT A STEREO LAYER

If no legal companion layers are available in the selected Instrument, the display will also show the above screen.

Select a legal layer and press **Enter • Yes** to return to Level-Detect mode.

# Section 9 — WaveSample & Layer Concepts

This section provides an overview of the concepts behind editing an ASR-10 WaveSample. For more detailed descriptions of the actual parameters, refer to the following section.

## ASR-10 Instrument Configuration

Each ASR-10 instrument consists of up to eight Layers, and up to 127 WaveSamples. Each WaveSample within an ASR-10 instrument consists of the following:

- a digital oscillator playing a wave from memory
- two multi-mode digital filters
- one LFO (Low Frequency Oscillator)
- one random NOISE generator
- three complex envelope generators for controlling pitch, filter, and volume
- a versatile matrix modulation scheme with 15 routable modulation sources

## About WaveSamples

The WaveSample is the most basic unit of sound within the ASR-10. A WaveSample can be anything — a drum, a note on a piano, a sound effect, or your voice. Each WaveSample has its own set of WaveSample parameter settings. Several WaveSamples can be grouped together to form Layers, and up to eight layers can reside within an instrument.

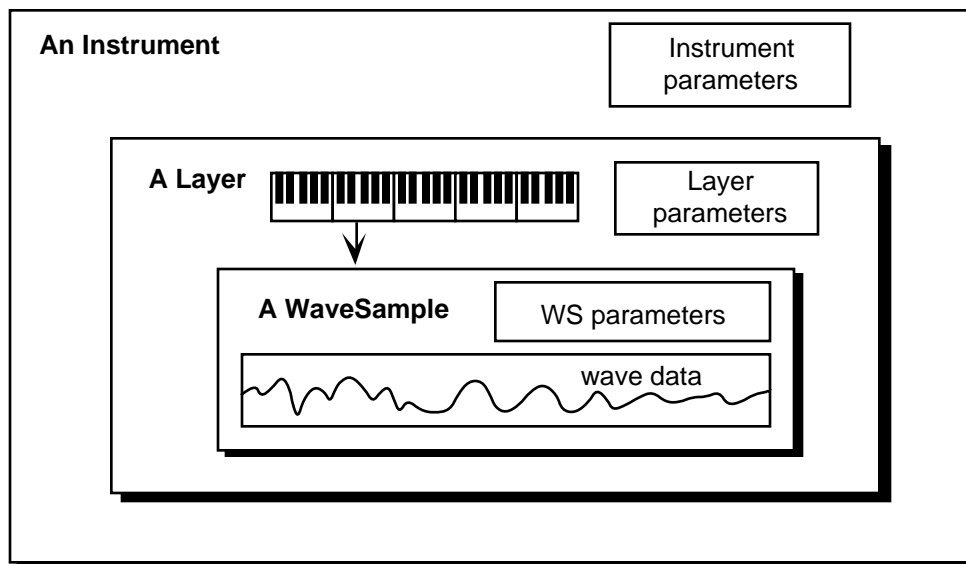

The diagram on the following page shows the configuration of one ASR-10 WaveSample.

### ASR-10 WaveSample Configuration

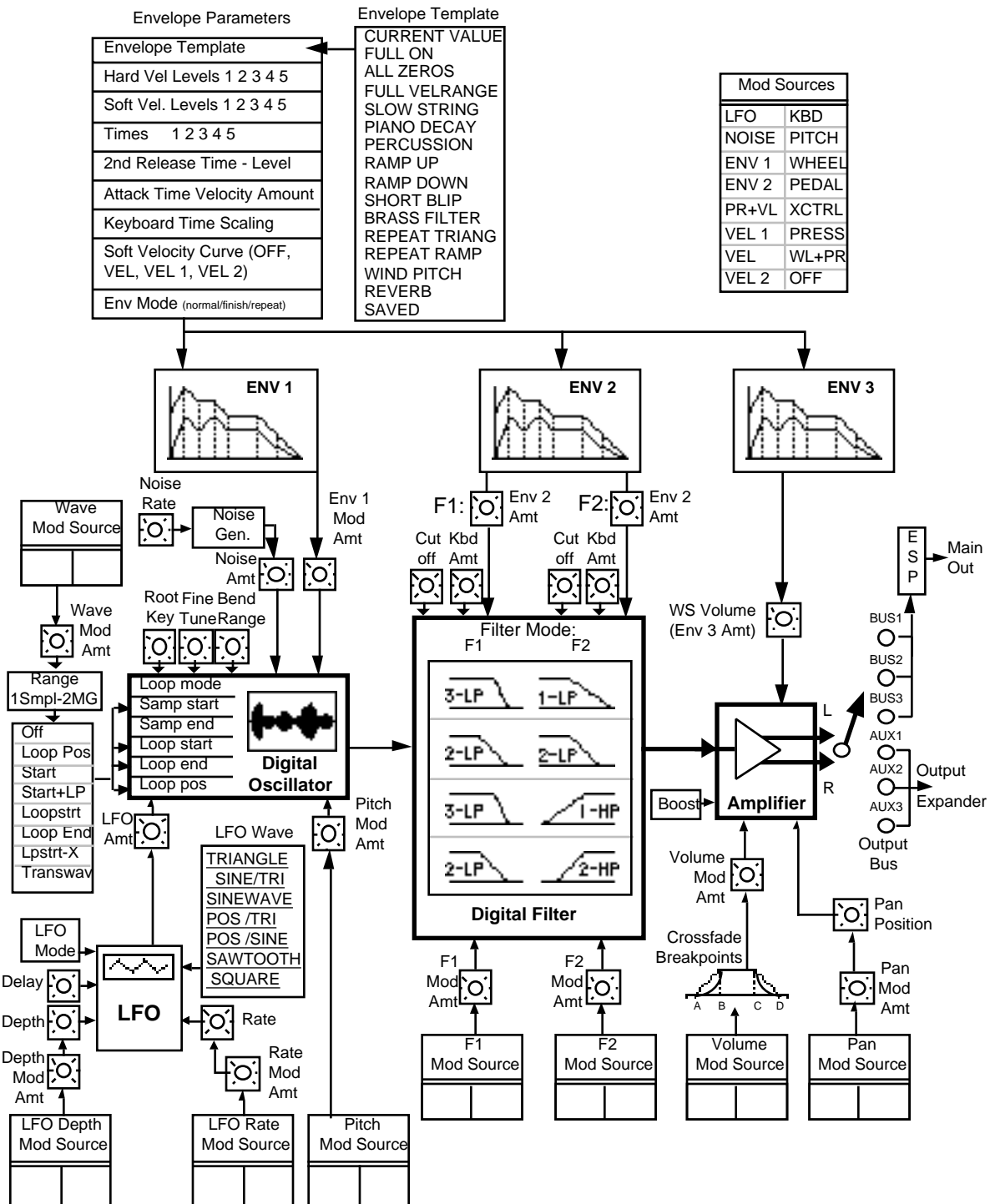

## Selecting a WaveSample or Layer for Editing (the Edit Context page)

In the next two sections of the manual, all the tools available for shaping a raw WaveSample will be covered. Almost all of these parameters and commands will require you to select either a WaveSample or layer for editing. The procedure for doing this is quite simple:

- Press the **Instrument • Sequence Track** button for the instrument you want to edit.
- Press the **Edit** button. The ASR-10 displays the Edit Context page:

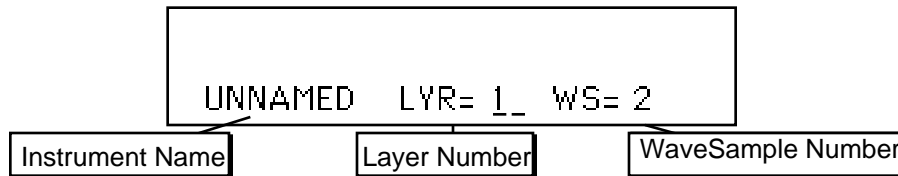

You see the currently selected instrument, layer (stereo or mono), and WaveSample.

- Press the **Left/Right Arrow** buttons to move the cursor (underline) until it is beneath the WaveSample Number (WS=\_\_\_).
- Play the keyboard to select the WaveSample you want to work on. When you play the keyboard, the WaveSample Number showing on the display will change as you as you play different WaveSamples. Whichever WaveSample Number is showing is considered the current “edit WaveSample” — the one that will be affected by any WaveSample Edit or Command functions.
- Pressing **Edit** again will return you to the last Edit page you were on. This lets you select a different WaveSample and then quickly return to the same parameter (SAMPLE START or END, for example) that you were editing.
- To perform editing on all WaveSamples in an entire layer, make sure the cursor is beneath the Layer Number (LYR=\_\_\_). The WaveSample Number reads WS=ALL. You can select the various layers within the instrument by using the **Data Entry Controls**. Only layers active in the current patch can be edited (active layers are displayed on the Edit/Instrument PATCH= parameter). If the layer number has an “L” or an “R” directly after it, then it is defined as a Left or Right stereo layer. Any edits to WaveSamples in a stereo layer will also affect the WaveSamples in its companion layer, even if the companion layer is not active in the current patch.
- To perform editing on all active layers and WaveSamples in an instrument, make sure the cursor is beneath the Instrument Name. The Layer Number reads LYR=A. Now any WaveSample parameter edits will affect all layers and WaveSamples in the current patch.
- When LYR=A or WS=ALL, the **Data Entry Controls** function as described below:

**Note:** When STEREO LAYER LINK= ON, editing layer or WaveSample parameters in one layer will edit the same parameter in the companion layer. Editing with the **Data Entry Slider** will set the current parameter in both layers to the same absolute value. Editing with the **Up/Down Arrow** buttons will edit parameter values in both layers *relative* to one another.

**Tip:** When the cursor is beneath the Layer Number on the Edit Context page, selecting any WaveSample Edit page, and pressing different keys, will display the parameter values for the WaveSamples assigned to that key range in the selected layer.

**Tip:** When editing any WaveSample parameter, pressing **Cancel • No** will reset the parameter to the value it was set to before it was edited.

## WaveSample Commands

There are many commands for working with WaveSamples and wave data. Rather than putting them all on one page, they are broken down into three pages.

The Command/Wave page contains the standard copy and delete commands for WaveSamples, plus several looping commands.

The Command/Amp and Command/LFO pages contain amplitude and wave data processing commands respectively. Some of these are fairly low-level operations that are rarely used. They are included for completeness.

**Note:** Always make sure the WaveSample you want to edit is selected on the Edit page.

### Messages

- **NO EDIT WS SELECTED** — go to the Edit page and select a WaveSample you want to work on.
- **WAVESAMPLE IS A COPY** — means the WaveSample you are editing is not an original, but a copy. If you press **Enter•Yes** in response to this message, the ASR-10 will take the data from the original WaveSample and copy it into the WaveSample you are editing. This will make the instrument you are editing larger. If this is undesirable, use the **WAVESAMPLE INFORMATION** command to find which WaveSample is the original. Then perform the command on the original.
- **LAYER NOT IN PATCH** — press **Edit**, then **Instrument** and select the correct layer. Use the **Arrow** buttons and enable the layer in the current patch.
- **SAMPLES NOT SAME SIZE** — means that the WaveSample is in a stereo layer, and its companion WaveSample is not the same size. This message is designed to prevent accidental damage to mono WaveSamples in stereo layers. If you're sure that you want to perform the command, press **Edit/Layer** and set **STEREO LAYER LINK= OFF**.
- **NO AUDITION - OK?** — when there is not enough free memory available for the Audition function to operate, this screen will appear. This is because the Audition function requires as much free memory as the size of the sample being processed. When processing samples in stereo layers, the Audition function requires *twice* as much free memory. If you press **Enter•Yes** in response to this message, the ASR-10 will execute the command *without* any audition. Pressing **Cancel•No** will abort the command.

**Note:** Wherever you see the notation ##, that symbol will represent the numeric value of a parameter whose setting or level is considered arbitrary to the subsequent discussion. For example, if **SCALE DEPTH= ## DB**, the ## represents the entire range of this parameter. You can use the **Data Entry Slider** or **Up/Down Arrow** buttons to explore the range of values.

### WaveSample Commands in Stereo Layers

When **Edit/Layer STEREO LAYER LINK= ON**, the wave data commands on the **Command/Wave**, **Command/Amp**, and **Command/LFO** pages will be simultaneously performed on the corresponding WaveSample in the companion layer.

## Modulators

### About Modulation

To modulate something is simply to cause it to change. Within the voice architecture of the ASR-10 we begin by setting basic, or manual, levels for the pitch, brightness, and volume of a voice, and we then modulate those levels in various ways to create movement and dynamics.

Suppose you switch on your stereo, and turn the volume half way up. We can call this the manual volume setting. It will stay at that level until it's changed. Now suppose that you take the volume knob of your stereo and begin quickly turning it up and down, so the volume gets continuously louder and softer, louder and softer. What you would be doing is modulating the volume of your stereo. Your hand would be the *Modulation Source* and volume would be the *Modulation Destination*. If you were to take the treble control, and do the same to that knob, you would be modulating the brightness of your stereo. In this case, brightness would be the *Modulation Destination*.

In much the same way we modulate various levels within the ASR-10 (though generally the approach is less haphazard). There are 15 different *Modulation Sources* (or modulators) available, and they can each be independently assigned to vary the manual levels for a great many aspects of a voice, including real time control of aspects of the current effects algorithm. The parameter that will be modulated by the modulator is called the *Modulation Destination*. In a stereo layer, the right channel will always use the modulation sources and destinations of the left channel.

### Selecting a Modulator

On those programming pages where a modulator can be selected to modulate a given modulation destination, the display shows MOD=\_\_ (short for Modulation Source). A modulator is chosen by selecting (underlining) the MOD= parameter with the **Left/Right Arrow** buttons, and then using the **Data Entry Slider** or the **Up/Down Arrow** buttons to select among the 15 available modulation sources.

**Tip:** Moving the **Data Entry Slider** all the way up selects OFF, which is handy if you don't want a modulator applied to a particular destination.

Let's take, for example, the Pitch Mod parameter, which is where you apply modulation to the pitch of a WaveSample (i.e. Pitch is the modulation destination). Press **Edit**, then **Pitch**. Next, press the **Right Arrow** button repeatedly until the following display appears:

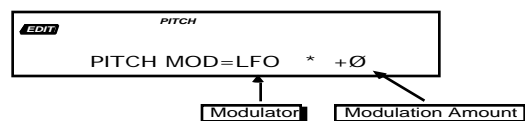

### Modulation Amount

As shown above, where a modulation source is selected, the parameter immediately to its right controls the *Modulation Amount* which controls how deeply the selected modulator will affect the level to which it is being applied.

Press the **Right Arrow** button to underline the Modulation Amount, and use the data entry controls to adjust it. Modulation amount can be positive or negative. A modulation amount of +00 has the same effect as turning the modulator OFF.



**Tip:** When editing any parameter that has a center value (+00), there is an easy way to reach that value. While holding down the **Down Arrow** button, press the **Up Arrow** button, then quickly release both buttons.

## Modulation Sources

The 15 Modulation Sources available on the ASR-10 are as follows:

- LFO - Low Frequency Oscillator
- NOISE - Noise Generator
- ENV 1 - Envelope 1
- ENV 2 - Envelope 2
- PR+VL - Pressure + Velocity
- VEL 1 - Convex Velocity Curve
- VEL - Linear Velocity Curve
- VEL 2 - Concave Velocity Curve
- KBD - Keyboard Tracking
- PITCH - Pitch Bend Wheel
- WHEEL - Modulation Wheel
- PEDAL - Voltage Control Foot Pedal
- XCTRL - External Controller (MIDI)
- PRESS - Pressure (After-touch)
- WL+PR - Mod Wheel + Pressure
- OFF - No Mod Source selected

- **LFO — Low Frequency Oscillator**

The *Low Frequency Oscillator* generates only very low frequency waves below the audio spectrum, which can produce vibrato, tremolo, and many other effects, depending on the LFO wave selected, and where it is applied as a modulator. There are seven possible waveshapes for the LFO.

- **NOISE — Noise Generator**

The Noise Generator produces a randomly changing level. It is useful for modulating, among other things, the pitch of a WaveSample (Edit/Pitch page). Applied to pitch with large modulation amounts it tends to create strange “computer sound” effects. Small modulation amounts (around +2 to +4) can create a subtle random movement in the sound, which can impart a more natural quality.

When STEREO LAYER LINK= ON, the NOISE modulation source in the right layer will be synchronized with the NOISE modulation source in WaveSamples assigned to the same or overlapping key zones in the left layer.

- **ENV 1, ENV 2**

The ASR-10 has three complex *Envelopes*. Envelopes are used to create changes over time in brightness, pitch, volume, etc.

- ENV 1 is permanently routed to the pitch of the WaveSample, though it can be assigned as modulator elsewhere if you wish.
- ENV 2 is permanently routed to the filter cutoff frequency. It also can be assigned as a modulator elsewhere.
- ENV 3 is a special case. ENV 3 *always* controls the volume of the WaveSample, and cannot be selected as a modulator.

- **PR+VL — Keyboard Pressure + Velocity**

This is one of two “combination” modulators. When this modulator is selected, both pressure and velocity will affect the modulation destination. After the note-on velocity has modulated the note played, pressing into the keyboard will change the modulator output set by velocity. After pressure has been exerted on the keyboard, pressure becomes the modulator until the note is released.

- **VEL 1, VEL, VEL 2 — Velocity**

Velocity means how hard you strike a key. Selecting VEL 1, VEL, or VEL 2 as a modulator allows you to modulate any manual level with velocity. Velocity as a modulation source only goes positive (though assigning a negative modulation amount will make the net result be to reduce the level with increased velocity). Each velocity modulator has its own response curve, shown below:

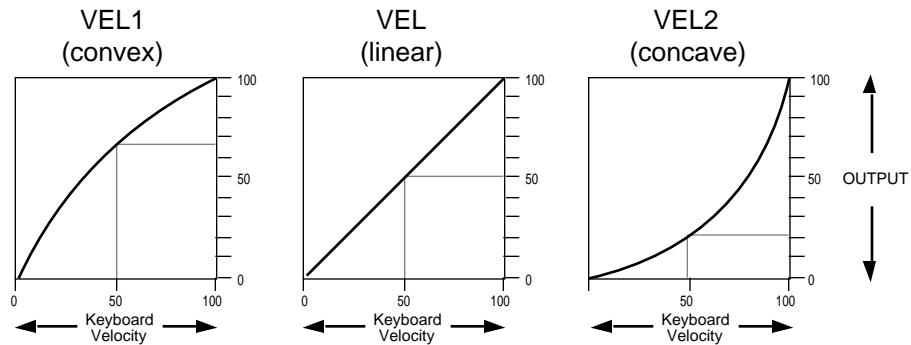

- **KBD — Keyboard Tracking**

This uses the position of a note on the keyboard as a modulator. The scaling effect of this modulator is figured over the full 128 MIDI key numbers:

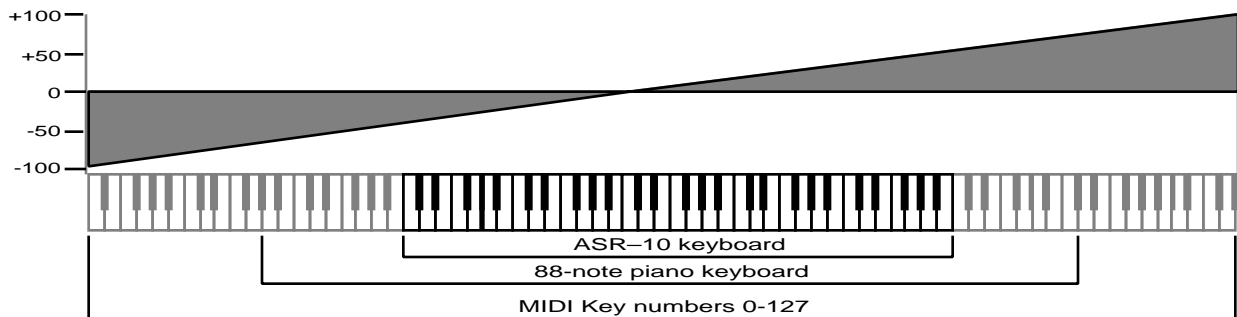

As the above illustration shows, the effect on KBD as the modulator goes negative as well as positive. The effect of KBD is to reduce the manual level of notes below the break point (middle C, C4, MIDI Note #60), and increase the manual level on notes above the break point. Negative modulation amounts will do the opposite.

- **PITCH — Pitch Bend Wheel**

This complex modulator groups the *Pitch Bend Wheel*, along with any other pitch modulators and pitch tables assigned to the instrument, to form a combined modulator. PITCH takes the amounts of each individual modulation source (as well as any pitch table information assigned to the instrument) and adds them together, taking the sum total as the modulation amount. Applied to the filter cutoff frequency for example, this would cause notes to become brighter as you bend them upwards and more muted as you bend them down (or the opposite with negative modulation amounts), in addition to the effect of any other filter cutoff modulators. If a pitch table was employed, the brightness would increase and decrease with the individual pitch assigned to each note, in addition to the effect of the pitch wheel and any other modulators. The value of the pitch bend wheel is 0 to 99, normally at the center (50% at rest).

- **WHEEL — Modulation Wheel**

The *Mod Wheel* to the left of the keyboard is assignable wherever a modulator is selected. To use the mod wheel for vibrato (one common application), WHEEL must be assigned to modulate the LFO, and the LFO Amount set to some number other than zero on the Edit/Pitch page. The mod wheel's effect is positive-going only, from 0 (wheel towards you) to +99 (wheel away from you). Negative modulation amounts will reverse the effect.

- **PEDAL — Voltage Control Foot Pedal**

This selects the optional *CVP-1 Foot Pedal*, which can be plugged into the Pedal•CV jack on the ASR-10 rear panel, as a modulator. Its effect is positive-going only, like the mod wheel. It can be applied wherever a modulator is selected.

Note that the Foot Pedal will only act as a modulator when the Pedal Function parameter is set to PEDAL=MOD on the Edit/System•MIDI page. When that parameter is set to PEDAL=VOL, the Foot Pedal will act as a volume pedal, not as a modulator (though this has no effect on incoming MIDI Foot Pedal data).

- **XCTRL — External Controller (MIDI only)**

An external controller (such as a Breath Controller, etc.) that is received via MIDI from another synthesizer or controller, can be assigned as a modulator within ASR-10 instruments. On the Edit/System•MIDI page, you can select the number of the external controller that will be recognized by the ASR-10.

**Tip:** You don't have to be playing the ASR-10 from an external instrument for this to work. For example, if you have a keyboard with a Breath Controller, do the following:

- Connect the breath controller's MIDI Out to the ASR-10 MIDI In.
- Make sure both instruments have controllers enabled (Edit/System•MIDI page).
- Select Breath Controller as the external controller that will be received by the ASR-10 (XCTRL=02, also on the Edit/System•MIDI page).
- Assign XCTRL as a modulator for LFO level, Filter Cutoff frequency, or some other manual level within a WaveSample.
- Play the sound from the ASR-10 keyboard, while blowing into the Breath Controller connected to the sending instrument. The modulation will have the same effect as if you were playing from the sending instrument.

- **PRESS — Pressure (After-touch)**

Pressure, also called after-touch, is a modulator that varies a manual level within a voice depending on how hard you press down on a key or keys. After you have struck a key, and while the note is sustaining, continuing to press down harder on the key brings in pressure. The ASR-10 keyboard generates pressure, and by using this modulator you can add a tremendous amount of expression to your sounds without ever taking your hands off the keyboard.

Pressure comes in two varieties — *Poly-Key™* pressure (or Polyphonic pressure), which affects each note individually, and *Channel* pressure (or Mono pressure) which affects all notes that are playing when you exert pressure on any key. Either type of pressure is available on the ASR-10, and both types are received via MIDI.

The PRESSURE MODE parameter on the Edit/Instrument page determines which of the two types of pressure will be used by the instrument. When set to KEY or CHAN, the ASR-10 will generate the selected pressure type, and will receive both types via MIDI. This parameter can also be set to OFF, in which case the instrument will not respond to pressure internally, nor will it transmit or receive pressure via MIDI.

Note that not all instruments are necessarily programmed to respond to pressure. If pressure seems to have no effect when you play certain instruments, it is likely that the programmer did not assign pressure as a modulator anywhere within the instrument.

The effect of pressure as a modulator is positive going only, though assigning a negative modulation depth will cause increased pressure to reduce manual levels.

- **WL+PR — Wheel + Pressure**  
Another combination modulator. When selected, both the mod wheel *and* pressure will affect the modulation destination. This can be good for modulating LFO depth when using the LFO for vibrato. Either the Mod Wheel or Pressure can then be used to generate vibrato.
- **OFF**  
Modulation is disabled.

# Section 10 — Wave Data Parameters

This section covers the parameters and commands that relate directly to the wave data, including sample length, playback direction, volume commands, and looping. For an overview of the WaveSample Programming concepts, refer to the previous section.

## Edit/Wave Page

The parameters on this page control all the WaveSample pointers such as sample start, sample end, loop points, etc. Also on this page, you can choose the playback mode and set up modulation of the sample start and/or loop position.

<i>EDIT</i>	<b>MODE (WS Playback Mode)</b>
<i>WAVE</i>	Press Edit / Wave / 0

This parameter allows you to select one of five possible WaveSample playback modes.

- FORWARD-NO LOOP — The ASR-10 plays through the WaveSample once, from sample start to sample end.
- BACKWARD-NO LOOP — The ASR-10 plays through the WaveSample once, only in reverse, from sample end to sample start.
- LOOP FORWARD — The ASR-10 will play forward from sample start to loop end and return to loop start and will continue playing the loop while the key is depressed. Once the key is released the loop continues playing as the WaveSample envelopes away.
- LOOP BIDIRECTION — The ASR-10 will play forward from sample start. At loop end, the ASR-10 will play the WaveSample in reverse to the loop start, playing the loop section back and forth until the key is released.
- LOOP AND RELEASE — The ASR-10 will play forward from sample start and will continue playing the loop while the key is depressed. As soon as the key is released the ASR-10 will go into release mode from wherever it is and will keep playing until the end of the WaveSample, playing data after the loop. LOOP AND RELEASE works in conjunction with Envelope 3, which needs to have its MODE parameter set to FINISH and its time and level values adjusted properly.

<i>EDIT</i>	<b>SMPL START</b>
<i>WAVE</i>	Press Edit / Wave / 1

This parameter allows you to set the sample start point. To conserve memory, it's a good idea to move the Sample Start and Sample End to eliminate any "dead space" at beginning or end, and then truncate the WaveSample using the TRUNCATE WAVESAMPLE command on the Command/Wave page (later in this section).

When the SAMPLE START or SAMPLE END parameters are displayed on the Edit/Wave page there are two ways to adjust them — you can move in large steps by adjusting the percent setting, or move one sample at a time by choosing the fine adjust.

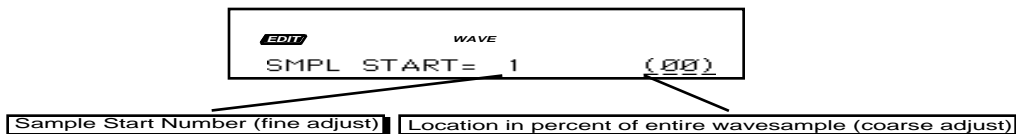

The Coarse Adjust reading is the one in parentheses. Changing this value will move the Sample Start in steps of one percent of the entire WaveSample. Use the **Data Entry Slider** or the **Up/Down Arrow** buttons to move the Sample Start ahead until the dead space is gone when you play.

Once you have gotten close using the percent setting, press the **Left Arrow** button to underline the Fine Adjust setting. Now the **Data Entry Slider** or the **Up/Down Arrow** buttons will move the SAMPLE START in small steps (less than 1%), letting you fine-tune its exact position while playing the sample.

EDIT WAVE	<b>SAMPLE END</b>
	Press Edit / Wave / 2

This parameter allows you to set the sample end point. Again you see the sample number (Fine Adjust) and the percent (Coarse Adjust). Use the data entry controls to edit this parameter in the same fashion as the SAMPLE START parameter.

## Loop Parameters

The LOOPSTART, LOOPEND, and LOOPPOS parameters all provide both Coarse and Fine Adjust values for adjusting the position of the loop.

EDIT WAVE	<b>LOOPSTART</b>
	Press Edit / Wave / 3

This parameter allows you to set the loop start point. After making a sample it is often necessary to “loop” (play over and over) a portion of the sound, so that it can sustain indefinitely when the key is held down. Getting a good loop tends to be the most difficult part of sampling.

Here are a few steps to get you started once you have sampled a sound that you want to loop:

- Turn ON the AUTO-LOOP FINDING parameter on the Edit/System•MIDI page: Press **Edit**, then **System•MIDI**, then scroll left to the parameter AUTO-LOOP FINDING. Make sure it is ON. When AUTO-LOOP FINDING=ON, every time you move the LOOP START or LOOP END points of a WaveSample, the ASR-10 picks only “optimized” loop points – ones most likely to work.
- On the Edit/Wave page, the MODE parameter determines whether the WaveSample will loop (among other things). Set it to MODE=LOOP FORWARD.
- Select the LOOP START parameter. Move the cursor to underline the Loop Start Percent value (the number in parentheses). While holding down a note, move it away from the beginning of the WaveSample (the 25% to 50% range is usually a good starting point).

LOOP START is used in conjunction with the next parameter.

EDIT WAVE	<b>LOOPEND</b>
	Press Edit / Wave / 4

This parameter allows you to set or change the loop end point. In addition to the Coarse and Fine Adjust values, the LOOPEND parameter also provides a fractional value (the number after the decimal point) that adjusts the end point of the loop by 1/16ths of a sample. This is especially helpful for fine-tuning short loops.

Move the cursor to underline the Loop End Percent value (in parentheses) and move it towards the beginning of the WaveSample, using the data entry controls to adjust in the same fashion as the LOOP START parameter. Move the LOOP START and the LOOP END around until you find the best sounding loop.

**Note:** The maximum loop length is 1.5 MegaWords.

**Tip:** There is a quick way to copy any of the SAMPLE START, SAMPLE END, LOOP START, and LOOP END parameter values from one parameter to another. This can eliminate the hassle of having to write the value down when, for example, you want the SAMPLE START to be set to the same value as the LOOP START, or vice versa. To use this function:

- Underline the value to be copied.
- Press the **Enter•Yes** button.
- Go to the parameter that you want to paste the copied value into (make sure this destination parameter value is underlined).
- Press the **Cancel•No** button.

<i>EDIT</i>	<b>LOOPPOS</b>
<i>WAVE</i>	Press Edit / Wave / 5

This parameter displays the LOOP START but moves both LOOP START and LOOP END, keeping the size of the loop the same. It lets you search for the perfect loop location after you've set up an optimal loop length.

<i>EDIT</i>	<b>MOD / SRC</b>
<i>WAVE</i>	Press Edit / Wave / 6 (Mod Type) 7 (Mod Source)

These parameters allow you to modulate certain parameters of the wave and select the mod source. The first parameter is WAVE MOD TYPE. This specifies which of the wave parameters the modulation will be affecting. There are seven possible MOD TYPES:

- OFF — Wave modulation is disabled.
- LOOP POS — Selecting this setting will modulate the loop position of the wave, moving it forward (towards the end of the wave) with positive values and backward (toward the beginning of the wave) with negative values.
- START — The SMPL START will be modulated.
- START+LP — Both the SMPL START and the Loop Position will be modulated. When START+LP is selected, sample playback will always begin at the LOOP START value, rather than at the SMPL START value.
- LOOPSTRT — Modulates the Loop Start parameter. This will have the effect of either making the loop shorter (by using positive modulation values to move the Loop Start point closer to the Loop End) or longer (negative values moving the Loop Start away from the Loop End).
- LOOP END — Works the same as LOOPSTRT, but from the back end.
- LPSTRT-X — This setting works the same as LOOPSTRT, but a pitch correction scheme is now employed to keep the pitch constant as the loop gets longer and shorter.
- TRANSWAV — Similar to LOOP POS, but the loop will move in increments of exactly one loop length. For example, with LOOPSTART at 0 and LOOPEND at 100, positive modulation will cause the loop to jump to LOOPSTART 100, LOOPEND 200, and then LOOPSTART 200, LOOPEND 300, etc. When this setting is selected, the MOD RANGE parameter (see below) has no effect, but the MOD AMOUNT (also below) sets the number of “jumps” that will happen over the full range of the controller (MOD SRC).

Any of the 15 ASR-10 modulation sources can be used as the SRC (Modulation Source) for the wave modulation.

<i>EDIT</i>	<b>MOD AMT / RANGE</b>
<i>WAVE</i>	Press Edit / Wave / 8 (Mod Amount) 9 (Mod Range)

Use these parameters to set the amount of wave modulation selected with the previous parameter. The wave modulation amount has two components:

- MOD AMT — This determines the amount of modulation that will be added to the wave parameter specified in the WAVE MOD TYPE parameter. This parameter has a value range of -99 to +99, allowing both positive and negative modulation amounts.
- RANGE — This portion of the parameter determines range that will be covered by the MOD AMT. This range is displayed in sample size. The reason for this is due to the nature of sampled instruments. Where on a synthesizer you would have waves or oscillators that had a defined length that was always the same, with samplers the wave size is always different from instrument to instrument, due to the sample time and rate at which each was sampled. The MOD AMT has no way of knowing this sample size, so the ASR-10 uses the RANGE to tell it.

Range: 1 Sample to 2 MegaSamples

To determine what size to set the RANGE parameter, go to the SAMPLE END parameter and look at the Sample End number. This number tells you how large the selected sample is in size. You can then select the RANGE value that comes closest to the actual size of the sample.

If you were working with a very small sample you would adjust the wave modulation amount to something like this MOD AMT=+99 RANGE=128. If you were working with a much larger sample you would adjust the wave modulation to MOD AMT=+99 RANGE=1 MG (MegaSample). Think of RANGE as a multiplier, and MOD AMT=-99 TO +99 as fine tuning.



## Command/Wave Page

<i>CMD</i>	<b>CREATE NEW WAVESAMPLE</b>
<i>WAVE</i>	Press Command / Wave / 0

A primary function of the ASR-10 is to create new WaveSamples by sampling external sound sources. However, the ASR-10 also can create a WaveSample without sampling. The CREATE NEW WAVESAMPLE command creates a small square-wave without sampling. This is useful as a tuning reference, or for experimenting with voice parameters on a static wave.

<i>CMD</i>	<b>COPY WAVESAMPLE</b>
<i>WAVE</i>	Press Command / Wave / 1

Use this command to make a copy of the currently selected WaveSample and its data, or a copy of its parameters only (when used within an instrument).

COPY WAVESAMPLE lets you apply different WaveSample parameter settings to the same wave data. You can copy the parameters and data of the original WaveSample, or just the parameters. When copying within an instrument, selecting PARAMS ONLY helps conserve memory.

- Select COPY WAVESAMPLE. Press **Enter•Yes**.
- The display reads TO INST=UNNAMED. Press an **Instrument•Sequence Track** button to choose the destination instrument (if necessary). Press **Enter•Yes**.
- The display reads TO LAYER=##. Using the **Up/Down Arrow** buttons, select a destination layer. Press **Enter•Yes**.
- Use the **Up/Down Arrow** buttons to select COPY=PARAMS ONLY or COPY=PARAMS & DATA. Press **Enter•Yes**. The display reads WAVESAMPLE ## CREATED.

<i>CMD</i>	<b>DELETE WAVESAMPLE</b>
<i>WAVE</i>	Press Command / Wave / 2

Use DELETE WAVESAMPLE to erase unneeded WaveSamples from an instrument in memory. For example, you can delete the drum sound WaveSamples that you don't need from a drum kit. Doing this can help you conserve memory.

- Be sure the WaveSample you want to delete is selected on the Edit page.
- Select DELETE WAVESAMPLE. Press **Enter•Yes**.
- The display will read DELETE WAVESAMPLE ##? If this is the WaveSample you want to delete, press **Enter•Yes**. If not, press **Cancel•No**.

**Note:** When STEREO LAYER LINK= ON, this command will be simultaneously performed on the corresponding WaveSample in the companion layer.

<i>CMD</i>	<b>WAVESAMPLE INFORMATION</b>
<i>WAVE</i>	Press Command / Wave / 3

You can use WAVESAMPLE INFORMATION to name a WaveSample; find out the sample rate; whether or not a WaveSample is a copy; and what the root key is. The WAVESAMPLE INFORMATION command is used primarily for reference, and is useful for keeping track of things when you are developing sounds.

- Select WAVESAMPLE INFORMATION. Press **Enter•Yes**.
- The display reads WS NAME=#####. Use the data entry controls to name the WaveSample as you would any other file. Press **Enter•Yes**.
- The display reads SAMPLE RATE=##KHZ. You can now use the **Up/Down Arrow** buttons to change the sample rate at which the sample will play. Notice that changing the sample rate effectively changes the playback pitch as well. Press **Enter•Yes**.
- The display reads ROOT KEY=##. The **Up/Down Arrow** buttons will now change the root key. Press **Enter•Yes**.
- If the WaveSample is a copy, the display will read COPY OF LYR ## WS ##. This parameter is display only, and cannot be changed.

If you get the message, LAYER NOT IN PATCH, press **Edit**, then **Instrument**. Use the **Arrow** buttons to enable the layer in the current patch.

CMD	<b>TRUNCATE WAVESAMPLE</b>
WAVE	Press Command / Wave / 4

Truncating removes data before the sample start, and/or after the sample end at the same time. The memory formerly used by the truncated data is then returned to the available memory.

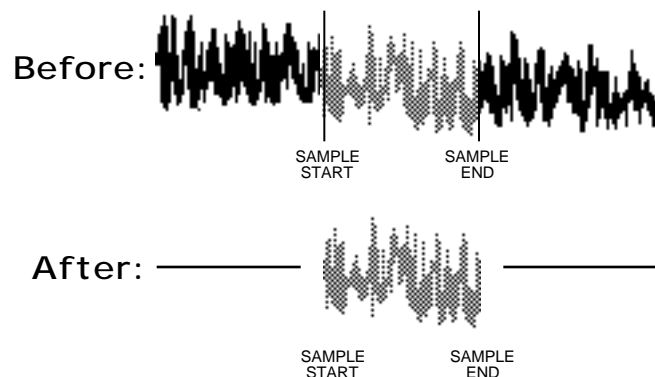

- Select TRUNCATE WAVESAMPLE. Press **Enter•Yes**.

**Note:** When STEREO LAYER LINK= ON, this command will be simultaneously performed on the corresponding WaveSample in the companion layer.

## About Loop Commands

In the following loop commands, the messages INCREMENT LOOPSTART, or DECREMENT LOOPEND may appear. When they do, the ASR-10 is letting you know there's a problem with the loop length. Try changing the FADE ZONE. You could also press **Edit**, then **Wave**, and adjust the loop points. To move the loop points one sample at a time, make sure AUTO-LOOP FINDING (on the Edit/System•MIDI page) is OFF.

**Note:** Whenever the KEEP=OLD NEW message appears, the ASR-10 is giving you the chance to "audition" the results of the operation, before you commit any changes to memory.

CMD WAVE	<b>CROSS FADE LOOP</b>
	Press Command / Wave / 5

The idea behind cross fading is to blend the data preceding the start of the loop with the data at the end of a loop, for a smooth transition between the two. The CROSS FADE LOOP command is a simple cross fade that works well with periodic waveforms that are relatively constant in tone. The default values are: SCALE DEPTH=3 dB; FADE ZONE=50%.

SCALE DEPTH determines the amount of volume drop that will have occurred in the original material at the halfway point of the cross fade. The material that is being added will follow an inverse curve, moving up to the same level at the halfway point. The result should be an even level of volume as the cross fade occurs.

The FADE ZONE determines the percentage of the loop over which the cross fade will occur. A setting of 99% would cause the cross fade to begin at the beginning of the loop. Lower values will start the fade nearer the *end* of the loop, causing the fade to occur in a shorter period of time.

Manual Ranges: FADE ZONE=1% to 99%; SCALE DEPTH=3 dB to 6 dB. With manual ranges, 3 dB will give you an exponential curve, while 6 dB is linear.

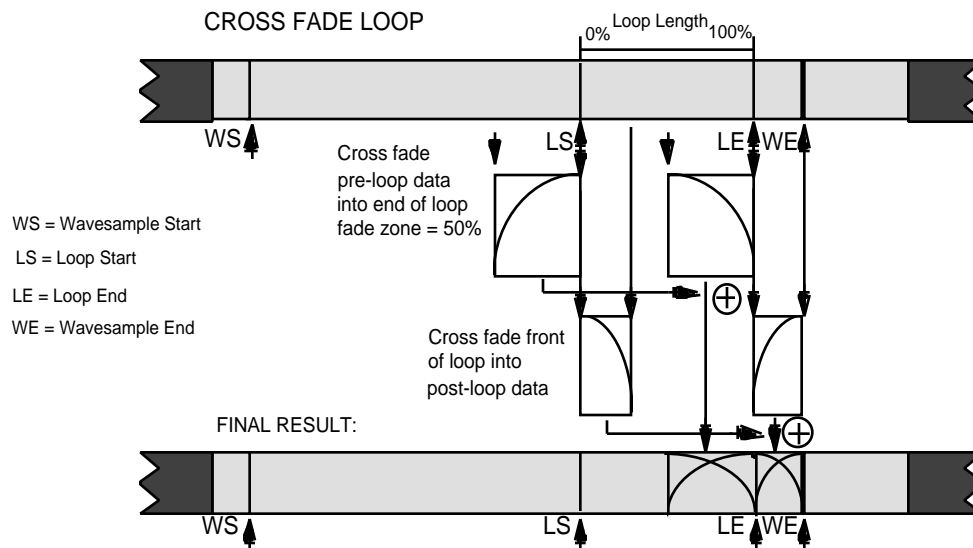

- Select **CROSS FADE LOOP**. Press **Enter•Yes**.
- The display reads **USE DEFAULT VALUES?** Press **Enter•Yes**.
- The display reads **KEEP=OLD/NEW**. Underline **NEW** and play the keyboard to hear the new loop, or underline **OLD** to hear the original. Underline **NEW** and press **Enter•Yes** to keep the new loop. Or, press **Cancel•No** to keep the old loop (the old loop will be kept no matter the location of the cursor).
- Pressing **Cancel•No** in response to **USE DEFAULT VALUES**, prompts the ASR-10 to display the manual values for this command. Use the **Left/Right Arrow** buttons to scroll to select: **SCALE DEPTH**=(3.0, 3.5, 4.0, 4.5, 5.5, or 6.0 DB) and **FADE ZONE (PERCENT)**=(1 to 99). Use the **Up/Down Arrow** buttons, or the **Data Entry Slider** to change the scale depth or fade zone. Press **Enter•Yes**.
- The display reads **KEEP= OLD/NEW**. Press **Enter•Yes** to complete the command (or **Cancel•No** to keep the original).

**Note:** When **STEREO LAYER LINK= ON**, this command will be simultaneously performed on the corresponding WaveSample in the companion layer.

CMD WAVE	<b>REVERSE CROSS FADE</b>
	Press Command / Wave / 6

The REVERSE CROSS FADE loop command helps eliminate tonal bumps, and smoothes out the tonal content of the loop. REVERSE CROSS FADE works well with multiple source sounds such as string sections, brass ensembles, and choirs. The default and manual values are the same as in the CROSS FADE LOOP command.

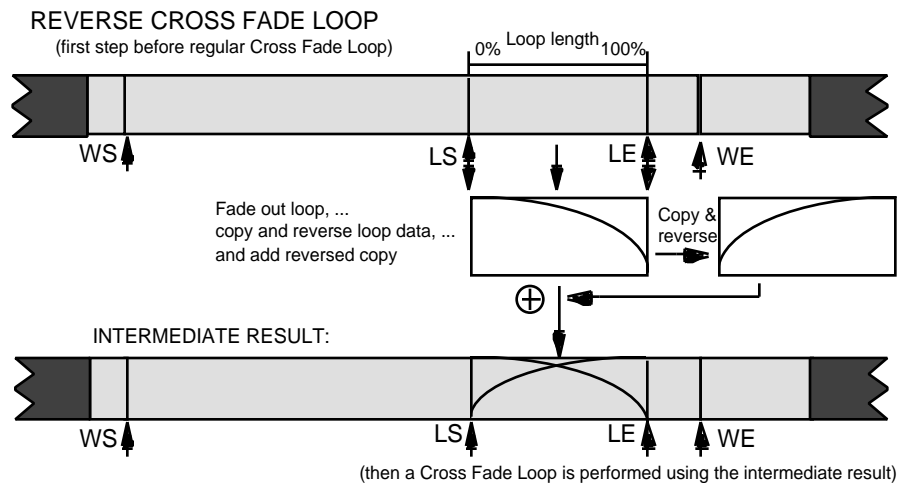

- Select REVERSE CROSS FADE. Press **Enter**•**Yes**.
- The screen will ask, USE DEFAULT VALUES? Press **Enter**•**Yes**.
- Pressing **Cancel**•**No** in response to USE DEFAULT VALUES, prompts the ASR-10 to display the manual values for this command. Use the **Left/Right Arrow** buttons to scroll to select SCALE DEPTH=## DB and FADE ZONE (PERCENT)=##. Press **Enter**•**Yes**.
- The display reads KEEP=OLD NEW. Press **Enter**•**Yes** to complete the command (or **Cancel**•**No** to keep the original).

**Note:** When STEREO LAYER LINK= ON, this command will be simultaneously performed on the corresponding WaveSample in the companion layer.

CMD WAVE	<b>ENSEMBLE CROSS FADE</b>
	Press Command / Wave / 7

ENSEMBLE CROSS FADE is essentially a cross fade loop with the FADE ZONE set to 100%. If you use the default values, the ASR-10 may tell you DEFAULTS CANNOT BE SET. Then it will advise, INCREMENT LOOP START or, DECREMENT LOOP END (Edit/Wave page). This is because the data preceding the loop is shorter than the loop itself. For ENSEMBLE CROSS FADE to work, the fade zone must be 100% of the loop length. You can either make sample start smaller so that you add more data preceding the loop, or move the loop around using loop position on the Edit/Wave page. The only manual value here is SCALE DEPTH which is the same as in the CROSS FADE LOOP command. The fade zone is not a parameter, because it is always assumed to be 100% of the loop length.

- Select ENSEMBLE CROSS FADE. Press **Enter**•**Yes**.
- The display reads USE DEFAULT VALUES? Press **Enter**•**Yes**.
- Pressing **Cancel**•**No** in response to USE DEFAULT VALUES, prompts the ASR-10 to display the manual values for this command. Use the **Left/Right Arrow** buttons to scroll to select SCALE DEPTH=## DB. Press **Enter**•**Yes**.

- The display reads KEEP=OLD/NEW. Press **Enter•Yes** to complete the command (or **Cancel•No** to keep the original).

**Note:** When STEREO LAYER LINK= ON, this command will be simultaneously performed on the corresponding WaveSample in the companion layer.

CMD	<b>BOWTIE CROSS FADE LOOP</b>
WAVE	Press Command / Wave / 8

The BOWTIE CROSS FADE LOOP command is used to equalize the data around the loop points so the transition in to and out of the loop splice point is very smooth. The BOWTIE CROSS FADE LOOP works well on sounds with a lot of ambience, reverb, or other effects. The FADE ZONE can never be greater than 50%, otherwise you will overlap data halfway through the loop. The BOWTIE CROSS FADE is limited by the length of the post-loop data (the data from loop end to WaveSample end).

If you truncate a sound with WaveSample end equal to loop end, you can not use the bowtie loop, because it needs some data after loop end to make the loop. There would not be enough post-loop data to follow the command. If this happens, the ASR-10 will advise, DECREMENT LOOPEND. For the bowtie you need to have the loop away from the ends of the WaveSample. You can decrement loop position in the same way you had incremented it for the ensemble cross fade.

The default values are the same as the cross fade. Manual value ranges are: FADE ZONE (PERCENT): 1% to 50%; SCALE DEPTH: 3.0 dB to 6.0 dB.

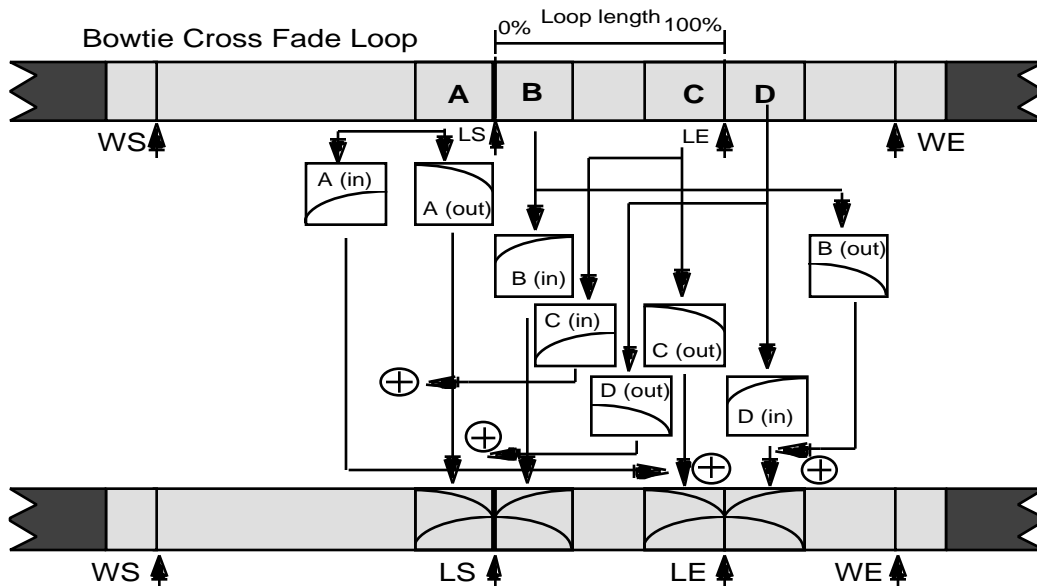

- Select BOWTIE CROSS FADE LOOP. Press **Enter•Yes**.
- The display reads USE DEFAULT VALUES? Press **Enter•Yes**.
- Pressing **Cancel•No** in response to USE DEFAULT VALUES, prompts the ASR-10 to display the manual values for this command. Use the **Left/Right Arrow** buttons to scroll to select: SCALE DEPTH=## DB, and FADE ZONE (PERCENT)=##. Press **Enter•Yes**.
- The display reads KEEP=OLD/NEW. Press **Enter•Yes** to complete the command (or **Cancel•No** to keep the original).

**Note:** When STEREO LAYER LINK= ON, this command will be simultaneously performed on the corresponding WaveSample in the companion layer.

CMD WAVE	<b>BIDIRECTIONAL X-FADE</b>
	Press Command / Wave / 9

BIDIRECTIONAL X-FADE is optimized for use with bidirectional loops. One advantage of the bidirectional loop (which you can select by setting MODE= LOOP BIDIRECTION on the Edit/Wave page) is that it makes a loop that sounds twice as long as the amount of data being used. It does this by playing the loop forward and backward. As a result, the bidirectional loop is very memory conservative and is best suited for ensemble sounds that have a slowly modulated sustain, such as the bowing in a string section.

The default and manual values are the same as the cross fade. It is very important to remember that the loop points should be adjusted with autolooping off. Unlike other looping algorithms that look for a “zero crossing,” BIDIRECTIONAL X-FADE works best when the loop points are set to the peaks in the waveform.

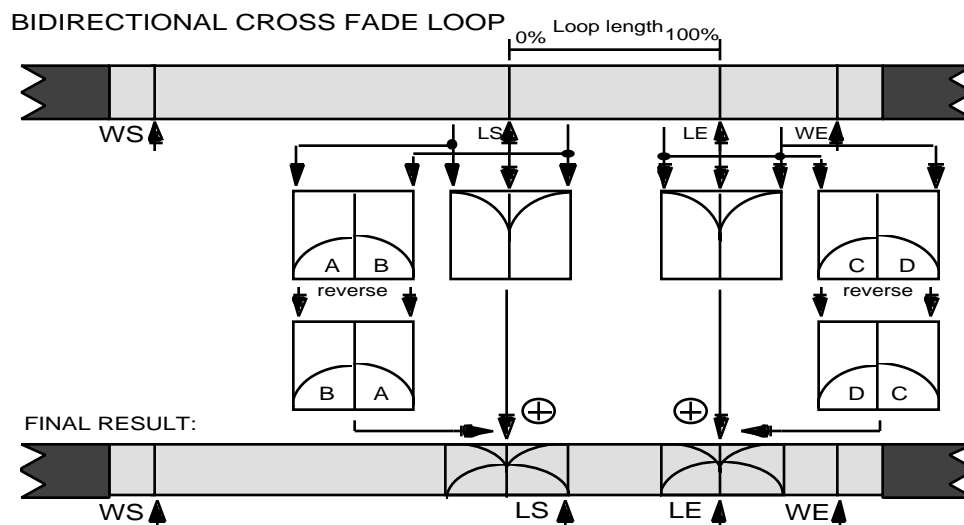

- Select BIDIRECTIONAL X-FADE. Press **Enter**•**Yes**.
- The display reads USE DEFAULT VALUES? Press **Enter**•**Yes**.
- Pressing **Cancel**•**No** in response to USE DEFAULT VALUES, prompts the ASR-10 to display the manual values for this command. Use the **Left/Right Arrow** buttons to scroll to select: SCALE DEPTH=## DB, and FADE ZONE (PERCENT)=##. Press **Enter**•**Yes**.
- The display reads KEEP= OLD/NEW. Press **Enter**•**Yes** to complete the command (or **Cancel**•**No** to keep the original).

**Note:** When STEREO LAYER LINK= ON, this command will be simultaneously performed on the corresponding WaveSample in the companion layer.

## A Note About the COPIES WILL CHANGE Message

When using the following MAKE LOOP LONGER, SYNTHESIZE LOOP, or CONVERT SAMPLE RATE commands, you should select only the layer that contains the WaveSample you want to work on. If there are copies of the WaveSample you are editing elsewhere in the instrument, the ASR-10 will display the following message:



For instance, if you try to execute the CONVERT SAMPLE RATE command and the COPIES WILL CHANGE-OK? message appears, it is possible the conversion may produce apparent pitch problems while the Audition page is displayed. This is because the pitch parameters haven't been converted yet. However, they will be converted once you decide to choose KEEP=NEW. With the MAKE LOOP LONGER and SYNTHESIZE LOOP commands, the loops may sound odd until you choose KEEP=NEW.

CMD WAVE	<b>MAKE LOOP LONGER</b>
	Press Command / Wave / scroll using the arrow buttons

If you are having a hard time getting a satisfactory loop—after you've tried the other looping commands—try making the loop longer. This process physically enlarges the loop, making the periodicity of the loop less noticeable. However, there is a trade-off: longer loops use more memory. The default and manual values are the same as in the CROSS FADE LOOP command. *This is not recommended for bidirectional loops.*

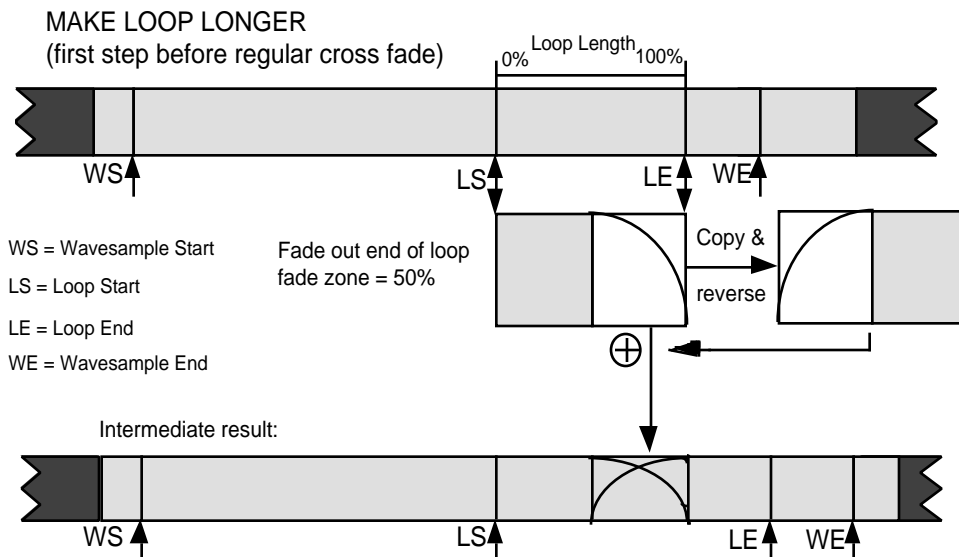

- Select MAKE LOOP LONGER. Press **Enter•Yes**.
- The display reads USE DEFAULT VALUES? Press **Enter•Yes**.
- Pressing **Cancel•No** in response to USE DEFAULT VALUES, prompts the ASR-10 to display the manual values for this command. Use the **Left/Right Arrow** buttons to scroll to select: SCALE DEPTH=## DB, and FADE ZONE (PERCENT)=##. Press **Enter•Yes**.
- The display reads KEEP=OLD/NEW. Press **Enter•Yes** to complete the command (or **Cancel•No** to keep the original).

**Note:** When STEREO LAYER LINK= ON, this command will be simultaneously performed on the corresponding WaveSample in the companion layer.

CMD WAVE	<b>SYNTHESIZED LOOP</b>
	Press Command / Wave / scroll using the arrow buttons

This is the looping algorithm to use when all other looping techniques have failed to make a smooth loop. Unlike the other looping algorithms, the “synth loop” uses a certain amount of random data processing. It’s a “loop anything” algorithm, which works well with special effects. With the SMOOTHNESS parameter, the smoother the loop, the more processes the ASR-10 goes through to create the synth loop. For example, if you do synth loop on a voice sample, and the SMOOTHNESS is set to very coarse, it may create a loop that sounds irregular or nervous. At the other extreme, if the setting is too fine, it may sound metallic. The default values are the same as in the CROSS FADE LOOP command. Manual values: FADE ZONE=1% to 99%. SMOOTHNESS=Very Fine to Very Coarse.

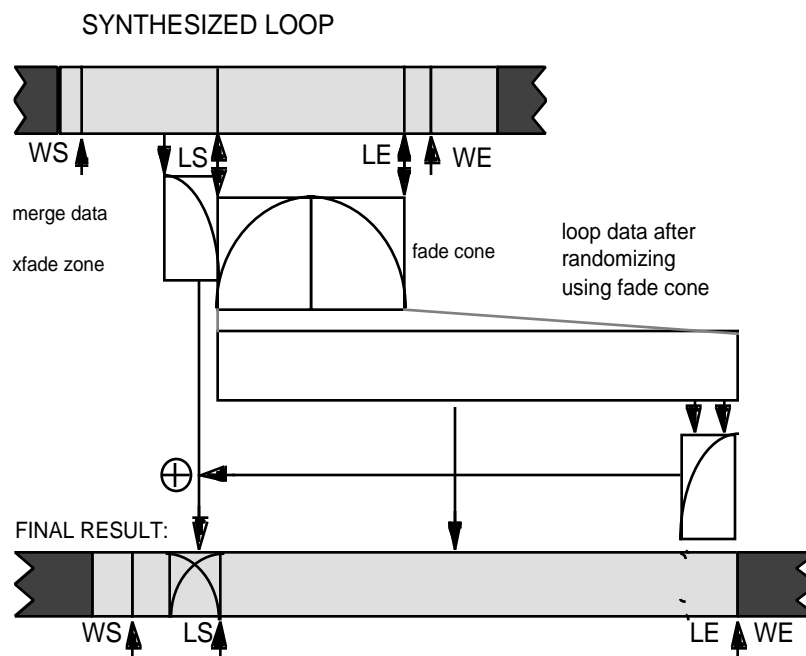

- Select SYNTHESIZED LOOP. Press **Enter**•**Yes**.
- The display reads USE DEFAULT VALUES? Press **Enter**•**Yes**.
- The display reads KEEP=OLD NEW. Press **Enter**•**Yes**.
- Pressing **Cancel**•**No** in response to USE DEFAULT VALUES, prompts the ASR-10 to display the manual values for this command. Use the **Left/Right Arrow** buttons to scroll to select: FADE ZONE (PERCENT)=##, and SMOOTHNESS=VERY FINE, FINE, MEDIUM, COARSE, VERY COARSE. Press **Enter**•**Yes**.
- The display reads KEEP=OLD NEW. Press **Enter**•**Yes** to complete the command (or **Cancel**•**No** to keep the original).

**Tip:** If you’ve done all you can to create a smooth sounding loop, and there are still irregular volume changes, try setting LOOP START and LOOP END (on the Edit/Wave page) to different values, and redoing this command.

**Note:** When STEREO LAYER LINK= ON, this command will be simultaneously performed on the corresponding WaveSample in the companion layer.



CMD WAVE	<b>CONVERT SAMPLE RATE</b>
	Press Command / Wave / scroll using the arrow buttons

This command effectively resamples a WaveSample at a different sampling rate. You can start sampling with a high rate, then if you need more memory later, you can convert to a lower sample rate. The ASR-10 lets you compare these conversions before committing them to memory. When you convert from a higher to a lower sample rate, it's like transposing the WaveSample up the keyboard: you play fewer samples and the sound is shorter. Conversely, a lower to a higher sample rate has the effect of transposing down the keyboard: the sound gets bigger, and stretches out.

Range: 48.0 kHz to 6.25 kHz.

- Select CONVERT SAMPLE RATE. Press **Enter•Yes**.
- The display reads SAMPLE RATE=## KHZ. Use the **Data Entry Slider** or **Up/Down Arrow** buttons to select a new sample rate. Press **Enter•Yes**.
- The display reads KEEP=OLD NEW. Press **Enter•Yes** to complete the command (or **Cancel•No** to keep the original).

**Note:** When STEREO LAYER LINK= ON, this command will be simultaneously performed on the corresponding WaveSample in the companion layer.

CMD WAVE	<b>TIME COMPRESS/EXPAND</b>
	Press Command / Wave / scroll using the arrow buttons

The TIME COMPRESS/EXPAND command shortens or lengthens the WaveSample duration, without affecting pitch. This is useful for “stretching” a WaveSample to fit a particular tempo, for example. To use this command:

- Press the **Enter•Yes** button after choosing a WaveSample to be edited. The display shows:

<b>CMD</b>	STOP
WAVE	
AMOUNT=100.00 PERCENT	

Range: 50 to 250

Values less than 100 shorten the duration, and values greater than 100 lengthen the duration.

- Press **Enter•Yes**, or scrolling right will display the QUALITY screen:

<b>CMD</b>	STOP
WAVE	
QUALITY = 99	

Range: 0 to 99

Higher values offer better fidelity on the compressed/expanded WaveSample, however, it takes longer to process this command.

**Tip:** Set the QUALITY parameter to 0 (or a low level) when checking the duration time for your particular application. This allows you to quickly verify that the time duration is correct, because it takes the least amount of time to process the data. When you know the exact duration amount, set the QUALITY parameter to 99, for the best fidelity.

- Pressing **Enter•Yes** from the QUALITY screen will execute the Command. The display will read:

<b>CMD</b>	WAVE	STOP
xx PERCENT DONE		

Range: 0 to 99

The xx value field counts up in real time. Pressing **Cancel•No** will abort the command.

If the selected WaveSample is a copy of another (or if there are copies of this WaveSample), the following screen will appear:

<b>CMD</b>	WAVE	STOP
COPIES WILL CHANGE-OK?		

- Pressing **Enter•Yes** will take you to the PERCENT DONE screen, as explained above.

**Note:** When STEREO LAYER LINK= ON, this command will be simultaneously performed on the corresponding WaveSample in the companion layer.

CMD	<b>COPY WAVE PARAMETERS</b>
WAVE	Press Command / Wave / scroll using the arrow buttons

This command will copy all the WaveSample parameters (but not the wave data) from a source WaveSample to a destination WaveSample. All the parameters (envelopes, filters, amp, pitch, mod parameters, etc.) are copied from the source WaveSample to the destination WaveSample, except for the actual sample pointers (sample start/end, loop start/end) and root key.

- Select COPY WAVE PARAMETERS. Press **Enter•Yes**.
- The display reads TO INST=## L=## WS=##. Select the destination instrument, layer, and WaveSample. The current (or Edit) WaveSample is used as the source.
- Press **Enter•Yes**. The display reads COMMAND COMPLETED.

## Command/Amp Page (Amplitude Commands)

<i>CMD</i>	<b>NORMALIZE GAIN</b>
<i>AMP</i>	Press Command / Amp / 0

This command maximizes the dynamic range of a WaveSample. NORMALIZE GAIN always works on the currently selected WaveSample (selected on the Edit page) and has no parameters. It will make the sound louder, unless it is already at full level. NORMALIZE GAIN finds the largest sample value, and uses that to scale the whole range of the sample to its absolute full level.



Press **Enter•Yes** to invoke the command. The display will read DATA BEING PROCESSED, followed by COMMAND COMPLETED.

**Note:** When STEREO LAYER LINK= ON, this command will be simultaneously performed on the corresponding WaveSample in the companion layer.

For more information, see **Managing Headroom** in *Section 1 — Controls and Architecture*.

<i>CMD</i>	<b>VOLUME SMOOTHING</b>
<i>AMP</i>	Press Command / Amp / 1

VOLUME SMOOTHING works like a dynamic compressor. The idea is to remove amplitude changes. The degree to which it does this is determined by “smoothness.” It works on a given range of sound, determined by the start and end address parameters. This command is very useful for smoothing out a loop, and getting rid of clicks caused by volume bumps.

For instance, if you are working with a piano loop, there is a natural envelope that is always decaying. If you try to loop on the section that is decaying, the loop end data will be at a much lower amplitude than the beginning. You would end up with a click, because of an abrupt change in amplitude. VOLUME SMOOTHING will help make the level constant. When the ASR-10 displays DATA RANGE TOO SMALL, it is advising you that the minimum range to perform this command is 256 samples.

This command is most useful for loops, but you can use it on the whole sample. If you wanted to remove a natural envelope from a piano, for example, you can use volume smoothing over the whole length of the sample. You can then superimpose any amplitude envelope from the ASR-10 over that sample. Value ranges: SCALE DEPTH=3.0 to 6.0 dB. SMOOTHNESS=VERY FINE to VERY COARSE.



- The display reads USE LOOP FOR RANGE? Press **Enter•Yes** to automatically set the start and end addresses to the loop points.
- Select START ADDR=## (##). Use the **Left/Right Arrow** buttons to scroll through the various screens. Use the **Up/Down Arrow** buttons to change the values in the display.
- Scroll to and select END ADDR=## (##). Scroll to and select the SCALE DEPTH=## DB. Scroll to and select the SMOOTHNESS=####. Press **Enter•Yes**.
- Select KEEP=OLD NEW. Press **Enter•Yes** to complete the command.
- Pressing **Cancel•No** for USE LOOP FOR RANGE? lets you adjust the start and end addresses manually.
- Select START ADDR=## (##). Scroll to and select the END ADDR= ## (##).
- Scroll to and select the SCALE DEPTH=## DB. Scroll to and select the SMOOTHNESS=####. Press **Enter•Yes**.
- The display reads KEEP=OLD NEW. Press **Enter•Yes** to complete the command (or **Cancel•No** to keep the original).

**Note:** When STEREO LAYER LINK= ON, this command will be simultaneously performed on the corresponding WaveSample in the companion layer.

## About Mix, Merge, and Splice

The MIX, MERGE, and SPLICE commands are very similar. You will always be working on a pair of WaveSamples—source and destination WaveSamples. These commands take a source WS and mixes, merges, or splices it into a destination WS. FR INST=## L=## WS=##, determines the source. TO INST=## L=## WS=## determines the destination. For best results the source and destination WaveSample should be in the same instrument, in different layers.

CONVERT SOURCE PITCH and CONVERT DEST PITCH let you combine WaveSamples that were sampled at different sample rates, or were on different root keys. If the WaveSamples are on the same root key, but have different sampling rates, their data will be different. The ASR-10 can't simply add them together because they would be out of tune with each other. It has to convert the sample rate of one or the other.

Before executing these commands, you should assign the layer containing the destination WaveSample to a different patch (on the Edit/Instrument page) than the patch containing the source. This way, when you “audition” the sound after the commands have been executed, you can specifically hear the final results of the operation, and not the final results and the source WaveSample together. This process is similar to that described in the COPY WAVESAMPLE command.

**Note:** When using the MERGE or SPLICE commands, the VOLUME BALANCE function only lets you hear the relative volumes of the source and destination WaveSamples, not the final results. You will be able to hear the final results after the WaveSamples have been merged or spliced. VOLUME BALANCE controls the relative volumes of the source and destination WaveSamples. When the value is negative, the source WaveSample is louder. And when the value is positive, the destination is louder.

CMD AMP	<b>MIX WAVESAMPLES</b>
	Press Command / Amp / 2

Mixing WaveSamples is a lot like layering two WaveSamples. It adds all of the wave data from the two WaveSamples together, resulting in a single composite WaveSample. For example, to make a “bowed voice,” you would assign the “bow” WaveSample to one layer, then the “voice” WaveSample to a different layer, and use “mix” to combine them digitally into one WaveSample.

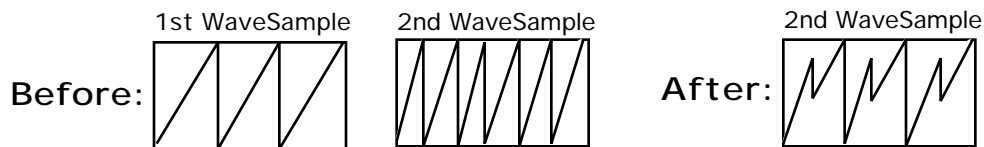

- Select MIX WAVESAMPLES. Press **Enter•Yes**.
- The display reads ARE SAMPLES LAYERED? Press **Enter•Yes**.
- Select FR INST=## L=## WS=##.
- Scroll to TO INST=## L=## WS=##.
- Scroll to CONVERT SOURCE PITCH, or CONVERT DEST. PITCH. Press **Enter•Yes**.
- Scroll to VOLUME BALANCE=(-99 to +99). Use the **Data Entry Slider** to set the balance between the two.
- Press **Enter•Yes**. The display shows KEEP=OLD/NEW. Press **Enter•Yes** to keep the mixed WaveSamples, or **Cancel•No** to keep the originals intact.

CMD AMP	<b>MERGE WAVESAMPLES</b>
	Press Command / Amp / 3

MERGE WAVESAMPLES takes source wavedata, and cross fades it into destination wavedata. MERGE WAVESAMPLES has many of the same parameters as MIX, with the addition of SCALE DEPTH and FADE ZONE. The SCALE DEPTH and FADE ZONE operate the same as with the cross fade command.

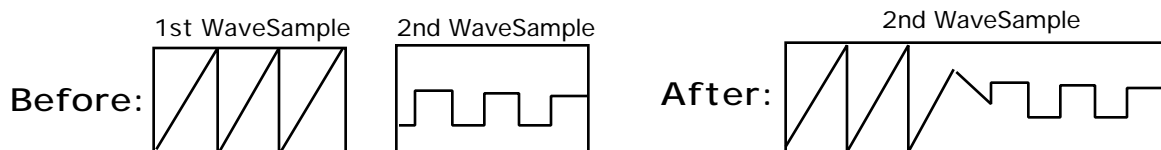

- Select MERGE WAVESAMPLES. Press **Enter•Yes**.
- The display reads ARE SAMPLES LAYERED? Press **Enter•Yes**.
- Select FR INST=## L=## WS=##. Scroll to TO INST=## L=## WS=##.
- Scroll to SCALE DEPTH=## DB. Scroll to FADE ZONE (PERCENT)=##.
- Scroll to CONVERT SOURCE PITCH or CONVERT DEST. PITCH.
- Scroll to VOLUME BALANCE=##. Press **Enter•Yes**.
- The display reads KEEP=OLD/NEW. Press **Enter•Yes** to keep the merged WaveSamples, or **Cancel•No** to keep the originals intact.

<i>CMD</i>	<b>SPLICE WAVESAMPLES</b>
<i>AMP</i>	Press Command / Amp / 4

This command takes the end of a source sample, and splices it to the beginning or start of the destination sample. SPLICE WAVESAMPLES is just like a tape splice—a butt splice. You can also think of it as MERGE with a zero length FADE ZONE.

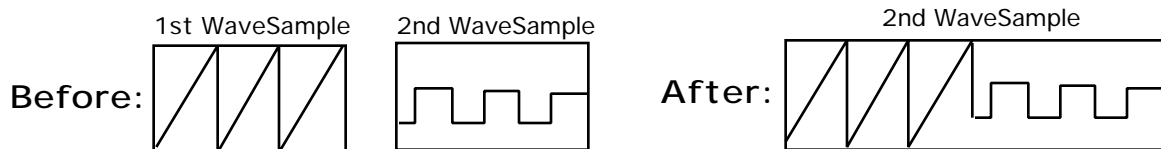

- Select SPLICE WAVESAMPLES. Press **Enter•Yes**.
- The display will ask ARE SAMPLES LAYERED? Press **Enter•Yes**.
- Select FR INST=## L=## WS=##. Scroll to TO INST=## L=## WS=##.
- Scroll to CONVERT SOURCE PITCH. Scroll to CONVERT DEST. PITCH.
- Scroll to VOLUME BALANCE= (-99 to +99). Use the **Data Entry Slider** to set the balance between the two.
- Press **Enter•Yes**. The display reads KEEP=OLD/NEW. Press **Enter•Yes** to keep the spliced WaveSamples, or **Cancel•No** to keep the originals intact.

<i>CMD</i>	<b>FADE IN</b>
<i>AMP</i>	Press Command / Amp / 5

This command scales the volume of the wave data from 0% to 100% to create a digital FADE IN of the sound. First, select a data range, using the start and end addresses, then choose an appropriate fade curve. 3 dB fades are very smooth and analogous to the way our hearing responds to sound.



- Select FADE IN. Press **Enter•Yes**.
- Select START ADDR=## (##). Scroll to END ADDR=## (##).
- Scroll to SCALE DEPTH=## DB. Press **Enter•Yes**.
- The display reads KEEP=OLD NEW.
- Press **Enter•Yes** to complete the command (or **Cancel•No** to keep the original).

**Note:** When STEREO LAYER LINK= ON, this command will be simultaneously performed on the corresponding WaveSample in the companion layer.

CMD	<b>FADE OUT</b>
AMP	Press Command / Amp / 6

This command scales the volume of the wave data from 100% to 0% to create a digital FADE OUT of the sound. The parameters are the same as above.

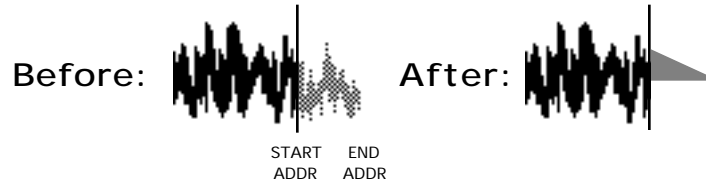

- Select FADE OUT. Press **Enter•Yes**.
- Select START ADDR=## (##). Scroll to END ADDR=## (##).
- Scroll to SCALE DEPTH=## (##). Press **Enter•Yes**.
- The display reads KEEP=OLD NEW.
- Press **Enter•Yes** to complete the command (or **Cancel•No** to keep the original).

**Note:** When STEREO LAYER LINK= ON, this command will be simultaneously performed on the corresponding WaveSample in the companion layer.

## Command/LFO Page (Data Commands)

<i>CMD</i>	<b>CLEAR DATA</b>
<i>LFO</i>	Press Command / LFO / 0

Use this command when you want silence as part of the WaveSample. Use the “start and end” addresses to select the section of WaveSample data you want to clear.

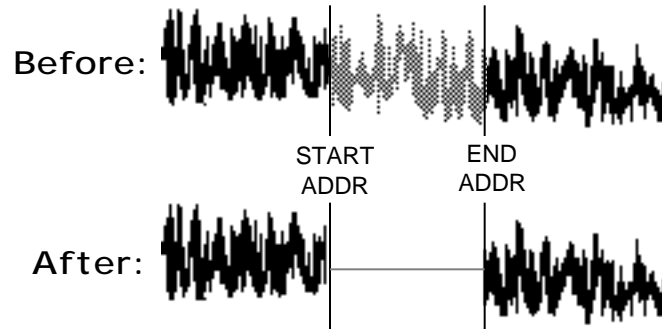

- Select CLEAR DATA. Press **Enter**•**Yes**.
- Select START ADDR=## (##). Scroll to END ADDR=## (##).
- Press **Enter**•**Yes** to complete the command (or **Cancel**•**No** to abort the procedure).

**Note:** When STEREO LAYER LINK= ON, this command will be simultaneously performed on the corresponding WaveSample in the companion layer.

<i>CMD</i>	<b>COPY DATA</b>
<i>LFO</i>	Press Command / LFO / 1

COPY DATA enables you to copy a section of wave data from one WaveSample and paste it over part of another WaveSample, replacing the data that was previously there. Use the “start and end” addresses, to copy wave data from a source to a destination. In fact, source and destination could be the same WaveSample, or the destination WaveSample could be in a different instrument.





CMD	<b>REPLICATE DATA</b>
LFO	Press Command / LFO / 0

The REPLICATE DATA command is used to append a section of wave data to itself as many times as will fit within the original WaveSample size. The replicated data will fill the remaining area of the WaveSample that lies after the END ADDR. Set the data range with the “start and end” addresses.

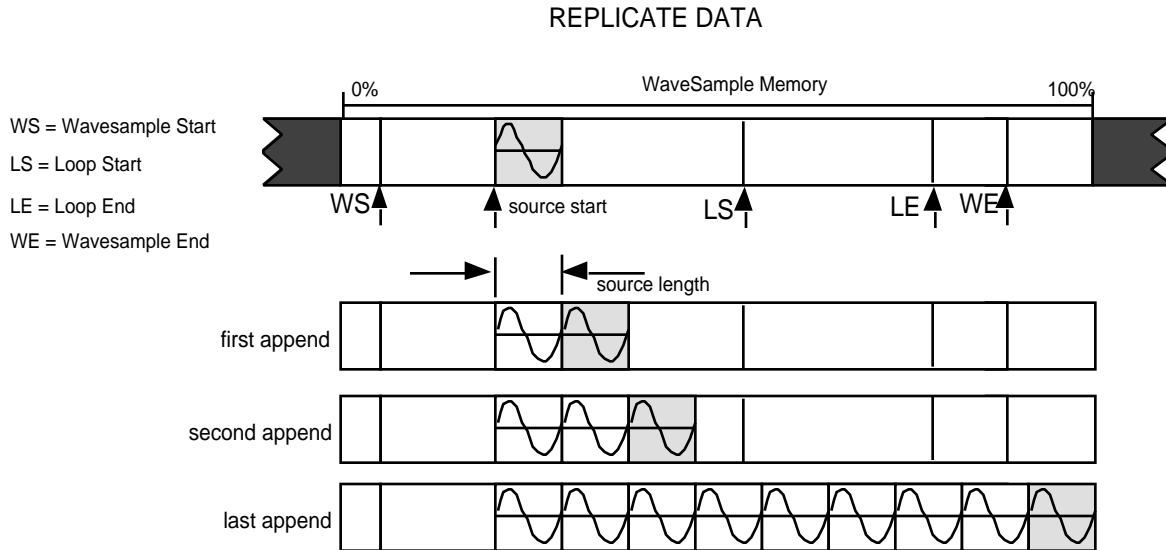

- Select REPLICATE DATA. Press **Enter•Yes**.
- Select START ADDR=## (##). Scroll to END ADDR=## (##). Press **Enter•Yes**.
- The display reads KEEP=OLD NEW. Press **Enter•Yes** to complete the command (or **Cancel•No** to abort the procedure).

**Note:** When STEREO LAYER LINK= ON, this command will be simultaneously performed on the corresponding WaveSample in the companion layer.

CMD	<b>REVERSE DATA</b>
LFO	Press Command / LFO / 3

The REVERSE DATA command takes the wave data in the specified range and turns it around backward, so that the last sample becomes the first one, the next-to-last sample becomes the second, and so on. It has the same effect as playing the WaveSample backward.

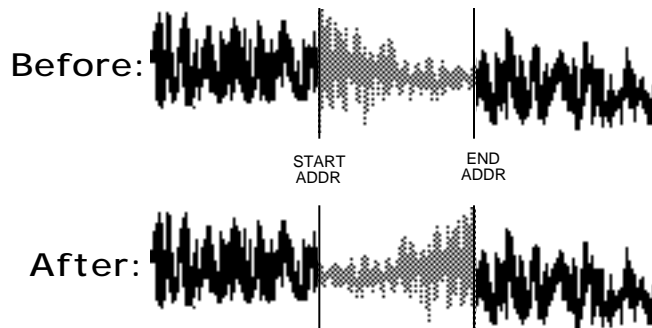

- Select REVERSE DATA. Press **Enter•Yes**.
- Select START ADDR=## (##). Scroll to END ADDR=## (##).

- Press **Enter•Yes** to complete the command (or **Cancel•No** to abort the procedure).

**Note:** When STEREO LAYER LINK= ON, this command will be simultaneously performed on the corresponding WaveSample in the companion layer.

<i>CMD</i>	<b>INVERT DATA</b>
<i>LFO</i>	Press Command / LFO / 4

This command inverts the phase of the selected wave data. This is the equivalent of playing the WaveSample upside down, with all frequency peaks becoming valleys and vice versa. If you're performing advanced WaveSample manipulation it is sometimes helpful to invert the phase of a signal for the purposes of cross fading. This will sometimes produce a smoother cross fade point.

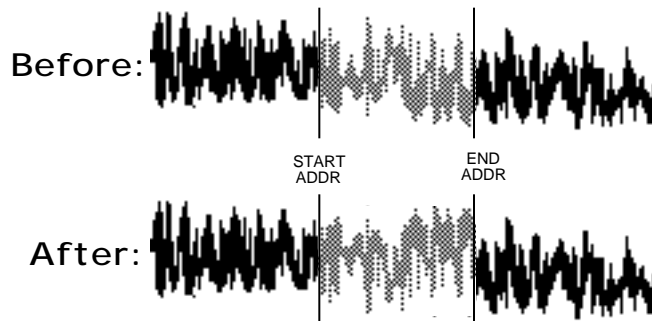

- Select INVERT DATA. Press **Enter•Yes**.
- Select START ADDR=## (##). Scroll to END ADDR=## (##).
- Press **Enter•Yes** to complete the command (or **Cancel•No** to abort the procedure).

**Note:** When STEREO LAYER LINK= ON, this command will be simultaneously performed on the corresponding WaveSample in the companion layer.

<i>CMD</i>	<b>ADD DATA</b>
<i>LFO</i>	Press Command / LFO / 5

This command is similar to COPY DATA, except it adds a section of the wave data from one WaveSample into part of another WaveSample, creating a composite of the two, according to the source and destination ranges. It could be the same WaveSample, or two different ones. When PREVENT CLIPPING is enabled, the ASR-10 (if necessary) will scale down the destination and source data, so the added data doesn't result in clipping.

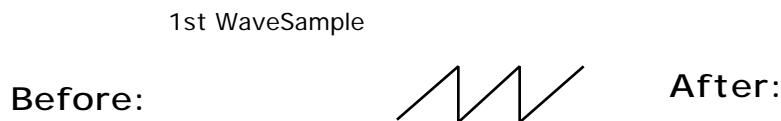

CMD	<b>SCALE DATA</b>
LFO	Press Command / LFO / 6

This command is a “sound sculpting” tool that will enable you to shape the volume contour of the waveform. As in the other commands, you select some range of data using the start and end addresses. You also set the scaling range with SCALE START and SCALE END points. These are multipliers. SCALE START is a multiplier used at the beginning of the source range. SCALE END is the multiplier used at the end of the source range. If the two scale points are the same, it’s like multiplying the whole range of data by the same number. So, if you wanted to drop the level in half, you would set SCALE START and END to 0.5. SCALE DEPTH works as described previously. If the scale points are different, the data will be scaled using a scaling curve whose depth is controlled by the SCALE DEPTH.

- Select SCALE DATA. Press **Enter•Yes**.
- Select START ADDR=## (##). Scroll to END ADDR=## (##). Scroll to SCALE START=##.
- Scroll to SCALE END=##. Scroll to SCALE DEPTH=## DB. Press **Enter•Yes**.
- The display reads KEEP=OLD NEW. Press **Enter•Yes** to complete the command (or **Cancel•No** to abort the procedure).

**Note:** When STEREO LAYER LINK= ON, this command will be simultaneously performed on the corresponding WaveSample in the companion layer.

# Section 11 — WaveSample & Layer Parameters

This section covers the parameters which can be edited independently for each individual WaveSample within an Instrument. For a general overview of the concepts involved, refer to Section 9 — WaveSample and Layer Concepts.

## Edit/Pitch Page

Use parameters on this page to adjust the pitch of the selected WaveSample(s).

**Note:** When STEREO LAYER LINK= ON, all pitch modulation in the right layer will be slaved to the settings in the WaveSamples assigned to the same or overlapping key zones in the left layer. This includes BEND RANGE, NOISE RATE, and all pitch modulation. Pitch modulation settings for WaveSamples in the right layer will be ignored.

<i>EDIT</i>	<b>ROOT KEY - FINE (Fine Tune)</b>
<i>PITCH</i>	Press Edit / Pitch / 1

These parameters allow you to change the WaveSample root key and adjust its fine tuning. The root key is the key at which the WaveSample plays back at the same pitch as it was recorded. Scroll right to select the fine tune range.

Root Key Range: KY0 to K11, C0 to G9

Fine Tune Range: -99 to +99 cents

**Note:** Keys in the octave below C0 are displayed as KY0 through K11. These values are only accessible when the Instrument is transposed up.

<i>EDIT</i>	<b>LFO AMOUNT</b>
<i>PITCH</i>	Press Edit / Pitch / 2

This parameter allows you to set the amount by which the LFO will modulate pitch (for vibrato, etc.).

Range: -15.7 to +15.7 semitones

<i>EDIT</i>	<b>ENV 1 AMOUNT</b>
<i>PITCH</i>	Press Edit / Pitch / 3

This parameter allows you to set the amount by which ENV 1 will modulate pitch.

Range: -15.7 to +15.7 semitones

<i>EDIT</i>	<b>NOISE RATE - AMOUNT</b>
<i>PITCH</i>	Press Edit / Pitch / 5

These parameters control the NOISE generator. The noise generator produces a randomly changing level. Its main use is to randomize or “humanize” the pitch. You can also use it to modulate the filters, amplitude, etc. NOISE RATE determines how frequently the random levels will change. Use the **Right Arrow** button to select AMOUNT. Noise AMOUNT determines the amount by which the NOISE generator will modulate pitch.

Rate range: 0 to 99

Amount: -99 to +99

<i>EDIT</i>	<b>BEND RANGE</b>
<i>PITCH</i>	Press Edit / Pitch / 6

This parameter allows you to set the pitch bend range on the WaveSample level.

Range: 0 through 12 semitones, GLOBAL

**Note:** When BEND RANGE=GLOBAL the WaveSample will use the GLOBAL BEND RANGE setting on the Edit/System • MIDI page.

<i>EDIT</i>	<b>PITCH MOD - AMOUNT</b>
<i>PITCH</i>	Press Edit / Pitch / 7

Use this parameter to assign one of fifteen modulators to modulate pitch, and to set the amount (depth) of that modulator.

Range: -99 to +99

<i>EDIT</i>	<b>WS RANGE LO - HI</b>
<i>PITCH</i>	Press Edit / Pitch / scroll using the arrow buttons

This parameter determines the key range the selected WaveSample will cover. Select the WS RNG LO parameter, play the key that you want to be the low key, the cursor will then automatically switch to the HI parameter, which can then be set in the same fashion.

Range: KY0 to K11, C0 to G9

**Note:** Keys in the octave below C0 are displayed as KY0 through K11. These values are only accessible when the Instrument is transposed up.

**Note:** As with the instrument key range, if you accidentally set the High Key *below* the Low Key, the selected WaveSample will not be heard.

## Command/Pitch Page

These commands allow you to create, delete and manipulate pitch tables. The ASR-10 can store up to eight user-defined pitch tables in each instrument. Each layer can use a different pitch table. Which pitch table a given layer will use is selected on the Edit/Layer page.

<i>CMD</i>	<b>EDIT PITCH TABLE</b>
<i>PITCH</i>	Press Command / Pitch / 0

Use this command to create or edit a pitch table.

- Sample a sound or load a sound from disk. If you sampled a sound, pick C4 as the root key.
- Select EDIT PITCH TABLE.
- Press **Enter** • **Yes**. When no pitch tables exist in the currently selected instrument, the display reads CREATE NEW PITCH TBL? Pressing **Enter** • **Yes** will assign the newly created pitch table to the currently selected layer. Note that when STEREO LAYER LINK= ON, this command will also assign the newly created pitch table to the companion layer.
- If multiple pitch tables exist in the current instrument, you must first assign a layer in the

instrument to use the pitch table that you want to edit (with the PITCH TBL parameter on the Edit/Layer page), and then invoke the pitch table command. If you're editing an existing pitch table, the CREATE NEW PITCH TBL prompt will not appear.

- Press **Enter•Yes**. The display reads KEY E4 = \* 0 CENTS. This is the default display. If you press any key on the keyboard the display will change. Pressing **Cancel•No** will abort this command.
- Press Middle C on the keyboard. The display now looks like this:

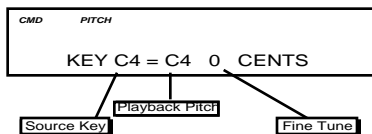

The source key can be thought of as the physical location of the key on the keyboard. The playback pitch can be the same as the source key—as shown in the display—or it can be any pitch from A0 to C8. The range of the fine tune is 0 to 99 cents. This allows you to create micro-tunings. Here's how:

- Play C4+ on the keyboard (the source key), or use the **Up/Down Arrow** buttons or the **Data Entry Slider** to select the source key.
- Press the **Right Arrow** button twice to move the cursor under the Fine Tune value, and change it to 50 CENTS.

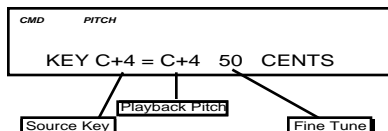

You have just defined a new interval between C and C4+. The interval has now been stretched by 50 cents. You can now repeat this procedure for each key on the keyboard to create your own custom pitch table.

Press the **Right Arrow** button until the display shows TBL NAME= PITCHTABLE 1 (the default pitch table name). You can name your custom pitch table using the **Left/Right Arrow** buttons to move the cursor, and the **Data Entry Slider** or the **Up/Down Arrow** buttons to select the characters. After you've named your custom pitch table:

- Press **Enter•Yes** to exit EDIT PITCH TABLE.

**Note:** For the following commands, you can't COPY, DELETE, or EXTRAPOLATE the STANDARD or NO PITCH pitch tables. If you try, the NO EDIT PITCH TABLE message will be displayed. You must create a new pitch table first using the EDIT PITCH TABLE command.

<i>CMD</i>	<b>COPY PITCH TABLE</b>
<i>PITCH</i>	Press Command / Pitch / 1

This command will copy a pitch table either within an instrument or from one instrument to another instrument. If you want to have multiple pitch tables within an instrument, start by selecting a layer that uses the pitch table to be copied. Use the COPY PITCH TABLE command to make a copy of the pitch table used by the currently selected layer. Next, assign a layer to use the pitch table copy (with the PITCH TBL parameter on the Edit/Layer page). Finally, with that layer selected, use the EDIT PITCH TABLE command to edit the pitch table copy to suit your needs. Remember to rename your newly edited pitch table to avoid confusion.

- Select COPY PITCH TABLE.
- Press **Enter**•**Yes**. The display reads TO INST= (name). Select the instrument where you would like the pitch table to be placed. Each instrument can contain up to 8 different pitch tables.
- Press **Enter**•**Yes**. The display reads PITCH TABLE (number) CREATED.

<i>CMD</i>	<b>DELETE PITCH TABLE</b>
<i>PITCH</i>	Press Command / Pitch / 2

This command will erase (delete) a pitch table. Any layers that used the pitch table that was deleted will have their Edit/Layer PITCH TBL parameter automatically set to use the (STANDARD) western equal temperment tuning.

<i>CMD</i>	<b>EXTRAPOLATE PITCH TBL</b>
<i>PITCH</i>	Press Command / Pitch / 3

Use this command to extend pitch table relationships across the keyboard. In other words, you can take the intervals defined between any two keys or group of keys, and extend that same relationship over the entire keyboard.

- Select EXTRAPOLATE PITCH TBL.
- Press **Enter**•**Yes**. The display reads SOURCE LO=## HI=## (## is a key number). This determines the range of the extrapolation.
- Play the low key of the range you wish to extrapolate.
- Scroll right to underline HI=##.
- Play the high key of the range you wish to extrapolate.
- Press **Enter**•**Yes**.

## ASR-10 Filters

Each ASR-10 voice has its own pair of digital filters, F1 and F2, that are connected in series. The filter settings determine which frequencies will be allowed to pass through to the output.

### Low-Pass and High-Pass

A low-pass filter allows only those frequencies below the filter cutoff frequency to pass—higher frequencies are filtered out. The reverse is true for the high-pass filters. In the ASR-10, the first filter (F1) is always a low-pass filter. The second filter (F2) can be either a high-pass or low-pass filter.

### Poles — Rolloff Curves

“Pole” is an engineering term that describes the steepness of a filter. Each additional pole gives a filter a steeper rolloff curve. In the ASR-10, four poles are available, but they are divided between two filters; either as 2 and 2, or as 3 and 1. A single-pole filter will rolloff at 6 dB per octave; a 2-pole, 12 dB per octave; a 3-pole, 18 dB per octave; and 4-pole, 24 dB per octave. To reproduce a 4-pole low-pass filter (for that “classic” analog synth sound) you would set both filters to 2-pole low-pass. Each filter would then roll-off at 12 dB per octave, resulting in a total 24 dB per octave rolloff.

### Cutoff Frequency

Every filter has a “knee” in the response curve, known as the cutoff frequency. This is the frequency at which the filter begins filtering out frequencies. The filter cutoff frequency can remain fixed over time, or it can be varied by modulating the filter with an envelope, LFO, velocity, etc. You can create some very interesting filter configurations by using a different modulator for each filter. For instance, try using pressure to modulate the filter. You can drive one filter up with pressure, while simultaneously driving the other down.



## Edit/Filters Page

Use the parameters on this page to adjust the filters.

<i>EDIT FILTERS</i>	<b>MODE (Filter Mode)</b>
	Press Edit / Filters / 0

Use this parameter to choose one of the four filter modes.

The following diagrams show some possible filter configurations. On the left are the response curves of the two filters shown separately. On the right are some possible shapes of the combined filters.

- **MODE F1=3/LP F2=1/LP.** F1 is a 3 pole low-pass filter. F2 is a 1-pole low-pass filter.

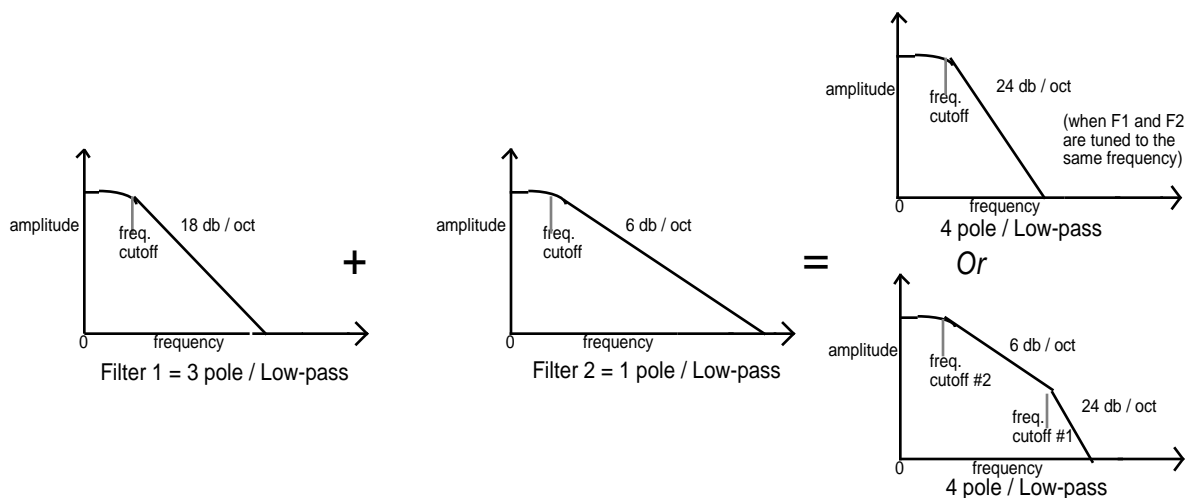

- **MODE F1=2/LP F2=2/LP.** F1 is a 2-pole low-pass filter. F2 is also a 2-pole low-pass filter.

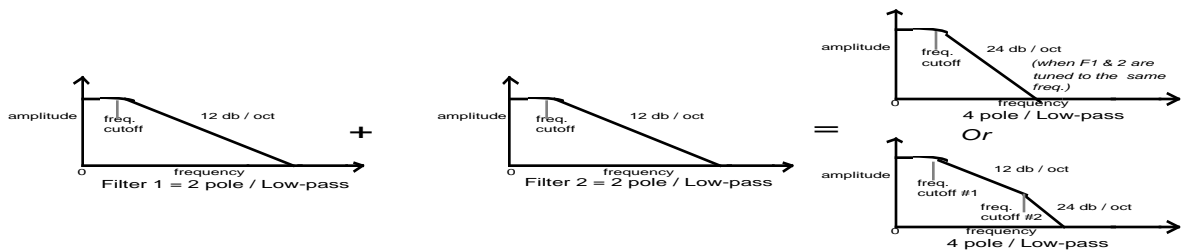

- MODE F1=3/LP F2=1/HP. F1 is a 3-pole low-pass filter. F2 is a 1-pole high-pass filter.

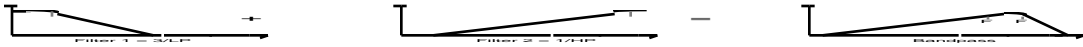

- MODE F1=2/LP F2=2/HP. F1 is a 2-pole low-pass filter. F2 is a 2-pole high-pass filter.

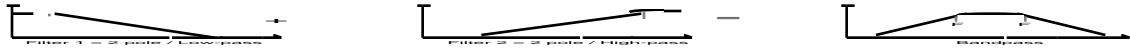

<i>EDIT</i> <i>FILTERS</i>	<b>CUTOFF F1 (Filter 1) - F2 (Filter 2)</b>
	Press Edit / Filters / 1

These parameters allow you to set the initial filter cutoff frequency for each of the two filters. With a low-pass filter, a setting of 150 lets all the original signal pass through the filter. With a high-pass filter, a setting of 0 lets through all of the original signal. This setting represents the “filter floor,” or manual level. The effect of any selected modulators will be added to (or subtracted from) this level.

Ranges: 0 to 150

<i>EDIT</i> <i>FILTERS</i>	<b>ENV2 AMT F1 (Filter 1) - F2 (Filter 2)</b>
	Press Edit / Filters / 2

Use these parameters to set the depth or amount by which Env 2 will modulate the filter cutoff frequency. Modulation amounts can be positive or negative.

Ranges: -99 to +99

<i>EDIT</i> <i>FILTERS</i>	<b>KBD AMOUNT F1 (Filter 1) - F2 (Filter 2)</b>
	Press Edit / Filters / 3

These parameters set the amount by which the location of a note on the keyboard will modulate the filter cutoff frequency (filter keyboard tracking). This allows the relative brightness of a sound to remain constant over the keyboard. To have a filter track the keyboard exactly you should set KBD AMT to +50.

Ranges: -99 to +99

<i>EDIT</i>	<b>F1 MOD - AMOUNT</b>
<i>FILTERS</i>	Press Edit / Filters / 7

Use this parameter to select a modulation source and the modulation amount for the Filter 1 cutoff frequency. Any of the fifteen available modulators can be applied to modulate the Filter 1 cutoff frequency. Modulation amounts can be positive or negative.

Range: -99 to +99

<i>EDIT</i>	<b>F2 MOD - AMOUNT</b>
<i>FILTERS</i>	Press Edit / Filters / 8

This parameter serves the same function as F1 MOD - AMOUNT, but controls Filter 2. It operates in an identical fashion. Any of the fifteen available modulators can be applied to modulate the Filter 2 cutoff frequency.

## Edit/Amp Page

The parameters on this page control the amplitude (or volume) of the WaveSample.

<i>EDIT</i>	<b>WS VOLUME - PAN</b>
<i>AMP</i>	Press Edit / Amp / 1 (for Volume) 2 (for Pan)

### WaveSample Volume

Use this parameter to set the volume of an individual WaveSample. This parameter also controls the amount by which ENV 3 will modulate the WaveSample volume.

Range: 0 to 99

### WaveSample Pan

Use this parameter to assign a WaveSample to a location in a stereo field, either within the main outputs, or any of the pairs of outputs on the optional Output Expander.

Range: -99 (full left) to +99 (full right)

<i>EDIT</i>	<b>VOLUME MOD - AMOUNT</b>
<i>AMP</i>	Press Edit / Amp / 7

This parameter allows you to assign a modulator to control the volume of an instrument, layer, and/or WaveSample. Any of the fifteen available modulators can be applied to modulate volume. Raising this value will lower the unmodulated volume of the WaveSample(s), creating the headroom necessary for the volume modulation. Note that the AMOUNT value is positive-going only. To obtain negative volume modulation, you must edit the A-B FADE IN and C-D FADE OUT values (see later in this Section).

Amount Range: 0 to 99

<i>EDIT</i>	<b>PAN MOD - AMOUNT</b>
<i>AMP</i>	Press Edit / Amp / 8

This parameter allows you to assign a modulator to control the panning of an instrument, layer, and/or WaveSample. Any of the fifteen available modulators can be applied to modulate pan.

Range: -99 to +99

<i>EDIT</i>	<b>A - B FADE IN - TO</b>
<i>AMP</i>	Press Edit / Amp / 3

<i>EDIT</i>	<b>C - D FADEOUT - TO</b>
<i>AMP</i>	Press Edit / Amp / 4

### Volume Modulator Cross Fade Breakpoints

The cross fade breakpoints (A and B, C and D) allow you to scale the effect of the volume modulator (selected with the Edit/Amp VOLUME MOD parameter) to create keyboard, velocity, or other types of cross fades. Using the cross fade breakpoints, you can customize how the volume modulator will affect the volume of the WaveSample across the range (or throw) of its output. This lets you use velocity, keyboard position, pressure or any other modulator to cross fade between WaveSamples.

Think of the A-B FADE IN/C-D FADEOUT parameters as a trapezoid, whose shape will affect the output of the modulator assigned to the Edit/Amp VOLUME MOD parameter. The A-B FADE IN value sets the point along the throw of the volume modulator that the modulator's output value will begin to rise above zero (i.e. fade in). The A-B FADE TO value sets the point along the throw of the volume modulator that the modulator's output value will have risen to its maximum output. The C-D FADE OUT value sets the point along the throw of the volume modulator that the modulator's output value will begin to fall from maximum (i.e. fade out). The C-D FADE TO value sets the point along the throw of the volume modulator that the modulator's output value will have fallen to zero.

The default values are "A-B FADE IN=0 TO 127" and "C-D FADE OUT=127 TO 127," imposing the following shape on the output of the volume modulator. In this example the Mod Wheel is the volume modulator:

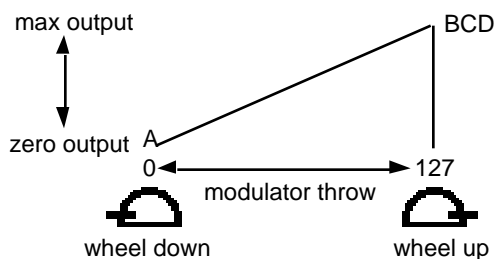

To reverse the polarity of the volume modulator, set the values as follows: "A-B FADE IN=0 TO 0" and "C-D FADE OUT=0 TO 127." The shape imposed on the output of the volume modulation is as follows; again, the Mod Wheel is the volume modulator:

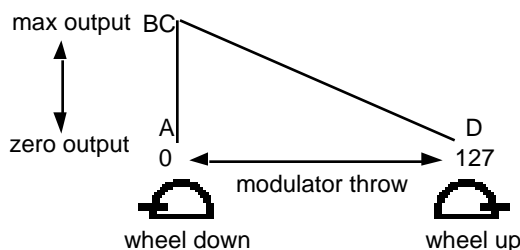

**Note:** Whenever you cross fade between WaveSamples, the WaveSamples must be in different layers, since only one WaveSample can occupy a given key within a single layer.

See Section 16 — *Instrument Programming Applications* for information on programming keyboard cross fades.

<i>EDIT</i> <i>AMP</i>	<b>FADECURVE</b>
	Press Edit / Amp / 5

This parameter determines what type of curve will be used when fading samples in and out between breakpoints A-B and C-D. There are two possible fadecurves:

- **CROSSFADE** — This convex curve features a steep initial rise/drop off. It is best used when a quick change between breakpoints is desired, as in a keyboard or velocity cross fade.
- **LINEAR** — This linear curve ramps up and down evenly, making it preferable when smoother transitions between breakpoints are appropriate, such as when using pressure to cross fade.

<i>EDIT</i> <i>AMP</i>	<b>BOOST</b>
	Press Edit / Amp / 6

Setting this parameter to ON gives the selected WaveSample a +12dB boost in volume. Be careful that adding boost to a sample doesn't cause it to become so loud that it starts to clip.

Range: OFF, ON

<i>EDIT</i> <i>AMP</i>	<b>OUT (Output Routing)</b>
	Press Edit / Amp / 9

This parameter enables you to assign instruments, layers, or WaveSamples to any of the three effects busses. With the OEX-6sr Output Expander (optional) connected, it also allows you to assign instrument, layers, and WaveSamples to any of the three additional auxiliary stereo outputs. This diagram shows how voices are routed through the Effects Processor and Output Expander.

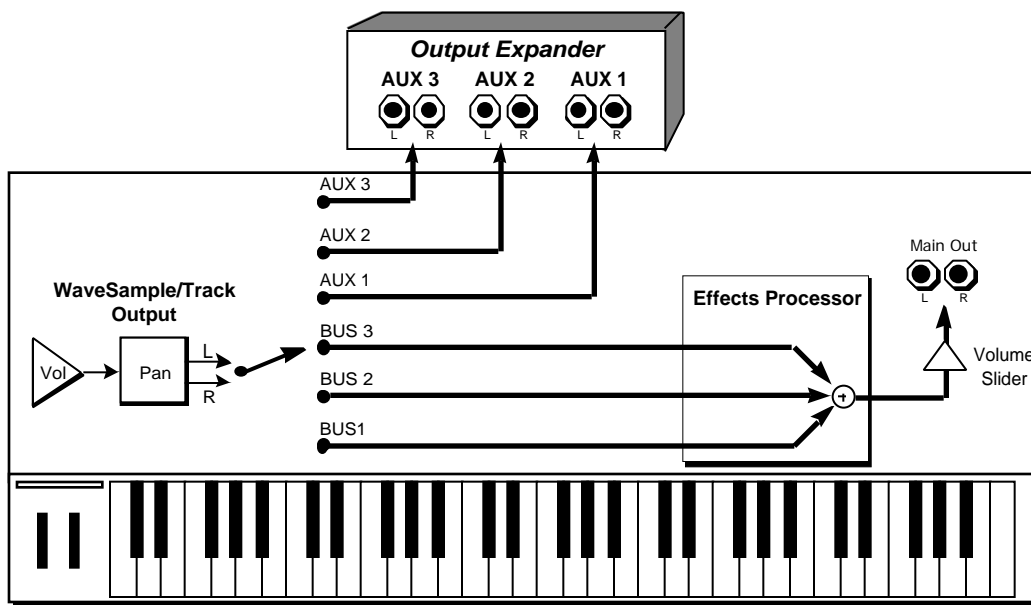

Range: BUS 1, BUS 2, BUS 3, AUX 1, AUX 2, or AUX 3

**Note:** When Sample • Source Select/REC SRC Field 1 is set to INPUT+FX, all Voices go DRY, and any WaveSamples that were routed to BUS 1, 2, or 3 will all show OUT= DRY - - FX BUS IN USE on this screen.

## ASR-10 Envelopes

Each ASR-10 WaveSample has three envelopes. These envelopes are hard-wired to the pitch, filter cutoff frequency, and amplitude of the WaveSample. Env 1 and Env 2 can also be assigned elsewhere, wherever a modulator is selectable. Each of the three envelope buttons is directly above the page button for the function it's associated with:

- Env 1 is routed to WaveSample pitch.
- Env 2 is routed to WaveSample filter cutoff frequency.
- Env 3 is routed to WaveSample amplitude (volume).

The indicator lights in the display tell you which one of the three Envelope pages you are on. For example when you are on the Edit/Env 2 page, the FILTER and ENV indicators are lit.

### About ENV 3

In the ASR-10, the response of the WaveSample volume, ENV 3, and the Instrument mix level all use the same (non linear) response curve. As shown below, setting any of these volume controls to 50 will attenuate a sound by 16 dB.

HARD OR SOFT LEVEL RESPONSE (dB)	LEVEL AMPLITUDE
99	0 dB
75	-8 dB
50	-16 dB
25	-32 dB
6	-56 dB
0	-∞ (infinity)

### Typical ASR-10 Envelope

The figure below shows a typical ASR-10 envelope shape:

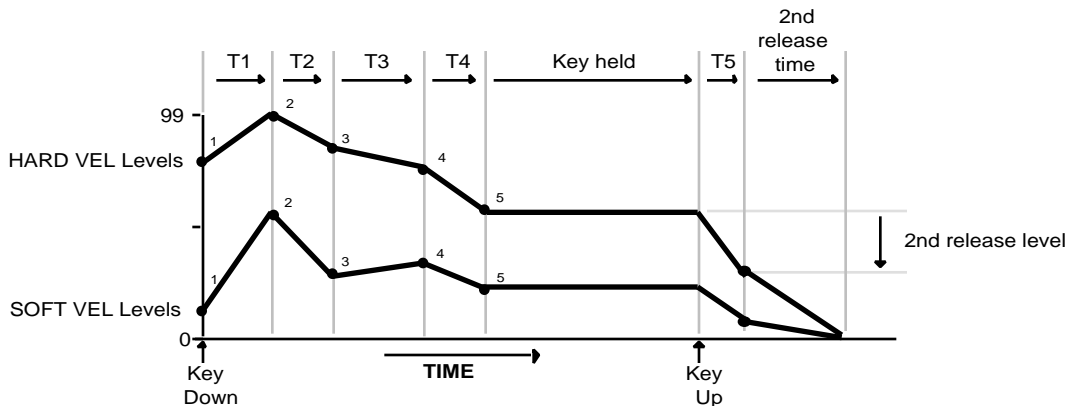

The ASR-10 envelope is a descendant of the venerable ADSR (attack, decay, sustain, release) envelope, with a number of refinements. While the ADSR envelope gives you control over three times segments and one level, the ASR-10 envelopes have six times and six levels.

What's more, the envelope parameters allow you to describe two entirely different shapes; one for maximum velocity (HARD VEL) and one for minimum velocity (SOFT VEL). When a key is struck, the envelope generator actually *interpolates* between the two, creating a curve that is a combination of the two based on the incoming velocity.

### Edit/Env 1, Env 2, Env 3 Pages

Each of the three Envelope pages (Edit/Env 1, Edit/Env 2, and Edit/Env 3) contain the following parameters. Use these parameters to adjust the envelopes.

<i>EDIT</i>	<b>HARD VEL LEVELS</b>
<i>ENV</i>	Press Edit / Env1, Env2, or Env3 / 1

HARDVEL shows the five levels for the envelope that will be used with maximum velocity. Level-1 is the initial level; in a traditional ADSR shape, Level-1 is always set to zero. Level-5 is the sustain level.

<i>EDIT</i>	<b>SOFT VEL LEVELS</b>
<i>ENV</i>	Press Edit / Env1, Env2, or Env3 / 2

SOFTVEL shows the five levels for the envelope that will be used with minimum velocity.

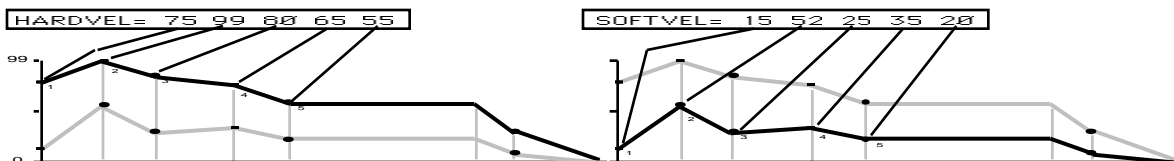

<i>EDIT</i>	<b>TIMES</b>
<i>ENV</i>	Press Edit / Env1, Env2, or Env3 / 3

TIMES shows five time parameters. The first four are the times between the five levels. The fifth time is the (first) release time.

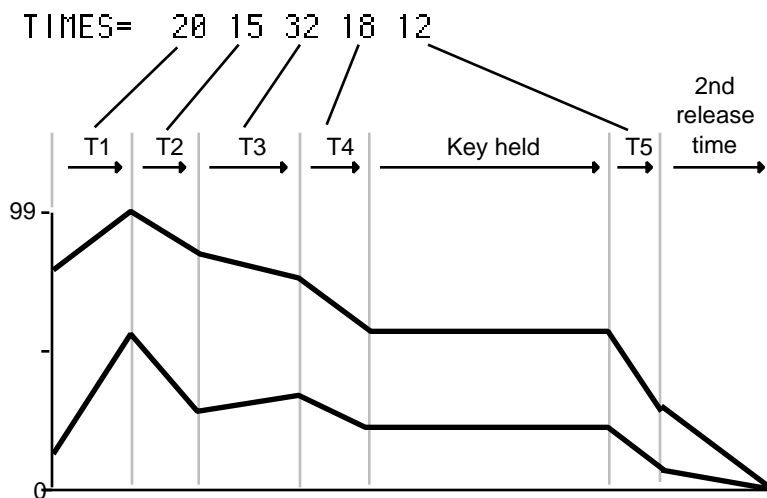

ENVELOPE TIMES

	time value	(in sec)	time value	(in sec)	time value	(in sec)	time value	(in sec)	time value	(in sec)
0	.00		20	.20	40	.82	60	3.2	80	13
1	.01		21	.22	41	.88	61	3.5	81	14
2	.02		22	.23	42	.94	62	3.7	82	15
3	.03		23	.25	43	1.0	63	4.0	83	16
4	.04		24	.27	44	1.0	64	4.3	84	17
5	.06		25	.29	45	1.1	65	4.6	85	18
6	.07		26	.31	46	1.2	66	4.9	86	19
7	.08		27	.33	47	1.3	67	5.3	87	21
8	.08		28	.35	48	1.4	68	5.7	88	22
9	.09		29	.38	49	1.5	69	6.1	89	24
10	.10		30	.41	50	1.6	70	6.5	90	26
11	.11		31	.44	51	1.7	71	7.0	91	28
12	.11		32	.47	52	1.8	72	7.5	92	30
13	.12		33	.50	53	2.0	73	8.1	93	32
14	.13		34	.54	54	2.1	74	8.6	94	34
15	.14		35	.58	55	2.3	75	9.3	95	37
16	.15		36	.62	56	2.4	76	9.9	96	39
17	.16		37	.66	57	2.6	77	10	97	42
18	.17		38	.71	58	2.8	78	11	98	45
19	.19		39	.76	59	3.0	79	12	99	49

<i>EDIT</i>	<b>2ND RELEASE (TIME) - LEV</b>
<i>ENV</i>	Press Edit / Env1, Env2, or Env3 / 4

2ND RELEASE time and 2nd release LEVEL provide one more breakpoint in the envelope, which occurs *after* the release (T5). The LEVEL value controls where the breakpoint will be placed relative to the current value of the envelope at the time the key was released.

The following diagram illustrates how the 2nd RELEASE time and LEVEL affect both the HARDVEL and SOFTVEL levels of an envelope.

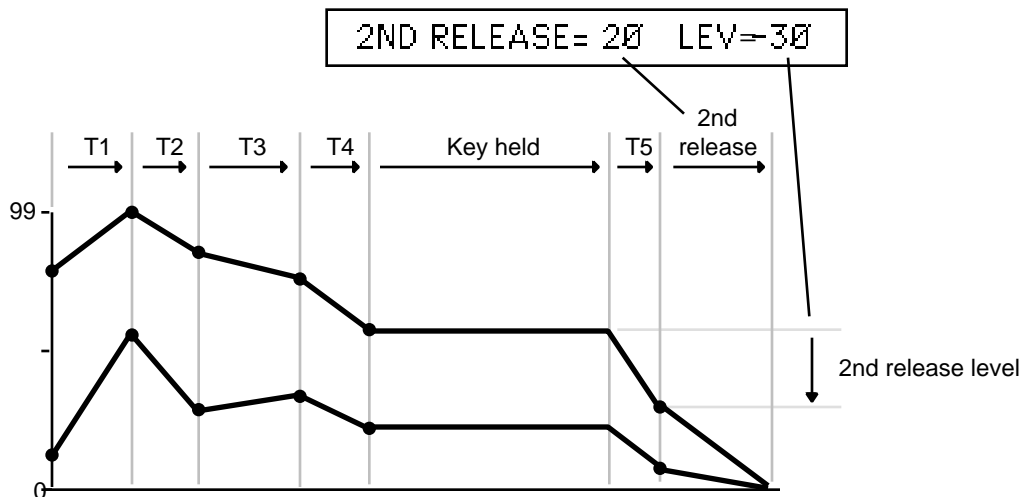



<i>EDIT</i>	<b>ATTACK TIME VEL AMT</b>
<i>ENV</i>	Press Edit / Env1, Env2, or Env3 / 5

ATTACK TIME VELOCITY AMOUNT makes TIME-1 shorter with increasing velocity. If TIME-1 is set to zero this parameter will have no effect.

Range: 0 to 99

<i>EDIT</i>	<b>KBD TIME SCALING</b>
<i>ENV</i>	Press Edit / Env1, Env2, or Env3 / 6

KBD TIME SCALING changes the envelope times above and below the root key. Positive values make the envelope shorter for keys above the root key, and longer for keys below the root key. Negative values have the opposite effect. The root key is not affected by this parameter. 2ND RELEASE time is also not affected by this parameter.

Range: -99 to +99

<i>EDIT</i>	<b>SOFT VEL CURVE</b>
<i>ENV</i>	Press Edit / Env1, Env2, or Env3 / 7

This parameter determines how incoming velocity will affect the envelope's interpolation between the SOFTVEL and HARDVEL level settings. There are four settings:

- OFF — The envelope uses only the HARDVEL levels, regardless of velocity.
- VEL, VEL1, or VEL2 — Incoming velocity will modulate the envelope levels between the SOFTVEL and HARDVEL level settings, according to one of the following velocity curves:

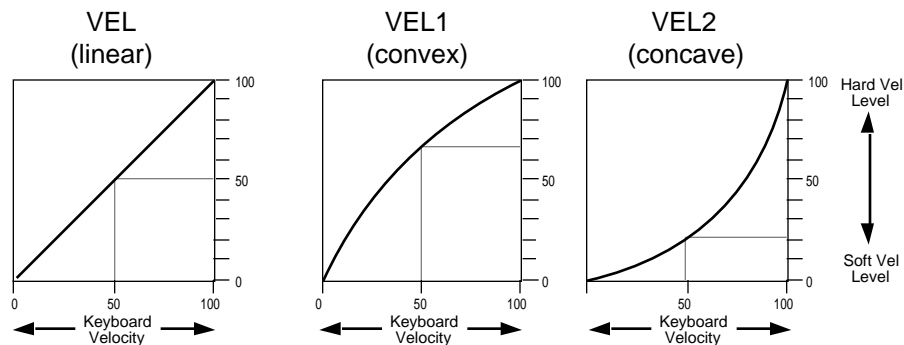

<i>EDIT</i>	<b>ENVELOPE MODE</b>
<i>ENV</i>	Press Edit / Env1, Env2, or Env3 / 8

ENVELOPE MODE has three states:

- **NORMAL:** as pictured in the previous envelope diagrams.
- **FINISH:** envelope runs its full cycle, ignoring the key-up event.
- **REPEAT:** In this mode, the envelope will run through levels 2 through 5, using times 1 through 4, repeatedly as long as the key is down.

<i>EDIT</i>	<b>ENVELOPE (Envelope Template)</b>
<i>ENV</i>	Press Edit / Env1, Env2, or Env3 / 0

The last parameter on the Envelope page usually reads ENVELOPE=CURRENT VALUE. This is the envelope template parameter.

There are a number of “typical” envelope templates permanently stored in the ASR-10; they each have a name. When you select one of these envelopes, its twenty-one parameters are *copied* into the envelope of the WaveSample or WaveSamples you are editing. The old values are temporarily saved as the CURRENT VALUE. You can go back to CURRENT VALUE any time you wish, unless you change any of the values in one of the template envelopes. Editing individual parameters of *any* envelope causes it to become the CURRENT VALUE of that particular envelope.

The following diagram illustrates the 14 typical envelope templates.

## Envelope Templates

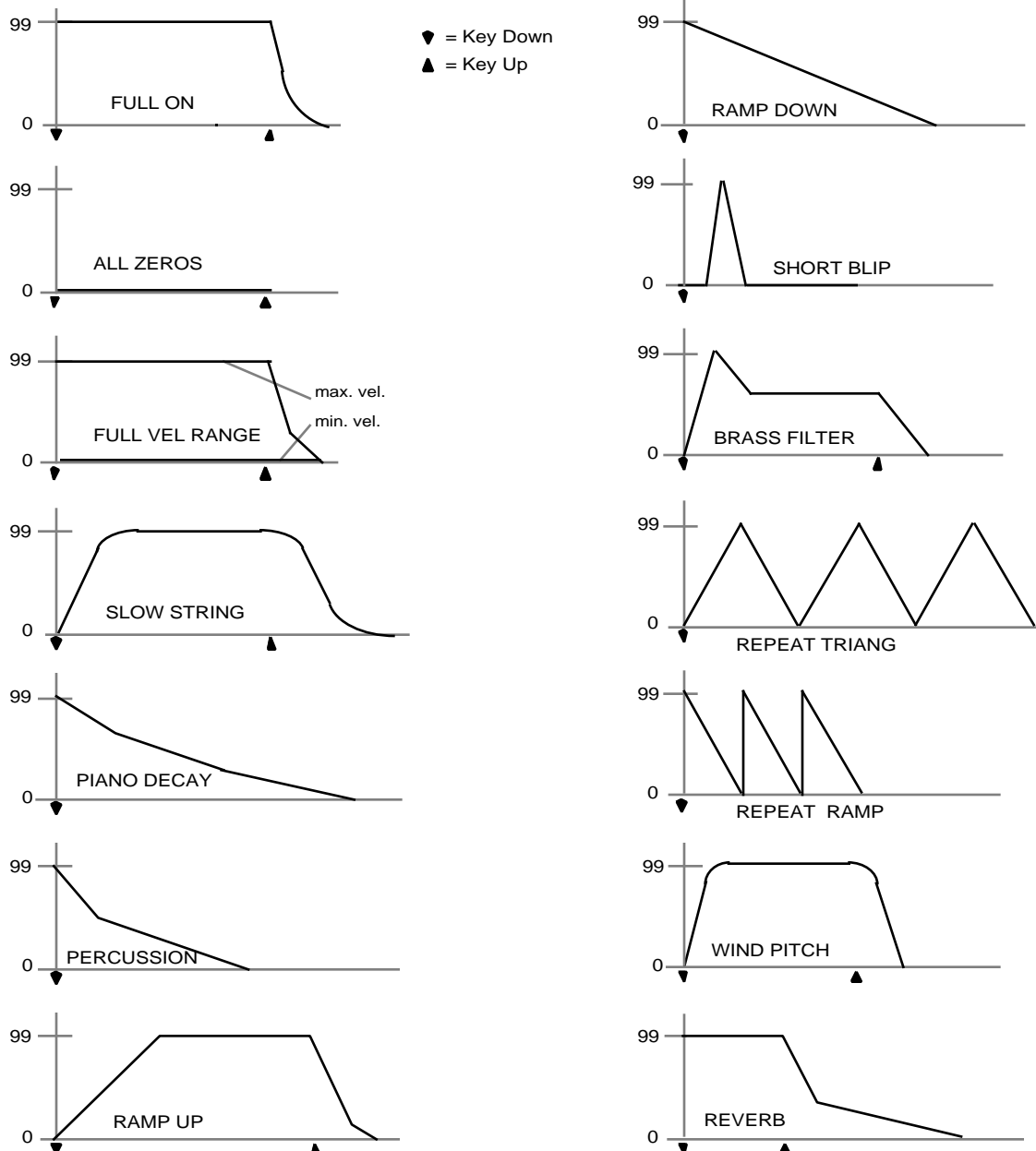

### Copying Envelopes

Pressing **Enter•Yes** while the envelope template parameter is displayed causes the current set of parameters to be saved in a special buffer. The message **ENVELOPE PARAMS SAVED** will appear briefly. There is only one **SAVED** envelope in the entire ASR-10 at any one time. This envelope becomes your own template, which can be selected on the envelope template page by selecting **ENVELOPE=SAVED**. You can use this function to copy an envelope from one WaveSample to another.

## Edit/LFO Page

The parameters on this page control the Low Frequency Oscillator (LFO) that can be used to create vibrato, tremolo and other effects. To access these parameters, press **Edit** then **LFO**.

<i>EDIT</i>	<b>WAVE - RATE</b>
<i>LFO</i>	Press Edit / LFO / 1 (for Wave) 2 (for Rate)

### LFO Wave

Use this parameter to select one of the seven LFO waveforms:

- **TRIANGLE** — the triangle wave is commonly used to modulate pitch to produce vibrato.
- **SINE/TRI** — a mixture of a sine and triangle wave, a sort of pointy sine wave.
- **SINEWAVE** — the sine wave is a pure fundamental frequency, more rounded in its peaks and valleys than the triangle wave.
- **POS/TRI** — the POS/TRI is a positive-only triangle wave useful for simulating vibrato on instruments like the guitar, where vibrato techniques are limited to bending the note up.
- **POS/SINE** — the POS/SINE is a positive-only sine wave, similar in application to the POS/TRI.
- **SAWTOOTH** — the sawtooth wave is commonly used for special effects.
- **SQUARE** — this positive-only square wave is useful for producing in-tune trill effects.

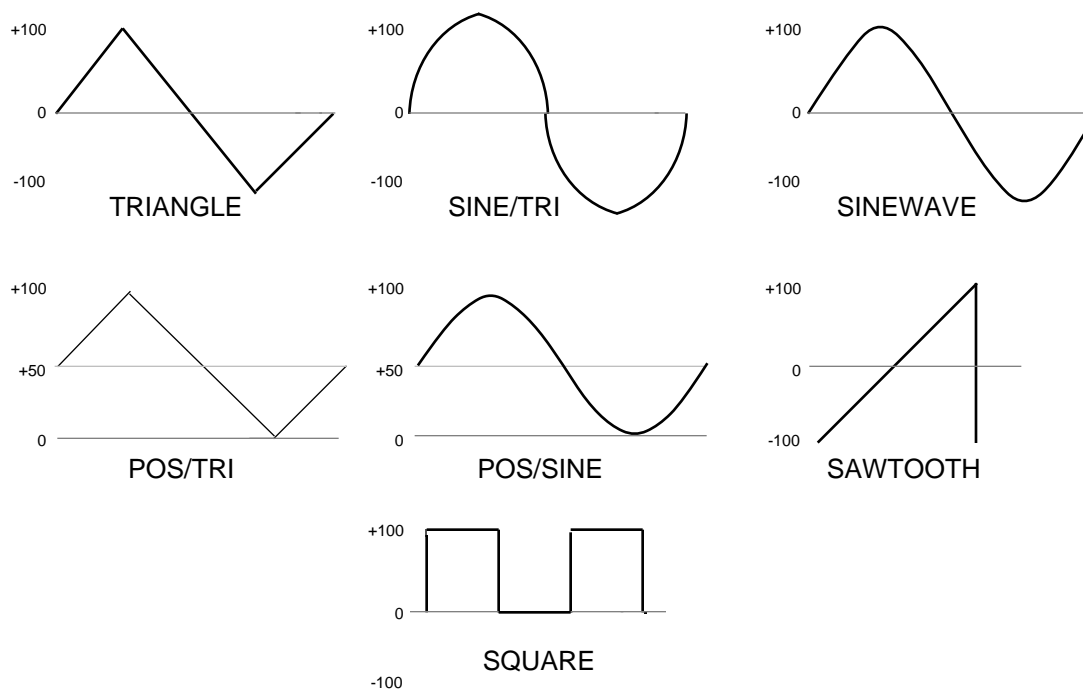

**LFO Rate**

This parameter allows you to set the rate (or speed) of the LFO, making the LFO modulation faster or slower.

Range: 0 to 99

LFO FREQUENCIES									
value	time (in Hz)	value	time (in Hz)	value	time (in Hz)	value	time (in Hz)	value	time (in Hz)
0	.05	20	1.25	40	6.25	60	11.25	80	16.25
1	.05	21	1.50	41	6.50	61	11.50	81	16.50
2	.06	22	1.75	42	6.75	62	11.75	82	16.75
3	.06	23	2.00	43	7.00	63	12.00	83	17.00
4	.06	24	2.25	44	7.25	64	12.25	84	17.25
5	.07	25	2.50	45	7.50	65	12.50	85	17.50
6	.07	26	2.75	46	7.75	66	12.75	86	17.75
7	.08	27	3.00	47	8.00	67	13.00	87	18.00
8	.08	28	3.25	48	8.25	68	13.25	88	18.25
9	.09	29	3.50	49	8.50	69	13.50	89	18.50
10	.10	30	3.75	50	8.75	70	13.75	90	18.75
11	.11	31	4.00	51	9.00	71	14.00	91	19.00
12	.13	32	4.25	52	9.25	72	14.25	92	19.25
13	.14	33	4.50	53	9.50	73	14.50	93	19.50
14	.17	34	4.75	54	9.75	74	14.75	94	19.75
15	.20	35	5.00	55	10.00	75	15.00	95	20.00
16	.25	36	5.25	56	10.25	76	15.25	96	20.25
17	.33	37	5.50	57	10.50	77	15.50	97	20.50
18	.50	38	5.75	58	10.75	78	15.75	98	20.75
19	1.0	39	6.00	59	11.00	79	16.00	99	21.00

<i>EDIT</i> <i>LFO</i>	<b>LFO DEPTH - DELAY</b>
	Press Edit / LFO / 3 (for Depth) 4 (for Delay)

**LFO Depth**

LFO DEPTH controls the initial amount of LFO. The effect of any LFO DEPTH modulator will be added to this amount.

Range: 0 to 99

**LFO Delay**

DELAY controls the time it takes for the LFO to go from zero to the amount set with the LFO DEPTH parameter. Values above 0 will cause the LFO to take longer to achieve its full depth. This is useful for creating delayed vibrato, tremolo, etc.

Range: 0 to 99

<i>EDIT</i>	<b>LFO MODE</b>
<i>LFO</i>	Press Edit / LFO / 5

Use this parameter to set the LFO in one of two modes:

- **RESTART OFF** — The LFO will cycle continuously without restarting.
- **RESTART ON** — The LFO waveform will return to the beginning of its cycle each time a new key is struck.

<i>EDIT</i>	<b>DEPTH MOD - AMOUNT</b>
<i>LFO</i>	Press Edit / LFO / 7

This parameter allows you to select a modulation source and the modulation amount for LFO DEPTH. The effect of LFO DEPTH MOD is *added* to the effect of the LFO DEPTH parameter. Either parameter can be used to generate LFO modulation. If you have the LFO DEPTH set to zero, you can still get LFO modulation by using any of the modulation sources on this page. Any of the fifteen available modulators can be applied to modulate LFO DEPTH .

<i>EDIT</i>	<b>RATE MOD - AMOUNT</b>
<i>LFO</i>	Press Edit / LFO / 8

This parameter allows you to select a modulation source and the modulation amount for the LFO RATE. The effect of RATE MOD is *added* to the effect of the LFO RATE parameter. Any of the fifteen available modulators can be applied to modulate the LFO RATE.

## Edit/Layer Page

The parameters on this page control the layers within an instrument. To access them press **Edit**, then **Layer**.

<i>EDIT</i>	<b>LYR GLIDEMODE</b>
<i>LAYER</i>	Press Edit / Layer / 0

Use this parameter to create a portamento glide between notes. This is a monophonic effect that is triggered when you play legato notes. When set to PEDAL, you must play legato notes (or sustained notes) and depress the foot pedal to start the glide. The ASR-10 uses *constant-time* glide: it will take the same amount of time to glide between notes that are close together (i.e. C4 to D4) as it will to glide between notes that are far apart (i.e. C4 to C7). Glide time is determined by the LAYER GLIDETIME parameter.

For monophone voice assignment without glide, set LAYER GLIDEMODE to LEGATO, TRIGGER, or MINIMODE, and set the LAYER GLIDETIME to zero.

- **OFF** — Glide is off. This is normal polyphonic operation with no portamento.
- **LEGATO** — Enables monophonic voice assignment, allowing only one voice to be active in the layer. If a key is depressed before another is released, the voice will glide from the old note to the new one. The envelopes and WaveSamples are retriggered or restarted each time there is a new key down.
- **PEDAL** — Enables the sustain pedal to start the polyphonic glide. In this mode, the glide and polyphony are controlled by the sustain pedal. When the pedal is up, there is no glide and the layer is fully polyphonic. When the sustain pedal is depressed, the glide is enabled, and the polyphony is limited to the number of notes being sounded at the moment. For example, with the pedal up play a three-note chord. Press the sustain pedal and lift your fingers off the keys (the three notes will sustain). Now press another key: one of these sustaining notes will glide to the new note. The envelopes and WaveSamples are retriggered, or restarted, each time there is a new key down. Keeping a key down will prevent the note from being stolen. This allows controlled voice leading.
- **TRIGGER** — This mode plays monophonically, with the envelopes and WaveSamples retriggering, or restarting, each time there is a new key down. This mode works just like LEGATO mode, except that it has no “note memory” (see below). It is ideal for adding monophonic piano “thuds” to piano instruments.
- **MINIMODE** — Similar to mono mode on old analog synths. The voice will play with one-voice polyphony, and new notes will glide from the previous note if the previous note is still held. Unlike the LEGATO, PEDAL, or TRIGGER modes, the envelopes and WaveSamples are only restricted from the beginning when you play staccato—play a new note with no other keys down.

**Note:** LEGATO and MINIMODE feature “note memory.” If you release a key while still holding down another key, the pitch will glide back to the note you are holding. Holding down the sustain pedal will dynamically disable note memory.

**GLIDE MODES**

Mode	Staccato Glide	Legato Glide	Legato Retrigger	Note Memory
<b>LEGATO</b>	NO	YES	YES	YES
<b>PEDAL</b> (with pedal down)	YES	YES	YES	NO
<b>TRIGGER</b>	NO	YES	YES	NO
<b>MINIMODE</b>	NO	YES	NO	YES

<i>EDIT LAYER</i>	<b>LAYER GLIDETIME</b>
	Press Edit / Layer / 1

Use this parameter to set the speed of the glide between notes. Lower values yield a faster glide; higher numbers, a slower glide.

Range: 0 to 99

<i>EDIT LAYER</i>	<b>LEGATO LAYER</b>
	Press Edit / Layer / 2

The legato layer is an ENSONIQ innovation that enables the ASR-10 to capture the elusive nuances of acoustic instruments. The sound of a wind instrument, the flute for example, is different when it is “tongued” than when notes are played in a connected manner (called legato). When two notes are “slurred” or “trilled” the characteristic attack of the second note is not present. The ASR-10 allows a simulation of this effect when used with one of the glide modes.

The rules for glide, described above, determine when two notes will be connected. The glide time determines how fast it will get to the new note. The legato layer parameter selects which layer, and therefore what sound, will play on the new note.

For example, suppose that layer one is a flute sample with a tongued attack, and layer two is a flute sustain without any attack. To use this function:

On the Edit/Instrument page:

- Enable both layer 1 and layer 2 in the patch. The display reads 00 PATCH=1 2 - - - - -.
- Scroll right, enable layer 1, the attack, as a keydown layer. Disable layer two as a keydown layer. The display reads KEYDWN LAYERS=1 - - - - -.

On the Edit/Layer page for layer 1:

- Set GLIDEMODE=LEGATO.
- Set LEGATO layer=2.
- Adjust GLIDETIME as you see fit.

If a key is depressed before another is released, the new note will play the WaveSample in the Legato layer (layer 2).



<i>EDIT LAYER</i>	<b>LYR VEL LO - HI</b>
	Press Edit / Layer / 3

This parameter allows you to set the velocity range in which the layer will respond. Outside the range selected, the layer will not play.

Range: 0 to 127

<i>EDIT LAYER</i>	<b>PITCH TBL</b>
	Press Edit / Layer / 4

This parameter determines whether a layer will use the STANDARD (equal tempered) pitch table, or play each WaveSample in the layer at the pitch it would play on C4 (NO PITCH), or use any pitch table you create. See the discussion of the Command/Pitch EDIT PITCH TABLE command earlier in this section for more on creating and editing pitch tables.

Range: STANDARD, NO PITCH, USER PITCH TABLES 1-8.

<i>EDIT LAYER</i>	<b>LYR NAME</b>
	Press Edit / Layer / 5

Use the data entry controls to change the name of an existing layer, or name a new one that you've just created (the **Left/Right Arrow** buttons move the cursor, and the **Data Entry Slider** and the **Up/Down Arrow** buttons change the characters).

<i>EDIT LAYER</i>	<b>DELAY - VEL AMOUNT</b>
	Press Edit / Layer / 6 (for Delay) 7 (for Velocity Amount)

The DELAY parameter determines how long voices within the selected layer will wait after a key is struck before playing. This parameter is adjustable from 0 to 5000, with each value increasing the delay by 1 millisecond.

The VELOCITY AMOUNT is a modulation amount, with velocity serving as a dedicated modulation source. Positive values will cause harder velocities to increase the DELAY time. Negative values will cause harder velocities to decrease the DELAY time. Setting the DELAY to zero will disable velocity modulation of DELAY time.

<i>EDIT LAYER</i>	<b>LAYER RESTRIKE TIME</b>
	Press Edit / Layer / 8

This parameter sets the amount of decay voices within the selected layer will have after they have been restruck. The higher the value, the longer the decay time.

Range: 0 to 99

EDIT LAYER	<b>STEREO LAYER LINK</b>
	Press Edit / Layer / 9

Stereo samples are stored in pairs of adjacent layers (1&2, 3&4, 5&6, or 7&8), with the LEFT channel always stored in an odd numbered layer (1, 3, 5 or 7), and the RIGHT channel stored across the same key range in the next higher even numbered layer. These paired adjacent layers are called *companion* layers.

The STEREO LAYER LINK parameter is automatically turned ON after a stereo sample is recorded. When this parameter is turned ON in the selected LAYER, it is simultaneously turned ON in the companion layer. When STEREO LAYER LINK= ON, simultaneous editing of both channels of a Stereo Sample is enabled (see below).

When STEREO LAYER LINK= ON, editing layer or WaveSample parameters in one layer will edit the same parameter in the companion layer. Editing with the **Data Entry Slider** will set the current parameter in both layers to the same absolute value. Editing with the **Up/Down Arrow** buttons will edit parameter values in both layers *relative* to one another.

When STEREO LAYER LINK= ON, all pitch modulation in the right layer will be slaved to the settings in the WaveSamples assigned to the same or overlapping key zones in the left layer. This includes BEND RANGE, NOISE RATE, and all pitch modulation. Pitch modulation settings for WaveSamples in the right layer will be ignored.

STEREO LAYER LINK can be turned OFF to allow independent editing of layers that contain one channel of a stereo sample.

If the companion layer does not exist, STEREO LAYER LINK cannot be turned ON in the selected layer. The screen will display NO COMPANION LAYER.

When performing wave data commands with STEREO LAYER LINK= ON, both the selected WaveSample and the WaveSample in the companion layer must be the same size. If the two WaveSamples are not the same size, the display will read SAMPLES NOT SAME SIZE, and the command will not be performed.

**Tip:** You can quickly access this parameter by double-clicking the **Layer** button when in Edit mode.

Range: OFF, ON

## Command/Layer Page

These commands allow you to create, copy, and delete whole layers.

<i>CMD</i>	<b>CREATE NEW LAYER</b>
<i>LAYER</i>	Press Command / Layer / 0

Use this command to create a new layer in the currently selected instrument.

- Select CREATE NEW LAYER.
- Press **Enter•Yes**. The display reads LAYER ## CREATED.

<i>CMD</i>	<b>COPY LAYER</b>
<i>LAYER</i>	Press Command / Layer / 1

Use this command to copy an existing layer and all the WaveSamples in it, either within an instrument or from one instrument to another.

- Select COPY LAYER. The display reads TO INST=UNNAMED INST.
- Select the destination instrument. Press **Enter•Yes**.
- Select COPY=PARAMS ONLY/PARAMS+DATA. It is a good idea to choose PARAMS ONLY when copying a layer within the same instrument, allowing the wave data to be shared. This will conserve memory. However, *always* choose PARAMS+DATA when copying a layer from one instrument to another, or else the destination instrument will not contain the wave data when it is saved to disk, and subsequently reloaded.
- Press **Enter•Yes**. The display reads LAYER ## CREATED.

**Note:** When STEREO LAYER LINK= ON, this command will also copy the companion layer. However, in order for this to work properly, there *must* be two undefined adjacent layers available.

<i>CMD</i>	<b>DELETE LAYER</b>
<i>LAYER</i>	Press Command / Layer / 2

Use this command to delete a layer in the currently selected instrument. This will delete all WaveSamples in the selected layer as well.

- Choose the layer you want to delete.
- Select DELETE LAYER.
- Press **Enter•Yes**. The display reads DELETE LAYER ##.
- Press **Enter•Yes** or **Cancel•No**.

**Note:** If you get the message NO EDIT LAYER SELECTED, simply press **Edit** and select the layer you want to copy or delete, and then proceed with the command.

---

# Section 12 — Sequencer & Audio Track Concepts

---

This section contains an introduction to the ASR-10 sequencer and all the information you'll need to get started sequencing. For more detailed descriptions of the actual parameters, refer to the following section.

## Sequencing on the ASR-10

The ASR-10 sequencer incorporates a range of features and capabilities you would expect to find in stand-alone or computer sequencers, yet with the advantage of being part of an integrated system.

The ASR-10 is both powerful and easy to use — having your sampler, sequencer, and master keyboard controller right at your fingertips in one unit is what makes the ENSONIQ approach to digital sequencing so intuitive and efficient.

If you can't wait to start sequencing, you can turn right to "Recording a Sequence" later in this section. We recommend, however, that you come back and familiarize yourself with the many other sequencer controls and functions described in this section. This is the only way to truly take advantage of the power of the ASR-10 sequencer.

## Digital Sequencing

Imagine a recorder which, instead of recording the sounds of an instrument, records the same kind of digital information that is sent and received via MIDI — key down, key up, key number and velocity, pitch bend, mod wheel, program changes and so on — and you have imagined a *digital sequencer*.

A sequencer records and plays back the "control information" rather than the actual notes. This means that there is no degradation of the sound in the recording process no matter how many times you overdub or rerecord a part. A sequencer is sort of like an electronic player piano.

It is important to bear in mind that a sequencer only records what you play. Sequencer memory is used up on the basis of *Events* (keys struck, controllers, etc.), while a tape recorder's memory (the tape) is always used up by the same amount over a fixed period of time.

This means that a sequencer will use virtually the same amount of memory to record 100 notes, whether you play those notes over ten seconds or ten minutes. When you strike a key, the sequencer records a *Key Down* event. It then counts the *clock* pulses until you release the key, when it records a *Key Up* event. The amount of time between the key down and the key up doesn't really affect the amount of memory required to record the note. Compare this to an audio tape recorder. With tape, *time* is the main factor. A tape recorder will use the same amount of tape to record a minute of music, whether the signal contains one note or one hundred.

You might say that tape is *linear* — it is used at a fixed rate, while digital sequencer memory is *dynamic* — it is used only as needed. Understanding the difference will help you to manage the ASR-10 sequencer memory. For example, while key events (the notes you play) use up relatively little memory each, controllers such as pressure, mod wheel, pitch bend, etc., are recorded as a flood of numbers that can fill up the memory in a hurry. Thus, if you're trying to squeeze one more track into a sequence when there is not much memory left, you should go easy on the controllers.

### What is a Sequence?

A sequence on the ASR-10 is a collection of eight independent tracks and their associated notes, controllers, etc.

The ASR-10 can have up to 80 sequences in its internal memory at once. Each sequence has its own 12 character name and time signature. A sequence can be up to 999 bars long.

You select the current sequence (the sequence you want to play or record) on the Edit/Seq•Song page. Press **Edit**, then double-click on **Seq•Song** to go directly to the Select Seq/Song parameter.

You can save an individual sequence to disk, though in most cases it is more useful to save the entire song with all its related sequences.

### What is a Song?

The sequences in memory can be chained together into a song. There can only be one song in memory at a time. The song also has its own 12 character name.

The song is selected on the Edit/Seq•Song page just as you would select a sequence. When the song is selected, the SONG indicator lights on the display.

In Song mode, sequences are assigned to play consecutively in any order, with up to 99 Steps, and up to 63 Repetitions of each step. Within each song step, individual tracks within the sequence can be muted or transposed.

After chaining together sequences into a song, you can record another complete set of song-length tracks that are separate from the individual sequence tracks, but share the same instruments. These “Song Tracks” are stored with the song. This makes the ASR-10 sequencer a sixteen track recorder (see Song Mode later in this section).

When you save a song to disk (using the SAVE SONG + ALL SEQS command on the Command/Seq•Song page), the ASR-10 automatically saves all the sequences currently in memory along with the song (it doesn't save the instruments; they must be saved separately). When you later load the song into memory (by itself or as part of a Bank), all the sequences will be loaded in along with it.

### Banks

The way to make sure that all the instruments are loaded into the proper locations, all the mix and pan levels for each track are properly preserved, and that the proper effect and related settings are in place is to save the whole contents of the ASR-10 memory as a Bank. Loading a bank file (instead of loading the song and the various instruments separately) ensures that every instrument will be loaded into the proper **Instrument•Sequence Track** location, so that the tracks will all play the right sounds.

### Sequencer “Transport Controls”

The three large buttons to the right of the **Audio Track** buttons serve to start and stop the sequencer, and to put it into Record and Overdub modes. In addition to these three buttons, the Left Foot Switch (available only when an optional SW-10 Dual Pedal Foot Switch is connected to the ASR-10 Foot Switch jack and the Edit/System•MIDI LEFT FOOT SW= STOP/CONT) can be used to start and stop the sequencer when both hands are busy.



Left Foot Switch

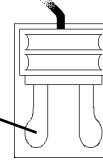

- Pressing **Play** will start the current sequence or the song (whichever is selected) playing from the beginning.
- Pressing **Stop • Continue** will stop the sequencer (if pressed while it is running); or will play the current sequence or the song from wherever it was last stopped (if pressed while the sequencer is stopped).
- The Left Foot Switch will duplicate the behavior of the **Stop • Continue** button.
- Pressing **Play** while holding down **Record** will start the sequencer recording on the current track from the beginning of the sequence or song.
- Pressing **Stop • Continue** while holding down **Record** will start the sequencer recording on the current track from wherever it was last stopped.
- Pressing **Record** while the sequencer is playing will put the sequencer into "Punch In" mode. It will wait for you to either start playing, or press the Left Foot Switch before going into Record on the current track.

### Sequencer Status

The sequencer is always in one of the following states; the sequencer Status Indicators in the upper right part of the display always tell you what the current status is:

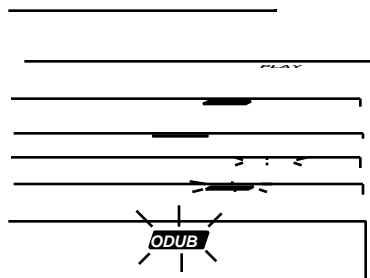

- **-PLAY —** Playing current Sequence or the Song
- **-REC —** Recording on current Track, first pass
- **-ODUB —** Overdub: Re-recording current Track
- **-PLAY (flashing) —** Countdown playing prior to going into Play, Record or Overdub
- **-REC (flashing) —** Recording on current Track, second pass

- **ODUB (flashing) —** "Punch-in" Standby: waiting for you to either play or press the Left Foot Switch before going into Overdub

## Loading and Saving Sequencer Data

There are two ways that ASR-10 Sequencer data can be stored on a disk:

- **SONG File.** A song file contains a song *and* all its related sequences. Loading a song file from disk will completely erase the current contents of the ASR-10 sequencer memory, replacing whatever is there with the song and sequences from the disk file.
- **SINGLE SEQUENCE File.** This type of file contains just one sequence. Loading a single sequence file will *not* erase the sequencer data already in memory — the new sequence simply becomes one more sequence in the internal memory which can be selected or used as a step in a song. There can be up to 80 sequences in memory at once.

### Loading a Song or a Single Sequence from Disk

Both types of sequencer files are accessed from the Load/Seq•Song page.

- Press **Load**, then press **Seq•Song**.  
The LOAD indicator flashes, meaning that the ASR-10 is showing you disk files.
- Press the **Up** or **Down Arrow** button until the file you want to Load is showing on the display:



When a SONG file is showing, the SONG indicator lights next to the SEQ indicator.



When a single SEQUENCE file is showing, only the SEQ indicator lights.

- Press **Enter•Yes** to load the sequencer file showing on the display. After you have loaded a song or sequence, it is automatically selected.

### Important:

Remember that loading a song or sequence does not ensure that the right instruments are loaded into the proper **Instrument•Sequence Track** locations. Each track of each sequence will play whatever instrument is in that location at the time. The way to make sure everything is in the right place is to save the contents of memory (including the song) as a bank.

### Saving a Single Sequence to Disk

Use the SAVE CURRENT SEQUENCE command to save a single sequence.

- On the Edit/Seq•Song page, select the sequence you want to save.
- Insert a formatted disk into the drive.
- Press **Command**, then press **Seq•Song**.
- Press the **Left** or **Right Arrow** button until the display reads SAVE CURRENT SEQUENCE.
- Press **Enter•Yes**.
- Edit the Sequence Name (if needed):

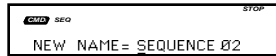

NEW NAME= SEQUENCE 02

The display shows the current name of the sequence, with a cursor (underline) beneath the first character. If you want to give the sequence a new name, do so at this time. Use the **Data Entry Slider** or the **Up/Down Arrow** buttons to change the underlined character, then press the **Left/Right Arrow** buttons to move the underline. Repeat until the display shows the name you want (if you don't need to rename the sequence, just skip this step).

- Press **Enter•Yes**. The display will read SAVING <FILE NAME> while the sequence is being saved.
- If there is already a sequence file with the same name on the disk, the display will ask DELETE OLD VERSION? Press **Enter•Yes** to save the sequence, replacing the one on the disk. Or press **Cancel•No** to abort the procedure.
- If there is not enough free space on the disk, the display will say NOT ENOUGH DISK SPACE. Save the sequence to another disk (or delete some files from the disk).
- If you try to SAVE CURRENT SEQUENCE while the song is selected, the ASR-10 will not execute the command, responding USE SAVE SONG + ALL. Again, make sure the sequence is selected before trying to save it.

### Saving a Song (along with all Sequences) to Disk

Once you have created a song or made changes to an existing one, you can save the song to a formatted ASR-10 disk. In addition to saving the song itself, the SAVE SONG + ALL SEQS command saves all the individual sequences currently in memory (whether they are part of the song or not). To save a song:

- Insert a formatted disk into the drive.
- Press **Command**, then press **Seq•Song**.
- Press the **Left** or **Right Arrow** button until the display reads SAVE SONG + ALL SEQS.
- Press **Enter•Yes**.
- Edit the song name (if needed):



NEW NAME= \*\*\* SONG \*\*\*

The display shows the current name of the song, with a cursor (underline) beneath the first character. If you want to give the song a new name, do so at this time. Use the **Data Entry Slider** or the **Up/Down Arrow** buttons to change the underlined character, then press the **Left/Right Arrow** buttons to move the underline. Repeat until the display shows the name you want (if you don't need to rename the song, just skip this step).



- Press **Enter•Yes**. The display will read **SAVING <SONG NAME>** while the song is being saved.
- If there is already a song file with the same name on the disk, the display will ask **DELETE OLD VERSION?** Press **Enter•Yes** to save the song, replacing the one on the disk. This is for updating songs to which you have made changes. Or press **Cancel•No** to abort the procedure.
- If there is not enough free space on the disk, the display will say **NOT ENOUGH DISK SPACE**. Save the song to another disk (or delete some files from the disk).
- Note that the song and all sequences in memory are saved as one file. You cannot extract a single sequence from a song file and load it separately. If you want access to a sequence individually, you must first load the song into the internal memory, and then save the individual sequence using the **SAVE CURRENT SEQUENCE** command.

## Selecting a Sequence/Song

Press the **Edit** button, then the **Seq•Song** button. The following screen will appear:

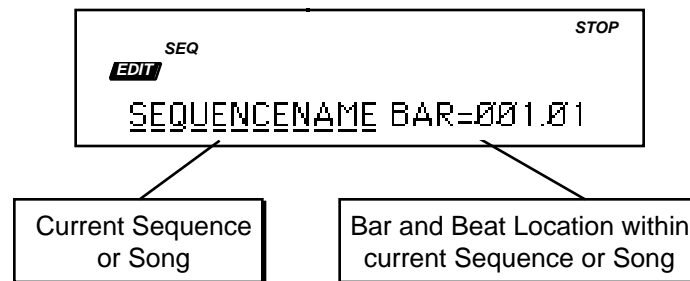

This screen is where you select a sequence or the song. With the selected sequence or song name underlined (as shown above), use the **Up/Down Arrow** buttons or the **Data Entry Slider** to select a different sequence or song. The display will indicate whether a song is selected:

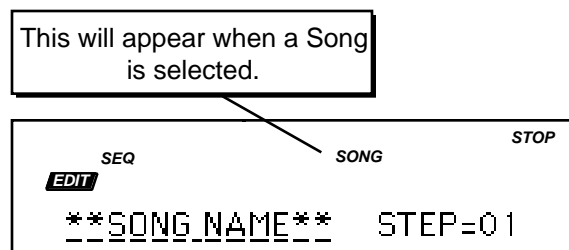

**Tip:** You can always get back to the Current Sequence/Song screen by double-clicking the **Seq•Song** button (when in Edit mode).

## Playing a Sequence/Song

Try selecting a sequence, and pressing the **Play** button in the sequencer section, to the right of the display. The selected sequence will begin to play.

While one sequence is playing you can select another one. You will see the name of the new sequence in the display, but the original one will continue to play. When the first sequence is finished, the sequencer will switch to the new sequence, and it will play. In this fashion you can string sequences together in real time, as they play.

Press the **Stop•Continue** button or the Left Foot Switch to stop the current sequence.

## Sequence Tracks

Each sequence is composed of up to eight tracks, which correspond to the eight **Instrument•Sequence Track** locations. That is, each instrument location also doubles as a track. Whatever is recorded on a given track will play on the instrument that is loaded into that **Instrument•Sequence Track** location.

You can only record on one track at a time. All sequence recording is done in Edit mode, and in Edit mode you can only select one **Instrument•Sequence Track** at a time.

You “mix down” sequences on the Edit/Track page. From the screens on this page you can play, mute, or solo each track; you can also adjust the MIX level, PAN setting, and Output Bus for each track (MIX, PAN, and OUT for each track are remembered when you save a bank).

The Audio Tracks also allow you to adjust the MIX level, PAN setting, and Output Bus for each track.

**Note:** When Editing Tracks, remember that the selected Track’s (**Instrument•Sequence Track** or **Audio Track** with its yellow LED solidly lit) parameters are the ones that are being viewed.

## Creating a New Sequence

- Press **Command**, then double-click the **Seq•Song** button. The display shows CREATE NEW SEQUENCE.
- Press **Enter•Yes**. The display will show NEW NAME= SEQUENCE 02 (or 03, 04, etc.). There is a cursor beneath the first character. You can now give the sequence a name of your choosing, or use the default name by skipping the next step.
- Name the new sequence, using the **Data Entry Slider** or the **Up/Down Arrow** buttons to change each character, and then pressing the **Left/Right Arrow** buttons to move the cursor to the next character. Continue this until the display shows the name you want.
- Press **Enter•Yes**.
- Select the time signature for the new sequence (or, if the time signature that’s showing is the one you want, just press **Enter•Yes** twice). The time signature for the sequence is set at this time and cannot be changed later. Adjust the top half of the fraction (numerator), then scroll right to select the bottom half of the fraction (denominator) and adjust that.
- Press **Enter•Yes**. The new sequence is created and becomes the currently selected sequence.

## Recording a Sequence

Here we will describe recording a new sequence from scratch. First we will concentrate on sequencing with the ASR-10 alone, and then cover recording MIDI instruments.

### 1) Create a New Sequence:

- Following the steps outlined earlier in this section, and create a new sequence.

### 2) Record the First Track:

- Select any loaded instrument by pressing its **Instrument • Sequence Track** button. This makes it the current track.
- While holding down **Record**, press **Play**. The ASR-10 immediately puts you on the **Edit/Seq • Song** page and the click track starts playing (assuming **CLICK=ON** or **REC** on the **Edit/Seq • Song** page), at the current tempo. The first beat of each measure is emphasized.
- Adjust the tempo. Press the **Right Arrow** button three times to scroll to the **TEMPO** parameter. Adjust it to the tempo you want with the **Data Entry Slider**, or press the **Enter • Yes** button twice in a row to use the tap tempo function.
- Play the keyboard to start recording. The bar in which you start playing becomes bar 1 of the sequence.
- Press **Stop • Continue** to end recording. The display will say **XXX BARS - KEEP TRACK?** The length (in bars) of the first track determines the length of the sequence.
- Press **Enter • Yes** to keep the track, defining the length of the sequence, or
- Press **Cancel • No** to erase the first track and start over again.

### 3) Record Additional Tracks:

- Select a different track. Again, selecting any loaded instrument by pressing its **Instrument • Sequence Track** button makes it the current track. Or you can leave the original **Instrument • Sequence Track** selected and overdub (re-record) that track.
- While holding down **Record**, press **Play**. After a one bar count off (if **COUNTOFF=CLICK** on the **Edit/Seq • Song** page) the ASR-10 goes into record and will record what you play on the selected track.
- Press **Stop • Continue**. The display shows:

```

  STOP          STOP
  KEEP =  OLD  NEW
  
```

This is called the **AUDITION** page. While playing the sequence, press the **Left/Right Arrow** buttons to move the cursor between **OLD** and **NEW** to hear the original track or audition the new track.

- With **NEW** underlined, pressing **Play** will play the new track, and pressing **Enter • Yes** will **KEEP** the new track, erasing the original. When **OLD** is underlined, pressing **Play** will play the **ORIGINAL** track, and pressing **Enter • Yes** will **KEEP** the original track. Note that on this page, pressing **Cancel • No** will always keep the original track.

### “Punching In” on a Track

Suppose you have a track that is fine for the first four bars but the next four bars need to be redone. You can “Punch In” at any point in the track by doing the following:

- Select the track you want to record on.
- Press **Play** to start the sequence or song playing.
- Press **Record**. This puts the ASR-10 in Overdub Standby — the ODUB indicator flashes on the display and the sequencer is waiting for you to play keys before going into record.
- Start playing (or press the Left Foot Switch) at the point where you want to punch in. As soon as you play anything, the ASR-10 goes into Overdub (or Record for a new track) and records what you play, leaving intact the part of the track before the punch in.
- Press **Stop•Continue**. You will see the Audition page as shown above, letting you play the new or the old track before deciding which to keep.

### Recording the Default Track MIX Setting

Each **Instrument•Sequence Track** has its own default MIX setting that is recorded each time that a sequence track is recorded/overdubbed. This default MIX setting is fixed, and applies to the entire duration of the track (unlike continuous volume changes recorded with the Foot Pedal, or MIXDOWN VOLUME events recorded on the songs tracks — see later in this Section). If the Edit/Track MIX value is edited during playback, the default track MIX setting will be restored each time the sequence loops around. To permanently change the default MIX setting for a track:

- Set SEQ REC MODE= ADD on the Edit/Seq•Song page. This will prevent any unwanted changes to existing track events.
- Select the **Instrument•Sequence Track** for which you want to adjust the MIX.
- Press **Play**, and then press **Edit**, followed by **Track**, and adjust the MIX value while listening to the track until you find the proper level.
- Once you’ve decided on the MIX value, press **Stop•Continue**.
- While holding down **Record**, press **Play**. After the first bar of the sequence has been recorded, press **Stop•Continue**.
- The KEEP= OLD/NEW Audition page will be displayed. You can’t audition the volume change on the KEEP=OLD/NEW page. Select KEEP=NEW and press **Enter•Yes** to keep the results. Press **Play**. You will now hear the new default MIX setting, and it will now be permanently recorded on the track. If you don’t like the new default MIX setting, simply repeat the above procedure and set a new MIX level.
- It’s a good idea to return to the Edit/Seq•Song page to set the SEQ REC MODE back to REPLACE for later sequencing.

**Tip:** You can use the optional CVP-1 Foot Pedal to record *continuous* volume changes onto a sequence track. Set PEDAL=VOLUME on the Edit/System•MIDI page, and then record the Pedal•CV controlled volume changes with SEQ REC MODE= ADD. This will record volume (MIDI Controller #7) events onto the track, which can then be edited like any other sequencer event.

For information about mixing down song tracks, see **Recording MIXDOWN VOLUME and MIXDOWN PAN**, later in this Section.

### Recording Another Track with a Copy of the Same Instrument

You will sometimes find that you want to record a second track using the same instrument. There is a quick way to make a “working copy” of any ASR-10 instrument in an unused location, without copying the sample data (thus conserving memory).

Suppose, for example, that you have recorded a track with a piano sound on Track 1. Now you want to record another track with the same sound, but with independent controllers, MIX level, PAN, OUT bus, etc. You can copy the piano into any empty **Instrument•Sequence Track** location (let’s say Track 4) by following these three steps:

### To Copy an Instrument to Another Location:

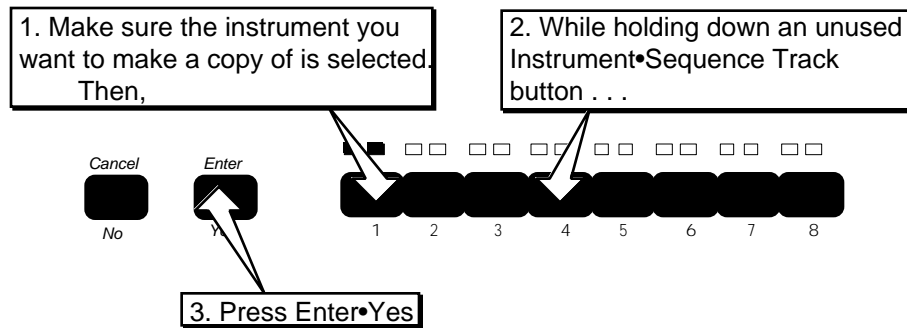

The display will read **PIANO COPIED**. **Instrument•Sequence Track 4** now contains a copy of the piano in **Instrument•Sequence Track 1**. You can now record on this track just as you would any other. Keys, controllers, etc. recorded on the new track will be independent from any recorded on **Instrument•Sequence Track 1**. You can Solo, Mute, MIX and PAN the new track independently from the original. The new track can be assigned to its own **MULTI-IN MIDI CHANNEL** and **OUT bus**. The two tracks simply “point to” the same sound. You can make as many copies of an instrument as you want. Instrument copies will not take up much additional memory, because they contain only “pointers” to the original sound.

### Additional Notes

- When you select an **Instrument•Sequence Track** location that contains a copy, it looks just like the original — the name and all its instrument parameters will be the same. In **LOAD** mode you can adjust the volume of a copied instrument, select, deselect and stack it as you would any instrument.
- These copied instruments are temporary things — the song or sequence doesn't know that it's playing a copy (in fact the song or sequence never knows what instruments are loaded into which locations). Any copied instruments will be forgotten when the ASR-10 is turned off unless you save the contents of memory as a bank (using the **SAVE BANK** command on the **Command/Instrument** page). When you load a bank, the ASR-10 recreates any copied instruments that were there when the bank was saved.
- You cannot edit the instrument, layer, or wavesample parameters of the copy independently. Any parameter changes made to the copy will affect the original, and vice-versa.
- If you load a new instrument into the **Instrument•Sequence Track** location that contains the original instrument, any copies of that instrument will be automatically deleted from memory.

☞ **Note:** When using the Version 2 O.S., the processing of sequencer editing may take a little longer than when using previous O.S. Versions. This is because the ASR-10 ensures the accurate processing of information, and needs to prepare Audio Tracks with each edit.

## MIDI Sequencing on the ASR-10 — MIDI Connections

You can sequence any remote MIDI device exactly as you would a local ASR-10 instrument:

- On the Edit/System •MIDI page, set the TRANSMIT ON parameter to TRANSMIT ON= INST CHAN.
- Create a MIDI instrument as shown in *Section 17 — Sequencing/MIDI Applications* and assign the MIDI instrument to transmit on the MIDI receive channel of the remote MIDI device you want to sequence from this track.
- Now select the MIDI instrument and proceed with recording the track just as you would any other track. All keys, controllers and program changes you record will be transmitted out via MIDI to the remote device. You can mix, mute, and solo these MIDI tracks on the Edit/Track page.

When sequencing multiple remote MIDI devices, first connect the various devices to the ASR-10, and to each other, as shown here. Connect the MIDI Out jack of the ASR-10 to the MIDI In jack of the first device. Then connect the MIDI Thru jack of the first device to the MIDI In jack of the second device. Connect the MIDI Thru jack of the second device to the MIDI In jack of the third device. An so on, for as many devices as you will be using.

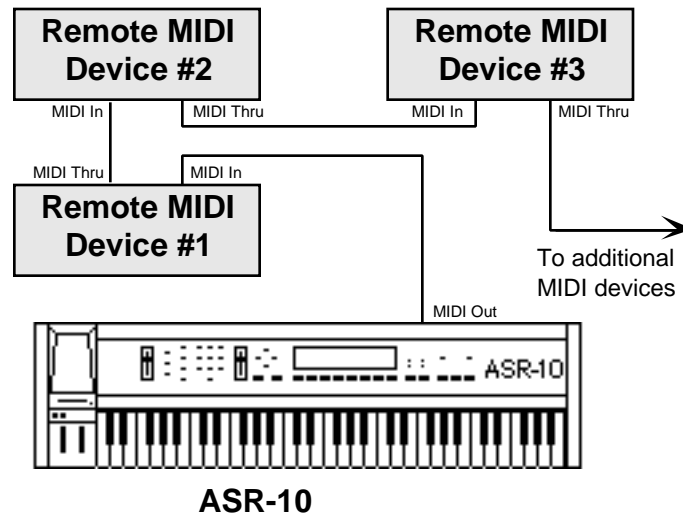

With this arrangement, once you set up the proper MIDI channels, etc. (see below), each remote MIDI device will receive and play only the data that is intended for it, and will “pass along” all other data. Also, each remote MIDI device can be played from its own keyboard without affecting the others, because MIDI Thru jacks only pass along incoming MIDI data, and do not transmit what is played on the instrument.

The above set up is ideal for controlling everything from the ASR-10. Simply by selecting the **Instrument • Sequence Track** that is set to transmit on the same MIDI channel as a particular remote MIDI device is set to receive on, you can:

- Play the remote MIDI device from the ASR-10 keyboard;
- Record a track that will play back on the remote MIDI device when you play the sequence or song; and
- Send the remote MIDI device program changes and adjust its volume (assuming the device receives MIDI Volume).

Once you have made the appropriate connections, and set up the MIDI configuration of the tracks and all remote MIDI devices, you can use the ASR-10’s keyboard and its front panel to control and record all the MIDI devices in your rig.

### MIDI Mode and Channel — Remote MIDI Devices

The next step is to set up each remote MIDI device to receive only the MIDI information that is intended for it. When each remote MIDI device is set to receive on a different MIDI channel (or a number of them, for multi-timbral units) you can control them all right from the ASR-10.

For each remote MIDI device:

- **Set to POLY (OMNI OFF) or MULTI Mode.** Each remote MIDI device must be in a mode where it receives *only* on its selected MIDI channel (or channels). This is usually referred to as POLY (or OMNI OFF) mode for receiving on a single channel, or MULTI mode for receiving independently on multiple channels. Consult the owner's manual if there is any question about a particular device.
- **Select a MIDI receive channel or channels.** The best idea is to assign each remote MIDI device its own MIDI receive channel(s) and leave it that way. If you know, for instance, that a certain synth is always set to receive on MIDI channel 4, you can quickly set up an **Instrument•Sequence Track** to drive that synth by simply creating a MIDI instrument (see *Section 17 — Sequencing/MIDI Applications*), then assigning that instrument to transmit on MIDI channel 4. Also when each remote MIDI device is always set to its own distinct MIDI channel, it means that different sequences and songs recorded at different times will always play the right instrument on the right track.

Once you have assigned MIDI receive channels to each MIDI device in your rig, *write them down*, and keep the paper handy for quick reference.

### Recording MIDI Tracks

Once everything is set up, you can proceed with recording MIDI instruments exactly as you would for instruments with LOCAL or BOTH status that will play locally. Tracks that are transmitted out via MIDI are treated the same as internal tracks in terms of recording, overdubbing, punching in, editing, etc. Follow the same steps outlined earlier in this section for recording the first track and then for additional tracks.

For each successive track you record, the procedure will follow the same lines:

- Define the MIDI configuration for the **Instrument•Sequence Track**,
- Record the track, and then
- Either keep or discard the new track from the KEEP=OLD/NEW page.

MIDI Instruments can be selected and stacked from the **Instrument•Sequence Track** buttons, and can be muted or soloed from the Edit/Track page, the same as any other tracks. Edit/Instrument parameters such as Volume, Key Zone, and Transpose all apply to MIDI tracks just as they do with LOCAL tracks.

Most often you will be recording sequences and songs that play some MIDI instruments and some LOCAL Instruments. When this is the case, be sure that you set the Edit/Instrument MIDI STATUS to LOCAL (as opposed to BOTH) for the instruments on the tracks that you want to play only on the ASR-10. This will avoid accidentally transmitting unintended MIDI data to any external MIDI devices when you play the sequence or song.

## Recording Program Changes

The ASR-10 allows program changes to be recorded onto any track of a sequence at any point within the sequence.

To record a program change onto a track:

- Make sure that RECORD MODE=ADD in the Edit/Seq•Song page.
- Enter Overdub mode by pressing **Play**, followed by the **Record** button. The “ODUB” indicator light will begin flashing.
- While holding down the appropriate **Instrument•Sequence Track** button (the one that corresponds to the track onto which you wish to record the program change), use the numeric keypad to type in the program number you want to be recorded.
- Release the **Instrument•Sequence Track** button at the point within the sequence that the program change should occur. The program change will be recorded on the track *the moment the button is released*.

## Recording into the ASR-10 Sequencer from a MIDI Controller

On many occasions, you may find it convenient to use an external controller to record a track into the ASR-10's internal sequencer. This could be for added authenticity (recording from Drum Pads to get a “live drummer” feel), performance flexibility (recording from a weighted-action MIDI keyboard controller like the ENSONIQ KS-32), or ease of use (a guitarist recording from a guitar controller). No matter which type of MIDI controller you use, there are a few parameters that need to be set in order to record into the sequencer.

### Recording Onto a Single Track (One MIDI Channel)

- Connect a MIDI cable from the MIDI Out of the controller to the MIDI In of the ASR-10.
- Set the MIDI IN MODE to POLY on the Edit/System•MIDI page. The MIDI controller should be in POLY mode as well.
- Set the ASR-10 MIDI BASE CHANNEL to the same MIDI channel that the MIDI controller is set to transmit on.
- Select the track you want to record on by pressing the appropriate **Instrument•Sequence Track** button on the ASR-10. Make sure the Instrument on the selected **Instrument•Sequence Track** has its Edit/Instrument MIDI STATUS set to BOTH, LOCAL, or MIDI.
- On the Edit/Seq•Song page, set the SEQ REC SOURCE parameter to BOTH or MIDI.

Recording proceeds normally from this point, with the sequencer responding to the data from the MIDI controller the same as it would to data from its own keyboard.

### Recording Onto Several Tracks (Multiple MIDI Channels) — Multi-Track Record

When (Edit/Seq•Song) SEQ REC SOURCE=MULTI, the ASR-10 will record incoming MIDI information simultaneously on *all* tracks that have an instrument loaded. This is ideal for downloading a sequence created on an external sequencer all in one pass. The ASR-10 will not record notes played on its own keyboard. Each track should be set to a different MULTI-IN MIDI CHAN on the Edit/Track page. If two tracks have the same MULTI-IN MIDI CHAN, only the lower numbered track will be recorded.

- Connect a MIDI cable from the MIDI Out of the external sequencer to the MIDI In of the ASR-10.
- Set the MIDI IN MODE to either MONO B (for guitar controllers sending on individual strings) or MULTI (for transferring data from another sequencer) on the Edit/System•MIDI page.
- Disable countoff on *both* systems to avoid problems. On the ASR-10, this is found on the Edit/Seq•Song page.



- Disable sequence looping on the external sequencer (LOOP=OFF).
- Create a new sequence with the correct time signature on the ASR-10.
- Set the individual MULTI-IN MIDI CHANNEL (found on the Edit/Track page) for each track, matching MIDI channels with those that will be transmitted on by the external sequencer. Different MIDI receive channels must be selected for each **Instrument•Sequence Track** that you want to receive via MIDI. If more than one sequence track is set to the same MULTI IN MIDI CHAN, only the lowest numbered **Instrument•Sequence Track** will receive via MIDI.
- Make sure that the Instruments on all of the tracks you want to record on have their Edit/Instrument MIDI STATUS set to BOTH, LOCAL, or MIDI.
- On the Edit/Seq•Song page, set the SEQ REC SOURCE parameter to MULTI.
- If recording from an external sequencer, set the ASR-10 to sync to MIDI clocks. On the Edit/Seq•Song page, select CLOCK SOURCE=MIDI. Set this parameter to INTERNAL if recording “live” from a MIDI guitar or other multi-channel controller.

With these parameters set, pressing the **Record** button places the ASR-10 into Record Waiting mode (the display will flash WAITING. . .). If external sync is used (CLOCK SOURCE=MIDI), recording begins with the first MIDI clock received after the MIDI Start command. If internal sync is selected (CLOCK SOURCE=INT), then recording begins when the first note is received.

Once the **Stop•Continue** button has been pressed, the ASR-10 displays the ###BARS-KEEP TRACK? message. Pressing the **Enter•Yes** button will save the data. The EDITING DATA... message is displayed while the sequencer is processing the data you have recorded. The time required for processing depends on how much data and how many tracks were recorded. It can take several minutes. You can either re-record or erase the tracks (or the entire sequence or song) if you do not wish to keep the results after recording.

Multi-Track Record always operates in REPLACE mode, and when SEQ REC MODE= MULTI the SEQ REC MODE parameter on the Edit/Seq•Song page is automatically set to REPLACE, and cannot be edited. However, while tracks are being rerecorded in MULTI, both the original and new tracks can be heard. This can be confusing, but only the new tracks are being recorded, and when played back the sequence will sound fine.

**Tip:** It is possible to record multi-track sequences from the keyboard, but only if you set the Edit/Instrument MIDI Status to MIDI for each of the active (primary and layered) **Instrument•Sequence Tracks** and then set up a MIDI loop (by connecting the ASR-10 MIDI Out to its own MIDI In). This procedure is a bit tricky, and should only be attempted if you have a good understanding of the system.

**Note:** When SEQ REC SRC= MULTI, the sequencer will always record both channel and key pressure received via MIDI, no matter what the Edit/Instrument PRESSURE MODE parameter is set to.

For more information about sequencing, see *Section 17 — Sequencing/MIDI Applications*.

## Song Mode

The ASR-10's Song mode allows you to chain individual sequences together to form a song. Since each sequence has a fixed length, tempo, and time signature, you can use the Song mode to create works with tempo and time signature changes. However, Song mode on the ASR-10 lets you do much more than just play sequences in order.

First, for each step of the song you can selectively mute or transpose any of the tracks in the sequence. And second...

*You can record in song mode.* An ASR-10 song offers you another set of 8 tracks, called song tracks, which let you record over the entire length of the song. The information recorded in these song tracks is separate from information in the tracks of the individual sequences which comprise the song. However, each song track *does* "share" an instrument with the same-numbered sequence track. The following are a few things to remember about ASR-10 song mode:

- There is only one song in the ASR-10 at a time. Whenever the song is selected, (as opposed to one of the sequences) the SONG indicator lights on the display:

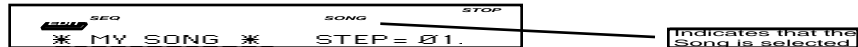

The SONG indicator remains lit as long as the song is selected, no matter what mode the ASR-10 is in or page it is on. Whenever the SONG indicator is *not* lit, an individual sequence is selected.

- You select the song in the same way that you select sequences, on the Edit/Seq•Song page (press **Edit**, then double-click on **Seq•Song**).
- Songs are composed of steps. For each step of the song, you define:
  - Which sequence will play during that step;
  - The number of repetitions (REP) – how many times the sequence will play during the step;
  - The status (Play, Mute, or Transpose) of each track of the sequence during the step; and
  - The transpose amount, which determines how far any transposed tracks in that step will be shifted up or down in pitch.

A song can contain as many as 99 steps, with up to 63 repetitions of each step.

- Putting together an ASR-10 song involves the following steps:
  - Record (or load from disk) the various sequences that you want to combine to form the song.
  - Construct the song, using the Edit SONG STEPS command on the Command/Seq•Song page (see below).
  - Record any song tracks.
  - Save the song (along with its component sequences) using the SAVE SONG + ALL SEQs command on the Command/Seq•Song page.
  - As a final step, it's always a good idea to save the contents of memory as a bank, so that you can later load the song and load all the instruments into the proper locations, just by loading the bank.

## Making a Song (Command/Seq•Song, EDIT SONG STEPS)

Once you have recorded a number of sequences that you want to chain together into a song:

- Press **Command**, then **Seq•Song**.
- Press the **Left/Right Arrow** buttons until the display shows EDIT SONG STEPS.
- Press **Enter•Yes**. The following page appears:

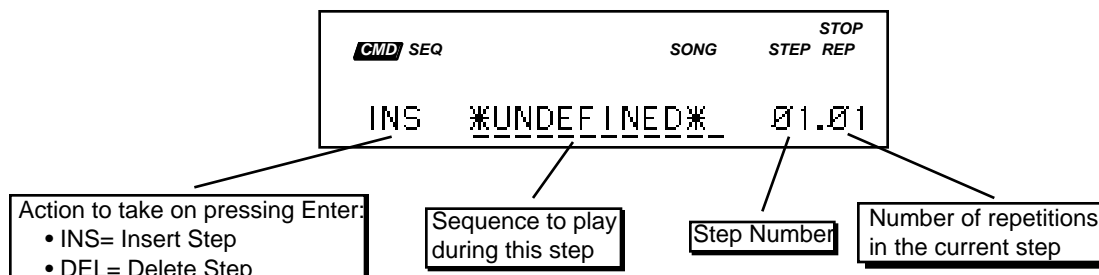

There are four things that can be selected (underlined) on this screen:

- On the left you can choose **INS** (insert step) or **DEL** (delete step). This is normally set to **INS**, for inserting new steps into your song (see the following page for details about deleting steps).
- In the middle of the screen you choose which sequence will play for this song step. This space currently reads **\*UNDEFINED\***, as shown above, when no steps have yet been defined for the song.
- To the right of the display you see the step number (which in the case of a new song will be step 1) and the number of repetitions (or reps) for that step.

For each song step that you want to create:

- Move the cursor (if it's not already there) to underline the sequence name, which currently reads **\*UNDEFINED\***.
- Press the **Up/Down Arrow** buttons to select among the sequences in memory until the display is showing the name of the sequence you want to play during that step.
- Scroll right to move the cursor to the number of repetitions (**REP**), and adjust the number of times you want the sequence to play during the step. (If you only want the sequence to play once during the song step, leave it set to 01.)
- Press the **Right Arrow** button again to reveal the following **TRACK STATUS** display:

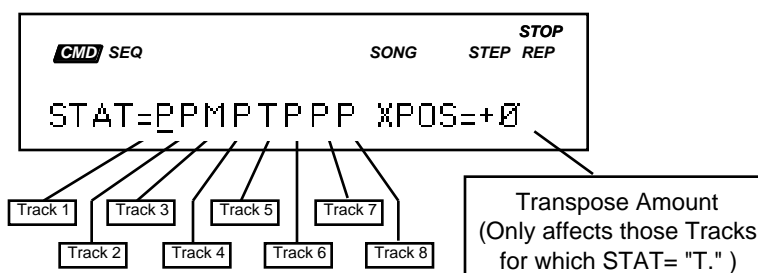

Here, for each step of the song, you can select Play, Mute, or Transpose Status for each track of the sequence.

- "P" means **PLAY** - tracks that show a "P" will play normally.
- "M" means **MUTE** - selecting "M" for a track will silence that track during the song step.
- "T" means **TRANSPOSE** - tracks that show a "T" will be transposed up or down, by the amount shown to the right, for the duration of the step.

If you want to mute or transpose any of the tracks during that step, scroll until that track is underlined, and use the **Up/Down Arrow** buttons to select “M” (mute) or “T” (transpose) for that track.

If you have selected “T” to transpose any of the tracks during the song step, scroll right to underline the Transpose (XPOS) Amount. This can be adjusted in one-semitone steps from -12 (down one octave) to +12 (up one octave). This control will only affect tracks for which “T” Status has been chosen. Conversely, if you choose “T” status for one or more tracks, but leave the Transpose Amount set at zero, it will have no effect.

- Press the **Left** or **Right Arrow** button to return to the first Song Step Editor screen.

Once the sequence and number of REPs are correct, press **Enter•Yes** to create step 1 of the song. The display will briefly read “EDITING...,” and then will display step 2:

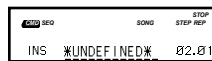

Now repeat the above procedure to define step two of the song.

For each step, choose a sequence and a number of repetitions and then press **Enter•Yes** to create the step.

- There is always one \*UNDEFINED\* step *after* the last step in the song.

### To Go to a Different Step in the Song:

Move the cursor to underline the step number, and use the **Up/Down Arrow** buttons to go to any step within the song. After you have finished editing the song steps (or at any point during the process, for that matter) you can go back through the song to check that all the steps are right.

### To Change Anything in an Existing Song Step:

To change any of the variables (sequence to play, number of reps, track mute or transpose) within a song step that has already been created, simply go to that step, as described above, select the variable you want to change and change it. You don't have to press **Enter•Yes** to make the changes permanent. You only have to press **Enter•Yes** to actually insert or delete a step.

### To Insert a Step Anywhere in the Song:

- Go to the step that you want the new step to precede. That is, if you want to insert a step between step 2 and step 3, go to step 3.
- Move the cursor to underline the sequence name.
- Use the **Up/Down Arrow** buttons to select the sequence you want to play for the new step.
- Set the number of repetitions and any mute or transpose settings for the step as shown earlier.
- Press **Enter•Yes**. The new step is inserted. If, as in the example above, you go to step 3 and insert a step, the step you inserted becomes the new step 3. What was step 3 becomes step 4, and so on.

### To Delete a Step Anywhere in the Song:

- Go to the step that you want to delete.
- Move the cursor to underline INS at the left of the display.

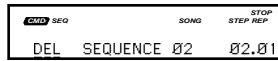

- Press the **Up Arrow** button to change INS (insert) to DEL (delete).
- Press **Enter•Yes**. The step that was showing will be deleted.

When you are through editing the song, press **Cancel•No** to exit the song step editor. Press **Edit** and then double-click on **Seq•Song** to go the Sequence/Song Select parameter. You will see that the song is selected. Press **Play** to play the song. When playing back a song from this page, the display shows:

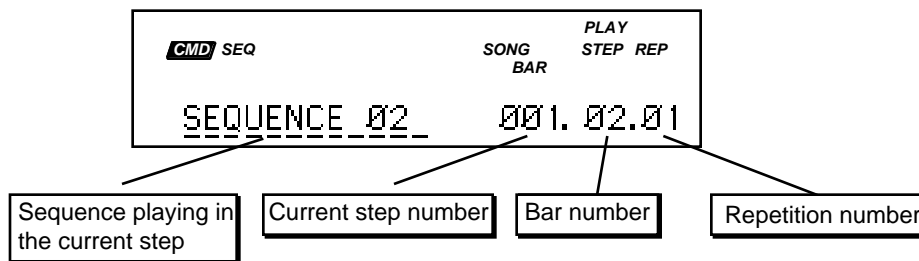

## Song Tracks

A song on the ASR-10 is much more than simply a group of sequences chained together. Once you have created a song and edited its steps, you can record another complete set of 8 song-length tracks. The length of the song tracks is determined by the combined length of the song's component sequences.

### Recording Song Tracks

Let's suppose you have constructed a song. For our example we will take a simple case:

- You have recorded three sequences, each using five tracks, and combined them into a song.
- Step one of the song is Sequence 01 (a 4-bar sequence) for 1 repetition;
- Step two is Sequence 02 (an 8-bar sequence) for 1 repetition; and
- Step three is Sequence 03 (a 4-bar sequence) for 1 repetition.

Your song would look like this:

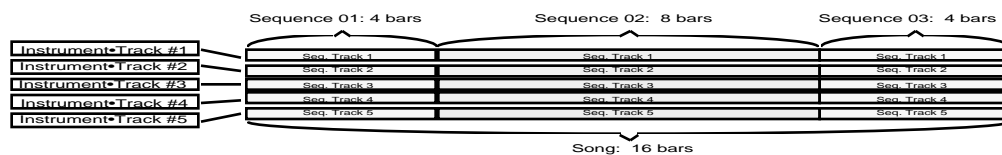

Now, with the song selected, you can enter Record (by holding down **Record** and pressing **Play**) and record a new song-length track on any of the five tracks. Follow the same procedures for recording song tracks that you would for sequence tracks. The only difference is that a song track is associated with the song itself and not with the individual sequences that comprise the song.

Continuing with the previous example, the song tracks might look like this:

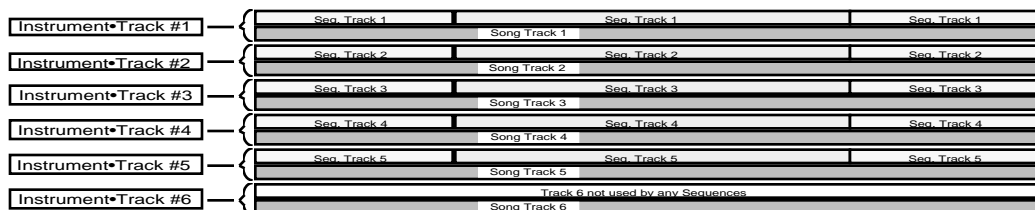

Any notes and controllers recorded in a song track will play the instrument loaded into that location — song tracks “share” the eight **Instrument•Sequence Track** locations with the corresponding sequence tracks. Therefore they are not entirely independent. For example pitch bends, sustain pedal, pressure, and any other controllers recorded into a song track will also affect notes recorded on the corresponding sequence tracks.

For this reason it is often a good idea to record a song track in a location not used by any sequences, as with track six in the illustration above. You could load a piano sound into **Instrument•Sequence Track 6** and record a song track with that sound that would remain completely independent of any tracks in the individual sequences. Or, make a copy of an instrument in an unused **Instrument•Sequence Track** location and record a song track using the copy.

- When the song is selected, if you go to the Edit/Track page you will find a third screen has been added — it looks just like the track status screen for a sequence except it says SNG instead of SEQ in the left corner of the display. This shows you the status of the song tracks. You can select P (play), M (mute), or S (solo) for any of the song tracks just as would sequence tracks. Note, however, that changing the mix or pan of a song track will also affect any corresponding sequence tracks.

**Note:** Any recording or track editing performed while in song mode will affect the song tracks, not the tracks of the individual sequences. To do any track editing (or additional recording) within the individual sequences of a song, you must first select that sequence from the Edit/Seq•Song page.

### Recording MIXDOWN VOLUME and MIXDOWN PAN

The song tracks can record a dynamic mixdown that allows you to record volume and pan changes over time. You can record *continuous* volume changes, by editing the Edit/Track MIX parameter while recording with SEQ REC MODE= ADD on a song track. This will record MIXDOWN VOLUME events onto the selected song track, overriding the default MIX setting for the corresponding sequence track. This allows you to record fade in and out mixdown information across multiple sequences. In addition, MIXDOWN PAN events can be recorded by editing the Edit/Track PAN parameter while recording with SEQ REC MODE= ADD. Here's how:

- 1) Select the song by pressing **Edit**, then **Seq•Song**. Double-click the **Seq•Song** button, and use the **Data Entry Controls** to select the song (the SONG indicator will light).
  - 2) Scroll left and set SEQ REC MODE= ADD. This will prevent any unwanted changes to existing song track events.
  - 3) Select the **Instrument•Sequence Track** that corresponds to the song track on which you want to record MIXDOWN VOLUME.
  - 4) While holding down **Record**, press **Play**.
  - 5) Press **Edit**, then **Track**, and when the sequencer enters Record/Overdub mode, adjust the MIX value while the sequencer plays back. The volume changes you hear will be recorded as MIXDOWN VOLUME events.
  - 6) Press the **Stop•Continue** button, and press **Play** to listen to your newly recorded mix. If your happy with the results, select KEEP= NEW on the Audition page, and then press **Enter•Yes** to keep the results. The new MIXDOWN VOLUME events will now be permanently recorded on the song track.
- Follow the same procedure to record MIXDOWN PAN events. At step 5 however, edit the PAN value.

## About Audio Tracks

Audio Tracks serve three basic purposes:

- Sing/Play through them — The Audio Tracks allow continuous audio monitoring of the stereo audio inputs through effects (if desired), enabling you to sing along (or play a guitar) through effects while playing a sequence, for example.
- Sample through them — The signal monitored through the Audio Tracks (mono or stereo) is the signal that will be sampled.
- Record through them — Audio Tracks can be recorded directly into RAM (RAMTracks™) or directly to a SCSI Storage Device (hard disk, removable media, etc.) via the optional SP-3 SCSI Interface (DiskTracks™).

The ASR-10 has two Audio Track buttons, labeled **A** and **B**. Each audio track has its own mix, pan, and output bus assignment, as set on the Edit/Track page. The two **Audio Track** buttons are located to the right of the **Instrument • Sequence Track** buttons:

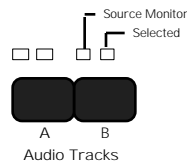

Each **Audio Track** button has 2 LEDs located directly above it:

- The left LED is red, and is labeled “Source Monitor.” When lit, it indicates that the Audio Track Record Source (set on the Sample • Source Select page, REC SRC parameter) can be monitored on the Audio Track, and that a voice is being used to monitor this audio signal. When the Source Monitor LED is off, the Audio Track is muted and inaudible.

When REC SRC= MAIN-OUT, the audio inputs are disabled, and both Source Monitor LEDs remain off at all times. This happens because REC SRC= MAIN-OUT recording is all ASR-10 generated audio that is routed to BUS1, 2, or 3, and the Source Monitor voices are not needed to monitor this REC SRC, as it is always audible out the Main Outs.

- The right LED is yellow, and is labeled “SELECTED.” When lit, it indicates that the track is selected for parameter editing and/or Audio Track Recording, and that the Audio Signal Source being monitored on the track is selected for sampling. When the SELECTED LED is off, the track’s Edit/(audio) Track parameters cannot be edited, and the Audio Signal Source being monitored on the track will not be sampled and will not be recorded to Audio Tracks.



### Selecting, Enabling, and Disabling Audio Tracks

When you want to select a single Audio Track that is not already selected, press its **Audio Track** button. Its yellow LED will light. When an Audio Track is selected (yellow LED lit), successive presses of the **Audio Track** button will alternate between Source Monitor enable (red LED on) and Source Monitor disable (red LED off) for that track.

To select an Audio Track, press its button:



Its yellow Selected LED will light (solidly):



Press the Audio Track button again and the red Source Monitor LED will light:



Press the Audio Track button again to Source Monitor disable the track (red LED off):



When you want to select both Audio Tracks, hold down one **Audio Track** button, and press the other **Audio Track** button. Both Audio Tracks will become Selected (both yellow LEDs lit) and Source Monitor enabled (both red LEDs lit).

To select both Audio Tracks:

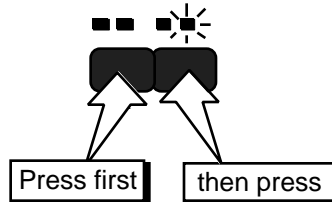

When both Audio Tracks are selected (both yellow LEDs lit), pressing the Audio Track button with the flashing yellow LED will cause that track to become solidly-selected (solidly lit). The previous solidly-selected Audio Tracks will become flashing-selected.

When both Audio Tracks are selected:

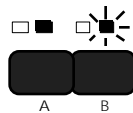

Pressing the button with the flashing LED:

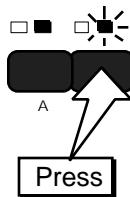

Will make that track solidly-selected:

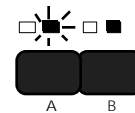

When both Audio Tracks are selected (both yellow LEDs lit) and Source Monitor disabled (both red LEDs off), pressing a solidly-selected Audio track button will cause both Audio Tracks to become Source Monitor enabled (both red LEDs on). Successive presses of the solidly-selected Audio Track will alternate between Source Monitor disable and Source Monitor enable for both tracks.

When both Audio Tracks are selected and Source Monitor is disabled:

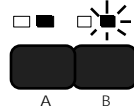

Pressing a solidly-selected Track button:

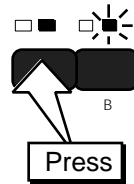

Will make both tracks become Source Monitor enabled:

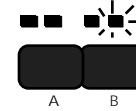

- When both Audio Tracks are selected (both yellow LEDs lit), they will both remain selected in Edit and Command Modes. The solidly-selected Audio Track is considered selected for parameter editing in Edit Mode, and as the target for track commands in Command Mode. In Edit and Command Modes, both Audio Tracks will be deselected as a pair (both Audio Track yellow LEDs off), when an **Instrument • Sequence Track** is selected.

**Note:** Audio input being monitored on an audio track will be muted during certain digital processing operations.

## How Audio Track Recording Works

Think of an Audio Track as a giant sample which is triggered by the sequencer. The sample is referred to as an AudioSample, and the sequencer event that plays the sample is referred to as an Audio Trigger. The Audio Trigger event specifies which AudioSample will play. Each Audio Track can have multiple Audio Trigger events on it, one after the other, that will each trigger a different AudioSample. However, each Audio Track can only trigger one AudioSample at a time.

### Differences between Audio Track recording and sampling

- When recording an Audio Track, the ASR-10 automatically creates a trigger event for the data. With ordinary sampling you would have to:
  - ① create the sample as a WaveSample in an Instrument.
  - ② go into record on the sequencer, and
  - ③ trigger the sample where you want it to play (by playing a key and holding the key down for the full length of the sample).
- The Audio Track audition mechanism greatly simplifies the process of recording a part, listening to it in context with a sequence, and re-recording the part if desired.
- When you locate to a section of a sequence that contains audio data, the ASR-10 will play back all the data (sequence and audio) from that point onward, even if the Audio Trigger event started earlier. With a sample, you would not hear any audio playback if you located past the sequencer key event that triggered it.
- The length of a DiskTrack is limited only by the size of your SCSI storage device, so you can create much longer audio recordings than when using sampling.
- You can punch in/out with an AudioSample; you cannot with a WaveSample.

### Methods of Recording Audio Tracks

**RAMTracks** — Record directly into internal memory. No additional hardware is required (16 Meg RAM is recommended — record up to three minutes mono @44.1 kHz, 4.5 minutes mono @29.76 kHz with 16 Meg RAM). RAMTrack data is stored entirely in the SONG + ALL SEQs file type.

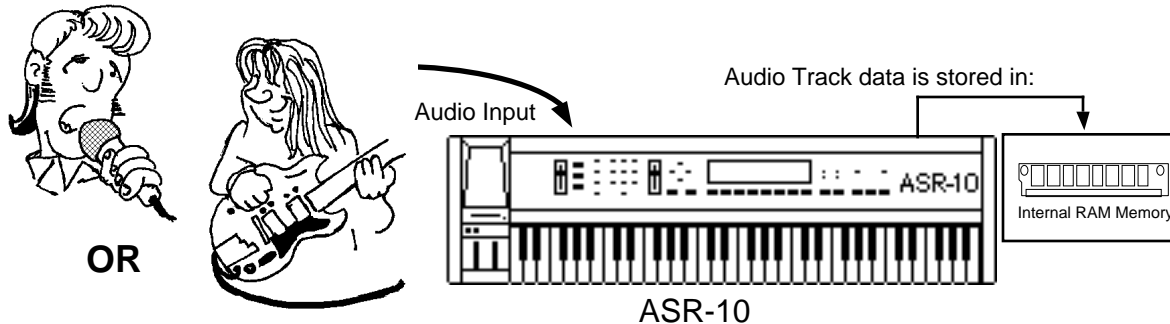

**DiskTracks** — Record directly to a SCSI storage device (hard disk, removable media, etc.) via the SCSI Interface (*SP-3 option required for the keyboard version ASR-10*). DiskTracks will work on a standard ASR-10, although expanded RAM is recommended. Recording time is limited only by the size of the SCSI storage device (as a general rule, 10 Meg = about one minute of stereo recording @44.1 kHz).

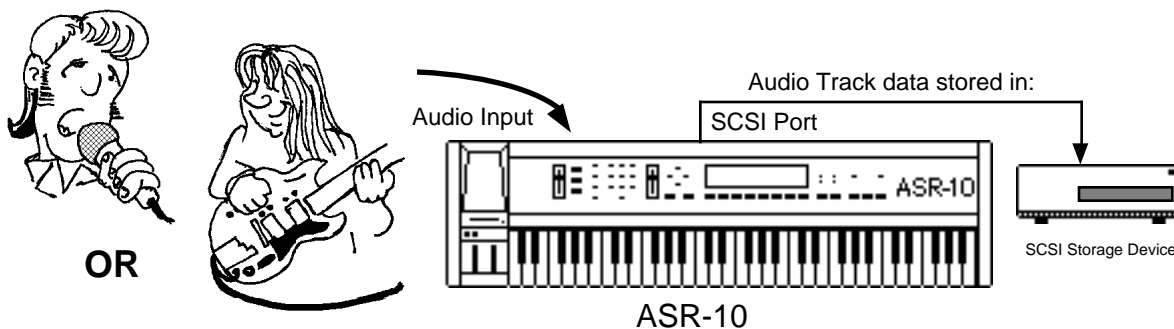

For more information about using SCSI with your ASR-10, including optional connector setups, refer to the SP-3 SCSI Manual.

### Audio Track Polyphony

Each Audio Track can use up to two voices of polyphony: Source monitoring requires one voice, and playback requires another voice. You can recover two of these voices, turn the source monitor off (red Source-Monitor LED unlit), and/or mute Audio Track playback on the **Edit/(audio) Track**, **ATRK PLAYBK STATUS** page.

## Types of Audio Tracks

The ASR-10 can record and play back two different types of Audio Tracks: sequence audio tracks or song audio tracks.

### Sequence Audio Tracks

An ASR-10 sequence is a collection of eight independent Instrument tracks and their associated notes and controller data. Each sequence has its own pair of Audio Tracks, containing audio trigger events that trigger a collection of AudioSamples from RAM or SCSI.

Sequence Audio Tracks would look like this:

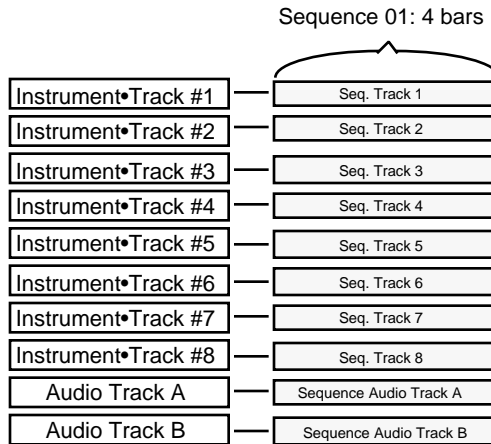

### Song Audio Tracks

An ASR-10 song is a group of sequences that have been chained together. Like sequences, the Song has its own pair of Audio Tracks that span the entire length of the song. When the Song is selected, and an Audio Track is selected, entering Record will record on a Song Audio Track (subject to the resetting of the SET SONG ATRK PLAYBACK Command, explained later in this manual).

Continuing with the previous example, Song Audio Tracks might look like this:

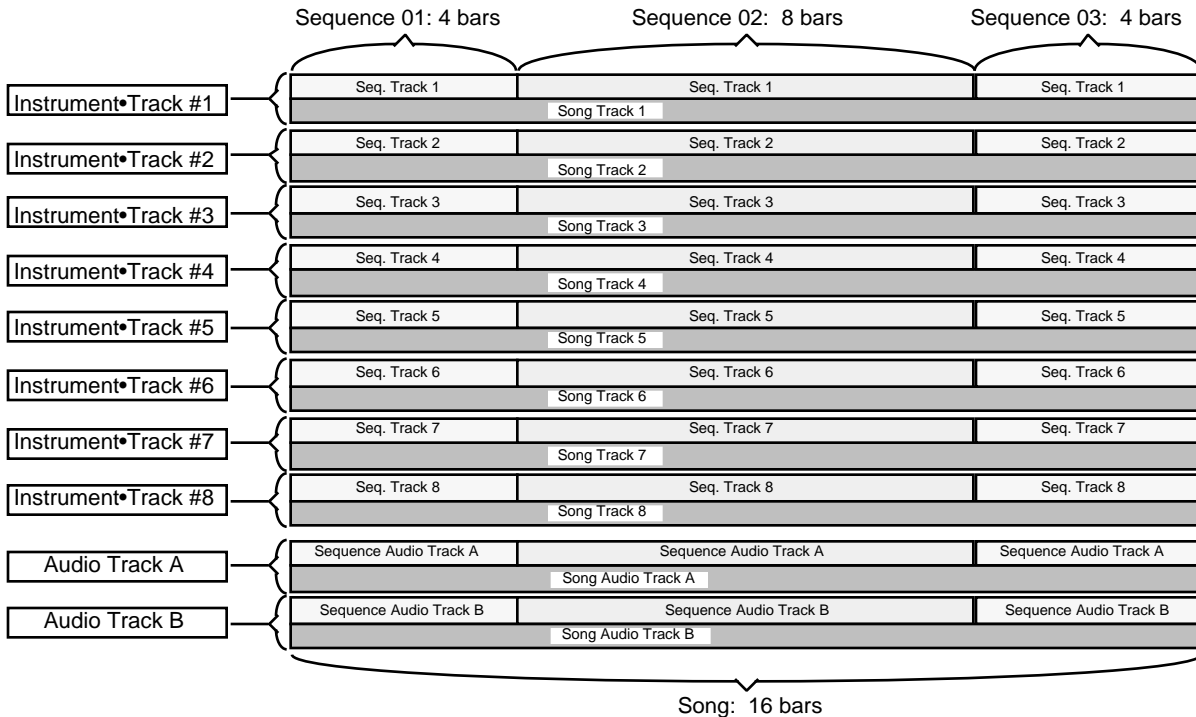

**Note:** In Song mode, the Audio Tracks will play either both of its Song Audio Tracks, both of its Sequence Audio Tracks, or one of each. It can never play all four at once.

Song Audio Tracks have the added bonus of recording AUDIO-MIX and AUDIO-PAN information that will affect the playback of the Audio Tracks for full mixdown capabilities. The **Command/(audio) Track**, FILTER AUDIO EVENTS command can be used to remove AUDIO-MIX and AUDIO-PAN events without removing the Audio Trigger events. see Section 13 for a description of the **Command/(audio) Track** commands.

The ASR-10 can play a maximum of two Audio Tracks at one time. Since the Song contains two song-length Audio Tracks, and the Song plays sequences that also have their own associated Audio Tracks, you must decide which pair of Audio Tracks you want to play. Use the **Command/Seq • Song, SET SONG ATRK PLAYBACK** command to do this.

**Note:** All sequences used within a song must have the same Tempo and Time Signature in order to record Song Audio Tracks.

## All About Memory

How much memory you have for recording and playing back Audio Tracks is dependent on whether you are configured for RAMTracks or for DiskTracks:

### RAMTracks (Audio recorded into RAM)

RAMTracks are the simplest type of Audio Track Recording. However, even with the ASR-10 memory fully expanded (16 meg), RAMTracks do not offer as much recording time as DiskTracks.

### Internal RAM Memory and SIMMs

The internal RAM memory is shared by Instruments, sequences, and AudioSamples, and is distributed *dynamically*. This means that the more sounds and sequences you have in memory, the less AudioSample memory you have. This is why we recommend expanding the memory if you plan to do a lot of RAMTrack recording. The ASR-10 can address up to 16 Megabytes/8 Megawords using industry standard SIMMs.

### DiskTracks (Audio recorded to a SCSI storage device)

DiskTracks allow a longer recording time than RAMTracks, but require you to configure the ASR-10 to recognize the SCSI storage device (how to configure the ASR-10 for DiskTracks will be explained later). Because some internal (RAM) memory is required as a buffer, we recommend expanding the ASR-10 memory to at least 4 Megabytes for improved performance.

**Note:** DiskTrack performance is dependent on the speed of the SCSI storage device and the extent of data fragmentation on the disk (see below).

## Memory Fragmentation

If you think of memory — either internal RAM or the space on a SCSI storage device — as a large jigsaw puzzle, fragmentation can be thought of as missing pieces. Fragmentation occurs when gaps in memory are left unused with data recorded on either side of the gaps. This can happen as a result of erasing a file, and then saving a different file in its place. If the new file is larger or smaller than the file that was erased, a gap in memory will remain. Fragmentation will adversely affect the performance of any memory-based system, causing it to take longer to find each file.

The ASR-10 prevents fragmentation in its internal RAM by SHUFFLING DATA each time data is added to or erased from memory. SCSI storage devices are unable to shuffle their data, and as a result are prone to fragmentation. This fragmentation will affect DiskTrack performance. To improve performance on a SCSI Storage Device and prevent fragmentation, start with a clean disk, and don't save Instrument files to the same SCSI Storage Device that you plan to use for recording Audio tracks.

## Memory-to-Recording Time — Conversion Table

The following table summarizes recording time for different memory capacities:

Memory/Disk Space		Recording Time (minutes)			
		44.1 kHz		29.76 kHz	
Megabytes	Blocks (approx.)	Mono	Stereo	Mono	Stereo
10	19,000	2	1	3	1.5
44	85,000	8	4	12	6
105	205,000	20	10	29	14.5
150	292,000	28	14	41	20.5
300	585,000	56	28	83	41.5

## RAM Buffers

A RAM buffer is a temporary holding area in the ASR-10's internal memory. Information that is to be transferred to an external SCSI storage device is stored in this area. A large RAM buffer can help the ASR-10 process greater amounts of information at one time, resulting in fewer transfers to the SCSI storage device (which generally means a cleaner, smoother transfer of information). Because of this, we recommend setting the SCSI BUFFER size to the largest amount available on your ASR-10. The SCSI BUFFER size is set with the **Command/System • MIDI, CONFIGURE AUDIO TRACKS** command (see later).

## Preparing to Record Audio Tracks

There are four things that you must do before recording Audio Tracks in the ASR-10:

1.	Select the sample rate
2.	Configure the Audio Tracks
3.	Choose a Record Source
4.	Prepare the Audio Tracks

The following pages contain rules and steps that must be followed prior to recording.

**Step One: Selecting the System Sample Rate**

1.	Select the sample rate
2.	Configure the Audio Tracks
3.	Choose a Record Source
4.	Prepare the Audio Tracks

**(select 30 or 44.1 kHz effects for use)**

The sample rate of the current effect algorithm on the **FX Select•FX Bypass** page determines the sample rate at which AudioSamples will be recorded.

Selecting an effect that uses a different sample rate than the rate at which previously recorded AudioSamples were recorded and will change the pitch of this material during playback. For this reason, we strongly recommend choosing one sample rate for the duration of an Audio Track recording Project (SONG + ALL SEQS file).

When recording Audio Tracks, we do not recommend setting **FX=INST** on the **FX Select•FX Bypass** page. Ideally, set **FX=BANK**. This will prevent Instrument selection from inadvertently changing the system sample rate, and will ensure that the correct effect is saved when you save the Bank.

**Note:** If you plan to use the Digital I/O Output, make sure that a 44.1 kHz effect is selected.

For a complete list and descriptions of the 44.1 kHz effect algorithms contained on the Version 2 O.S. (or higher) floppy disk, see the Appendix.

## Step Two: Configuring Audio Tracks for RAMTrack or DiskTrack Recording

1.	Select the sample rate
2.	Configure the Audio Tracks
3.	Choose a Record Source
4.	Prepare the Audio Tracks

These procedures configure the Audio Tracks for either RAM or SCSI recording and playback, or completely disable Audio Track recording and playback.

### How to Configure the ASR-10 for RAMTrack recording:

1. On the **Command/System•MIDI, CONFIGURE AUDIO TRACKS** page, press the **Enter•Yes** button. The display shows:

```

          SYSTEM                               STOP
  CMD
  ATRK PLAY/REC=RAM
  
```

2. Use the Data Entry Controls to set ATRK PLAY/REC=RAM. Note that this is the default setting.  
When ATRK PLAY/REC=RAM, entering record with an Audio Track solidly selected will record AudioSamples into RAM on the solidly selected Audio Track. This is the default setting for the CONFIGURE AUDIO TRACKS Command.
3. Press **Enter•Yes** again. The display will momentarily show COMMAND COMPLETED, and you will be returned to the CONFIGURE AUDIO TRACKS command page.

### How to configure the ASR-10 for DiskTrack recording:

1. Make sure that the ASR-10 and the SCSI storage device are both powered down. Then connect the external SCSI storage device to the SCSI Connector on the rear panel of the ASR-10. For more information about using SCSI with your ASR-10, refer to the SP-3 SCSI Manual.
2. Press **Command**, then **System•MIDI**, and use the Data Entry Controls to select the CONFIGURE AUDIO TRACKS command:

```

          SYSTEM                               STOP
  CMD
  CONFIGURE AUDIO TRACKS
  
```

3. On this page, press the **Enter•Yes** button, and set ATRK PLAY/REC=SCSI:

```

          SYSTEM                               STOP
  CMD
  ATRK PLAY/REC=SCSI
  
```

4. With the above screen set to ATRK PLAY/REC=SCSI, pressing **Enter•Yes** will display the following:

```

          SYSTEM                               STOP
  CMD
  SCSI BUFFERS=1166 BLKS
  
```

On this screen, you can select a size for the SCSI BUFFERS (a temporary holding area in the



ASR-10's internal memory, where the ASR-10 stores information that is to be transferred to an external SCSI storage device). The SCSI Buffer (spooling size) is based on the amount of ASR-10 internal RAM memory that is currently available, and may be different than the amount shown in the illustration above. Larger numbers give you a greater safety margin for writing the data out to disk. We recommend using the largest buffer size that your system will support.

5. Press **Enter**•**Yes**, and select the SCSI ACCESS SPEED:

```

          SYSTEM                               STOP
  CMD
SCSI ACCESS SPEED=3
  
```

This defaults to 3, but can be increased or decreased (using the Data Entry Controls) to match the speed of your connected SCSI storage device. Note that setting the SCSI ACCESS SPEED too high can have an adverse effect on sequencer timing. We recommend starting with the default value of 3, and only increase the value if the SCSI ACCESS TOO SLOW message is displayed.

6. Press **Enter**•**Yes**, and select the REC SCSI DRIVE=xxxx:

```

          SYSTEM                               STOP
  CMD
REC SCSI DRIVE=SCSI 0
  
```

Set this to the SCSI storage device ID number that you want to record on. This will automatically reset **Command/System**•**MIDI**, **CHANGE STORAGE DEVICE** to match the same SCSI ID number. Selecting **REC SCSI DRIVE=NONE** will allow *playback only* from the current SCSI storage device, and will disable Audio track recording.

7. Press **Enter**•**Yes** again. The display shows:

```

          SYSTEM                               STOP
  CMD
REC FILE=CURRENT  BLKS
  
```

This creates or resizes the Temporary Record Files, and defines the largest size that the AudioSample can be when recorded to the SCSI storage device.

8. Press **Enter**•**Yes** again.

The ASR-10 will now prepare the SCSI storage device for recording DiskTracks. The display will show **PREPARING SCSI DEVICE** (if it needs to access the SCSI device for anything), followed by **COMMAND COMPLETED**, and then you will be returned to the **CONFIGURE AUDIO TRACKS** command page.

**Note:** RAM AudioSamples can still be played back along with SCSI AudioSamples when **ATRK PLAY/REC=SCSI**.

### Understanding Temporary Record Files (REC FILE)

Temporary Record files are the area on the selected REC SCSI DRIVE that SCSI AudioSamples will be recorded into. They are stored in file 38, a directory called AUDIO TRACKS, on the selected REC SCSI DRIVE. This directory is created when you configure Audio Tracks for ATRK PLAY/REC=SCSI. The two Temporary Record Files are named TEMPORARY000 and TEMPORARY001, for Audio Tracks A and B respectively, and appear as Instrument files under **Load/Instrument** when you are in the AUDIO TRACKS directory. REC FILE=CURRENT BLKS uses any available space within the current Temporary Record File on the selected SCSI REC DRIVE. If the Temporary file has a size of 0 Blocks or does not exist, you will get a NOT ENOUGH DISK SPACE error message (i.e. there's not enough disk space in the Temporary Record File). The ASR-10 will be reconfigured for REC SCSI DRIVE=NONE. Note that you can always create new Temporary files by reconfiguring (provided that you have enough disk space left on your SCSI device).

Temporary Record Files are dedicated; one for Audio Track A, and the other for Audio Track B. For example, if you configure for REC FILE=30000 BLKS, you can record 15000 Blocks on Audio Track A, and 15000 Blocks on Audio Track B (15000 Blocks mono on each of A & B, or 15000 Blocks stereo on both A & B simultaneously, but not 30000 mono on either A or B).

**Note:** Stereo Audio Track recording time is limited by the size of the smaller of the two Temporary Record Files. If you have done some mono recording, and then enter Stereo recording, you may get a NOT ENOUGH DISK SPACE message. We suggest reconfiguring with a REC FILE size other than CURRENT or NONE to make more room.

### Resizing Temporary Record Files to Zero Blocks

Resizing Temporary Record Files to zero blocks can free up disk space on your connected SCSI storage device. You must first configure with REC SCSI DRIVE set to the Device ID for the SCSI storage device that contains the Temporary Record Files, and then reconfigure for REC SCSI DRIVE=NONE. If you configure for REC SCSI DRIVE=NONE without currently being configured for a SCSI # (for example, first thing after power-up), the Temporary Record Files will not be resized because the ASR-10 doesn't recognize which SCSI ID # they reside on.

### Deleting Temporary Record Files

You can delete the Temporary Record files manually just like any other disk file:

1. Press **Load**, then **System•MIDI**.
2. Enter the file 38 AUDIO TRACKS directory by pressing **Enter•Yes**. This is where all DiskTrack AudioSamples reside.
3. Press **Load**, then **Instrument**.
4. Select the ASMPL—##### files that you want to delete using the Data Entry Controls.
5. Press **Cancel•No** while holding down the **Load** button.

**Auditioning DiskTracks**

When auditioning a DiskTrack recording, you cannot switch between OLD and NEW on the Audition page while the sequencer is in play. This is because the sequencer must be stopped to properly prepare DiskTracks. The STOP SEQUENCER FIRST error message will be displayed if you try. You must first press **Stop • Continue**, select OLD or NEW, and then press PLAY.

**About Syncing Audio Tracks to MIDI Clocks**

When recording or playing back Audio Tracks, we highly recommend the **Edit/Seq • Song** CLOCK SOURCE=INTERNAL (i.e. not slaved to an external MIDI clock). This is because the external MIDI clock may not have a consistent tempo, and the Audio Track playback could drift out of sync with the sequence tracks. When you configure Audio Tracks for DiskTracks (ATRK PLAY/REC=SCSI), the ASR-10 automatically sets the sequencer CLOCK SOURCE parameter to be INTERNAL. Then, as long as you have Audio Tracks configured for SCSI, you cannot change the CLOCK SOURCE parameter. Whenever the Audio Tracks are reconfigured for RAM or OFF, the CLOCK SOURCE parameter can be changed.

**When Does the System Automatically Reconfigure for RAMTracks?**

When the system boots up, it is configured for RAMTrack recording by default. Once it is configured for SCSI, there are several ways it can be reconfigured back to RAM. One way is to run the CONFIGURE AUDIO TRACKS command and set it manually. There are times when the ASR-10 automatically reconfigures for RAMTracks (in order to free up memory that is being used by the SCSI Buffers). This happens when you enter Sampling, BACKUP/RESTORE, COPY FLOPPY DISK, COPY SCSI DRIVE, or use the MIDI SYS-EX RECORDER. In all these cases, the ASR-10 needs the maximum RAM memory that's available, and that means releasing the SCSI buffers. Most of these actions (except entering sampling) will prompt you with "MUST ERASE MEMORY-OK?" before continuing.

### Resampling Audio Track Playback

If you are configured for ATRK PLAY/REC=SCSI, and you enter sampling (i.e. get to the VU page), the ASR-10 automatically reconfigures ATRK PLAY/REC=RAM. This eliminates the SCSI BUFFERS in RAM, allowing for the maximum amount of sample RAM. This also prevents sampling of DiskTrack playback, but DiskTrack data is usually too large to fit into sample RAM anyway. You can still sample RAMTrack playback.

**Tip:** Resampling RAMTrack playback (with **Sample • Source Select**, REC SRC=MAIN-OUT) allows you to convert part or all of a RAMTrack into a WaveSample, through effects if desired. By performing this, you will be able to process the RAMTrack AudioSample data with the WaveSample commands. You can then truncate, normalize, loop, reverse, pitch correct, etc., and then either sequence with the new WaveSample(s), or re-record them back to Audio Tracks with REC SRC=MAIN-OUT. The sky's the limit!

**Tip:** Resample RAMTrack playback for one-finger triggering of an entire stereo Audio Track mix. If you then play the original sequence, and play the key that triggers the sample of the sequence at the same time, you can create a chorusing/flanging effect. To set the chorus/flange delay time, move the pitch wheel slightly up or down while holding down the key to get ahead of or behind the sequence playback; when you find the proper relationship, let go of the pitch wheel, and the chorus/flange effect will remain.

### How to disable Audio Track recording and playback

1. Press **Command**, then **System • MIDI**, and use the Data Entry Controls to select the CONFIGURE AUDIO TRACKS command:



2. On this page, press the **Enter • Yes** button, and use the **Down Arrow** button to set ATRK PLAY/REC=OFF:

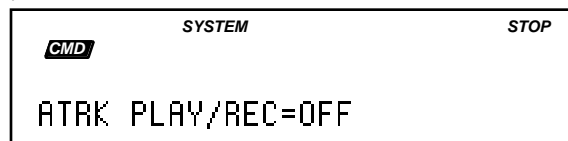

When ATRK PLAY/REC=OFF, entering record with an Audio Track solidly selected will record on the flashing selected **Instrument • Sequence Track**, *not* the solidly selected Audio Track. If no **Instrument • Sequence Tracks** are selected when Record is entered, the last selected **Instrument • Sequence Track** will automatically become flashing-selected.

3. Pressing **Enter • Yes** from the above screen will execute the command.

### Step Three: Choosing a Record Source

1.	Select the sample rate
2.	Configure the Audio Tracks
3.	Choose a Record Source
4.	Prepare the Audio Tracks

The **Sample•Source Select**, REC SRC screen determines the RECORD SOURCE (Field 1) and STEREO/MONO Record mode (Field 2) for Audio Track recording:

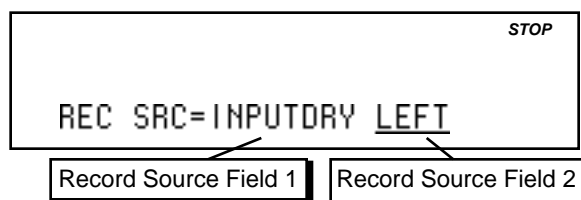

When REC SRC=	Entering Record will:
<b>INPUTDRY</b>	Record audio from the Audio Inputs dry, while monitoring the Audio Inputs through the <b>Edit/(audio) Track</b> , OUT Bus.
<b>INPUT+FX</b>	Record and monitor audio from the Audio Inputs wet through BUS1, while monitoring all other ASR-generated Audio dry.
<b>MAIN-OUT</b>	Record any ASR-10 voices that are routed to BUS1/2/3. This includes any sequence tracks that are playing local ASR-10 Instruments, and any notes played on the keyboard or received via MIDI that play local ASR-10 Instruments. Audio Track playback can itself be re-recorded according to the bounce-down rules described later.
<b>DIGITAL</b>	Record audio from the Digital Input. For more information about using this record source, refer to the DI-10 Digital I/O Manual.

#### 1 or 2 Inputs?

The REC SRC Field 2 values determine whether the Audio Tracks will be mono or stereo:

- **LEFT** — the left channel of the REC SRC will be selected for Sampling and Audio Track recording (MONO).
- **RIGHT** — the right channel of the REC SRC will be selected for Sampling and Audio Track recording (MONO).
- **L+R** — both the left and right channels of the REC SRC will be selected for Sampling and Audio Track recording (simultaneously in STEREO). Stereo Audio Track recording will create two separate AudioSamples; one for the left, and one for the right.

☞ **Note:** When using REC SRC=INPUT+FX and recording a mono source (for example, a guitar or a single mic) in stereo, through a stereo effect like reverb, you should use a “Y” cable into both Audio Inputs. Otherwise the signal will only appear on one side of the stereo image.

#### Using the Audio Track Buttons to Select and Monitor Audio Tracks

Pressing the **Audio Track** buttons will also change the REC SRC Field 2 value to reflect the current combination of selected Audio Tracks. For instance, if you press the **Audio Track A** button, the REC SRC Field 2 value changes to **LEFT**. If you press **Audio Track B**, the REC SRC Field 2 value changes to **RIGHT**. If you press **Audio Track A** and while holding it down press **Audio Track B**, the REC SRC Field 2 value changes to **L+R**. When both Audio Tracks are selected (both yellow LEDs lit), holding one **Audio Track** button and pressing the other one will change the REC SRC Field 2 value to **LEFT**. Both Audio Tracks will become Source Monitor disabled (no red LEDs lit).

For more information about Selecting, Enabling, and Disabling Audio Tracks, see earlier in this section.

The following diagrams explain the signal chain routing for the four different Record Sources.

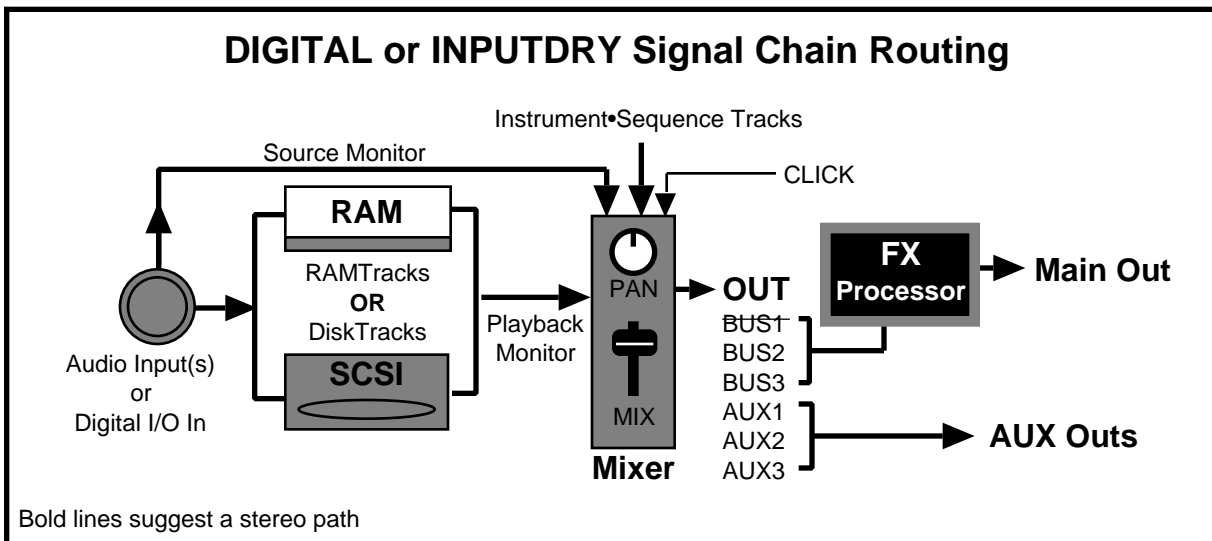

### About the INPUT DRY and DIGITAL Signal Chain Routing

Audio Tracks can be thought of as a two-track recording studio with tape-monitor mix (but not source-mix) capabilities — the Input source goes directly to “tape” before the “mixer” but is always monitored through the mixer.

The Audio Input or Digital I/O In is recorded directly to RAMTracks or DiskTracks, before the mixer. The mixer monitors both the Input source and the output of the RAMTracks or DiskTracks. The FX Processor follows the mixer, for monitoring both the source and the playback wet.

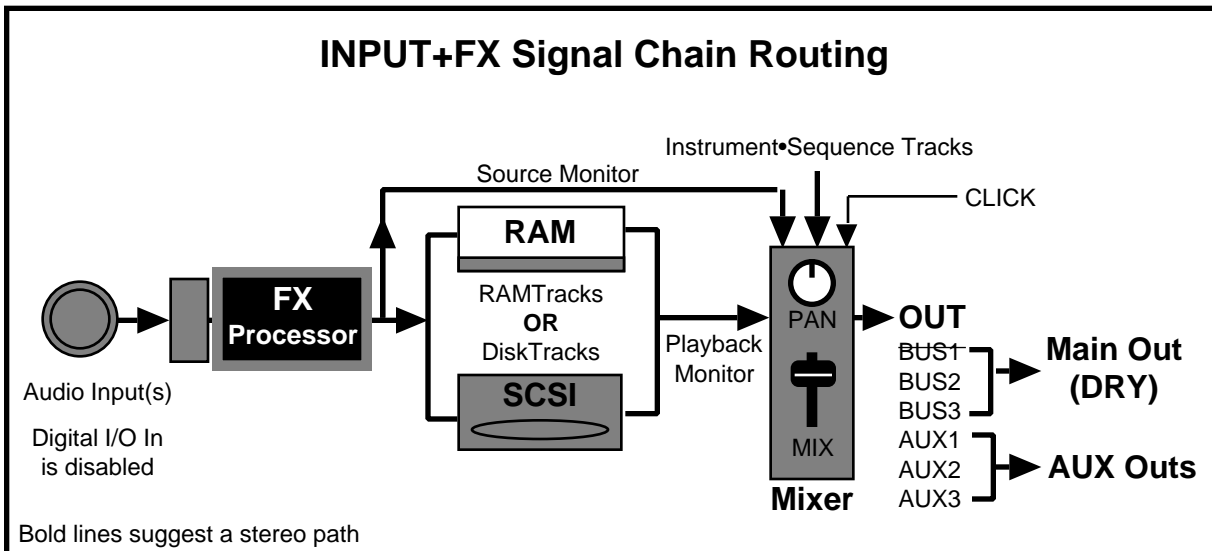

### About the INPUT+FX Signal Chain Routing

In this routing, the FX Processor is moved between the Audio Input (Digital I/O In is disabled) and the RAMTracks or DiskTracks. The RAMTracks or DiskTracks record the direct output of the FX Processor, and the Mixer monitors the output of the FX Processor (source). The Mixer also monitors the output of the RAMTracks or DiskTracks, and will playback dry (without additional processing). The Audio Input is hard-wired directly to BUS1. The FX Processor is not available for processing Instrument•Sequence Tracks, the Click track, or RAMTrack or DiskTrack playback. If the **Edit/(audio) Track**, OUT value is set to BUS1/2/3, the display will show “OUT=DRY—FX BUS IN USE”, because the effects unit is not available on the “effects loop” from the mixer. AUX1/2/3 are still available, as usual. The **Edit/(seq) Track**, OUT and **Edit/Amp**, OUT parameters will also show “OUT=DRY—FX BUS IN USE” for any Tracks/WaveSamples that are routed to BUS1/2/3.

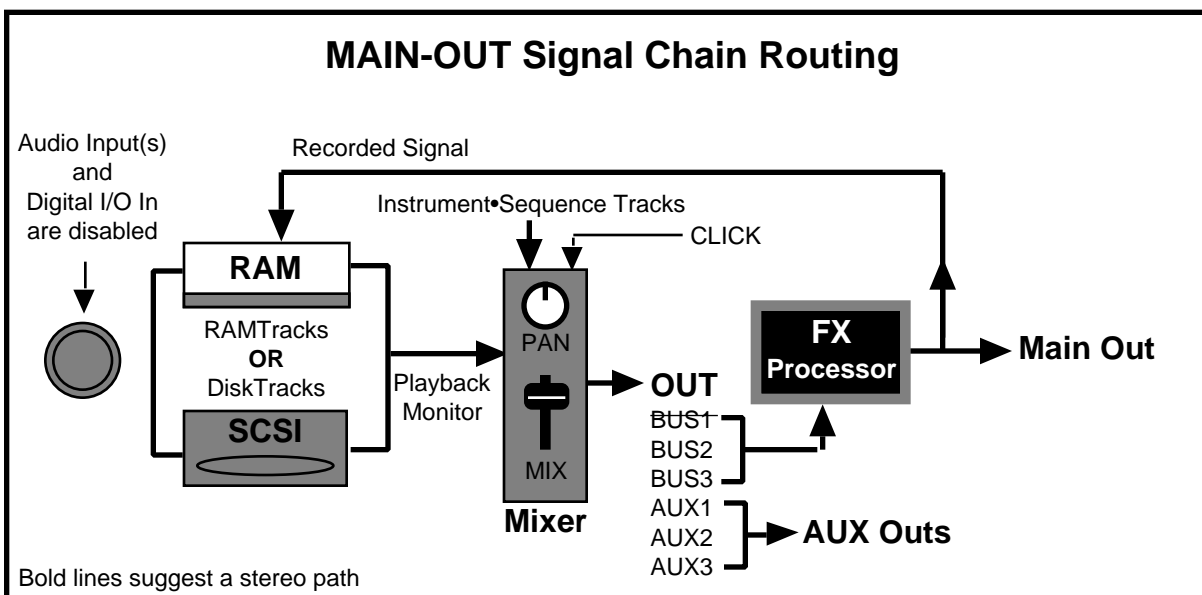

### About the MAIN-OUT Signal Chain Routing (for Bounce-down)

The ASR-10 becomes a two-track re-mix studio with source-mix capabilities.

In this routing, the Audio Inputs and Digital I/O In are disabled. The Audio Track Source-Monitor LEDs remain off at all times. Any ASR-generated audio signal that is routed to BUS1/2/3 will be recorded. The FX Processor follows the Mixer, so you will be recording the output of the FX Processor. The output of the FX Processor is monitored out the Main Outs.

**Tip:** When **Sample•Source Select**, REC SRC=MAIN-OUT, and **Edit/Seq•Song**, CLICK=REC, the click will be muted to prevent it from being recorded. You can set it to ON and route it to AUX1/2/3 if you want to hear it without recording it.



### Step Four: Preparing Audio Tracks

1.	Select the sample rate
2.	Configure the Audio Tracks
3.	Choose a Record Source
4.	Prepare the Audio Tracks

Audio Tracks that contain data must be prepared before recording or playback. Preparing Audio Tracks involves cueing up the first AudioSample for each Audio Track.

#### Preparing the Audio Tracks for recording and playback:

If the sequencer is stopped, selecting a sequence or song that has data recorded on its Audio Tracks will not automatically prepare the Audio Tracks for playback. This happens because preparing the Audio Tracks for playback requires some set-up time to cue up the first AudioSample for each Audio Track. The *SEQ* indicator light will flash on all Seq•Song mode screens (indicating that the current Sequence/Song has data recorded on its Audio Tracks) until the Audio Tracks are prepared.



- After selecting a new sequence, you must either press **Enter•Yes** (when the sequence/song name is underlined), or press an unselected **Audio Track** button, to prepare the Audio Tracks. Each time a new Sequence/Song is selected, any currently selected Audio Tracks will be automatically de-selected as a handy reminder.
- After selecting a Sequence/Song that has data recorded on its Audio Tracks, pressing **Play** without either pressing **Enter•Yes** or selecting an Audio Track will play the sequence tracks *without* playing the Audio Tracks. You must first press **Stop•Continue**, and then press **Enter•Yes**, or select an unselected Audio Track, in order to prepare the Audio Tracks and be able to play them.
- If the sequencer is stopped, pressing **Enter•Yes** (only when the sequence/song name is underlined) or selecting an unselected Audio Track will cue up the Audio Tracks (if necessary).

Whenever the first AudioSample for each Audio Track is being cued up for playback (after pressing **Enter•Yes** on the Sequence Selection page, after selecting an Audio Track, or after executing various sequencer commands), the display will flash the following message and return to the last screen displayed:



After Audio Tracks are prepared, the current stopped location will be reset back to the start of the sequence or song.

**How to Prepare Song Audio Tracks:**

The ASR-10 can playback two Audio Tracks at one time. Since the song can contain data on its own pair of Audio Tracks, and the sequences that make up the song can also contain data on their Audio Tracks, you must decide which pair you want to play and whether or not you want to record Song Audio Tracks. Before you begin, make sure that you have the song selected on the **Edit/Seq•Song**, Sequence Selection page. Then:

1. On the **Command/Seq•Song**, SET SONG ATRK PLAYBACK page, press the **Enter•Yes** button.
2. On this sub-page you will set the PLAY value:

IF:	THEN:
PLAY=SEQ ATRKS ONLY	You will be preparing to play back both sequence Audio Tracks only, and to disallow Song Audio Track recording and playback.
PLAY=SONG-A + SEQ-B	You will be preparing to record and play back one Song Audio Track using Audio Track A, and to play back the data on Audio Track B in the sequences that make up the song. You will be unable to record or play back from Song Audio Track B.
PLAY=SEQ-A + SONG-B	You will be preparing to record and play back one Song Audio Track using Audio Track B, and to play back the data on Audio Track A in the sequences that make up the song. You will be unable to record or play back from Song Audio Track A.
PLAY=SONG ATRKS ONLY	You will be preparing to record and play back both Song Audio Tracks only, and to ignore any data recorded on both Audio Tracks in the sequences that make up the song.

3. Select the proper PLAY setting for your Audio Track recording using the Data Entry Controls, and press **Enter•Yes**. The display will momentarily show **COMMAND COMPLETED**, and you will be returned to the SET SONG ATRK PLAYBACK command page.



**A Note About Preparing Song Audio Tracks**

When the Song is selected, the SEQ indicator light will always flash, whether or not the Song contains data on either the Song Audio Tracks or any of the Sequence Audio Tracks in the Sequences that make up the Song. This is done to ensure that you prepare the Audio Tracks before attempting to record Song Audio Tracks, and so that the ASR-10 can check the sequences that make up the Song to ensure that they all use the same Tempo and Time Signature.

**Audio Tracks in “Chain Play”:**

When using the “Chain Play” function to manually cue up a second sequence to play while one is already playing, the second sequence will play its sequence tracks fine, but will not play its Audio Tracks. This is due to the lack of necessary set-up time required to prepare the second Sequence’s AudioSample data. You must first press **Stop•Continue** and then press **Enter•Yes** in order to prepare the Audio Tracks.

## Principles of Audio Track Recording

### Which Track is Selected?

The solidly selected (yellow LED lit) track is always the target for recording:

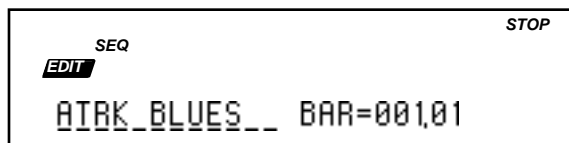

**Note:**  
Although the rack-mount ASR-10 button and LED placement is different than the keyboard ASR-10, the functionality is identical.

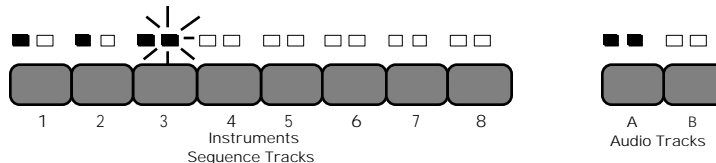

If the Audio Track LED is solidly selected, and Instrument•Sequence track LED is flashing selected, you will be recording an Audio Track.

In LOAD mode, it is possible to have both an Audio Track and an Instrument solidly selected. If you were to enter record mode on the ASR-10, the name of track you see on the display is the one you are recording on:

If an Instrument•Sequence Track name is shown in the display, it is the target for recording:



If ATRK-A LEFT or ATRK-B RIGHT is shown in the display, it is the target for recording:



### Tie the Jack to the Track

- If you are connected to the **Audio Input A/Left** jack (mono), you will be recording data to Audio Track A. You will not be recording any AudioSample data to Audio Track B.
- If you are connected to the **Audio Input B/Right** jack (mono), you will be recording data to Audio Track B. You will not be recording any AudioSample data to Audio Track A.
- If you are connected to both **Audio Inputs** (stereo), you will be recording two discrete AudioSamples using Audio Track A and Audio Track B.

**Note:** This does not imply that what is plugged into the jacks will determine which Audio Tracks will be selected for recording. Remember, your record source is selected on the **Sample•Source Select** page.

### Recording the first AudioSample

When you enter record for the first time with an Audio Track selected, you are recording both an AudioSample (recorded audio data) and an Audio Trigger event that will trigger the recorded AudioSample data. The Audio Trigger event is recorded automatically at the point at which you enter record. For this example, imagine someone singing the alphabet:

Recording the first AudioSample on an Audio Track	
Existing (or new) sequence length:	*****
Audio Trigger event:	▼
AudioSample data:	ABCDEFGHIJKLMN OPQRSTUVWXYZ
<b>Note:</b> The AudioSample data will play for its entirety when triggered by an Audio Trigger event (which is automatically recorded).	

### Overdubbing

Overdubbing allows you to re-record all or part of an Audio Track.

#### Recording Over an Audio Track

If you record over an existing Audio Track, it replaces all previous AudioSample data.

Recording over an existing Audio Track	
Audio Trigger event:	▼
Original data of AudioSample 1:	ABCDEFGHIJKLMN OPQRSTUVWXYZ
Audio Trigger event:	▼
Data that you punch-in (AudioSample 2):	abcdefghijklmnopqr stuvwxyz
<b>Note:</b> AudioSample 1 is deleted. New AudioSample 2 is created.	

#### Punching In on an Audio Track

Suppose you have an Audio Track that is fine for the first four bars, but the next four bars need to be redone. You can “punch in” at any point in the Audio Track by doing the following:

1. Select the Audio Track(s) that you want to record on and prepare the Audio Tracks, as explained earlier.
2. Press **Play** to start the sequence.
3. At the point that you want to start the “punch-in,” press **Record**.  
As soon as you press **Record**, the ASR-10 will start recording, leaving intact the part of the Audio Track before the punch-in.
4. Press **Stop•Continue**, or let the sequence/song end. You will see the Audition page, letting you play the new or the old Audio Track before deciding which to keep.

#### General Punch-In & Out Rules

- An AudioSample that is playing at the time of punch-in will have its data changed.
- A new AudioSample recorded during the Playback of an existing AudioSample will be “amalgamated” into the existing AudioSample, if the existing AudioSample was triggered before the punch-in occurred.
- When you KEEP=NEW on the Audition page, a 10 msec cross-fade time is imposed on the splice points at which the AudioSamples are amalgamated (there are no cross-fades in Audition).
- If an AudioSample is triggered to play *during* punch-in, the AudioSample will be deleted.
- If an AudioSample is changed or deleted as the result of a punch-in, any Audio Trigger Events after the punch-out point that trigger any of the changed or deleted AudioSamples will be silenced during Audition.

- See the punch-in examples below for more details.

☞ **Note about Auditioning DiskTracks:** If punching in on an existing AudioSample, the Audition playback requires much more disk activity than what it would after a KEEP=NEW. (This is because selecting KEEP=NEW converts the two separate AudioSamples into one AudioSample, eliminating disk fragmentation if possible.) Therefore, you are more likely to experience missed audio playback during Audition.

**Amalgamation**

Amalgamation is the way the ASR-10 automatically tries to unite all punched-in AudioSamples into one AudioSample, which helps to avoid disk fragmentation.

Amalgamation of SCSI-based AudioSamples may require free disk space to build the amalgamated AudioSample. This means that you might encounter a scenario wherein there is enough room on disk to record, but not enough room to amalgamate. In this case, keeping NEW after a punch-in will keep the NEW AudioSample without amalgamating it.

**Punch-In Cases for Audio Track Overdubbing**

Examples 1-5 describe the most common punch-in situations:

<b>PUNCH-IN TABLE</b>	
In the following examples:	
Audio Trigger event:	▼
Original data of AudioSample 1:	ABCDEFGHIJKLMN OPQRSTUVWXYZ
Audio Trigger event:	▼
Data that you punch-in (AudioSample 2):	abcdefghijklmnopqr stuvwxyz

<b>PUNCH-IN Example 1:</b>	
(Punch-in and out occur during AudioSample 1)	
Audio Trigger event:	▼
Original data of AudioSample 1:	ABCDEFGHIJKLMN OPQRSTUVWXYZ
Data that you punch-in (AudioSample 2):	.....abcdef.....
What you audition:	ABCDEFGHIJabcdef QRSTUVWXYZ
Audio Trigger event:	▼
What you keep:	ABCDEFGHIJabcdef QRSTUVWXYZ
<b>Note:</b> AudioSample 1 data has changed. It is the same size.	

<b>PUNCH-IN Example 2:</b> (Punch-in before AudioSample 1, punch-out after AudioSample 1)	
Audio Trigger event:	▼
Original data of AudioSample 1:	.....ABCDEFGHIJKLMN.....
Data that you punch-in (AudioSample 2):	abcdefghijklmnpqrstuvwxyz
What you audition:	abcdefghijklmnpqrstuvwxyz
Audio Trigger event:	▼
What you keep:	abcdefghijklmnpqrstuvwxyz
<b>Note:</b> AudioSample 1 is deleted. New AudioSample 2 is created.	

<b>PUNCH-IN Example 3:</b> (Punch-in during AudioSample 1, punch-out after AudioSample 1)	
Audio Trigger event:	▼
Original data of AudioSample 1:	ABCDEFGHIJKLMNOPQRSTUVWXYZ
Data that you punch-in (AudioSample 2):	.....abcdefghijkljk
What you audition:	ABCDEFGHIJKLMNOPQXabcdefghijkljk
Audio Trigger event:	▼
What you keep:	ABCDEFGHIJKLMNOPQXabcdefghijkljk
<b>Note:</b> AudioSample 1 data has changed. It is also bigger.	

<b>PUNCH-IN Example 4:</b> (Punch-in before AudioSample 1, punch-out during AudioSample 1)	
Audio Trigger event:	▼
Original data of AudioSample 1:	.....ABCDEFGHIJKLMNOPQRSTUVWXYZ
Data that you punch-in (AudioSample 2):	abcdefghijkljk
What you audition:	abcdefghijkljkFGHIJKLMNOPQRSTUVWXYZ
Audio Trigger event:	▼
What you keep:	abcdefghijkljkFGHIJKLMNOPQRSTUVWXYZ
<b>Note:</b> AudioSample 1 is deleted. New AudioSample 2 is created. AudioSample 2 contains some of the data that was in AudioSample 1.	



<b>PUNCH-IN Example 7:</b>	
(Punch-in changes AudioSample that is triggered by multiple Audio Trigger Events.)	
Audio Trigger event:	▼ ▼
What you have:	ABCDEFGHIJKL.....ABCDEFGHIJKL..
	.....abc.....
What you audition:	ABCDEFGabcKL.....
Audio Trigger event:	▼ ▼
What you keep:	ABCDEFGabcKL.....ABCDEFGabcKL..
<p><b>Note:</b> AudioSample 1 data has changed. During audition, the ASR-10 <i>does not</i> play the second Audio Trigger of new AudioSample 1. This example shows that if you correct a bad note in the middle of one AudioSample, then all Audio Trigger Events that trigger that AudioSample will pick up the correction. After keeping NEW, the second Audio Trigger of AudioSample 1 plays the changed version.</p>	

<b>PUNCH-IN Example 8:</b>	
(Punch-in changes AudioSample that is triggered by multiple Audio Trigger Events.)	
Audio Trigger event:	▼ ▼
What you have:	ABCDEFGHIJKL.....ABCDEFGHIJKL..
	.....abcdefghijklmno.....
What you audition:	ABCDEFGabcdefghijklmno.....
Audio Trigger event:	▼
What you keep:	ABCDEFGabcdefghijklmno.....
<p><b>Note:</b> AudioSample 1 data has changed. During audition, the ASR-10 <i>does not</i> play the second Audio Trigger of new AudioSample 1. After keeping NEW, the second Audio Trigger of AudioSample 1 <i>does not</i> play the second Audio Trigger of new AudioSample 1.</p>	



## Punching In on Copied Sequences

### Recording Different Audio Tracks to Copied Sequences

If you copy a Sequence that contains data recorded on its Audio Tracks, and you want to record a different version of the Audio Tracks into the copy, you must do the following in order to avoid recording over the AudioSamples that are triggered by the original Sequence:

1. Copy the sequence using the **Command/Seq•Song**, COPY SEQUENCE Command.
2. Invoke **Command/(audio) Track**, ERASE AUDIO TRACK for Audio Tracks A and B, but make sure ERASE=ATRK EVENTS ONLY

This will erase the Audio Trigger events, but will leave the AudioSamples intact to be played back by the original Sequence. You can now record new Audio Track data into the copy without affecting the original Sequence.

### Punching In on a Copied Audio Track without Affecting the Original

You can record a mono punch-in on a copied Audio Track without affecting the AudioSample data in the original Audio Track, by bouncing down (re-recording) the playback of one Audio Track to another Audio Track. Here's how:

1. Copy the sequence using the **Command/Seq•Song**, COPY SEQUENCE command. This will copy the sequence data and the Audio Trigger events only (and not duplicate the AudioSample data).  
If the original sequence had data on both Audio Tracks, then the copied sequence triggers the same data as the original sequence in both of its Audio Tracks. In order to record in the copy without affecting the original, you must erase the Audio Trigger events in the copy.
2. Erase all trigger events from one Audio Track in the copied sequence by using the **Command/(audio) Track**, ERASE AUDIO TRACK command. Make sure ERASE=ATRK EVENTS ONLY. This will erase the Audio Trigger events, leaving the AudioSample data intact. (hence not affecting the playback of the original sequence). *Be sure to erase the Audio Track that you don't want to punch in on.*
3. Bounce-down (with REC SRC=MAIN-OUT on the **Sample•Source Select** page, and **Edit/Seq•Song**, MUTE ATRKS IN REC=NO; see below) *from* the Audio Track that you want to punch-in on, *to* the one that you just erased. This will make a new AudioSample that you can then safely punch-in on without affecting the original sequence.

## Bounce-Down

Bounce-down is the re-recording of the playback of existing tracks. You can bounce down two tracks into one, allowing for unlimited overdubbing – create stacked background vocals, doubled guitar parts, etc. A track can be bounced back to itself to add effects to a dry track, or to build up multi-processed tracks using a different effect algorithm with each pass.

**Tip:** When **Sample • Source Select**, REC SRC=MAIN-OUT, up to eight Instrument • Sequence Tracks can be bounced down to one (or two) Audio Track(s), freeing up the eight Instrument • Sequence Tracks for additional sequencing! Just set the **Edit/Seq • Song**, MUTE ATRKS IN REC=YES to prevent the Audio Tracks from being re-recorded as well (see below).

**Note:** SCSI speed on most SCSI Storage Devices tends to be too slow to allow the accurate transfer of ASR-10 bounce-down information. Because of this, we do not recommend performing a 2-to-2 bounce-down using DiskTracks.

### Audio Track Bounce-Down Rules — Recording the MAIN-OUT:

- When **Sample • Source Select**, REC SRC=MAIN-OUT, the Audio Inputs are disabled, and both Source-Monitor LEDs remain off at all times. Only the Audio Track playback is monitored through the **Edit/(audio) Track** settings. The Source Monitor voices are not needed to monitor this REC SRC, as it is always audible out the MAIN OUTs.
- In combination with setting the **Sample • Source Select**, REC SRC=MAIN-OUT, setting the **Edit/Seq • Song**, MUTE ATRKS IN REC=NO enables Audio Track playback, allowing Audio Track playback to be re-recorded, or bounced down.
- Entering record with the **Sample • Source Select**, REC SRC=MAIN-OUT will record any ASR-10 voices that are routed to BUS1/2/3. This includes any sequencer tracks that are playing local ASR-10 Instruments, any notes played on the keyboard or received via MIDI that play local ASR-10 Instruments, and any previously recorded Audio Tracks that have their **Edit/(audio) Track**, ATRK PLAYBACK STATUS set to “P” (if the **Edit/Seq • Song**, MUTE ATRKS IN REC=NO).
- Audio Tracks are always bounced-down *through* the **Edit/(audio) Track** settings, with the MIX and PAN and FX processing settings being permanently imposed on the Audio data.
- When the **Sample • Source Select**, REC SRC Field 1 is set to MAIN-OUT, the following REC SRC Field 2 settings determine whether entering Record will bounce both Audio Tracks down to a single track (2 to 1), or will simply re-mix both Audio Tracks through new effects, maintaining track discretion (2 to 2).

### 2-to-1 Bounce-Down

2-to-1 Bounce-Down is configured by setting the **Sample • Source Select**, REC SRC Field 1 to MAIN-OUT and Field 2 to LEFT or RIGHT (i.e. this will be re-recorded in mono, since only one track is selected). The selected Audio Track is the destination for the bounced-down AudioSample. This creates a single AudioSample out of all AudioSamples that were triggered by both Audio Tracks. The original material on the track that was *not* the destination (i.e.: was not selected) for the bounce-down is left unchanged. Make sure that all Instrument • Sequence Tracks are muted (on the **Edit/(seq) Track**, Status page or they will be bounced-down as well.

- If you are bouncing down to Audio Track A, you should adjust the **Edit/(audio) Track PAN** settings to the *left* side, so that they will be recorded properly.
- If you are bouncing down to Audio Track B, you should adjust the **Edit/(audio) Track PAN** settings to the *right* side, so that they will be recorded properly.

### 2-to-2 Bounce-Down

2-to-2 Bounce-Down is configured by setting the **Sample • Source Select**, REC SRC Field 1 to MAIN-OUT and Field 2 to L+R (i.e. this will be re-recorded in stereo, since both tracks are selected). This creates two AudioSamples — one for each Audio Track — out of all of the AudioSamples that were triggered by both Audio Tracks. Make sure that all Instrument • Sequence Tracks are muted (on the **Edit/(seq) Track**, Status page, or they will be bounced-down as well.

**Tip:** When **Sample • Source Select**, REC SRC=MAIN-OUT, and **Edit/Seq • Song**, CLICK=REC, the click will be muted to prevent it from being recorded. You can set it to ON and route it to AUX 1, 2, or 3 if you still want to hear it during recording.

### Notes on Bounce-down:

We strongly recommend that you perform a bounce-down to an empty track before Punching-In on any Audio Track that has had Audio Track commands performed on it. This prevents any confusion that could result from punching in on an Audio Track that contains multiple Audio Trigger Events that trigger the same AudioSample. Be aware that this will probably increase the memory used by AudioSamples. See punch-in rules above.

To monitor Audio Tracks without re-recording their playback during bounce-down, set the **Edit/(audio) Track**, OUT value(s) to AUX1/2/3. With this setup, the Audio Track playback will *not* be re-recorded, but any ASR-10 voices routed to BUS1/2/3 *will* be recorded.

Remember to mute any Sequence Tracks (on the **Edit/(seq) Track** Status page) that you don't want bounced down to the Audio Tracks.

When REC SRC=MAIN-OUT, the MAIN-OUT audio will be recorded **post-Volume Slider**. For the optimal signal-to-noise ratio, the **Volume Slider** should be at maximum when recording the MAIN-OUT.

**Tip:** To quickly record global volume changes on both Audio Tracks simultaneously (and any other voices routed to BUS 1/2/3), adjust the **Volume Slider** while recording a bounce-down. These volume changes will be permanent.

## Song Audio Track Mixdown

Song Audio Tracks have the added bonus of recording AUDIO-MIX and AUDIO-PAN information that will affect the playback of the Audio Tracks for full mixdown capabilities (the **Edit/Seq • Song**, SONG ATRK REC parameter determines this). The **Command/(audio) Track**, **FILTER AUDIO EVENTS** command can be used to remove AUDIO-MIX and AUDIO-PAN events without removing the Audio Trigger events (see later in this document for a description of the Audio Track commands).

### Recording Audio-Mix and Audio-Pan information

1. Select a song (refer to the ASR-10 Musician's Manual for steps in creating a song).
2. Select an Audio Track that has AudioSample data (by pressing its **Audio Track** button).
3. Press **Edit**, then **Sequence • Song**, and use the Data Entry Controls to select SONG ATRK REC=AUDIO.
4. press the **Up Arrow** button once to change the display to SONG ATRK REC=MIX+PAN.
5. Press **Record** and while holding it down, press **Play**.  
At this point, you can change the mix or pan of the Audio Track, and it will be recorded.
6. When the song is finished, select KEEP=NEW.  
If you want to re-record your mixdown, you must first filter the audio events (see below).

### How to Filter Audio Mixdown Events

1. Press **Command**, then **Track**.
2. Use the Data Entry Controls to select the **FILTER AUDIO EVENTS** command:



A screenshot of the sequencer's data entry screen. At the top left is a 'CMD' button, at the top right is a 'STOP' button, and in the center is a 'TRACK' button. The main display area shows the text 'FILTER AUDIO EVENTS'.

3. Press **Enter • Yes** to invoke the command. The display shows:

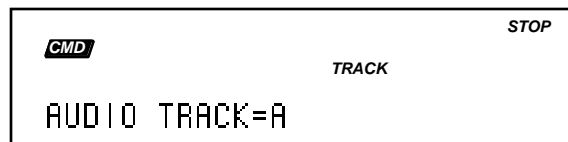

A screenshot of the sequencer's data entry screen. At the top left is a 'CMD' button, at the top right is a 'STOP' button, and in the center is a 'TRACK' button. The main display area shows the text 'AUDIO TRACK=A'.

4. Use the **Audio Track A** and **B** buttons to select the Audio Track that you want to filter the audio events.
5. Press **Enter • Yes**.  
This page allows you to select either the AUDIO-MIX or the AUDIO-PAN events to erase (which are selected using the **Up/Down Arrow** buttons or the **Data Entry Slider**).
6. Press **Enter • Yes** to filter the selected Audio Track. The display momentarily shows **SHUFFLING DATA**, then allows you to Audition the newly filtered Audio Track. If there are no events to filter, the display momentarily shows **NO DATA ON SOURCE TRACK**.
7. Select KEEP=NEW and press **Enter • Yes** to save the filtered version, or press **Cancel • No** to abort the command.

## How Existing Sequence Commands Affect Audio Tracks

Sequencer commands only affect the Audio Trigger events, and do not affect the associated AudioSamples. Only the following functions will affect the AudioSamples:

- Punching-in on an Audio Track
- **Command/Seq • Song**, ERASE ALL AUDIOSAMPLES
- **Command/(audio) Track**, DELETE AUDIOSAMPLE
- **Command/(audio) Track**, ERASE AUDIO TRACK
- When the SAVE SONG + ALL SEQS command is invoked, the SONG + ALL SEQS file type can now be saved across multiple disks. It may be very large if it contains large RAM AudioSamples.
- After performing the **Command/Seq • Song**, APPEND SEQUENCE, CHANGE SEQUENCE LENGTH, and EDIT SONG STEPS Commands on Sequences that have data recorded on their Audio Tracks, the “PREPARING AUDIO TRACKS” message will be displayed as Audio Tracks are cued up for Playback.

### **Caution:**

Most sequence commands only affect the Audio Triggers, and not the AudioSample data. Remember, the same AudioSample can be triggered by many different sequences as a result of using the COPY SEQUENCE or COPY AUDIO TRACK Commands. If you punch in on an AudioSample that is used elsewhere, it will be modified elsewhere as well. We recommend performing sequence commands before recording any data to Audio Tracks.

- The DELETE SEQUENCE and ERASE SONG + ALL SEQS Commands will NOT delete the AudioSamples that are triggered by Events on the Sequence's Audio Tracks.

### How Audio Tracks Function in Command and Edit Modes

There are two sets of track commands and track edit parameters: Sequence Track commands/parameters, and Audio Track commands/parameters.

Which command or edit parameter you will see is based on whether an Audio Track or an Instrument•Sequence Track is selected.

- When an Audio Track is selected in Command and Edit modes, the Audio Track's Selected LED will be solidly lit, and the currently selected Instrument•Sequence Track's Selected (yellow) LED will flash. The solidly-selected track is always considered the target for Command/Track Commands:

STOP

TRACK

COPY AUDIO TRACK

**Note:**

Although the rack-mount ASR-10 button and LED placement is different than the keyboard ASR-10, the functionality is identical.

1 2 3 4 5 6 7 8  
Instruments  
Sequence Tracks

A B  
Audio Tracks

If the Audio Track LED is solidly selected, and Instrument•Sequence track LED is flashing selected, the Audio Track commands and Edit parameters will be displayed.

- Selecting an Instrument•Sequence Track in Command mode will de-select both Audio Tracks.

STOP

TRACK

QUANTIZE TRACK

**Note:**

Although the rack-mount ASR-10 button and LED placement is different than the keyboard ASR-10, the functionality is identical.

1 2 3 4 5 6 7 8  
Instruments  
Sequence Tracks

A B  
Audio Tracks

If the Instrument•Sequence Track LED is solidly selected, the Audio Track LED is de-selected, and the Instrument•Sequence Track commands and Edit parameters will be displayed.

- When both Audio Tracks are selected in LOAD mode, pressing Command will leave them both selected — one Solidly-Selected and one Flashing-Selected. The Solidly-Selected Audio Track is always considered the target for Command/(audio) Track Commands.

## System Optimization Tips

### Application Notes to Improve Performance:

Note that these are not required, but may improve situations where system bandwidth is being limited by excess SCSI activity:

- Mute the first Audio Track before recording the second. This will cut down on disk activity during record.
- When recording from the start of a sequence, record with a countoff. This allows one bar of countoff time to verify recording files exist, instead of having to do this verification in real-time.
- When Audio Track recording, mute unneeded sequence tracks.
- Record Audio Tracks with a minimum timing reference, then copy over sequence tracks from another sequence (or copy Audio Tracks over to the other sequence).
- Mute Audio Tracks before recording sequence tracks.
- For Audio Track bounce-down (assuming you're bouncing-down Audio Track playback only, and not sequence playback), set the SCSI ACCESS SPEED as high as possible. Sequencer track playback may be compromised, but the AudioSamples will play back smoothly, and since this what you are re-recording, the bounced-down data should be fine. Again, mute the sequence tracks here, as well.
- For 2-track playback, SCSI storage devices that were recently formatted will perform better than a SCSI storage device that had a lot of data on it prior to Audio Track recording. This is true even if the SCSI storage device has been defragmented. This is because data that resides on the outer edges of the SCSI storage device will reduce the disk head movement.
- The SCSI storage device manufacturer's access times do NOT tell the whole story. Some SCSI storage devices use highly intelligent caching schemes to *greatly* reduce the amount of disk activity for the same amount of data transferred. Some SCSI storage devices have fast seek times, but slow SCSI transfer times. Drives with segmented caches work much better for multiple Audio Tracks.
- Some SCSI storage devices will time out after several minutes of no use. This puts the SCSI storage device into an idle state. The first request to the SCSI storage device while it is in this state takes longer to process because the motor may not be up to full speed. If you try to go into record, this may result in a MEMORY OVERFLOW message. If you go into play, this may result in a SCSI ACCESS TOO SLOW message. Subsequent SCSI storage device activity is then fine. To get around the idle state, simply reselect the sequence and prepare it (press **Enter•Yes**). This will wake the SCSI storage device up so the first real-time playback SCSI transfer will be on time.
- Audio Tracks recording or playing back at 44.1KHz require much more SCSI activity than the same sequence at 30KHz. If the MEMORY OVERFLOW message occurs during recording at 44.1KHz, you may be successful recording at 30KHz. Again, this is all dependent on what type of SCSI storage device is at the other end of the SCSI cable.
- Follow all cabling tips in the SP-3 SCSI Manual, making the shortest possible path between the ASR-10 and the SCSI storage device selected with the CONFIGURE AUDIO TRACKS command, REC SCSI DRIVE parameter.

## AudioSample Specs

- Each SONG + ALL SEQs (Project) file can have a maximum of 8192 AudioSamples.
- The map of contiguous blocks will allow approximately 500 fragments per sequence or song. So if all AudioSamples were contiguous, this would allow up to 500 AudioSamples per sequence or song. If each file consisted of two fragments, you could have up to 250 AudioSamples per sequence or song (fragmentation is entirely dependent on the data already on the disk).
- Time limits per AudioSample (worst case): 80.1 minutes at 29.7KHz; 54.1 minutes at 44.1KHz.

**Error/Informational Messages (in alphabetical order)**

<p style="text-align: right;"><b>REC</b></p> <p>SEQ <b>EDIT</b></p> <p>AUDIO DEV NOT SELECTED</p>	<p>If you configure for ATRK PLAY/REC=SCSI with REC SCSI DRIVE set to one SCSI Device ID number, and then you run CHANGE STORAGE DEVICE and set the current storage device to a different SCSI Device ID number.</p> <p>This will also appear if you try to play DiskTracks from a device that is not currently selected (regardless of what the REC SCSI DRIVE is set to).</p>
<p style="text-align: right;"><b>STOP</b></p> <p><b>EDIT</b> TRACK</p> <p>CONFIGURE ATRKS FIRST</p>	<p>If you are configured for SCSI, with SCSI REC DRIVE=NONE, and you try to enter record with an Audio Track selected.</p>
<p style="text-align: right;"><b>STOP</b></p> <p>SEQ <b>EDIT</b></p> <p>DISK DRIVE NOT READY</p>	<p>This message usually occurs when the ASR-10 is trying to access the floppy drive or a removable SCSI storage device when there is no disk or cartridge in the drive, or when the SCSI storage device is spinning up.</p> <p>If this message occurs, insert a floppy disk or cartridge in the drive, then use the CHANGE STORAGE DEVICE command to select the appropriate SCSI Device ID number.</p>
<p style="text-align: right;"><b>STOP</b></p> <p>SEQ <b>EDIT</b></p> <p>DISK HAS BEEN CHANGED</p>	<p>This is displayed when the ASR-10 can't find the Temporary Record Files when you entered record on an Audio Track while configured for ATRK PLAY/REC=SCSI.</p>
<p style="text-align: right;"><b>STOP</b></p> <p>SEQ <b>EDIT</b></p> <p>DISK WRITE PROTECTED</p>	<p>Just like floppy disks, some cartridges used with removable SCSI storage devices have a switch to prevent accidentally erasing files. If this message appears while using a removable SCSI storage device, remove the cartridge, and change the Write Protect Switch.</p>
<p style="text-align: right;"><b>STOP</b></p> <p>SEQ <b>EDIT</b></p> <p>DRIVE NOT RESPONDING</p>	<p>If encountered while using a SCSI storage device, this error may indicate a problem with your SCSI cables. The cable from the ASR-10 to the SCSI storage device may be too long, or the system may not have proper termination.</p> <p>Check all connections and make sure that you are using the correct cables. Make sure you have the proper termination. If this message appears repeatedly while files are being saved to the SCSI storage device, then it is likely that you are invisibly losing sectors of your SCSI storage device. Correct the problem before continuing to use the SCSI storage device. For more information, refer to the SP-3 SCSI Manual</p>
<p style="text-align: right;"><b>STOP</b></p> <p>SEQ <b>EDIT</b></p> <p>MEMORY OVERFLOW</p>	<p>DiskTrack recording has filled up the SCSI BUFFERS before the data could be transferred to the SCSI storage device. The sequencer will automatically stop recording, the message will be displayed for two seconds, and the ASR-10 will enter Audition Play. The AudioSample data that was recorded before the overflow occurred is processed as if you had pressed <b>Stop•Continue</b> to exit recording. This may also be displayed if there is a memory problem during RAMTrack recording or sampling.</p>



<div style="border: 1px solid black; padding: 5px;"> <div style="display: flex; justify-content: space-between; align-items: center;"> <span>SEQ</span> <span>STOP</span> </div> <div style="display: flex; justify-content: space-between; align-items: center;"> <span><b>EDIT</b></span> </div> <p style="text-align: center;">NO ATRK PLAYBACK ROOM</p> </div>	<p>If the current Sequence/Song has data recorded on its Audio Tracks, and there is not enough memory to cue up the Audio Tracks for playback, this will be displayed when you press <b>Play</b> or <b>Stop•Continue</b>, or when <b>Enter•Yes</b> is pressed on the <b>Edit/Seq•Song</b>, Sequence Selection screen.</p> <p>After this message is displayed, the Audio Tracks will not play, but the Sequence Tracks will play fine.</p>
<div style="border: 1px solid black; padding: 5px;"> <div style="display: flex; justify-content: space-between; align-items: center;"> <span>GMD</span> <span>STOP</span> </div> <div style="display: flex; justify-content: space-between; align-items: center;"> <span>WAVE</span> </div> <p style="text-align: center;">NO ROOM FOR OPERATION</p> </div>	<p>If there is not enough memory to record Audio Tracks, this will be displayed when you try to enter record with an Audio Track selected.</p> <p>If you try to run a command that requires more memory than available, this will be displayed when you run the command.</p>
<div style="border: 1px solid black; padding: 5px;"> <div style="display: flex; justify-content: space-between; align-items: center;"> <span>SEQ</span> <span>STOP</span> </div> <div style="display: flex; justify-content: space-between; align-items: center;"> <span><b>EDIT</b></span> </div> <p style="text-align: center;">NO SCSI ATRK MIDI SYNC</p> </div>	<p>This appears when you try to manually change the <b>Edit/Seq•Song</b>, CLOCK SOURCE to MIDI when Audio Tracks have been configured for DiskTrack recording.</p>
<div style="border: 1px solid black; padding: 5px;"> <div style="display: flex; justify-content: space-between; align-items: center;"> <span>GMD</span> <span>STOP</span> </div> <div style="display: flex; justify-content: space-between; align-items: center;"> <span>SYSTEM</span> </div> <p style="text-align: center;">NOT AN EPS SCSI DEV</p> </div>	<p>The SCSI storage device selected is not an EPS/EPS-16 PLUS/ASR-10 formatted Storage Device, and cannot be used by the ASR-10.</p> <p>You may choose to reformat the SCSI storage device for use with the ASR-10. Use caution, as this will erase all previously saved data.</p>
<div style="border: 1px solid black; padding: 5px;"> <div style="display: flex; justify-content: space-between; align-items: center;"> <span>SEQ</span> <span>PLAY</span> </div> <div style="display: flex; justify-content: space-between; align-items: center;"> <span><b>EDIT</b></span> </div> <p style="text-align: center;">NOT ENOUGH DISK SPACE</p> </div>	<p>The allocated Temporary Record Files have been used up, or you are configured for SCSI with REC FILE SIZE=CURRENT, but no Temporary Record files exist on the selected SCSI storage device.</p>
<div style="border: 1px solid black; padding: 5px;"> <div style="display: flex; justify-content: space-between; align-items: center;"> <span>SEQ</span> <span>PLAY</span> </div> <div style="display: flex; justify-content: space-between; align-items: center;"> <span><b>EDIT</b></span> </div> <p style="text-align: center;">NOT SET FOR SONG ATRK</p> </div>	<p>This will appear if you are trying to record a Song Audio Track, but <b>Command/Seq•Song</b>, SET SONG ATRK PLAYBACK is set to PLAY=SEQ ATRKS ONLY.</p> <p>It will also appear if you are trying to record Song Audio Track A and PLAY=SEQ A + SONG B, or you are trying to record Song Audio Track B and PLAY=SONG A + SEQ B.</p>
<div style="border: 1px solid black; padding: 5px;"> <div style="display: flex; justify-content: space-between; align-items: center;"> <span>SEQ</span> <span>STOP</span> </div> <div style="display: flex; justify-content: space-between; align-items: center;"> <span><b>EDIT</b></span> </div> <p style="text-align: center;">OUT OF MEMORY</p> </div>	<p>RAMTrack recording has completely filled the ASR-10 internal memory during recording. The sequencer will automatically stop recording, the message will be displayed for two seconds, and the ASR-10 will enter Audition Play. The AudioSample data that was recorded before all memory was exhausted is processed as if you had pressed <b>Stop•Continue</b> to exit recording.</p>
<div style="border: 1px solid black; padding: 5px;"> <div style="display: flex; justify-content: space-between; align-items: center;"> <span>SEQ</span> <span>STOP</span> </div> <div style="display: flex; justify-content: space-between; align-items: center;"> <span><b>EDIT</b></span> </div> <p style="text-align: center;">PREPARE ATRKS FIRST</p> </div>	<p>If an Audio Track is selected, but the Audio Tracks have not been prepared (i.e. data has not been cued up by pressing <b>Enter•Yes</b>, or selecting an unselected Audio Track while the sequencer is stopped), this will be displayed when you try to enter record. The sequencer will not enter record with an Audio Track selected until the Audio Tracks have been prepared.</p>

<p style="text-align: right;">SEQ <span style="float: right;">STOP</span></p> <p><b>EDIT</b></p> <p>SCSI ACCESS TOO SLOW</p>	<p>This is displayed when you press <b>Stop•Continue</b> to stop sequencer playback, and it means that the selected SCSI storage device is not keeping up during audio playback. This could be due to one or more of the following:</p> <p>Within the <b>Command/System•MIDI</b>, CONFIGURE AUDIO TRACKS command:</p> <ul style="list-style-type: none"> <li>• SCSI BUFFERS too small</li> <li>• SCSI ACCESS SPEED too slow</li> </ul> <p>Problems relating to the External SCSI storage device:</p> <ul style="list-style-type: none"> <li>• disk access time too slow</li> <li>• disk seek time too slow</li> <li>• disk drive not smart about caching</li> <li>• disk drive SCSI interface too slow</li> <li>• disk fragmented</li> </ul> <p>You can continue to use the sequencer even though this message appeared, because it is possible that some problems can be detected but not heard. If you see this message but didn't hear a problem, you might want to consider reconfiguring the Audio Tracks (using the <b>Command/System•MIDI</b>, CONFIGURE AUDIO TRACKS command) with larger SCSI BUFFERS and a slightly faster SCSI ACCESS SPEED. If you hear glitching of the Audio Tracks during playback, you should definitely look for this message when you press <b>Stop•Continue</b>. Note that this message does not appear in Audition Play.</p>
<p style="text-align: right;">TRACK <span style="float: right;">STOP</span></p> <p><b>EDIT</b></p> <p>SELECT ASMPL FIRST</p>	<p>If the <b>Edit/(audio) Track</b>, ASMPLNAME=*UNDEFINED*, or if no AudioSamples exist, this will be displayed when any AUDIOSAMPLE command is invoked.</p> <p>Go to the ASMPLNAME parameter and use the <b>Up/Down Arrow</b> buttons to choose a target AudioSample before invoking the Command.</p>
<p style="text-align: right;">SEQ SONG <span style="float: right;">STOP</span></p> <p><b>EDIT</b></p> <p>SONG TEMPO/TIME VARIES</p>	<p>This message appears when you try to record Song Audio Tracks in a song made up of sequences containing different Tempos and Time Signatures. Song Audio Tracks can only be recorded in songs made up of sequences of like tempos and time signatures.</p>
<p style="text-align: right;">SEQ <span style="float: right;">PLAY</span></p> <p><b>EDIT</b></p> <p>STOP SEQUENCER FIRST</p>	<p>When auditioning a DiskTrack recording, you cannot dynamically switch between OLD and NEW on the Audition page while the sequencer is in play. If you try, you will get this message.</p>
<p style="text-align: right;">SYSTEM <span style="float: right;">STOP</span></p> <p><b>CMD</b></p> <p>UNCONNECTED SCSI DEV</p>	<p>The REC SCSI DEVICE selected in the CONFIGURE AUDIO TRACK command is no longer connected. The ASR-10 will be configured for ATRK PLAY/REC=SCSI, but REC SCSI DRIVE=NONE (i.e. SCSI playback only) and Buffers have been allocated.</p> <p>Check your SCSI connections. If your SCSI storage device has a changeable ID number, make sure it matches the SCSI Device ID number you have chosen in the CONFIGURE AUDIO TRACK command.</p>
<p style="text-align: right;">SYSTEM <span style="float: right;">STOP</span></p> <p><b>CMD</b></p> <p>USE SMALLER AMOUNT</p>	<p>The SCSI BUFFERS size selected in the CONFIGURE AUDIO TRACKS command is too large to fit in available RAM. After this message is displayed, the ASR-10 Audio Track configuration will be left unchanged. Choose a smaller value and try again.</p>

# Section 13 — Sequencer & Audio Track Parameters

The following parameters control the ASR-10 sequencer. Parameters for creating and manipulating sequences, the song, and the tracks contained within each are covered here. This section also describes the Audio Track Edit/Track parameters. For a basic overview of the concepts involved, refer to the previous section.

## The Edit/Seq•Song Page

This page acts as the main “control panel” for sequencing.

<i>EDIT</i> SEQ•SONG	<b>CURRENT SEQUENCE/SONG - BAR - BEAT/STEP</b>
	Press Edit / Seq•Song / 0 (for Current Seq/Song) 1 (for Bar)

### Current Sequence/Song

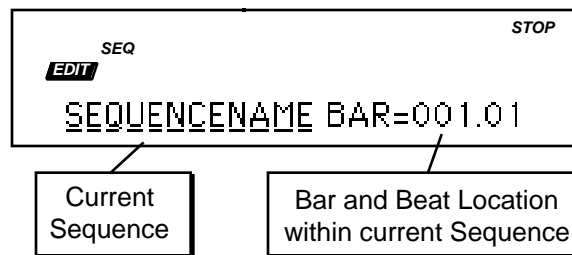

This screen is where you select a sequence or the song. With the selected sequence or song name underlined (as shown above), use the **Up/Down Arrow** buttons or the **Data Entry Slider** to select a different sequence or song.

**Tip:** You can always get back to the Current Sequence/Song screen by double-clicking the **Seq•Song** button (when in Edit mode).

### BAR/STEP — The GOTO Function

- Press the **Right Arrow** button to move the cursor to the BAR parameter. The display reads as follows:

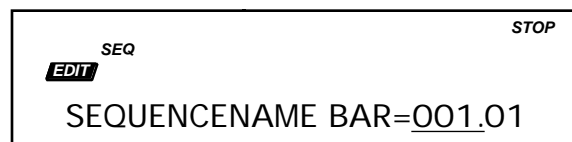

This parameter shows the current location in the selected sequence or song. When the cursor is under the Bar, Beat (or Step) Number, you can use the GOTO function to “go to” any location within the sequence or song, by moving the **Data Entry Slider** or the **Up/Down Arrow** buttons to select a new location, then pressing **Enter•Yes**. Pressing **Play** will always start the sequencer from the beginning of the selected sequence. Pressing the **Stop•Continue** button will begin playing the sequence from the selected bar.

**Tip:** After using the GOTO function to go to a certain Bar, Beat (or Step) location, pressing **Enter•Yes** twice with the cursor under the Bar, Beat (or Step) value will relocate the sequencer to the last selected GOTO location.

<i>EDIT</i>	<b>TEMPO - LOOP</b>
<i>SEQ•SONG</i>	Press Edit / Seq•Song / 2 (for Tempo) 3 (for Loop)



Here you can adjust the tempo of the sequence in beats per minute, and the LOOP parameter. When LOOP=ON the sequence will repeat continuously, when LOOP=OFF the sequence will play once and stop. When CLOCK SOURCE= MIDI, the TEMPO value will read EXT, to indicate that the tempo is controlled by incoming MIDI clocks.

Range: 20 to 250, EXT

### Tap Tempo

When the TEMPO parameter is selected, tapping on the **Enter•Yes** button at the correct rate for the desired tempo will update the TEMPO parameter to the new value.

<i>EDIT</i>	<b>CLOCK SOURCE</b>
<i>SEQ•SONG</i>	Press Edit / Seq•Song / 4

This parameter determines the sequencer CLOCK SOURCE. There are two possible choices:

- INTERNAL — The ASR-10 will use its own internal clock.
- MIDI — The ASR-10 will sync to incoming MIDI clocks from a remote device. This is useful when syncing to a drum machine or external sequencer, but still recording on the ASR-10.

When CLOCK SOURCE= MIDI, pressing the **Record** button puts the ASR-10 into standby MIDI sync record. The MIDI indicator light will flash and the display will show WAITING... Recording will begin with the first MIDI clock received after a MIDI Start command. If the **Stop•Continue** button is pressed before a MIDI Start command is received, the ASR-10 waits 5 seconds before stopping.

<i>EDIT</i>	<b>CLICK - CLICK NOTE VALUE</b>
<i>SEQ•SONG</i>	Press Edit / Seq•Song / 5

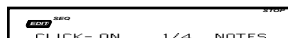

These two parameters control the metronome CLICK. The first parameter controls when the click will be heard:

- REC — the click will be heard only when the sequencer is recording, and not when it is playing. This is the default.
- OFF — the click will not be heard during Play or Record.
- ON — the click will be heard whenever the sequencer is running.

The second parameters controls the note value that the click will play:

Range: 1/2, 1/2T, 1/4, 1/4T, 1/8, 1/8T, 1/16, 1/16T, 1/32, 1/32T ("T" = triplets)

<i>EDIT</i>	<b>CLICK VOLUME</b>
<i>SEQ•SONG</i>	Press Edit / Seq•Song / 6

The volume of the click track is adjustable from 0 to 99.

<i>EDIT</i>	<b>CLICK PAN - OUT (Output Routing)</b>
SEQ•SONG	Press Edit / Seq•Song / 7

Use the **Data Entry Slider** or the **Up/Down Arrow** buttons to pan the click track within the stereo field (-99 to +99). The OUT value will route the click to one of the three stereo effect busses (BUS1, 2, or 3), or send it to one of the three pairs of outputs on the optional Output Expander (AUX1, 2, or 3). The panning and output routing of the click is handled in the same manner as WaveSample panning and output routing.

<i>EDIT</i>	<b>SEQ COUNTOFF</b>
SEQ•SONG	Press Edit / Seq•Song / 8

When:

- SEQ COUNTOFF=OFF — the song or sequence will start playing or recording as soon as you press **Play**, or **Record and Play** (i.e. there is no count off).
- SEQ COUNTOFF=ON — you will hear one bar of click track before the sequencer goes into Play or Record.
- SEQ COUNTOFF=RECORD — you will hear one bar of click track before the sequencer goes into Record, but not prior to going into Play.
- SEQ COUNTOFF=QUIET — there is a *silent* one-bar count before the sequencer goes into Play or Record.

<i>EDIT</i>	<b>SEQ REC MODE</b>
SEQ•SONG	Press Edit / Seq•Song / 9

The SEQ REC MODE parameter determines how sequence data will be recorded by the ASR-10 sequencer when you enter Record. Use the **Data Entry Slider** or the **Up/Down Arrow** buttons to choose between the following options:

- SEQ REC MODE=REPLACE — Anything recorded into an existing track will replace data that was in the track previously. The sequencer will stop recording after reaching the end of the sequence or song, and will enter Audition/Play mode. When the SEQ REC SOURCE= MULTI, REPLACE is automatically selected, and cannot be edited.
- SEQ REC MODE=ADD — New data recorded into an existing track will be added to (or merged with) data already in the track. The existing data will be left intact. Again, the sequencer will exit Record after reaching the end of the sequence or song, and will enter Audition/Play.
- SEQ REC MODE=LOOPED — As with ADD mode, new data recorded into an existing track will be added to (or merged with) data already in the track. However, when SEQ REC MODE=LOOPED, the sequencer will remain in Record for as many times as you play through the song or sequence (rather than dropping out of Record after reaching the end). Think of this as “Drum Machine mode” — as long as the sequence or song keeps playing, you can keep adding parts until you stop the sequencer.

<i>EDIT</i>	<b>SEQ REC SOURCE</b>
SEQ•SONG	Press Edit / Seq•Song / scroll using the arrow buttons

This parameter determines what will be recorded when the MIDI IN MODE= MULTI on the Edit/System•MIDI page — data from the keyboard, from incoming MIDI, or both. Setting this parameter to MIDI is useful if you want to send data from the ASR-10 to a MIDI processor, then record only the processed data coming back from the processor. This parameter only has an effect in MULTI mode; in POLY or OMNI modes the sequencer always records BOTH.

- **BOTH** — The sequencer will record data received either from the keyboard or via MIDI on the track's MULTI IN MIDI channel.
- **KEYBD** — The sequencer will record data only from the keyboard.
- **MIDI** — The sequencer will record only data received via MIDI on the track's MULTI IN MIDI channel.
- **MULTI** — This setting allows you to record data onto multiple ASR-10 tracks simultaneously, but only via MIDI. The ASR-10 will not record notes played on its own keyboard. This is most useful for recording multiple tracks sent from external sequencers or played from guitar controllers. The ASR-10 must be set to receive data from MIDI in MULTI mode (MIDI IN MODE=MULTI on the Edit/System•MIDI page) in order for this feature to work correctly. Multi-Track Record always operates in REPLACE mode, and when SEQ REC SOURCE= MULTI, the SEQ REC MODE parameter is automatically set to REPLACE, and cannot be edited.

**Tip:** It is possible to record on multiple tracks simultaneously from the keyboard, but only if you set the Edit/Instrument MIDI STATUS to MIDI for each of the active (primary and layered) Instrument•Sequence Tracks and then set up a MIDI loop (by connecting the ASR-10 MIDI Out to its own MIDI In). This procedure is a bit tricky, and should only be attempted if you have a good understanding of the system.

<i>EDIT</i>	<b>SONG ATRK REC</b>
SEQ•SONG	Press Edit / Seq•Song / scroll using the arrow buttons

This parameter determines what will be recorded onto Song Audio Tracks when the Song is selected, and you enter Record with an Audio Track selected.

**AUDIO** — the sequencer will record Audio Trigger Events in REPLACE mode. AudioSample data is recorded according to the punch-in rules, described earlier. This is the default value for this parameter.

**MIX+PAN** — the sequencer will record AUDIO-MIX and AUDIO-PAN events in ADD mode.

<i>EDIT</i>	<b>MUTE ATRKS IN REC</b>
SEQ•SONG	Press Edit / Seq•Song / scroll using the arrow buttons

This parameter determines whether or not Audio Track playback will be muted during Audio Track recording.

**YES** — Audio Track playback will be muted during Audio Track recording. This is the default value.

**NO** — Audio Track playback will not be muted during Audio Track recording.

 **Note:** In combination with setting the **Sample•Source Select**, REC SRC=MAIN-OUT, setting the **Edit/Seq•Song**, MUTE ATRKS IN REC=NO, enables Audio Track Bounce-Down.

## Command/Seq•Song Page

These commands are used to create, copy, delete, name, and save sequences and the song. Remember, pressing **Cancel•No** will cancel these commands.

<i>CMD</i>	<b>CREATE NEW SEQUENCE</b>
<i>SEQ•SONG</i>	Press Command / Seq•Song / 0

Use this command to create a new sequence.

- Select **CREATE NEW SEQUENCE**.
- Press **Enter•Yes**. This display allows you to name the sequence, using the Data Entry Controls.
- Press **Enter•Yes** and use the **Left/Right Arrows** to define the time signature.
- Press **Enter•Yes** to complete the command.

<i>CMD</i>	<b>COPY SEQUENCE</b>
<i>SEQ•SONG</i>	Press Command / Seq•Song / 1

This command allows you to copy an entire sequence, including all tracks and sequence parameters. **COPY SEQUENCE** lets you perform commands and edits on the “copy” while preserving the source sequence.

- Select **COPY SEQUENCE**.
- Press **Enter•Yes**. The display reads **FROM SEQ=SEQUENCE ##**. Choose your source sequence.
- Press **Enter•Yes**. The display reads **NEW NAME=SEQUENCE ##**. You can use the data entry controls to change the name of the sequence, or use the default designation.
- Press **Enter•Yes** to complete the command.

<i>CMD</i>	<b>DELETE SEQUENCE</b>
<i>SEQ•SONG</i>	Press Command / Seq•Song / 2

Use this command to erase unwanted sequences.

- Select **DELETE SEQUENCE**.
- Press **Enter•Yes**. The display reads **SEQ=SEQUENCE ##**.
- Use the **Data Entry Slider** or the **Up/Down Arrow** buttons to select the sequence you want to delete.
- When the sequence you want to delete is displayed, press **Enter•Yes**.

<i>CMD</i>	<b>SAVE CURRENT SEQUENCE</b>
<i>SEQ•SONG</i>	Press Command / Seq•Song / 3

Use this command to save the current sequence to disk.

- Make sure the sequence you want to save is selected.
- Select **SAVE CURRENT SEQUENCE**.
- Press **Enter•Yes**. The display reads **NEW NAME=SEQUENCE ##**. If you want to rename your sequence, do so at this time using the data entry controls.
- Press **Enter•Yes**. The display reads **SAVING SEQUENCE ##**, and then **DISK COMMAND COMPLETED**.

<i>CMD</i>	<b>SAVE SONG AND ALL SEQs</b>
<i>SEQ•SONG</i>	Press Command / Seq•Song / 4

Use this command to save all sequencer memory to disk as a file.

- Select SAVE SONG + ALL SEQs.
- Press **Enter•Yes**. The display reads NEW NAME=--\*\*SONG\*\*. You can change the song name at this point.
- Press **Enter•Yes**. The display reads SAVING--\*\*SONG\*\*, and then DISK COMMAND COMPLETED.

<i>CMD</i>	<b>RENAME SONG/SEQUENCE</b>
<i>SEQ•SONG</i>	Press Command / Seq•Song / 5

Use this command to rename the current sequence or song.

- Make sure the song or the sequence you want to rename is selected.
- Select RENAME SONG/SEQUENCE.
- Press **Enter•Yes**. The display reads NEW NAME=SEQUENCE ##. Use the data entry controls to rename the current sequence.
- Press **Enter•Yes** to complete the command.

<i>CMD</i>	<b>SEQUENCER INFORMATION</b>
<i>SEQ•SONG</i>	Press Command / Seq•Song / 6

You can use this command to find out the length of the sequence (in bars), the time signature, the size of all sequencer data, and the size of the current sequence. In addition, you can keep track of the duration of the current sequence in minutes, seconds, and fractions of a second. Scroll using the **Left/Right Arrow** buttons to view these values. If the song is currently selected, an additional parameter will be displayed: the MIDI SONG SELECT=##.

**Tip:** When the song is selected, MIDI Song Select numbers can be assigned as follows:

- Select SEQUENCER INFORMATION.
- Press **Enter•Yes**. Scroll left until the display reads MIDI SONG SELECT=##.
- Select a MIDI Song Select number 0 through 127 with the Data Entry Controls.

The song can be assigned a MIDI Song Select number from 0 through 127. MIDI Song Select numbers 0 through 127 are transmitted via MIDI when you load a new song into the ASR-10, or when the currently loaded song is selected. MIDI Song Selects can be used to instruct a remote sequencer or drum machine to select a new song. The MIDI SONG SELECT parameter (on the Edit/System•MIDI page) must be set to "ON" for this to work. MIDI Song Select numbers are stored with the song when you save the song to disk.

**Note:** This page is mainly for information *only*. You cannot change any of the parameters (except for the MIDI SONG SELECT number) from this page.



<i>CMD</i>	<b>ERASE SONG + ALL SEQS</b>
<i>SEQ•SONG</i>	Press Command / Seq•Song / 7

Using this command clears all the sequencer memory. Save to disk all sequences that are important to you before performing this command.

- Select ERASE SONG + ALL SEQS.
- Press **Enter•Yes**. The display reads ERASE ALL SEQ DATA?
- Press **Enter•Yes** to complete the command (or **Cancel•No** to abort the procedure).

<i>CMD</i>	<b>APPEND SEQUENCE</b>
<i>SEQ•SONG</i>	Press Command / Seq•Song / 8

This command allows a sequence to be attached (appended) to the end of another sequence. The FROM SEQ= (source) will be attached to the end of the TO SEQ= (destination). You can also append a sequence to itself to make a longer sequence. For example, if you have a drum sequence that is four bars long, you could append it to itself to create an eight bar sequence. Do it again and you have a sixteen bar sequence. The source sequence must have the same time signature as the destination sequence.

- Select APPEND SEQUENCE.
- Press **Enter•Yes**. The display reads FROM SEQ=SEQUENCE ##. This is the source sequence. Use the **Up/Down Arrow** buttons to select the source sequence.
- Press **Enter•Yes**. The display reads TO SEQ=SEQUENCE ##. This is the destination sequence. Use the **Up/Down Arrow** buttons to select the destination sequence.
- Press **Enter•Yes** to complete the command. The source sequence will be attached to the end of the destination sequence. Press **Cancel•No** to abort the procedure.

<i>CMD</i>	<b>CHANGE SEQUENCE LENGTH</b>
<i>SEQ•SONG</i>	Press Command / Seq•Song / 9

Use this command to add bars to or delete bars from a sequence.

- Select CHANGE SEQUENCE LENGTH.
- Press **Enter•Yes**. The display reads ADD ## BARS AT ##.  
If, for example, you wanted to add 2 bars to your sequence starting at bar 4, adjust the display to look like this: ADD 2 BARS AT 4.
- Press **Enter•Yes** to complete the command (or **Cancel•No** to abort the procedure).
- Or, you can underline ADD in the display and use the **Up Arrow** button to change it to DELETE. You can now delete specific bars from the sequence using the above procedure.
- Press **Enter•Yes** to complete the command (or **Cancel•No** to abort the procedure).

<b>CMD</b>	<b>EDIT SONG STEPS</b>
<b>SEQ•SONG</b>	Press Command / Seq•Song / scroll using the arrow buttons

This command is used to link sequences together to create a song. To do this:

- Select **EDIT SONG STEPS**.
- Press **Enter•Yes**. The display shows:

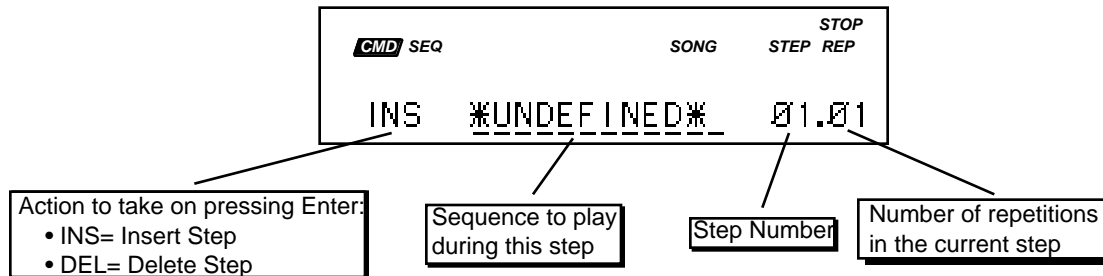

There are four things that can be selected (underlined) on this screen:

- On the left you can choose **INS** (insert step) or **DEL** (delete step). This is normally set to **INS**, for inserting new steps into your song (use the **Up/Down Arrow** buttons and select **DEL** to delete the step).
- In the middle of the screen you choose which sequence will play for this song step. This space currently reads **\*UNDEFINED\***, as shown above, when no steps have yet been defined for the song.
- To the right of the display you see the step number (which in the case of a new song will be step 01) and the number of repetitions (or reps) for that step.
- Press the **Right Arrow** button until you see the following **TRACK STATUS** display:

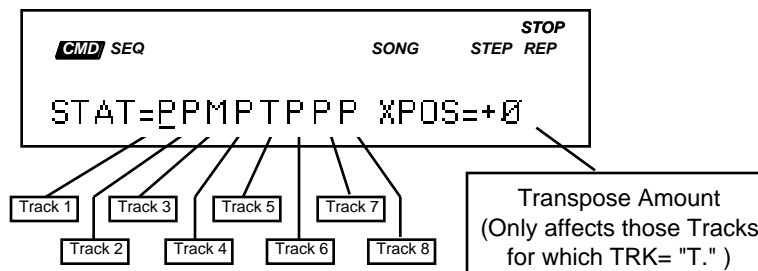

Here, for each step of the song, you can select Play, Mute, or Transpose Status for each track of the sequence.

- "**P**" means **PLAY** — tracks that show a "**P**" will play normally.
- "**M**" means **MUTE** — selecting "**M**" for a track will silence that track during the song step.
- "**T**" means **TRANSPOSE** — tracks that show a "**T**" will be transposed up or down, by the amount shown to the right (in whole steps), for the duration of the step.

See *Section 12 — Sequencer and Audio Track Concepts* for a more detailed description of **EDIT SONG STEPS**.

<i>CMD</i> SEQ•SONG	<b>ERASE ALL AUDIOSAMPLES</b>
	Press Command / Seq•Song / scroll using the arrow buttons

This command will erase all AudioSamples within the current SONG + ALL SEQS (Project) file from RAM, SCSI, or BOTH. This will not erase SCSI resident AudioSamples that are triggered by other SONG + ALL SEQS (Project) files.

- Press **Enter•Yes**. The display shows:

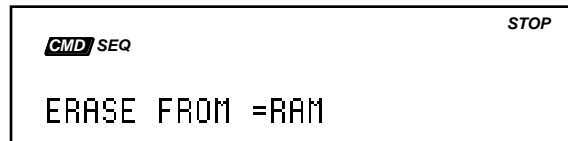

- Use the Data Entry Controls to select RAM, SCSI, or BOTH.
- Press **Enter•Yes**. The display asks “ERASE ASMPLS?”.
- Pressing **Enter•Yes** will execute the command.
- Pressing **Cancel•No** will abort the command.

<i>CMD</i> SEQ•SONG	<b>SET SONG ATRK PLAYBACK</b>
	Press Command / Seq•Song / scroll using the arrow buttons

This command determines which pair of Audio Tracks (Song or Sequence) will be played when the Song is selected. It also enables or disables Song Audio Track recording.

- Press **Enter•Yes**. The display shows:



Range: SEQ ATRKS ONLY, SONG-A + SEQ-B, SEQ-A + SONG-B, SONG ATRKS ONLY

- Pressing **Enter•Yes** will execute the command. If any Audio Tracks have been recorded, the PREPARING AUDIO TRACKS message will be briefly displayed while the Audio Tracks are cued up for playback.
- This parameter defaults to PLAY=SEQ ATRKS ONLY upon booting.
- If the SONG is not selected when the SET SONG ATRK PLAYBACK command is invoked, the song will be automatically selected.
- If the song is selected, and this is set to PLAY=SEQ ATRKS ONLY, trying to enter record on an Audio Track results in the NOT SET FOR SONG ATRK message.

IF:	THEN:
PLAY=SEQ ATRKS ONLY	You will be preparing to play sequence Audio Tracks only, and to disallow Song Audio Track recording and playback.
PLAY=SONG-A + SEQ-B	You will be preparing to record and play back a Song Audio Track using Audio Track A, and to play the data on Audio Track B in the sequences that make up the song. You will be unable to record or play back from Song Audio Track B.
PLAY=SEQ-A + SONG-B	You will be preparing to record and play back a Song Audio Track using Audio Track B, and to play the data on Audio Track A in the sequences that make up the song. You will be unable to record or play back from Song Audio Track A.
PLAY=SONG ATRKS ONLY	You will be preparing to record and play back Song Audio Tracks only, and to ignore any data recorded on both Audio Tracks in the sequences that make up the song.

## Edit/(sequence) Track Page

These parameters control the sequencer tracks. The parameter values displayed apply to the currently selected sequence track (yellow selected LED solidly lit). The settings for MIX, PAN, OUT, and EFFECT MOD CONTROL are saved with the bank. To select a track for editing, press the desired **Instrument•Sequence Track**.

**Tip:** When Edit/Track parameters are displayed, pressing a loaded **Instrument•Sequence Track** button will display the Edit/Track values for the selected track. This feature provides quick access to the same parameter for different tracks when setting track parameter values relative to one another.

<i>EDIT TRACK</i>	<b>SEQ TRACK STATUS (Mute/Play/Solo)</b>
	Press Edit / Track / 0

<i>EDIT TRACK</i>	<b>SNG TRACK STATUS (Mute/Play/Solo)</b>
	Press Edit / Track / 3 (when a song is selected)

The track status parameter allows you to control the playback status of each track within the selected song or sequence. The cursor (underline) tells you which track is selected. To select a different track, press its **Instrument•Sequence Track** button. The underline will move to that track.

You can select any of the tracks which contain recorded data and use the **Up/Down Arrow** buttons to select PLAY, SOLO, or MUTE status.

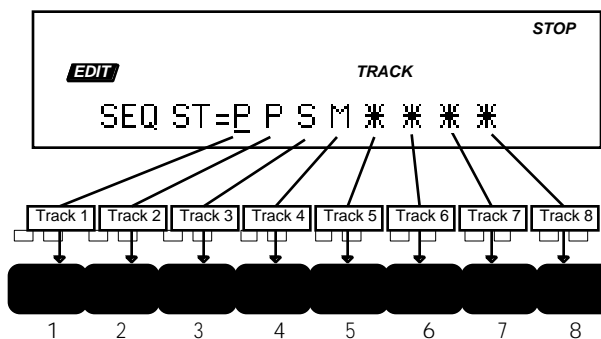

The display shows the status of each track:

- “P” means PLAY — Tracks that show a “P” will play normally.
- “S” means SOLO — Selecting “S” for any track will “solo” the track muting all the others.
- “M” means MUTE — Selecting “M” for a track will silence that track.
- A “Star” indicates that there is nothing recorded on that track (no track data). In the illustration, Tracks 5, 6, 7, and 8 contain no sequence data.

When the song is selected, if you go to the EDIT/Track page you will find an additional parameter screen has been added — it looks just like the track status screen for a sequence except it says SNG instead of SEQ in the left corner of the display. This shows you the status of the song tracks. You can select “P” (play), “M” (mute), or “S” (solo) for any of the song tracks just as you would for sequence tracks.

EDIT TRACK	<b>MIX - PAN</b>
	Press Edit / Track / 1 (for Mix) 2 (for Pan)

### Track MIX

The MIX parameter controls the volume for each **Instrument•Sequence Track**. The ASR-10 stores a default MIX setting for each track of a sequence. When you record/overdub a sequence track, the default MIX setting will be recorded onto the track. When you play a sequence back, each track will have the correct volume balance.

Range: 0 to 99

**Tip:** When TRANSMIT ON = INST CHAN, on the Edit/System•MIDI page, editing the MIX value will transmit MIDI Volume messages (Controller #7) on the selected **Instrument•Sequence Track's** MIDI OUT CHANNEL (on the Edit/Instrument page).

### Recording the Default Track MIX Setting

Each **Instrument•Sequence Track** has its own default MIX setting that is recorded each time that a sequence track is recorded/overdubbed. This default MIX setting is fixed, and applies to the entire duration of the track (unlike *continuous* volume changes recorded with the Foot Pedal, or MIXDOWN VOLUME events recorded on the songs tracks — as described in the previous Section). If the Edit/Track MIX value is edited during playback, the default track MIX setting will be restored each time the sequence loops around. To permanently change the default MIX setting for a track:

- Set SEQ REC MODE= ADD on the Edit/Seq•Song page. This will prevent any unwanted changes to existing track events.
- Select the **Instrument•Sequence Track** for which you want to adjust the MIX.
- Press **Play**, and then press **Edit**, followed by **Track**, and adjust the MIX value while listening to the track until you find the proper level.
- Once you've decided on the MIX value, press **Stop•Continue**.
- While holding down **Record**, press **Play**. After the first bar of the sequence has been recorded, press **Stop•Continue**.
- The KEEP= OLD/NEW Audition page will be displayed. You can't audition the volume change on the KEEP=OLD/NEW page. Select KEEP=NEW and press **Enter•Yes** to keep the results. Press **Play**. You will now hear the new default MIX setting, and it will now be permanently recorded on the track. If you don't like the new default MIX setting, simply repeat the above procedure and set a new MIX level.
- It's a good idea to return to the Edit/Seq•Song page to set the SEQ REC MODE back to REPLACE for later sequencing.

**Tip:** You can use the optional CVP-1 Foot Pedal to record *continuous* volume changes onto a sequence track. Set PEDAL=VOLUME on the Edit/System•MIDI page, and then record the Pedal•CV controlled volume changes with SEQ REC MODE= ADD. This will record volume (MIDI Controller #7) events onto the track, which can then be edited like any other sequencer event.

For information about mixing down song tracks, see **Recording MIXDOWN VOLUME and MIXDOWN PAN**, in the previous Section.

**Track PAN**

The PAN parameter controls the current pan position for each **Instrument•Sequence Track**. This parameter allows you to give each track in a sequence or the song its own specific PAN setting, overriding the WaveSample PAN settings (on the Edit/Amp page).

Range: -99 (full left) to +99 (full right), or WAVESAMPLE

When WAVESAMPLE is selected, each **Instrument•Sequence Track** will use the Edit/Amp PAN settings that are contained within the instrument.

<i>EDIT TRACK</i>	<b>OUT (Output Routing)</b>
	Press Edit / Track / 4

The OUT parameter controls the output routing for each **Instrument•Sequence Track**. This parameter allows you to override the Edit/Amp OUT settings for an instrument, and reroute local sequence/song track playback to a specific output bus.

Range: WAVESAMPLE, BUS1, BUS2, BUS3, AUX1, AUX2, or AUX3

When WAVESAMPLE is selected, each **Instrument•Sequence Track** will use the Edit/Amp OUT settings that are contained within the Instrument.

**Note:** When Sample•Source Select/REC SRC Field 1 is set to INPUT+FX, all Voices go DRY, and any **Instrument•Sequence Tracks** that were routed to BUS1, 2, or 3 will all show OUT= DRY - - FX BUS IN USE on this screen.

**Note:** Changing the MIX, PAN or OUT (Output Routing) of a song track will also affect any corresponding sequence tracks.

<i>EDIT TRACK</i>	<b>EFFECT MOD CONTROL</b>
	Press Edit / Track / 5

Because of the dynamic nature of the ASR-10's signal processor, instruments can interact and control certain parameters of the selected effect. But what happens when you are using a BANK or ROM effect, one that is accessed globally by all the instruments in memory? Without a way to determine which of the instruments will have control of the effect, controllers from all of the instruments would send confusing messages to the signal processor.

This parameter is specifically designed to be used when a sequence or song is using a BANK or ROM effect, and acts as a "traffic cop" for the instrument controllers.

- ON — The **Instrument•Sequence Track** will control the effect with its controllers. Any parameters within the effect that respond to controllers will take their cues from this **Instrument•Sequence Track**.
- OFF — Controller information generated by the **Instrument•Sequence Track** will be ignored by the signal processor.

Obviously, since this parameter is designed to let one instrument control the effect, you will want to set one **Instrument•Sequence Track** to EFFECT MOD CONTROL= ON, and all others to OFF.

<i>EDIT TRACK</i>	<b>MULTI-IN MIDI CHAN</b>
	Press Edit / Track / 6

Determines which MIDI channel (1 to 16) the selected **Instrument•Sequence Track** will receive on if the MIDI IN MODE=MULTI or MONO B on the Edit/System•MIDI page. Remember, the Edit/Instrument MIDI STATUS parameter has to be set to LOCAL, BOTH, or MIDI to receive incoming MIDI data.

This parameter has no bearing on which channel the **Instrument•Sequence Track** will transmit on (that is determined by the MIDI OUT CHANNEL parameter on the Edit/Instrument page).

**Note:** In MULTI and MONO B modes, different MIDI receive channels must be selected for each **Instrument•Sequence Track** that you want to receive via MIDI. If more than one sequence track is set to the same MULTI IN MIDI CHAN, only the lowest numbered **Instrument•Sequence Track** will receive via MIDI.

The MULTI-IN MIDI CHANNEL set-up for all eight **Instrument•Sequence Tracks** is saved with the global parameters. Therefore, it is a good idea to use the SAVE GLOBAL PARAMETERS command (on the Command/System•MIDI page) to put the MULTI-IN MIDI CHANNEL set-up onto the disk containing your O.S. When the ASR-10 boots up, it will automatically install the MULTI-IN MIDI CHANNEL settings for you.

**Tip:** If you use several different MIDI reception configurations in your studio, make several copies of the O.S. disk, and save different GLOBAL PARAMETERS on each one. You can then use the LOAD GLOBAL PARAMETERS command (Command/System•MIDI page) to load the different configurations for each O.S. disk.

## Edit/(audio) Track Page

These parameters affect the REC SRC Signal Monitor. The parameter values displayed apply to the currently selected audio track (yellow LED solidly lit). To select a track for editing, press the desired **Audio Track** button.

The following Edit/(audio) Track parameters are located at the same screen address as the corresponding Edit/(seq) Track screen, and they show the same current parameter.

Pressing an **Audio Track** button when the display is showing an Edit/(seq) Track parameter screen that is not applicable to audio tracks, will display the last selected Edit/(audio) Track screen. When the display is showing an Edit/(seq) Track parameter screen that is applicable to audio tracks, pressing an **Audio Track** button will display the selected audio track's value(s) for the current parameter. While an audio track is selected, only applicable Edit parameter screens will be subsequently displayed.

- When the Sample • Source Select REC SRC parameter is set to INPUTDRY, the audio tracks monitor the Audio Inputs. The left Audio Input is monitored on **Audio Track A** and the right Audio Input on **Audio Track B**.
- When the Sample • Source Select REC SRC parameter is set to INPUT+FX, the ESP chip is dedicated to processing the Audio Inputs, and the audio tracks monitor the direct output of the ESP chip. The left effects channel is monitored on **Audio Track A** and the right channel on **Audio Track B**. The Wet/Dry mix is set on the Edit/Effects page.
- When the Sample • Source Select REC SRC parameter is set to MAIN-OUT, no audio signals are monitored through the Edit/(audio) Track settings. All other ASR-10 instruments retain their Edit/(seq) Track settings.
- When the Sample • Source Select REC SRC parameter is set to DIGITAL, the audio tracks monitor the Digital Input. The left channel is monitored on **Audio Track A** and the right channel on **Audio Track B**.
- Edit/(audio) Track parameter settings are saved with the global parameters (using the Command/System • MIDI SAVE GLOBAL PARAMETERS command).

<i>EDIT</i>	<b>ATRK PLAYBACK STATUS</b>
<i>(Audio) TRACK</i>	Press Edit /(audio) Track / 0

Double-clicking the **Track** button on the Edit/(audio) Track page will reveal the following ATRK PLAYBK STATUS parameter:



Range: \* (TRACK is empty), P (play — TRACK contains data, and is unmuted), M (mute — TRACK contains data, and is muted)

- Press the **Audio Track** buttons to move the cursor. Audio Tracks that are muted before entering record will not have their data cued up, and will not play if unmuted during play.

**Note:** When recording Audio Tracks with **Edit/Seq • Song**, MUTE ATRKS IN REC=YES, Audio Track playback on the track being recorded on is automatically muted while the ASR-10 is in Record, and the ATRK PLAYBK STATUS is displayed as below, and cannot be edited.



The currently implemented **Edit/(audio) Track**, MIX, PAN and OUT parameters affect both the REC SRC signal monitor as well as the PLAYBACK monitor.

When the **Sample•Source Select**, REC SRC Field 1 is set to MAIN-OUT, only the Audio Track Playback is monitored through the **Edit/(audio) Track** settings. The Audio Inputs are disabled, and both Source-Monitor LEDs remain off at all times. The Source Monitor voices are not needed to monitor this REC SRC, as it is always audible out the MAIN OUTs.

<i>EDIT TRACK</i>	<b>ATRK MIX - PAN</b>
	Press Edit / Track / 1 (for Mix) 2 (for Pan)

### Audio Track MIX

The MIX parameter controls the volume for the signal being monitored on each audio track.

Range: 0 to 99

The default MIX value is 60, because BOOST is permanently ON on the Audio Tracks.

### Audio Track PAN

The PAN parameter controls the current pan position for the signal being monitored on each audio track.

Range: -99 (full left) to +99 (full right)

The default PAN settings are ATRK-A PAN= -99, and ATRK-B PAN= +99.

### How MIX and PAN parameters work with Version 2 O.S.

The following chart describes how the **Edit/(audio) Track**, MIX and PAN parameters interact with Audio Track source monitoring and playback. For more information, refer to the ASR-10 Musician's Manual.

How the Audio Track MIX and PAN parameters work			
If you edit the values:	in Mono:	In Stereo:	Sequencer plays back MIX or PAN:
The Display changes:	YES (mono)	YES (stereo)	NO
The Playback volume changes:	YES (mono)	YES (stereo)	YES (mono)
The Monitor volume changes:	YES (mono)	YES (stereo)	NO

**Tip:** Using the FILTER AUDIO EVENTS command on Sequence Audio Tracks will remove the “default” Audio Track MIX events. The default MIX events are recorded each time you enter record on an Audio Track. This is useful to prevent the playback of these events from interfering with manual edits to the MIX value that you might make during bounce-down.

<i>EDIT</i> <i>TRACK</i>	<b>OUT (Audio Track Output Routing)</b>
	Press Edit / Track / 4

This parameter allows you to route the signal being monitored on each audio track to a specific output bus.

Range: BUS1, BUS2, BUS3, AUX1, AUX2, or AUX3

**Note:** When Sample • Source Select/REC SRC Field 1 is set to INPUT+FX, all voices go DRY, and any audio tracks that were routed to BUS1, 2, or 3 will all show OUT= DRY -- FX BUS IN USE on this screen.

<i>EDIT</i> <i>(Audio) TRACK</i>	<b>ASMPLNAME (AudioSample Name)</b>
	Press Edit /(audio) Track / scroll using the arrow buttons

The ASMPLNAME parameter displays the name of the AudioSample that will be the target of all **Command/(audio) Track** commands. This parameter can be edited to select any AudioSample in the current SONG + ALL SEQS (Project) file, and once edited, does not necessarily reflect the AudioSample triggered by the currently selected **Audio Track**.

The list of all AudioSamples in the current SONG + ALL SEQS (Project) file can be accessed with the Data Entry Controls.

Whenever the sequencer is running, the ASMPLNAME value will be updated in real-time to indicate the name of the AudioSample that was last triggered by an Audio Trigger Event on the currently selected Audio Track.

After the sequencer is stopped, this parameter will always default to the name of the last AudioSample that was being triggered by the selected Audio Track when the sequencer was stopped. If no AudioSamples exist, or if the sequence or the song has just been selected, the display will read:

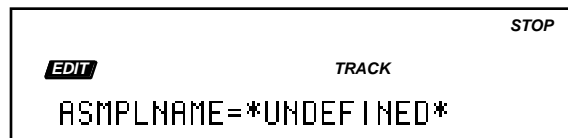

If the ASMPLNAME parameter is edited while the sequencer is stopped, selecting an Audio Track, or pressing **Play** will update the parameter value to reflect the currently triggered AudioSample.

The ASMPLNAME parameter is duplicated in several **Command/(audio) Track** Commands. If the ASMPLNAME parameter is edited within a Command, the **Edit/(audio) Track**, ASMPLNAME parameter will inherit the edited value, and the current AudioSample context will remain for use by other Commands (until either the Transport Controls or the GOTO function are used).

**Note:** As AudioSamples are recorded, they are each assigned a unique default name (ASMPL—#####). AudioSamples can be renamed with the **Command/(audio) Track**, RENAME AUDIOSAMPLE Command.

## Command/Track Page

These commands allow you to manipulate sequence data on the individual tracks.

<i>CMD</i>	<b>QUANTIZE TRACK</b>
<i>TRACK</i>	Press Command / Track / 0

This command automatically corrects the timing of a track. After you have recorded a track, the ASR-10 can post-quantize the track and move the notes to the nearest beat boundary. For example, if you set quantize to 1/4, all the notes will be adjusted to the nearest quarter note. You can compare the quantized track with the original track on the Audition page, before deciding whether or not to keep the results.

- Select QUANTIZE TRACK.
- Press **Enter•Yes**. The display reads TRACK=##. Select the track you want to quantize by pressing one of the active **Instrument•Sequence Track** buttons.
- Press **Enter•Yes**. The display reads QUANTIZE TO ##### NOTE. The quantize values are: 1/4, 1/4T (triplets), 1/8, 1/8T, 1/16, 1/16T, 1/32, 1/32T, 1/64, 1/64T notes. Select a quantize value.
- Press **Enter•Yes**. The display reads ENTIRE TRACK. Pressing **Enter•Yes** at this point will edit the entire track and place you on the Audition (KEEP=OLD/NEW) page. If you wish to edit only a portion of the track, press the **Up Arrow** button until the display reads SET RANGES. You can then press **Enter•Yes** and set both the key range and bar/beat range in which the editing will take place. After setting these ranges, the editing will take place and you will be placed on the Audition page. If you've previously set editing ranges for the current song or sequence, you can use the **Up Arrow** button to call up USE RANGES. Pressing **Enter•Yes** will commence editing based on the previously set range values.
- Press **Enter•Yes** if you want to keep the quantized version of the track, or **Cancel•No** to keep the unquantized track.

<i>CMD</i>	<b>COPY TRACK</b>
<i>TRACK</i>	Press Command / Track / 1

This command copies the currently selected track (or any bar range of the track) to any other track in any other sequence.

- Select COPY TRACK.
- Press **Enter•Yes**. The display reads FROM TRACK= ##. Select the source track by pressing one of the active **Instrument•Sequence Track** buttons.
- Press **Enter•Yes**, or scroll right to select TO SEQ= (sequence name). Use the **Up/Down Arrow** buttons to select a destination sequence.
- Scroll right to select TO TRACK= ##. This will default to the lowest numbered empty track. Choose a destination track by pressing one of the active **Instrument•Sequence Track** buttons.
- Scroll right to select AT BAR= ##.
- Scroll right to select RANGE= ##. The range parameter lets you select either the entire range, or set your own ranges; allowing you to define the key range, and the start and end bar/beat to be copied.
- Press **Enter•Yes**. The display reads KEEP=OLD/NEW.
- Press **Enter•Yes** to keep the new track (or **Cancel•No** to keep the original track).

<i>CMD</i> <i>TRACK</i>	<b>ERASE/UNDEFINE TRACK</b>
	Press Command / Track / 2

Use this command to erase a selected track. Keep in mind, even if you delete an instrument from an **Instrument • Sequence Track** location, the sequence/song track data is still there until you erase it. You can determine whether a track is defined by pressing **Edit**, then **Track**. Scroll to the Track Status parameter. An asterisk indicates that a track is undefined.

- Select ERASE/UNDEFINE TRACK.
- Press **Enter • Yes**. The display reads TRACK=##. Select the track you want to erase by pressing one of the active **Instrument • Sequence Track** buttons.
- Press **Enter • Yes** to complete the command (or **Cancel • No** to abort the procedure).

<i>CMD</i> <i>TRACK</i>	<b>FILTER EVENT</b>
	Press Command / Track / 3

This command provides a convenient way to eliminate (ERASE) or copy specific information in a track, while leaving other track data intact.

- Select FILTER EVENT.
- Press **Enter • Yes**. The display reads TRACK=##. Select the track you want to edit by pressing one of the active **Instrument • Sequence Track** buttons.
- Press **Enter • Yes**. The display shows the following:

<i>CMD</i>	<i>TRACK</i>	<i>STOP</i>
MODE=ERASE		

On this screen, by using the **Data Entry Slider** or the **Up/Down Arrow** buttons, you select the type of event to be “filtered” (ERASED or COPIED). Editing this parameter will change the Event type display, found by pressing the **Right Arrow** button. When MODE=COPY, the Event type display reads “COPY TO TRACK (##).” When MODE=ERASE, the Event type display reads “ERASE= (event type).”

The following event types are available for editing in this parameter:

- CNTL-1.MODWHEEL — Mod Wheel
- CNTL-4.PEDAL — Control Voltage
- CNTL-7.VOLUME — Volume
- CNTL-64.SUSTAIN — Sustain
- CNTL-70.PATCHSEL — Patch Select
- CNTL-XX.XCTRL — External Cnt
- ALL.CONTROLLERS
- CHANNEL-PRESSURE
- MIXDOWN-VOLUME — Track Volume
- MIXDOWN-PAN — Track Pan
- PITCH-BEND — Pitch Bend Wheel
- KEY-PRESSURE — Poly-Key Press
- PROGRAM-CHANGE
- KEY-EVENTS

Select the type of event for editing by using the **Up/Down Arrow** buttons, then press **Enter • Yes**. At this point, there are two editing options:

- ERASE — This option will erase all events or a portion of events of the type specified. Press **Enter • Yes** and the display will read ENTIRE TRACK. Pressing **Enter • Yes** at this point will erase all of the selected events on the entire track and place you on the Audition page. If you wish to erase only events in a portion of the track only, press the **Up Arrow** button until the display reads SET RANGES. You can then press **Enter • Yes** and set both the key range and bar/beat range in which the editing will take place. After setting these ranges, the editing will

take place and you will be placed on the Audition page. If you've previously set editing ranges for the current song or sequence, you can use the **Up Arrow** button to call up USE RANGES. Pressing **Enter•Yes** will commence editing based on the previously set range values.

- **COPY** — This option allows you to copy events to another track. Scroll right to select the Track number value. Use the **Instrument•Sequence Track** buttons to select the destination track. After selecting the destination track, press **Enter•Yes**. From this point on, the editing proceeds from this point in the same manner as erasing events.

**Note:** The Copy mode of the Filter Command works just like the Copy Track command: Data on the destination track will be erased.

<i>CMD</i>	<b>MERGE TWO TRACKS</b>
<i>TRACK</i>	Press Command / Track / 4

This command merges all key and controller information from one track into another track. This allows you to record several different tracks, all with the same instrument and MIDI configuration, then merge them into one. This is useful for creating sound-on-sound type sequences where you add rather than replace track data.

**Note:** You may run into problems if you try to merge two tracks with similar controller events. For instance, if you have pitch bend in your source track, and pitch bend in the destination track, and you merge them together at the same point in the sequence, it will result in “controller fights.” If this happens, first erase the controller from one of the tracks, and then merge the two tracks together.

<i>CMD</i>	<b>EVENT EDIT TRACK</b>
<i>TRACK</i>	Press Command / Track / 5

Use this command to add, delete, lengthen, shorten, change the velocity, or the position of individual notes in a track. EVENT EDIT TRACK is a very useful command. Here are the fundamentals.

The sequencer uses “bars,” “beats,” and “clocks” to mark time during the recording of a track. The illustration below represents a stream of events recorded during two bars of a track.

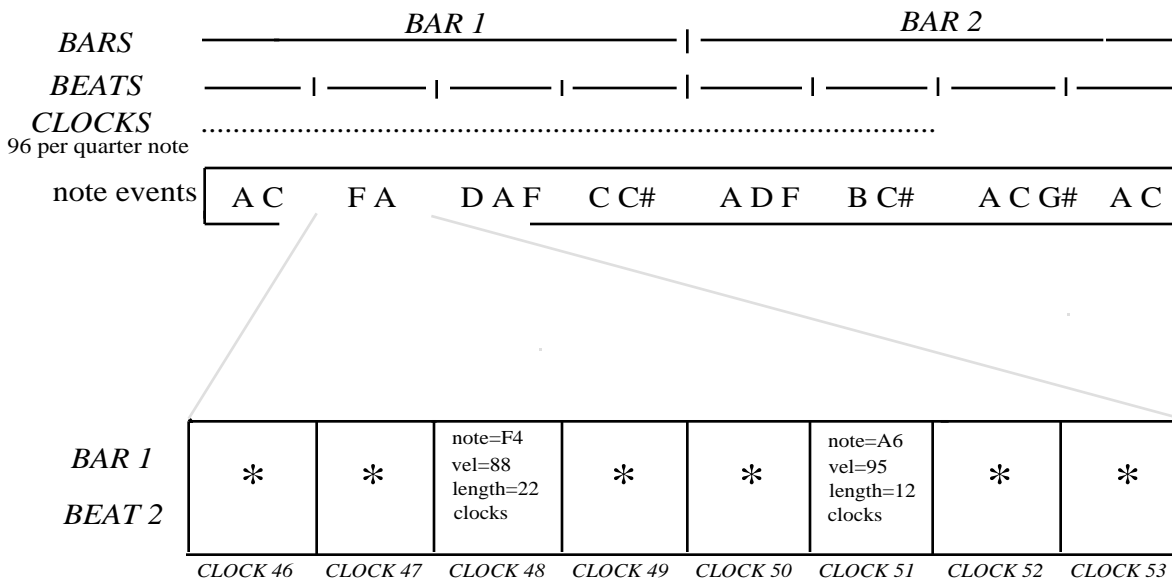

There are always 96 clocks per quarter note. The number of beats in a bar depends upon the time signature of the sequence. The number of bars depends upon the sequence length.

Sequencer tracks are made up of note events that occur at some location in the track. The location is defined in terms of bars, beats, and clocks. Note events consist of key, velocity, and duration information.

In the illustration above, an event occurs at BAR 1, BEAT 2, CLOCK 48. The note event is key F4. It was struck at a velocity of 88 (V=88). Its NOTE LENGTH (duration) is 22 CLOCKS. All this information is displayed for each key event when you use the EVENT EDIT TRACK command. You can change the key, velocity, or length of any key event. You also can delete events and insert new ones.

The EVENT EDIT TRACK function works on an individual track basis.

- With the track you want to edit selected, press the **Command** button, followed by the **Track** button. Scroll until the display shows EVENT EDIT TRACK. Press the **Enter•Yes** button. The display shows:

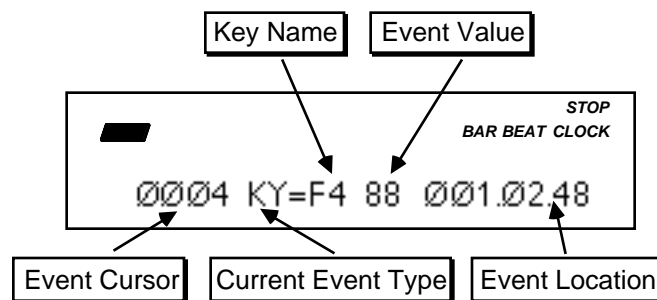

This is the Event Locating screen.

### Event Cursor

When this field is selected, you can use the **Data Entry Slider** or **Up/Down Arrow** buttons to step ahead or back in time among the events in the track to find the one(s) you want to edit. When you press the **Up/Down Arrow** buttons, it will advance to the next or previous event of the type specified in the Event Type Filter. Moving the **Data Entry Slider** will scroll quickly through all the events in the track. You will hear the notes in the sequence play as you step through the track.

### Current Event Type

This displays the current event type being viewed. This parameter is display only and cannot be changed from this screen.

### Key Name

This parameter displays the key name that is either being played (when Current Event Type is "KY" KEY EVENTS) or being affected by pressure (when Current Event Type is "KP" KEY PRESSURE).

To change the Key Name for the current event, select the Key Name parameter and play the new key on the keyboard.

### Event Value

This shows the value of the current event. The values can be changed using the **Data Entry Slider** or **Up/Down Arrow** buttons. These changes take place as they are made.

### Event Location

Shows the current location in terms of Bar, Beat, and Clock. These three location fields can be individually selected by repeated presses of the **Left/Right Arrow** buttons. This allows you use the **Up/Down Arrow** buttons to step ahead or back in time by bars, beats or clocks, depending on which field is selected. Note that this parameter does not alter the track data in any way, it merely provides a method for locating and viewing events within a track.

**Note:** When event editing a song track, there will be an additional display which will have two more location values, corresponding to the step and repetition of the song. This screen can be found by pressing the **Right Arrow** button once.

Press the **Left Arrow** button until you see the following:



### EVENT TYPE — Event Type Filter

This controls which types of events will be shown on the Event Locating screen as you scroll up through the events in the track. When set to AL = ALL EVNT, every event in the track will be listed. When set to any other value, only events of the type selected will be selected. Events of all other types will be left out of the list. When the Event Type is changed and you return to the Event Locating screen, the display will jump directly to the next event of the type shown, skipping other types. Event Types that can be selected here are:

- |                                  |  |
|----------------------------------|--|
| MW MODWHEEL= Mod Wheel           | MV MIX-VOL= Mixdown Volume             |
| FP FOOTPEDL= Foot Pedal          | MP MIX-PAN= Mixdown Pan                |
| VL VOL-PEDL= Volume Pedal        | PB PITCHBND= Pitch Bend Wheel          |
| SU SUSTAIN= Sustain Pedal        | KP KEY-PRSR= Key Pressure              |
| PS PATCH-SL= Patch Select        | PC PROG-CHG= Program Change            |
| XC EXT-CONT= External Controller | KY KEY-EVNT= All Key Events            |
| CO ALL-CONT= All Controllers     | AL ALL-EVNT= All notes and controllers |
| CP CHANPRSR= Channel Pressure    |  |

### Duration Screen for Key Events and Key Pressure Events

When event editing KY KEY-EVNTs or KP KEY-PRSR events on the Event Locating screen, pressing the **Right Arrow** button once (when editing a sequence track), or twice (when editing a song track) brings up an additional screen that looks like this:



These two parameters set the duration for a particular Key Event or Key Pressure Event in beats and clocks. Remember, this screen only appears when the current event is a KY Key Event or KP Key Pressure event.

## INSERT and DELETE

After selecting a location with the Event Locating screen, you can INSERT or DELETE events.

- From the Event Locating Screen, press the **Enter•Yes** button. The display reads:



From this screen, you can use the **Left/Right Arrow** buttons to choose between the following:

- INSERT a note, controller, or program change onto the selected track
- DELETE a note controller, or program change from the selected track

- INSERT** — This command is used to insert an event into the selected track. To utilize this function, select the type of event to be inserted with the Event Type Filter. Scroll to the Event Locating screen and select the location where the event is to be placed. On events other than key events, set the desired event value. Finally, use this screen to insert the event. Pressing **Enter•Yes** with **INSERT** underlined will insert the event.
- DELETE** — Removes the event displayed on the Event Locating Screen. As with the INSERT command, select the type of event to be removed with the Event Type Filter. Scroll to the Event Locating screen and select the location where the event that is to be removed is located. Finally, use this screen to remove the event. Pressing **Enter•Yes** with **DELETE** underlined will remove the event.

**Tip:** When a Key Event is deleted, the key number and velocity are remembered. The next time a Key Event is inserted it will default to the value of the last Key Event deleted. This provides a convenient way to move a single Key Event that may be off-time. This only applies to KY KEY EVENTS.

## Auditioning Changes

Once you have completed making changes to the track and would like to hear how they sound, press the **Cancel•No** button. This places you on the Audition page. From here, you can decide whether to keep the changes you've made, or go back and try again.

If you have not made any changes to the track, pressing **Cancel•No** exits the EVENT EDIT TRACK command.

<i>CMD</i>	<b>TRANPOSE TRACK</b>
<i>TRACK</i>	Press Command / Track / 6

Use this command to transpose notes in a track by as much as an octave, up or down.

- Select TRANPOSE TRACK.
- Press **Enter•Yes**. The display reads TRACK=##.
- Select TRANPOSE AMOUNT=## (Range -12 to +12 semitones).
- Select RANGE. Set the key and bar/beat ranges as described in earlier commands.
- Press **Enter•Yes**. The display reads KEEP=OLD/NEW.
- Press **Enter•Yes** to complete the command (or **Cancel•No** to abort the procedure).

**Tip:** To transpose a track by more than one octave, use this command several times.



<i>CMD</i>	<b>SCALE EVENT</b>
<i>TRACK</i>	Press Command / Track / 7

Use this command to increase or decrease the effect of a controller in a track.

- Press **Enter**•**Yes**. The display reads TRACK=##.
- Scroll to SCALE=\_. The controllers on this page include:

KEY-VELOCITY	CNTL-XX.XCTRL
CNTL-1.MODWHEEL	ALL.CONTROLLERS
CNTL-4.PEDAL	CHANNEL-PRESSURE
CNTL-7.VOLUME	MIXDOWN-VOLUME
CNTL-64.SUSTAIN	MIXDOWN-PAN
CNTL-70.PATCHSEL	PITCH-BEND

- Scroll to SCALE BY ##. This value is a percent. The **Data Entry Slider** sets the whole number values; the **Up/Down Arrow** buttons set the fractional value. Values of less than 1.00 will decrease the effect of a controller. Values greater than 1.00 will increase the effect of a controller.
- Scroll to RANGE. Here you can select the entire range, or define a key range, and bar/beat to be scaled.
- Press **Enter**•**Yes**. The display reads KEEP=OLD/NEW. Press the **Play** button to audition this event.
- Press **Enter**•**Yes** to complete the command (or **Cancel**•**No** to abort the procedure).

<i>CMD</i>	<b>SHIFT TRACK BY CLOCKS</b>
<i>TRACK</i>	Press Command / Track / 8

This command allows you to shift all note events on a track forward or backward in time. This can be useful for correcting MIDI delay, or creating a “lazy” or “rushed” feel when a track is shifted relative to other tracks.

- Scroll to SHIFT TRACKS BY CLOCKS.
- Press **Enter**•**Yes**. The display reads TRACK=##.
- Scroll to SHIFT AMOUNT=## (Range -96 to +96 clocks).
- Press **Enter**•**Yes**. The display reads KEEP=OLD/NEW.
- Press **Enter**•**Yes** to complete the command (or **Cancel**•**No** to abort the procedure).

## Command/(audio) Track Page

These commands allow you to manipulate Audio Track data.

<i>CMD</i>	<b>COPY AUDIO TRACK</b>
<i>(Audio) TRACK</i>	Press Command /(audio) Track / scroll using the arrow buttons

This command allows the currently selected Audio Track to be copied from the current Sequence or the Song, to any other Audio Track in any sequence, or to the Song, in memory. This will erase all existing Audio Track Events on the DESTINATION Audio Track.

- Select the Audio Track that you want to copy by pressing its **Audio Track** button.
- Press **Enter•Yes** to invoke the Command. The display shows:

```

                                STOP
    CMD                                TRACK
    FROM AUDIO TRACK=A
  
```

- Press **Enter•Yes**. The display shows:

```

                                STOP
    CMD                                TRACK
    TO SEQ=SEQ-SONGNAME
  
```

- Use the Data Entry Controls to select the DESTINATION (where you want the copied Audio Track to reside) Sequence or Song. This defaults to the currently selected sequence or song name.
- Press **Enter•Yes**. The display shows:

```

                                STOP
    CMD                                TRACK
    TO AUDIO TRACK=B
  
```

- Use the **Audio Track** buttons to select the destination Audio Track.
- Press **Enter•Yes**. The display shows:

```

                                STOP
    CMD                                TRACK
    AT BAR=1
  
```

- Use the Data Entry Controls to select the BAR where you want to place the Audio Trigger Event (that will play the AudioSample).

- Press **Enter•Yes**. The display shows:

```

          CMD                                     STOP
                                     TRACK
NO AUDITION - OK?
    
```

- This command does not have any Audition.
- Pressing **Enter•Yes** will execute the Command. If a destination Track in a different Sequence is selected as the target for the COPY, the PREPARING AUDIO TRACKS message will be briefly displayed while the Audio Tracks are cued up for Playback.

<i>CMD</i>	<b>ERASE AUDIO TRACK</b>
<i>(Audio) TRACK</i>	Press Command /(audio) Track / scroll using the arrow buttons

This command will erase all Audio Trigger, Audio-Mix and Audio-Pan events from the currently selected Audio Track.

- Pressing **Enter•Yes** will invoke the Command, revealing the following screens:

```

          CMD                                     STOP
                                     TRACK
AUDIO TRACK=A
    
```

Range: A or B (selected by pressing an **Audio Track** button)

A secondary parameter determines whether or not the command will erase all the RAM and Disk AudioSamples that are triggered by the Audio Trigger events on the Audio Track being erased, or if only the Audio Trigger, Audio-Mix and Audio-Pan events will be erased, leaving the AudioSamples intact:

```

          CMD                                     STOP
                                     TRACK
ERASE=EVENTS + ASMPLS
    
```

Range: EVENTS + ASMPLS, ATRK EVENTS ONLY

- Pressing **Enter•Yes** will execute the Command. This command has no Audition.

<i>CMD</i>	<b>SHIFT AUDIO TRACK</b>
<i>(Audio) TRACK</i>	Press Command /(audio) Track / scroll using the arrow buttons

This command allows all Events on the currently selected Audio Track to be shifted by ±96 clocks.

- Pressing **Enter•Yes** will invoke the Command, revealing the following screens:

```

          CMD                                     STOP
                                     TRACK
AUDIO TRACK=A
    
```

Range: A or B (selected by pressing an **Audio Track** button)

```

CMD                                STOP
                                     TRACK
SHIFT AMOUNT=+0
  
```

Range: -96 to +96 clocks

- Pressing **Enter•Yes** will execute the Command. This command has Audition.

<i>CMD</i>	<b>RENAME AUDIOSAMPLE</b>
(Audio) TRACK	Press Command /(audio) Track / scroll using the arrow buttons

This command allows you to rename any single AudioSample in the current SONG + ALL SEQs (Project) file. If the **Edit/(audio) Track**, `ASMPNAME=*UNDEFINED*`, the **SELECT ASMP FIRST** error message will be displayed.

- Pressing **Enter•Yes** will invoke the Command, revealing the following screen:

```

CMD                                STOP
                                     TRACK
ASMPNAME=ASMP--00000
  
```

This screen allows you to use the Data Entry Controls to change the name of the AudioSample.

### **Caution:**

If you rename a SCSI resident AudioSample, you should immediately save the SONG + ALL SEQs file as well. If you forget to do this, and reload your original SONG + ALL SEQs file later, you will have renamed the file on disk but your original SONG + ALL SEQs file will be looking for the old name, not the new one.

- Pressing **Enter•Yes** from the above screen will execute the Command, renaming the AudioSample.

When renaming a disk AudioSample, the command changes the name of the file on the disk and in the SONG + ALL SEQs (Project) file (which currently resides in the ASR-10's RAM. If you rename a disk AudioSample (using the **Command/(audio) Track**, **RENAME AUDIOSAMPLE** Command) but forget to resave the SONG + ALL SEQs (Project) file before turning the unit off, then the next time you load that SONG + ALL SEQs (Project) file, it will still be referencing the AudioSample by the old name and unfortunately, not find it anywhere. The AudioSample file on disk (which has the new name) is considered "orphaned" since it is not being referenced.

### **To Recover an Orphaned AudioSample**

You can run the **RENAME AUDIOSAMPLE** command again, selecting the AudioSample in the SONG + ALL SEQs (Project) file (the old name) and renaming it to the file on the disk (the new name). The rename command will search for the disk file to rename and if it cannot find it, it will still rename the AudioSample within the current SONG + ALL SEQs (Project) file. Now the SONG + ALL SEQs (Project) file's AudioSample and the disk AudioSample have the same name. You must reselect the sequence and re-prepare it so that the prepare logic will load in the disk information.

When performing the RENAME AUDIOSAMPLE command, make sure that you are renaming the proper AudioSample. Once you've recovered the orphaned AudioSample, be sure to resave the SONG + ALL SEQs file, or you may have to repeat this whole process again.

<i>CMD</i> (Audio) TRACK	<b>AUDIOSAMPLE INFO</b>
Press Command / (audio) Track / scroll using the arrow buttons	

This command provides information about the last AudioSample that was being triggered when the sequencer was last stopped (i.e. the same AudioSample that was last displayed on the Edit/(audio) Track, ASMPLNAME screen).

Pressing **Enter•Yes** will invoke the Command, revealing the following read-only screens.

```

CMD                                     TRACK                                     STOP
ASMPLNAME=ASMPL--00000
    
```

If the AudioSample has not been named, this defaults to "ASMPL—#####" (##### represents the currently selected AudioSample file number).

```

CMD                                     TRACK                                     STOP
ASMPL NUMBER=#####
    
```

```

CMD                                     TRACK                                     STOP
ASMPL RESIDENCY=RAM
    
```

Range: RAM, SCSI

```

CMD                                     TRACK                                     STOP
SIZE=##### BLKS
    
```

This display shows the size in blocks.

```

CMD                                     TRACK                                     STOP
SAMPLE RATE=29.7619 KHZ
    
```

The Sample Rate will be either 29.7619 or 44.1000.

- Pressing **Enter•Yes** from any of the above screens will exit the Command.

<i>CMD</i> (Audio) TRACK	<b>FILTER AUDIO EVENTS</b>
	Press Command / (audio) Track / scroll using the arrow buttons

This command allows you to erase any Mix or Pan events associated with the Audio Tracks.

Range: AUDIO-MIX, AUDIO-PAN

- Pressing **Enter•Yes** will invoke the Command. The display shows:

```

          CMD                                STOP
          TRACK
AUDIO TRACK=A

```

- Use the **Audio Track A** and **B** buttons to select the Audio Track that you want to filter the audio events.
- Press **Enter•Yes**.
- This page allows you to select either the AUDIO-MIX or the AUDIO-PAN events to erase.
- Press **Enter•Yes** to filter the selected track. The display momentarily shows SHUFFLING DATA, then allows you to Audition the newly filtered Audio Track. If there are no events to filter, the display momentarily shows NO DATA ON SOURCE TRACK.
- Select **KEEP=NEW** and press **Enter•Yes** to save the filtered version, or press **Cancel•No** to abort the command.

# Section 14 — Storage

This section covers all data storage functions.

## Disk Storage — Using the Disk Drive to Save and Load Data

The ASR-10's built-in disk drive is used to store all your Instruments, Banks, and Sequencer data, as well as System Exclusive messages from other MIDI devices. The ASR-10 uses a high-density (HD) disk drive, that can store 1600 Kilobytes of data on a Double-Sided High-Density (DSHD) 3.5" micro-floppy disk and 800 Kilobytes of data on a Double-Sided Double-Density (DSDD) 3.5" micro-floppy disk. The disks are enclosed in a protective plastic carrier with an automatic shutter to protect the diskette from physical damage. It is important not to alter this carrier in any way.

The 3.5" disks have a sliding write-protection tab so that you can protect your sounds and sequences against accidental erasure. Sliding the write-protection tab in the lower left corner of the disk so that the window is closed will allow you to store information on the disk. Sliding the tab so that the window is open will protect the disk against being accidentally reformatted or having files deleted. Double-Sided High Density disks can be easily identified because they have an additional window (with no write-protection tab) located on the lower right corner of the disk.

### Double-Sided High-Density (DSHD)

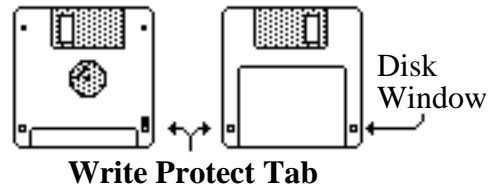

### Double-Sided Double-Density (DSDD)

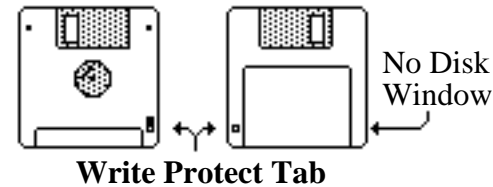

Floppy disks are a magnetic storage medium, and should be treated with the same care you'd give important audio tapes. Just as you would use high quality audio tapes for your important recording needs, we recommend using high quality floppy disks for your ASR-10. You should keep your disks and the disk drive clean and free of dust, dirt, liquids, etc. Never put anything other than a disk in the disk drive. Do not expose disks to extremes of temperature or to strong magnetic fields. Also, never eject a disk while the drive is operating (the disk drive light is on).

## ASR-10 Disk File Types

The ASR-10 disk storage system has been designed to allow maximum flexibility in saving, loading and organizing your instrument and sequence data. Consequently, there are several different types of files that can be saved:

- **INSTRUMENT** — individual ASR-10 instruments can be saved.
- **BANK** — contain "snapshots" of the currently loaded files.
- **SEQUENCE** — contains a single ASR-10 sequence.
- **SONG + ALL SEQs** — contains an entire song along with its related sequences.
- **EFFECT** — contains an effect algorithm that can be loaded to the BANK effect slot.
- **MIDI SYS-EX data** — In addition to the above types of ASR-10 data, you can use the disk drive to save system exclusive data from other MIDI devices. The ASR-10 can serve as the "librarian" for your other MIDI gear. This function is covered at the end of this section.

- **MACROS** — The file structure of the ASR-10 is set up so that each *directory* can hold up to 38 files. If any additional files are needed within the directory, a sub-directory must be created to hold those extra files. When working with a directory/file structure that is several layers deep, it is convenient to have a quick way to get to a sub-directory that is down deep in the structure. MACROS allow you to do that by using direct-dialing in much the same way that direct-dialing is used to access commands and parameters. The SAVE MACRO FILE command (on the Command/System•MIDI page) allows you to save your macros to disk.
- **O.S.** — The computer program that controls the ASR-10 (the *Operating System*, or O.S.) is contained on a disk and is loaded into RAM upon booting. The O.S. also contains the global parameter settings that are saved with the Command/System•MIDI SAVE GLOBAL PARAMETERS command. The disk that came with your ASR-10 contains the current O.S. Operating System upgrades will be available from your Authorized ENSONIQ Dealer as they are released. The COPY O.S. TO DISK command (on the Command/System•MIDI page) allows you to copy the O.S. to a different disk.

### Disk Capacity — Bytes, Blocks, and Files

The instruments, banks, songs, and sequences that the ASR-10 plays are stored on 3.5" micro-floppy disks. The ASR-10 has a high-density (HD) drive, allowing you to use both Double-Sided High-Density and Double-Sided Double-Density disks:

- **Double-Density disks** — can store 800 kilobytes of data, which translates into about 1600 *Blocks*.
- **High-Density disks** — can store 1600 kilobytes of data, which translates into about 3200 *Blocks*.

A Block is a handy unit which the ASR-10 uses to measure internal and disk memory — 1 Block=512 bytes=256 sample words; 2 Blocks=1k bytes; 4 Blocks=1k sample words.

ASR-10 disk files vary in size — how many will fit on a disk depends on the type of disk, the type of formatting, the number of files, and the size of the files.

There are two types of formatting that can be used to format a floppy disk:

- **ENSONIQ** — this format offers the largest amount of free blocks.
- **COMPUTER** — this format has fewer free blocks, because it allows Macintosh™ and IBM™ computers running the appropriate translation software to read the disks.

Disk Type	High -Density	High-Density	Double-Density	Double-Density
Format (Sector Offset)	ENSONIQ (offset 0)	COMPUTER (offset 1)	ENSONIQ (offset 0)	COMPUTER (offset 1)
<b>Kilobytes</b>	1600	1440	800	720
<b>Sample Words</b>	800k	720k	400k	360k
<b>Blocks</b>	3176	2863	1585	1426

There are limits to the number of files on a disk:

- Each disk can hold a *maximum* of 156 files.
- A disk can hold up to 60 files of any one file type, but no more than the total of 156 files of all types will fit on a single disk.



## ASR-10 Disk Functions

### FORMAT FLOPPY DISK — Formatting a Blank Disk

Before it can be used by the ASR-10 to store data, a disk must be formatted. Formatting puts information on the disk which the ASR-10 needs to read and write files. In addition to formatting a blank disk, the format procedure can be used to reformat a disk which has been used with some other device, such as a personal computer or another musical instrument. Note that any data (of whatever type) on a disk will be lost when the disk is formatted by the ASR-10.

To Format a floppy disk:

- Insert a blank, Double-Sided Double-Density or Double-Sided High-Density 3.5" micro-floppy disk into the disk drive, with the label-side facing up, and the metal shutter facing away from you. Make sure the plastic write-protect tab is in the closed position (no light showing through the window).
- Press **Command**, followed by **System•MIDI**.
- Press the **Right Arrow** button repeatedly until the following screen appears:



- Press **Enter•Yes**. The display will read `DISK LABEL=DISK000`. Use the **Data Entry Slider** and the **Arrow** buttons to give the disk a unique name by which you can identify that disk. This is very important, as the ASR-10 will ask you for this disk by name if an instrument or song on the disk is used in a bank. Also, make sure you write the Disk Label name on the outside of each disk after it has been formatted.
- Press **Enter•Yes**. The display will read `FORMAT TYPE=.` Here you select which type of formatting you would like to use to format your floppy disk:

**ENSONIQ** — this standard format allows the ASR-10 to read the disk, and offers the largest amount of free blocks (DSDD disks format to 800k and DSHD disks format to 1600k).

**COMPUTER** — this unique format provides a lower disk capacity, but (having the first sector labelled sector 1) allows Macintosh and IBM computers that are running the appropriate translation software to read the disks.

- After choosing a format type, press **Enter•Yes**.
- The display will read `ERASE AND FORMAT DISK?`
- Press the **Enter•Yes** button to proceed (pressing the **Cancel•No** button will return you to the **Command/System•MIDI** page).
- While the ASR-10 is formatting the disk, the display reads `*FORMATTING*`. The formatting process takes between 80 and 160 seconds, depending on the format and disk type.
- When the formatting is done, the display reads `DISK COMMAND COMPLETED`, and then you are returned to the **Command/System•MIDI** page. The disk is ready to have ASR-10 files stored on it.

FORMAT FLOPPY DISK Messages:

- **DISK DRIVE NOT READY** — No disk in the drive.
- **DISK FORMAT FAILURE -- DISK IS UNUSABLE**. This indicates a defective disk. If you get this message, we advise that you throw out the disk in question. Try again with another disk.
- **DISK WRITE-PROTECTED** — The plastic write-protect tab in the lower-left corner of the disk must be closed (so you can't see through the hole) before anything can be written to the disk. Close the write-protect tab and try again.

### COPY FLOPPY DISK — Making a Backup Copy of a Disk

The COPY FLOPPY DISK function lets you duplicate the contents of one entire disk (the *source disk*) onto another disk (the *destination disk*). This function will only work if both disks are the

same size (**both** High-Density disks or **both** Double-Density disks). It is a good practice to regularly back up your valuable data — including the O.S. disk which came with the ASR-10 — in this way. You can use either blank or formatted disks. During the COPY FLOPPY DISK command, the ASR-10 will ask you if you want to format the blank disk. Make sure the formatted destination disks do not contain any files that you want to keep because they will be erased. It is also a good idea to *write-protect* the source disk, so there's no chance of losing data.

**Note:** This procedure uses the internal memory to temporarily hold the information while copying it between disks. The fewer files you have loaded in the internal memory before you start, the fewer times you will have to swap disks during the copy procedure. You will only have to swap disks if the size of the source disk you are copying is greater than the amount of free internal memory.

To Make a Backup Copy of a Disk:

- Slide open the plastic write-protect tab on the source disk (the original) so that the disk is write-protected (you can see through the hole). This is an extra precaution to safeguard the data.
- Press **Command**, then **System•MIDI**.
- Press the **Right Arrow** button repeatedly until the display shows COPY FLOPPY DISK.
- Press **Enter•Yes**. The display shows INSERT SOURCE DISK (the one you want to copy).
- Insert the source disk, then press **Enter•Yes**.
- The drive will engage and the display will flash READING SOURCE DISK. Once the drive stops, the display will change to show INSERT DEST DISK.
- Insert the destination disk (the one you want to copy to), and then press **Enter•Yes**. If the destination disk is unformatted, the display will ask ERASE AND FORMAT DISK? Press **Enter•Yes** to format the disk. When formatting is complete, the drive will engage and the display will flash WRITING DEST DISK.
- After writing to the destination disk, the display will read VERIFYING DEST DISK. If the copy is complete, then the display will read DISK COMMAND COMPLETED.
- If the size of the source disk you are copying is greater than the amount of free internal memory, the display will change to show INSERT SOURCE DISK again. Repeat the preceding four steps as prompted by the ASR-10 display.

**Note:** When you copy a disk, the Disk Label Name is copied from the source disk to the destination disk.

COPY FLOPPY messages:

- **DISK WRITE-PROTECTED** — When asked for the destination disk you inserted a write-protected disk. The destination disk must have the write-protect tab closed (so you can't see through the hole).
- **DISK IS NOT SOURCE DISK** or **DISK IS NOT DESTINATION DISK** — You put the wrong disk in the drive when prompted for a certain disk. This is not fatal; it doesn't abort the copy procedure. Just insert the requested disk and proceed.

## Loading and Saving ASR-10 Instruments

### Loading an Instrument

You can load up to eight different instruments into the ASR-10 at once (within the limits of memory). First, insert a disk containing one or more instrument files into the disk drive.

- Press **Load**. The LOAD indicator flashes.
- Press **Instrument**. The display might look like this:



When the LOAD indicator is flashing, the ASR-10 is showing you disk files (think of it as a question mark - the ASR-10 is saying “Load the file showing on the display?”). Pressing the **Up/Down Arrow** buttons takes you through the files on the disk. If there are none, the display will read “NO INST OR BANK FILES.”

Whenever a disk file is displayed as above, you can press the **Left** or **Right Arrow** button to see the size of that file in *Blocks* (a Block is 256 samples; 4 Blocks=1K samples). Press the **Left** or **Right Arrow** button again to return to the file name.

- Use the **Data Entry Slider** or the **Up/Down Arrow** buttons to view the various instrument files on the disk. Each file has its own File Number. When an instrument file is showing, the INST indicator is lit. The BANK indicator will light when a bank file is showing.
- Find the instrument you want to load, and press **Enter•Yes**. The display will say PICK INSTRUMENT BUTTON. The ASR-10 is asking in which instrument location you want to load the sound into.
- Press any of the eight **Instrument•Sequence Track** buttons. The ASR-10 will begin immediately loading the instrument into the selected location. The display reads LOADING FILE... and the left red LED *flashes* while the instrument is being loaded.

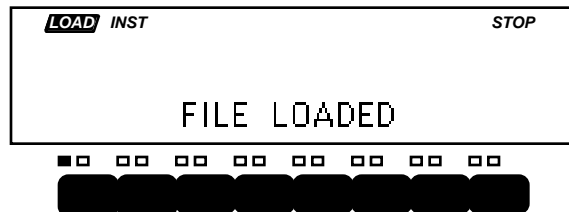

Once the instrument has been loaded, the display briefly shows “FILE LOADED.” The left red LED above the **Instrument•Sequence Track** button stops flashing and remains solidly lit, indicating that there is now an instrument loaded in that location which can be selected by pressing that button.

If you tell the ASR-10 to load an instrument into a location that already has an instrument loaded (left red LED lit), the new instrument will be loaded into that location and the one that was there will be automatically deleted.

### If You Run Out of System Memory

You might have to delete an instrument(s) before loading the new one. If there are already one or more instruments loaded into the ASR-10, there might not be enough free memory to load the new one. In this case, the display will say PICK INST TO DELETE. At this point you can:

- Press any loaded **Instrument•Sequence Track** button. That instrument will be deleted from memory and the new one will be loaded; or,
- Press **Enter•Yes**. The ASR-10 will delete an instrument (or instruments, as needed) for you, starting from the *highest-numbered* one in memory; or,
- Press **Cancel•No**. The load command will be canceled with no harm done.

**Note:** You can continue to select and play existing instruments while the new one loads. No more “down-time” waiting for the next sound to load. With the ASR-10, you can be loading the next sound you need while continuing to play the currently selected sound.

### Saving an Instrument to Disk

After you have created a new ASR-10 instrument, or made changes to an existing instrument, you can save the instrument to a formatted ASR-10 disk with the following steps:

- Insert a formatted disk into the drive. If you don't have a formatted disk, format one before proceeding.
- Press **Command**, then **Instrument**. This puts you on the Command/Instrument page, that contains all the instrument-related commands. Check to make sure that the instrument you want to save is selected. If not, press its **Instrument•Sequence Track** button to select it.
- Press the **Left** or **Right Arrow** button until the display reads SAVE INSTRUMENT (or use this shortcut — after pressing **Command**, double-click on the **Instrument** button).
- Press **Enter•Yes**.
- Edit the Instrument Name (if needed):

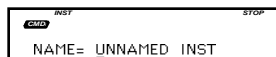

The display shows the current name with a cursor (underline) beneath the first character. If you want to give the instrument a new name, do so at this time. Use the **Data Entry Slider** or the **Up/Down Arrow** buttons to change the underlined character, then press the **Left** or **Right Arrow** button to move the underline. Repeat until the display shows the name you want (if you don't need to rename the instrument, just skip this step).

- Press **Enter•Yes**.  
The display will read SAVING <INST NAME> while the instrument is being saved. Note that you can continue playing the keyboard while the instrument is being saved, and you can select other instruments. You cannot get out of COMMAND mode until the save procedure is done.
- If there is already an instrument file with the same name on the disk, the display will ask DELETE OLD VERSION? Press **Enter•Yes** to save the instrument, replacing the one on the disk. This is for updating instruments to which you have made changes. Or press **Cancel•No** to abort the procedure.
- If there is not enough free space on the disk for the instrument, the display will say NOT ENOUGH DISK SPACE. Save the instrument to another disk (or delete some files from the disk).

## Loading and Saving ASR-10 Banks

### To Load a Bank

- Press **Load**, then **Instrument**.
- Use the **Up/Down Arrow** buttons to view the different files.

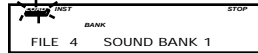

When a bank file is showing, the **BANK** indicator lights on the display along with the **INST** indicator.

- Once a bank file is showing, press **Enter•Yes**. The ASR-10 will begin loading the instruments and the song data. As it loads each instrument the display tells you what it's doing. As soon as any of the instruments are finished loading, you can select that instrument and play while the rest of the bank loads.

At some point in the loading process, you may encounter the following message:



This prompt is informing you that an instrument or song saved as part of the bank is on a different disk than the disk currently in the drive. When this occurs:

- Eject the current disk in the disk drive and replace it with the disk that matches the Disk Label ID requested by the ASR-10 (you are writing these names on your disks, aren't you?).
- Press **Enter•Yes**. The ASR-10 will resume loading until completed, or until the point when it needs another disk.
- When it has finished loading the instruments, the ASR-10 will load the song (if any) and then set up any copied instruments included in the bank.

## Saving the Contents of Memory as a Bank

Saving a bank is like taking a “snapshot” of the contents of the ASR-10 memory. When you later load a bank, the ASR-10 “looks” at that snapshot and tries to recreate what was in memory when the bank was saved. You can use banks to automatically load a new group of instruments and/or a new song.

Banks are valuable for this reason: ASR-10 songs and sequences have no way of knowing which instruments are loaded into various **Instrument • Sequence Track** locations. Suppose, for example, you record a track with a piano instrument, but then load a kazoo sample into the instrument location where the piano was. The track will now play on the kazoo. By using banks you load instruments into their “proper” location. The Bank file stores the following information:

- Which instruments are loaded into each **Instrument • Sequence Track** location
- Which song and its related sequences are loaded into the internal memory
- Up to eight discrete Performance Presets
- The Bank Effect and its parameter settings
- The Edit/Track MIX, PAN, OUT, and EFFECT MOD CONTROL setting for each **Instrument • Sequence Track**

It's easy to save the contents of the ASR-10 memory as a bank. Just remember that any instruments in the internal memory, as well as the song, must be saved separately before they can be saved as a bank.

- Save any instruments in memory to disk using the SAVE INSTRUMENT command on the Command/Instrument page.
- Save the song to disk (if you want a song as part of the bank) using the SAVE SONG + ALL SEQs command on the Command/Seq • Song page.
- Press **Command**, then **Instrument**.
- Press the **Left** or **Right Arrow** button until the display reads SAVE BANK.
- Press **Enter • Yes**. The display shows:

```

  STOP
  BANK NAME = SOUNDBANK 1
  
```

The display shows the current name with a cursor (underline) beneath the first character. If you want to give the bank a new name, do so at this time. Use the **Data Entry Slider** or the **Up/Down Arrow** buttons to change the underlined character, then press the **Left** or **Right Arrow** button to move the underline. Repeat until the display shows the name you want. (If you are updating an existing bank, don't rename the bank; just press **Enter • Yes** and then press **Enter • Yes** once more in response to the question DELETE OLD VERSION?).

- Press **Enter • Yes**.

**Note:** It's not necessary for the instruments and song to be saved on the same disk as the bank. Each instrument, the song, and bank can be saved on separate disks, but make sure the disks are labelled (WRITE DISK LABEL command found on Command/System • MIDI page) so that the bank can locate the information properly.

## Loading and Saving Sequencer Data

There are two ways that ASR-10 Sequencer data can be stored on a disk:

- **SONG File.** A song file contains a song *and* all its related sequences. Loading a song file from disk will completely erase the current contents of the ASR-10 sequencer memory, replacing whatever is there with the song and sequences from the disk file.
- **SINGLE SEQUENCE File.** This type of file contains just one sequence. Loading a single sequence file will *not* erase the sequencer data already in memory — the new sequence simply becomes one more sequence in the internal memory which can be selected or used as a step in a song. There can be up to 80 sequences in memory at once.

### Loading a Song or a Single Sequence from Disk

Both types of sequencer files are accessed from the Load/Seq•Song page.

- Press **Load**, then press **Seq•Song**.  
The LOAD indicator flashes, meaning that the ASR-10 is showing you disk files.
- Press the **Up** or **Down Arrow** button until the file you want to load is showing on the display:



When a SONG file is showing, the SONG indicator lights next to the SEQ indicator.



When a single SEQUENCE file is showing, only the SEQ indicator lights.

- Press **Enter•Yes** to load the sequencer file showing on the display. After you have loaded a song or sequence, it is automatically selected. Just press **Play** to play it.

**Note:** Remember that loading a song or sequence does not ensure that the right instruments are loaded into the proper **Instrument•Sequence Track** locations. Each track of each sequence will play whatever instrument is in that location at the time. The way to make sure everything is in the right place is to save the contents of memory (including the song) as a bank.

### Saving a Single Sequence to Disk

Use the SAVE CURRENT SEQUENCE command to save a single sequence.

- On the Edit/Seq•Song page, select the sequence you want to save.
- Insert a formatted disk into the drive.
- Press **Command**, then press **Seq•Song**.
- Press the **Left** or **Right Arrow** button until the display reads SAVE CURRENT SEQUENCE.
- Press **Enter•Yes**.
- Edit the Sequence Name (if needed):

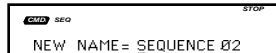

```
EDIT SEQ                                STOP
NEW NAME = SEQUENCE 02
```

The display shows the current name of the sequence, with a cursor (underline) beneath the first character. If you want to give the sequence a new name, do so at this time. Use the **Data Entry Slider** or the **Up/Down Arrow** buttons to change the underlined character, then press the **Left/Right Arrow** buttons to move the underline. Repeat until the display shows the name you want (if you don't need to rename the sequence, just skip this step).

- Press **Enter•Yes**. The display will read SAVING <FILE NAME> while the sequence is being saved.
- If there is already a sequence file with the same name on the disk, the display will ask DELETE OLD VERSION? Press **Enter•Yes** to save the sequence, replacing the one on the disk. Or press **Cancel•No** to abort the procedure.
- If there is not enough free space on the disk, the display will say NOT ENOUGH DISK SPACE. Save the sequence to another disk (or delete some files from the disk).
- If you try to SAVE CURRENT SEQUENCE while the song is selected, the ASR-10 will not execute the command, responding USE SAVE SONG + ALL. Again, make sure the sequence is selected before trying to save it.



## Saving a Song (along with all Sequences) to Disk

Once you have created a song or made changes to an existing one, you can save the song to a formatted ASR-10 disk. In addition to saving the song itself, the SAVE SONG + ALL SEQS command saves all the individual sequences currently in memory (whether they are part of the song or not). To save a song:

- Insert a formatted disk into the drive.
- Press **Command**, then press **Seq • Song**.
- Press the **Left** or **Right Arrow** button until the display reads SAVE SONG + ALL SEQS.
- Press **Enter • Yes**.
- Edit the song name (if needed):



The display shows the current name of the song, with a cursor (underline) beneath the first character. If you want to give the song a new name, do so at this time. Use the **Data Entry Slider** or the **Up/Down Arrow** buttons to change the underlined character, then press the **Left/Right Arrow** buttons to move the underline. Repeat until the display shows the name you want (if you don't need to rename the song, just skip this step).

- Press **Enter • Yes**. The display will read SAVING <SONG NAME> while the song is being saved.
- If there is already a song file with the same name on the disk, the display will ask DELETE OLD VERSION? Press **Enter • Yes** to save the song, replacing the one on the disk. This is for updating songs to which you have made changes. Or press **Cancel • No** to abort the procedure.
- If there is not enough free space on the disk, the display will say NOT ENOUGH DISK SPACE. Save the song to another disk (or delete some files from the disk).
- Note that the song and all sequences in memory are saved as one file. You cannot extract a single sequence from a song file and load it separately. If you want access to a sequence individually, you must first load the song into the internal memory, and then save the individual sequence using the SAVE CURRENT SEQUENCE command.

### **Caution:**

Saving a SONG + ALL SEQS (Project) file to disk will take longer than in previous O.S. versions. The SHUFFLING DATA message will be displayed before saving, perhaps for several minutes. This happens because the ASR-10 must manage the Audio Track data that is stored with the SONG + ALL SEQS (project) file. The more AudioSamples you have recorded, the longer it will take.

## Loading and Saving ASR-10 Effects

### Loading an Effect File

You can load an effect from disk into the internal memory of the ASR-10. The effect will load into the Bank effect location, replacing whatever effect was there previously.

First, insert a disk containing one or more effect files into the disk drive.

- Press **Load**. The LOAD indicator flashes.
- Press **Effects**. The display looks like this:



When the LOAD indicator is flashing, the ASR-10 is showing you disk files. Pressing the **Up/Down Arrow** buttons takes you through the effect files on disk. If there are none, the display will read NO EFFECT FILES.

Whenever a disk file is displayed as above, you can press the **Left** or **Right Arrow** button to see the size of that file in *Blocks* (a Block is 256 samples; 4 Blocks=1K samples). Press the **Left** or **Right Arrow** button again to return to the file name.

- Use the **Data Entry Slider** or the **Up/Down Arrow** buttons to view the various effect files on the disk. Each file has its own File Number.
- Find the effect you want to load, and press **Enter•Yes**. The ASR-10 will load that effect into the BANK effect slot. When finished, the display will read DISK COMMAND COMPLETED.

### Saving an Effect to Disk

Use the SAVE BANK EFFECT command to save an effect to disk. If you wish to save either a ROM effect or an INST (Instrument) effect as a separate effects file, you must first copy the ROM Command/Effects page (see *Section 6 — EffectsParameters*) and then save it.

- Insert a formatted disk into the drive.
- Press **Command**, then press **Effect**.
- Press the **Left** or **Right Arrow** button until the display reads SAVE EFFECT.
- Press **Enter•Yes**.
- Edit the effect name (if necessary):

The display shows the current name of the effect, with a cursor (underline) beneath the first character. If you want to give the effect a new name, do so at this time. Use the **Data Entry Slider** or the **Up/Down Arrow** buttons to change the underlined character, then press the **Left/Right Arrow** buttons to move the underline. Repeat until the display shows the name you want. (If you don't need to rename the effect, just skip this step.)

- Press **Enter•Yes**. The display will read SAVING <FILE NAME> while the effect is being saved.
- If there is already an effect file with the same name on the disk, the display will ask DELETE OLD VERSION? Press **Enter•Yes** to save the effect, replacing the one on the disk. Or press **Cancel•No** to abort the procedure.
- If there is not enough free space on the disk, the display will show NOT ENOUGH DISK SPACE. Save the effect to another disk (or delete some files from the disk).

### **A Note About Saving and Loading from a SCSI Storage Device**

The preceding discussion has dealt with saving and loading ASR-10 files using the built-in 3.5 inch floppy disk drive. You can also use a SCSI storage device (through the optional *SP-3 SCSI kit*) to store instruments, banks, and sequence files. Much of the saving and loading procedure is similar to using the floppy disk drive. However, if you are using a SCSI storage device, please refer to the manual that came with the storage device, and the manual that came with the *SP-3 SCSI kit* for complete details.

### **Deleting a File from Disk**

Deleting of disk files is done from Load mode. To delete (erase) a file from a disk:

- Press **Load**, followed by the page button (**Instrument**, **Seq**•**Song**, **System**•**MIDI**, or **Effects**) for the type of file you want to delete.
- Press the **Up** or **Down Arrow** button until the file you want to delete is showing on the display.
- While holding down the **Load** button, press **Cancel**•**No**. The display will ask **DELETE <FILE NAME>?**
- Press **Enter**•**Yes**. Press **Cancel**•**No** to abort this procedure.

## Audio Track Storage

### Saving

#### Where is Everything Stored?

- Audio Track recording data can only be saved using **Command/Seq•Song**, SAVE SONG + ALL SEQS. The SAVE SONG + ALL SEQS (also known as the Project) file stores all of the information about what AudioSamples are triggered by each Audio Track.
- Audio Track recording data *cannot* be saved with **Command/Seq•Song**, SAVE CURRENT SEQUENCE.
- RAMTrack AudioSamples are stored in the ASR-10 internal RAM Memory.
- RAMTrack AudioSamples can only be saved using the **Command/Seq•Song**, SAVE SONG + ALL SEQS Command.
- DiskTrack AudioSamples are saved to the connected SCSI storage device as you record Audio Tracks.
- The Audio Trigger events that play the DiskTrack AudioSamples are saved using the **Command/Seq•Song**, SAVE SONG + ALL SEQS Command.
- Temporary Record files are the area on the selected REC SCSI DRIVE that SCSI AudioSamples will be recorded into. They are stored in file 38, a directory called AUDIO TRACKS, on the selected REC SCSI DRIVE. This directory is created when you configure Audio Tracks for ATRK PLAY/REC=SCSI. The two Temporary Record Files are named TEMPORARY000 and TEMPORARY001, for Audio Tracks A and B respectively, and appear as Instrument files under **Load/Instrument** when you are in the AUDIO TRACKS directory. REC FILE=CURRENT BLKS uses any available space within the current Temporary Record File on the selected SCSI REC DRIVE. If the Temporary file has a size of 0 Blocks or does not exist, you will get a NOT ENOUGH DISK SPACE error message (i.e. there's not enough disk space in the Temporary Record File). The ASR-10 will be reconfigured for REC SCSI DRIVE=NONE.

#### Using the SAVE SONG + ALL SEQS Command

Once you have created a song or made changes to an existing one, you can save the song to a formatted ASR-10 disk. In addition to saving the song itself, the SAVE SONG + ALL SEQS command saves all the individual sequences currently in memory (whether they are part of the song or not). Audio Track recording data is also stored with the SONG + ALL SEQS file type. Because the SONG + ALL SEQS file saves your Audio Track recording data, it is sometimes referred to as the *project file*. Note that a SONG + ALL SEQS file that is saved after a large amount of RAMTrack data has been recorded will increase in size significantly, and may need to be saved across multiple disks. Be prepared with a few extra floppy disks for this task. To save a song:

1. Insert a formatted disk into the drive.
2. Press **Command**, then press **Seq•Song**.
3. Press the **Left** or **Right Arrow** button until the display reads:

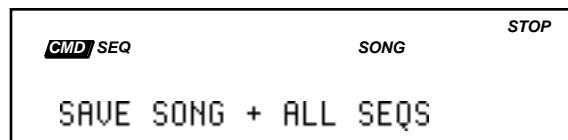

4. Press **Enter•Yes**.

5. Edit the song name (if needed):

```

CMD SEQ                SONG                STOP
NEW NAME=ATRK TUT SNG
  
```

The display shows the current name of the song, with a cursor (underline) beneath the first character. If you want to give the song a new name, use the Data Entry Controls to change the name, (if you don't need to rename the song, just skip this step).

6. Press **Enter**•**Yes**.

The display will flash SHUFFLING DATA as the ASR-10 prepares to save the file to disk.

```

CMD SEQ                SONG                STOP
SHUFFLING DATA
  
```

### Caution:

Saving a SONG + ALL SEQS (Project) file to disk will take longer than in previous O.S. versions. The SHUFFLING DATA message will be displayed before saving, perhaps for several minutes. This happens because the ASR-10 must manage the Audio Track data that is stored with the SONG + ALL SEQS (Project) file. The more AudioSamples you have recorded, the longer it will take.

7. If the SONG + ALL SEQS file will be saving RAMTracks, the display will usually ask:

```

CMD SEQ                SONG                STOP
USE MULTIPLE DISKS?
  
```

8. Press **Enter**•**Yes**.

The display shows SAVING <SONG NAME> while the song is being saved.

- If there is already a song file with the same name on the disk, the display will ask DELETE OLD VERSION? Press **Enter**•**Yes** to save the song, replacing the one on the disk. This is for updating songs to which you have made changes. Or press **Cancel**•**No** to abort the procedure.
- If there is not enough free space on the disk, the display will show:

```

CMD SEQ                SONG                STOP
INSERT DISK-HIT ENTER
  
```

At this point, press the **Eject** button on the disk drive, remove the disk, insert the next ASR-10 formatted disk into the drive, and press **Enter**•**Yes**. You may need to repeat this step several times, depending on the size and amount of the RAMTracks.

9. When the SONG + ALL SEQS file is finished being saved, the display will show COMMAND COMPLETED, then return to the SAVE SONG + ALL SEQS command page.

### About Saving the Bank

Use the SAVE BANK command to save the current Bank. Banks provide a way to load a whole group of Instruments, song and sequences, and Audio Track recording data into the ASR-10 with a few button presses. When you save a Bank to disk, it is like taking a “snapshot” of the contents of the ASR-10 internal memory. The Bank file stores the following information:

- Which Instrument files are loaded into each **Instrument•Sequence Track** location.
- Which SONG + ALL SEQS file is loaded into the internal memory. This includes all Audio Track recording data.
- Up to eight discrete Performance Presets.
- The Bank Effect and its parameter settings.
- The **Edit/(seq) Track MIX, PAN, OUT, and EFFECT MOD CONTROL** setting for each **Instrument•Sequence Track**.

### Saving the Bank:

1. Insert one of your own ASR-10 formatted disks (you should not save any of your own files to the Version 2 O.S. disk.)
2. Press **Command**, then **Instrument**, and use the Data Entry Controls to select the SAVE BANK command.
3. Press **Enter•Yes**. The display shows:

```

INST                                STOP
CMD                                SONG
BANK NAME=ATRK TUT BNK

```

The display shows the current Bank name with a cursor (underline) beneath the first character. If you want to rename the Bank, use the **Data Entry Controls**. If you are updating an existing Bank, and you didn't rename the Bank, pressing **Enter•Yes** will show the following screen:

```

INST                                STOP
CMD                                SONG
DELETE OLD VERSION?

```

4. Press **Enter•Yes**. The display shows SHUFFLING DATA, then COMMAND COMPLETED, and returns to the SAVE BANK command page.

**Note:** It's not necessary for the Instrument files and SONG + ALL SEQS file to be saved on the same disk as the Bank. Each file can be saved on separate disks, but make sure the disks are labeled with a *unique* disk label (see the WRITE DISK LABEL command found on the **Command/System•MIDI** page) so that the Bank knows which disk the files are saved on, and can locate the information properly.

### Backing Up SCSI Storage Devices containing DiskTracks:

- You can use the **Command/System•MIDI, COPY SCSI DRIVE** command to make a backup copy to the same size/type SCSI storage device.
- **BACKUP/RESTORE** will not backup AudioSample files. You will get an Error Message: **CANT BACKUP <AudioSample name>** is displayed whenever an AudioSample file is encountered, but **BACKUP/RESTORE** will continue to back up other data.

**Loading:****Loading Foreign Sequences into the current SONG + ALL SEQs (Project) file**

A Foreign Sequence is a sequence that has had data recorded on its Audio Tracks, within the context of another SONG + ALL SEQs (Project) file.

**Caution:**

We strongly recommend against loading Foreign Sequence files into the current SONG + ALL SEQs (also known as the Project) file. AudioSample ID numbers are Project-specific, and the same ID number might be used in two different SONG + ALL SEQs (Project) files. Loading a Foreign Sequence can result in the Audio Trigger Events on the Foreign Sequence's Audio Tracks triggering like-numbered, but incorrect, AudioSamples in the current SONG + ALL SEQs (Project) file. As a result, Foreign Sequences cannot be imported cleanly into the current SONG + ALL SEQs (Project) file. You should only load single SEQUENCE files that have data recorded on their Audio Tracks back into the same SONG + ALL SEQs (Project) file in which they were created.

**Loading Multi-Disk Song Files**

Because a Song file may contain Audio Track data, it might need to be loaded from several floppy disks. You will be prompted for the required disks by name. Here's how to load a Multi-disk Song file:

1. Press **Load**, then **Seq•Song**.
2. Use the **Up/Down Arrow** buttons to locate the Song file.:



When a song is selected, the SONG indicator lights next to the SEQ indicator. If the song is saved across multiple disks, the bottom right corner of the display will show the number of the disk in the multi-disk song file.

3. Press **Enter•Yes** to load the Song file showing on the display. The display shows **LOADING <Song-name>**, then asks for the next disk in the multi-disk song file:

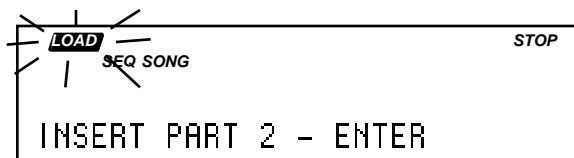

4. Press the **Eject** button on the disk drive, remove the disk, insert the next ASR-10 formatted disk into the drive, and press **Enter•Yes**. You may need to repeat this step several times, depending on the size of the SONG + ALL SEQs (Project) file.
5. When the SONG + ALL SEQs file is finished being loaded, the display will show **FILE LOADED** and the song will be automatically selected.

**Deleting:****To Delete a RAM AudioSample:**

1. Select the appropriate Audio Track by pressing its button.
2. Press the **Command** button.
3. Press the **Track** button.
4. Using the **Left** and **Right Arrow** buttons, scroll until the display shows DELETE AUDIOSAMPLE. The DELETE AUDIOSAMPLE command will delete any single AudioSample in the current SONG + ALL SEQs (Project) file. This command will *not* delete the Audio Trigger Events that may have triggered the AudioSample that was deleted.

```

CMD                                STOP
                                TRACK
DELETE AUDIOSAMPLE

```

5. Pressing **Enter•Yes** will invoke the command, revealing the following screen:

```

CMD                                STOP
                                TRACK
ASMPLNAME=ASMPL--XXXXXX

```

6. This display shows the AudioSample name. Press **Enter•Yes**:

```

CMD                                STOP
                                TRACK
DELETE ASMPL--XXXXXX ?

```

7. This display asks if you are sure you want to delete the named AudioSample. Pressing **Enter•Yes** will execute the command. The “PREPARING AUDIO TRACKS” message will be briefly displayed while the Audio Tracks are cued up for Playback.

**To Delete a SCSI AudioSample:**

There are two ways to delete a Disk AudioSample:

- Run the DELETE AUDIOSAMPLE command (as explained above). This is the recommended way to delete AudioSamples from DiskTracks, or
- Select the AudioSample on the SCSI storage device and delete the file manually:
  1. Press **Load**, then **System•MIDI**.
  2. Enter the file 38 AUDIO TRACKS directory by pressing **Enter•Yes**. This is where all DiskTrack AudioSamples reside.
  3. Press **Load**, then **Instrument**.
  4. Select the ASMPL—##### files that you want to delete using the Data Entry Controls.
  5. Press **Enter•Yes** while holding down the **Load** button.

This is the way to delete “orphaned” disk AudioSamples. For example, when you’ve recorded a Disk AudioSample, but didn’t save the SONG + ALL SEQs (Project) file before turning the ASR-10 off, AudioSamples can become “orphaned,” because the ASR-10 doesn’t know that they are part of a Project.



## MIDI System Exclusive Recorder

### What is System Exclusive Data?

Some MIDI information—such as key events, controllers, program changes, etc. — is understood by virtually all MIDI devices, regardless of the manufacturer. The common ability to send and receive these messages is what allows you to play any MIDI device from any other, to change programs and volume remotely, to start and stop sequencers and drum machines together, and the many other performance miracles we have come to expect from MIDI.

There are other messages which each manufacturer has reserved for communicating specific information with a specific machine (or family of machines). These machine-specific messages are called *System Exclusive* (or *Sys-Ex*) messages, since they are meant to be recognized only by a particular device and ignored by all others (i.e. they are exclusive to a particular system).

### System Exclusive Storage

It is not strictly necessary, however, for the receiving system to understand the data it receives, if the purpose is to store it for later reloading into the original system (just as it's not necessary for a file cabinet to understand the pieces of paper you file there). The ASR-10 can receive any MIDI System Exclusive message (up to 2 Megabytes standard/16 Megabytes with fully expanded memory) and save it to disk without having the slightest notion what it means or what type of device it came from. When you want to send the data back to the original device, you just load the data from disk back into the ASR-10, which will then retransmit the message exactly as it was received.

**Note:** System Exclusive messages cannot be stored across multiple floppy disks. System Exclusive dumps larger than 1600k can only be saved to a SCSI Storage Device.

Here are some examples of the kinds of information that the ASR-10 can store in this way:

- The program (patch) memory of virtually any MIDI synthesizer.
- The pattern memory a drum machine.
- The sequence memory of a MIDI sequencer.
- The preset memory of any MIDI reverb or other effects device which can send and receive it.

In short, any MIDI data (within memory limits) that can be transmitted from one device to another, can be received and stored by the ASR-10. With the ASR-10 at the heart of your system you now have disk storage for the data in all of your MIDI instruments.

### Saving Sys-Ex Data Uses the Internal Memory

The ASR-10 uses the RAM (Random Access Memory) that is normally devoted to instruments, banks, and the sequencer to “buffer” incoming System Exclusive messages before saving them to disk. A buffer is an area of memory where data is held temporarily. When the ASR-10 receives a System Exclusive data dump, it stores it in the internal memory until you save the data to disk. As a result the contents of the ASR-10 internal memory is erased before the MIDI Sys-Ex recorder can be used.

#### Important:

You must save all instrument, bank, and sequencer memory before using the MIDI Sys-Ex recorder to receive data.

Loading Sys-Ex data from disk to an external device will not necessarily clear the internal memory. If there is enough unused sequencer memory to load and transmit the Sys-Ex message, the memory will not be affected. If there is not enough memory, you will be prompted to delete instruments until enough memory is available.

### Saving System Exclusive Data from an External Device to Disk

Using the ASR-10's disk drive for storing data from external devices is a three-step process:

- 1) first get the ASR-10 ready to receive the data via MIDI;
- 2) next, send the data from the external device to the ASR-10; and finally
- 3) save the data to an ASR-10 floppy disk.

To save System Exclusive data from an external MIDI device:

- Connect the MIDI Out of the sending device to the MIDI In of the ASR-10.
- Insert a formatted 3.5" disk into the ASR-10 disk drive.
- Press **Command**, then **System**•**MIDI**.
- Press the **Right Arrow** button repeatedly until the display reads MIDI SYS-EX RECORDER.
- Press **Enter**•**Yes**. The display shows the prompt MUST ERASE MEMORY OK? to warn you that any instruments, banks, sequences, and songs currently in memory will be lost. It's not too late, however, to quit and preserve the internal memory intact. Pressing **Cancel**•**No** at this point will return you to the Command/System•MIDI page without erasing the internal memory, allowing you to save it to disk before proceeding.
- Press **Enter**•**Yes**. The display shows WAITING...
- From the external MIDI device, transmit the System Exclusive data. The display will flash RECEIVING... while the data is being sent.
- When the full message has been received, the display will read CANCEL=QUIT ENTER=SAVE to indicate that a complete message was recorded.
- Once you have successfully received the Sys-Ex message (or messages), press the **Enter**•**Yes** button to begin the process of saving the MIDI data to disk. The following display appears:

A screenshot of the ASR-10's LCD display. At the top, it shows 'COMMAND SYSTEM'. Below that, the text 'FILENAME=SYS-EX FILE' is displayed, with the characters 'SYS-EX' underlined. The display is enclosed in a rectangular border.

- Name the file with a 12-character name of your choice using the **Data Entry Slider** or the **Up/Down Arrow** buttons to change the underlined character, and the **Left/Right Arrow** buttons to move the cursor. Repeat until the display shows the name you want.
- Press **Enter**•**Yes**. The display reads SAVING <FILENAME> while the data is being saved. Or press **Cancel**•**No** to cancel the procedure for any reason.
- If there is a Sys-Ex file with the same name already on the disk, the ASR-10 will ask DELETE OLD VERSION? Press **Enter**•**Yes** to save the file, replacing the one on the disk. This is for updating files to which you have made changes. Or press **Cancel**•**No** to abort the procedure.
- After the file is saved, the ASR-10 returns to the FILENAME=<FILENAME> screen, so that you can save the a backup copy of the data to a different disk if you wish. Press **Cancel**•**No** (or any other front panel button) to exit.

## System Exclusive Messages

If during the reception of Sys-Ex data the ASR-10 display reads STATUS=INCOMPLETE, this means it did not receive an “End Of Exclusive” after the System Exclusive message. This would indicate that external device did not transmit a complete message for some reason. Press **Cancel•No** and try again.

If the ASR-10 display reads STATUS=MEMORY FULL, this means it ran out of memory with which to “buffer” the incoming data. After receiving the Memory Full message you can still save the file, but it is almost certain that the last Sys-Ex message received is incomplete and will not be able to be received successfully when retransmitted.

## Loading System Exclusive Data from Disk to an External Device

After you have saved a System Exclusive message from an external MIDI instrument, getting the data back to the original instrument involves three steps:

- 1) First prepare the receiving instrument(s) to receive System Exclusive messages via MIDI;
- 2) next, load the data from the ASR-10 disk drive into memory; and then
- 3) send the data to the remote instrument(s) from the ASR-10.

To Load (and Transmit) a System Exclusive file from disk:

- Connect the MIDI Out of the ASR-10 to the MIDI In of the receiving device(s).
- Enable the receiving instrument(s) to receive System Exclusive messages. Many devices have a switch or a parameter which enables or disables reception of System Exclusive messages. Consult the manual for each particular device for details.
- Insert the disk containing the Sys-Ex data into the disk drive.
- Press **Load**, then **System•MIDI**.
- Use the **Up/Down Arrow** buttons to scroll through the files.
- Press **Enter•Yes**. **LOADING <FILE NAME>** will appear on the screen as the ASR-10 loads the Sys-Ex data from its disk drive into internal memory. When completed, the display will look like this:

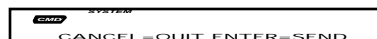

- Press **Enter•Yes** to send the data. The display will flash **SENDING DATA...** When completed, the display will return to the **QUIT/SEND** screen.
- Check the receiving instrument(s) to see that the data was received correctly. If it wasn't, make sure that:
  - ☛ the MIDI connections are correct (ASR-10 MIDI Out should be connected to the receiving device's MIDI In),
  - ☛ the receiving device is enabled to receive System Exclusive messages,
  - ☛ the receiving device is set to the same base MIDI channel as when the data was initially sent to the ASR-10.

If all of this checks out, then press **Enter•Yes** again, and the data will be transmitted again. You can keep repeating this until the data has been successfully received by the remote device(s).

- Once the data has been successfully transmitted, press **Cancel•No**.

## ASR-10 Disk Messages

### WARNINGS

Warnings are displayed for one second and indicate either successful completion or non-fatal error conditions encountered during a disk operation.

- **DISK COMMAND COMPLETED** — indicates that the disk operation was completed successfully.
- **DISK WRITE-PROTECTED** — appears during **SAVE** or **DELETE** operations if the diskette is write-protected.
- **DISK HAS BEEN CHANGED** — appears when you begin to **LOAD**, **SAVE** or **DELETE** when the disk in the drive has been changed since the last time the ASR-10 loaded a disk directory.
- **DISK DRIVE NOT READY** — usually indicates that there is no diskette in the drive, although it can indicate a hardware problem if it persists.
- **NOT ENOUGH DISK SPACE** — indicates that there are not enough available sectors on diskette or hard drive to save the file.
- **FILE DOES NOT EXIST** — appears when you try to **LOAD** or **DELETE** a file when the display reads **FILE=NO <FILE TYPE>**.
- **NO SYS-EX DATA TO SAVE** — indicates that there is no data in the Sys-Ex Recorder to save.
- **FILE TOO LARGE TO LOAD** — indicates that the sequence data in the disk file will not fit into the free memory. Delete sequences or songs to make some memory available. If that does not work, the file may have been saved from a system with more memory installed.

### ERROR MESSAGES

Error messages are always accompanied by the **PRESS ANY BUTTON TO CONTINUE...** prompt, and remain on the screen until any button is pressed. These messages indicate serious error conditions which interrupted the disk operation. These errors may have prevented the correct saving or loading of the data in the file(s).

- **DISK DRIVE NOT RESPONDING** — indicates either that there is no diskette in the drive or that there are hardware problems.
- **DISK NOT FORMATTED** — the disk format was not recognized, and the disk is either blank or formatted for some other system.
- **NOT ASR-10 DISK** — the disk format was recognized, but the disk does not contain ASR-10 data.
- **DISK ERROR - WRITE VERIFY** — during a **SAVE** operation, the data written could not be verified. Probably indicates a bad disk sector. The file may be unusable.
- **DISK ERROR - LOST DATA** — during a disk read operation, the system missed data coming from the disk. Probably indicates a hardware problem. The file may be unusable.

- **FILE OPERATION ERROR** — one of a number of possible fatal errors occurred during a disk operation. Probably caused by a low-level hardware or software error, although the disk may be bad.
- **DISK ERROR - BAD DATA** — during a file operation, the CRC (error checking code) of the data block was incorrect. Probably indicates a bad disk sector. The file may be unusable.
- **DISK ERROR - BAD DISK O.S.** — during a file operation, the CRC of the Disk OS Program Control Block was incorrect. Probably indicates a bad disk sector. The disk may be unusable.
- **DISK ERROR - BAD DIRECTORY**— during a file operation, the CRC of the Directory blocks was incorrect. Probably indicates a bad disk sector. The disk may be unusable.
- **DISK ERROR - BAD FAT** — during a file operation, the CRC of the FAT (File Allocation Table) block was incorrect. Probably indicates a bad disk sector. The disk may be unusable.
- **DISK ERROR - BAD DEVICE ID** — during a file operation, the CRC of the Device ID block was incorrect. Probably indicates a bad disk sector. The disk may be unusable.
- **FORMAT FAILED - BAD DISK** — during formatting, a bad disk sector was detected. The disk may be defective, and should not be used.
- **O.S. NOT ON DISK** — the system was unable to LOAD the O.S. file. The file may be unusable.
- **DISK COPY NOT COMPLETED** — appears if **Cancel**•**No** is pressed during the Disk Copy procedure.

# Section 15 — Sampling Applications

## Resampling through the EQ Effect — Using Equalization

Often a sound contains some overtones or harmonics which sound normal on one note but unnatural when transposed over a range on the keyboard. Or it might be necessary, when trying to match up the different samples in a multisampled sound, to apply some drastic EQ to one or more of those samples. This is why the single most valuable tool for shaping a sampled sound probably is a good equalizer.

The ASR-10 offers an excellent parametric EQ within its ROM effects that allow you to equalize the signal and resample the processed signal back into the ASR-10. Here's a little trick for finding the proper EQ settings:

## Record a Dry Sample

The first step is to sample the signal source flat, without any EQ or other processing:

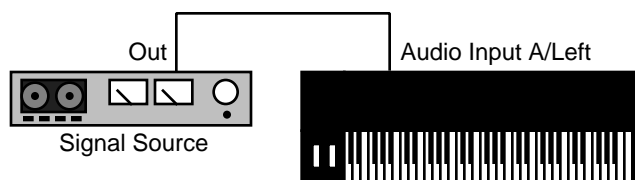

- To do this, press the **FX Select • FX Bypass** button and set it to **FX=OFF 23 VOICE 44K** for the best frequency response (remember that this is setting your sampling rate for sampling).
- Connect the sound source to the Left (and Right for stereo) Audio Input jack on the rear panel of the ASR-10.
- The rear panel Mic/Line switch is used to set the ASR-10's Audio Input to accept either a *line-level* signal (such as that from a mixer, guitar, or a synthesizer) when in the down position, or a *mic-level* signal (from a microphone) when in the up position.
- Press the **Sample • Source Select** button. The display shows:

```
REC SRC=INPUTDRY LEFT
```

REC SRC= INPUTDRY LEFT is the default, allowing you to sample a dry signal connected to the Left Audio Input (in mono).

**Note:** If you want to sample in stereo (for instance, when sampling a stereo synthesizer), press the left **Audio Track** button, and while holding it down, press the right **Audio Track** button (or press the **Up Arrow** button twice) to select L+R. The display will reflect the Audio Track status.

For additional information about Selecting, Enabling, and Disabling Audio Tracks, see *Section 12 — Sequencer/Audio Track Concepts*.

Because we want to record a dry unprocessed signal, leave the Record Source set to INPUTDRY.

- Press the left **Audio Track** button to hear the input source (red LED lit).
- Press an unused (no left red LED lit) **Instrument•Sequence Track** button. The ASR-10 goes into Level-Detect (or VU) mode:

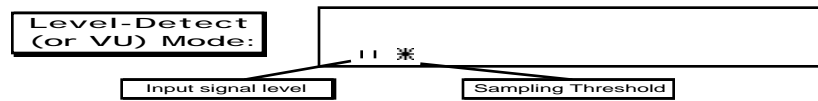

Once you have adjusted the input signal level:

- Press **Enter•Yes** or press the left foot switch to initiate sampling. The display will show “WAITING...” until the threshold is exceeded. The AMP indicator will light if the Input Source clips. During sampling, the display shows:

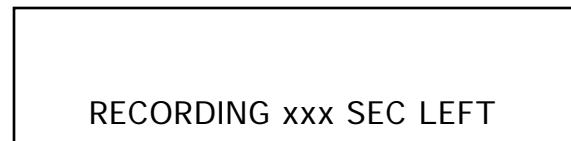

The xxx value (range 000 to 999) will count down in real time when sampling. Press any button to stop sampling. Remember that if the sampling threshold (the star) is set higher than the input signal level (the vertical bars), the ASR-10 will not begin sampling until the input signal crosses the threshold. Pressing **Cancel•No** while the sampling screen reads WAITING will abort sampling, and the ASR-10 will return to Level-Detect mode.

- Play the sound to be sampled: play the guitar, synth, start the recording, or speak/sing into the microphone.
- Press **Cancel•No** or press the left foot switch to stop sampling. If you don't stop it by pressing **Cancel•No** or the left foot switch, the ASR-10 will continue sampling until it has used up all the available memory.

**Note:** In order to use the foot switch to start and stop sampling, the LEFT FOOT SW parameter on the Edit/System•MIDI page must be set to LEFT FOOT SW= SAMPL YES.

- After you have stopped sampling (or the memory is full) the display flashes PLAY ROOT KEY OR ENTER. The Root Key is the note on the ASR-10 keyboard from which the sample will play back at “unity” (the same pitch as the original input signal). Whichever key you press in response to the PLAY ROOT KEY OR ENTER prompt is the key that will play back exactly what you sampled.

**Tip:** You can also press the **Enter•Yes** button in response to the PLAY ROOT KEY OR ENTER prompt. This will set the root key of the new WaveSample to the same note assigned to the ENTER PLAYS KEY parameter, and allows you to record samples using your ASR-10 without playing the keys. Remember, you can assign different WaveSample ranges and change the pitch using the Edit/Instrument parameters.

## Normalizing Gain

After you've recorded a satisfactory sample, you should then perform the Command/Amp NORMALIZE GAIN command, to optimize use of the full dynamic range of the ASR-10. To do this:

- Press **Command**, then **Amp** and scroll until the display reads NORMALIZE GAIN.
- Press **Enter•Yes** to invoke the command. The display will read DATA BEING PROCESSED, followed by COMMAND COMPLETED.

## Setting up the Parametric EQ Effect

Play the sample on various notes, listening to the overall tonal balance — does it need some added highs, or perhaps a little less midrange, etc. Listen particularly for frequencies that seem to stand out unnaturally when the sound is transposed.

- Press the **FX Select•FX Bypass** button, and use the **Data Entry Slider** or the **Arrow** buttons to select FX= ROM-49 PARAM EQ. The display shows:

```

  CMD              AMP              STOP
  FX=ROM-49 PARAM EQ
  
```

- Press **Edit** followed by the **Effects** page button. The display shows the VAR= xxx screen. Play the ASR-10 at the root key of the new sample (it's very important that you play the root key during this process so that you'll be equalizing exactly the pitch you sampled). While playing the root key, adjust the PARAM EQ effect parameters (using the **Left/Right Arrow** buttons to select the parameters, and the **Data Entry Slider** or the **Up/Down Arrow** buttons to change the values), zeroing in on the problem areas and cutting or boosting those frequencies, until the sample sounds just the way you want (for a complete description of the Parametric EQ parameters, see *Section 6 — Effect Parameters*).

## Resampling with Effect

- Without changing any of the settings on the PARAM EQ effect, press the **Sample•Source Select** button. The display reads REC SRC= INPUTDRY LEFT.
- LEFT (underlined) is the default, allowing you to resample the LEFT channel of the Main Output in mono.

**Note:** If you want to resample in stereo (for instance, when resampling with an effect that has stereo movement, like EQ+TREM+DDL), press the left **Audio Track** button, and while holding it down, press the right **Audio Track** button (or press the **Up Arrow** button twice) to select L+R. The display will reflect the Audio Track status.

- Press the **Right Arrow** button once to select INPUTDRY (underlined).
- Press the **Up Arrow** button twice to select MAIN-OUT. For the optimal signal-to-noise ratio, the Volume Slider should be at maximum (all the way up) when sampling the MAIN-OUT. The display looks like this:

```

  REC SRC=MAIN-OUT LEFT
  
```



With this set-up, you are sending the processed main output signal *back into* the ASR-10. In this routing, the processed WaveSample is theoretically sent out the Main Output of the ASR-10 and back into the Audio Input to be resampled (much like a studio effects loop).

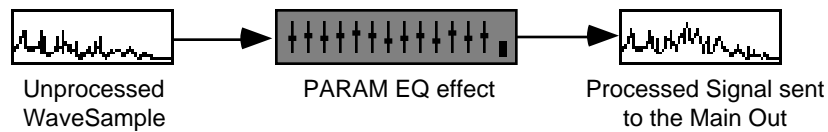

- Press an unused **Instrument • Sequence Track** button. This puts you back into Level-Detect (or VU) mode.
- Press **Enter • Yes** and play the processed WaveSample to initiate sampling (as described earlier).

The EQ curve you set up in the previous step is now “built into” the sample, and it should sound just as it did when you were playing it through the PARAM EQ. To verify this, press the **FX Select • FX Bypass** button and scroll down to **FX= OFF 31 VOICE AT 30K**. You should hear the WaveSample with the EQ curve built into it.

If you find that you have boosted or cut any given frequency too much, just change the EQ settings slightly and sample the sound again. With a little practice you will be able to identify quickly problem frequencies and EQ them out using this method.

**Tip:** After sampling the MAIN OUT, the Edit/Amp BOOST parameter is automatically set to ON in order to match the level between the original WaveSample and the resampled WaveSample. As a final step, after you're happy with the resampled results, you can further optimize the WaveSample by setting the Edit/Amp BOOST parameter to OFF, and performing the Command/Amp NORMALIZE GAIN command (as explained above).

## Using the ASR-10 as a Virtual Multi-Track Digital Recorder

Because the ASR-10 has several unique sampling features (such as the ability to sample through the Effects and the MAIN OUT sample mode, which allows you to resample sequence playback or notes played the keyboard), you can use the ASR-10 as a virtual multi-track digital recorder. Doing this requires some creative thinking on how to use some of these sampling features. This application note will give you some ideas and point you in the right direction.

- First, load instruments into **Instrument•Sequence Track** locations 1-6 and record a 4 bar sequence. Set the Effects the way you want them to be heard.
- The next step is to sample this sequence. To do this, set the ASR-10 to REC SRC= MAIN OUT L+R on the Sample•Source Select page. Press **Enter•Yes** to enter the sampling page and select one of the two unused **Instrument•Sequence Track** locations when you see the PICK SAMPLE INSTRUMENT prompt. Now initiate sampling. As soon as sampling has begun, start the sequencer. Let the sequence play through one repetition, then hit **Cancel•No** to end sampling. Select a root key when prompted, and you're ready for the next step.
- At this point, you may need to edit the SAMPLE START point of the sample. Here's a tip on doing this. Go back to your sequence, and press **Record** and **Play**. On the first beat of measure 1, play the root key of the Instrument containing the new sample, and hold it down for the entirety of the four bar sequence. The sample will most likely not begin playing at the point where the music from your original sequence starts playing, but that's okay. QUANTIZE this track to 1/4 notes when you're finished.

The purpose of doing this is to give you a shortcut for finding the correct SAMPLE START location. Here's how:

- Select the new sample for editing and go to the SAMPLE START screen. Now, adjust the percentage parameter, but instead of striking the key each time to hear if you've found the right spot, hit the **Play** button of the sequencer. Press the **Stop•Continue** button if you don't hear music begin playing as soon as the sequencer starts playing, then reset the SAMPLE START parameter, and try again.

Now, here comes the benefit of doing it this way. When you think the SAMPLE START point is close, start the sequencer again, this time with both the CLICK and LOOP parameters set to ON. You can now edit using the absolute sample start parameter. If you have found exactly the right SAMPLE START point, the click will be in time with the music. Also, when the sequencer loops, it will restrike the sample. You should hear no "glitch" when the sequence loops. Once you have your sample meeting both of these standards, you've found the right SAMPLE START location.

- Next, move on to the SAMPLE END parameter and set it to a point just past the end of the fourth measure of music. For this edit, you will have to strike the key, since playing the sequencer will never play the sample all the way to the end (it loops, remember?). Once you have a SAMPLE END point set, use the TRUNCATE WAVESAMPLE command to get rid of the unneeded data at the beginning and end of the sample.
- After playing your new sample, you can use the DELETE INSTRUMENT command to eliminate instruments 1-6. Remember, since our sequence is now a sample, you're able to erase all of the instruments used to make the sequence and in so doing, free up some memory.
- You can now record a second digital audio track. Plug in a microphone, or a guitar, bass, or any line signal into the Left Audio Input of the ASR-10. Use the Mic/Line Switch and the Input Level knob to set the correct level.
- Set the REC SRC page to INPUT+FX LEFT. Press **Enter•Yes** to enter sampling mode and select an unused **Instrument•Sequence Track** when you see the PICK SAMPLE

INSTRUMENT prompt.

- Next, play the sequence and play or sing along with it until you feel comfortable with your new part. Then, press **Enter•Yes** again to begin sampling. As soon as sampling has begun, start the sequencer and play or sing along through one 4 bar repetition. Then, hit **Cancel•No** to stop sampling. Select a root key when prompted.

Notice that when you play back the new sample, you hear only the new part. This is because the sequencer is not recorded in REC SRC= INPUT+FX (or REC SRC= INPUTDRY) mode. The sequence was only acting as a timing guide for the new part. This allows you to have track separation to set Volume and Panning information.

- Now, record this new sample into the sequence by playing on the first beat of bar 1, then QUANTIZE to 1/4 notes, just like you did with the first sample. You can then proceed to edit the SAMPLE START and end parameters, as described above. When the SAMPLE START time is correct, you'll hear this new track "sync up" with the original sample.
- You can now continue adding tracks in this fashion until you get close to running out of memory, or have only one sequence track left. Once either of these things happens, go on to the next step.
- Now you can "bounce down" the tracks you have to a stereo mix. To do this, set your track mix and pan levels where you'd like them. You can also add a new Effect onto the entire mix, if you desire. Then, set the REC SRC parameter to MAIN OUT L+R. Press **Enter•Yes** and select an unused **Instrument•Sequence Track** location when you see the PICK SAMPLE INSTRUMENT prompt. You are now essentially back at the beginning of this application note, taking a sequence of multiple tracks and sampling it into a two track master mix. If you'd still like to add more tracks, you can again erase all of the instruments that were in the sequence you just sampled, and proceed repeating the above steps in the application note.

Happy recording!

## Section 16 — Instrument Programming Applications

---

This section provides information on some of the most commonly used Instrument programming applications.

### Making a Stereo Sound from a Mono WaveSample

Within an Instrument, you can take a mono WaveSample, copy it to another layer, and pan each WaveSample left and right to create a stereo sound. You can also select a layer (containing many WaveSamples), copy the layer, and then pan each layer left and right to create a stereo sound. For the purpose of this discussion, we'll copy a WaveSample from an Instrument that only has one layer, and one WaveSample. Here's how:

- Make sure the Instrument with the WaveSample to be copied is selected, by pressing it's **Instrument•Sequence Track** button (yellow LED solidly lit).
- Press **Command**, followed by **Layer** and scroll until the display shows CREATE NEW LAYER.
- Press **Enter•Yes**. The display momentarily reads LAYER 2 CREATED.
- Press the **Edit** button. The display shows:

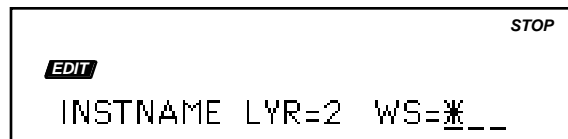

The screenshot shows a rectangular display area. In the top right corner, the word "STOP" is visible. In the top left corner, the word "EDIT" is displayed in a bold, italicized font. The main text of the display reads "INSTNAME LYR=2 WS=\* \_", where the asterisk and the first underscore are underlined.

Here you see the currently selected instrument, the newly created layer (LYR= 2), and WS= \* (the \* indicates that there are no WaveSamples in this layer yet).

- Move the cursor (underline) to LYR = 2. The cursor should be beneath the Layer number. If it's not, use the **Left Arrow** button to move it there.
- Press the **Up/Down Arrow** buttons to select the first layer (LYR= 1).
- Move the cursor (underline) to WS = \*. Use the **Right Arrow** button to move it there.
- Play the keyboard or press the **Up/Down Arrow** buttons to select the WaveSample to be copied.
- Press **Command**, followed by **Wave** and scroll until the display shows COPY WAVESAMPLE.
- Press **Enter•Yes**. The display shows TO INST= (Instrument name). Select the same Instrument.
- Press **Enter•Yes**. The display shows TO LAYER= \_\_. Select Layer 2.
- Press **Enter•Yes**. The display shows either COPY= PARAMS ONLY or COPY= PARAMS +DATA. Since the WaveSample copy is going in the same Instrument, we don't need to copy the data, and choosing COPY= PARAMS ONLY uses the least amount of memory. Select COPY= PARAMS ONLY.
- Press **Enter•Yes**. The display briefly shows WAVESAMPLE 2 CREATED.

Now that we have the same WaveSample copied to 2 different layers, we can pan each WaveSample left and right to create a stereo sample.

- Press the **Edit** button, and select (same Instrument name) LYR= 1 WS= 1 using the **Arrow** buttons as explained above.
- Press the **Amp** button and scroll until the display shows WS VOLUME=99 PAN=+0.
- Move the cursor (underline) to PAN= +0. The cursor should be beneath the pan value. If it's not, use the **Left /Right Arrow** buttons to move it there.
- Use the **Data Entry Slider** to set the value to PAN= +99.
- Press the **Edit** button, and select (same Instrument name) LYR= 2 WS= 2.
- Press the **Amp** button. The display shows WS VOLUME=99 PAN=+0.
- The cursor will still be beneath the pan value.
- Use the **Data Entry Slider** to set the value to PAN= -99.

You've just taken a mono WaveSample, copied it to another layer, and panned them left and right to create a stereo sound. If you aren't hearing both stereo signals, double-click the **Instrument** page button (the 00 PATCH= screen is displayed), and make sure both Layers 1 and 2 are selected.

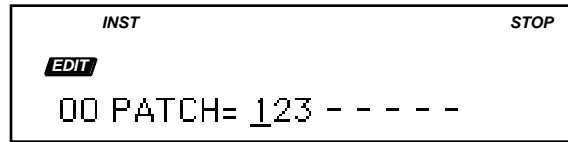

If not, move the cursor with the **Left/Right Arrow** buttons and select/deselect the layers with the **Up/Down Arrow** buttons. In the above example layers 1, 2, and 3 are selected. Layers 4 through 8 are deselected. Take the time to enjoy your newly created stereo sound.

**Tip:** One of the most common tricks to creating a “chorused” effect is to slightly detune each channel of a stereo WaveSample in equal amounts of positive and negative values. Here's how to do this with our newly created stereo example:

- Press the **Edit** button, and select (same Instrument name) LYR= 1 WS= 1 using the **Arrow** buttons as explained above.
- Press the **Pitch** button and scroll until the display shows ROOT KEY=(key location) FINE=+0.
- Move the cursor (underline) to FINE= +0. The cursor should be beneath the fine tune value. If it's not, use the **Left /Right Arrow** buttons to move it there.
- Use the **Up/Down Arrow** buttons to set the value to FINE= +5.
- Press the **Edit** button, and select (same Instrument name) LYR= 2 WS= 2
- Press the **Pitch** button. The display still shows ROOT KEY=(key location) FINE=+0.
- Use the **Left /Right Arrow** buttons to set the value to FINE= -5.

For more of a “chorused” effect, set the positive/negative values to a wider range. For less of a “chorused” effect, set the positive/negative values to a closer range.

## Creating Keyboard Cross Fades

We'll use the Edit/Amp, Volume Modulator Cross Fade Breakpoints to create a keyboard cross fade. First, create three samples in three layers:

- With a microphone connected to the left Audio Input of the ASR-10, press **Sample•Source Select**, set REC SRC= INPUTDRY LEFT, and then pick a sample instrument. Press **Enter•Yes** and say “one,” then press **Cancel•No** to stop sampling. Make the lowest C on the keyboard the root key for sample “one” in layer 1.
- The next sample will be in a NEW layer. Press **Sample•Source Select**, then pick the same sample instrument. Underline LYR= 1 and change that to LYR= N. Press **Enter•Yes** twice. Say “two.” Press **Cancel•No** and assign the root key to middle C (two octaves above the lowest C). That's sample “two” in layer 2.
- Press **Sample•Source Select**, then pick the same sample instrument. Underline LYR=2 and change that to LYR=N. Press **Enter•Yes** twice, and say, “three” into the microphone. Press **Cancel•No** and assign the root key to the C two octaves above middle C. Sample “one” is in the bottom third of the keyboard. Sample “two” is in the middle third, and sample “three” is in the top third.

Press the **Edit** button to get to the Edit Context page. Adjust the parameters in the display so they read UNNAMED LYR=1 WS=ALL. Press the **Amp** button. You are now on the EDIT/Amp page. Scroll right to VOLUME MOD and adjust the parameters so the display reads VOLUME MOD=KBD \* 0. This selects KBD (keyboard) as the volume modulator. Underline the number in the display and change it to 99. The display will read VOLUME MOD=KBD \* 99. Scroll right to

A-B FADE IN and set the parameters in the display to read, A-B FADE IN=0 TO 40. Scroll right one more page, and set the parameters in the display to read, C-D FADEOUT=50 TO 60. Press the **Edit** button to return to the Edit Context page. Underline LYR=1 in the display and change that to LYR=2. The display now reads UNNAMED LYR=2 WS=ALL.

Press the **Edit** button to return to the Edit/Amp page. Scroll right to the VOLUME MOD page, and set it to VOLUME MOD=KBD \* 99. Scroll right to the A-B FADE IN page and set it to A-B FADE IN =45 TO 55. Scroll right to the C-D FADE OUT page and set it to C-D FADE OUT=65 TO 75.

Press the **Edit** button and set the parameters in the display to read UNNAMED LYR=3 WS=ALL. Press the **Edit** button again to return to the Edit/Amp page. Scroll right to VOLUME MOD, and set it to VOLUME MOD=KBD \* 99. Scroll right to A-B FADE IN and set the parameters to A-B FADE IN=60 TO 70. Scroll to C-D FADE OUT and set it to C-D FADE OUT=80 TO 127. The following diagram illustrates the keyboard crossfade that you have now constructed:

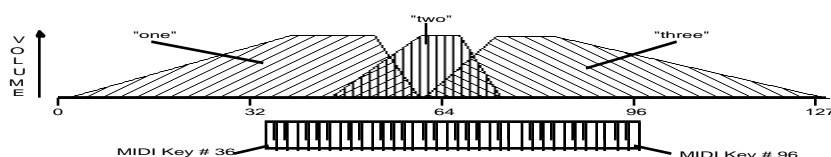

As you play chromatically up the keyboard you will hear the three different WaveSamples fading in and out. The voice samples could have been piano or synthesizer samples, and the result would have been the same. When the keyboard is used as the Volume Modulator, the Crossfade Breakpoint parameters enabled you to blend the samples together seamlessly.

Note that when the keyboard is used as the volume modulator, the numbers selected for A, B, C, and D refer to MIDI key numbers. The low C on the ASR-10 keyboard is MIDI key # 36; the high C is MIDI key number 96. Middle C is MIDI key # 60. And so on. (The keys of an 88-note piano-style keyboard go from MIDI key 21 to MIDI key 108.)

Although the crossfade described above uses the keyboard to determine the breakpoints. The output of any of the available modulators found on the Edit/Amp Volume Mod parameter can be used.

See *Section 11 — WaveSample and Layer Parameters* for more information on the Volume Modulator Cross Fade Breakpoints.

## Velocity Cross-Switching Between Layers

This application will give you an example of how velocity can be used to call up layers:

- Press the **Sample•Source Select** button, set REC SRC= INPUT DRY LEFT, and then pick a sample instrument. Press **Enter•Yes** and say “one,” then press **Cancel•No** to stop sampling. Make middle C the root key. This is layer one.
- Press the **Sample•Source Select** button again, pick the same sample instrument. The display reads UNNAMED LYR=1 WS=NEW. Underline LYR=1, and set it to LYR=N. Press **Enter•Yes**. Press **Enter•Yes** again and say “two.” Again, make middle C the root key. This is layer two.
- Press the **Sample•Source Select** button, then pick the same sample instrument. Underline LYR=2 in the display, and change it to LYR=N. Press **Enter•Yes** twice, and say “three.” This is layer three. Again, select middle C as the root key. When you play middle C, you will hear samples, “one, two, and three,” in layers one, two, and three.

Now that we have our WaveSamples, the Edit/Layer LAYER VELOCITY parameter can be used.

- Press **Edit**. This places you on the Edit Context page. Using the **Data Entry Slider** or **Arrow** buttons, adjust the parameters on the page so the screen reads, UNNAMED LYR=1 WS=ALL.
- Press the **Layer** button. This will take you to the Edit/Layer page. Scroll to the LYR VEL screen and underline and adjust this parameter so it reads LYR VEL LO=0 HI=42.
- Press the **Edit** button again, which takes you back to the Edit page. Underline LYR=1 in the display and change it to LYR=2. The display reads UNNAMED LYR=2 WS=ALL. Pressing the **Edit** button takes you back to the Edit/Layer page (the **Edit** button acts as a toggle).
- Set the Edit/Layer parameters to LYR VEL LO=42 HI=85. Press the **Edit** button again, to return to the Edit Context page. Underline LYR=2 and set it to LYR=3. Press the **Edit** button to toggle back to the Edit/Layer page. Set these Parameters to LYR VEL LO=86 HI=127.

All three Layers are now set to respond to velocity. A layer will only play when the note-on velocity is within the range specified on this page. A soft attack will call up sample “one,” a medium attack, sample “two,” and a hard attack, sample “three.” Remember, you can do this with up to eight layers.

## Using the ENTER PLAYS KEY Parameter

The ENTER PLAYS KEY parameter, found on the Edit/System•MIDI page, adds new functionality for selecting and playing WaveSamples. By using the **Data Entry Slider** or the **Up/Down Arrow** buttons, you can select each key and play it by pressing the **Enter•Yes** button. This is useful for hearing WaveSamples outside of your keyboard's range, or hearing the different WaveSamples in a multi-sampled instrument (like a drum kit for instance).

Let's experiment with this feature by using the **Enter•Yes** button to play some of the keys assigned in the STEREO DRUMS instrument (from disk #AD-007 which came with your ASR-10).

- Load STEREO DRUMS into an **Instrument•Sequence Track** and select it (its Selected LED should be lit yellow).
- Press the **Edit** button, then **System•MIDI**, and using the **Arrow** buttons, scroll to the ENTER PLAYS KEY parameter. The display shows ENTER PLAYS KEY=C4.
- Press **Enter•Yes**. You will hear the ride cymbal assigned to C4, played at a velocity of 127. The note will sustain for as long as you hold down the **Enter•Yes** button. You can even press the Sustain pedal to sustain the note indefinitely. This note is transmitted via MIDI (assuming Edit/Instrument MIDI STATUS=BOTH) and can be recorded by the sequencer.
- Press the **Up Arrow** until the display shows ENTER PLAYS KEY=D4+.
- Press **Enter•Yes**. You will hear now the crash cymbal assigned to D4+.
- Press the **Up Arrow** until the display shows ENTER PLAYS KEY=A4.
- Press **Enter•Yes**. You will now hear the low tom assigned to A4.

Take a moment to select different keys using the **Up/Down Arrow** buttons, and play them using the **Enter•Yes** button. Fun, huh?

Now we're going to use the ENTER PLAYS KEY parameter to locate a WaveSample for editing. This is useful for determining which WaveSample to edit, without having a MIDI Controller connected to your ASR-10.

- Press the **Up Arrow** until the display shows ENTER PLAYS KEY=D3+.
- Press **Enter•Yes**. You will hear the snare assigned to D3+.
- Press the **Edit** button. This takes us to the Edit Context page.
- Press the **Enter•Yes** button. This plays the snare again, and updates the Edit Context page (just as if a note-on for D3+ was received from a MIDI controller), showing which WaveSample (in Layer 1) is selected for editing. In this scenario, it is WS=6.

What if the WaveSample you want to edit is not in Layer 1 (or in the currently displayed layer)? By continually moving the cursor back and forth between the Layer and WaveSample values on the Edit Context page (selecting each defined layer), pressing the **Enter•Yes** button will help you locate the WaveSample that you want to edit.

- Press **System•MIDI** to go back to the ENTER PLAYS KEY parameter.
- Press the **Up Arrow** until the display shows ENTER PLAYS KEY=E6.
- Press **Enter•Yes**. You will hear the hand-clap assigned to E6.
- Press the **Edit** button to get to the Edit Context page.
- Press **Enter•Yes** to update the Edit Context page. You will hear the hand-clap assigned to E6, but since this WaveSample is not on Layer 1, the display shows WS=ALL.
- Move the cursor under the Layer value, and select Layer 2 using the **Up Arrow** button.
- Move the cursor under the WaveSample value, and press the **Enter•Yes** button. You have just determined that this WaveSample is not on Layer 2, because the display still shows WS=ALL.
- Repeat the last two steps for Layer 3, Layer 4 and Layer 5. Haven't found it yet, huh?
- Move the cursor under the Layer value, and select Layer 6 using the **Up Arrow** button.
- Move the cursor under the WaveSample value, and press the **Enter•Yes** button. The WaveSample value has been updated, and the display shows WS=37. You've just used the **Enter•Yes** button to find the location of the hand-clap (LYR=6 WS=37). Now press the **Enter•Yes** button repeatedly, and give yourself a hand!



# Section 17 — Sequencing/MIDI Applications

This section covers a number of advanced sequencer applications, including using the ASR-10 with a variety of external MIDI devices.

## Using the ASR-10 as a Master MIDI Controller

### The MIDI Connection

Musical Instrument Digital Interface (MIDI) — that magical connection that lets you play one instrument (or a whole roomful of them) from another — is a standard that has been agreed upon by manufacturers for translating musical events into specific numbers that are transmitted and received by MIDI instruments.

For instance, when you play middle C on the ASR-10, it instantly transmits a series of numbers out its MIDI Out jack. These numbers represent a *Key Down* event, along with the location of the note on the keyboard and how hard the key was struck. When you release the key, the ASR-10 transmits a number meaning *Key Up*. Any MIDI keyboard connected to the ASR-10 can receive and translate those numbers and will play the middle C itself. The same thing happens whenever you move a controller, such as the Pitch Bend or Mod Wheel, or when you select a new sound — each of these events is translated into a series of numbers which are transmitted out the MIDI Out jack.

### Controlling Remote MIDI devices from the ASR-10 — MIDI Connections

You can use the ASR-10 banks or performance presets to drive external MIDI instruments, greatly enhancing the number of available voices and timbres. With the Edit/Instrument MIDI STATUS parameter, an instrument, and its associated sequence and song track can be assigned one of the following settings:

- EXT or MIDI status — so that it will play only out via MIDI
- LOCAL status — so that it will play only locally on the ASR-10
- BOTH — in which case it will play a local sound *and* will transmit on its designated MIDI OUT CHANNEL

When controlling multiple remote MIDI devices, first connect the various devices to the ASR-10, and to each other, as shown here. Connect the MIDI Out jack of the ASR-10 to the MIDI In jack of the first device. Then connect the MIDI Thru jack of the first device to the MIDI In jack of the second device. Connect the MIDI Thru jack of the second device to the MIDI In jack of the third device. And so on, for as many devices as you will be using.

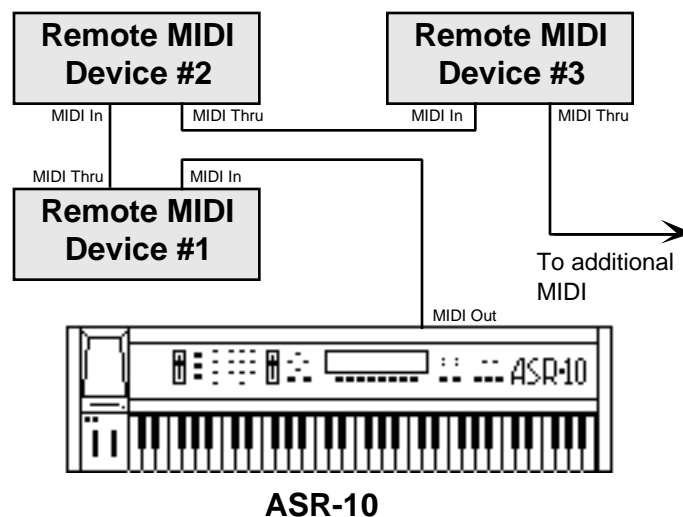

With this arrangement, once you set up the proper MIDI channels, etc., each remote MIDI device will receive and play only the data that is intended for it, and will “pass along” all other data. Also, each can be played from its own keyboard (as well as from the ASR-10’s) without affecting the others, because MIDI Thru jacks only pass along incoming MIDI data, and do not transmit what is played on the instrument.

This set up is ideal for controlling everything right from the ASR-10. Simply by making a MIDI Instrument and setting the **Instrument • Sequence Track** to the same MIDI channel as a particular instrument, you can:

- Play the remote MIDI device from the ASR-10 keyboard
- Record a sequence track that will play back on the remote MIDI device when you play the sequence or song
- Send the remote MIDI device program changes and adjust its volume (assuming the device receives MIDI volume)

In other words, once you have made the appropriate connections and set up the MIDI configuration of the tracks and all remote MIDI devices, you can use the ASR-10's keyboard and its front panel to control and record all the remote MIDI devices in your rig.

### Creating a MIDI Instrument

Let's suppose that you have a synthesizer module (say an ENSONIQ SQ-R PLUS 32 Voice) connected to the ASR-10 as shown below:

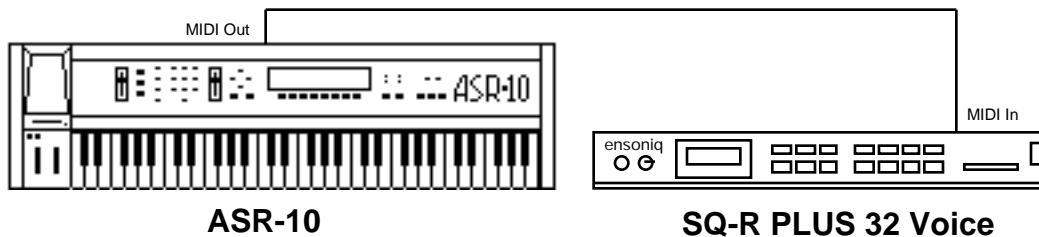

You want to be able to select the SQ-R PLUS 32 Voice from the ASR-10 front panel and then play or sequence it from the ASR-10 just as you would an ASR-10 instrument. To do this, you can make an ASR-10 instrument that contains no sample data, and that will not sound on the ASR-10, but will only transmit via MIDI. Such "MIDI Instruments," as we call them, use up very little memory, and can be loaded from disk almost instantly. They are the key to using the ASR-10 as a MIDI master controller.

- On the Edit/System • MIDI page, set the TRANSMIT ON parameter to TRANSMIT ON= INST CHAN.
- Press **Command**, then press **Instrument**.
- Scroll left or right until the display reads CREATE NEW INSTRUMENT.
- Press **Enter • Yes**. The display reads SELECT UNUSED INST= 1. The new instrument will be created in the **Instrument • Sequence Track** location indicated. You can select a different location (by pressing any unused **Instrument • Sequence Track** button), or just press **Enter • Yes**.
- Press **Enter • Yes**. The ASR-10 will create a new unnamed instrument in the location you indicated. The new instrument is selected (its yellow LED is lit). Note that it contains no layers or WaveSamples and will make no sound when you play the keyboard.
- Press **Edit**, then press **Instrument**. This puts you on the Edit/Instrument page where you will assign the characteristics of your new instrument.
- Using the **Arrow** buttons, scroll left (or right) until the display shows MIDI STATUS. Set MIDI STATUS = MIDI. Now the instrument will only play over MIDI, sending keys, controllers, etc. on its designated MIDI channel.
- Scroll left to the parameter MIDI OUT CHANNEL = \_\_. This is the MIDI channel on which the instrument will transmit. Let's suppose that the SQ-R PLUS 32 Voice in our example is set to receive on MIDI channel 3. We would set this parameter to MIDI OUT CHANNEL= 3. Now, selecting and playing this instrument should play the SQ-R PLUS 32 Voice.
- Name the new instrument. Scroll left until the display shows NAME = UNNAMED INST and

use the **Arrow** buttons to name/rename the instrument. Give the new instrument a name which describes it. In this case we might name it SQR - CHAN 3.

- Press **Load** to return to LOAD mode and select the MIDI instrument. The instrument's name and volume level show on the display like any other ASR-10 instrument. When you play it from the ASR-10 keyboard you should hear the SQ-R PLUS 32 Voice.
- You can select, deselect, or stack the MIDI instrument as you would a local instrument.
- You can change its keyboard range so it only plays over a specified part of the keyboard.
- Changing its volume (by moving the **Data Entry Slider**) will send MIDI volume changes to the SQ-R PLUS 32 Voice, letting you mix its level just as you would a local instrument.
- Save the new instrument to disk. You can later load it into any of the eight **Instrument•Sequence Track** locations and play the SQ-R PLUS 32 Voice just as you would load and play a local sampled instrument.

Create customized MIDI-only ASR-10 instruments for each of your remote MIDI devices. Then load them into memory for playing and sequencing specific external instruments. Just remember to follow these rules:

- TRANSMIT ON = must be set to INST CHAN on the Edit/System•MIDI page.
- Each external device for which you create a MIDI instrument should always be set to receive in POLY (or MULTI) mode, OMNI OFF, and always on the same MIDI channel that you assign the related ASR-10 MIDI instrument to transmit on.
- Make sure that any ASR-10 instruments that you don't want transmitting notes via MIDI are assigned to SEND KEYS TO = LOCAL. Then save the instrument(s) to disk.

## Recording into the ASR-10 Sequencer from a MIDI Controller

On many occasions, you may find it convenient to use an external controller to record a track into the ASR-10's internal sequencer. This could be for added authenticity (recording from Drum Pads to get a "live drummer" feel), performance flexibility (recording from a weighted-action MIDI keyboard controller like the ENSONIQ KS-32), or ease of use (a guitarist recording from a guitar controller). No matter which type of MIDI controller you use, there are a few parameters that need to be set in order to record into the sequencer.

### Recording Onto a Single Track (One MIDI Channel)

- Connect a MIDI cable from the MIDI Out of the controller to the MIDI In of the ASR-10.
- Set the MIDI IN MODE to POLY on the Edit/System•MIDI page. The MIDI controller should be in POLY mode as well.
- Set the ASR-10 MIDI BASE CHANNEL to the same MIDI channel that the MIDI controller is set to transmit on.
- Select the track you want to record on by pressing the appropriate **Instrument•Sequence Track** button on the ASR-10. Make sure the Instrument on the selected **Instrument•Sequence Track** has its Edit/Instrument MIDI STATUS set to BOTH, LOCAL, or MIDI.
- On the Edit/Seq•Song page, set the SEQ REC SOURCE parameter to BOTH or MIDI.

Recording proceeds normally from this point, with the sequencer responding to the data from the MIDI controller the same as it would to data from its own keyboard.

### Recording Onto Several Tracks (Multiple MIDI Channels) — Multi-Track Record

- Connect a MIDI cable from the MIDI Out of the controller to the MIDI In of the ASR-10.
- Set the MIDI IN MODE to MULTI on the Edit/System•MIDI page.
- Set the MIDI controller to either MONO B (for guitar controllers sending on individual strings) or MULTI (for transferring data from another sequencer). Consult the manual for the external MIDI device for details.
- Set the individual MULTI IN MIDI CHANNEL for each track (found on the Edit/Track page), matching MIDI receive channels with those that will be transmitted on by the controller. Different MIDI receive channels must be selected for each **Instrument•Sequence Track** that you want to receive via MIDI. If more than one sequence track is set to the same MULTI IN MIDI CHAN, only the lowest numbered **Instrument•Sequence Track** will receive via MIDI.
- Make sure all of the instruments on the **Instrument•Sequence Tracks** that you want to record on have their Edit/Instrument MIDI STATUS set to BOTH, LOCAL, or MIDI.
- On the Edit/Seq•Song page, set the SEQ REC SOURCE parameter to MULTI.

Once these parameters are set, you can begin recording. For more information on recording with the SEQ REC SOURCE set to MULTI (Multi-Track Record), see *Section 12 — Sequencer and Audio Track Concepts*.

## Using the ASR-10 with an External Sequencer

Because of its multi-timbral capabilities, the ASR-10 is an ideal instrument for use with a MIDI sequencer. Its ability to receive on up to eight MIDI channels at once means that the ASR-10 can take the place of several keyboards in your rig.

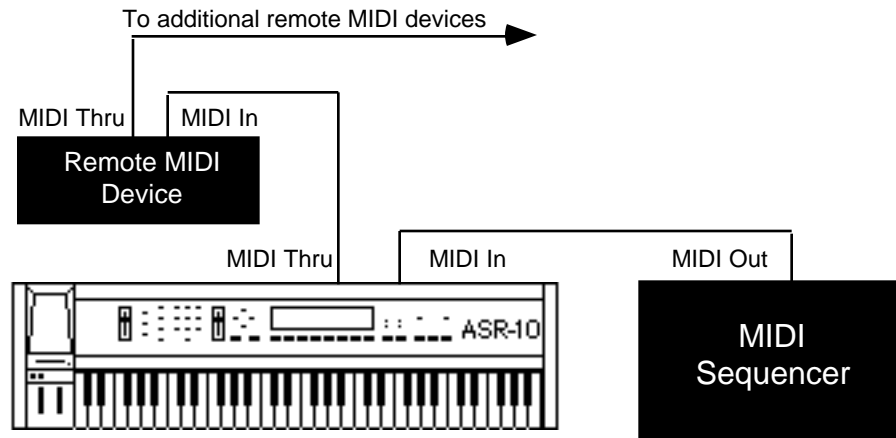

The illustration above shows a typical sequencing set-up. Of course the ASR-10 doesn't have to be the first in the chain after the sequencer — you can chain MIDI devices in any order, with one exception; if a unit doesn't have a MIDI Thru jack, you must place that unit last in the chain.

### POLY Mode — The ASR-10 as One Instrument

We'll start with the most basic sequencing situation, in which the ASR-10 will be used as if it were an ordinary instrument. This is how it will act in POLY mode. In POLY mode, the ASR-10 will respond only to information received on the base MIDI channel, and will play only the sounds that are selected on the front panel.

- On the Edit/System•MIDI page, set the MIDI mode parameter to MIDI IN MODE=POLY.
- Also on the Edit/System•MIDI page, set the MIDI channel (MIDI BASE CHANNEL=\_\_\_) to the MIDI channel you want the ASR-10 to receive on. In POLY mode, the ASR-10 will only respond to MIDI messages received on this MIDI channel.

### MULTI Mode — The ASR-10 as Eight Independent Instruments

When you set the MIDI IN MODE= MULTI on the Edit/System•MIDI page, the ASR-10 becomes eight "virtual instruments," each receiving on its own MIDI channel, but all sharing the same pool of voices.

- On the Edit/System•MIDI page, set the MIDI IN MODE parameter to MULTI.
- For each instrument, set the MULTI IN MIDI CHANNEL parameter, found on the Edit/Track page. The MIDI channels you select for each track should correspond to the MIDI channels that the external MIDI sequencer will transmit on.

### Some Important Points about MULTI Mode

- Each of the eight **Instrument•Sequence Tracks** is completely independent and polyphonic. The ASR-10's dynamic voice allocation means that at any moment, each track can play all of the ASR-10's voices, if it needs them. If all voices are in use and a track needs a voice, it will "steal" the voice from the oldest note playing.
- In MULTI mode it doesn't matter what instruments are selected or stacked on the front panel. Which instruments will play depends entirely on what MIDI channel(s) the data is received on.
- Different MIDI receive channels must be selected for each **Instrument•Sequence Track** that you want to receive via MIDI. If more than one sequence track is set to the same MULTI IN MIDI CHAN, only the lowest numbered **Instrument•Sequence Track** will receive via MIDI.
- In MULTI mode, program changes received by a given **Instrument•Sequence Track** on its MIDI channel will cause the ASR-10 to try to load the same numbered instrument disk file into that **Instrument•Sequence Track** location, replacing the instrument that is currently loaded in that location.
- When using a MIDI sequencer, it's generally a good practice to assign a certain MIDI channel (or channels) to each instrument in your rig and always leave them set to that channel.
- When recording in MULTI mode, the SEQ REC SOURCE parameter on the Edit/Seq•Song page must also be set to MULTI.

### Synchronizing to an External MIDI Clock Source

When you set the CLOCK SOURCE= MIDI on the Edit/Seq•Song page, the ASR-10 will sync to incoming MIDI clocks from a remote device. The MIDI indicator light will flash and the display will show WAITING... Recording will begin with the first MIDI clock received after a MIDI Start command. If the **Stop•Continue** button is pressed *before* a MIDI Start command is received, the ASR-10 waits 5 seconds before stopping.

## Using the ASR-10 with a Drum Machine

When you use the ASR-10 in conjunction with a drum machine or other rhythm sequencer, there are three ways to have them operate together:

- Sync the drum machine's clock to the ASR-10
- Sync the ASR-10's clock to the drum machine
- Sequence the drum machine from the ASR-10, just as you would a synthesizer

### To Sync a Drum Machine to the ASR-10:

- Connect the MIDI Out of the ASR-10 to the MIDI In of the drum machine.
- Set the drum machine to sync to MIDI clocks.
- Set the drum machine to receive on an unused MIDI Channel, OMNI Off; or disable channel information. You don't want the drum machine receiving and playing back ASR-10 sequence data intended for other instruments. MIDI clocks, start, stop, and continue are *real time* commands that are sent and received regardless of MIDI channel or mode.
- The drum machine should now sync to the ASR-10's clock. Pressing **Play** or **Stop • Continue** will start, stop, and continue the drum machine, assuming it receives those commands.

### To Sync the ASR-10 to a Drum Machine:

- Connect the MIDI Out of the drum machine to the MIDI In of the ASR-10.
- Set the ASR-10 to sync to MIDI clocks. On the Edit/Seq • Song page, select **CLOCK SOURCE=MIDI**.
- Set the drum machine to not transmit channel information, or to transmit on a MIDI Channel that none of the ASR-10 **Instrument • Sequence Tracks** have their Edit/Track **MULTI-IN MIDI CHANNEL** set to receive on. Again, MIDI clocks, start, stop, and continue are sent and received regardless of MIDI channel or mode.
- The ASR-10 should now sync to the drum machine's clock. Starting, stopping, or continuing the drum machine will start, stop, and continue the ASR-10.

### To Sequence a Drum Machine from a Track of the ASR-10:

- Connect the MIDI Out of the ASR-10 to the MIDI In of the drum machine.
- Set the drum machine to Tape Sync or External Clock, or any setting other than Internal or MIDI Clock. This way it will not play its own patterns, but will act only as a sound-producing device, sequenced from a track of the ASR-10.
- Set the drum machine to POLY (OMNI Off) mode and select a MIDI channel.
- From the Edit/Instrument page, set the MIDI Status for an ASR-10 Instrument to MIDI. Set the instrument's MIDI OUT CHANNEL to the same MIDI channel you assigned the drum machine to receive on.
- You should now be able to play the drum machine from the ASR-10 keyboard. You can then record a track on the ASR-10, from the ASR-10 keyboard, which will play on the drum machine — just as if you were sequencing an external synthesizer. The advantage of this approach is that some drum machines respond better to velocity when played via MIDI than when played from their own front panels. Thus, you may get more dynamic range out of your drum machine if you use this approach. The disadvantage is that you use up ASR-10 sequencer memory to sequence the drum machine.

## Using the ASR-10 with a MIDI Guitar Controller

The ASR-10 is an ideal instrument to use with any MIDI guitar controller that is capable of transmitting in MONO mode. MONO mode allows a guitar controller to transmit the notes played on each string on a different MIDI channel. This has the advantage of letting each string send pitch bends independently, which is the only way to truly recreate guitar technique on a synthesizer.

Some earlier guitar controllers do not support MONO mode. You will have to consult the manual of your particular model to see if it does. If you have a guitar controller that only sends in POLY mode (i.e. send all six strings on the same MIDI channel) you should use the ASR-10 in POLY mode or OMNI mode.

For MIDI guitar controllers that do support MONO mode, you will want to put the ASR-10 in one of the two types of MONO mode that are available. In MONO A, the ASR-10 receives on eight consecutive MIDI channels with only one voice assigned to each MIDI channel. In MONO B, the ASR-10 receives on the Edit/Track MULTI-IN MIDI channel assigned to each **Instrument•Sequence Track**.

- MONO A is the mode you will probably use most often. This is the mode to use when you want to play the same sound on all the strings of your guitar controller. In MONO A, the ASR-10 receives on eight consecutive MIDI channels (the MIDI BASE CHANNEL through MIDI BASE CHANNEL +7) and will play whatever **Instrument•Sequence Track(s)** are selected or stacked on the front panel. In other words, the ASR-10 behaves as it does in POLY or OMNI modes, except that it receives monophonically on multiple MIDI channels. This provides the advantage of multiple tracks that will respond independently to controllers received on multiple channels, but you do not have to set up the instruments for each track separately.
- MONO B is the mode to use if you want to be able to play a different sound on each string of your guitar controller. In MONO B, each **Instrument•Sequence Track** receives on its own Edit/Track MULTI-IN MIDI channel. In other words, the ASR-10 behaves as it does in MULTI mode, except that each **Instrument•Sequence Track** receives monophonically on multiple MIDI channels. This is the only way to get a different sound on each string when using a MIDI guitar controller.

### Using MONO A Mode

To use the ASR-10 in MONO A mode, set it up as follows:

- Load one or more instruments into the ASR-10.
- Press **Edit**, then **System•MIDI**. Scroll to MIDI IN MODE.
- Select MIDI IN MODE= MONO A.
- Set your guitar controller to transmit in MONO mode on channels 1– 6 (some models have an easy shortcut for getting into this state).
- Connect the MIDI Out of the guitar controller module to the MIDI In of the ASR-10.
- Press **Load** on the ASR-10 to return to Load mode. (Remember — the ASR-10 will only respond to program changes or select multiple instruments when in LOAD mode.)
- Select an **Instrument•Sequence Track** either by pressing a front panel button or by sending a program change from the guitar controller.
- You should now be able to play the ASR-10 from the guitar controller with all six strings playing whatever instrument(s) are selected or stacked on the front panel.



## Using MONO B Mode

To use the ASR-10 in MONO B mode, set it up as follows:

- Load one or more instruments into the ASR-10.
- Press **Edit**, then **System•MIDI**. Scroll to MIDI IN MODE.
- Select MIDI IN MODE= MONO B.
- Press **Edit**, then **Track**. Scroll to MULTI-IN MIDI CHANNEL.
- Set each **Instrument•Sequence Track** MULTI-IN MIDI CHANNEL to correspond with its track number (Track 1 MULTI-IN MIDI CHANNEL=1, Track 2 MULTI-IN MIDI CHANNEL=2, etc.).
- Set your guitar controller to transmit in MONO mode on channels 1– 6 (some models have an easy shortcut for getting into this state).
- Connect the MIDI Out of the guitar controller module to the MIDI In of the ASR-10.
- You should now be able to play the ASR-10 from the guitar controller with each string playing its corresponding **Instrument•Sequence Track** as shown below:

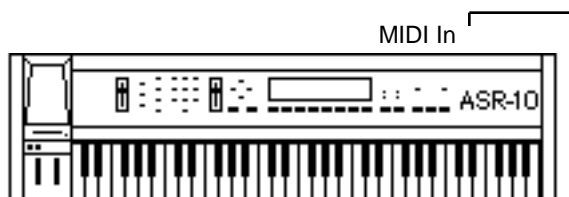

### ASR-10 Settings:

MIDI IN MODE=MONO B  
 Track 1 MULTI IN MIDI CHANNEL= 1  
 Track 2 MULTI IN MIDI CHANNEL= 2  
 Track 3 MULTI IN MIDI CHANNEL= 3  
 Track 4 MULTI IN MIDI CHANNEL= 4  
 Track 5 MULTI IN MIDI CHANNEL= 5  
 Track 6 MULTI IN MIDI CHANNEL= 6  
 Track 7 MULTI IN MIDI CHANNEL= 7  
 Track 8 MULTI IN MIDI CHANNEL= 8  
 MIDI BASE CHANNEL= 1  
 Global Controllers received on base channel minus one (Chan. 16)

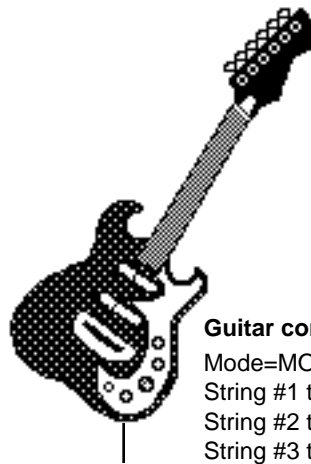

### Guitar controller Settings

Mode=MONO  
 String #1 transmits on Channel 1  
 String #2 transmits on Channel 2  
 String #3 transmits on Channel 3  
 String #4 transmits on Channel 4  
 String #5 transmits on Channel 5  
 String #6 transmits on Channel 6  
 Global controllers transmitted on Chan. 16

A few important points about MONO B Mode:

- Notes played on each string will play only the corresponding **Instrument•Sequence Track**. Each string/**Instrument•Sequence Track** combination is totally independent.
- MULTI-IN MIDI CHANNELS do not have to be set 1-8. They can be set to any channel from 1 to 16, as long as each track has a different MULTI-IN MIDI CHANNEL and the guitar controller transmits accordingly. Unless you have a very complex MIDI setup, setting things up as shown above will provide the most straight-forward and intuitive arrangement.
- Different MIDI receive channels must be selected for each **Instrument•Sequence Track** that you want to receive via MIDI. If more than one sequence track is set to the same MULTI IN MIDI CHAN, only the lowest numbered **Instrument•Sequence Track** will receive via MIDI.

### Global Controllers in MONO A and B Modes

Global controllers are controllers sent on one channel that affect all other channels simultaneously. They can be useful in reducing the number of MIDI events required to achieve particular effects, and can thereby reduce the delays sometimes associated with overloading MIDI. Some guitar controllers can transmit global controllers, and the ASR-10 can respond to them.

In MONO mode (A or B) the base channel minus one becomes the MIDI channel for global controllers (pitch bend, pressure, etc.). For example, if the base channel is channel 3, any controllers received on channel 2 will be interpreted as global controllers and will affect *all* voices being played. If the base channel is channel 1, channel 16 becomes the channel for global controllers. Each track will also respond independently to controllers sent on its own channel. For example, each guitar string on a MIDI guitar can send independent pitch bend, while the “whammy bar” controller could be sent on the global channel (channel 16 in the example above) to affect all voices.

**Note:** The ASR-10 will not receive note data via MIDI on the base channel minus one in MONO A and B modes. Therefore, we recommend that the MIDI BASE CHANNEL parameter on the Edit/System • MIDI page be set to the same channel as the **Instrument • Sequence Track** with the lowest numbered Edit/Track MULTI-IN MIDI CHAN number.

### Patch Selects and Presets

Making patch select changes from a continuous controller (i.e. mod wheel, whammy bar, etc.) can be an adventure. The patch select buttons are sent and received as MIDI controller #70. Since the ASR-10 recognizes the 0–31 range as both patch selects up; 32–63 as the right patch select down; 64–95 as the left patch select; 96–127 as both patch selects down, it can be difficult to make predictable changes from a continuous controller. If your MIDI guitar controller has the capability of sending discrete or specific controller values, rather than continuous controller numbers, then you'll be able to send predictable patch select changes.

Another alternative is to use the two pedals of the optional SW-10 Dual Foot Switch. When plugged into the rear panel Patch Select jack, the SW-10 will act as patch select buttons. This way you can change patches with you feet as you play the MIDI guitar controller.

Also, patch select configurations can be stored within performance presets which can be accessed by program changes 17-24 (in MONO A mode only). Each time you send a program change from your MIDI guitar controller, the ASR-10 will respond to that message by selecting one of the eight presets. Check the program change and patch assignment section in your MIDI guitar controller manual.

## Song Position Pointers

The ASR-10 sends and receives Song Position Pointers via MIDI. Song Position Pointers are MIDI commands that tell a sequencer or drum machine where to locate within a song or sequence.

When the ASR-10 receives a Song Position Pointer, it will locate to the appropriate place in the selected song or sequence.

The ASR-10 sends a Song Position Pointer over MIDI whenever you use the Auto-Locate control (the GOTO function on the Edit/Seq•Song page). Any receiving unit which recognizes Song Position Pointers will locate to the same spot. (Not all devices recognize Song Position Pointers. Consult the manual of any other sequencing device you are using to see if it does.)

## MIDI Song Selects

MIDI Song Selects allow a sequencer such as the ASR-10 to instruct a remote sequencer or drum machine to select a new song. The song can be assigned a MIDI Song Select number from 0 through 127. MIDI Song Select numbers 0 through 127 are transmitted via MIDI when you load a new song into the ASR-10, or when the currently loaded song is selected. The MIDI SONG SELECT parameter (on the Edit/System•MIDI page) must be set to “ON” for this to work.

The SEQUENCER INFORMATION parameter on the Command/Seq•Song page allows you to set the MIDI SONG SELECT number that will be sent whenever the song is selected. MIDI Song Select numbers are stored with the song when you save the song to disk.

## Delay Times/Tempo BPM Chart

This chart shows the relationship between delay times and tempo beats per minute. Values shown are accurate to 2 decimal places—since most delay devices are not accurate to 2 decimal places, you may have to round off these values. You can use this chart to set the effect delay times to sync to your sequence or song.

BPM	1/4 NOTE	1/8th NOTE	1/8 TRIPLET	1/16th NOTE
40	1500.00	750.00	500.00	375.00
41	1463.41	731.71	487.80	365.85
42	1428.57	714.29	476.19	357.14
43	1395.35	697.67	465.12	348.84
44	1363.64	681.82	454.55	340.91
45	1333.33	666.67	444.44	333.33
46	1304.35	652.17	434.78	326.09
47	1276.60	638.30	425.53	319.15
48	1250.00	625.00	416.67	312.50
49	1224.49	612.24	408.16	306.12
50	1200.00	600.00	400.00	300.00
51	1176.47	588.24	392.16	294.12
52	1153.85	576.92	384.62	288.46
53	1132.08	566.04	377.36	283.02
54	1111.11	555.56	370.37	277.78
55	1090.91	545.45	363.64	272.73
56	1071.43	535.71	357.14	267.86
57	1052.63	526.32	350.88	263.16
58	1034.48	517.24	344.83	258.62
59	1016.95	508.47	338.98	254.24
60	1000.00	500.00	333.33	250.00
61	983.61	491.80	327.87	245.90
62	967.74	483.87	322.58	241.94
63	952.38	476.19	317.46	238.10
64	937.50	468.75	312.50	234.38
65	923.08	461.54	307.69	230.77
66	909.09	454.55	303.03	227.27
67	895.52	447.76	298.51	223.88
68	882.35	441.18	294.12	220.59
69	869.57	434.78	289.86	217.39
70	857.14	428.57	285.71	214.29
71	845.07	422.54	281.69	211.27
72	833.33	416.67	277.78	208.33
73	821.92	410.96	273.97	205.48
74	810.81	405.41	270.27	202.70
75	800.00	400.00	266.67	200.00
76	789.47	394.74	263.16	197.37
77	779.22	389.61	259.74	194.81
78	769.23	384.62	256.41	192.31
79	759.49	379.75	253.16	189.87
80	750.00	375.00	250.00	187.50
81	740.74	370.37	246.91	185.19
82	731.71	365.85	243.90	182.93
83	722.89	361.45	240.96	180.72
84	714.29	357.14	238.10	178.57
85	705.88	352.94	235.29	176.47
86	697.67	348.84	232.56	174.42
87	689.66	344.83	229.89	172.41
88	681.82	340.91	227.27	170.45
89	674.16	337.08	224.72	168.54
90	666.67	333.33	222.22	166.67
91	659.34	329.67	219.78	164.84
92	652.17	326.09	217.39	163.04
93	645.16	322.58	215.05	161.29
94	638.30	319.15	212.77	159.57
95	631.58	315.79	210.53	157.89
96	625.00	312.50	208.33	156.25
97	618.56	309.28	206.19	154.64
98	612.24	306.12	204.08	153.06
99	606.06	303.03	202.02	151.52
100	600.00	300.00	200.00	150.00
101	594.06	297.03	198.02	148.51
102	588.24	294.12	196.08	147.06

BPM	1/4 NOTE	1/8th NOTE	1/8 TRIPLET	1/16th NOTE
103	582.52	291.26	194.17	145.63
104	576.92	288.46	192.31	144.23
105	571.43	285.71	190.48	142.86
106	566.04	283.02	188.68	141.51
107	560.75	280.37	186.92	140.19
108	555.56	277.78	185.19	138.89
109	550.46	275.23	183.49	137.61
110	545.45	272.73	181.82	136.36
111	540.54	270.27	180.18	135.14
112	535.71	267.86	178.57	133.93
113	530.97	265.49	176.99	132.74
114	526.32	263.16	175.44	131.58
115	521.74	260.87	173.91	130.43
116	517.24	258.62	172.41	129.31
117	512.82	256.41	170.94	128.21
118	508.47	254.24	169.49	127.12
119	504.20	252.10	168.07	126.05
120	500.00	250.00	166.67	125.00
121	495.87	247.93	165.29	123.97
122	491.80	245.90	163.93	122.95
123	487.80	243.90	162.60	121.95
124	483.87	241.94	161.29	120.97
125	480.00	240.00	160.00	120.00
126	476.19	238.10	158.73	119.05
127	472.44	236.22	157.48	118.11
128	468.75	234.38	156.25	117.19
129	465.12	232.56	155.04	116.28
130	461.54	230.77	153.85	115.38
131	458.02	229.01	152.67	114.50
132	454.55	227.27	151.52	113.64
133	451.13	225.56	150.38	112.78
134	447.76	223.88	149.25	111.94
135	444.44	222.22	148.15	111.11
136	441.18	220.59	147.06	110.29
137	437.96	218.98	145.99	109.49
138	434.78	217.39	144.93	108.70
139	431.65	215.83	143.88	107.91
140	428.57	214.29	142.86	107.14
141	425.53	212.77	141.84	106.38
142	422.54	211.27	140.85	105.63
143	419.58	209.79	139.86	104.90
144	416.67	208.33	138.89	104.17
145	413.79	206.90	137.93	103.45
146	410.96	205.48	136.99	102.74
147	408.16	204.08	136.05	102.04
148	405.41	202.70	135.14	101.35
149	402.68	201.34	134.23	100.67
150	400.00	200.00	133.33	100.00
151	397.35	198.68	132.45	99.34
152	394.74	197.37	131.58	98.68
153	392.16	196.08	130.72	98.04
154	389.61	194.81	129.87	97.40
155	387.10	193.55	129.03	96.77
156	384.62	192.31	128.21	96.15
157	382.17	191.08	127.39	95.54
158	379.75	189.87	126.58	94.94
159	377.36	188.68	125.79	94.34
160	375.00	187.50	125.00	93.75
161	372.67	186.34	124.22	93.17
162	370.37	185.19	123.46	92.59
163	368.10	184.05	122.70	92.02
164	365.85	182.93	121.95	91.46
165	363.64	181.82	121.21	90.91

## Section 17 — Sequencing/MIDI Applications

BPM	1/4 NOTE	1/8th NOTE	1/8 TRIPLET	1/16th NOTE
166	361.45	180.72	120.48	90.36
167	359.28	179.64	119.76	89.82
168	357.14	178.57	119.05	89.29
169	355.03	177.51	118.34	88.76
170	352.94	176.47	117.65	88.24
171	350.88	175.44	116.96	87.72
172	348.84	174.42	116.28	87.21
173	346.82	173.41	115.61	86.71
174	344.83	172.41	114.94	86.21
175	342.86	171.43	114.29	85.71
176	340.91	170.45	113.64	85.23
177	338.98	169.49	112.99	84.75
178	337.08	168.54	112.36	84.27
179	335.20	167.60	111.73	83.80
180	333.33	166.67	111.11	83.33
181	331.49	165.75	110.50	82.87
182	329.67	164.84	109.89	82.42
183	327.87	163.93	109.29	81.97
184	326.09	163.04	108.70	81.52
185	324.32	162.16	108.11	81.08
186	322.58	161.29	107.53	80.65
187	320.86	160.43	106.95	80.21
188	319.15	159.57	106.38	79.79
189	317.46	158.73	105.82	79.37
190	315.79	157.89	105.26	78.95
191	314.14	157.07	104.71	78.53
192	312.50	156.25	104.17	78.13
193	310.88	155.44	103.63	77.72
194	309.28	154.64	103.09	77.32
195	307.69	153.85	102.56	76.92
196	306.12	153.06	102.04	76.53
197	304.57	152.28	101.52	76.14
198	303.03	151.52	101.01	75.76
199	301.51	150.75	100.50	75.38
200	300.00	150.00	100.00	75.00
201	298.51	149.25	99.50	74.63
202	297.03	148.51	99.01	74.26
203	295.57	147.78	98.52	73.89
204	294.12	147.06	98.04	73.53
205	292.68	146.34	97.56	73.17
206	291.26	145.63	97.09	72.82
207	289.86	144.93	96.62	72.46
208	288.46	144.23	96.15	72.12
BPM	1/4 NOTE	1/8th NOTE	1/8 TRIPLET	1/16th NOTE
209	287.08	143.54	95.69	71.77
210	285.71	142.86	95.24	71.43
211	284.36	142.18	94.79	71.09

212	283.02	141.51	94.34	70.75
213	281.69	140.85	93.90	70.42
214	280.37	140.19	93.46	70.09
215	279.07	139.53	93.02	69.77
216	277.78	138.89	92.59	69.44
217	276.50	138.25	92.17	69.12
218	275.23	137.61	91.74	68.81
219	273.97	136.99	91.32	68.49
220	272.73	136.36	90.91	68.18
221	271.49	135.75	90.50	67.87
222	270.27	135.14	90.09	67.57
223	269.06	134.53	89.69	67.26
224	267.86	133.93	89.29	66.96
225	266.67	133.33	88.89	66.67
226	265.49	132.74	88.50	66.37
227	264.32	132.16	88.11	66.08
228	263.16	131.58	87.72	65.79
229	262.01	131.00	87.34	65.50
230	260.87	130.43	86.96	65.22
231	259.74	129.87	86.58	64.94
232	258.62	129.31	86.21	64.66
233	257.51	128.76	85.84	64.38
234	256.41	128.21	85.47	64.10
235	255.32	127.66	85.11	63.83
236	254.24	127.12	84.75	63.56
237	253.16	126.58	84.39	63.29
238	252.10	126.05	84.03	63.03
239	251.05	125.52	83.68	62.76
240	250.00	125.00	83.33	62.50
241	248.96	124.48	82.99	62.24
242	247.93	123.97	82.64	61.98
243	246.91	123.46	82.30	61.73
244	245.90	122.95	81.97	61.48
245	244.90	122.45	81.63	61.22
246	243.90	121.95	81.30	60.98
247	242.91	121.46	80.97	60.73
248	241.94	120.97	80.65	60.48
249	240.96	120.48	80.32	60.24
250	240.00	120.00	80.00	60.00

**Tip:** Assign a controller to modulate the effect delay times, and select a specified minimum and maximum range so that you can create unique poly-rhythms in real-time.

# Section 18 — Audio Track Applications

---

## Using a Microphone with the ASR-10

Because the Audio Tracks allow continuous audio monitoring of the stereo Audio Inputs, you can sing along (through effects if desired) while playing the ASR-10 keyboard. Here's how:

- Load in the Instruments that you want to use (to sing along with) by pressing **Load**, then **Instrument**, then scrolling through the files with the **Up/Down Arrow** buttons.
- Press **Enter•Yes** and the appropriate **Instrument•Sequence Track** button to load the currently viewed Instrument/Bank file into the internal memory. See *Section 1 — Controls and Architecture* for more information about loading files.
- Plug the microphone into the left Audio Input jack on the rear panel.
- Set the Mic/Line switch in the up (mic) position.
- On the front panel of the ASR-10, press the **Sample•Source Select** button. The display shows the record source screen:

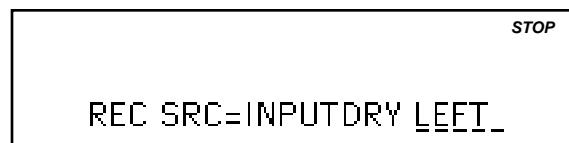

The record source value defaults to exactly what we want. You may have noticed when you pressed **Sample•Source Select** that the left Audio Track yellow LED turned on. When lit, it indicates that the track is selected.

- Press the left **Audio Track** button so that the red LED is lit. You should now be hearing the microphone signal through the ASR-10.
- Adjust the Input Level control (on the rear panel) so that the signal is present (green Input Level LED lit) but only peaks occasionally (red Input Level LED lit). Remember, the red Input Level LED lights at 6dB below clipping.
- At this point, you can play different sounds (by pressing their **Instrument•Sequence Track** buttons) while singing along with the ASR-10, all without the use of an external mixer.

## Using a Guitar with a Sequence or Song

Using a guitar (or any line level signal) is almost identical to using a microphone, but with different input level settings. The Audio Tracks allow you to play along (through effects if desired) with the ASR-10 sequencer. Here's how:

- Load in the Instruments that you want to use by pressing **Load**, then **Instrument**, then scrolling through the files with the **Up/Down Arrow** buttons.
- Press **Enter•Yes** and the appropriate **Instrument•Sequence Track** button to load the currently viewed Instrument/Bank file into the internal memory.
- Load in the Sequences or Song that you want to use (to play along with) by pressing **Load**, then **Seq•Song**, then scrolling through the files with the **Up/Down Arrow** buttons.
- Press **Enter•Yes** to load the currently viewed Sequence/Song file into the internal memory. These may be single sequence files or a complete song file consisting of many sequences (a song may also be loaded as part of a bank file).
- Plug the guitar (or any line level signal) into the left Audio Input jack on the rear panel.
- Set the Mic/Line switch in the down (line) position.

- Press the **Sample•Source Select** button. The display shows the record source screen:

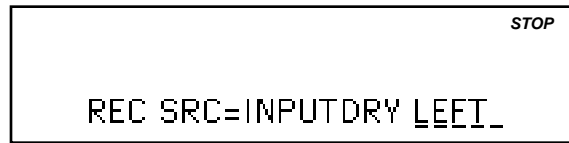

The record source value defaults to exactly what we want. You may have noticed when you pressed **Sample•Source Select** that the left Audio Track yellow LED turned on. When lit, it indicates that the track is selected.

- Press the left **Audio Track** button (red LED lit). You should now be hearing the guitar (or other line level signal) signal though the ASR-10.
- Adjust the Input Level control (on the rear panel) so that the signal is present (green Input Level LED lit) but only peaks occasionally (red Input Level LED lit). Remember, the red Input Level LED lights at 6dB below clipping.
- At this point, you can play sequences or songs (by pressing the **Play** button) while playing your guitar (or other line level signal) along with the ASR-10.

## Assigning Different Output Routings

When using the Audio Tracks with an effect, you can assign different output routings for each Audio Track, as well as for each **Instrument•Sequence Track**. For instance, lets say you have a sequence/song with a drum kit, bass, piano, and a horn section on **Instrument•Sequence Tracks 1, 2, 3, and 4** respectively, and a microphone signal plugged into **Audio Track A**. For this example, we'll be using **FX=ROM-10 CHOR+REV+DDL**. By assigning different outputs, you can route:

- the drum kit through reverb
- the bass through the chorus and reverb
- the piano through the delay line
- the horn section dry, without any effect processing
- the microphone through just the reverb

You can see that by assigning different output routings, you can create different effect variations. Here's how to set up the above scenario:

- Load a drum kit onto **Instrument•Sequence Track 1**.
- Load a bass onto **Instrument•Sequence Track 2**.
- Load a piano onto **Instrument•Sequence Track 3**.
- Load a horn section onto **Instrument•Sequence Track 4**.
- Load in any song or sequences that you may want to use (to play or sing along with) by pressing **Load**, then **Seq•Song**, then scrolling through the files with the **Up/Down Arrow** buttons.
- Press **Enter•Yes** to load the currently viewed **Seq•Song** file into the internal memory.
- When using a microphone, we recommend plugging it into a mixer or preamp, and sending a line from the mixer/preamp to the Left Audio Input jack, for optimal performance.
- On the front panel of the ASR-10, press the **Sample•Source Select** button. The display shows the record source screen:

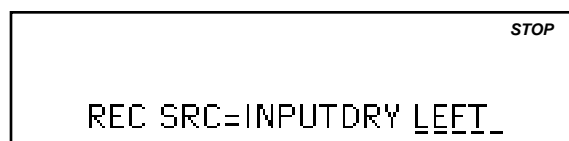

- Press the left **Audio Track** button so that the red LED is lit. You should now be hearing the microphone signal through the ASR-10.
- Adjust the Input Level control (on the rear panel) so that the signal is present (green Input Level LED lit) but only peaks occasionally (red Input Level LED lit). Remember, the red Input Level LED lights at 6dB below clipping.
- Press the **FX Select • FX Bypass** button and use the **Up/Down Arrow** buttons to select **FX=ROM-10 CHOR+REV+DDL**. The display shows:

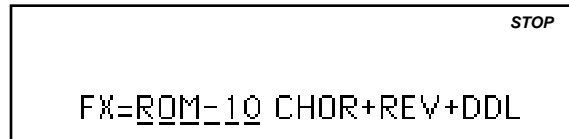

- Press **Edit**, then **Effects**. The display shows the Effect variations screen for the Chorus+Reverb+Delay effect. You can select different parameters for editing by scrolling with the **Left/Right Arrow** buttons, and changing the values with the **Up/Down Arrow** buttons. Remember, as soon as you change a value, or edit any parameter, the ROM effect becomes the Bank effect.

Once you've edited the effect for your particular application, you can assign different output routings (you can still go back and edit the effect parameters after you've assigned the output routings). To assign the output routings:

- Select **Instrument • Sequence Track 1** (the drum kit). The LED for **Instrument • Sequence Track 1** is solidly lit yellow.
- Press **Edit**, then **Track**. Using the **Left/Right Arrow** buttons, scroll until the display shows **OUT=** (output name). With the **Up/Down Arrow** buttons, select **OUT= BUS2 JUST REVERB**.
- Select **Instrument • Sequence Track 2** (the bass). You should still be on the **Edit/Track OUT=** screen. Notice that the **Instrument • Sequence Track 2** LED is solidly lit yellow.
- With the **Up/Down Arrow** buttons, select **OUT= BUS1 CHORUS+REVRB**.
- Select **Instrument • Sequence Track 3** (the piano). You should still be on the **Edit/Track OUT=** screen. Notice that the **Instrument • Sequence Track 3** LED is solidly lit yellow.
- With the **Up/Down Arrow** buttons, select **OUT= BUS3 DELAY LINE**.
- Select **Instrument • Sequence Track 4** (the horn section). You should still be on the **Edit/Track OUT=** screen. Notice that the **Instrument • Sequence Track 4** LED is solidly lit yellow.
- With the **Up/Down Arrow** buttons, select **OUT= AUX 1**. This will send the audio output of the Horn Section *only* to the AUX 1 Output jacks, and not to the Main Outputs. The output of the AUX jacks is always dry, and can be connected to an additional external effects processor, like the ENSONIQ DP/4, for instance.
- Select **Audio Track A** (the microphone). Although you have now selected an Audio Track, you should still see its **Edit/Track OUT=** screen. The **Audio Track A** yellow LED is solidly lit. Notice that the last selected **Instrument • Sequence Track** LED is flashing. This indicates that it can still be played from the keyboard, but is no longer selected for editing.
- With the **Up/Down Arrow** buttons, select **OUT= BUS2 JUST REVERB**.
- Press the **Load** button, to return to solid Load mode.

Now in solid Load mode, when you play the instruments, sing in the microphone, or play a song or sequence, you can hear how the effect routings affect each sound differently.



## An Audio Track Tutorial

Before beginning this tutorial, make certain that any Instruments or sequences that you might want to save have been backed up to floppy (or a SCSI storage device).

### Load the Audio Track Tutorial Bank and Play the Song

1. Insert the disk "ENSONIQ ASR-10 Operating System Version 2 (or higher)" into the ASR-10 floppy drive.
2. Press the Load button.
3. Press the **Instrument** button.
4. Use the **Up/Down Arrow** buttons to locate the "FILE 11 ATRK TUT BNK" Bank file.
5. With the BANK indicator lit (in the upper left of the display) and the display reading FILE 11 ATRK TUT BNK, press the **Enter•Yes** button.

The ASR-10 will begin to load Instruments into various **Instrument•Sequence Track** locations. Once loading has completed, the display will read BANK LOAD COMPLETED.

6. Press the **Play** button.

You will hear ATRK TUT SNG, which is based on the classic 12-bar blues pattern. Later in this tutorial, you will be using a sequence from within this song to record your first RAMTrack. When the song reaches the end, it will automatically stop. If you want to stop listening to the song sooner, you can hit the **Stop•Continue** button, located immediately to the left of the **Play** button.

### Select the Sequence for Recording

1. Press **Edit**, then the **Seq•Song** button. The name of the song (ATRK TUT SNG) should be underlined.
2. Press the **Up** or **Down Arrow** button to select the sequence named "ATRK BLUES." This is the sequence that we'll be using to record the first RAMTrack. You can listen to this sequence by pressing **Play**. Notice that the sequence repeats after 12 bars, because **Edit/Seq•Song**, **LOOP=ON**. This allows you to continually practice your part (after basic set-up) as the sequence plays, until you're ready to record.
3. Press the **Stop•Continue** button to stop the sequence.

### Set-up for Recording a RAMTrack

1. Plug a guitar or microphone with a 1/4" phone plug into the jack marked **Audio Input A/Left** on the rear panel.
2. Press the **Audio Track A** button. The yellow Selected LED above the button will light. This indicates that Audio Track A is selected for editing.
3. Press the **Audio Track A** button again. The red Source-Monitor LED will light. This indicates that the Audio Track is active or Source Monitor enabled and can be used to listen to incoming audio from the corresponding rear panel Audio Input. The Left Audio Input corresponds to Audio Track A and the Right Audio Input corresponds to Audio Track B.

To select an Audio Track, press its button:

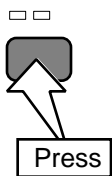

Its yellow Selected LED will light (solidly):



Press the Audio Track button again and the red Source Monitor LED will light:



#### Note:

The rack-mount ASR-10 LED and button placement is different than the keyboard ASR-10, but the functionality is identical.

4. If you do not hear audio when using a microphone, flip the **Mic/Line Switch** on the rear panel of the ASR-10 up to the Mic position. You should now be able to hear the signal. However, it may still be a bit too loud or soft.

**Tip:** You can overload the analog mic pre-amp by setting the **Mic/Line switch** to Mic for a line-level signal source. This creates a fabulous analog distortion for guitar (or whatever) without using the effects processor. Then use the effects processor to add chorus, reverb, or any other effect to the analog distortion. This can then be sampled or recorded to Audio Tracks, or you can just play along with sequences.

5. To further adjust the volume, turn the **Input Level Trim Control** knob on the rear panel of the unit until the signal just begins to light the red Signal/Peak indicator.  
The **Input Level Trim Control** knob increases the signal level when turned clockwise and decreases the signal level when turned counter-clockwise (as viewed when facing the rear panel).
6. Test your guitar or microphone.  
Depending on the output level of your source, you may or may not hear signal coming through the ASR-10. The left pair of Signal/Peak Input Level indicators will light when a signal is present (green indicates a signal is detected, and red indicates the signal has reached 6 dB below the point of overload). You should see these indicators light when you hear audio.

### Play Along with the Sequence

Now that you are set up for recording a RAMTrack, you may want to have a “practice run” to play or sing along with the sequence before recording.

1. Make sure the Left Audio Track's yellow and red LEDs are still lit. If not, press the **Audio Track A** button until they are lit.
2. Press the **Play** button.  
You will now hear the ATRK BLUES sequence, based on the classic 12-bar blues pattern, and you can play/sing along with it for as long as you want.
3. Press **Stop•Continue** to stop the sequence.

### Record Your First RAMTrack

When you are finished practicing, it's time to record:

1. Make sure the Left Audio Track's yellow and red LEDs are still lit. If not, press the **Audio Track A** button until they light (if the yellow LED is not lit, you will not be recording an Audio Track).
2. While holding down the **Record** button, press **Play**.  
There will be a four bar countoff, followed by the sequence named “ATRK BLUES.”
3. Play your guitar along with the sequence, or “sing the blues” in your microphone. Here's some typical “blues lyrics”:  
My baby done left me  
I sure do got the blues  
My dog died yesterday (substitute the animal of your choice; i.e. My llama died yesterday)  
I sure do got the blues  
I'm feeling so low  
I sure do got the blues

### Audition Your RAMTrack Recording

When the sequence is finished, (or you run out of memory) the display shows:



This is the Audition page. The ASR-10 has always let you compare between the OLD (original) part and the NEW part when performing any recording or track command. This is also true for RAMTracks and DiskTracks. Notice that you are now listening to your newly recorded RAMTrack.

1. If you want to hear the OLD track (in this case, no Audio Track recorded), press the **Left Arrow** button to select (underline) KEEP=OLD.  
You will now be hearing the original sequence without the Audio Track recording.
2. Use the **Stop•Continue** and **Left** and **Right Arrow** buttons to select whether to keep the newly recorded track or not. If you do not like your RAMTrack performance, select KEEP=OLD, press **Enter•Yes**, and re-record the RAMTrack.
3. When you've recorded an acceptable performance, select KEEP=NEW and press the **Enter•Yes** button.

You'll briefly see . . .EDITING . . . on the display. Then you'll be returned to the Sequence Select/GOTO page. By pressing the **Enter•Yes** button while NEW was underlined on the Audition page, you have chosen to keep your newly created part.

### Press Play and Enjoy!

You can listen to your performance by pressing **Play**. You have just successfully recorded a RAMTrack! Pretty easy, huh?

### Master Directly to DAT

These Audio Tracks were digitally recorded using the 44.1 kHz sample rate because the current effect is a 44.1 kHz algorithm. With the optional DI-10 Digital I/O Interface installed, you could record your entire performance directly from the ASR-10's Digital I/O output to a any DAT recorder (or other digital audio recording device) equipped with a compatible digital input. Consult the DI-10 Operation Manual for more details on using the DI-10 Digital I/O Interface.

### Save your Work

If you want to save this performance to floppy disk, use the **Command/Seq•Song**, SAVE SONG + ALL SEQs command, followed by the **Command/Instrument**, SAVE BANK command.

### Using the SAVE SONG + ALL SEQs Command

Once you have created a song or made changes to an existing one, you can save the song to a formatted ASR-10 disk. In addition to saving the song itself, the SAVE SONG + ALL SEQs command saves all the individual sequences currently in memory (whether they are part of the song or not). Audio Track recording data is also stored with the SONG + ALL SEQs file type. Because the SONG + ALL SEQs file saves your Audio Track recording data, it is sometimes referred to as the Project file. Note that a SONG + ALL SEQs file that is to be saved after a large amount of RAMTrack data has been recorded will increase in size significantly and may need to be saved across multiple disks. Be prepared with a few extra floppy disks for this task. To save a song:

1. Insert a formatted disk into the drive.
2. Press **Command**, then press **Seq • Song**.
3. Press the **Left** or **Right Arrow** button until the display reads:

```

CMD SEQ          SONG          STOP
SAVE SONG + ALL SEQs
  
```

4. Press **Enter • Yes**.
5. Edit the song name (optional):

```

CMD SEQ          SONG          STOP
NEW NAME=ATRK TUT SNG
  
```

The display shows the current name of the song with a cursor (underline) beneath the first character. If you want to give the song a new name, use the Data Entry Controls (see the ASR-10 Musician's Manual for details).

6. Press **Enter • Yes**.

The display will flash SHUFFLING DATA as the ASR-10 prepares to save the file to disk.

```

CMD SEQ          SONG          STOP
SHUFFLING DATA
  
```

### **Caution:**

Saving a SONG + ALL SEQs (Project) file to disk will take longer than in previous O.S. versions. The SHUFFLING DATA message will be displayed before saving, perhaps for several minutes. This happens because the ASR-10 must manage the Audio Track data that is stored with the SONG + ALL SEQs (Project) file. The more AudioSamples you have recorded, the longer it will take.

7. If the SONG + ALL SEQs file will be saving RAMTracks, the display will usually ask:

```

CMD SEQ          SONG          STOP
USE MULTIPLE DISKS?
  
```

**8. Press Enter•Yes.**

The display shows SAVING <SONG NAME> while the song is being saved.

- If there is already a song file with the same name on the disk, the display will ask DELETE OLD VERSION? Press **Enter•Yes** to save the song, replacing the one on the disk. This is for updating songs to which you have made changes. Or press **Cancel•No** to abort the procedure.
- If there is not enough free space on the disk, the display will show:

```

  CMD/SEQ                SONG                STOP
  INSERT DISK-HIT ENTER

```

At this point, press the **Eject** button on the disk drive, remove the disk, insert the next ASR-10 formatted disk into the drive, and press **Enter•Yes**. You may need to repeat this step several times, depending on the size and amount of the RAMTracks.

9. When the SONG + ALL SEQS file is finished being saved, the display will show COMMAND COMPLETED, then return to the SAVE SONG + ALL SEQS command page.

### About Saving the Bank

Use the SAVE BANK command to save the current Bank. Banks provide a way to load a whole group of Instruments, song and sequences, and Audio Track recording data into the ASR-10 with a few button presses. When you save a Bank to disk, it is like taking a “snapshot” of the contents of the ASR-10 internal memory. The Bank file stores the following information:

- Which Instrument files are loaded into each **Instrument•Sequence Track** location.
- Which SONG + ALL SEQs file is loaded into the internal memory. This includes all Audio Track recording data.
- Up to eight discrete Performance Presets.
- The Bank Effect and its parameter settings.
- The **Edit/(seq) Track MIX, PAN, OUT, and EFFECT MOD CONTROL** setting for each **Instrument•Sequence Track**.

### Saving the Bank:

1. Insert one of your own ASR-10 formatted disks (you should not save any of your own files to the Version 2 O.S. disk.)
2. Press **Command**, then **Instrument**, and use the Data Entry Controls to select the SAVE BANK command.
3. Press **Enter•Yes**. The display shows:

```

INST                                SONG                                STOP
CMD
BANK NAME=ATRAK TUT BNK

```

The display shows the current Bank name with a cursor (underline) beneath the first character. If you want to rename the Bank, use the **Data Entry Controls**.

If you are updating an existing Bank, and you didn't rename the Bank, pressing **Enter•Yes** will show the following screen:

```

INST                                SONG                                STOP
CMD
DELETE OLD VERSION?

```

4. Press **Enter•Yes**. The display shows SHUFFLING DATA, then COMMAND COMPLETED, and returns to the SAVE BANK command page.

**Note:** It's not necessary for the Instrument files and SONG + ALL SEQs file to be saved on the same disk as the Bank. Each file can be saved on separate disks, but make sure the disks are labeled with a *unique* disk label (see the WRITE DISK LABEL command found on the **Command/System•MIDI** page) so that the Bank knows which disk the files are saved on, and can locate the information properly.

You have just successfully recorded and saved a RAMTrack!

# Appendix

## 44 kHz Effect Descriptions and Variations

Version 2 Operating System contains 12 additional 44 kHz effect algorithms specially designed for the ASR-10. This section will:

- provide the name of each effect as it appears on the display (shown inside the black header),
- list the available preprogrammed variations (shown immediately below the effect name),
- describe the effect,
- show the signal routing diagram (if applicable), and
- list the names of parameters that you can adjust.

At the end of the section is an alphabetized list of all the parameters and what they do.

### 44LUSH PLATE

1 LUSH REVERB	2 STANDARD REVERB	3 MEDIUM REVERB	4 LONG REVERB
---------------	-------------------	-----------------	---------------

### 44LUSH PLAT2

1 LUSH REVERB	2 STANDARD REVERB	3 MEDIUM REVERB	4 LONG REVERB
---------------	-------------------	-----------------	---------------

### 44PERC PLATE

1 AMBIENT REVERB	2 SLAP REVERB	3 SHORT REVERB	4 PERC REVERB
------------------	---------------	----------------	---------------

A plate reverb takes the vibrations from a metal plate and uses them to create a metallic-sounding reverb. 44LUSH PLATE is a 44 kHz small plate reverb offering early reflections; 44LUSH PLAT2 is a larger 44 kHz plate reverb effect; 44PERC PLATE is a 44 kHz plate reverb optimized for drum and percussion sounds. In general, small plate reverbs are used for drums and percussion, while large plate reverbs are used to enhance a vocalist's performance.

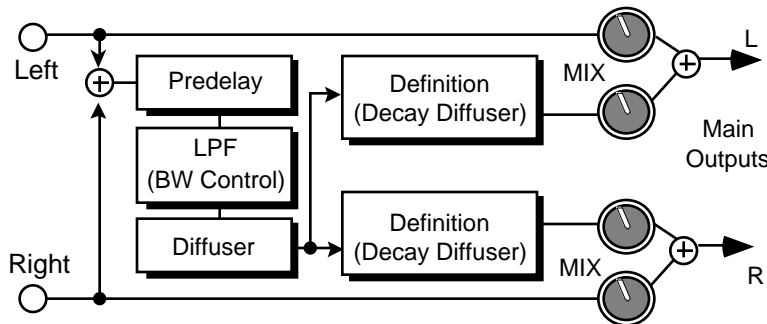

**Reverb Signal Routing (applies to all plate reverb effects)**

DECAY TIME	DEPTH
PREDELAY TIME	DEFINITION
HF DAMPING	DIFFUSION (1 & 2)
BW (bandwidth)	ER TIME (L & R) * not available within 44LUSH PLAT2
DETUNE RATE	ER LEVEL (L & R) * not available within 44LUSH PLAT2

**Reverb Parameters (apply to all plate reverb effects, except where noted)**

**44EQ+DDL**

1 LEFT RIGHT CENTR

2 SLAP ECHOES

3 WHEEL ECHO

4 RHYTHMIC ECHOES

44EQ+DDL combines a 44 kHz parametric EQ with a digital delay.

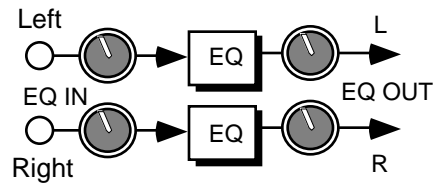

**EQ Routing**

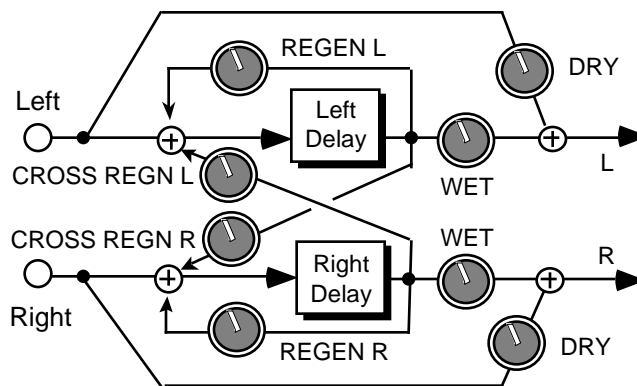

**Digital Delay Routing**

EQ IN	MID BW
OUT	ECHO WET
GAIN BASS	DRY
TREB	ECHOTIME (L & R)
MID	ECHO REGEN (L & R)
GAIN	CROSS REGN (L & R)

**44EQ+DDL Parameters**



**44DDL+CH+REV**

1 SWIRLING CHORUS

2 DDL+SLOW CHORUS

3 FLANGED CHORUS

4 WARM CHORUS

44 kHz digital delay with a three-voice chorus and reverb. Because this is a hi-fidelity 44 kHz effect algorithm, BUS2 and BUS3 are dry. The reverb routing is the same as in the plate reverbs.

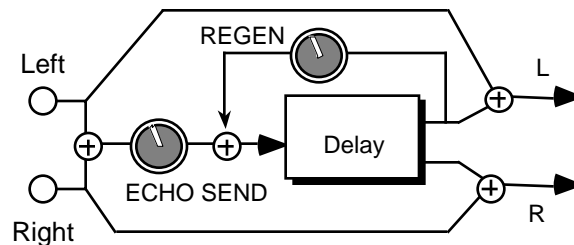
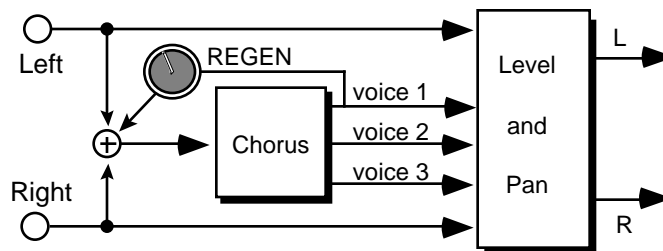
**Digital Delay Routing****Three-Voice Chorus Routing**

REVERB MIX	DECAY TIME
ECHO SEND	PREDELAY TIME
REGEN	HF DAMPING
ECHOTIME (L & R)	BW
CH RATE	DEFINITION
REGEN	DIFFUSION
CH DRY LEV	
PAN	<b>EXPERT PARAMS</b>
CH WET LEV (1 to 3)	FDBK T
CH WET PAN (1 to 3)	TIME L
CH LFORATE (1 to 3)	TIME R
CH WIDTH (1 to 3)	GAIN L
CH DELAY (1 to 3)	GAIN R

**44DDL+CH+REV Parameters**

**44DDL+CHORUS**

1 PING PONG CHORUS

2 FAT CHORUS

3 ORGAN VIBRATO

4 CLOCKWORK PIANO

Combines a 44 kHz six-voice chorus (three left and three right) with a reverb. Because this is a hi-fidelity 44 kHz effect algorithm, BUS2 and BUS3 are dry. The digital delay routing is the same as found in 44DDL+CH+REV.

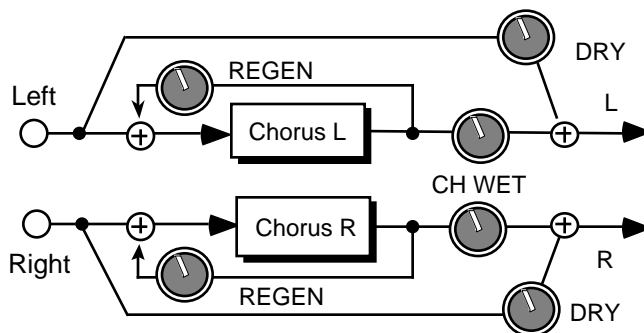
**Six-Voice Chorus Routing**

ECHO LEV	CH RATE
REGEN	REGEN
ECHOTIME (L & R)	CH LFO SPREAD
CH WET	CH WIDTH
DRY	DELAY

**44DDL+CHORUS Parameters**

### 44DLYLFO+REV

1 PING PONG CHORUS	2 SIDE TO SIDE	3 DETUNER	4 WHEEL WOW
--------------------	----------------	-----------	-------------

Combines a 44 kHz digital delay that provides LFO modulation with a chorus effect. The reverb routing is the same as in the plate reverbs.

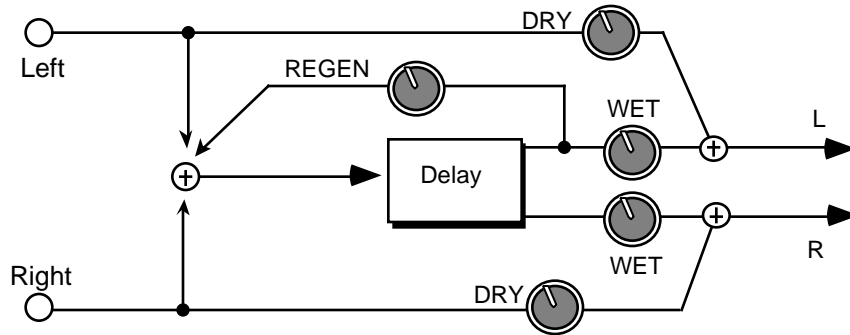

**Delay LFO Routing**

REVERB MIX	BW
DL WET	DEFINITION
DRY	DIFFUSION (1 & 2)
DL RATE	
REGEN	<b>EXPERT PARAMS</b>
DL WIDTH (L & R)	FDBK T
DL DELAY (L & R)	TIME L
DECAY TIME	TIME R
PREDELAY TIME	GAIN L
HF DAMPING	GAIN R

**44DLYLFO+REV**

**44EQ+DDL+CHO**

1 SWIRLING CHORUS	2 DDL+SLOW CHORUS	3 FLANGED CHORUS	4 WARM CHORUS
-------------------	-------------------	------------------	---------------

This 44 kHz algorithm combines a parametric EQ with a digital delay and a chorus effect. The EQ routing is the same as in 44EQ+DDL. The digital delay routing is the same as in 44DDL+CH+REV. The chorus routing is the same as in 44DDL+CH+REV.

EQ IN	REGEN
OUT	CH DRY LEV
EQ FREQ	PAN
GAIN	CH WET LEV (1 to 3)
EQ BW	CH WET PAN (1 to 3)
ECHO LEV	CH LFORATE (1 to 3)
REGEN	CH WIDTH (1 to 3)
ECHOTIME (L & R)	DELAY (1 to 3)
CH RATE	

**44EQ+DDL+CHO Parameters****44PARAM EQ**

1 LA CURVE	2 HYPED VOCALS	3 BASS BOOST	4 ASR SWEETENER
------------	----------------	--------------	-----------------

44PARAM EQ offers a 44 kHz minimum phase three band parametric EQ. The EQ routing is the same as in 44EQ+DDL.

BASS FC	MID Q
GAIN	TREBLE FC
MID FC	GAIN
GAIN	INPUT TRIM

**44PARAM EQ Parameters**

**44EQ+REVERB**

1 LUSH REVERB	2 STANDARD REVERB	3 MEDIUM REVERB	4 LONG REVERB
---------------	-------------------	-----------------	---------------

This effect combines a 44 kHz parametric EQ with a reverb. This reverb routing is the same as in the plate reverbs. The EQ routing is the same as in 44EQ+DDL.

REVERB MIX	DEFINITION
EQ IN	DIFFUSION (1 & 2)
OUT	
EQ FREQ	
GAIN	<b>EXPERT PARAMS</b>
EQ BW	FDBK T
DECAY TIME	TIME L
PREDELAY TIME	TIME R
HF DAMPING	GAIN L
BW	GAIN R

**44EQ+REVERB Parameters**

**44ROTO+REVRB**

1 AMBIENT REVERB

2 SLAP REVERB

3 SHORT REVERB

4 PERC REVERB

A 44 kHz rotating speaker simulation with reverb. The reverb routing is the same as in the plate reverbs.

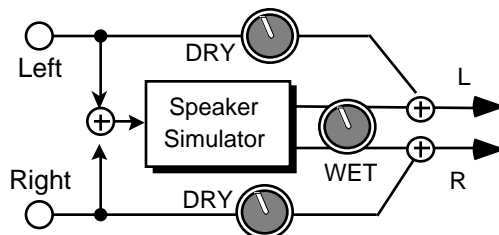
**Rotary Speaker Routing**

REVERB MIX	PREDELAY TIME
SPKR WET	HF DAMPING
DRY	BW
SPEED	DEFINITION
INERTIA	DIFFUSION (1 & 2)
SPEED MIN	
MAX	<b>EXPERT PARAMS</b>
AM MIN	FDBK T
MAX	TIME L
FM MIN	TIME R
MAX	GAIN L
DECAY TIME	GAIN R

**44ROTO+REVRB Parameters**

**44EQ+ROT+DDL**

1 PATCH SELECT

2 MOD WHEEL

3 TREMOLO PATCH

4 VIBRATO PATCH

This 44 kHz effect combines a parametric EQ with a rotating speaker and digital delay. The rotary speaker topology is the same as in 44ROTO+REVRB. The EQ routing is the same as in 44EQ+DDL. The rotary speaker routing is the same as 44ROTO+REVRB. The digital delay routing is the same as in 44EQ+DDL.

EQ IN	MAX
OUT	AM MIN
EQ FREQ	MAX
GAIN	FM MIN
EQ BW	MAX
SPKR WET	ECHO WET
DRY	DRY
SPEED	ECHOTIME (L & R)
INERTIA	ECHO REGEN (L & R)
SPEED MIN	CROSS REGN (L & R)

**44EQ+ROT+DDL Parameters**





- CROSS REGN (L and R)** Ranges: -99 to +99  
Allows you to feed back the echoed signals to their opposite sides. The left voice crosses to the right voice, and the right voice crosses to the left voice. A setting of +99 or -99 will cause infinite delay. Be careful, if the echo regen is set too high, it may cause this parameter to “blow up.”
- DECAY TIME** 44PERC PLATE Range: 0.40 to 1.21  
44LUSH PLATE 1 and 2, 44DDL+CH+REV,  
44DLYLFO+REV, 44EQ+REVERB,  
44ROTO+REVRB Range: 0.40 to 140. sec  
Controls the amount of time it takes for the reverberation to decay. Generally, high values of decay time sound good on plate reverb algorithms.
- DEFINITION** Range: 0 to 99  
Controls the rate at which echo density increases with time. Higher values can cause the echo density to build at a rate that exceeds the decay rate. Try to select the highest value that works with your sound source for the best performance.
- DELAY** 44EQ+DDL+CHO Ranges: 0 to 50  
44DDL+CHORUS Ranges: 0 to 100  
Controls the nominal delay time of the chorus in milliseconds.
- DEPTH** Range: 0 to 99  
This parameter controls the depth of the detuning, that is, how much the pitch will change. Low values yield a metallic sound. Some synth voices sound best with very low values.
- DETUNE RATE** Range: 0 to 99  
This parameter controls the LFO rate of detuning incorporated within the reverb. Detuning introduces a slight pitch shift in the reverberated signal, giving it a more natural-sounding decay by breaking up resonant nodes.
- DIFFUSION (1 & 2)** Ranges: 0 to 99  
Smears the input signal to create a smoother sound. Lower values will cause impulse sounds to appear as a series of discrete echoes, while higher values tend to increase the smear, making the echoes less apparent. The diffusers are in series. Plate reverbs tend to sound metallic, and the diffusers help to smear the signal, eliminating the metallic sound.
- DL DELAY L and R** Ranges: 0 to 400 msec  
Determines the nominal amount of time between the input signal and the delay outputs.
- DL RATE** Range: 0 to 130  
Controls the rate of the LFO (pitch modulation). To achieve a chorusing effect, this rate must be very slow.
- DL WET** Range: -99 to +99  
This parameter controls the volume of the delayed signal only. Setting this parameter to +0 will eliminate the delay portion completely.
- DL WIDTH L and R** Ranges: 0 to 127  
These two parameters control the left and right excursion of pitch modulation. Since the rate is usually very slow, the width is usually large.

**DRY**

44EQ+DDL Range: 0 to 99  
44DDL+CHORUS, 44DLYLFO+REV,  
44ROTO+REVRB, 44EQ+ROT+DDL  
Range: -99 to +99

This parameter allows you to define how much of the signal you want to completely bypass the effect. Setting this parameter to 0 will eliminate the dry signal. By setting this parameter to 99 and the WET parameter to 0, you can assign voices to be completely dry. Negative values will reverse the polarity, offering a tonal variation. Note that for 44ROTO+REVRB and 44EQ+ROT+DDL, you can simulate the typical "leakage" of a rotary speaker by setting the DRY parameter to approximately half of the SPKR WET value. This offers the best rotating effect at a slow speed.

**ECHOTIME L and R**

44DDL+CHORUS Ranges: 0 to 1000 msec  
44EQ+ROT+DDL Ranges: 0 to 700 msec

Sets the amount of delay time for the independent delays. Each value increases the delay time by 1 millisecond. Experiment with different settings to find the right mix for your sound source and application.

**ECHO LEV**

Range: 0 to 99

Adjusts the volume of the delayed signals against the original dry signal. A level of 0 will offer no audible delay.

**ECHO REGEN (L and R)**

Ranges: -99 to +99

Determines the amount of signal that will be fed from the output of the delay back into the input, increasing the number of repeats in the delay. A setting of 99 would offer an infinite delay. The sign of the value determines the polarity of the regen (regeneration).

**ECHO SEND**

Range: 00 to 99

Controls the amount of delay being sent into the chorus. A setting of 0 would offer no delay.

**ECHOTIME (L and R)**

44EQ+DDL Ranges: 0 to 700 msec  
44DDL+CH+REV Ranges: 0 to 500 msec  
44EQ+DDL+CHO Ranges: 0 to 1400 msec

These parameters control the delay times for the left and right echoes. Each value increases the delay time by 1 millisecond. Experiment with different settings to find the right mix for your sound source and application.

**ECHO WET**

Range: 0 to 99

This parameter controls the volume of the echoed signal only. Setting this parameter to 0 will eliminate the echo portion completely.

**EQ BW**

Range: 0 to 20K

This parameter is a bandwidth control that determines the width of the resonant peak at the mid-frequency band. By lowering the value, you can produce a narrower bandwidth.

**EQ FREQ**

Range: 0 to 20000

Sets the center of the mid-frequency parametric.

**EQ IN**

Range: -99 to +48 dB

Allows you to adjust the input level trim to the EQs to eliminate the possibility of clipping boosted signals.



- MID** Range: 0 to 20000  
Sets the center of the mid-frequency parametric.
- MID BW** Range: 0 to 20K  
This parameter is a bandwidth control that determines the width of the resonant peak at the mid-frequency band. By lowering the value, you can produce a narrower bandwidth.
- MID FC** Range: 0 to 9999 Hz  
Sets the center of the mid-frequency parametric.
- MID Q** Range: 1 to 18  
This parameter is a bandwidth control that determines the width of the resonant peak at the center-frequency band. By raising the value you can produce a narrower bandwidth.
- OUT** Range: -99 to +48 dB  
Adjusts the output volume after the parametric EQ. With the LEVEL, GAIN BASS, and TREBLE LEVEL set to high values, the OUTPUT parameter could be used to create a raspy distortion effect. Negative values will decrease the output volume.
- PAN** Range: -99 to +99  
Determines the location of the dry signal in the stereo spectrum. A value of -99 is panned hard left, and +99 is hard right.
- PREDELAY TIME** Plate Range: 0 to 300 msec  
44EQ+DDL, 44DDL+CH+REV, 44DLYLFO+REV,  
44EQ+REVERB, 44ROTO+REVRB Range: 0 to 150 msec  
Controls the amount of time it takes for the input signal to be presented to the reverb. A value of 0 would offer no delay. The range is based in milliseconds.
- REGEN** Range: -99 to +99  
Determines the amount of signal that will be fed from the output of the left delay back into the input, increasing the number of repeats in the delay. A setting of 99 would offer an infinite delay.
- REGEN (Chorus)** Range: -99 to +99  
Controls the amount of feedback applied to the chorus. The sign of the value determines the polarity of the feedback. Feedback accentuates the complexity of the "swept" signal.
- REGEN (Delay)** Range: -99 to +99  
Determines the amount of signal that will be fed from the output of the delay back into the input, increasing the number of repeats in the delay. The sign of the value determines the polarity of the regen.
- REVERB MIX** Range: 0 to 99  
This parameter controls the Dry/Wet mix of the Reverb. A setting of 0 offers no reverb.

**SPEED**

Range: MIN or MAX

Determines how the rotary speaker will switch between slow and fast speeds. The behavior of the switch accurately reflects an actual rotary speaker, taking time to speed up or slow down, based on the value of the INERTIA parameter (see INERTIA description). Any effect modulator can act as the SPEED controller. How the modulators will switch the rotor speed fall into two categories:

- PATCH, FTSW2, SUSTN — These modulation sources toggle the rotor speed between MIN and MAX. Every time the modulation source moves from zero in a positive direction, the rotating speaker effect changes speeds from MIN to MAX or MAX to MIN.
- KEYDN, VEL, KBD, XCTRL, PEDAL, PRESS, PBEND, WHEEL — These modulation sources act like a switch to turn the fast rotor speed on or off. To reverse the polarity of the switch, set SPEED MIN faster than MAX.

**SPEED MIN**

Range: 0 to 130

Determines the rate of the rotary speaker when in the “MIN” setting. SPEED MIN determines the manual level for the rotary speaker rate when SPEED=MIN, or when the selected modulator is at zero output level. Again, the higher the value, the faster the rate.

**SPKR WET**

Range: -99 to +99

This parameter controls the volume of the rotating speaker only. Setting this parameter to +0 will eliminate the rotating speaker portion completely.

**TREB**

Range: -99 to +48 dB

Sets the treble amount of boost or cut applied to a 10 to 22K high-shelving filter.

**TREBLE FC**

Range: 1 to 20 KHz

Sets the center-frequency of the high-frequency parametric.

**Additional Effect Parameters****EXPERT PARAMS**

The following parameters, designed for the professional sound engineer, offer a high degree of programmable editing.

**FDBK T**

Ranges: 0 to 127

These four feedback time parameters control the “size” of the reverb (like early reflections). 1 and 3 are generally short, and 2 and 4 are long.

**GAIN L**

Ranges: -99 to +99

These four parameters control the output volume of the four left taps.

**GAIN R**

Ranges: -99 to +99

These four parameters control the output volume of the four right taps.

**TIME L**

Ranges: 0 to 127

These parameters set four output tap positions (early reflections) for the left side within the reverb. Higher numbers create a more delayed early reflection.

**TIME R**

Ranges: 0 to 127

These parameters set four output tap positions (early reflections) for the right side within the reverb. Higher numbers create a more delayed early reflection.

## ASR-10 MIDI Implementation

The ASR-10 features an extensive MIDI (Musical Instrument Digital Interface) implementation. For normal applications, you will find all the information you need regarding the ASR-10's MIDI functions in this manual. You can also refer to the MIDI Implementation Chart on the next page for a summary of the ASR-10 MIDI implementation.

If you are writing a computer program to communicate with the ASR-10 via MIDI, or otherwise require a copy of the full ASR-10 System Exclusive Specification, it is available free of charge by writing to:

ENSONIQ Corp  
MIDI Specification Desk  
155 Great Valley Parkway  
P.O. Box 3035  
Malvern PA 19355-0735  
USA

Include in your written request your name and address, and indicate that you would like a copy of the "ASR-10 System Exclusive Specification." Please allow 2 to 3 weeks for delivery.

## Registered Parameters

Registered parameters are transmitted (as four sequential continuous controller messages) by the ASR-10 whenever certain parameters are edited from the front panel. The two registered parameter controllers select the parameter and the following two data entry controllers specify the value.

### Controllers

<i>Number</i>	<i>Name</i>	<i>Value</i>
100	Registered Parameter Select LSB	00 or 01
101	Registered Parameter Select MSB	always 0
6	Data Entry MSB (Most Significant Byte)	(see below)
38	Data Entry LSB (Least Significant Byte)	(see below)

### Registered Parameters

<i>Number</i>	<i>Name</i>	<i>ASR-10 parameter range</i>
00	Pitch Bend Range	0..12
01	Master Tuning (Fine)	0..255 (displayed -99..+99)

The parameter values are sent as two Data Entry controller messages:

<i>Parameter</i>	<i>Data Entry MSB (6)</i>	<i>Data Entry LSB (38)</i>
Pitch Bend Range	0..12	0
Master Tune	0..127 (internal bits 1..7)	64 or 0 (internal bit 0)

For Master Tune, which is an 8-bit value internally, the most significant 7 bits are offset by 64 and shifted once before being sent as Data Entry MSB (Controller 6). The least significant bit of the internal value is transmitted as bit 6 of Data Entry LSB (Controller 38).

MODEL: ASR-10

## MIDI Implementation Chart

Version: 2

Function...		Transmitted	Recognized	Remarks
<b>Basic Channel</b>	<b>Default Channels</b>	1 1-16	1 1-16	
<b>Mode</b>	<b>Default Messages Altered</b>	1 X X	1, 3, 4, MULTI X X	current mode is memorized Global Controllers in MONO Mode
<b>Note Number</b>	<b>True Voice</b>	21-108	21-108	
<b>Velocity</b>	<b>Note ON Note OFF</b>	O X <sup>1</sup>	O X	<sup>1</sup> A Note Off velocity of 64 is always sent for all keys.
<b>After Touch</b>	<b>Key Channel</b>	O O	O O	PolyKey pressure
<b>Pitch Bender</b>		O	O	
<b>Control Change</b>		1 Mod Wheel 4 Foot (Pedal) 6 Data Entry MSB <sup>2</sup> 7 Volume 38 Data Entry LSB <sup>2</sup> 64 Sustain 70 Sound Variation <sup>3</sup> 100 Reg. Param. Select LSB <sup>4</sup> 101 Reg. Param. Select MSB <sup>5</sup>	1-95 External Controller 1 Mod Wheel 4 Foot (Pedal) 6 Data Entry MSB <sup>2</sup> 7 Volume 38 Data Entry LSB <sup>2</sup> 64 Sustain 70 Sound Variation <sup>3</sup> 100 Reg. Param. Select LSB <sup>4</sup> 101 Reg. Param. Select MSB <sup>5</sup>	assignable (XCTRL)  <sup>2</sup> for Reg. Params only after 100 & 101 are transmitted or received.  <sup>3</sup> Patch Selects; values of 0, 32, 64, 127 <sup>4</sup> values of 0 & 1 only <sup>5</sup> always 0
<b>Program Change</b>	<b>True Number</b>	0-127	0-23 0-38, 100-127	in OMNI, POLY, & MONO A in MULTI & MONO B
<b>System Exclusive</b>		O	O	see ASR-10 SysEx Spec.
<b>System Common</b>	<b>: Song Pos : Song Sel : Tune</b>	O O X	O X X	
<b>System Real Time</b>	<b>: Clocks : Commands</b>	O O <sup>6</sup>	O O <sup>6</sup>	<sup>6</sup> Start, Stop, Continue
<b>Aux. Messages</b>	<b>: Local On/Off : All Notes Off : Active Sense : Reset</b>	X X X X	X O <sup>7</sup> X X	<sup>7</sup> recognized by rackmount units only.
<b>Notes</b>				

Mode 1= OMNI ON, POLY  
Mode 3= OMNI OFF, POLY

Mode 2= OMNI ON, MONO  
Mode 4= OMNI OFF, MONO

O = YES  
X = NO

## ASR-10 Index

**A**

About Macros 45  
 About MIDI 36  
 About Poly-Key Pressure 37  
 ADD DATA 191  
 Additional Front Panel Controls 8  
 Additional Resources ix  
 Amalgamation 258  
 Amp  
   Parameters 200  
   Cross fade breakpoints 201  
     Create a keyboard cross fade 330  
 Amplifying the ASR-10 v  
 ASMPLNAME 287  
 ATRK BLUES 351  
 ATRK PLAYBACK STATUS 285  
 Audio Input Specs 5  
 Audio Input — B/Right and A/Left 5  
 Audio Outputs 5  
 Audio Track buttons 9, 237  
 Audio Track MIX 286  
 Audio Track PAN 286  
 Audio Track Polyphony 240  
 Audio Track Recording 237  
 Audio Track Storage 313  
 Audio Track Tutorial 350  
 Audio Tracks 237  
   About 239  
   Assigning Different Output Routings 348  
   Selecting, Enabling, and Disabling Audio  
   Tracks 238  
   Using a Guitar with the ASR-10 347  
   Using a Microphone with the ASR-10 347  
 AudioSample 257  
 AUDIOSAMPLE INFO 298  
 AudioSample Specs 268  
 AUDITION page 224  
 Auto-loop 35

**B**

BACKUP/RESTORE 49  
 Bank  
   How to Load a Bank 21  
   Loading a Bank 306  
   Save Bank 72  
   Saving a bank 60, 307  
 Banks 21, 58  
   About Banks 218  
 BASECHAN PRESSURE 36

BIDIRECTIONAL X-FADE 179  
 Bits 14  
 Boost 202  
   About the Boost parameter 30  
 Bounce-down 263, 264  
 BOWTIE CROSS FADE LOOP 178  
 Breath Controller 168

**C**

CDR viii  
 CHANGE STORAGE DEVICE 45  
 Channel Pressure 11  
 Channel pressure via MIDI 37  
 Cleaning the ASR-10 ii  
 CLEAR DATA 189  
 Click Track Parameters 273  
 Command/System • MIDI Page 42  
 Companion Layers 152  
 COMPUTER 42, 302  
 CONFIGURE AUDIO TRACKS 52, 245  
 Configure the Audio Tracks 245  
 CONVERT SAMPLE RATE 182  
 COPIES WILL CHANGE-OK 180  
 COPIES WILL CHANGE-OK? 183  
 COPY AUDIO TRACK 295  
 COPY DATA 189  
 COPY FLOPPY DISK 45  
 COPY LAYER 216  
 COPY PITCH TABLE 196  
 COPY SCSI DRIVE 48  
 COPY TRACK 288  
 COPY WAVE PARAMETERS 183  
 Copying Effects 87  
 CREATE NEW LAYER 216  
 CREATE NEW SEQUENCE 223  
 CROSS FADE LOOP 176  
 CV Pedal viii, 34  
 CVP-1 Control Voltage Foot Pedal 3

**D**

DAT 4, 352  
 Data Entry Controls 7  
 Delay Times/Tempo BPM Chart 345  
 Delete  
   Instrument Effect 74  
 DELETE AUDIOSAMPLE 317  
 DELETE LAYER 216  
 DELETE PITCH TABLE 196  
 Deleting a File from Disk 29, 312  
 Deleting an Instrument from the Internal  
 Memory 20



DI-10 Digital I/O Board (S/PDIF) viii  
 DI-10 Digital I/O Interface 4, 352  
 Digital audio output 4  
 Digital I/O — Input/Output 4  
 Digital Input and Output 4  
 Digital sampling 4  
 Directories  
   Create a new directory 44  
 Disk AudioSample 317  
 Disk Capacity — Bytes, Blocks, and Files 301  
 Disk Error messages 321  
 Disk Memory 13  
 Disk Storage 300  
 Disk Warnings 321  
 Disks  
   Different types of files 300  
 Display 8  
 Drum machine 340  
   Sequence a Drum Machine from a Track of  
   the ASR-10 340  
   Sync a Drum Machine to the ASR-10 340  
   Sync the ASR-10 to a Drum Machine 340  
 Dual Function Effect Mixer 82

## E

EDIT PITCH TABLE 194  
 EDIT SONG STEPS 279  
 Edit/(audio) Track parameters 285  
 Edit/System • MIDI Page 33  
 Edit/Wave Parameters 170  
 Effect  
   Delete Instrument Effect 74  
 EFFECT MOD CONTROL 83  
 Effect Modulators 84, 85  
   List of Effect Mod Sources 84  
 Effect Parameters  
   44KHZ DELAYS 89  
   44KHZ REVERB 88  
   8-VOICE CHOR 125  
   CHOR+REV+DDL 92  
   CHORUS+REVRB 89  
   CMP+DIST+REV 93  
   DE-ESSER 136  
   DIST+CHO+REV 94  
   DUAL DELAYS 89  
   DUCKER 138  
   EQ + DELAY LFO 108  
   EQ+CHOR+DDL 116  
   EQ+COMPRESSOR 130  
   EQ+FLNGR+DDL 120  
   EQ+TREM+DDL 122  
   EQ+VIBR+DDL 118  
   EXPANDER 132

FAST PITCHSH 129  
 FLANGER+REV 91  
 GATED REVERB 102  
 GUITAR AMP 1 111  
 GUITAR AMP 2 111  
 GUITAR AMP 3 113  
 HALL REVERB 88  
 HALL REVERB2 96  
 INVRS EXPNDR 135  
 KEYED EXPANDER 133  
 LARGE PLATE 98  
 LARGE ROOM 96  
 MULTITAP DDL 107  
 NLIN REVRB 1 105  
 NLIN REVRB 2 105  
 NLIN REVRB 3 105  
 PARAM EQ 140  
 PHASER+DDL 123  
 PHASER+REVRB 90  
 PITCH SHIFT 126  
 PITCH+DDL 128  
 REVRSE REVB2 101  
 REVRSE REVRB 100  
 ROOM REVERB 88  
 ROT.SPKR+REV 91  
 RUMBLE FILTR 140  
 SMALL PLATE 98  
 SMALL ROOM 96  
 SPKR CABINET 115  
 TUNABLE SPKR 115  
 VAN DER POL 141  
 VCF+DISTORT 110  
 WAH+DIST+REV 95

### Effect Types

Bank Effect  
   About Bank Effects 76  
   To Display the Bank Effect 76  
 Instrument Effects  
   About Instrument Effects 76  
   To Display the Current Effect 76  
 ROM Effect  
   About ROM Effects 76  
   To Display the ROM Effect 76

### Effect Variations 88

### Effects

About the Effects i, 75  
 Combined Effects 82  
 Concepts 75  
 Copying the Current Effect 87  
 Parameters 87  
 Routing Instruments through the Bank  
   Effect 83  
 Saving a Bank Effect 87  
 Selecting Effects

- List of ROM Effects 77
- Effects Busses
  - About Busses 81
- Effects Mixing 81
- ENSEMBLE CROSS FADE 177
- ENTER PLAYS KEY 41, 333
- Envelopes
  - About Envelopes 203
  - Copying Envelopes 208
  - Envelope Parameters 204
- ERASE ALL AUDIOSAMPLES 280
- ERASE AUDIO TRACK 296
- ERASE SONG + ALL SEQs 278
- ESP 75
- ESP Chip 79
- EVENT EDIT TRACK 290
- External controller 40
- EXTRAPOLATE PITCH TBL 196

## F

- FADE IN 187
- FADE OUT 188
- Fadecurves 202
- FILTER AUDIO EVENTS 299
- Filter cutoff frequency 199
- FILTER EVENT 289
- Filters 197
  - Cutoff frequency 197
  - Filter Parameters 198
  - High-pass filter 197
  - Low-pass filter 197
  - Rolloff curve 197
- Floppy Disk
  - Copy Floppy Disk 303
  - Files 301
  - Format a floppy disk 302
  - How to Copy the O.S. to Disk 43
  - How to Format a Floppy Disk 42
  - Two types of formatting 301
- Floppy Disks 300
- Foot Switch 1
- Foreign Sequence 316
- FORMAT SCSI DRIVE 52
- FORMAT TYPE 42
- FREE DISK BLOCKS 33
- FREE SYSTEM BLOCKS 33
- Front Panel Controls 6
- FX Select • FX Bypass 9, 81

## G

- Glide Mode 212

- GLIDE MODES 213
- GLOBAL BEND RANGE 33
- Global controllers 38, 343
- Global effect. 76
- GOTO Function 272
- Ground Loops
  - About Ground Loops iv

## H

- Headphones 5
- How to Play Instruments 22

## I

- IBM PC compatibles 13
- Input Level LED Meters 8
- Input Level Trim Control 4, 351
- Instrument 56
  - Copy 71
  - Create 71
  - Delete 71
  - Delete Effect 74
  - How to Load an Instrument 19, 57, 304
  - Key Range 70
  - Name 69
  - Save Instrument 72
  - Size (in blocks) 69
  - What is an Instrument 19
- Instrument Configuration 161
- Instrument • Sequence Track Buttons 9, 22
- Internal Memory 13
- INVERT DATA 191

## K

- Keyboard Calibration 12
- Keyboard Range 23
- KEYDOWN LAYERS 66
- KEYUP LAYERS 66

## L

- Layer Commands 216
  - COPY LAYER 216
  - DELETE LAYER 216
- Layer Parameters 212
- LEFT FOOT SW
  - Effects Modulation 35
  - Foot Switch Functions 35
  - Sample Start/Stop 35
  - Starting and Stopping the Sequencer 35
- Legato layer 213

Level-Detect mode 157  
LFO Parameters 209  
Line Conditioner iv  
Load global parameters 44  
Loading a Song or a Single Sequence from Disk 26  
Loading an Effect File 80, 311  
Loading and Saving Sequencer Data 220, 308  
Loading Sequencer Data 26  
Loop Parameters 171  
Loops  
    MAKE LOOP LONGER 180  
    SYNTHESIZED LOOP 181

## M

Macintosh 13  
Macros  
    Creating a Macro 54  
    Invoking a Macro 54  
    Loading a Macro File 54  
    Saving a Macro File 54  
    What Is a Macro? 53  
Main Out — Right/Mono and Left/Mono 5  
Making a Stereo Sound from a Mono  
    WaveSample 329  
Manual  
    About the Manual ii  
Master Directly to DAT 352  
MASTER TUNE 33  
MegaBytes 14  
MegaWord 14  
Memory 14, 305  
    Expanding 14  
Memory allocations 14  
Memory Expansion Jumper 15  
Memory-to-Recording Time  
    Conversion Table 243  
MERGE TWO TRACKS 290  
MERGE WAVESAMPLES 186  
Mic/Line Switch 4, 351  
Microwave vi  
MIDI  
    About MIDI 334  
    Controlling Remote Devices 334  
    Making a MIDI Instrument 335  
    Recording MIDI Tracks 228  
    Sequencing MIDI Devices 227  
MIDI BASE CHANNEL 36  
MIDI CONTROLLERS (ON/OFF) 38  
MIDI guitar controller 341  
MIDI In 1  
MIDI In Mode 37  
MIDI Out 1

MIDI OUT CHANNEL 66  
MIDI OUT PROGRAM 67  
MIDI SONG SELECT (ON/OFF) 40  
MIDI Song Selects 344  
MIDI STATUS 68  
MIDI Sys-Ex recorder 46  
    Loading Data from Disk 47  
    Saving Data 46  
MIDI SYS-EX RECORDER 39  
MIDI Thru 1  
MIX WAVESAMPLES 186  
Mode Buttons 6  
    COMMAND mode 6  
    EDIT mode 6  
    LOAD mode 6  
MODULATION WHEEL 10  
Modulators  
    About Modulation 165  
    Modulation Amount 165  
    Modulation Sources 166  
    Selecting a Modulator 165  
MONO A Mode 37  
MONO B Mode 37  
MONO Modes 38  
MULTI CONTROLLERS 41  
MULTI Mode 37  
Multi-disk Song file 316  
Multi-Sampling  
    Parameters 159  
Multi-Track Digital Recorder 327  
Multi-Track Record 229  
MultiSampling  
    How to Multisample 149  
MUTE ATRKS IN REC 275

## N

Nanoseconds 13  
NORMALIZE GAIN 184  
Nyquist frequency, 143

## O

OEX-6sr Output Expander viii, 4, 202  
OMNI Mode 37  
Operating System 12  
Optional accessories viii  
Orphaned 297  
Out 202  
Output 283  
Output Expander (AUX 1, 2, 3) 4  
Output mixing 82  
Overdubbing 257

**P**

Page Buttons 7  
 Parameter Illustrations 32  
 Parametric Programming 7  
 Parity 13  
 Patch Select  
     Making patch select changes 343  
 Patch Select (Foot Switch) 1  
 PATCH SELECT BUTTONS 10, 19, 64  
 PATCH SELECT MODE 69  
 Pedal/CV  
     Pedal Specs 3  
 Performance Controllers 10  
 Performance Preset 61  
     Create Preset 73  
     Creating Keyboard Splits 63  
     How to Create a Performance Preset 62  
 Phones 5  
 Pile o' Instruments 23  
 Pitch bend range 194  
 PITCH BEND WHEEL 10  
 Pitch Commands 194  
 Pitch Parameters 193  
 PITCH TABLE 214  
 Playing a Sequence/Song 27, 222  
 Polarization and Grounding iii  
 POLY Mode 37  
 Poly-Key™ Pressure 11  
 Power iii  
 PRE TRIGGER 158  
 Prepare the Audio Tracks 254  
 Pressure (After-touch) 11  
 PRESSURE MODE 67  
 Pressure threshold 34  
 Programming Effects 81  
 Programming Patches 65  
 Punch in 257  
 Punch-out 257  
 Purchasing SIMMs 13

**Q**

Quakercaster 342  
 QUANTIZE TRACK 288

**R**

RAM buffer 243  
 Rear Panel Connections 1  
 REC SCSI DRIVE 246  
 Receiving Program Changes 39

Recording a Sequence 224  
 Recording MIXDOWN VOLUME and  
     MIXDOWN PAN 236  
 Recording Program Changes 229  
 Recording Song Tracks 234  
 RENAME AUDIOSAMPLE 297  
 REPLICATE DATA 190  
 Resampling through Effects 323  
 REVERSE CROSS FADE 177  
 REVERSE DATA 190  
 Rhythm sequencer 340  
 Root key 193

**S**

S/PDIF 4  
 Sample rate 14, 158  
 Sample • Source Select Button 8  
 Sampling  
     About Auto-Loop Finding 153  
     About Sampling i  
     Adjusting the Sampling Threshold Level  
         146, 157  
     Creating a Short Loop 154  
     Getting better quality samples 144  
     How to Sample 144  
     Long Loops 155  
         Creating a Long Loop 155  
     Looping 153  
     Multi-sampling 159  
     Sampling Over an Existing WaveSample 150  
     Sampling parameters 146, 157  
     Setting the Input Level 147  
     Short (single-cycle) loop 154  
     Short Loop  
         Adjusting Loop Position 155  
     Sound  
         What is a sound 142  
     Understanding Aliasing 143  
     Understanding Sample Rates 143  
 Sampling Threshold Level 157  
 Sampling time 159  
 SAVE BANK 315, 355  
 SAVE GLOBAL PARAMETERS 44  
 SAVE MACRO FILE 45  
 SAVE SONG + ALL SEQs 313, 353  
 SAVE SONG AND ALL SEQs 277  
 Saving a Single Sequence to Disk 28, 221, 309  
 Saving a Song (along with all Sequences) to Disk  
     29, 221, 310  
 Saving an Effect to Disk 80, 311  
 Saving an Instrument to Disk 58, 305  
 Saving and Loading from a SCSI Storage Device  
     312

- Saving Effects 87
  - SCALE DATA 192
  - SCALE EVENT 294
  - SCSI ACCESS SPEED 246
  - SCSI BUFFER 243
  - SCSI Interface 4
  - Select the sample rate 244
  - Selecting a Sequence/Song 27
  - Selecting Effects 77
  - SEQ REC MODE 274
  - SEQ REC SOURCE 275
  - Sequence
    - How to string sequences together 27, 222
    - Use an external controller to record a track 229, 337
  - Sequence Tracks 223
  - Sequencer
    - Append Sequence 278
    - CHANGE SEQUENCE LENGTH 278
    - CLOCK SOURCE 273
    - Copy an entire sequence 276
    - Create a new sequence 276
    - LOOP 273
    - Rename the current sequence or song 277
    - Save all sequencer memory 277
    - Save the current sequence 276
    - Tempo 273
    - To erase unwanted sequences 276
    - Using an External Sequencer 338
  - Sequencer "Transport Controls" 9
  - SEQUENCER INFORMATION 277
  - Sequencer Parameters 272
  - Sequencer Status 219
  - Sequencing
    - About Digital Sequencing 217
    - About Sequencing i
    - About the Sequencer 217
  - Serial Number
    - Where to Find 12
  - SET SONG ATRK PLAYBACK 280
  - SHIFT AUDIO TRACK 296
  - SHIFT TRACKS BY CLOCKS 294
  - SHUFFLING DATA 314, 353
  - Signal Chain Routing
    - DIGITAL 251
    - INPUT+FX 252
    - INPUTDRY 251
    - MAIN-OUT 253
  - Signal processing 75
  - SIMMs 13
    - Accessing 14
    - Installing 15
  - Single Function Effect Mixer 82
  - Song
    - Delete a Step 234
    - insert a step 233
    - Making a Song 232
    - Recording Song tracks 234
  - SONG ATRK REC 275
  - Song mode 231
  - Song Position Pointers 344
  - Song Tracks 234
  - Sound Libraries viii
  - SP-3 SCSI Interface Kit viii, 44
  - SPLICE WAVESAMPLES 187
  - Stacking Instruments 25
  - Stereo Layer Link 152, 215
  - Stereo sampling 151
  - Surge/Spike Suppressor iv
  - SW-10 Dual Foot Switch viii, 1, 35
  - SW-2 Foot Switch 1, 35
  - SW-6 Foot Switch viii
  - Synthesizer
    - About The Synthesizer i
  - System Exclusive 318, 320
    - Saving Data 319
    - Storage 318
  - System Optimization Tips 268
- ## T
- Temporary Record files 247
  - TIME COMPRESS/EXPAND 182
  - To Send a MIDI Program Change from the ASR-10 39
  - TOUCH (Velocity and Pressure Response) 34
  - Track
    - How to Change the Default Track MIX Volume 225, 282
    - To erase a selected track 289
  - Track PAN 283
  - Track status 281
  - Tracks
    - Recording Program Changes 229
    - "Transport Controls" 218
  - TRANSCOPE TRACK 293
  - Triple Function Effect Mixer 83
- ## U
- Using an SQ-R PLUS 32 Voice 335
  - Using the ENTER PLAYS KEY Parameter 333
- ## V
- Velocity 332
  - Volume Slider 6

VOLUME SMOOTHING. 184

## W

Warning! 13

WaveSample

    About WaveSamples 161

    COPY WAVESAMPLE 174

    CREATE NEW WAVESAMPLE 174

    DELETE WAVESAMPLE 174

    Editing 163

    Key range 194

    Loop end point 171

    Loop position 172

    Loop start point 171

        Creating a loop 171

    Modulation Amount and Range 173

    Sample end point 171

    Sample start point 170

    TRUNCATE WAVESAMPLE 175

    Wave modulation 172

WaveSample Commands 164

WaveSample Commands in Stereo Layers 164

WaveSample Configuration Chart 162

WAVESAMPLE INFORMATION 174

WaveSample Pan 200

WaveSample playback modes 170

WaveSample Volume 200

What is a Sequence? 218

What is a SIMM? 14

What is a Song? 218

Word 14

WRITE DISK LABEL 47

    How to Label a Disk 47

## X

XPOS OCT - SEMI (Transpose) 70