

ENGINE

multitrack sequencer



USER GUIDE

Social Entropy Electronic Music Instruments

IMPORTANT SAFETY AND MAINTENANCE INSTRUCTIONS

1. Do not use this product near water - for example, in the rain, near a bathtub or sink, in a wet basement, or near a swimming pool.
2. This product, in combination with an amplifier and headphones or speakers, may be capable of producing sound levels that could cause permanent hearing loss. Do not operate for a long period of time at a high volume level or at a level that is uncomfortable.
3. Never use aggressive cleaners on the casing. Remove dust, dirt, and fingerprints with a soft, dry, non-abrasive cloth. If the unit is extremely dirty use a slightly damp cloth using only water. If the dirt still persists use a damp cloth with a conservative amount of dishwashing liquid.
4. Install in accordance with the instructions. Make sure you place the unit on a stable surface before use.
5. The product should be located away from heat sources such as radiators, heat registers, or other products that produce heat.
6. Connect the unit to an easily accessible electrical outlet that is close to it.
7. The product should only be connected to a power supply of the type described in the operating instructions or as marked on the product.
8. Unplug the unit during lightning storms, before cleaning or when not in use for long periods of time.
9. Care should be taken so that objects do not fall and liquids are not spilled into the enclosure through openings.
10. When transporting the unit, use the original box and padding.
11. Social Entropy LLC is not responsible for any damage caused by improper operation of this instrument.

WARNING - To reduce the risk of fire, electrical shock or product damage:

- Do not expose the unit to rain, moisture, dripping or splashing and avoid placing objects filled with liquid, such as cans or cups, on or near the unit.
- Do not expose the unit to direct sunlight or use it in ambient temperatures exceeding 30°C as this can lead to malfunction.
- Do not open the main casing of the unit. There are no user repairable or adjustable parts inside. Service and repairs should be performed by trained service technicians only.

EXTERNAL POWER SUPPLY SAFETY INSTRUCTIONS

- The adapter is not safety grounded and may only be used indoors.
- To ensure good ventilation for the adapter, do not place it in tight spaces. To prevent risk of electric shock and fire because of over-heating, ensure that curtains and other objects do not prevent adapter ventilation.
- Do not expose the power adapter to direct sunlight, nor use it in ambient temperatures exceeding 40°C.
- In the EU, only use CE approved power cords.

SPECIFICATIONS SUBJECT TO CHANGE

Social Entropy LLC reserves the right to modify or change any specifications without notice or obligation at any time, including changes to hardware features, software capabilities, colors and/or design.

Any company names, products or logos used in this manual are trademarks of their respective owners.

NOTE: This equipment has been tested and found to comply with the limits for a Class B digital device, pursuant to part 15 of the FCC Rules. These limits are designed to provide reasonable protection against harmful interference in a residential installation. This equipment generates, uses and can radiate radio frequency energy and, if not installed and used in accordance with the instructions, may cause harmful interference to radio communications. However, there is no guarantee that interference will not occur in a particular installation. If this equipment does cause harmful interference to radio or television reception, which can be determined by turning the equipment off and on, the user is encouraged to try to correct the interference by one or more of the following measures:

- Reorient or relocate the receiving antenna.
- Increase the separation between the equipment and receiver.
- Connect the equipment into an outlet on a circuit different from that to which the receiver is connected.
- Consult the dealer or an experienced radio/TV technician for help.

NOTICE: This Class B digital apparatus meets all requirements of the Canadian Interference-Causing Equipment Regulations ICES-003.

AVIS: Cet appareil numérique de la classe B respecte toutes les exigences du Règlement sur le matériel brouilleur du Canada.

European Union regulation compliance statement



This product has been tested to comply with the Low Voltage Directive 2006/95/EC and the Electromagnetic Compatibility Directive 2004/108/EC. The product meets the requirements of RoHS 2 Directive 2011/65/EU.

This symbol indicates that the device must be disposed of properly according to local laws and regulations.



TABLE OF CONTENTS

BACKGROUND	1
CONCEPTS	2
DIAGRAM CONVENTIONS	3

THE BASICS

WHAT'S IN THE BOX	6
FRONT PANEL	7
REAR PANEL	8
PHYSICAL SPECIFICATIONS	8
SEQUENCER BASICS	9
TRACKS	9
SONGS	13
FUNCTIONS	14

QUICK START

QUICK START	16
CONNECTIONS	16
CONNECTING MIDI	16
CONNECTING AUDIO	16
CONNECTING POWER	16
SELECT A TRACK	17
CREATE A PATTERN	17
MODIFY A PATTERN	18
CREATE SNAPSHOTS	18
CREATE A SONG	19

REFERENCE GUIDE

STARTING AND STOPPING THE SEQUENCER	22
MIDI CONTINUE	23
MIDI PANIC	24
TRACKS	25

SELECTING TRACKS	25
SELECTING PATTERNS AND PATTERN CHAINS FOR A TRACK	27
SELECTING PATTERNS USING MIDI.....	29
CLEARING A TRACK	30
CLEAR TRACK SETTINGS.....	31
CLEARING TRACK PATTERNS TO A SPECIFIC TYPE	31
COPYING A TRACK	32
PASTING A TRACK.....	32
MUTING TRACKS.....	33
SOLOING TRACKS.....	34
UNSOLOING TRACKS.....	34
FUNCTION MODE.....	35
SETTING THE TRACK MIDI CHANNEL.....	36
MIDI EFFECTS	37
VELOCITY OFFSET	37
GATE OFFSET	38
DELAY OFFSET	38
NOTE REPEAT.....	39
NOTE REPEAT - POLY MODE	40
NOTE REPEAT DECAY	41
TRACK UTILITY MODE	42
SETTING TRACK KNOB MIDI CHANNEL/PORT	43
CONFIGURING TRACK KNOBS	44
USING MIDI CONTROLLERS	45
USING TRACK MODULATORS.....	46
USING MIDI NOTES	47
PATTERN BANK AND PROGRAM CHANGE MESSAGES.....	48
SET FIXED VELOCITIES.....	51
SETTING THE ACCENT VELOCITY.....	51
SETTING THE NORMAL VELOCITY	52
SETTING THE GHOST VELOCITY	53
SYSTEM EXCLUSIVE DUMPS	54
SYNTH1/SYNTH2: TRANSPOSING TRACKS USING MIDI	55
SYNTH1/SYNTH2: SETTING STEP PITCH USING MIDI	56
TRACK QUANTIZATION	57
CV/GATE OUTPUT MODES	58
SETTING CV/GATE MODE.....	59
DISABLE/ENABLE TRACK CV SLIDE	60
CV TUNING OFFSET	61
FORCE TO SCALE.....	62
SELECTING THE ROOT NOTE.....	63
SELECTING THE SCALE PRESET	64
SETTING THE USER SCALE.....	65

SAVING THE USER SCALE	65
PATTERNS	66
PATTERN TYPES.....	66
CHANGING PATTERN TYPES	67
REST MODE.....	68
ADAPTIVE RECORD MODE	69
SETTING UP FOR ADAPTIVE RECORD	69
INITIATING ADAPTIVE RECORD	69
ENDING ADAPTIVE RECORD	70
REPLACE RECORD MODE	71
PAUSE RECORD MODE.....	72
TIME MODE.....	73
SETTING PATTERN LENGTH	74
EXTENDING A PATTERN.....	75
COPYING A PATTERN SECTION	76
PASTING A PATTERN SECTION.....	76
CLEARING A PATTERN SECTION.....	77
TRANSPOSING A PATTERN SECTION.....	77
SETTING PATTERN TIME SCALE	78
SETTING PATTERN SHUFFLE	80
SKIPPING PATTERN STEPS	81
REALIGN A PATTERN	82
TEMPO LOCK	83
TAP TEMPO.....	83
INCREMENT/DECREMENT TEMPO	84
DRUM TYPE PATTERNS	85
SELECTING DRUM INSTRUMENTS.....	85
ALL ACCENT	86
NO ACCENT.....	87
LIVE DRUM INSTRUMENT REST	88
ALL REPEAT.....	89
NO REPEAT.....	89
PROGRAMMING DRUM TYPE PATTERNS.....	90
GRID PROGRAMMING	90
ADDING OR REMOVING A TRIGGER.....	90
CHANGING TRIGGER VELOCITY.....	91
SETTING NOTE REPEAT	92
SETTING STEP DELAY	92
REALTIME RECORDING.....	93
REALTIME RECORD ACCENT, REPEAT, REST	94
STEP RECORDING.....	95

MUTING DRUM INSTRUMENTS.....	97
SOLOING DRUM INSTRUMENTS	98
UNSOLOING DRUM INSTRUMENTS	98
DRUM ROLLS	99
CHANGING THE DRUM ROLL RESOLUTION	100
LATCHING DRUM ROLLS	101
RECORDING A DRUM ROLL	102
DRUM LEARN MODE	103
SYNTH TYPE PATTERNS	104
PROGRAMMING A SYNTH TYPE PATTERN.....	104
GRID PROGRAMMING	105
ADDING OR REMOVING A STEP EVENT.....	106
SYNTH1: POLYPHONIC PROGRAMMING	107
SYNTH1: SELECTING THE PITCH SLOT TO PROGRAM	107
SYNTH2: POLYPHONIC PROGRAMMING	108
SYNTH2: SELECTING THE NOTE LANE TO PROGRAM.....	108
CHANGING STEP PITCHES	109
SYNTH1: QUICKLY ENTERING MULTIPLE PITCHES	111
SYNTH1: TRANSPOSING POLYPHONIC STEPS.....	112
SETTING STEP LENGTH	113
FINE TUNING GATE LENGTH	114
SYNTH1: ADDING SLIDE	115
SETTING NOTE REPEAT	115
SETTING VELOCITY OR ACCENT	116
SYNTH1: SETTING STEP DELAY.....	117
REALTIME RECORDING	118
QUANTIZATION	118
STEP RECORDING	119
TRANSPOSING SYNTH PATTERNS	122
ALL ACCENT	124
NO ACCENT	124
SYNTH1: ALL SLIDE	125
SYNTH1: NO SLIDE	125
ALL REPEAT	126
NO REPEAT.....	126
REALTIME RECORD TRANSPOSE, ACCENT, SLIDE, NOTE REPEAT ..	127
REALTIME ARPEGGIATOR.....	128
SYNTH1 AND SYNTH2 ARPEGGIATOR DIFFERENCES.....	128
CHANGING THE ARPEGGIO PLAY MODE	129
ARPEGGIO PLAY MODE: PATTERN.....	130
CHANGING THE ARPEGGIO VARIATION	131
CHANGING THE ARPEGGIO OCTAVES	132
LATCHING THE ARPEGGIATOR.....	133

RECORDING AN ARPEGGIO	134
CHORD MEMORY	135
CONTROL TYPE PATTERNS	137
SELECTING CONTROLLERS.....	137
PROGRAMMING A CONTROL TYPE PATTERN	138
GRID PROGRAMMING	138
ADDING OR REMOVING A CONTROL EVENT	139
CHANGING A CONTROL VALUE.....	140
CONTROL SLIDE	141
REALTIME RECORDING	142
STEP RECORDING.....	143
MUTING INDIVIDUAL CONTROLLERS.....	145
SOLOING INDIVIDUAL CONTROLLERS.....	146
UNSOLOING CONTROLLERS	146
LFO MODE	147
CHANGING THE LFO SHAPE	148
CHANGING THE LFO SPEED	149
CHANGING THE LFO MODULATION DEPTH.....	150
CHANGING THE LFO PHASE	151
LFO SLIDE	152
LATCHING THE LFO.....	153
RECORDING AN LFO	154
STEP FUNCTIONS	155
DRUM/CTRL: OPERATING ON ALL INSTRUMENTS.....	155
STEP ROTATE	156
STEP CLEAR	156
STEP COPY	157
STEP PASTE.....	158
SYNTH1/SYNTH2: STEP LENGTH.....	158
PATTERN FUNCTIONS	159
DRUM/CONTROL: OPERATING ON ALL INSTRUMENTS.....	159
SYNTH: APPLY TRANSPOSE	160
PATTERN ROTATE.....	161
PATTERN CLEAR	162
PATTERN COPY	162
PATTERN PASTE.....	163
PATTERN RANDOMIZE	164
RANDOMIZE VALUE.....	164
RANDOMIZE GATE	165
SYNTH1/SYNTH2: RANDOMIZATION PITCHES	165
SYNTH1/SYNTH2: PITCH RANGE BIAS.....	166
SYNTH1: SLIDE RANDOMIZATION	166
DRUM/CTRL: INSTRUMENT EXCLUDE.....	167

EXECUTING RANDOMIZATION	168
PATTERN DIRECTION.....	169
PROBABILITY DIRECTION.....	171
SNAPSHOTS.....	172
CREATING SNAPSHOTS	174
SNAPSHOT RECORD	175
SNAPSHOT PASTE	176
RECALLING SNAPSHOTS	178
CLEARING SNAPSHOTS	179
SNAPSHOT FUNCTION MODE.....	180
SNAPSHOT UTILITY MODE	181
SNAPSHOT RECALL SETTINGS.....	182
TRACK MIDI PORT/CHANNEL RECALL	182
TRACK MIDI EFFECTS RECALL	182
TRANSPOSE INST MUTE RECALL.....	183
TRACK MUTE RECALL	183
SNAPSHOT TEMPO RECALL	184
SONGS.....	185
PLAYING SONGS	185
ENTERING SONG PLAY MODE	185
SELECTING SONGS	186
CREATING SONG CHAINS	186
SONG LOCATION SHORTCUTS	187
STARTING FROM A SPECIFIC SONG STEP	188
RECORDING SONGS.....	189
REALTIME SONG RECORD	189
PAUSE RECORD REALTIME SONG	190
SONG STEP RECORD	191
SELECTING CURRENT SONG STEP	192
DELETING CURRENT SONG STEP	193
INSERTING A SONG STEP	194
SETTING SONG STEP REPEATS	195
ASSIGNING SNAPSHOTS TO SONG STEPS	196
SETTING THE LAST SONG STEP	196
SONG FUNCTIONS	197
CLEARING A SONG	197
COPYING A SONG	198
PASTING A SONG	198
GLOBAL CONFIG	199

SETTING GLOBAL KNOB CHANNELS.....	200
SETTING GLOBAL KNOB CONTROLLER NUMBERS	201
DUMP MACHINE STATE	202
CV EXPANSION MODE.....	203
CV MODE: 8 TRACKS.....	204
CV MODE: 4 TRACKS.....	205
CV MODE: 1 TRACK.....	207
CV MODE: 6 CONTROLS AND CLOCKS	210
SETTING INPUT MIDI CHANNEL.....	212
ENABLING MIDI THRU	213
ENABLING MIDI PROGRAM CHANGE RECEIVE.....	215
SYNC SOURCE.....	216
SPECIFYING THE SYNC SOURCE	216
SPECIFYING THE DIN RATE.....	217
DIN CONTINUE	218
SENDING MIDI CLOCK	219
FORMAT ALL PATTERNS	220
USB MIDI	221
DIMMING LEDS.....	222
CHECKING OS VERSION.....	223
MASTER TRACK	224
MIDI OUTPUT OVERLOAD.....	225
SUPPORT FOR ELEKTRON TURBOMIDI.....	226
UPDATING FIRMWARE	227
MACHINE WIPE	229
FACTORY RESET	230
CV GATE OUTPUT EXPANSION.....	231
INSTALLING THE CV EXPANSION BOARD	231
ENABLING THE CV EXPANSION BOARD	233
SELECTING THE CV MODE.....	234
CV CONVERTER MODE	235
ENABLING CV CONVERTER MODE.....	235
ENDING CV CONVERTER MODE	236
MONOPHONIC/POLYPHONIC CONVERSION	236
SETTING CONVERSION MIDI CHANNELS.....	237
ENABLING HARDWARE SLIDE.....	238
CV/GATE OUTPUT MODE	239
MIDI ROUTING DIAGRAM	240

BACKGROUND

Social Entropy started business developing the Quicksilver upgrades for the TR-606 and TB-303. This was specifically a challenge because we were adding new features and capabilities to a machine that already had a defined interface, buttons and labelling. There were many places where adding extra capability just didn't make sense in the context of the interface.

As part of our creative process, we always enjoy a dedicated hardware device that had a particular workflow, whether it was for drums or synthesizer. This is where the old machines really shine. But we also wanted even greater control over multiple machines and the ability to control any device with the same type of dedicated interface, whether it was a VST, a sound module or even a modular synthesizer.

At this point we decided it was time to design and build a sequencer of our own. A machine that had the best parts of a dedicated hardware sequencer, streamlined workflow and connectivity to multiple devices.

Four years later, we were finally ready to release Engine. We hope you enjoy it as much as we do!

CONCEPTS

Engine is a multitrack step sequencer with eight polyphonic tracks. Composing music with Engine consists of selecting tracks, assigning patterns or pattern chains to a track, setting pattern types and recording steps into the patterns. These configurations can be captured into snapshots and sequenced into a song structure. The remainder of this manual will focus on these activities.

Engine is all about the ability to both compose and perform live from a dedicated interface. This means several things in the context of Engine.

First, almost everything that you can do as a live performance can be recorded directly into a sequence. This includes pitches, arpeggiators, drum rolls, accents, slides, etc. The sequencer can enter or leave record mode from almost any of the live performance modes, making it extremely easy to capture an interesting musical event.

Second, most changes to a sequence are quantized to the loop point. This means that changing the selected pattern, snapshot, scale, shuffle or length won't cause patterns to fall out of sync with each other during live performance. There are still a few functions that apply immediately, such as muting and transpose which can be used for other interesting performance options.

Almost all functions can be used momentarily or they can be double-clicked (pinned) to stay in a function without being forced to hold down a button. This is great when certain functions are needed consistently for live performance, such as track muting or drum muting.

Everything in Engine can be done while the sequencer is running. This means that your performance doesn't need to be interrupted by stopping the sequencer to access certain functions or enter certain modes.

DIAGRAM CONVENTIONS

Throughout this document, diagrams are used to illustrate the buttons used to perform various actions.

Some diagrams will not show buttons being held or pinned to stay in a certain mode while functions are performed. For example, for functions associated with TIME MODE, it is assumed that the TIME button is being held or pinned, the TIME button will not be shown in every diagram.

To illustrate that a button should be pressed and held, the button will be displayed as RED.

To illustrate that a button should be pressed and released (clicked), the button will be displayed as WHITE.

Example:

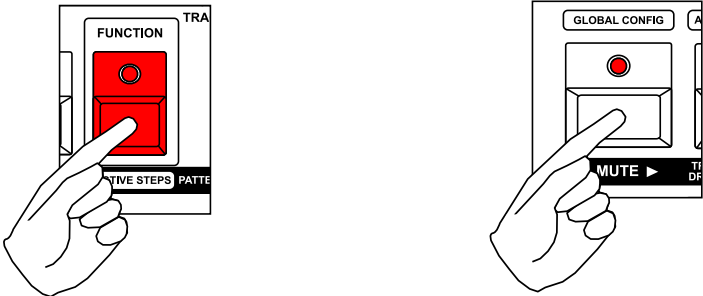

This shows one button being held This shows one button being clicked

When multiple buttons are used to perform an action, the diagram will use a plus sign to show the combination of buttons used.

Example:

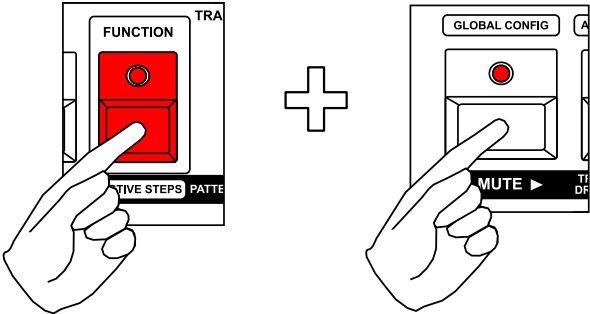

This shows one button being held and then a second button being clicked

A brightly lit LED is represented as red, a dim LED is represented in pink.

When an LED is blinking, it is represented with a dotted line around the LED.

Example:

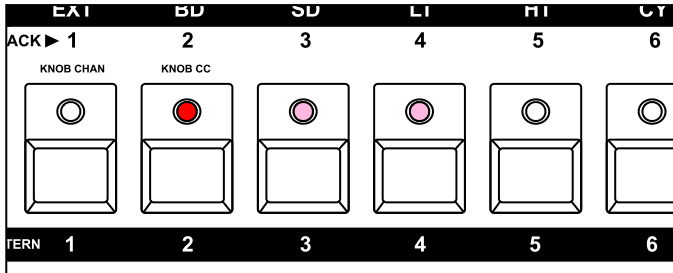

One brightly lit LED and two dimly lit LEDs

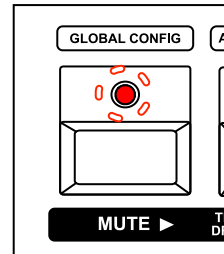

A blinking LED

When a knob should be turned, it will be shown with a red arrow.

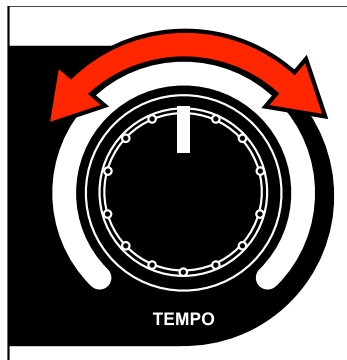

Showing that a knob should be turned

THE BASICS

WHAT'S IN THE BOX

Included in the box are the following:

- 1x Engine hardware sequencer: white/red, white/blue or black edition
- 1x USB cable
- 1x 9V DC international power supply
- 5x International power plug attachments
- 1x Quickstart postcard
- 1x Sticker

FRONT PANEL

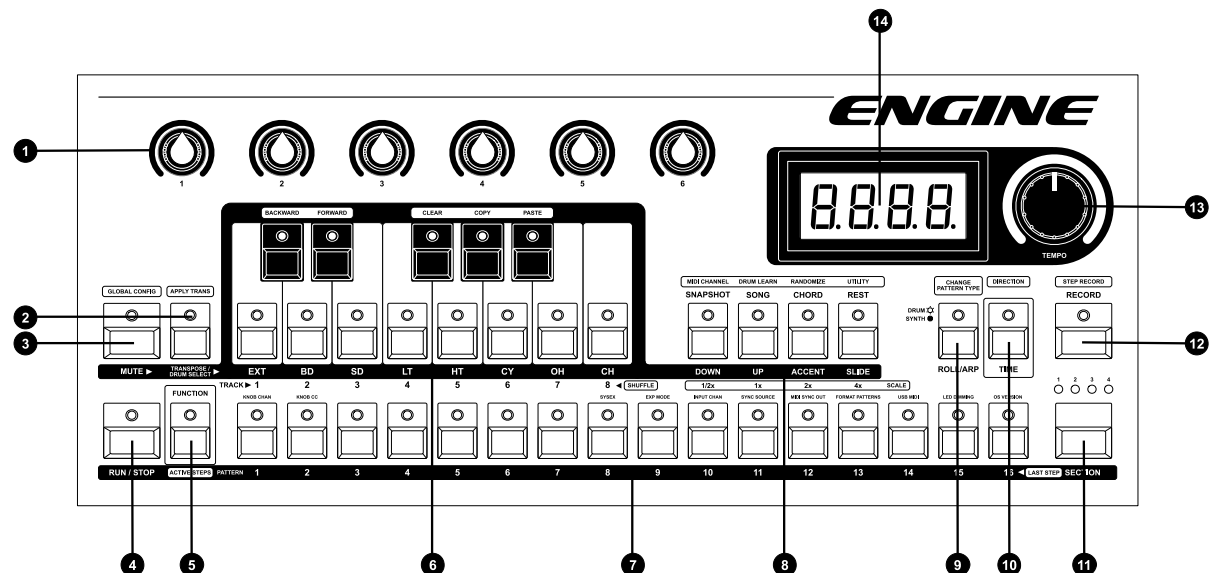

- 1** CONTROL KNOBS
Used for sending MIDI or CV control messages in realtime
The knobs are also used for setting some values
- 2** TRANSPOSE / DRUM SELECT BUTTON
Used in combination with the mini-keyboard to transpose synth type patterns or change the selected drum instrument in drum type patterns
- 3** MUTE BUTTON
Used to mute tracks or individual drum instruments in drum type patterns
- 4** RUN / STOP BUTTON
Used to start or stop the sequencer
- 5** FUNCTION BUTTON
Used to access secondary functions
- 6** MINI KEYBOARD
Used to select tracks, drum instruments, or enter pitch in semitones
- 7** 16 PATTERN STEP BUTTONS
Used to edit pattern steps and select patterns
- 8** 4 STEP ATTRIBUTE BUTTONS
Used to set certain step attributes or enter other modes
- 9** ROLL/ARP BUTTON
Used to enter the arpeggiator for synth type patterns or drum roll mode for drum type patterns
- 10** TIME BUTTON
Used to enter time mode or set pattern playback direction
- 11** SECTION BUTTON
Used to select pattern sections or banks
- 12** RECORD BUTTON
Enter and leave record mode
- 13** TEMPO KNOB
Varies the tempo of the internal clock
- 14** LED DISPLAY
Usually displays tempo, but used to display information in some other modes.

REAR PANEL

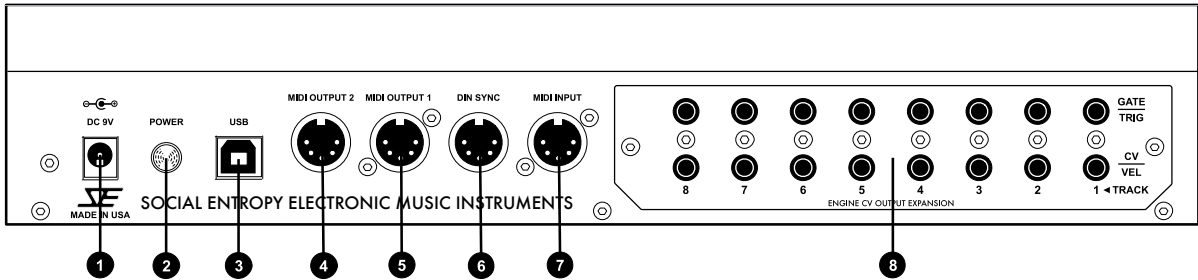

- 1** POWER JACK
Use 2.1mm, 9V DC power supply, center positive 500mA or more.
- 2** POWER BUTTON
Push to turn Engine on or off.
- 3** ISOLATED USB JACK
Use to connect Engine to a USB host, such as a computer. USB can be used for updating the firmware or sending MIDI over USB
- 4** MIDI OUTPUT 2 JACK
Connect to external MIDI devices for sequencing or synchronization. NOTE: Output 2 does not provide power to unpowered MIDI devices
- 5** MIDI OUTPUT 1 JACK
Connect to external MIDI devices for sequencing or synchronization. Output 1 provides power to unpowered MIDI devices
- 6** DIN SYNC JACK
Can be configured as either a DIN SYNC master or slave for synchronization
- 7** MIDI INPUT JACK
Connect to external MIDI devices such as MIDI controllers or a MIDI clock master for synchronization
- 8** EXPANSION PORT
Mounting bay for optional expansion boards, such as the CV/Gate expansion

PHYSICAL SPECIFICATIONS

DIMENSIONS	327 (W) x 66 (D) x 133 (H) mm
	12-7/8 (W) x 2-5/8 (D) x 5-1/4 (H) inches
WEIGHT	1.2kg (excluding power supply, options)
	2 lbs 9 oz (excluding power supply, options)
POWER	
	9V DC 300mA, 2.1mm center positive

SEQUENCER BASICS

This section covers the basic features and building blocks of Engine.

The Engine sequencer works with five main components; TRACKS, PATTERNS, STEPS, SNAPSHOTS and SONGS.

TRACKS

A good place to start is the TRACK. Engine has eight tracks which play simultaneously. A track shouldn't be confused with a song, on some synthesizers/sequencers the term "track" is used to describe a song structure.

A track contains settings for a selected pattern or pattern chain, MIDI channel, drum note mappings, MIDI effects and track mute status.

Each track has four dedicated banks of sixteen patterns (64 patterns per track). A track can play a single pattern or a chain of patterns can be selected to play back in sequence.

PATTERNS

Within each track is a selected pattern (or chain of patterns). A pattern contains all of the steps that make up a musical passage up to 64 steps.

There are four distinct pattern types, DRUM type patterns, SYNTH1 type patterns, SYNTH2 type patterns and CONTROL type patterns. Each pattern type has different capabilities specifically designed for programming different types of sequences, we will cover these differences in more detail later in the manual.

Each pattern contains settings for type, timing scale, shuffle and last step (length) in addition to programmed steps. Synth type patterns also include settings for pattern transpose and chord memory. Drum type patterns store the individual drum instrument mute status. Control type patterns store the mute status for individual controllers.

There are 512 total patterns spread across the 8 tracks (64 x 8).

STEPS

Steps are the lowest level component that make up a pattern. A STEP typically represents one musically significant event, such as a 16th note, although this can change depending on the timing scale.

A step has different STEP ATTRIBUTES depending on the pattern type it belongs to.

BASICS

For SYNTH1 type patterns, a step has attributes that determine PITCH, GATE, VELOCITY (ACCENT), GATE LENGTH (SLIDE), REPEAT and DELAY, in addition to ACTIVE for the entire step.

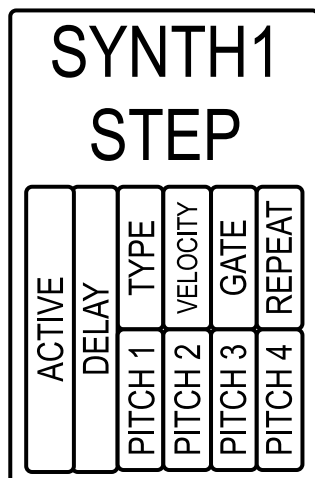

PITCH 1-4	Defines the pitches of the step
VELOCITY	The velocity of the note to be played, accent is a quick way to set the velocity to a preset value
GATE	Defines the note length, slide is created when a note overlaps the next note, also known as legato. This is interpreted by most 303 clones as a "slide"
TYPE	The step type can be a step, tie or rest. The total length of a note is determined by the combination of a step event along with subsequent tie events
ACTIVE	Determines if the step will be played or skipped
REPEAT	Activates the note repeat effect for the step
DELAY	Delays the start of the note.

For SYNTH2 type patterns, a step has attributes that determine PITCH, GATE, VELOCITY (ACCENT), and REPEAT, in addition to ACTIVE for the entire step.

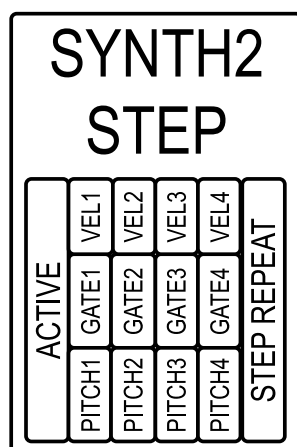

PITCH 1-4	Defines the note pitches for the step
VELOCITY 1-4	The velocity of the note which is limited to the fixed velocities defined in TRACK UTILITY mode.
GATE 1-4	Defines the note length, can be defined independently per note
TYPE	The step type can be a step, tie or rest. The total length of a note is determined by the combination of a step event along with subsequent tie events
ACTIVE	Determines if the step will be played or skipped
REPEAT	Activates the note repeat effect for the step

BASICS

For DRUM type patterns, a step has attributes that determine TRIGGER, VELOCITY and REPEAT for sixteen drum instruments, in addition to ACTIVE and DELAY for the entire step.

DRUM STEP																
ACTIVE																
DELAY																
RPT	VEL	EXT														
RPT	VEL	BASSDRUM														
RPT	VEL	SNARE														
RPT	VEL	LOW TOM														
RPT	VEL	HI TOM														
RPT	VEL	CYMBAL														
RPT	VEL	OPEN HAT														
RPT	VEL	CLOSED HAT														
RPT	VEL	EXT2														
RPT	VEL	BD2														
RPT	VEL	SNARE2														
RPT	VEL	LOW TOM2														
RPT	VEL	HI TOM2														
RPT	VEL	CYMBAL2														
RPT	VEL	OPEN HAT2														
RPT	VEL	CLOSED HAT2														

TRIGGER 1-16	Defines which drum instruments will be played on this step
VELOCITY 1-16	The trigger velocity per drum instrument. Available velocities are set in TRACK UTILITY mode.
ACTIVE	Determines if the step will be played or skipped
REPEAT 1-16	Activates the note repeat effect for the step
DELAY	Delays the start of all triggers

In a CONTROL type pattern, a step has attributes that determine the CONTROL VALUE , SLIDE and CONTROL ACTIVE state for the six control knobs, in addition to ACTIVE state for the entire step.

CONTROL STEP							
ACTIVE							
SLIDE							
ACTIVE	VALUE1	SLIDE					
ACTIVE	VALUE2	SLIDE					
ACTIVE	VALUE3	SLIDE					
ACTIVE	VALUE4	SLIDE					
ACTIVE	VALUE5	SLIDE					
ACTIVE	VALUE6	SLIDE					

CONTROL VALUE 1-6	Defines the control value that will be sent for one of the six controllers
CONTROL ACTIVE 1-6	Determines if the controller value will be sent for this step
SLIDE 1-6	Determines if the (optional) CV slide is engaged, also will send intermediate MIDI CC to next step.
ACTIVE	Determines if the step will be played or skipped

SNAPSHOTS

Snapshots are useful for storing the current state of Engine across all tracks. This allows all settings to be recalled with a single button press. This can be used to build a song structure in realtime for live performance.

A SNAPSHOT stores the settings for selected patterns or pattern chains per track, MIDI effects, MIDI channels, the mute status of tracks, the mute status of individual drum instruments in drum type patterns, the mute status of controllers in control type patterns and the transpose value of synth type patterns. Additionally, a snapshot stores the current tempo.

NOTE: The actual pattern data is not stored with a snapshot, only pointers to selected patterns.

There are 2 groups of 64 snapshots (4 banks x16 snapshots) for a total of 128 available snapshot locations.

BASICS

SONGS

A SONG is a sequence of snapshots. SONGS allow for an entire performance to be constructed with different snapshots and played back in sequence automatically.

Each SONG is made up of a series of SONG STEPS (not to be confused with pattern STEPS). A SONG can contain up to 64 individual SONG STEPS.

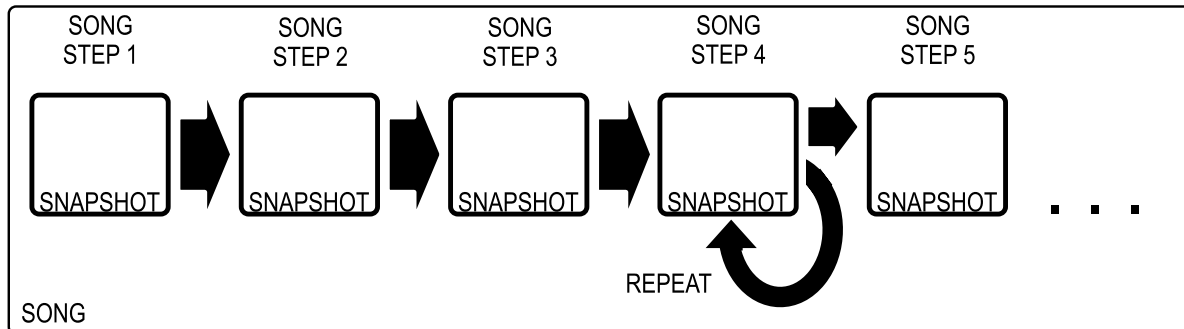

Each SONG STEP has settings for:

- SNAPSHOT – Snapshot location recalled on the song step
- REPEATS – How many times a SNAPSHOT will play before advancing to the next step. Playback of the longest pattern or pattern chain in the snapshot counts as one repeat.

A SONG also contains settings for SONG LENGTH. After reaching the last song step, a SONG will loop back to the beginning or move to the next song in the chain.

There are 32 total songs in memory.

MODES

There are many modes accessible using different buttons on the front panel. Some examples of available modes are:

- MUTE MODE - Mute individual tracks
- TRANSPOSE MODE - Transpose a synth type pattern
- PATTERN SELECT MODE - Select the pattern or pattern chain assigned to a track
- TIME MODE - Edit time parameters for a pattern, such as scale, shuffle or last step

Each available mode will be covered in detail later in this manual.

FUNCTIONS

FUNCTIONS perform actions on step, pattern or track data. Most functions are initiated in FUNCTION MODE through various combinations of buttons, but some functions are available as realtime performance capabilities in other modes.

Some examples of functions are:

- PATTERN CLEAR - Clearing pattern data.
- STEP COPY - Copy step data to the step copy buffer.
- PATTERN ROTATE - Move pattern data forward or backwards one step at a time.
- ALL ACCENT - A realtime performance function that plays every note accented.
- RANDOMIZE - Randomize pattern data.

Each function is documented in full detail throughout the remainder of this manual.

QUICK START

QUICK START

This guide should help you get started as quickly as possible. It covers basic entry of PATTERN data into a single track and then constructing a simple SONG.

CONNECTIONS

Before using Engine, you will need to connect the machine to power and a sound source to be controlled using MIDI, USB-MIDI or optionally CV/Gate. For this exercise we will use only the MIDI output.

CONNECTING MIDI

Engine has a MIDI input and two MIDI output ports.

The MIDI input port can be used for syncing Engine to other devices, or it can be used to connect a MIDI controller for realtime recording into patterns.

The MIDI output ports are used to send programmed MIDI events to other devices, in order to generate sound. MIDI clock can also be sent to synchronize other devices to Engine.

To begin, we recommend starting with one MIDI device such as a synthesizer that can be used as a sound source for programmed patterns. Connect MIDI output 1 from Engine to the MIDI input of the synthesizer.

CONNECTING AUDIO

Connect audio cables before turning on audio amplifiers.

Connect the audio output of the MIDI device to a mixer or other audio input. A headphone output can be used for private listening.

This will allow us to hear the results of our sequencing.

CONNECTING POWER

Use the included 9V power supply to power Engine. The power supply is world voltage compatible, you must choose the correct plug attachment for your region and attach it to the power supply.

Once the power supply is connected, push the power switch to turn Engine on. You should see the LEDs light in sequence as Engine boots.

TIP: If you wish to start from a clean state, use the FACTORY RESET procedure before starting.

SELECT A TRACK

First we will select the track we want to sequence. The default mode for Engine is TRACK SELECT mode, meaning that you can use the eight white buttons of the mini keyboard to select one of the eight available tracks.

After initialization, Engine automatically creates synth type patterns in tracks 1 through 4 and drum type patterns in tracks 5 through 8. These can be changed to suit your studio.

MIDI channels are automatically assigned to match the track number. These channels can also be changed to match your studio.

TIP: All of these actions can be done while the sequencer is running!

1. Select a track by pressing one of the eight white buttons on the mini keyboard:
 - Because our sound source is a synthesizer, select a track from 1 to 4
2. Match the MIDI channel of the track to the MIDI channel of the synthesizer
 - Double click the FUNCTION button to pin FUNCTION MODE
 - Press and hold the MIDI CHANNEL (snapshot) button
 - Select the desired MIDI port and channel by turning control knob 1.
 - The current MIDI port and channel is shown on the LED display
3. Click the FUNCTION button to leave function mode.
4. The track is now ready to be sequenced

CREATE A PATTERN

Now we will quickly create a new pattern. There are multiple ways of entering pattern data, but for this exercise we will use the grid programming method. For details on other methods, please refer to the REFERENCE GUIDE section of this manual.

1. If you have not done so, press the RUN/STOP button to start the sequencer
2. By default the pattern is 16 steps long, the chase LED should move across the 16 pattern steps and loop back to step 1
3. Now click and hold one of the 16 step buttons to enter a note event
4. To set the length of the note, while still holding the step button, click a second step button located after the first. The length will be shown with dim LEDs.
5. While still holding the step button, set the pitch of the note in semitones using the mini keyboard buttons

QUICK START

6. While still holding the step button, set the octave of the pitch using the DOWN and UP buttons
7. While still holding the step button, you can also set the ACCENT and SLIDE attributes
8. While still holding the step button, a specific note velocity can be set using controller knob 1. The current velocity of the note is displayed on the numeric display.
9. While still holding the step button, fine tune the gate length of the note using control knob 2. The current gate length will be displayed on the numeric display. If slide is set, the display will show "SLD".
10. Release the step button and repeat from step number 3 to enter new notes.

MODIFY A PATTERN

Now that you have created a pattern, you can do something dynamic with it.

- Try the ALL ACCENT function by pressing and holding the TRANSPOSE button then press the ACCENT button, all notes will play with accent while ACCENT button is held.
- Try the ALL SLIDE function by pressing and holding the TRANSPOSE button then press the SLIDE button, all notes will be played legato while the slide button is held.
- Release the TRANSPOSE button
- Modify the pattern length by pressing and holding the TIME button and then pressing a pattern step button. The new length will take effect the next time the pattern loops.
- Release the TIME button

CREATE SNAPSHOTS

Now we will save your pattern setup into a snapshot.

1. Select SNAPSHOT MODE by double-clicking the SNAPSHOT (down) button. The SNAPSHOT LED will blink.
2. Record a snapshot by pressing and holding the RECORD button and then click PATTERN STEP 1.

QUICK START

3. Now let's transpose the pattern on track 1 without leaving SNAPSHOT mode. Make sure that track 1 is selected by pressing the TRACK 1 button (low C on the mini-keyboard).
4. Press and hold the TRANSPOSE button, now select a semitone transpose amount by pressing one of the buttons of the mini-keyboard.
5. Release the TRANSPOSE button
6. Now we will save the transposed pattern setup into a new SNAPSHOT location. We are still in SNAPSHOT mode and the SNAPSHOT LED should be blinking.
7. Press and hold the RECORD button and then click PATTERN STEP 2. This saves the snapshot to location 2.
8. You can now switch back and forth between the two snapshots by clicking PATTERN STEP 1 or PATTERN STEP 2. The snapshot will change when the pattern loops and you should hear the pattern transpose automatically.
9. Click the SNAPSHOT button to leave SNAPSHOT mode.

CREATE A SONG

Using the two snapshots we have recorded, we will build a simple song.

1. Select SONG MODE by double clicking the SONG (transpose up) button.
2. For this example we will use song step record mode to create the song. To enter step record, press and hold FUNCTION and then click RECORD. The FUNCTION and RECORD LEDs will start blinking.
3. For our song structure we will play snapshot 1 three times, then switch to snapshot 2 for one repetition, then loop back to the beginning.
4. The current song step number is shown on the numeric display, it should be showing "St 1" for step 1.
5. Although it should already be selected, click PATTERN STEP 1 to select snapshot 1 for this step.
6. Now click the TRACK 3 (mini-keyboard E) button to set the step repeats to 3. The first 3 track LEDs will show the number of repetitions.
7. Now we move to song step 2 by clicking the FORWARD (D sharp) button. The numeric display should change to show "St 2".
8. Now click PATTERN STEP 2 to assign snapshot 2 to this song step.
9. The number of repeats should already be set to 1, which is shown by a (blinking) LED on the TRACK 1 button.
10. Now we need to assign song step two as the last step in this song. Click the REST (slide) button to assign this step as the last song step. The REST LED will light.

QUICK START

11. Now leave song step record by clicking the FUNCTION button.
12. If the sequencer is already running, you should hear and see the song progress from snapshot 1 to snapshot 2. The LEDs and display will change to show the song progress. After playing snapshot 2, the song loops back to snapshot 1.

Now that you know how to create patterns, snapshots and songs, you can explore polyphonic programming, drum programming, realtime recording, arpeggios and drum rolls and more across all eight tracks!

REFERENCE GUIDE

STARTING AND STOPPING THE SEQUENCER

To start or stop the sequencer, simply click the RUN/STOP button.

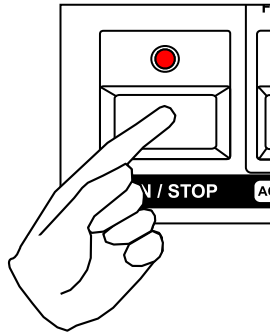

If the sequencer is currently under external sync, the internal clock will be used as a fallback when external sync is lost.

TIP: You can also use RECORD PAUSE to start the sequencer automatically when starting to record a new pattern.

MIDI CONTINUE

If you wish to continue the sequencer from the current position (after stopping the sequencer) press and hold the FUNCTION button before clicking RUN/STOP. This will also send a MIDI continue message to any MIDI sync outputs.

TIP: Engine will also respond to MIDI Continue messages when using external sync.

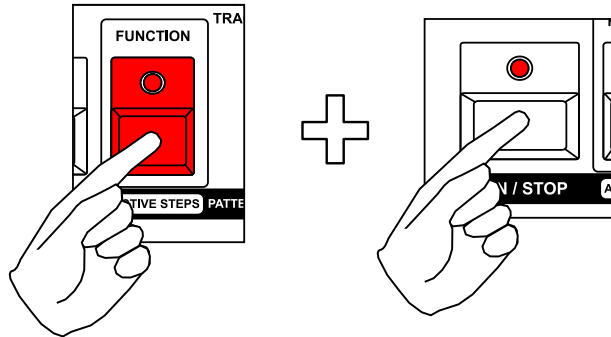

NOTE: Continue cannot be initiated while in TIME MODE, because this button combination is used to realign a track.

NOTE: The behavior of the DIN clock when using continue can be configured in GLOBAL CONFIG mode.

MIDI PANIC

If a connected device has notes hanging after stopping the sequencer, Engine can send an "ALL NOTES OFF" message (MIDI controller 123) on all MIDI channels. Engine will also clear any internal notes and CV/Gates.

To send an all notes off message, with the sequencer stopped, double-click the RUN/STOP button.

NOTE: The receiving device must respect the ALL NOTES OFF message, not all devices respond to this message.

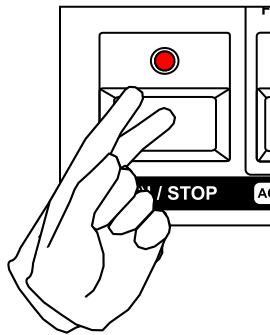

TRACKS

There are eight tracks in Engine. Tracks define a pattern or chain of patterns, along with other settings for things like MIDI channel, controller assignments, MIDI effects, etc. All eight tracks play simultaneously.

Depending on the pattern type selected, a track can play a 4-note polyphonic synth sequence, an 16-note polyphonic drum trigger sequence or 6 recorded controllers. Patterns in each track can have different lengths and timing characteristics.

SELECTING TRACKS

When Engine is powered on, it will default to TRACK SELECT (NORMAL) mode.

TRACK SELECT mode is the normal mode, when no other modes are active.

TIP: Engine remembers the state of the selected track and instrument when turning the machine off. The selected track will be recalled when turning the machine back on.

In Track Select mode the eight white buttons of the mini keyboard are used to select the track you wish to work with.

You can change the selected track by clicking one of the white mini keyboard buttons. The

TIP: The track LEDs flicker briefly each time a note is played in that track. This gives a good visual indicator of what tracks are playing. Muted tracks will not flicker.

step LEDs will change to show the programmed pattern for the selected track.

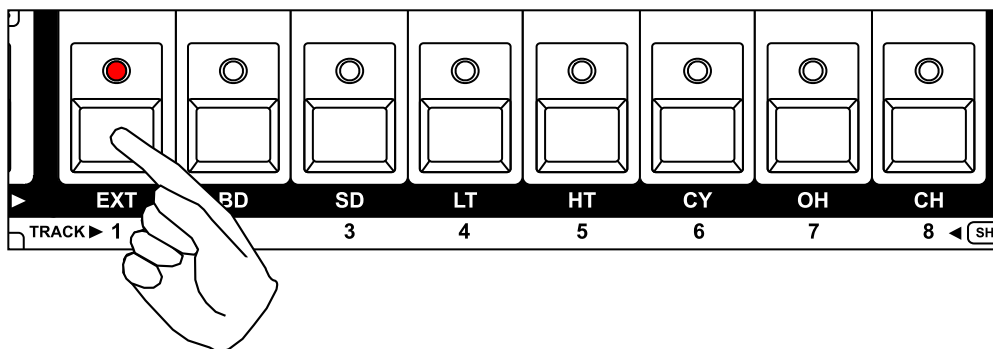

TRACKS

The Pattern Type LED will also change to show the type of pattern assigned to the selected track. For Drum type patterns the Pattern Type LED will be lit, for Synth type patterns the LED will not be lit, for Control type patterns, the LED will blink slowly.

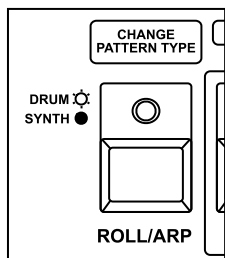

Synth type pattern

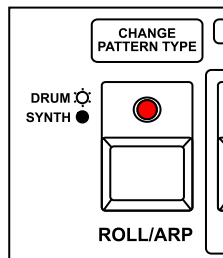

Drum type pattern

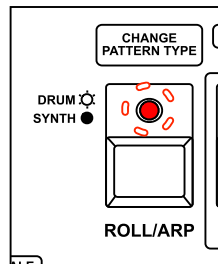

Control type pattern

SELECTING PATTERNS AND PATTERN CHAINS FOR A TRACK

TRACK SELECT mode is also where you will assign patterns or pattern chains to the selected track. While holding one of the TRACK buttons, the pattern step LEDs change to show the selected pattern for the track.

TIP: You can also double click the selected track button to pin it, then you can select patterns and pattern chains without having to hold the selected track button down. To unpin the selected track, just click the selected track button again.

While in TRACK SELECT, use the pattern step buttons and the section button to select the pattern and pattern bank assigned to the track. There are four banks of 16 patterns available per track. The section button is used to switch between the four banks.

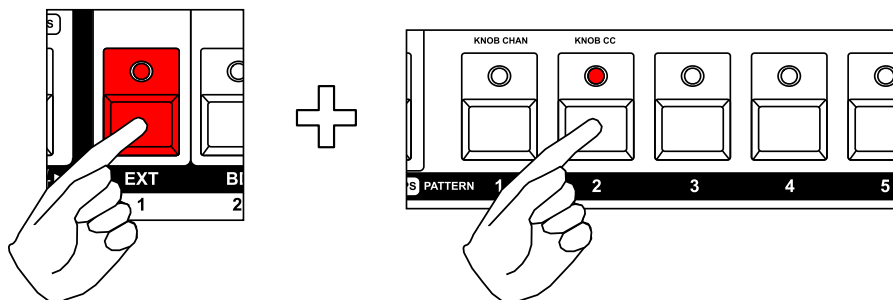

Assigning pattern 2 to track 1

TRACKS

To select a pattern chain, press and hold the pattern step button for the first pattern in the chain, then click the pattern step button for the last pattern in the chain. The pattern chain should light across all selected patterns.

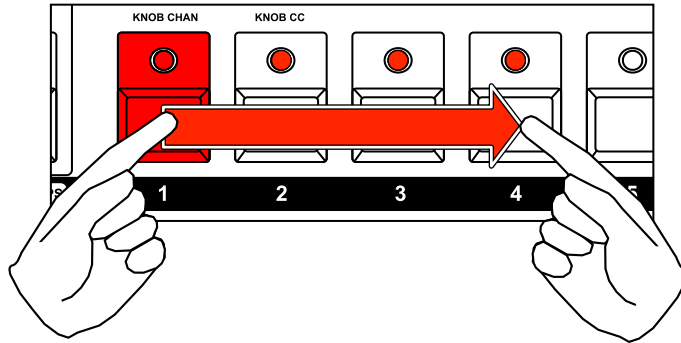

NOTE: You cannot chain patterns across multiple pattern banks.

When chaining patterns, one pattern will be shown as the current pattern for editing. This pattern is designated with a blinking LED, while other patterns in the chain are shown with bright LEDs. Other (unselected) patterns will show with dim LEDs if they contain pattern data.

To change the selected edit pattern within a chain, while still holding the selected track button, press and hold the function button and then click one of the patterns in the pattern chain to make it the edit pattern. You will only be able to select patterns within the current chain.

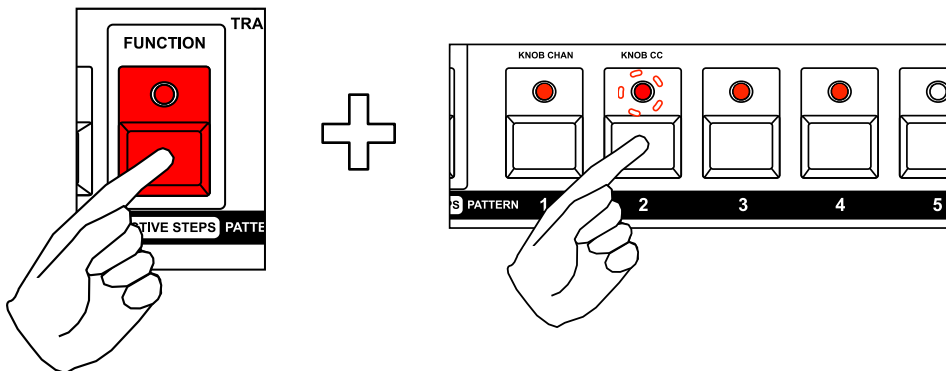

You can select different patterns and pattern chains for each of the eight tracks. The patterns and pattern banks for each track are not shared, this means there are a total of 512 patterns available across the eight tracks. You can use the pattern copy/paste functions to move patterns between tracks if needed.

TRACKS

SELECTING PATTERNS USING MIDI

Individual patterns can be selected using MIDI program change messages. There are 64 patterns per track (16 patterns x 4 banks) which can be selected with the corresponding MIDI program change number.





Each track will listen for program change messages on the MIDI channel assigned to that track.

TIP: You can disable the reception of MIDI program change messages in GLOBAL CONFIG mode. This is useful if your MIDI controller sends program changes when selecting patches and you do not wish Engine to change patterns.

TRACKS

CLEARING A TRACK

Track clearing can operate in two different ways, depending on whether you wish to just clear track settings (leaving pattern data intact), or initialize all patterns in a track to a certain pattern type.

TRACK SETTINGS		Clear all track level settings, but keep patterns as is.
CLEAR PATTERNS (SYNTH1)		Clear all (64) patterns in the track, set to SYNTH1 type patterns.
CLEAR PATTERNS (SYNTH2)		Clear all (64) patterns in the track, set to SYNTH2 type patterns.
CLEAR PATTERNS (DRUM)		Clear all (64) patterns in the track, set to DRUM type patterns.
CLEAR PATTERNS (CONTROL)		Clear all (64) patterns in the track, set to CONTROL type patterns.

To clear a track, while holding the track select button, click the CLEAR button (F sharp), then select the CLEAR method by rotating knob 1 or clicking the BACKWARD/FORWARD buttons.

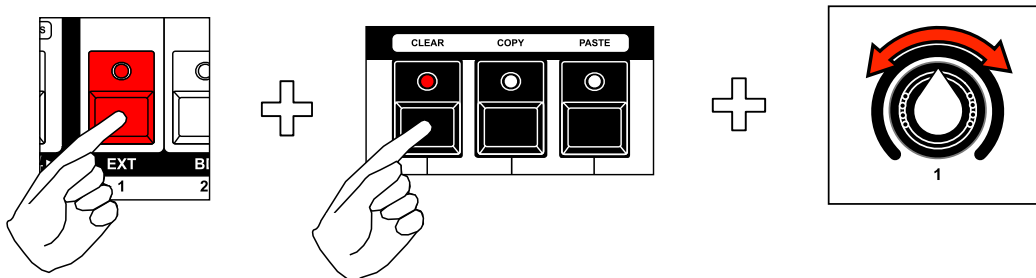

The LED display will show the clearing method. To execute the clear, click the SECTION button.

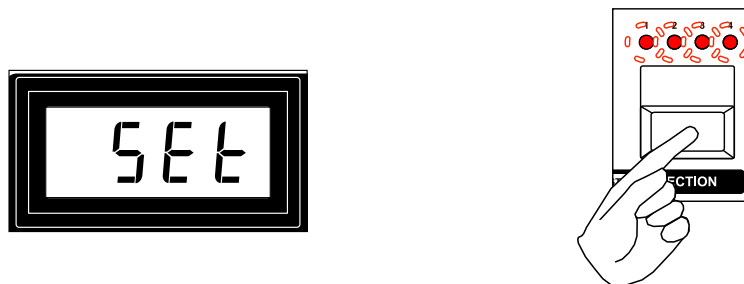

TRACKS

CLEAR TRACK SETTINGS

To clear track settings, select the "SET" clear method. Pattern data is not cleared when clearing track settings.

When clearing track settings, the cleared values are:

Selected pattern/pattern chain	Reset to pattern 1, bank 1, no chain
MIDI port and channel	Reset to port 1, channel same as track number
LFO, ROLL and ARP	Reset to basic settings
CV gate mode (if applicable)	V/Oct, Positive gate
CV tuning offset	Reset to 0
MIDI FX settings	Reset to basic settings
MIDI controller numbers	Default settings
MIDI drum note mappings	Default mapping (General MIDI)
MIDI entry, Quantize, Force to Scale	OFF, ON, All notes enabled

CLEARING TRACK PATTERNS TO A SPECIFIC TYPE

To clear all 64 patterns in a track and set them to the same pattern type, select the pattern type clear method. The type is shown on the LED display as either "DRM", "SYN1", "SYN2" or "CTRL"

After confirming by clicking the SECTION button, all patterns will be erased and set to the selected type. The track settings will be maintained.

NOTE: The track clear function is destructive and cannot be undone.

TRACKS

COPYING A TRACK

The settings for a track can be copied into the clipboard for later pasting into other tracks.

To copy a track, while holding the selected track, click the COPY button (G sharp).

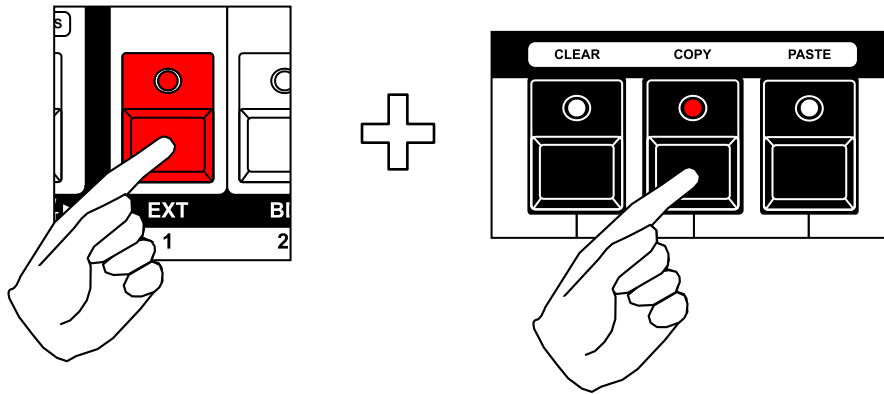

PASTING A TRACK

The current contents of the TRACK clipboard can be pasted into the currently selected track.

To paste a track, while holding the selected track, click the PASTE button (A sharp). This will overwrite the current track settings.

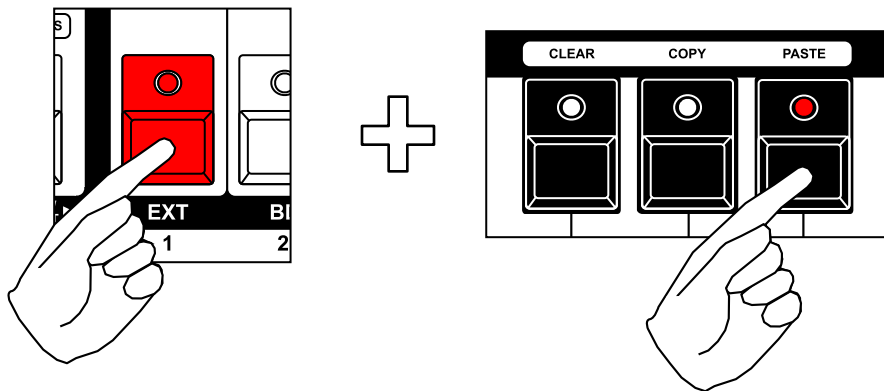

MUTING TRACKS

Each track can be muted individually for creating variations or live performance. To mute a track, while in normal mode, press and hold the MUTE button, then click the track you wish to mute or unmute. Muted tracks are shown as an unlit track LED, while unmuted tracks are shown with a lit LED.

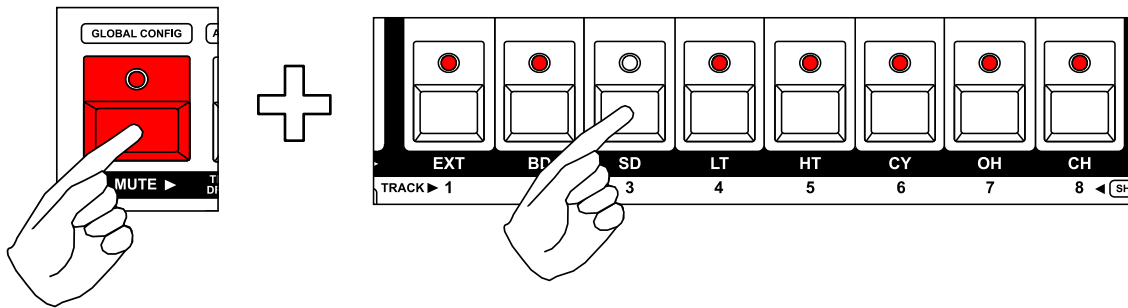

TIP: The MUTE button can be double clicked to pin the track mute function. This is useful for live performance when muting and unmuting tracks is a common action.

SOLOING TRACKS

A track can be soloed, which will mute all other tracks. To solo a track, while in TRACK SELECT (normal) mode, press and hold the MUTE button, then press and hold the FUNCTION button, then click the track you wish to solo. The selected track will be unmuted, all other tracks will be muted.

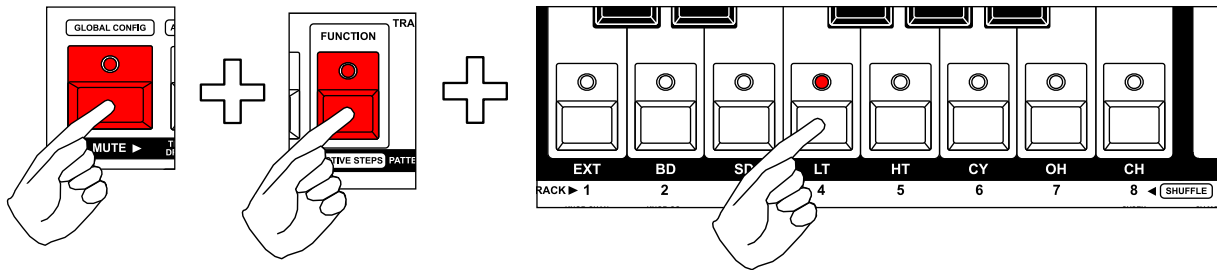

UNSOLOING TRACKS

A track that has been soloed can also be unsoloed, which will restore the track mute settings that were in place when the track was soloed. To unsolo a track, while in TRACK SELECT (normal) mode, press and hold the MUTE button, then press and hold the FUNCTION button, then click the soloed track button. The track mute settings will be restored.

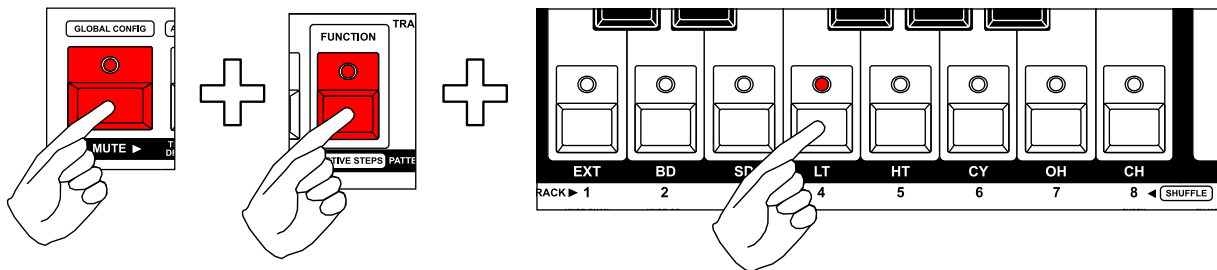

NOTE: You must unsolo a track before soloing a new track.

FUNCTION MODE

Function mode is used to perform many alternate functions on patterns and tracks. This includes functions like pattern randomize, clear/copy/paste, pattern direction, MIDI effects and UTILITY MODE.

The FUNCTION button has a colored line surrounding it, with the word FUNCTION above it. This is a visual indicator to understand the FUNCTION actions of the other buttons. Other button labels that are above the button and in a colored rectangle indicate a FUNCTION action.

To enter function mode, press and hold (or double click) the FUNCTION button.

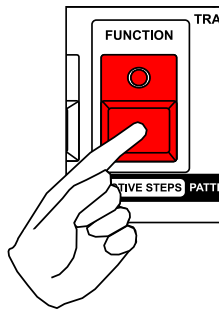

For all FUNCTION mode actions documented in subsequent sections, it is assumed that you are holding the FUNCTION button, or have double-clicked the FUNCTION button to pin FUNCTION MODE.

TRACKS

SETTING THE TRACK MIDI CHANNEL

The MIDI output channel and output port can be set for each track. To view the MIDI output channel for a track, press and hold (or double-click) the FUNCTION button, then press and hold the MIDI CHANNEL (down) button.

The display will show the port and MIDI output channel for the selected track.

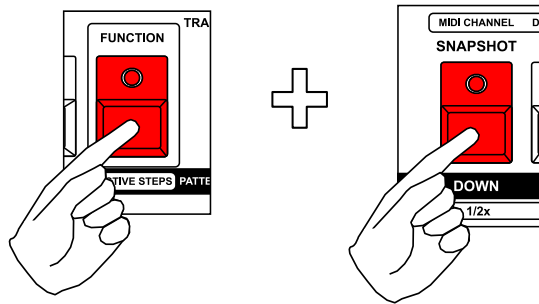

To change the MIDI channel, while in MIDI channel mode, rotate control knob 1 (or click the BACKWARDS/FORWARDS buttons). The LED display will change to show the new MIDI channel and port. The USB MIDI output port is designated as port "U".

You can also use the three sharp buttons (F sharp, G sharp, A sharp) as a shortcut to selecting the three available ports, and the 16 pattern step buttons as a shortcut to select the MIDI channel.

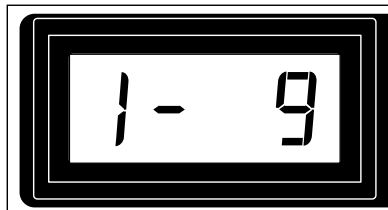

MIDI output port 1, channel 9

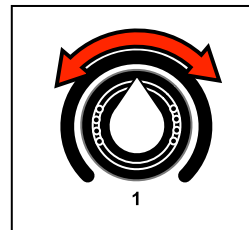

Use the track select buttons to switch tracks while in the MIDI channel mode, to quickly set the output channel for multiple tracks.

TIP: You can assign the same MIDI output channel to multiple tracks to control a single device from multiple patterns.

TIP: You can set the MIDI output channel to OFF for tracks that may be using only the (optional) CV expansion board.

TRACKS

MIDI EFFECTS

Each track has a set of MIDI EFFECTS that change how an entire pattern plays. MIDI EFFECTS are accessible in FUNCTION MODE using the control knobs.

The MIDI effects knob use a “pass-through” scheme to avoid jumps in value. This means that a knob must first pass through the current value for the setting before the knob location is used to set the value.

MIDI EFFECTS settings can be saved in snapshot locations, but are not saved with pattern data. If a new pattern is recalled, it will have the current track MIDI EFFECTS applied to it.

TIP: MIDI Effects settings are also available when in SNAPSHOT FUNCTION and SONG FUNCTION modes.

VELOCITY OFFSET

A velocity offset effect can be applied to all MIDI notes generated by the pattern. This can be either a positive or negative offset from -63 to +64.

This is especially useful when you have a mix of high velocity (accented) and unaccented notes. The velocity offset can be used as a creative volume control to fade out certain notes in the sequence or normalize all notes to a high velocity.

To set the velocity offset, while in FUNCTION MODE, rotate control knob 1. The current velocity offset value will show briefly on the LED display.

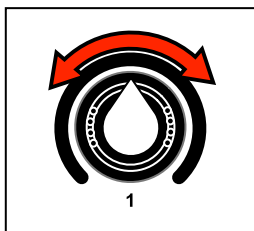

TIP: The velocity offset can also be used with control type patterns to offset control and LFO values.

TRACKS

GATE OFFSET

The gate offset effect will shorten or lengthen all gates in a pattern by up to one step. The offset can be set from -32 to +31.

The gate offset can be used creatively to change note playback from more staccato to more legato style. It is especially effective when you have a mix of notes that are longer (or have slide) and short single step notes.

TIP: The gate offset can be used to change the trigger pulse size for DRUM type patterns. Some devices require longer pulses to trigger properly

To set the gate offset, while in FUNCTION MODE, rotate control knob 2. The current gate offset value will show briefly on the LED display.

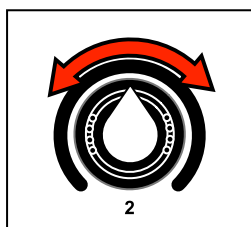

TIP: The gate offset can also be used with control type patterns and the gate signal sent by the (optional) CV output expansion board.

DELAY OFFSET

The delay offset effect will add or subtract a delay amount to the start of all programmed steps. This can be used to increase quantization or remove shuffle in realtime.

To set the delay offset, while in FUNCTION MODE, rotate control knob 3. The current delay offset value will show briefly on the LED display.

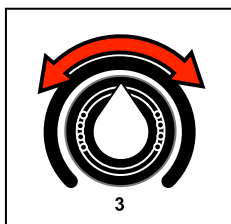





TRACKS

NOTE REPEAT

The note repeat effect creates a ratchet type effect for steps that have note repeat set. Please see the sections on GRID PROGRAMMING to learn how to set note repeat on a pattern step.

There are three distinct types of note repeat: gate, step and poly.

OFF		Programmed note repeats have no effect.
GATE		A step with note repeat enabled will quickly retrigger the same note multiple times within the space of one step. The repeat range varies from 1 to 4 repeats per step. Shown as "rPg" on the LED display for "repeat gate".
POLY		Poly repeat will sequentially play the multiple programmed pitches of a SYNTH1 type pattern within the space of one step. Shown as "POLY" on the LED display.
STEP		A step with note repeat enabled will play the pattern step multiple times before moving to the next step. The repeat range varies from 1 to 7 repeats. Applies only to SYNTH type patterns. Shown as "rPS" on the LED display for "repeat step".

The note repeat setting can be adjusted using control knob 4. The current note repeat value will show briefly on the LED display.

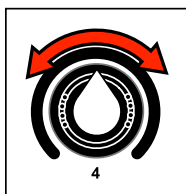

Step repeat 4

TRACKS

NOTE REPEAT - POLY MODE

There is a special NOTE REPEAT mode for SYNTH1 type patterns. In this mode, note repeats will play the programmed polyphonic pitches of a step in sequence, rather than simultaneously. This is useful for creating strumming type effects, or subdividing a step into smaller notes or different time scales.

If the current step only has one programmed pitch, poly note repeat will do nothing. If the current step has two programmed pitches, it will play both pitches, splitting the note lengths into one half the current step. For three or four pitches, the step will be divided into thirds and fourths.

When SLIDE is enabled on the current step, the played notes will be played overlapping to create slide events.

To select POLY MODE for NOTE REPEAT, while in FUNCTION MODE, rotate control knob 4 completely clockwise until the LED display reads "POLY".

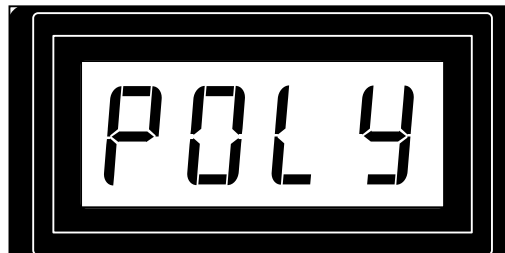
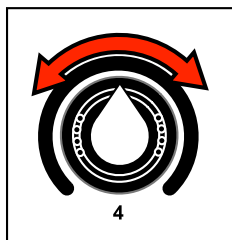

TRACKS

NOTE REPEAT DECAY

When using the note repeat effect, you can specify that each repeat will play with progressively lower velocity to create a note decay effect. This can be used to create interesting dynamics in the pattern.

The decay value is specified as the amount the MIDI velocity will decrease on each subsequent repeat. For example, if the programmed note has a velocity of 100, with step repeat of three and repeat decay of 20, then the three notes generated would be of velocities 100, 80 and 60.

The note repeat decay setting can be adjusted using control knob 5. The current decay value will show briefly on the LED display.

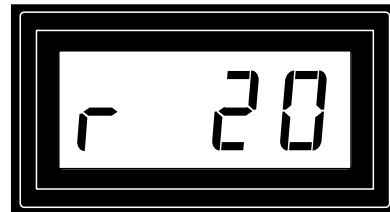
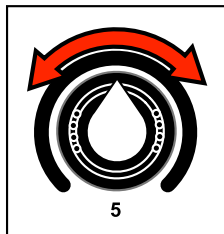

Repeat decay 20

TRACK UTILITY MODE

From FUNCTION MODE there are some additional utility functions that can be accessed with the TRACK UTILITY mode. This includes configuring the per track knob controller settings, program changes for patterns, force to scale, designating a track to listen to incoming MIDI for transposition and dumping individual patterns via MIDI system exclusive messages.

To enter TRACK UTILITY mode, click the UTILITY button while in FUNCTION mode.

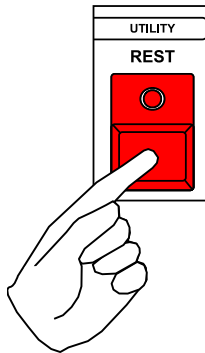

To exit TRACK UTILITY mode, click the FUNCTION button.

SETTING TRACK KNOB MIDI CHANNEL/PORT

The MIDI channel and port for each control knob can be set separately per track. This allows each control knob to be used to control a different device per track if needed. To use track controllers, set the knob channels to "tr" in GLOBAL CONFIG mode.

To set the MIDI channel for a control knob for the selected track, while in UTILITY mode, press and hold pattern step button 1, then turn the control knob you wish to set. The MIDI channel of the knob will be displayed on the LED display. You can set the channel from the range 1 to 16 or use the track defined MIDI channel.

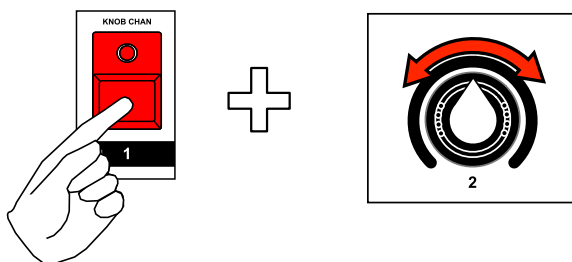

Setting MIDI channel for knob 2

If you just want to view the current MIDI channel assigned to a knob without changing it, while holding pattern step button 1, press and hold the track select button corresponding to the controller knob that you wish to view.

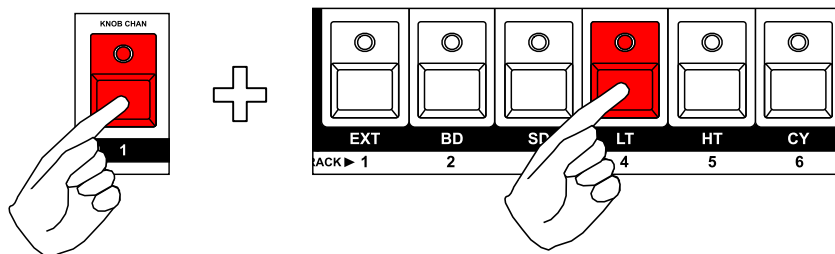

Viewing MIDI channel for knob 4

The current MIDI channel of the corresponding knob will be displayed on the LED display.

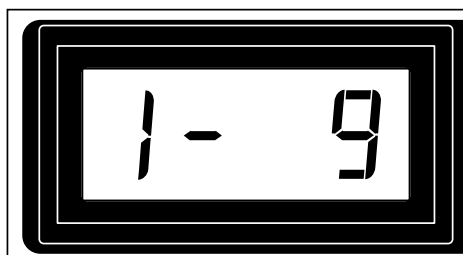



TRACKS

CONFIGURING TRACK KNOBS

When using track level knob settings, each control knob can be set separately per track. This allows each control knob to be used to control a different parameter per track if needed. To use track level settings, set the knob channels to "tr" in GLOBAL CONFIG mode.

Each knob can be configured to control one of a few different types of destinations:

MIDI CONTROLLER		The knob will send a standard MIDI controller message, usually used to control parameters of other devices. The knob can be used with any type of pattern.
TRACK MODULATOR		When used with a CONTROL TYPE pattern, the knob can be used modulate properties of other tracks, such as pitch, velocity, gate or note repeat.
MIDI NOTE		When used with a CONTROL TYPE pattern, the knob can be used to send MIDI note messages. The MIDI note used by the knob is configured with the DRUM LEARN function.

If you just want to view the current knob destination without changing it, while holding pattern step button 2, press and hold the track select button corresponding to the controller knob that you wish to view.

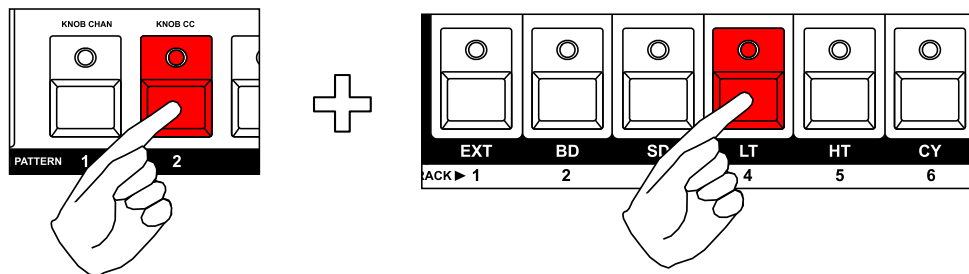

Viewing control destination for knob 4

The current destination of the corresponding knob will be displayed on the LED display.



Knob configured for MIDI controller 28

TRACKS

USING MIDI CONTROLLERS

The MIDI controller number for each control knob can be set separately per track. This allows each control knob to be used to control a different parameter per track if needed.

The corresponding control message will be sent when the knob is turned.

To set the MIDI controller number for a control knob for the selected track, while in UTILITY mode, press and hold pattern step button 2, then turn the control knob you wish to set.

The knob values will start from the bottom of the knob range at C0 (for controller number 0) to C127. Above C127, begin the values for track modulators.

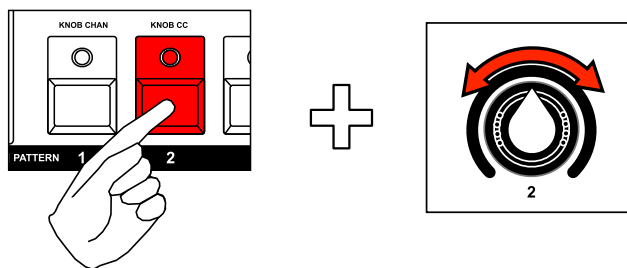

Setting destination for knob 2

The value will be displayed on the LED display.

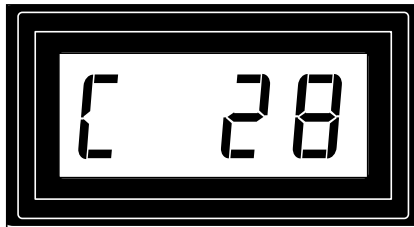

Knob configured for MIDI controller 28

TRACKS

USING TRACK MODULATORS

A control knob can also be configured to modulate other track parameters. The track parameters that can be modulated are pitch, velocity, gate time, note delay and note repeat. A knob can modulate a single track or all tracks.

NOTE: When a knob is configured for track modulation, it does not send modulation values in realtime, it can only be used to set or record values into a control type pattern. This prevents a knob from accidentally setting a track modulation value.

To set the track modulation destination for a control knob, while in UTILITY mode, press and hold pattern step button 2, then turn the control knob you wish to set. Turn the knob to the values above C127, starting with 1Pit (for track 1 pitch) and ending with ArPt (for all tracks note repeat).

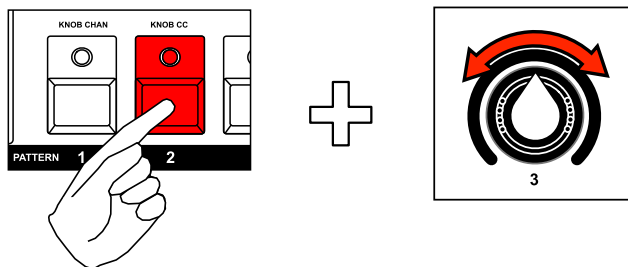

Setting the control destination number for knob

TRACK PITCH		For SYNTH type patterns playing in the target track, the pitch will be modulated. Modulation range is -64 to +63.
TRACK VELOCITY		Modulates the velocity of notes playing in the target track. For CONTROL TYPE patterns, the control value is modulated. Modulation range is -64 to +63.
TRACK GATE		Modulates the gate time of notes playing in the target track. Modulation range is -32 to +31.
TRACK DELAY		Modulates the step delay of steps playing in the target track. Modulation range is -6 to +5.
TRACK NOTE REPEAT		Modulates the note repeat setting of the target track. Modulation range is OFF to rPS8.

TRACKS

USING MIDI NOTES

Each track level control knob can also be configured to send a MIDI note message, instead of a MIDI control or track modulation message..

This allows a CONTROL TYPE pattern to be used for programming MIDI notes, useful for programming drums with more velocity control or more “analog style” sequencing using the control knobs.

The note numbers used by the six controls are set using the DRUM LEARN function, with the knob number correspond to the first six drum instruments. The knob value controls the velocity of the generated note.

To configure the control knob to send MIDI notes, while in UTILITY mode, press and hold pattern step button 2, then turn the control knob you wish to set fully clockwise.

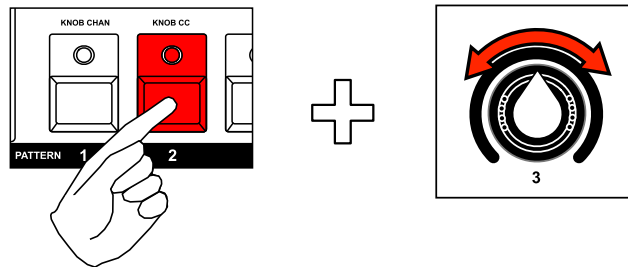

Setting control knob 3 to send MIDI notes

The setting will be displayed on the LED display.

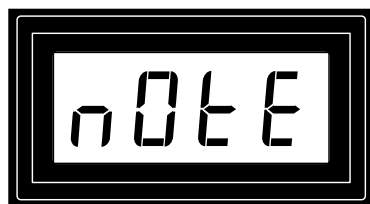

Knob configured for MIDI notes

TRACKS

PATTERN BANK AND PROGRAM CHANGE MESSAGES

A pattern can be configured to send MIDI bank select and program change messages when it is switched. This allows a pattern to change the selected patch on a synthesizer or drum machine automatically. The messages can be sent on the MIDI channel defined for the track, or on a specific MIDI channel.

The selected program change message can be set from 1 to 128 or OFF (default).

The bank least significant byte can be set from 1 to 128 or OFF (default).

The bank most significant byte can be set from 1 to 128 or OFF (default).

The MIDI channel can be set from 1 to 16 or track (default).

If the program change message is set to OFF, the bank select messages will not be sent.

TIP: The program change for all patterns will also be sent when starting the sequencer.

To define a PROGRAM CHANGE number for the current edit pattern, while in UTILITY MODE, press and hold the CHANGE PATTERN TYPE (roll/arp) button, then rotate control knob 1.

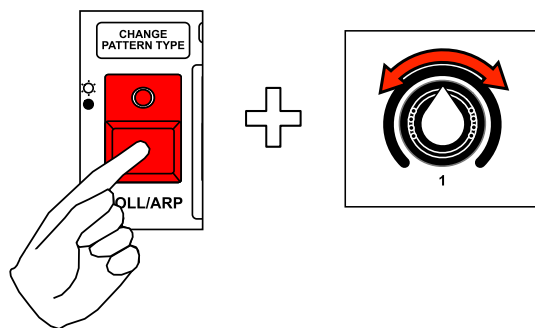

The current program number will be shown on the LED display while holding the CHANGE PATTERN TYPE button.

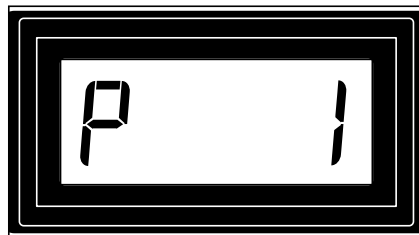

TRACKS

To define the bank select least significant byte for the current edit pattern, while in UTILITY MODE, press and hold the CHANGE PATTERN TYPE (roll/arp) button, then rotate control knob 2.

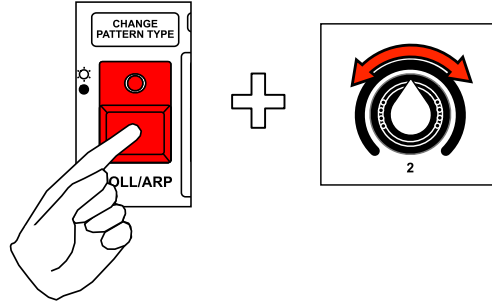

The current bank select least significant byte will be shown on the LED display while turning control knob 2.

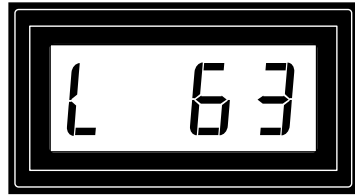

To define the bank select most significant byte for the current edit pattern, while in UTILITY MODE, press and hold the CHANGE PATTERN TYPE (roll/arp) button, then rotate control knob 3.

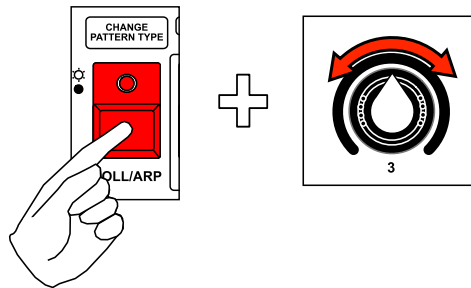

The current bank select most significant byte will be shown on the LED display while turning control knob 3.



TRACKS

To define the MIDI channel used for program select, while in UTILITY MODE, press and hold the CHANGE PATTERN TYPE (roll/arp) button, then rotate control knob 4.

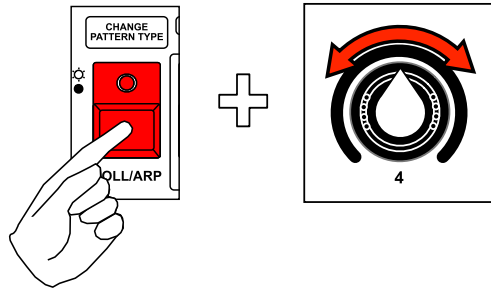

The current channel will be shown on the LED display while turning control knob 4. To send on the same channel as the defined track MIDI channel, select "tr".



NOTE: The program change will use the same MIDI output port assigned to the track.

TRACKS

SET FIXED VELOCITIES

DRUM and SYNTH2 patterns used a fixed set of velocities for playback. This is in contrast to SYNTH1 and CONTROL type patterns which have full 0-127 velocity range.

The fixed velocity values can be changed per track, allowing fine tuning of the velocities to suit the device being controlled.

DRUM type patterns use three fixed velocities for ghost, normal and accented notes.

SYNTH2 type patterns use four fixed velocities for ghost, normal, mid accent and accented notes. The mid accent velocity is always calculated dynamically as half way between normal and accented velocity. For example if normal velocity is 50 and accented velocity is 100, the mid accent velocity would be calculated as 75.

Changing the fixed velocities will dynamically affect all DRUM or SYNTH2 type patterns playing in the track.

For SYNTH1 type patterns, the fixed velocities for normal and accented notes are used when clicking the ACCENT button to set the velocity, allowing for a quick “shortcut” to setting note velocity to a certain value.

SETTING THE ACCENT VELOCITY

To set the accent velocity for the track, while in UTILITY MODE, press and hold the ACCENT button, then rotate control knob 1.

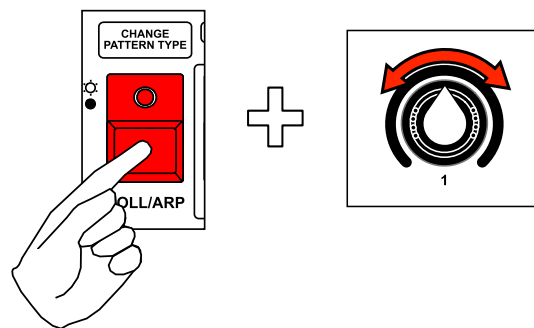

The current accent velocity will be shown on the LED display while holding the ACCENT button.



TRACKS

SETTING THE NORMAL VELOCITY

To set the normal (unaccented) velocity for the track, while in UTILITY MODE, press and hold the ACCENT button, then rotate control knob 2.

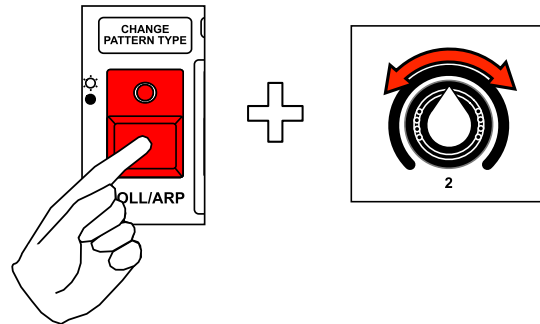

The current normal velocity will be shown on the LED display while holding the ACCENT button.



TRACKS

SETTING THE GHOST VELOCITY

To set the ghost velocity for the track, while in UTILITY MODE, press and hold the ACCENT button, then rotate control knob 3.

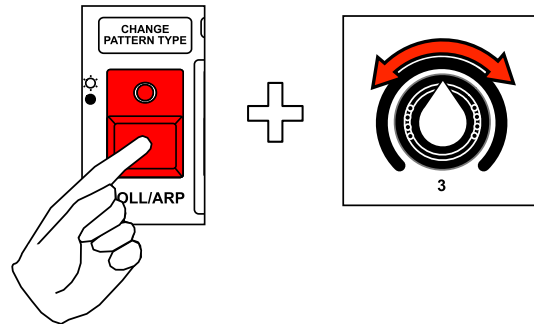

The current ghost velocity will be shown on the LED display while holding the ACCENT button.



TRACKS

SYSTEM EXCLUSIVE DUMPS

Engine patterns can be saved to an external device using MIDI system exclusive. SYSEX can be used to store individual patterns or the entire machine state.

For dumps of the entire machine state, the patterns will be placed directly into their original locations. For information on dumping the entire machine see the GLOBAL CONFIG mode.

Pattern data can also be received from other compatible machines, such as the Quicksilver TB-303, Quicksilver TR-606 and Abstrakt Instruments Avalon Bassline.

Drum type patterns can be loaded from Quicksilver 606, while synth type patterns can be loaded from Quicksilver 303 and Avalon Bassline.

Pattern dumps are sent from the current contents of the pattern COPY buffer, this means you must first copy a pattern using the PATTERN COPY function, then dump the pattern using system exclusive.

This is also true for receiving a MIDI system exclusive message for a single pattern. After receiving the pattern dump, the pattern will be placed into the pattern COPY buffer and must be pasted into the final pattern location.

To dump a single pattern via sysex, first copy the pattern to the copy buffer. Then, in UTILITY MODE, dump the pattern in the copy buffer by pressing the SYSEX (step 8) button. Your SYSEX recording utility should be listening for a single SYSEX message (in contrast to a machine state dump, which should listen for multiple messages)

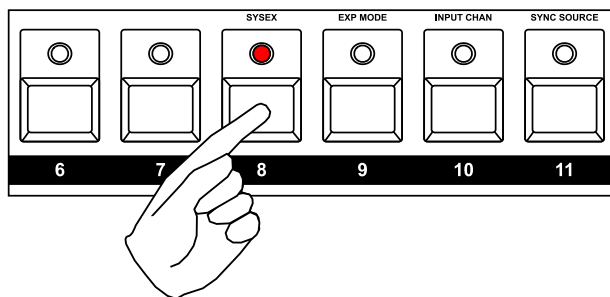

NOTE: The USB MIDI setting in GLOBAL CONFIG MODE controls whether MIDI system exclusive is sent via USB MIDI or DIN MIDI outputs. By default, USB MIDI is selected, which transfers system exclusive at much greater speed.

TRACKS

SYNTH1/SYNTH2: TRANSPOSING TRACKS USING MIDI

Each track can be configured to listen to incoming MIDI notes to apply transposition. This is extremely useful if you wish to transpose multiple tracks simultaneously. Some tracks can be assigned to transpose, while others do not transpose. Transposition applies only to SYNTH1 and SYNTH2 type patterns

To enable or disable MIDI transpose for a track, in UTILITY MODE, click the TRANSPOSE button. When transpose is enabled for the track, the TRANSPOSE LED will be lit, if transpose is disabled, the LED will be off.

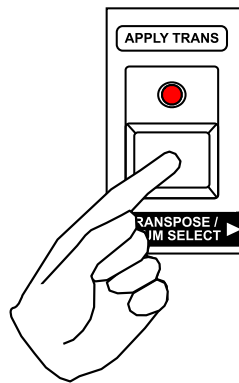

The MIDI transpose function respects the settings for MIDI input channel and track channels, this means that you can transpose different tracks using different input devices, which can be a creative option.

TRACKS

SYNTH1/SYNTH2: SETTING STEP PITCH USING MIDI

Each track can be configured to listen to incoming MIDI notes to set the pitch of a selected step in grid recording. This is useful if you wish to use an external controller to set the pitch of steps or enter chords in grid recording.

To enable or disable MIDI pitch entry for a track, in UTILITY mode, click the OCTAVE DOWN button. When MIDI pitch entry is enabled for the track, the OCTAVE DOWN LED will be lit, if MIDI pitch entry is disabled, the LED will be off.

MIDI pitch entry respects the settings for MIDI input channel and track channels.

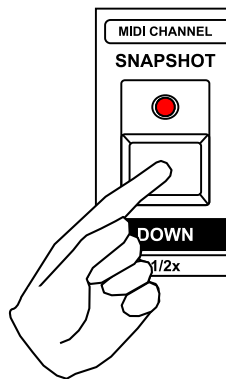

TRACKS

TRACK QUANTIZATION

Quantization can be enabled or disabled per track. Quantization only applies to input during realtime recording of synth type patterns.

Quantization is enabled by default. This forces incoming notes to be a multiple of 50% gate length, the same as a 303 type sequencer. The beginning of a note will be hard quantized to the step.

When quantization is disabled, the gate length of the note will be set to the nearest clock tick, allowing more expressive sequences to be captured. The start of the note will be recorded with the nearest delay value for the step.

To enable or disable TRACK QUANTIZATION, while in UTILITY MODE, click the TIME button.

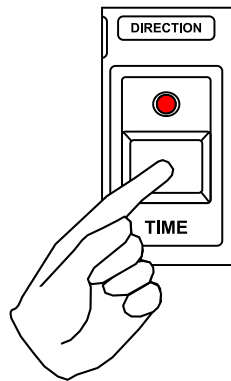

When quantization is enabled, the TIME LED will be lit, when quantization is disabled, the TIME LED will be unlit.

NOTE: Note start time (step delay) does not apply to SYNTH2 type steps.







TRACKS

CV/GATE OUTPUT MODES

When the CV/Gate output expansion board is installed, each track can be configured to send out CV using either 1V/Octave, Hz/Volt or 1.2V/Octave and Gate using either positive trigger or negative trigger. This allows the CV outputs to be used with a wide range of different analog devices. Each of the eight tracks can have a different setting for CV MODE.

NOTE: The CV MODE can only be set when the CV/Gate expansion board is installed and enabled.

The available modes are:

POSITIVE GATE, 1V/OCTAVE		Positive gate, 1 volt per octave
NEGATIVE GATE, 1V/OCTAVE		Negative gate, 1 volt per octave
POSITIVE GATE, Hz/V		Positive gate, hertz per volt
NEGATIVE GATE, Hz/V		Negative gate, hertz per volt
POSITIVE GATE, 1.2V/OCTAVE		Positive gate, 1.2 volts per octave
NEGATIVE GATE, 1.2V/OCTAVE		Negative gate, 1.2 volts per octave

TRACKS

SETTING CV/GATE MODE

To set the CV MODE for a track, while in UTILITY MODE, press and hold EXP MODE (step 9) button. Then rotate control knob 1 or click BACKWARD/FORWARD to select the desired mode.

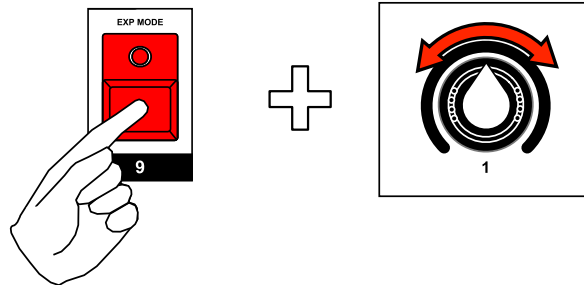

The current CV/Gate output mode will be shown on the LED display while holding the EXP MODE button.



TRACKS

DISABLE/ENABLE TRACK CV SLIDE

The slide circuit for a track using the CV/Gate output expansion can be completely disabled if required. This means that playing legato or patterns that have programmed slide will not create a CV slide, instead they jump immediately to the next pitch.

NOTE: The TRACK SLIDE can only be changed when the CV/Gate expansion board is installed and enabled.

To enable or disable the slide circuit for a track, while in UTILITY MODE, press and hold EXP MODE (step 9) button. Then rotate control knob 2 to enable or disable slide. You can also use the BACKWARDS and FORWARDS button to change the value.

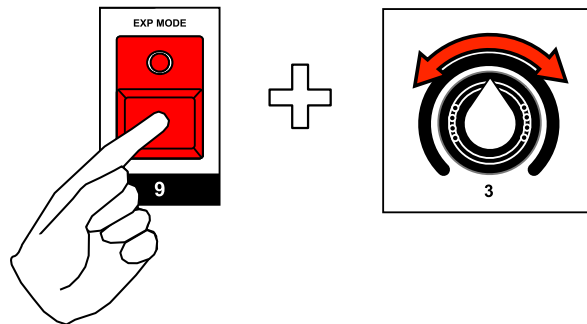

The current slide circuit setting will be shown on the LED display while continuing to hold the EXP MODE button.



Slide is enabled for the track

TRACKS

CV TUNING OFFSET

The CV output for the track can be tuned up or down in small increments if required.

NOTE: The CV TUNING OFFSET can only be set when the CV/Gate expansion board is installed and enabled.

The available values in the range of -512 to +511 (using control knob 3 to set the value will have a slightly smaller range) The tuning will change by 1 cent for about every five values in Volt/Octave mode.

To set the CV TUNING OFFSET for a track, while in UTILITY MODE, press and hold EXP MODE (step 9) button. Then rotate control knob 3 to select the desired offset. You can also use the BACKWARDS and FORWARDS button to change by one value at a time.

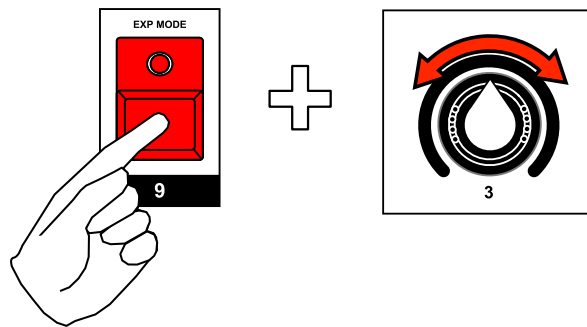

The current offset value will be shown on the LED display while continuing to hold the EXP MODE button.

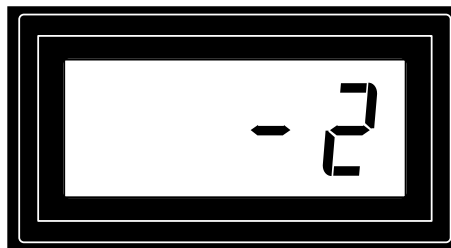

TRACKS

FORCE TO SCALE









Each track can be forced to output only notes in a selected scale. This can be useful when composing or transposing patterns.

The CHORD MEMORY function specifically does not use the force to scale function.

The scale can be changed any time and does not change the actual notes stored in the pattern, rather the notes output by a pattern are forced into the new scale in realtime.

When attempting to play a note that is not in the defined scale, the next lowest note will be played instead.

The force to scale feature includes 7 preset scales and 1 user scale. The root note can also be set for each scale.

User		User defined pitches.
Chromatic		All twelve pitches are part of the scale.
Major		Includes pitches in the intervals: whole, whole, half, whole, whole, whole, half
Minor		Includes pitches in the intervals: whole, half, whole, whole, half, whole, whole
Dorian		Includes pitches in the intervals: whole, half, whole, whole, whole, half, whole
Mixolydian		Includes pitches in the intervals: whole, whole, half, whole, whole, half, whole
Harmonic Minor		Includes pitches in the intervals: whole, half, whole, whole, half, whole+half, half
Blues		Includes pitches in the intervals: whole+half, whole, half, half, whole+half, whole

TRACKS

SELECTING THE ROOT NOTE

To select the root note of the scale for a track, while in **UTILITY MODE**, rotate control knob 1 to select the desired root note.

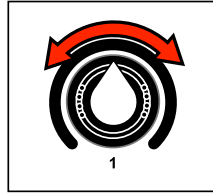

The LEDs of the mini keyboard will light to show the pitches of the selected scale, according to the selected root note. The LED display will show the selected root note along with the selected scale preset.

Sharp notes are designated with the decimal point next to the root note on the LED display.

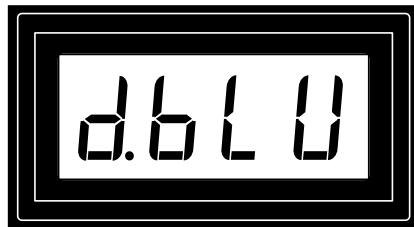

The root note D# with the blues scale

TRACKS

SELECTING THE SCALE PRESET

To select the scale preset for a track, while in UTILITY MODE, rotate control knob 2 to select the desired preset.

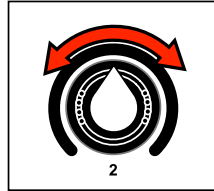

The LEDs of the mini keyboard will light to show the pitches of the selected scale, according to the selected root note. The LED display will show the selected scale preset along with the current root note.

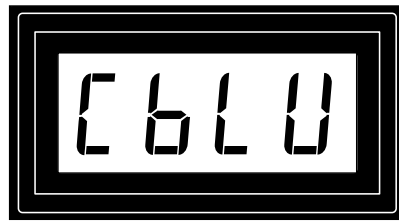

The blues scale preset, with root note C

TRACKS

SETTING THE USER SCALE

To define the user scale, while in UTILITY MODE, first select the “user” scale preset. Then click the mini keyboard buttons to turn on/off the notes of the scale. The user scale can also be transposed according to the root note.

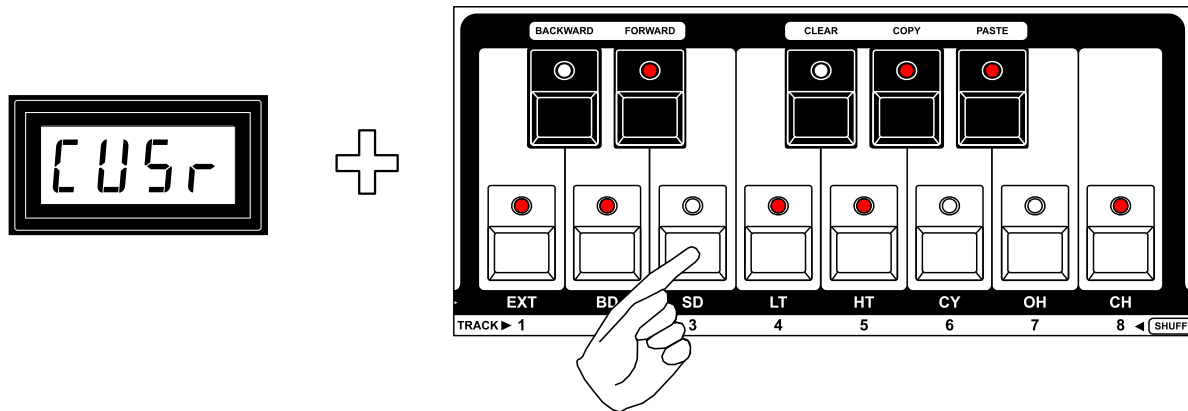

SAVING THE USER SCALE

Once a user scale has been configured, it can be saved as the user preset.

Saving the user preset will automatically apply the preset (and root note) to any other tracks that are set to use the user preset. This makes it quick to force all tracks to use the same scale.

If the user preset is not saved, each track can have a different scale configured under the user scale.

To save the user preset, while in UTILITY MODE, click the RECORD button.

TIP: The RECORD LED will light to show if the user preset has been modified from the stored value.

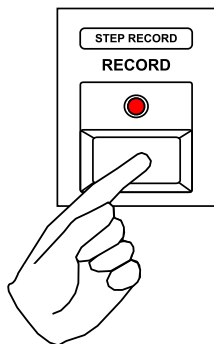

PATTERNS

Patterns are where the programming action takes place. Patterns and pattern chains are assigned to tracks, selecting patterns was covered in the TRACK SELECT section of the manual.

Each pattern has separate settings for PATTERN TYPE, LENGTH, TIME SCALE, SHUFFLE and SKIPPED STEPS. This means that you could have patterns within a pattern chain that have completely different settings, which can create interesting variations on timing and groove.

PATTERN TYPES

Engine has four different types of patterns, DRUM type patterns, SYNTH1 type patterns SYNTH2 type patterns and CONTROL type patterns.

TIP: Each pattern type has different capabilities for programming, but that doesn't mean that a drum type pattern couldn't be used to sequence a synth for example.

Tracks can have any combination of drum, synth1, synth2 or control type patterns, meaning you can use any type of pattern in any of the eight available tracks.

In the next sections we will cover the different pattern types and how they can be used.

CHANGING PATTERN TYPES

Any pattern can be changed to a DRUM, SYNTH1, SYNTH2 or CONTROL type pattern at any time. This allows for any mix of pattern types in any track.

The current pattern type is visible on the PATTERN TYPE led, with DRUM patterns showing a lit LED, SYNTH1 and SYNTH2 type patterns showing an unlit LED and CONTROL type patterns showing a slow blinking LED.

To change the current pattern type, press and hold (or double click) the FUNCTION button, then press and hold the CHANGE PATTERN TYPE (roll/arp) button. While holding CHANGE PATTERN TYPE, rotate control knob 1 or click BACKWARD/FORWARD to select a new pattern type.

The four section LEDs will blink to warn that this operation is destructive. To confirm the pattern type change, click the SECTION button.

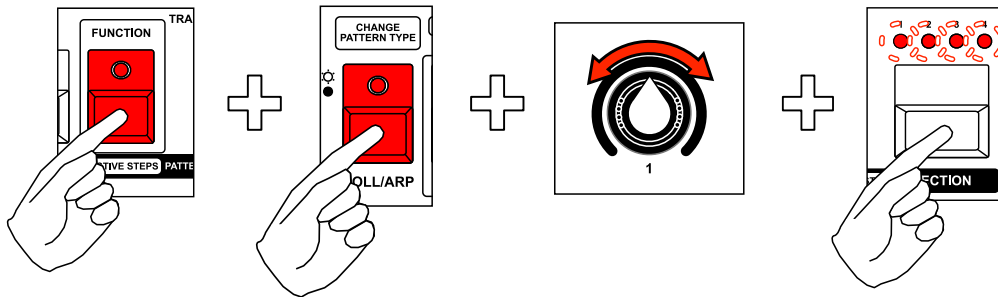

Changing the pattern type is a destructive operation, meaning that the programmed notes in a sequence will be erased when changing the type! This is necessary because the pattern memory format for each type of pattern is completely different.

You can immediately UNDO an accidental pattern type change by clicking the RECORD button, while still holding FUNCTION and CHANGE PATTERN TYPE buttons. The RECORD LED will light when UNDO is available.

REST MODE

REST mode is used to temporarily mute a playing pattern and play live from the keyboard. The behavior of REST mode changes depending on the current pattern type.

To enter REST mode, from NORMAL mode, hold or double-click the REST button. You can now use the mini-keyboard and control knobs or an external controller to play events live through the track.

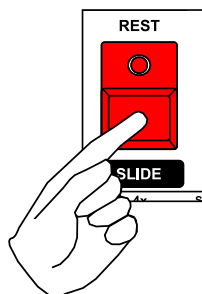

For DRUM type patterns, only the 16 drum notes used in the track drum mapping will be played.

For SYNTH1 type patterns, notes will be played monophonically with slides created for multiple notes and a note buffer to allow sliding back to a held note. CHORD MEMORY and FORCE TO SCALE will also be applied to live notes.

For SYNTH2 type patterns, notes will be played polyphonically with FORCE TO SCALE applied. CHORD MEMORY will also be applied up to 4 simultaneous notes.

For CONTROL type patterns, the six controllers assigned to the control knobs can be used as normal, but any LFO or programmed control events will be muted.

REST mode can also be used to move directly into REPLACE RECORD mode, this is useful for practicing playback and then moving into record mode seamlessly.

ADAPTIVE RECORD MODE

Engine includes a unique recording mode called “adaptive record”. Adaptive record essentially records a performance at any speed with the sequencer stopped and then dynamically “fits” the performance into the current pattern.

NOTE: Adaptive record only applies to SYNTH1, SYNTH2 and DRUM type patterns.

This is especially useful for playing a sequence exactly as imagined without trying to play against a metronome or recording in realtime.

SETTING UP FOR ADAPTIVE RECORD

To set up for adaptive record, first create a pattern or pattern chain that is the length and timing you wish the final result to be (using TIME MODE). For example, a long pad progression over 64 steps at 4x time scale.

INITIATING ADAPTIVE RECORD

Now, initiate adaptive record. With the sequencer stopped, hold the RECORD button and click the TIME button. The TIME and RECORD LEDs will blink to indicate ADAPTIVE RECORD is active.

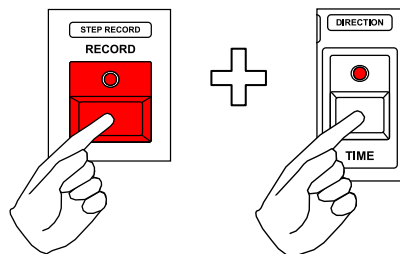

Now, play the performance using a MIDI controller or the mini keyboard on Engine. Adaptive record starts with the first note. The speed (tempo) of the performance doesn't matter, but try to keep accurate relative timing for the notes.

NOTE: The maximum length for an adaptive performance is about 76 seconds.

PATTERNS

ENDING ADAPTIVE RECORD

When the performance would naturally loop (end), click the RUN/STOP button to indicate the end of the performance. Engine will now take the recorded events and apply them to the current pattern and begin playback immediately.

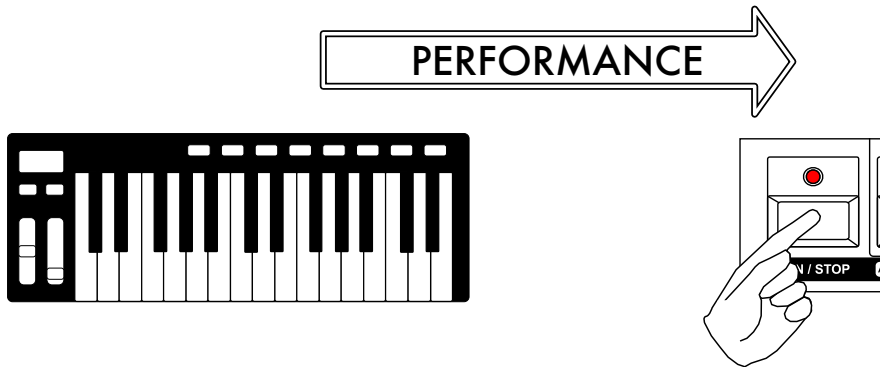

If you wish to leave adaptive record without recording any performance, just click the RECORD button.

REPLACE RECORD MODE

Normal REALTIME RECORD mode acts as an OVERDUB record mode which does not erase any existing events during recording. It is possible to use REPLACE RECORD mode to erase events while recording, this is useful to clear a track manually, or introduce momentary “gaps” in a pattern.

REPLACE RECORD is useful when recording a live performance, such as polyphonic notes, so that any existing data is removed as new data is recorded.

To enter REPLACE RECORD mode, from NORMAL mode, hold the REST button and hold or double-click RECORD. You can also enter REPLACE RECORD mode directly from REST mode by holding or double-clicking RECORD.

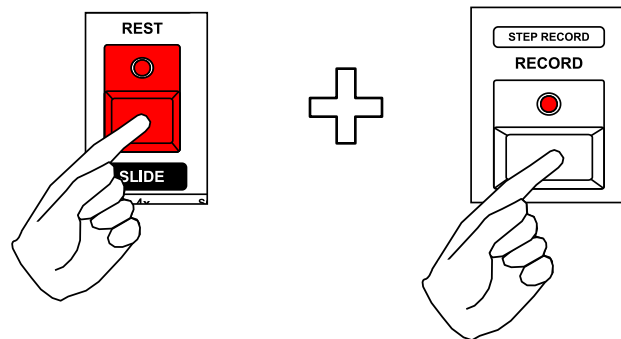

REPLACE RECORD will automatically exit after one complete loop of the current pattern, this is helpful so that you do not accidentally record over a recorded performance when the pattern loops.

PAUSE RECORD MODE

PAUSE RECORD mode will automatically start the sequencer in RECORD (or REPLACE RECORD) on the first note played. This is extremely useful to have a sequence start recording precisely on the downbeat.

To use PAUSE RECORD, with the sequencer stopped, hold RECORD and then click RUN/STOP. Both the RECORD and RUN LEDs should blink to indicate PAUSE RECORD is active.

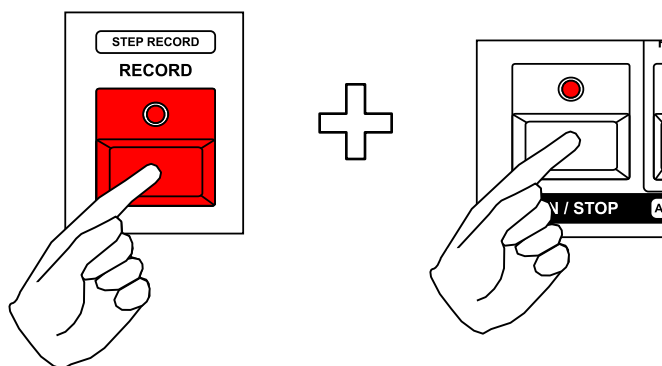

To start the sequencer playing and recording automatically, play a note from the mini-keyboard or an external controller, or turn a control knob for a CONTROL type pattern.

If you started in REPLACE RECORD, it will automatically switch to normal RECORD after one pattern loop.

PAUSE RECORD also works in ARPEGGIATOR and DRUM ROLL modes.

To exit PAUSE RECORD mode you can click the RUN/STOP or the RECORD button. Clicking RUN/STOP will start the sequencer in RECORD mode.

TIME MODE

Time mode is used to set all of the timing parameters for a pattern. This includes the pattern length, timing scale, shuffle and skipped steps. An initialized pattern is automatically set to a length of 16 steps, 4/4 timing, zero shuffle with no skipped steps.

The TIME button has a black line surrounding it, with the word TIME below it. This is a visual indicator to understand the TIME functions of the other buttons. Other button labels that are below the button and in a white rectangle surrounded by black indicate a TIME function.

To enter time mode, press and hold (or double click) the TIME button.

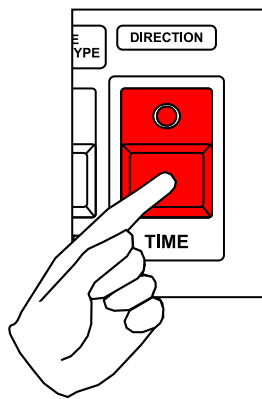

For all TIME MODE functions documented in subsequent sections, it is assumed that you are holding the TIME button, or have double-clicked the TIME button to pin TIME MODE.

PATTERNS

SETTING PATTERN LENGTH

The pattern length is set by selecting the last step of the pattern. The last step can be set in any of the four pattern sections, allowing a maximum pattern length of 64 steps.

When changing the pattern length while the sequencer is running, the change will not take effect until the pattern loops.

In TIME mode, the section button can be used to select between the four sections of the pattern.

The last step of the pattern is shown on the pattern step LEDs if the last step is within the selected section. If the last step is not in the current selected section, the section LED for the section which contains the last step will light dimly.

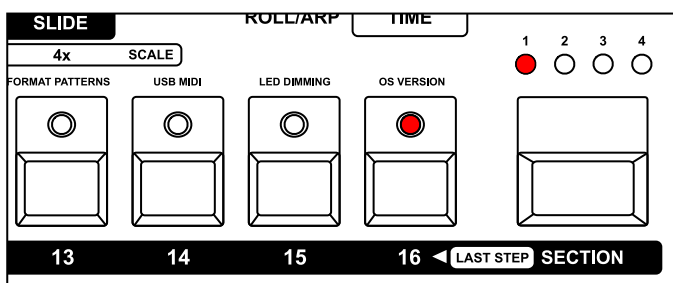

Last step set to step 16

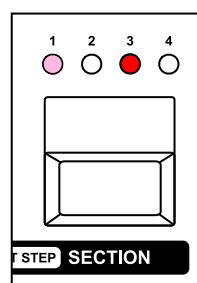

Last step in section 1

To set a new pattern length, while in TIME mode, select the section which will contain the new last step and click the pattern step button for the desired last step. For example, to set a pattern to be 28 steps long, select section two and click the pattern step button 12.

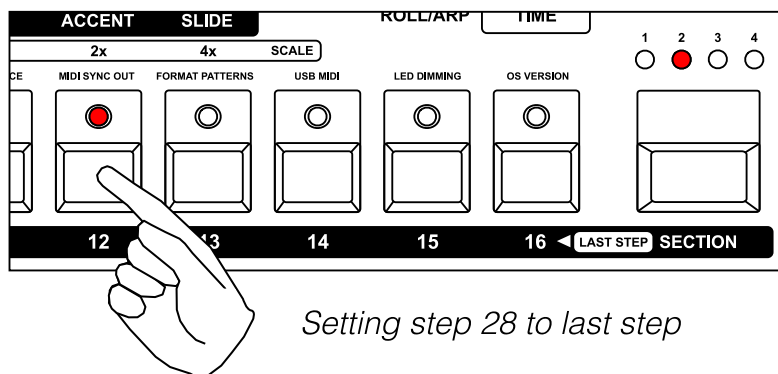

Setting step 28 to last step

Setting the last step this way will reactivate any skipped steps in the pattern. To change the pattern length without reactivating skipped steps, you must use the ACTIVE STEPS function to skip or activate steps at the end of the pattern.

EXTENDING A PATTERN

Sometimes you may wish to increase the length of a pattern during live performance. If you just set the length, there could be empty sections played until new notes are entered into the pattern, which would disrupt the flow of the performance. In order to avoid this situation, use the PATTERN EXTEND function.

PATTERN EXTEND will copy the notes from the previous section into subsequent sections automatically, this allows the pattern to play uninterrupted while continuing to edit the longer pattern. Extend also works well when creating variations on an existing pattern, because you don't have to manually re-enter all of the note events to make a small change.

To extend a pattern, while in TIME mode, press and hold the RECORD button while clicking the SECTION button. For example, to extend a pattern from 16 to 32 steps, starting with section one selected, press and hold RECORD, then click the section button to copy section one to section two. The last step of the pattern will also be changed automatically from step 16 to step 32.

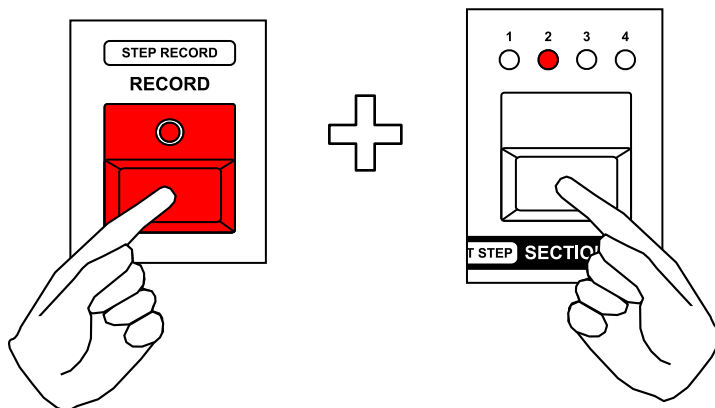

PATTERNS

COPYING A PATTERN SECTION

The SECTION copy function allows the current selected section of a pattern to be copied and then pasted into a different section of the pattern. This is similar to the EXTEND function, but is more flexible in some cases.

To COPY a section, while in TIME MODE, first select the section you wish to copy by clicking the SECTION button.

Now hold the FUNCTION button and click the COPY button.

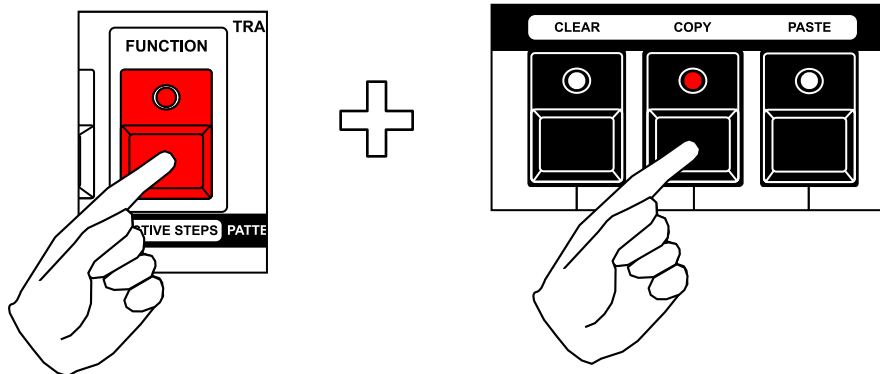

PASTING A PATTERN SECTION

The SECTION paste function allows a copied section to be pasted into the currently selected section of the pattern.

To PASTE a section, while in TIME MODE, first copy a section, then select the section you wish to paste into by clicking the SECTION button.

Now hold the FUNCTION button and click the PASTE button.

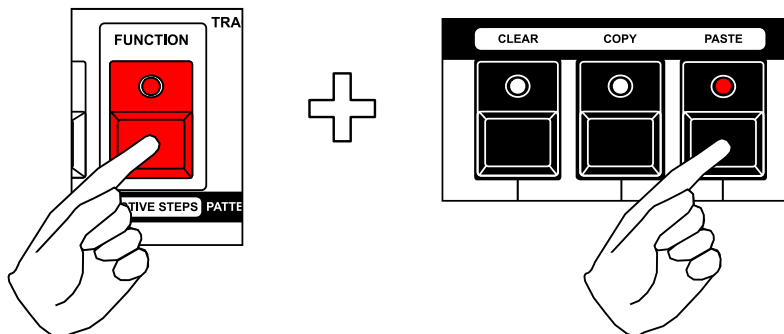

PATTERNS

CLEARING A PATTERN SECTION

The SECTION clear function will clear the currently selected section of the pattern.

Clearing a section will set all steps in that section to RESTS, it does not deactivate the steps.

To CLEAR a section, while in TIME MODE, first select the section you wish to clear by clicking the SECTION button.

Now hold the FUNCTION button and click the CLEAR button.

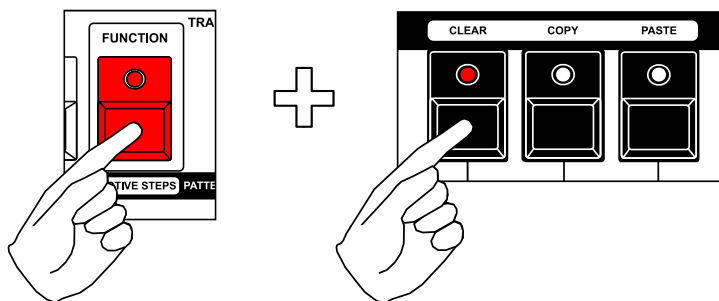

TRANSPOSING A PATTERN SECTION

The SECTION transpose function allows transposition of the currently selected section of the pattern.

To transpose a section, while in TIME MODE, first select the section you wish to transpose by clicking the SECTION button.

Now hold the FUNCTION and TRANSPOSE buttons. While holding FUNCTION and TRANSPOSE the mini-keyboard and octave DOWN/UP buttons can be used to transpose the current section.

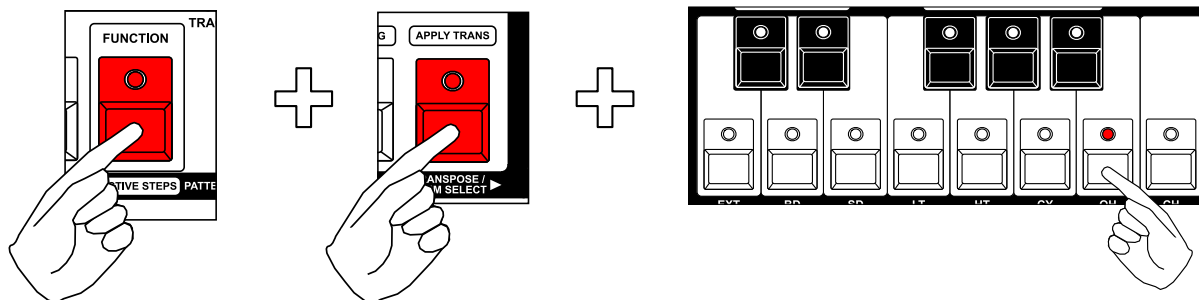

NOTE: Section transpose only applies to SYNTH1 and SYNTH2 type patterns.

PATTERNS

SETTING PATTERN TIME SCALE

Patterns can be assigned different timing scales, which changes the “resolution” of the pattern steps.

This is also useful for setting the speed that a pattern plays back for polyrhythmic sequencing.

There are eight available timing scales to choose from:

1/2x	each step represents 1/32 note
1x	each step represents 1/16 note (default)
2x	each step represents 1/8 note
4x	each step represents 1/4 note
1/2x (triplet)	each step represents 1/32 note triplet
1x (triplet)	each step represents 1/16 note triplet
2x (triplet)	each step represents 1/8 note triplet
4x (triplet)	each step represents 1/4 note triplet

The current time scale of the pattern is displayed on the four attribute LEDs, the 4/4 scales are shown with a brightly lit LED while the triplet version of the scale is displayed with a dimly lit LED.

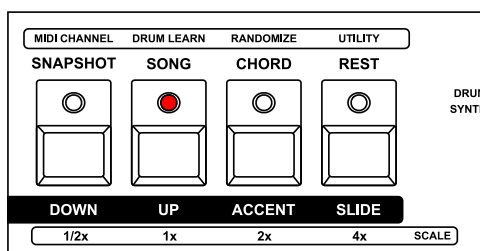

1x setting for 4/4 16th notes

PATTERNS

To change the timing scale of a pattern, while in TIME mode, click one of the four attribute buttons. To change to the triplet version of a scale, double-click one of the four attribute buttons.

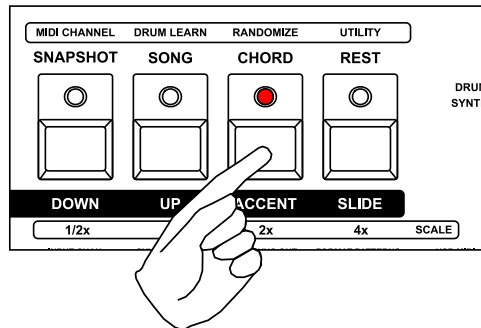

Changes to the time scale while the sequencer is running will not take effect until the pattern loops, this keeps the pattern in sync during live performance.

TIP: As a convenience, when switching scales between 4/4 and triplet, the last step is automatically changed to keep the pattern in sync. For example, switching from 1x time scale to 1x (triplet) on a 16 step pattern will automatically change the last step to step 12. The last step can be freely changed to any other step as needed.

PATTERNS

SETTING PATTERN SHUFFLE

Each pattern can have separate shuffle timing during playback. The amount of shuffle available depends on the selected time scale.

Patterns with different time scales have the following shuffle levels available (including no shuffle):

1/2x	7 levels of shuffle
1x	13 levels of shuffle
2x	15 levels of shuffle
4x	15 levels of shuffle

The current shuffle level is displayed on the LEDs of the mini keyboard, with level one meaning "no shuffle".

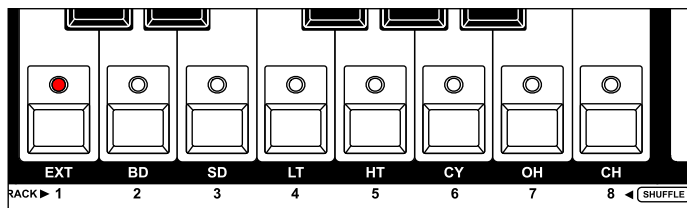

No shuffle currently applied

To change the shuffle level, while in TIME mode, use the white mini keyboard buttons. You can click a single button or two adjacent buttons to select the various shuffle levels.

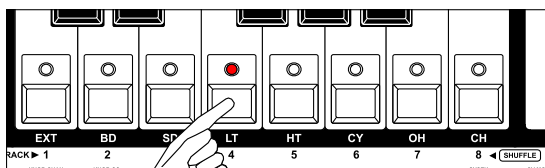

Setting to shuffle level 7

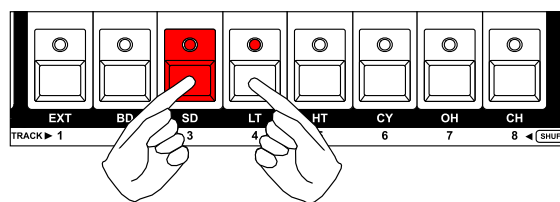

Setting to shuffle level 6

If the shuffle level is not available for the current time scale, the level cannot be selected.

Changes to the shuffle level while the sequencer is running will not take effect until the pattern loops.

PATTERNS

SKIPPING PATTERN STEPS

It is possible to generate interesting pattern variations and timings by setting some steps to be skipped during playback. This capability is a more "advanced" function of TIME mode.

To see the current active steps, while in TIME mode, press and hold the FUNCTION button. The active steps will be shown with brightly lit pattern step LEDs. While continuing to hold the FUNCTION button, you can deactivate steps by clicking pattern step buttons.

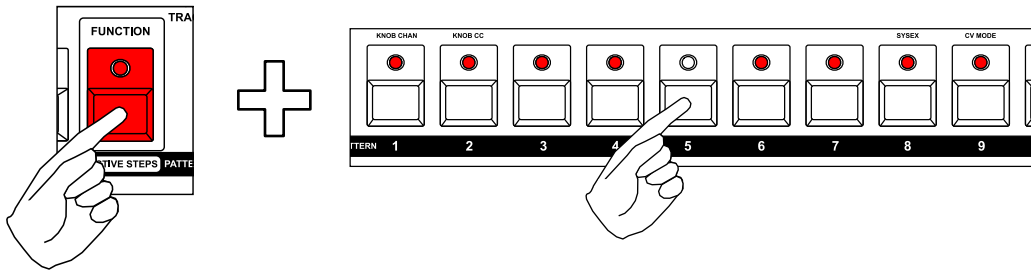

TIP: You can also quickly specify a range of steps to be active by holding one step button and then clicking a second button to specify the range. All other steps will be set to inactive.

Skipped steps will be immediately deactivated, even while the sequencer is running. This means it is possible for a pattern lose sync with other playing tracks. In this case it may be useful to realign the pattern using the REALIGN function.

TIP: You can automatically set the last step and all previous steps to active by double-clicking a pattern step button.

NOTE: Setting the last step using the PATTERN LENGTH function will automatically reactivate any skipped steps.

PATTERNS

REALIGN A PATTERN

It is possible to realign a pattern if it falls out of sync with other tracks. This is particularly useful if the pattern has fallen out of sync because of changes to the pattern length or skipped steps.

To realign the pattern, while in TIME mode, press and hold the FUNCTION button and then click the RUN/STOP button. The pattern will realign itself when all tracks have looped.

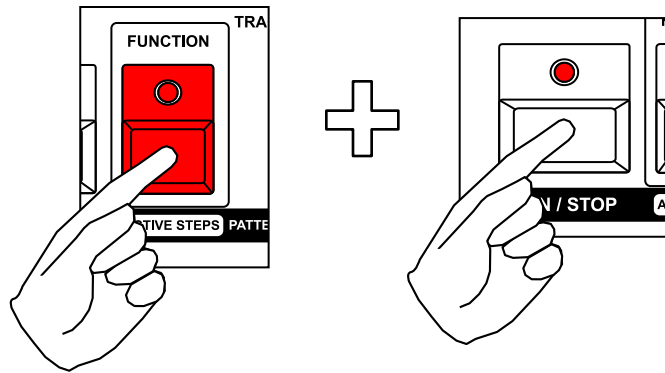

PATTERNS

TEMPO LOCK

The tempo lock function can be used to prevent the internal tempo from being changed when moving the tempo knob. This is useful in live situations where accidental changes of the tempo are unacceptable.

TIP: Tempo Lock also controls whether the stored tempo in a snapshot is restored when the snapshot is recalled.

To engage the tempo lock, while in TIME MODE, click the black “A sharp” button on the mini keyboard. The LED will light to show that tempo lock is active. To disengage, click the A sharp button again.

When disengaging tempo lock, the tempo knob will only begin changing tempo after it passes through the current tempo value.

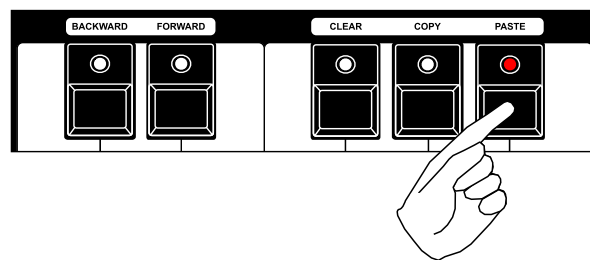

TAP TEMPO

It is possible to manually enter a tempo using the tap tempo function. This is useful when setting a tempo in relation to another sound source.

To set the tempo using tap tempo, first engage the tempo lock. While tempo lock is engaged, the black “F sharp” button on the mini keyboard can be tapped in time to establish the current tempo. The new tempo will be displayed on the LED display.

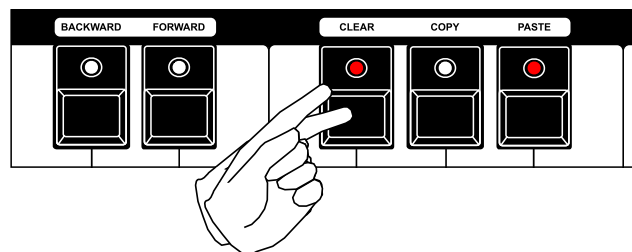

PATTERNS

INCREMENT/DECREMENT TEMPO

In TIME MODE, the current tempo can be changed incrementally while the tempo lock is engaged. This allows the tempo to be adjusted manually without disengaging the tempo lock.

To set the tempo incrementally, use the BACKWARDS and FORWARDS (C sharp and D sharp) buttons on the mini keyboard. Clicking the BACKWARDS button will decrement the tempo, clicking the FORWARDS button will increment the tempo. The new tempo will be displayed on the LED display.

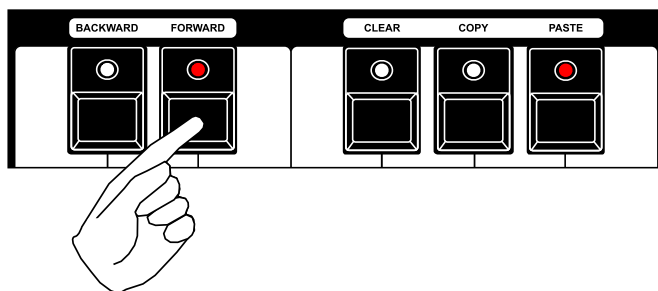

If you continue to hold the button, the tempo will begin to increment or decrement continuously.

DRUM TYPE PATTERNS

Drum type patterns are well suited for programming percussion sequences. A drum pattern has sixteen individual drum instruments that can be programmed, allowing a complete drum sequence to be created using a single track.

SELECTING DRUM INSTRUMENTS

Drum instrument selection is split into two groups of eight instruments.

The drum instruments are labeled as EXT for external, BD for bass drum, SD for snare drum, LT for low tom, HT for high tom, CY for cymbal, OH for open hihat and CH for closed hihat.

The EXT instrument is also used to send triggers from the (optional) CV Gate output expansion in 8 track mode.

When editing a drum pattern, select which drum instrument is currently displayed on the pattern step LEDs by holding the TRANSPOSE/DRUM SELECT button to the left of the mini keyboard and then selecting the drum instrument using the white buttons of the mini keyboard.

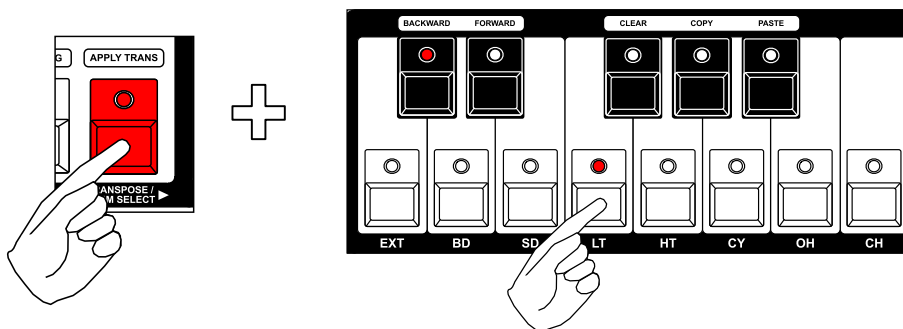

Selecting low tom, group 1 drum instrument

TIP: When the sequencer is not playing, the drum instrument will be played as it is selected. This makes it easier to preview the drum sound.

TIP: While holding the DRUM SELECT button, the track LEDs flicker briefly each time a drum instrument is played. This gives a good visual indicator of what instruments are playing. Muted instruments will not flicker.

PATTERNS

To switch between the two groups of eight drum instruments click the BACKWARD or FORWARD button. The current group is displayed on the BACKWARD or FORWARD LED.

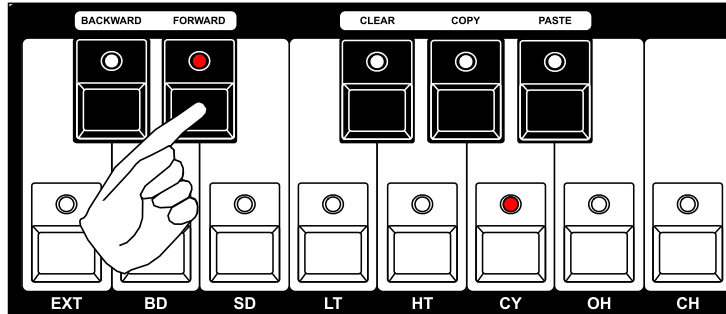

ALL ACCENT

To play back all pattern steps of the current selected drum instrument as accented notes, press and hold the ACCENT button while in DRUM SELECT mode. Notes will resume normal playback when the ACCENT button is released.

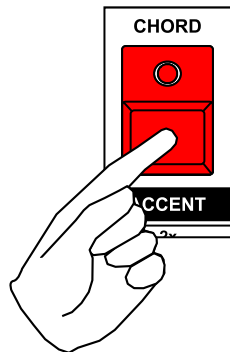

PATTERNS

NO ACCENT

To play back all pattern steps of the current selected drum instrument as unaccented notes, press and hold the MUTE button and then press and hold the ACCENT button while in DRUM SELECT mode. Notes will resume normal playback when the ACCENT button is released.

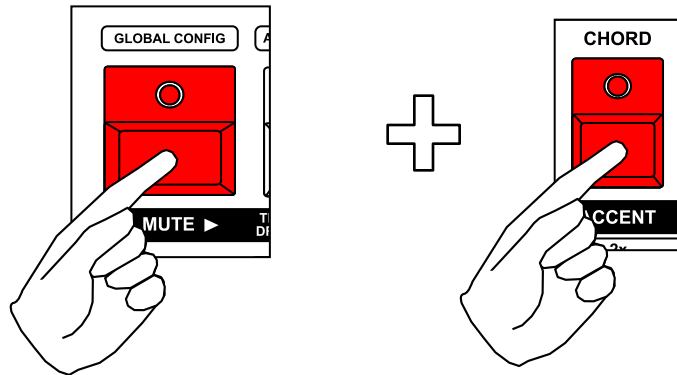

PATTERNS

LIVE DRUM INSTRUMENT REST

To temporarily mute all pattern steps of the current selected drum instrument, press and hold the REST button while in DRUM SELECT mode. Steps will resume normal playback when the REST button is released.

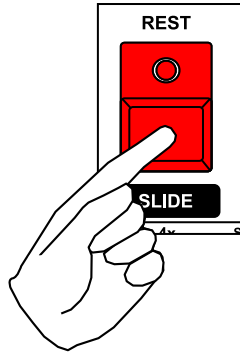

PATTERNS

ALL REPEAT

To play back all pattern steps of the current selected drum instrument with note repeat, press and hold the ROLL/ARP button while in DRUM SELECT mode. Steps will resume normal playback when the ROLL/ARP button is released.

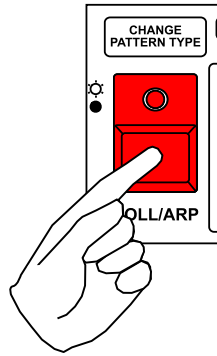

NO REPEAT

To play back all pattern steps of the current selected drum instrument without note repeat, press and hold the MUTE button and then press and hold the ROLL/ARP button while in DRUM SELECT mode. Steps will resume normal playback when the ROLL/ARP button is released.

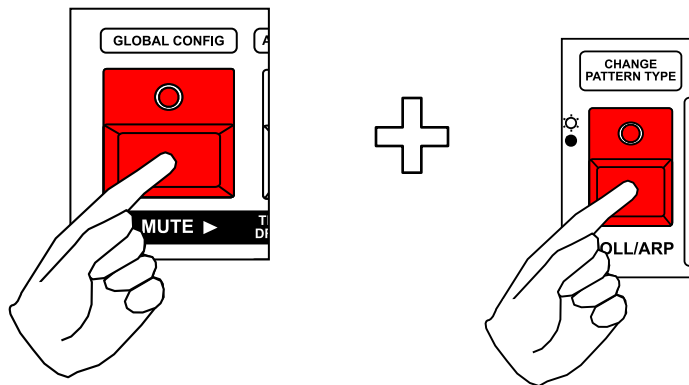

PATTERNS

PROGRAMMING DRUM TYPE PATTERNS

Drum type patterns can be programmed using grid programming, step programming, adaptive recording or realtime recording. Each method has its strengths, so you can choose the appropriate method for your situation. Realtime recording and step recording can also be used simultaneously with grid programming, allowing for very interactive sequencing.

GRID PROGRAMMING

Grid programming mode is the default mode and is always active, meaning that you don't need to enter record mode to use grid programming. Grid programming is the "classic" method of entering triggers using the pattern step buttons. You can see the programmed steps directly on the step LEDs. Accented triggers are shown with a brightly lit LED, unaccented triggers are shown with a dim LED.

ADDING OR REMOVING A TRIGGER

After selecting the appropriate drum instrument, use the pattern step buttons to enter triggers for the instrument. Clicking a pattern step button once enters an unaccented trigger. To enter an accented trigger, double click the pattern step button.

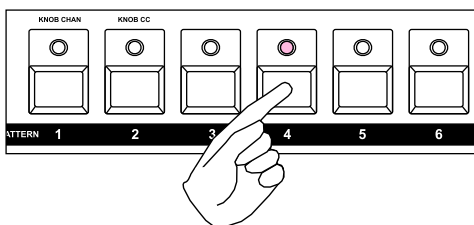

Adding an unaccented trigger

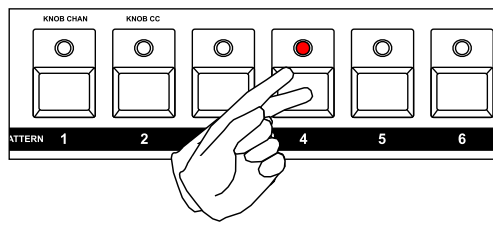

Adding an accented trigger

PATTERNS

CHANGING TRIGGER VELOCITY

In addition to clicking or double-clicking as a trigger is programmed, the velocity can also be set using the ACCENT button or control knob 1 while pressing the step button.

There are three velocity levels available (default 40, 63 and 127). The three velocity values can be changed in TRACK UTILITY mode.

While holding the step button, clicking the ACCENT button will cycle through the three velocity levels, or you can turn control knob 1 to select the velocity.

The current velocity is shown on the LED display.

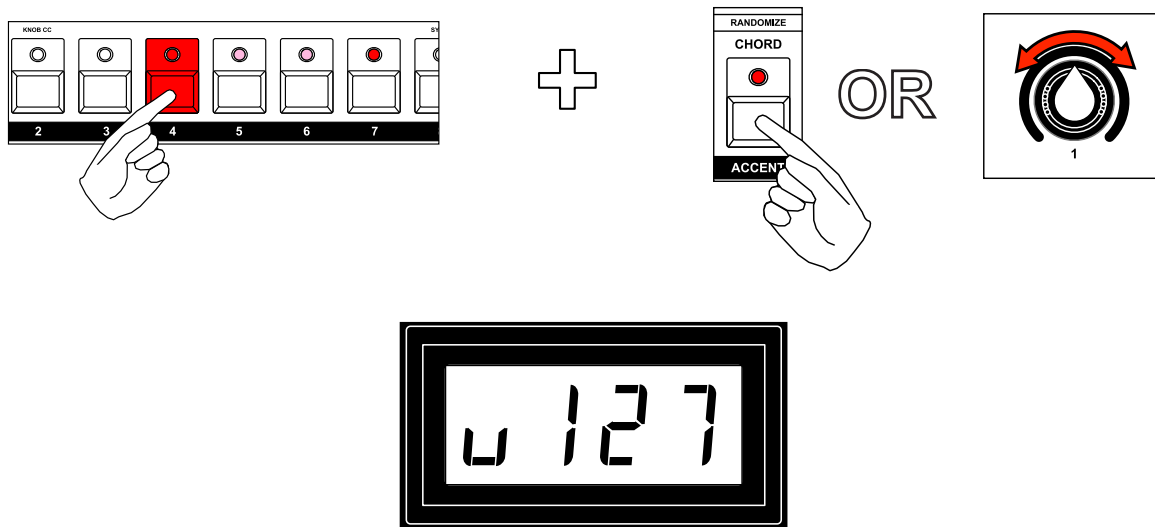

PATTERNS

SETTING NOTE REPEAT

Each trigger can be enabled for the note repeat MIDI EFFECT. This will cause the step to be retrIGGERED according to the note repeat setting for the track. This creates a flam type effect.

If the track MIDI EFFECT has a note repeat setting of zero, you will not hear any repeats. For details on using the note repeat MIDI EFFECT, please see the MIDI EFFECTS section under FUNCTION MODE.

To set note repeat for a step, press and hold the pattern step button. Then click the ROLL/ARP button to turn note repeat on or off. The current note repeat setting is indicated by the ROLL/ARP LED.

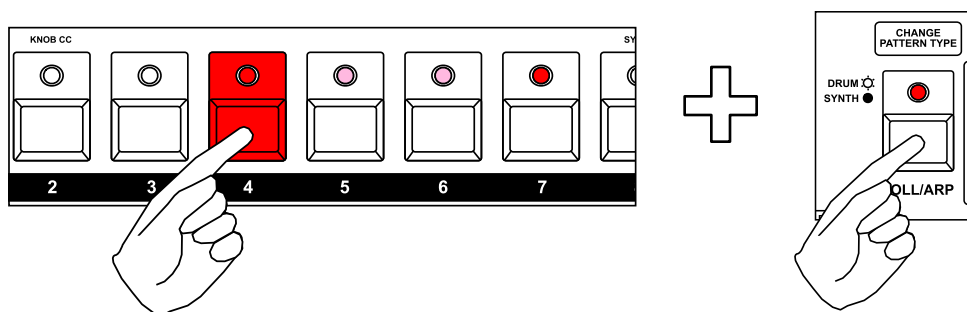

SETTING STEP DELAY

Each step of a drum type pattern can have a delay added to the start of the step. This can create a more humanized feel in programmed patterns. The amount of delay available will vary based on the current TIME SCALE for the pattern.

To set the delay for a step, press and hold the pattern step button. Then use control knob 3 to set a delay for the step. The current delay will be shown on the LED display.

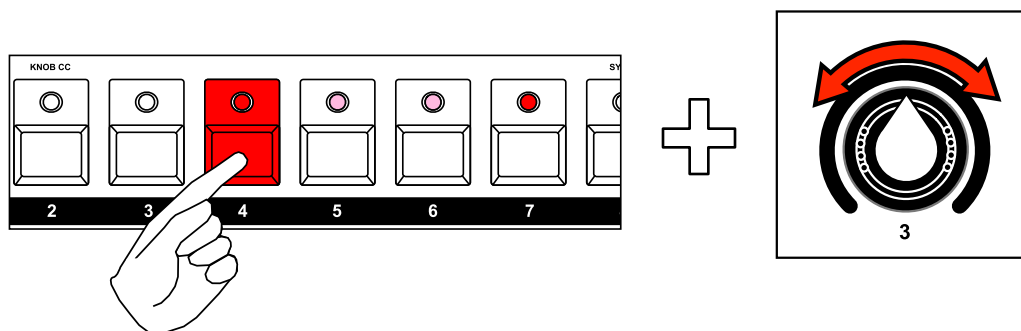

NOTE: Step delay applies to all drum instruments on the step.

PATTERNS

REALTIME RECORDING

Drum type patterns can also be recorded in realtime, which can be useful for capturing the expression of a live performance.

To begin realtime recording, press and hold (or double click) the RECORD button.

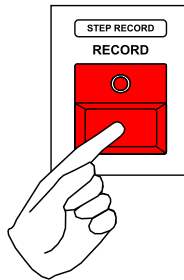

In RECORD mode, the eight white buttons of the mini keyboard become drum pads for realtime recording. All eight of the drum instruments can be played simultaneously into the pattern in realtime. The BACKWARD/FORWARD buttons can be used to switch between the two instrument groups.

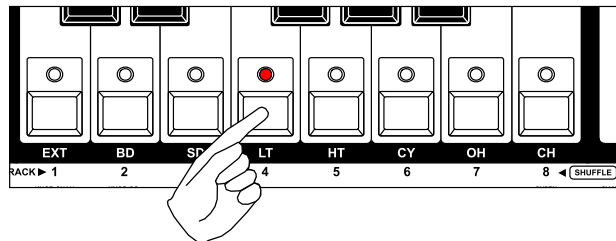

To add accents, you can press and hold the accent button while playing the drum instrument pads.

Realtime input from an external MIDI controller can also be recorded, the velocity of the incoming notes will automatically map to accented notes.

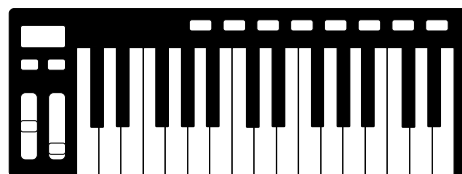

PATTERNS

REALTIME RECORD ACCENT, REPEAT, REST

Pattern accents, note repeat, rest and muting of accents, and note repeats can be recorded directly into a DRUM TYPE pattern in realtime. This is extremely useful for adding variation to a recorded pattern, or fixing and modifying accent and note repeat events.

To realtime record drum step attributes, press and hold (or double-click) the RECORD button while in DRUM SELECT mode.



TIP: You can jump directly into and out of DRUM SELECT RECORD mode while already in realtime record mode.

While in realtime drum attribute record, using the ACCENT, REST and ROLL/ARP buttons, you can add accent, rest and note repeat events to pattern data. Using the MUTE button in combination with the ACCENT and ROLL/ARP buttons, you can erase events from pattern data.

PATTERNS

STEP RECORDING

Step recording is an alternate way to enter drum triggers by moving from one step to the next in sequence. This can be done while the sequencer is running or stopped.

To enter STEP RECORD, press and hold (or double click) the FUNCTION button, then click the RECORD button. Both the FUNCTION and RECORD LEDs will blink to indicate you are in STEP RECORD mode.

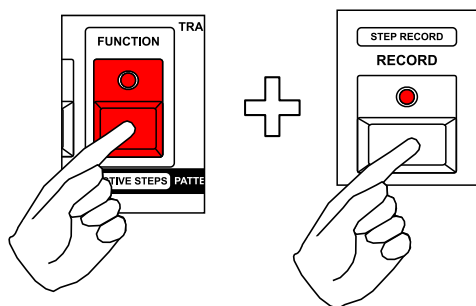

The current step location is indicated on the pattern step buttons with a bright blinking LED. You can begin entering step events from the beginning of the sequence immediately or you can jump to a particular step by clicking a pattern step button.

In STEP RECORD mode, the white buttons of the mini-keyboard function as drum pads for 8 drum instruments. To enter triggers, click the white buttons of the mini keyboard buttons, the step will automatically advance to the next step.

If you hold down multiple drum instrument buttons simultaneously, you can add drum triggers for multiple instruments on the same step.

To switch between the two instrument groups, hold DRUM SELECT and click BACKWARD/FORWARD.

You can also add ACCENT to a step by clicking the ACCENT button while holding the drum instrument button.

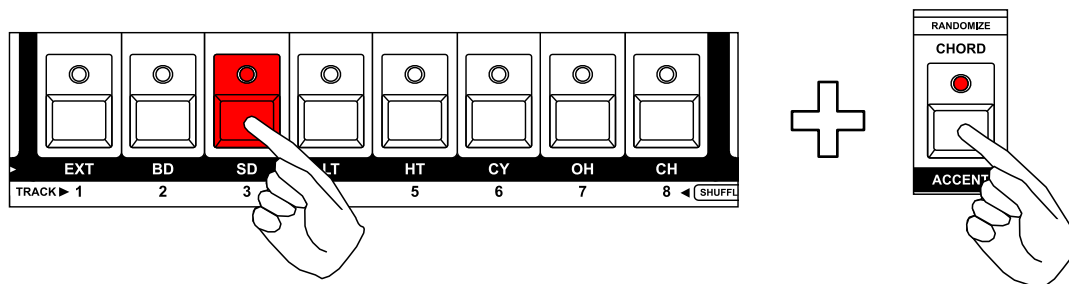

PATTERNS

To enter a REST event, click the REST button, any existing event will be erased from the current step.

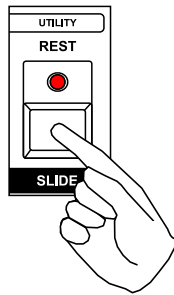

To advance one step without entering any new data, click the RECORD button.

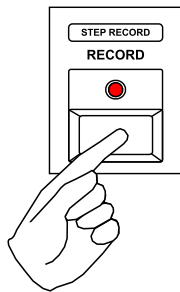

To leave STEP RECORD mode, click the FUNCTION button.

PATTERNS

MUTING DRUM INSTRUMENTS

Individual drum instruments can be muted within a DRUM type pattern to create pattern variations.

To enter drum instrument mute mode, first press and hold (or double click) the TRANSPOSE/DRUM SELECT button, then press and hold (or double click) the MUTE button. The current mute status for each drum instrument is shown on the LEDs of the eight white mini keyboard buttons. Unmuted instruments are shown as lit LEDs, while muted instruments are shown as unlit LEDs.

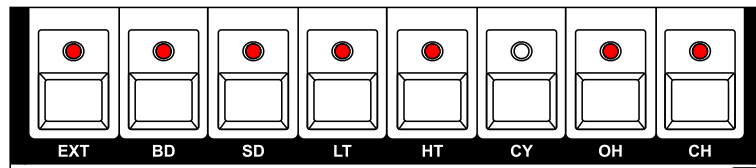
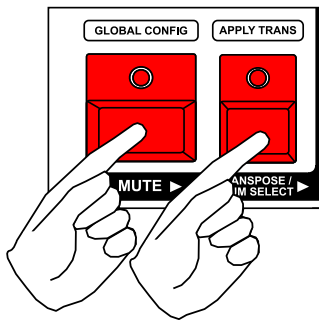

The CYMBAL instrument is muted

TIP: The MUTE and DRUM SELECT buttons can be double clicked to pin the instrument mute function. This is useful for live performance when muting and unmuting individual drum instruments.

To change the drum instrument mutes, while in drum instrument mute mode, click the white mini keyboard buttons to mute or unmute instruments.

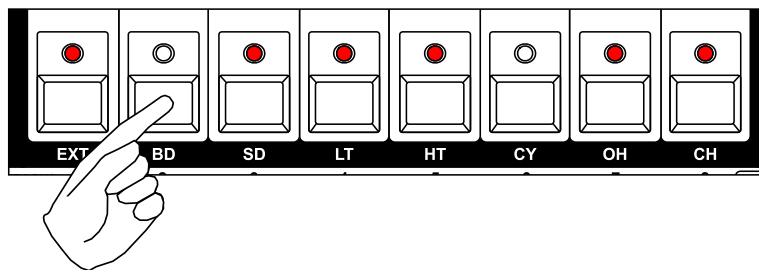

The BACKWARD and FORWARD buttons can be used to select which group of eight drum instruments are shown on the mini-keyboard for muting.

PATTERNS

SOLOING DRUM INSTRUMENTS

A single drum instrument can be soloed, which will mute all other instruments. To solo a drum instrument, while in DRUM INSTRUMENT MUTE mode, press and hold the FUNCTION button, then click the drum instrument you wish to solo. The selected instrument will be unmuted, all other instruments will be muted.

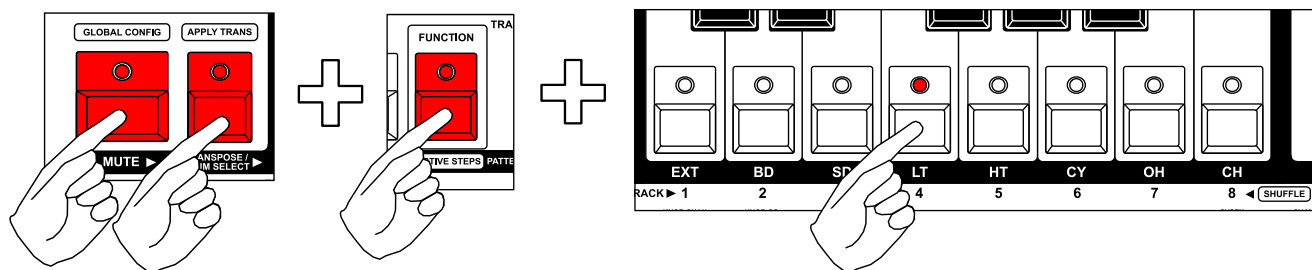

The LOW TOM instrument is soloed

NOTE: Soloing a drum instrument does not effect TRACK MUTES.

UNSOLOING DRUM INSTRUMENTS

When a drum instrument is soloed, you can quickly unsolo it and return to the previous drum mute settings.

To unsolo an instrument, while in DRUM SOLO mode, click the previously soloed instrument button. The drum mute settings will be restored.

NOTE: You must unsolo an instrument before soloing a new instrument.

PATTERNS

DRUM ROLLS

Drum type patterns include a DRUM ROLL function that can be used for realtime performance or recorded directly into the pattern sequence.

To enter DRUM ROLL mode, press and hold (or double-click) the ROLL/ARP button.

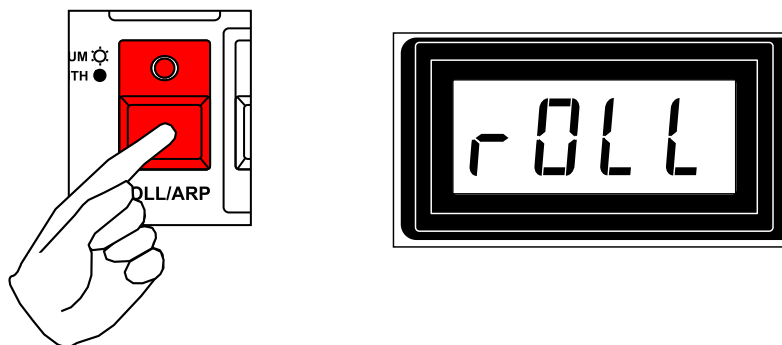

While in DRUM ROLL mode, the white mini keyboard buttons can be used to play drum rolls for each of the sixteen drum instruments. The ACCENT button can also be pressed to add accents in realtime.

To switch between the two groups of eight drum instruments, hold the DRUM SELECT button and then click the BACKWARD or FORWARD button. The current group is displayed on the BACKWARD or FORWARD LED.

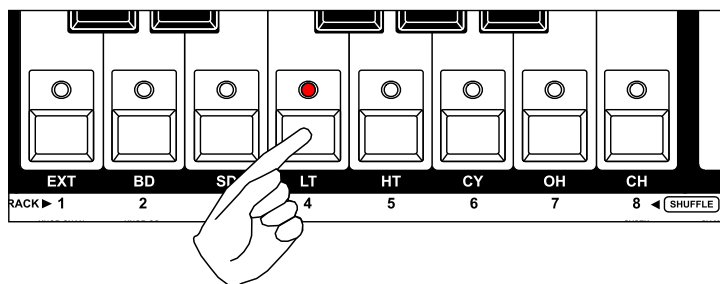

While playing a drum roll, the sequenced pattern for that instrument is overridden. When the drum roll is released, the sequenced pattern resumes.

TIP: Drum rolls can also be played using an external MIDI controller.

TIP: Drum rolls can be played while the sequencer is stopped.

CHANGING THE DRUM ROLL RESOLUTION

The resolution of the DRUM ROLL can be changed to create interesting variations. The current resolution will be displayed on the LEDs of the black mini-keyboard buttons.

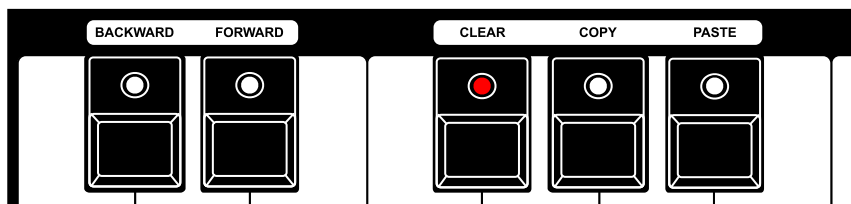

To change the drum roll resolution, while in DRUM ROLL mode, press any of the black mini-keyboard buttons.

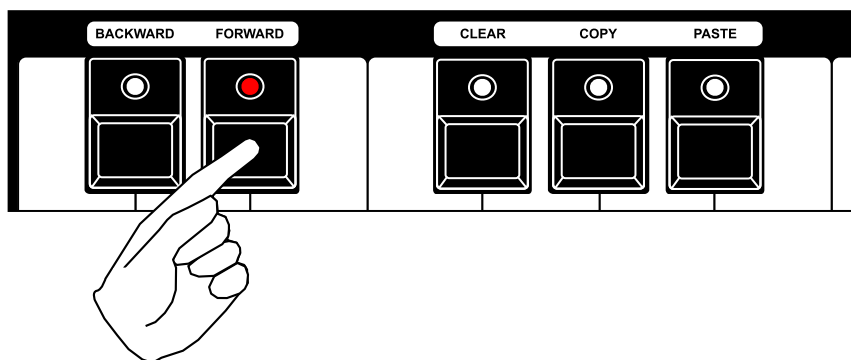

The available resolutions (in relation to a 4/4 16th note pattern):

OFF	C sharp button
32nd notes	D sharp button
16th notes	F sharp button (default)
8th notes	G sharp button
Quarter notes	A sharp button

PATTERNS

LATCHING DRUM ROLLS

While a drum roll is playing, you can latch the roll. When a drum roll is latched, it will continue to play, even when leaving ROLL mode.

You can add additional instruments or remove instruments from the drum roll while the roll is latched, by clicking the buttons of the mini keyboard.

To latch the roll, click the FUNCTION button. To unlatch the roll, click the FUNCTION button again.

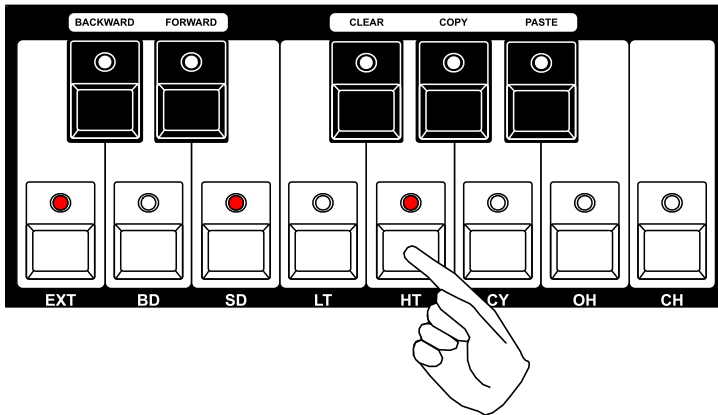
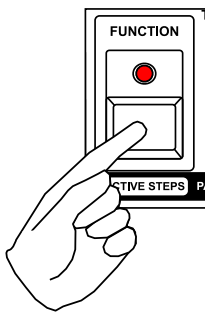

PATTERNS

RECORDING A DRUM ROLL

If you find an interesting drum roll, you can instantly record it directly into the pattern. To record a drum roll, while in DRUM ROLL mode, press and hold (or double-click) the RECORD button. Momentary recording of a drum roll can create interesting musical combinations in the sequenced pattern.

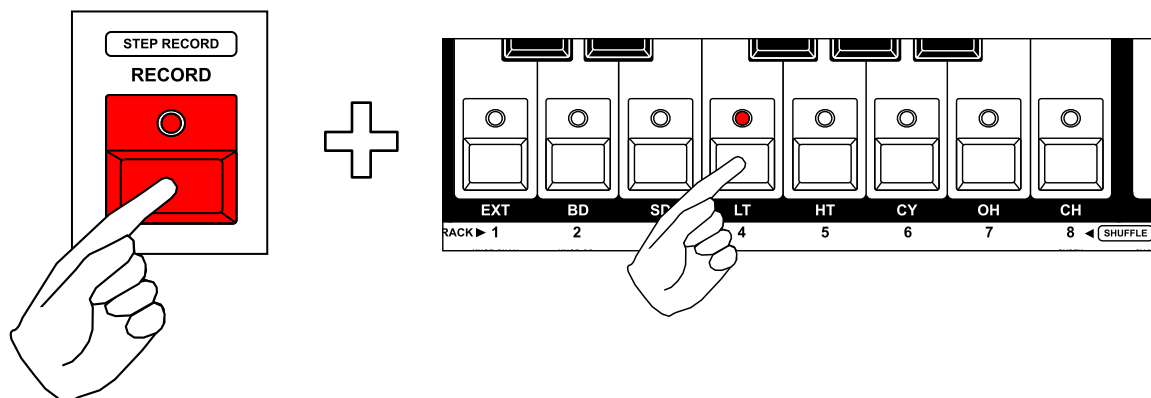

NOTE: Drum rolls cannot be recorded at a higher resolution than the timing scale of the pattern. This means that a 32nd note roll will only be recorded as 16th notes in a 4/4 16th note pattern. The other notes of the drum roll will be ignored.

TIP: PAUSE RECORD also works with DRUM ROLL mode.

PATTERNS

DRUM LEARN MODE

By default, the note values for the drum instruments map to the standard GM notes for a drum kit. The assigned notes for each drum instrument can be changed per track in DRUM LEARN mode.

To enter DRUM LEARN mode, press and hold (or double click) the FUNCTION button and then press and hold the DRUM LEARN (song) button. The current selected drum instrument is shown on the white keys of the mini keyboard and the current note assignment for the selected instrument is shown on the LED display.

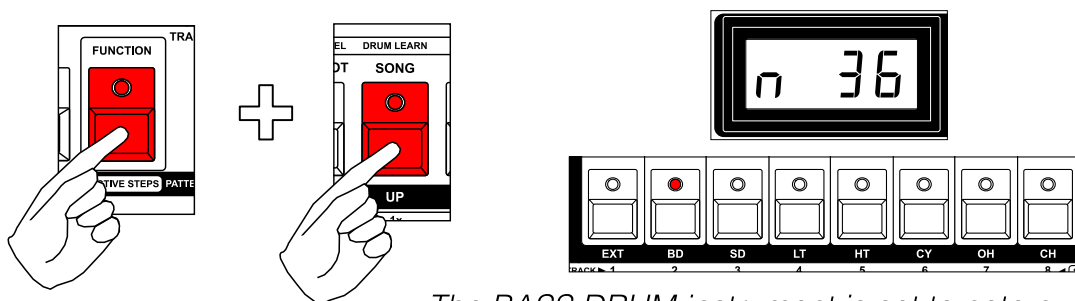

The BASS DRUM instrument is set to note number 36

To change the note assignment, while in DRUM LEARN mode, turn control knob 1, click BACKWARD/FORWARD or send a MIDI note from an external MIDI controller.



Use the white mini keyboard buttons to switch instruments while in DRUM LEARN mode, to quickly set the MIDI note for multiple instruments.

To switch between the two groups of eight drum instruments, hold the DRUM SELECT button and then click the BACKWARD or FORWARD button. The current group is displayed on the BACKWARD or FORWARD LED.

SYNTH TYPE PATTERNS

There are two types of synth patterns in Engine: SYNTH1 and SYNTH2.

SYNTH1 type patterns store up to four pitches per step with shared length and velocity, making them well suited for programming bass sequences. Synth1 type patterns also allow SLIDE (overlapping) between notes and they can use the CHORD MEMORY function to automatically play polyphonic chords over MIDI.

SYNTH2 type patterns also store up to four pitches per step, but each pitch is completely independent, with separate length and velocity. SYNTH2 type patterns allow for more traditional polyphonic programming, but do not offer SLIDE between steps and use limited velocity values.

PROGRAMMING A SYNTH TYPE PATTERN

Both types of SYNTH pattern can be programmed using grid programming, step programming, adaptive recording or realtime recording. Each method has its strengths, so you can choose the appropriate method for your situation. Realtime recording and step recording can also be used simultaneously with grid programming, allowing for very interactive sequencing.

PATTERNS

GRID PROGRAMMING

Grid programming mode is the default mode and is always active, meaning that you don't need to enter record mode to use grid programming. Grid programming is the "classic" method of entering notes using the pattern step buttons. You can see the programmed steps and step lengths directly on the step LEDs. All of the step attributes are visible and can be edited while holding down a step button.

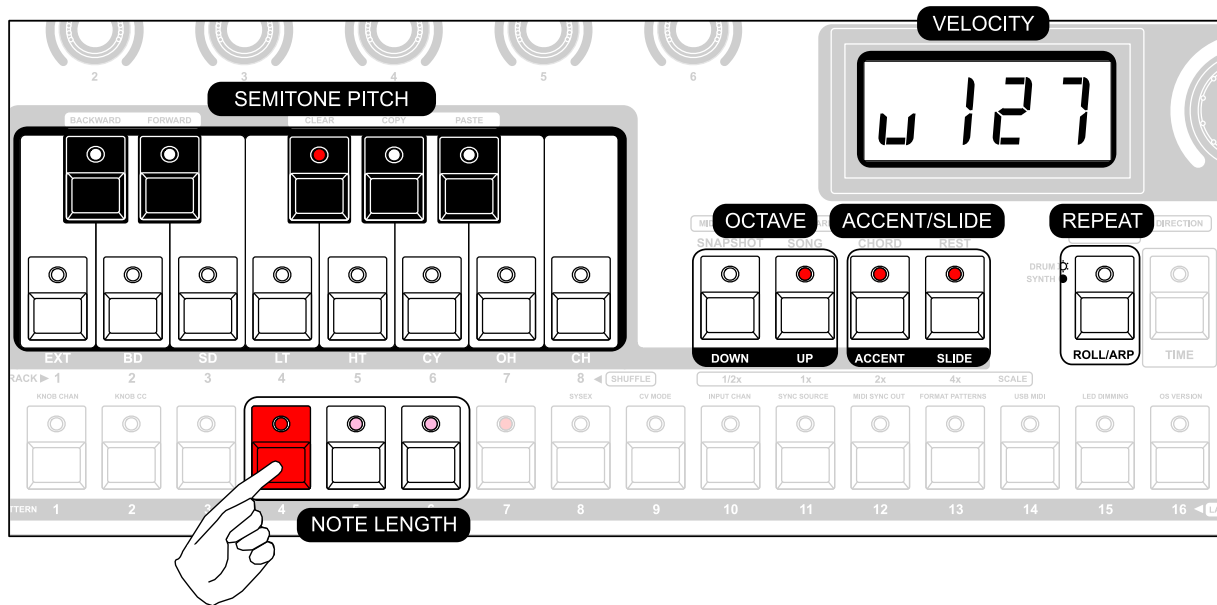

TIP: You can click the TRANSPOSE button while holding a step to show the step gate length or delay on the LED display

NOTE: Only SYNTH1 type patterns support the SLIDE function.

PATTERNS

ADDING OR REMOVING A STEP EVENT

To add a new step event, click the pattern step button where you wish to place the event. Continue to hold down the step button to see and edit other attributes of the step.

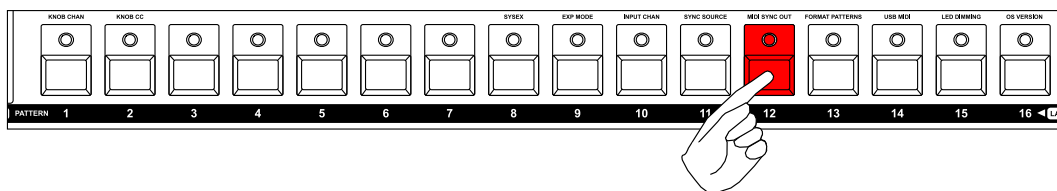

To remove the step, you can quickly click the step button.

If you wish to edit an existing step, you can press and hold the step button and the step will not be removed when releasing the step button.

TIP: When the sequencer is not playing, the pitch of the step will be played as it is selected. This makes it easier to preview the programmed notes.

PATTERNS

SYNTH1: POLYPHONIC PROGRAMMING

Each step of a SYNTH1 type pattern can have separate pitches programmed in four available pitch slots. This allows for programming chords or other polyphonic note data per step.

The velocity and gate length of the four pitch slots is shared, this means that setting VELOCITY/ACCENT or GATE LENGTH/SLIDE for a step will effect all programmed pitch slots.

The CV signal for a SYNTH1 pattern is always related to pitch slot 1.

SYNTH1: SELECTING THE PITCH SLOT TO PROGRAM

When initially pressing and holding a step button, PITCH SLOT 1 is selected. This is displayed by a brightly lit SECTION 1 LED. If other pitch slots (2, 3 or 4) are currently programmed, the corresponding SECTION LED will be lit dimly. Pitch slots that are not programmed will have an unlit SECTION LED.

To select a different pitch slot, while holding a step button, click the SECTION button. This will cycle between the four pitch slots.

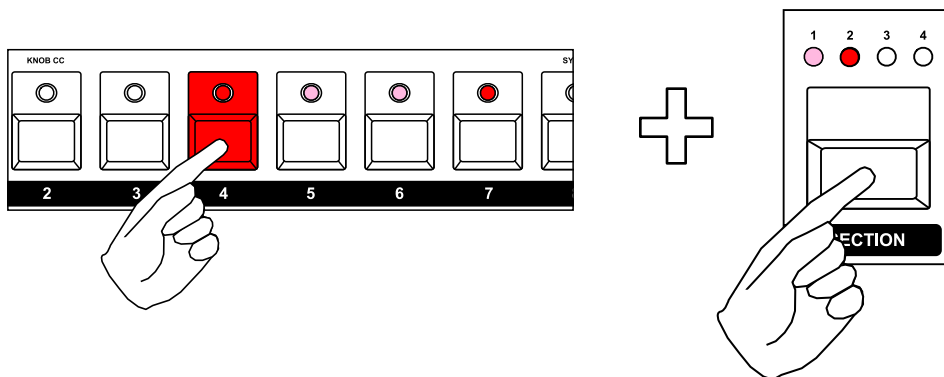

When a pitch slot is selected, the programmed pitch will be shown on the mini-keyboard and octave LEDs. If no pitch is programmed, the mini-keyboard will have no LEDs lit.

PATTERNS

SYNTH2: POLYPHONIC PROGRAMMING

SYNTH2 type patterns have four note lanes, which can be used to edit polyphonic sequences. Each note lane, has independent step programming for note start, length and velocity, so you can think of each lane as a sort of “mini-sequence”.

The CV signal for a SYNTH2 pattern is always related to note lane 1 in 8 track mode.

SYNTH2: SELECTING THE NOTE LANE TO PROGRAM

To select the current note lane, press and hold TRANSPOSE and then click the SECTION button (with no other buttons pressed). While the TRANSPOSE button is held, the selected note lane is displayed on the four SECTION LEDs. The note data for the selected lane will be displayed on the pattern step buttons and can be edited.

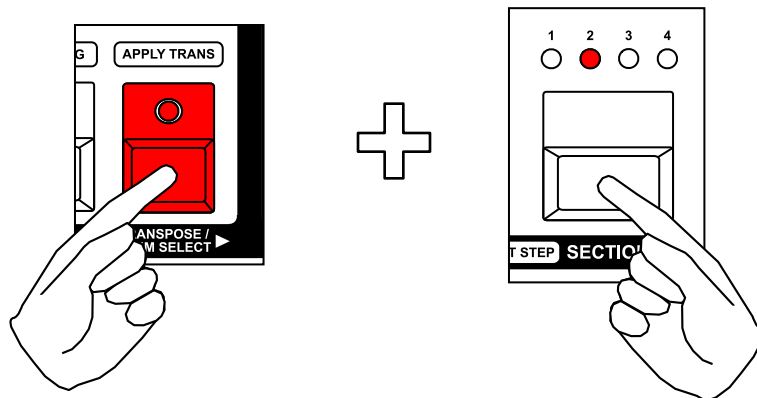

PATTERNS

CHANGING STEP PITCHES

While holding a step button, you can see and change the programmed pitch for the step. The semitone pitch is displayed on the mini keyboard, while the octave of the note is shown on the UP and DOWN octave LEDs to the right of the mini keyboard.

To change the step pitch, while holding the step button, press any semitone button on the mini keyboard.

TIP: If pitch entry over MIDI is enabled for the selected track, you can also set the step pitch using a MIDI controller.

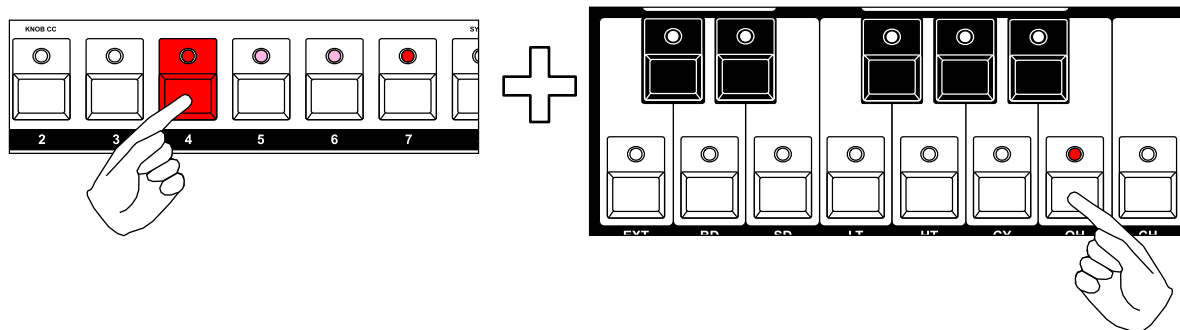

For SYNTH1 type patterns, if PITCH SLOT 2, 3 or 4 is currently selected, you can deactivate the pitch by clicking the mini-keyboard button for the current programmed semitone. You cannot deactivate PITCH SLOT 1, it will always be played if the step is triggered.

To change the octave of the selected pitch, press the octave UP or DOWN buttons to the right of the mini keyboard.

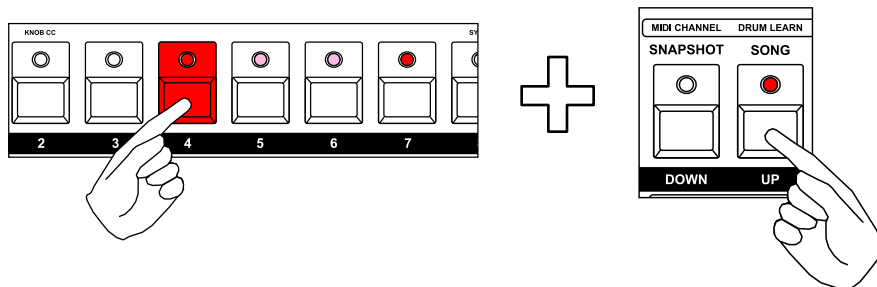

PATTERNS

You can select from nine octaves using the octave UP and DOWN buttons. The LEDs of the octave buttons will light differently according to the selected octave. For example, one octave down will light the DOWN LED dimly, two octaves down will light the DOWN LED brightly, three octaves down will blink the DOWN LED dimly, four octaves down will blink the DOWN LED brightly.

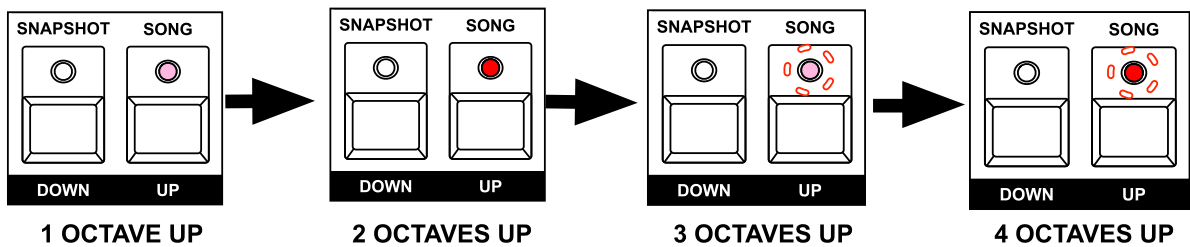
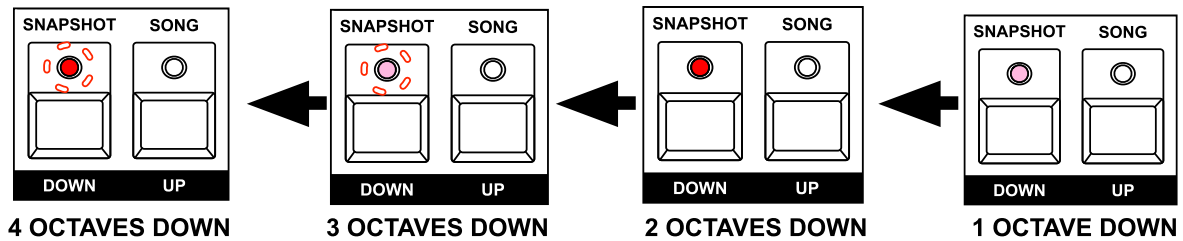

PATTERNS

SYNTH1: QUICKLY ENTERING MULTIPLE PITCHES

In a SYNTH1 type pattern, you can quickly enter a polyphonic step by holding a step button and then press and hold multiple pitches on the mini-keyboard. This is useful for quickly entering chords on a step.

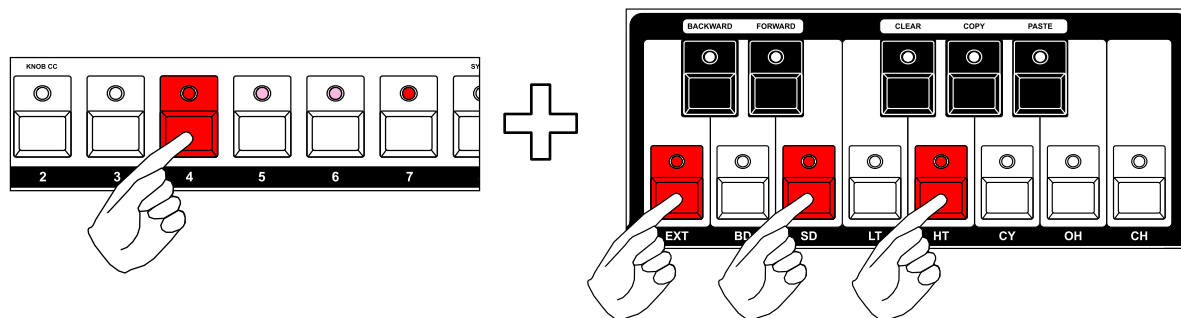

Each additional keyboard button (up to four) will automatically increment the selected pitch slot and store the pitch value.

When entering multiple pitches with this method, higher pitch slots will automatically be deactivated.

For example, if the current step has four pitch slots programmed, and pitch slot one is currently selected, then holding a second keyboard button will automatically enter pitch slot two and deactivate pitch slots three and four.

TIP: This also works when setting the step pitch using a MIDI controller.

PATTERNS

SYNTH1: TRANSPOSING POLYPHONIC STEPS

Sometimes you may wish to transpose all pitch slots of a SYNTH1 type pattern at the same time, by the same amount. The step transpose function allows you to do this.

The step transpose function uses the mini-keyboard and octave buttons to transpose all pitches on the current step by semitones or octaves.

While holding a step button for grid programming, press and hold the TRANSPOSE button. Click the buttons of the mini-keyboard or the octave up and down buttons to transpose all active pitches on the step.

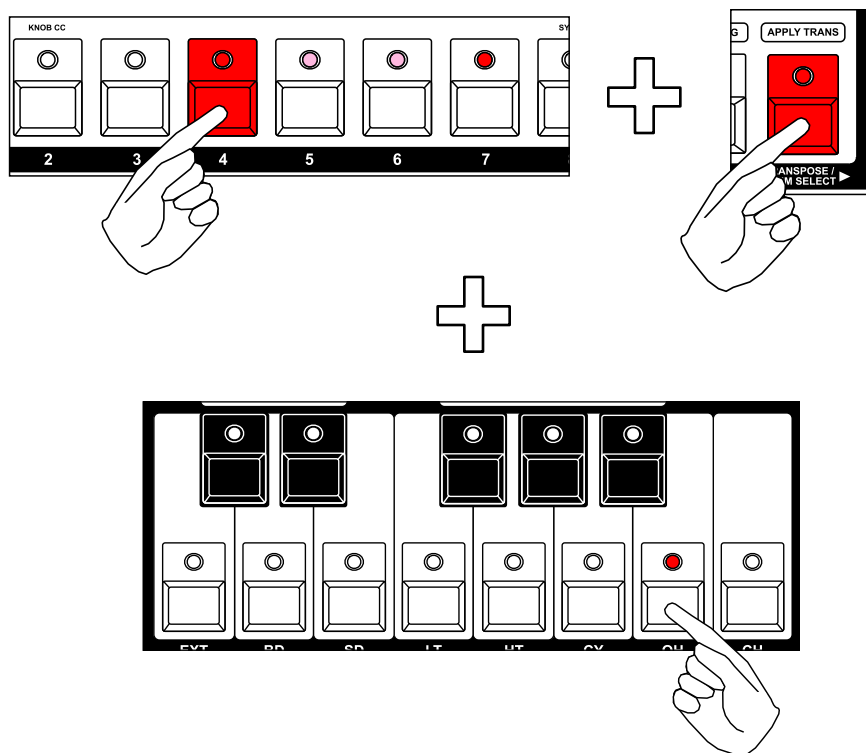

The keyboard LEDs will show the current selected pitch, but will apply any changes as an offset to all pitches on the step.

TIP: This also works when setting the step pitch using a MIDI controller.

PATTERNS

SETTING STEP LENGTH

To set the overall length of a step, press and hold the step button and then click a second step button. The beginning of the step is shown with a brightly lit step LED, and the length of the note is shown by a chain of dimly lit step LEDs.

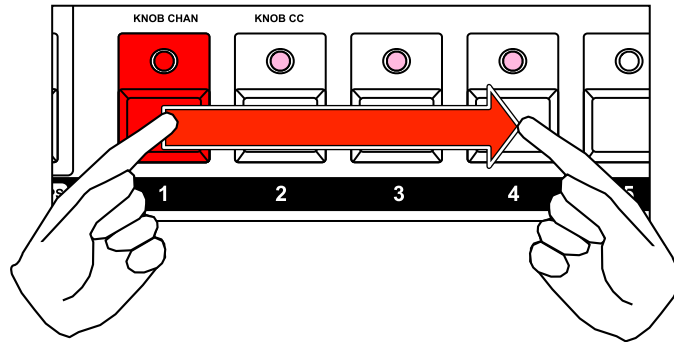

You can shorten the step by clicking a second step button closer to the start of the step.

To make the step one step long again, click the first step button to turn it off, and then click it again to turn it back on. This removes any programmed step length.

TIP: To create notes that are longer than 16 steps or stretch across pattern sections, use the length feature in STEP FUNCTION mode.

PATTERNS

FINE TUNING GATE LENGTH

The length of each step can be fine tuned to create longer or shorter note events. By default a note is created with 50% gate length. This means that by default, a note behaves the same as the sequencer on a TB-303.

You can change the gate length of any step by rotating control knob 2 while holding the step button. The LED display will show the current gate length of the step as a percentage.

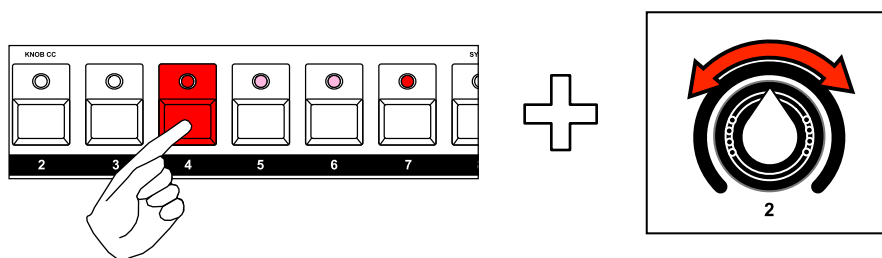

For SYNTH1 type patterns, if you turn the control knob completely clockwise, the note will be set to SLIDE, indicating that the note length will overlap with the next note. The LED display will show "SLD" when a note is set to slide.

TIP: Slides can also be set quickly using the SLIDE button while holding the step button.

When fine tuning the length of a note that extends over several steps, only the length of the last step is modified. This means that you can fine tune the "tail" of a step even for long notes.

The available resolution of note length changes with different time scales. For 1x scale, the available length is between 1 and 12 clock ticks. When changing to different time scales, the step length of steps will change in proportion to the selected scale. This means that note length is set relative to the sequencer tempo, not absolute time.

When a pattern is set with shuffle timing, notes that are set with a length greater than the step time will be automatically truncated during playback to prevent unwanted slides.

When turning a step off and then back on, the gate length will be reset back to one half the step resolution.

PATTERNS

SYNTH1: ADDING SLIDE

A step can have a programmed SLIDE attribute. Slide causes the note length to be extended so that it is played legato, meaning that the next note will be started before ending the previous note, so that they overlap. On many synthesizers, this will trigger a slide or portamento between notes.

To set slide on a note using the SLIDE button, press and hold the pattern step button. Then click the SLIDE button to turn slide on or off. (cv hardware slide)

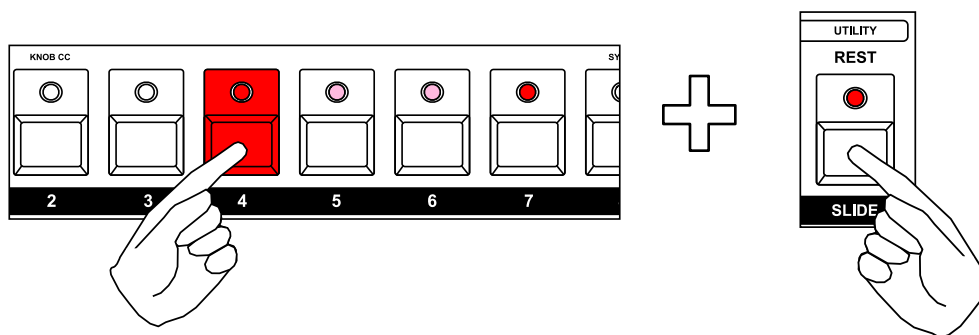

TIP: SLIDE can also be set using the note length knob, by rotating control knob 2 clockwise and setting the note length to maximum.

SETTING NOTE REPEAT

Each step can be enabled for the note repeat MIDI EFFECT. This will cause the note to be retriggered according to the note repeat setting for the track. If the track MIDI EFFECT has a note repeat setting of zero, you will not hear any note repeats. For details on using the note repeat MIDI EFFECT, please see the MIDI EFFECTS section under FUNCTION MODE.

To set note repeat for a step, press and hold the pattern step button. Then click the ROLL/ARP button to turn note repeat on or off. The current note repeat setting is indicated by the ROLL/ARP LED.

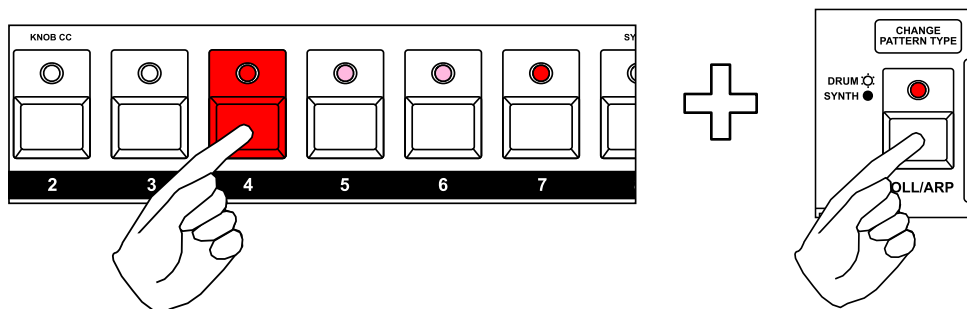

PATTERNS

SETTING VELOCITY OR ACCENT

Each step of a synth type pattern can be set to specific velocity.

For SYNTH1 type patterns the velocity range is 0-127.

For SYNTH2 type patterns, there four velocities (default: 31, 63, 95 and 127). These velocities can be changed in TRACK UTILITY mode.

As a shortcut, the ACCENT button can be used to set a predefined velocity for accented or unaccented notes.

To set the velocity of a note using the ACCENT button, press and hold the pattern step button. Then click the ACCENT button to accent turn on or off.

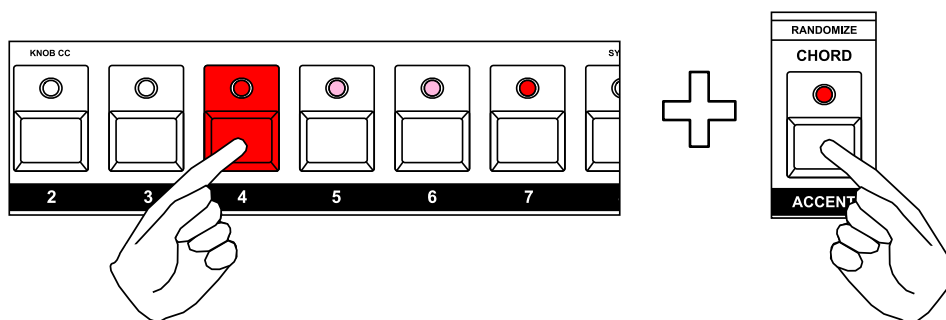

To set a different velocity for the step, while holding the step button, use control knob 1 to set a velocity value. The current velocity of the step is shown on the LED display.

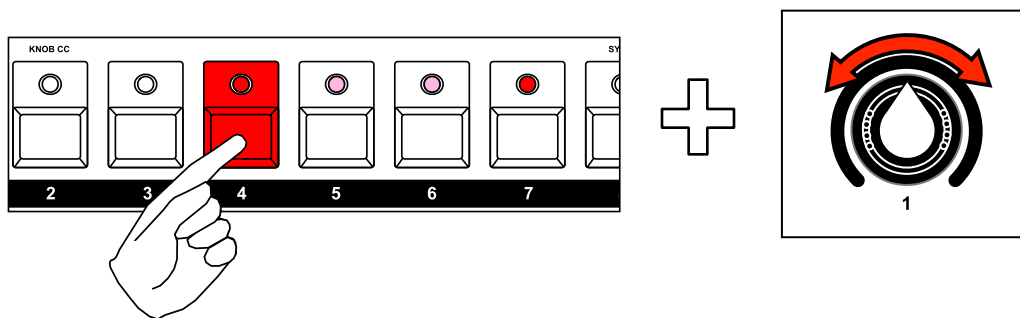

TIP: You can quickly enter an accented step by double clicking the pattern step button as you enter the step event.

PATTERNS

SYNTH1: SETTING STEP DELAY

Each step of a SYNTH1 type pattern can have a delay added to the start of the step. This can create a more humanized feel in programmed patterns. The amount of delay available will vary based on the current TIME SCALE for the pattern.

To set the delay for a step, press and hold the pattern step button. Then use control knob 3 to set a delay for the step. The current delay will be shown on the LED display.

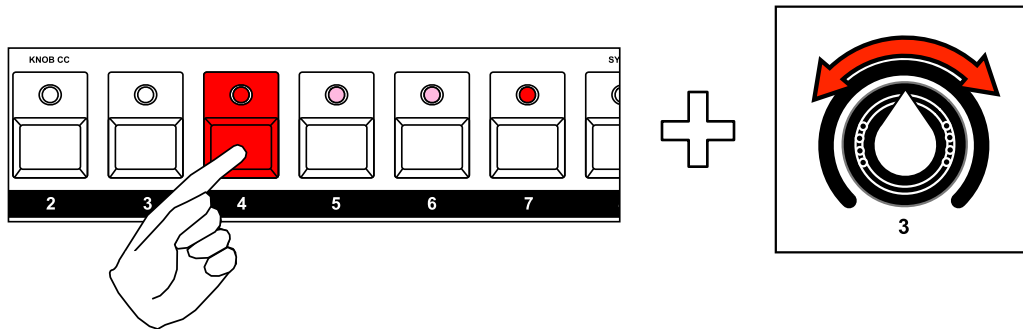

PATTERNS

REALTIME RECORDING

The pattern information for a SYNTH type pattern can be recorded in realtime using the mini keyboard or from an external MIDI controller. This allows a more expressive performance to be recorded directly into a pattern.

To enter RECORD mode, press and hold or double click the RECORD button. In record mode, the mini keyboard can be used to play notes into the pattern. Performances will be recorded directly into the sequence. For SYNTH1 patterns, playing notes legato will automatically be recorded as slides.

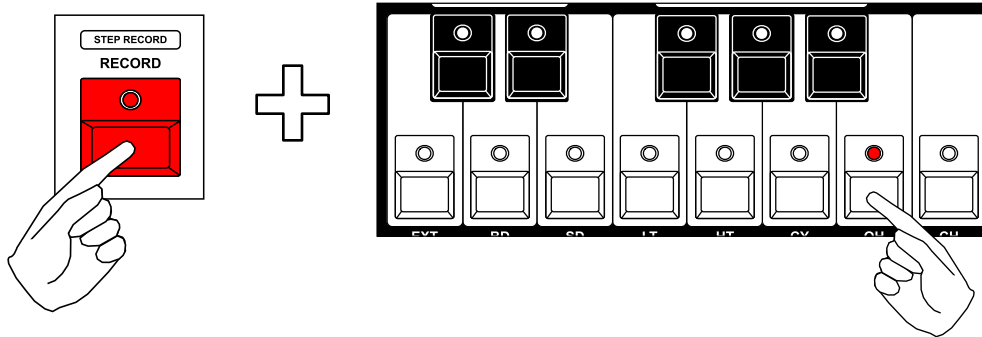

You can also continue to use grid recording on individual steps while in REALTIME RECORD mode. To do this, click and hold any pattern step button. The step attributes can be displayed and edited, when releasing the step button you can return to realtime recording.

TIP: When using an external MIDI controller, the incoming velocity will be recorded into steps automatically.

QUANTIZATION

When realtime recording, the length of played notes can be quantized to the nearest half step or note lengths can be recorded to the nearest clock tick. This allows you to control how “expressive” the recorded sequence is. For classic bassline programming, quantization should be left on, which will force all notes to 50% gate length.

PATTERNS

STEP RECORDING

Step recording is an alternate way to enter a monophonic sequence of notes and timing by moving from one step to the next in sequence. This can be done while the sequencer is running or stopped.

To enter STEP RECORD, press and hold (or double click) the FUNCTION button, then click the RECORD button. Both the FUNCTION and RECORD LEDs will blink to indicate you are in STEP RECORD mode.

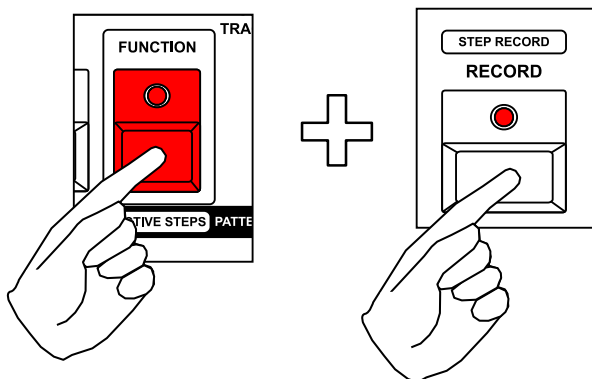

The current step location is indicated on the pattern step buttons with a bright blinking LED. You can immediately jump to a particular step by clicking a pattern step button, or begin entering step events from the beginning of the sequence.

To enter steps, you can click pitches on the mini keyboard buttons, the step will automatically advance to the next step.

TIP: When the sequencer is not playing, the selected pitch will be played as it is entered. This makes it easier to preview the programmed notes.

For SYNTH1 type patterns, if you play the keyboard legato (hold down two notes simultaneously) it will automatically create a slide and advance to the next step.

For SYNTH2 type patterns, step entry will be placed in the currently selected note lane. To change note lanes, press and hold TRANSPOSE and click the SECTION button.

PATTERNS

You can also add ACCENT to a step by clicking the ACCENT button while holding the keyboard button.

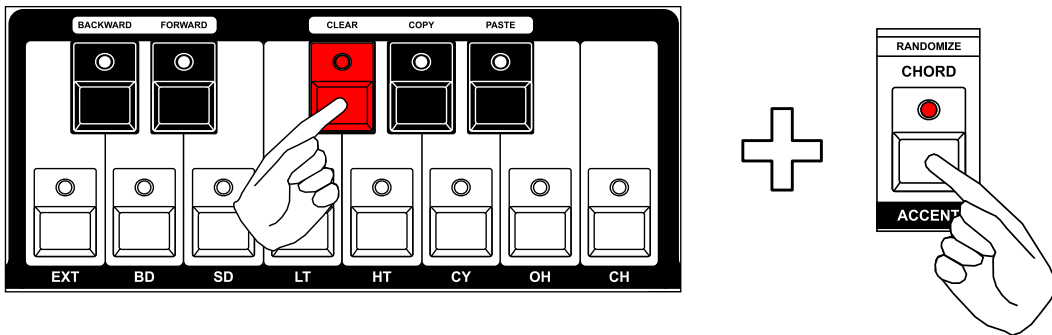

To increase the length of the current step, keep holding the current mini keyboard button and click the RECORD button, this will lengthen the step event by one step and advance the current step.

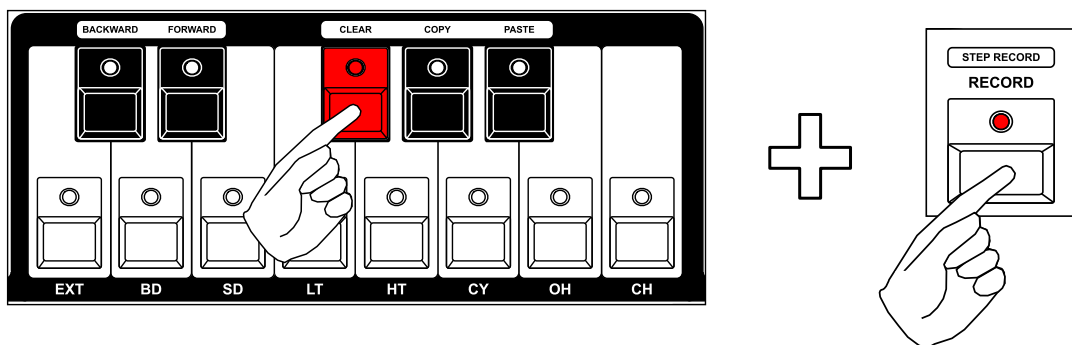

To enter a REST event, click the REST button, any existing event will be erased from the current step.

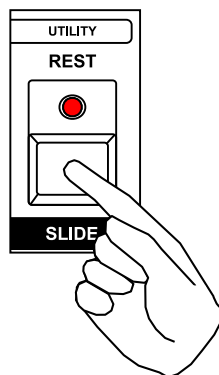

PATTERNS

To advance one step without entering any new data, click the RECORD button.

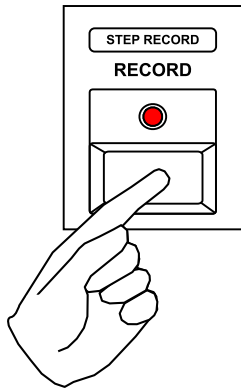

To leave STEP RECORD mode, click the FUNCTION button.

You can also continue to use grid recording on individual steps while in STEP RECORD mode. To do this, click and hold any pattern step button. The step attributes can be displayed and edited, when releasing the step button you can return to step recording.

PATTERNS

TRANSPOSING SYNTH PATTERNS

An entire synth type pattern can be transposed in semitones or octaves. This can be used to create musical progressions or to quickly experiment with different note ranges. Along with pattern copy/paste, pattern transpose can be used to create layers and variations across tracks.

To enter TRANSPOSE mode, press and hold (or double-click) the TRANSPOSE button. The current transposition value will be shown on the mini keyboard LEDs and the octave DOWN and UP LEDs.



To change the pattern transposition in semitones, click one of the mini keyboard buttons.

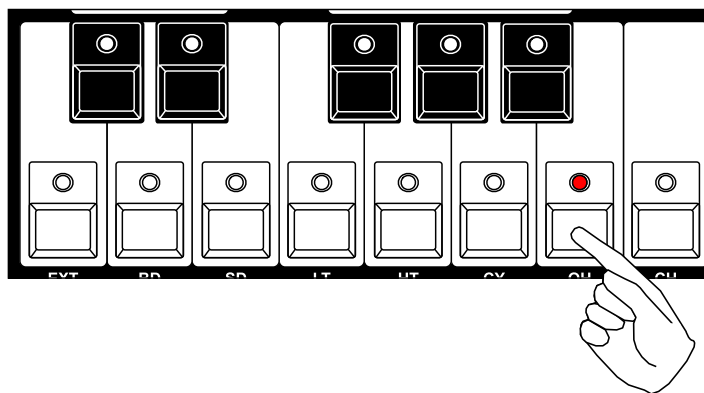

TIP: While holding the TRANSPOSE button, the mini-keyboard LEDs flicker briefly each time a note is played. This gives a good visual indicator of what notes are playing. Muted tracks will not flicker.

PATTERNS

To change the pattern transposition in octaves, click either the DOWN or UP buttons.

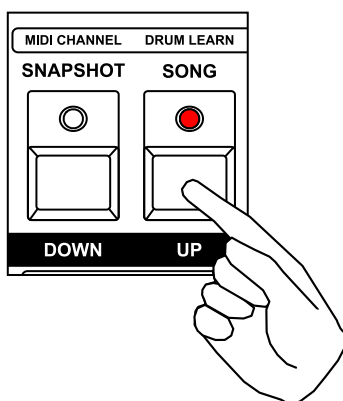

The LEDs of the octave buttons will light differently according to the selected octave. For example, one octave down will light the DOWN LED dimly, two octaves down will light the DOWN LED brightly, three octaves down will blink the DOWN LED dimly, four octaves down will blink the DOWN LED brightly.

Pattern transposition takes effect immediately even if the sequencer is playing.

TIP: You can use MIDI to transpose multiple patterns at the same time by turning on MIDI transpose listen in TRACK UTILITY mode.

PATTERNS

ALL ACCENT

To play back all pattern steps as accented notes, press and hold the ACCENT button while in transpose mode. Notes will resume normal playback when the ACCENT button is released.

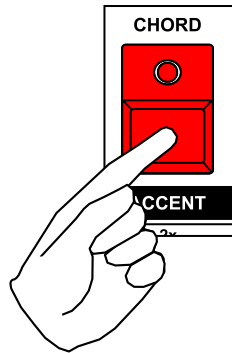

NO ACCENT

To play back all pattern steps as unaccented notes, press and hold the MUTE button and then press and hold the ACCENT button while in transpose mode. Notes will resume normal playback when the ACCENT button is released.

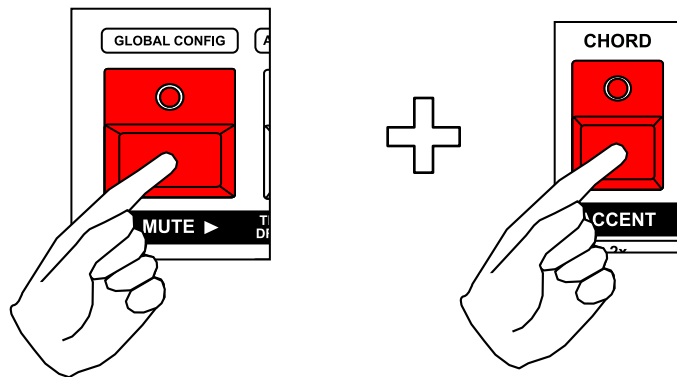

PATTERNS

SYNTH1: ALL SLIDE

To play back all pattern steps with slides, press and hold the SLIDE button while in transpose mode. Notes will resume normal playback when the SLIDE button is released.



SYNTH1: NO SLIDE

To play back all pattern steps without slide, press and hold the MUTE button and then press and hold the SLIDE button while in transpose mode. Notes will resume normal playback when the SLIDE button is released.

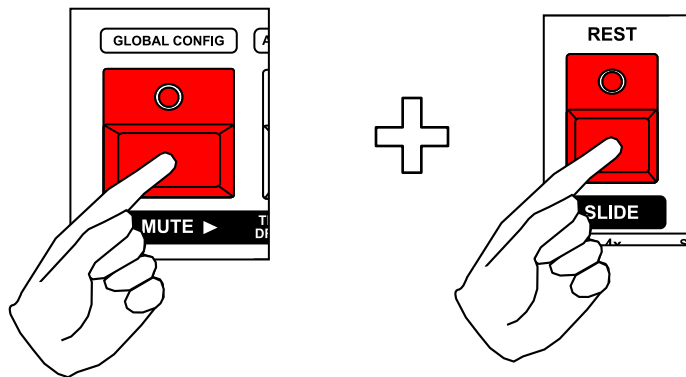

PATTERNS

ALL REPEAT

To play back all pattern steps with note repeat, press and hold the ROLL/ARP button while in transpose mode. Notes will resume normal playback when the ROLL/ARP button is released.

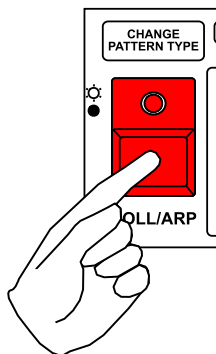

NO REPEAT

To play back all pattern steps without note repeat, press and hold the MUTE button and then press and hold the ROLL/ARP button while in transpose mode. Notes will resume normal playback when the ROLL/ARP button is released.

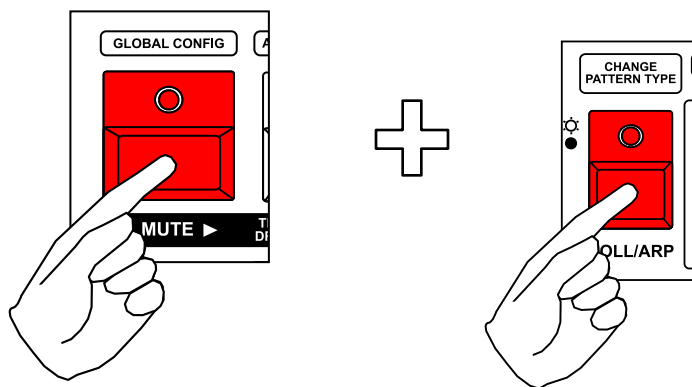

PATTERNS

REALTIME RECORD TRANSPOSE, ACCENT, SLIDE, NOTE REPEAT

Pattern transposition, accents, slides (for SYNTH1 patterns), note repeat and muting of accents, slides and note repeats can be recorded directly into a pattern in realtime. This is extremely useful for adding variation to a recorded pattern, or fixing and modifying accent and slide events.

To realtime record the transpose functions, press and hold (or double-click) the RECORD button while in transpose mode.



TIP: You can jump directly into and out of transpose mode while already in realtime record mode.

While in realtime transpose record, the mini-keyboard and octave down/up buttons can be used to transpose pattern notes. This transposition is recorded permanently into the pattern data.

Using the ACCENT, SLIDE and ROLL/ARP buttons, you can add accent, slide and note repeat events to pattern data. Using the MUTE button in combination with the ACCENT, SLIDE and ROLL/ARP buttons, you can erase events from pattern data.

PATTERNS

REALTIME ARPEGGIATOR

Synth type patterns include an arpeggiator that can be used for realtime performance or recorded directly into the pattern sequence.

To enter ARPEGGIATOR mode, press and hold (or double-click) the ROLL/ARP button.

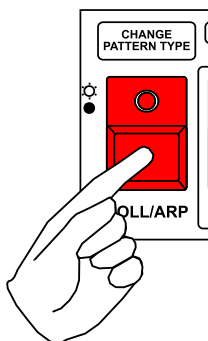

While in ARPEGGIATOR mode, the mini keyboard can be used to play arpeggios. Before playing notes on the mini keyboard, the octave can be set using the octave DOWN and UP buttons. The ACCENT button and SLIDE buttons can also be pressed to add variation in realtime.

While playing an arpeggio, the sequenced pattern is overridden. When the arpeggio is released, the sequenced pattern resumes.

TIP: The arpeggiator can also be played using an external MIDI controller.

TIP: The arpeggiator can be played while the sequencer is stopped.

SYNTH1 AND SYNTH2 ARPEGGIATOR DIFFERENCES

The arpeggiator has some different behavior when playing over a SYNTH1 or SYNTH2 type pattern.

On a SYNTH2 type pattern, the arpeggiator only applies to the currently selected note lane. This allows the other note lanes to continue playing along with the arpeggiator simultaneously. Using the arpeggiator record feature you can also record and layer multiple arpeggios on top of each other.







On SYNTH1 type arpeggios, the SLIDE button introduces slides to the playing notes (overlap). When using a SYNTH2 type pattern, the SLIDE button will hold the current note until the SLIDE button is released, making the note play longer.

PATTERNS

CHANGING THE ARPEGGIO PLAY MODE

The play mode of the arpeggio can be changed to create interesting variations.

The available play modes are:

AS PLAYED		The notes of the arpeggio will be played in the same order they were entered.
UP		The notes of the arpeggio will play in order up from lowest to highest pitch.
DOWN		The notes of the arpeggio will play in order down from highest to lowest pitch.
UP/DOWN		The notes of the arpeggio will play in order up from lowest to highest pitch, then switch direction to play back down from highest to lowest. The lowest and highest pitches will be repeated when changing direction.
RANDOM		The notes of the arpeggio will play in random order.
PROGRAMMED		The notes of the arpeggio will be played in the same order they were entered, but the gate times of the notes will be determined by the current pattern steps. The arpeggio does not play during REST steps.
PATTERN		The arpeggio pitches will be determined by the programmed pitches of the current pattern. The arpeggio does not play during REST steps.

To change the arpeggio play mode, while in ARPEGGIO mode, press the TIME button. The current play mode will be displayed on the LED display. To change the play mode, turn control knob 1 or click BACKWARD/FORWARD. The new play mode will be displayed on the LED display.

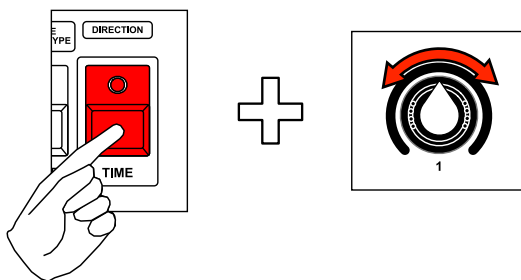

PATTERNS

ARPEGGIO PLAY MODE: PATTERN

The PATTERN play mode of the arpeggiator is a special mode which arpeggiates the notes of the current pattern, rather than taking live input from the keyboard.

For SYNTH1 type patterns, if there are multiple pitch slots active on a step, it will also arpeggiate through the pitches.

When there is a REST step in the pattern, the arpeggio will stop for the duration of the step. In addition, any steps with a programmed note repeat will also advance the arpeggio accordingly. These features allow you to program interesting arpeggios using the pattern directly.





Pattern based arpeggios are only active when ARPEGGIO latch is active and the sequencer is running, this means that you must click FUNCTION (HOLD) after selecting the pattern play mode in order to hear the arpeggio.

PATTERNS

CHANGING THE ARPEGGIO VARIATION

Each arpeggio play mode has 4 variations that change the playback of the arpeggio notes.

In general each variation applies the following rules:

VAR 1		Each pitch in the arpeggio is played once before moving to the next pitch.
VAR 2		Every odd pitch in the arpeggio is played twice before moving to the next pitch.
VAR 3		Every even pitch in the arpeggio is played twice before moving to the next pitch.
VAR 4		Each pitch in the arpeggio is played twice before moving to the next pitch.

To change the arpeggio variation, while in ARPEGGIO mode, press the TIME button and then turn control knob 2.

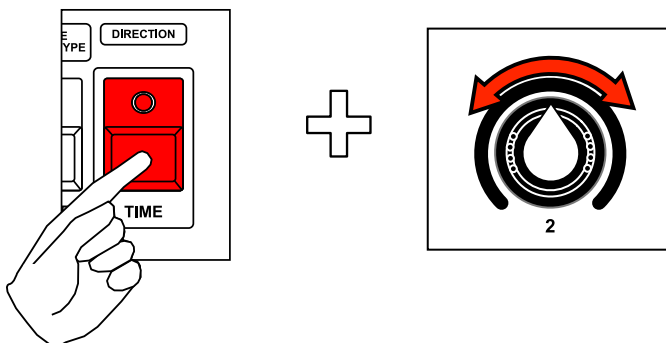

The variation number will be displayed on the LED display.

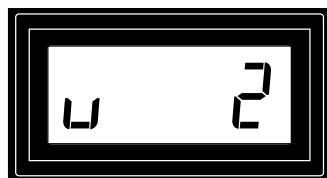

Arpeggio variation 2

PATTERNS

CHANGING THE ARPEGGIO OCTAVES

The arpeggio can be programmed to play over multiple octaves. The available range is from zero to +3 octaves.

To change the number of octaves, while in ARPEGGIO mode, press the TIME button and then turn control knob 3.

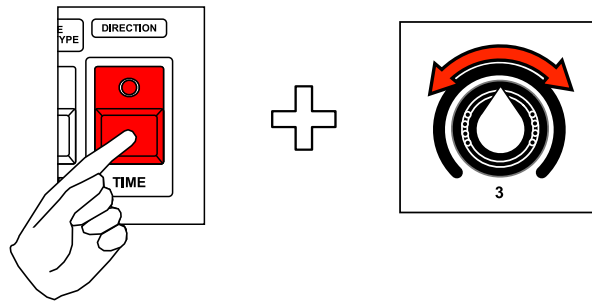

The number of arpeggio octaves will be displayed on the LED display.



Arpeggio notes will play two additional octaves

PATTERNS

LATCHING THE ARPEGGIATOR

The arpeggiator can be latched. When the arpeggiator is latched, it will continue to play, even when leaving ARPEGGIO mode.

You can add additional notes or remove notes from the arpeggio while the arpeggiator is latched, by clicking the buttons of the mini keyboard.

To latch the arpeggiator, while in arpeggio mode, click the FUNCTION button. To unlatch the arpeggiator, click the FUNCTION button again.

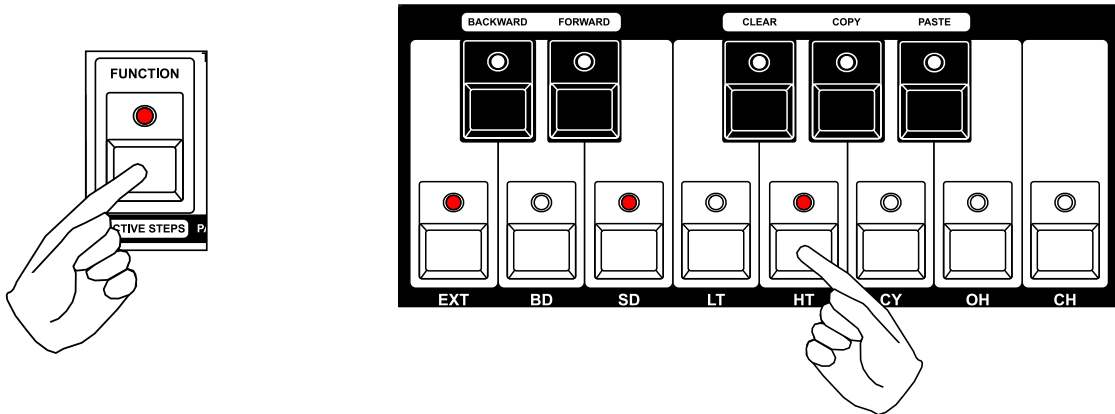

TIP: You can have different arpeggiators playing and latched in multiple tracks simultaneously.

TIP: For the pattern play mode, you must latch the arpeggiator to hear the arpeggio.

PATTERNS

RECORDING AN ARPEGGIO

If you find an interesting arpeggio, you can instantly record it directly into the pattern.

To record an arpeggio, while in ARPEGGIO mode, press and hold (or double-click) the RECORD button.

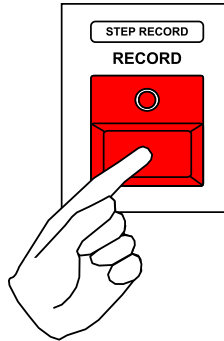

Momentary recording of an arpeggio can create interesting musical combinations in the sequenced pattern.

TIP: PAUSE RECORD also works with ARP mode.

PATTERNS

CHORD MEMORY

The CHORD MEMORY function can be used to automatically create polyphonic playback over MIDI.

Use CHORD MEMORY to define a chord shape that will be played for each step.

For SYNTH1 type patterns, CHORD MEMORY will use the programmed pitch in PITCH SLOT 1 as the basis for the chord. Programmed pitches for PITCH 2,3 or 4 are not used for CHORD MEMORY.

For SYNTH2 type patterns, CHORD MEMORY will be applied to notes in any of the four note lanes.

CHORD MEMORY is not confined to notes defined in the FORCE TO SCALE settings.

To enter CHORD MEMORY mode, press and hold (or double click) the CHORD button.

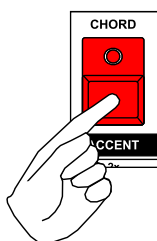

The current chord shape will be shown on the mini-keyboard LEDs. If no chord is defined, there will be no LEDs lit.

To define a new chord shape, while in CHORD MEMORY mode, click up to four of the mini keyboard buttons. The lowest note represents the basis of the chord and will be played with PITCH 1 from the programmed sequence. Additional notes in the chord shape will be played as an interval from the base pitch, transposing the chord according to the base pitch.

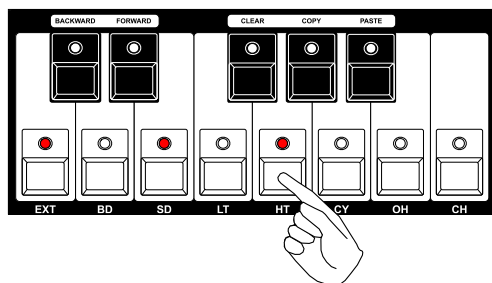

PATTERNS

To remove or change the chord, click lit mini keyboard buttons to remove notes from the chord. If there is only one lit note in the chord, or no lit notes, there will be no chord played.

CONTROL TYPE PATTERNS

Control type patterns are useful for recording specific controller values or automating playback of controller modulation. A control pattern can record up to six control values per step, which map to the six control knobs. The LFO mode of the control pattern can be used to create periodic modulation of any of the six control values.

SELECTING CONTROLLERS

There are 6 available controls in a control pattern.

While editing a control pattern, select which control is currently displayed on the pattern step LEDs by holding the TRANSPOSE/DRUM SELECT button to the left of the mini keyboard and then selecting the control using the first six white buttons of the mini keyboard labeled 1 thru 6. This is similar to programming a DRUM type pattern.

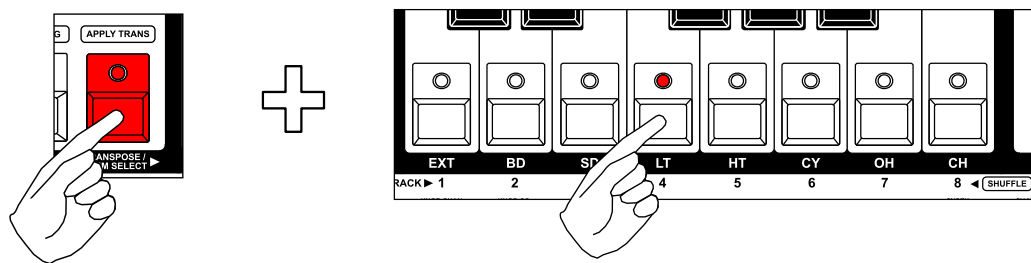

Selecting controller 4

TIP: While holding the TRANSPOSE/DRUM SELECT button, the track LEDs flicker briefly each time a control is played. This gives a good visual indicator of which controllers are being used. Muted controls will not flicker.

The pattern step LEDs will light brightly for high control values (64 - 127) and dimly for low control values (0 - 63), this gives some visual indication the control “shape” for the pattern.

PATTERNS

PROGRAMMING A CONTROL TYPE PATTERN

Control type patterns can be programmed using grid programming, step programming or realtime recording. Each method has its strengths, so you can choose the appropriate method for your situation. Realtime recording and step recording can also be used simultaneously with grid programming, allowing for very interactive sequencing.

GRID PROGRAMMING

Grid programming mode is the default mode and is always active, meaning that you don't need to enter record mode to use grid programming. Grid programming allows you to enter control values using the pattern step buttons. The step LEDs show which steps have a recorded control value for the currently selected control.

The programmed control value of a step is visible and can be edited while holding down a step button.

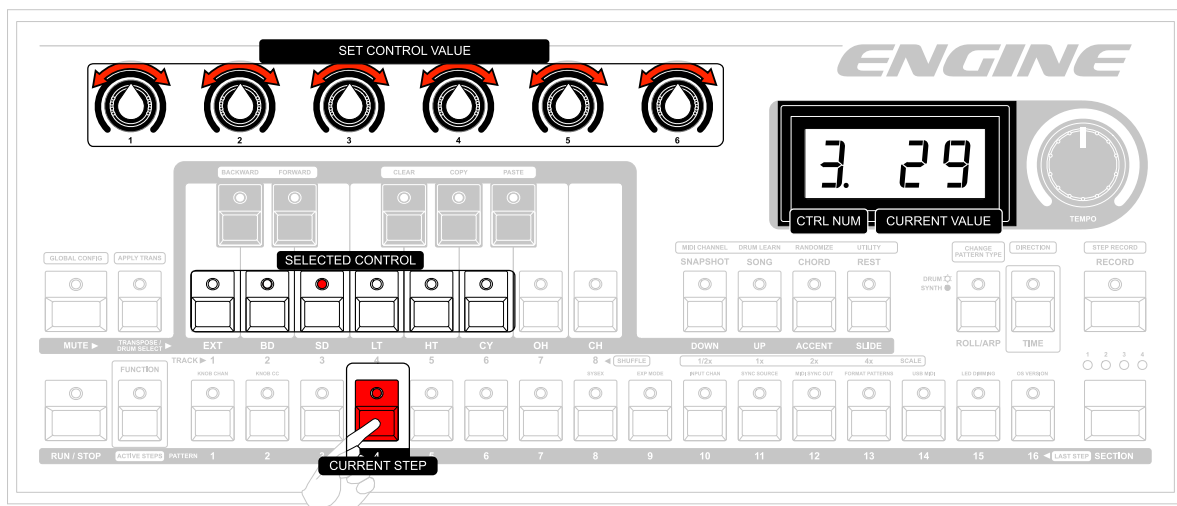

PATTERNS

ADDING OR REMOVING A CONTROL EVENT

After selecting the appropriate control, use the pattern step buttons to enter and remove events for the control. Quickly clicking a step button will activate or deactivate the step event, the programmed value for the control event will be remembered.

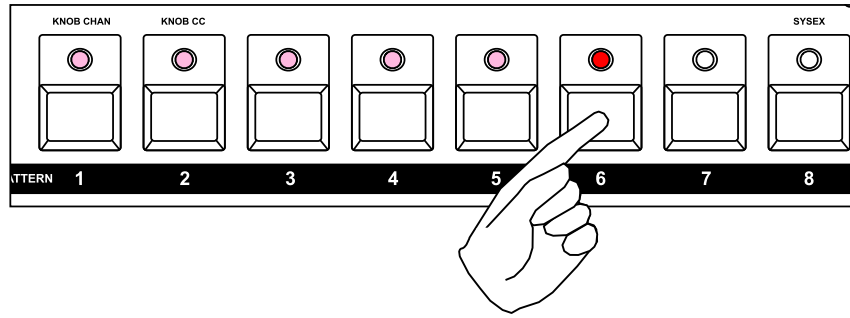

Adding a controller event on step 6

In addition, the CV expansion board will also generate a GATE signal for a programmed control event. This allows control type patterns to act similar to an analog sequencer, triggering envelopes with the gate signal, and sending CV voltages programmed into the control step.

GATE signals will also be generated on each step of an active LFO.

PATTERNS

CHANGING A CONTROL VALUE

To change a control value, click and hold the pattern step button where you wish to place the event. Continue to hold down the step button and then rotate one of the six control knobs to record a new control value.

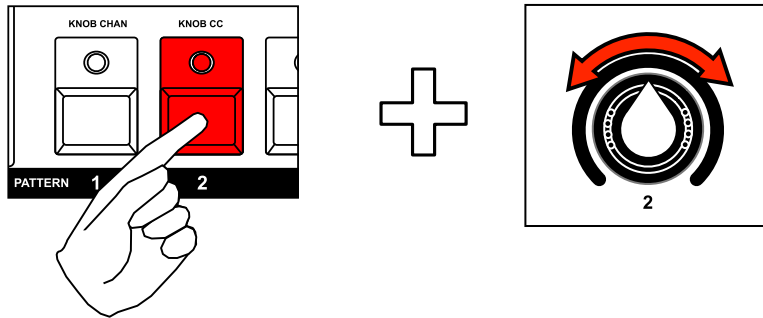

Setting control value 2 for pattern step 2

You can change any of the six control values using the control knobs. You can also use the BACKWARD/FORWARD buttons to change the control value.

TIP: When setting the value for a step using the control knobs, the selected control and step LEDs will change automatically to the control corresponding to the knob.

If you wish to edit an existing event, you can press and hold the step button and the step will not be deactivated when releasing the step button.

TIP: You can change multiple steps at the same time by holding two step buttons while turning a control knob. All intermediate steps will also be set to the same value.

PATTERNS

CONTROL SLIDE

The SLIDE attribute can also be set on a control step per control. Slide will generate one intermediate MIDI control value between adjacent control steps and with the (optional) CV expansion board it will also activate the slide circuitry before changing the CV value. Slide will create a smoother transition between control values.

NOTE: If there is not an adjacent active controller event, the slide parameter has no effect on MIDI output.

To enable slide on a control step, while holding the step, click the SLIDE button.

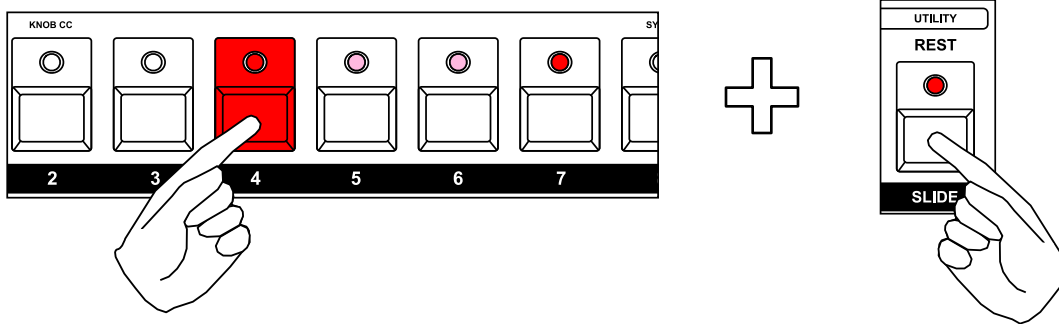

PATTERNS

REALTIME RECORDING

The pattern information for a control type pattern can be recorded in realtime using the control knobs. This allows a more expressive performance to be recorded directly into a pattern.

To enter RECORD mode, press and hold or double click the RECORD button. In record mode, the control knobs are used to record control values into the pattern as the pattern plays.

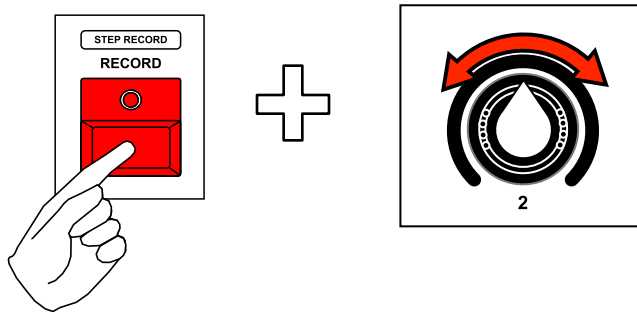

You can also continue to use grid recording on individual steps while in REALTIME RECORD mode. To do this, click and hold any pattern step button. The step attributes can be displayed and edited, when releasing the step button you can return to realtime recording.

PATTERNS

STEP RECORDING

Step recording is an alternate way to enter control values by moving from one step to the next in sequence. This can be done while the sequencer is running or stopped.

To enter STEP RECORD, press and hold (or double click) the FUNCTION button, then click the RECORD button. Both the FUNCTION and RECORD LEDs will blink to indicate you are in STEP RECORD mode.

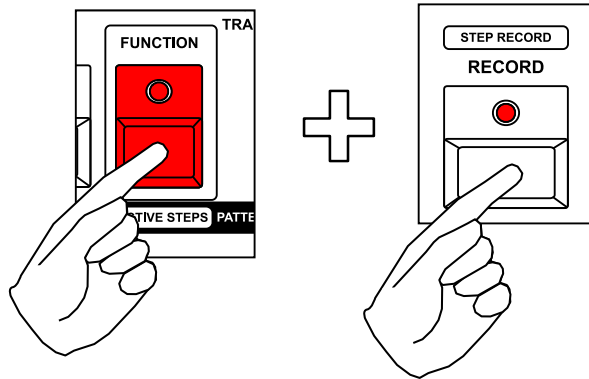

The current step location is indicated on the pattern step buttons with a bright blinking LED. You can immediately jump to a particular step by clicking a pattern step button, or begin entering step events from the beginning of the sequence.

In STEP RECORD, you can use the first six white buttons of the mini keyboard labeled 1 thru 6 to select which control is displayed on the step LEDs.

To enter control values, rotate one of the control knobs. The value of the control knob will be recorded to the current step and the step will advance automatically.

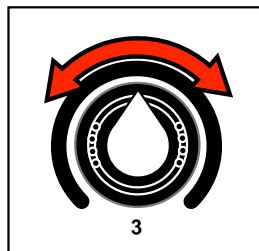

NOTE: Because a knob has a range of 0-127 values, turning the knob quickly will advance through the pattern steps very quickly! Try turning the knob slowly to see the steps advance.

PATTERNS

To enter a REST event, click the REST button, any existing control events will be deactivated on the current step.

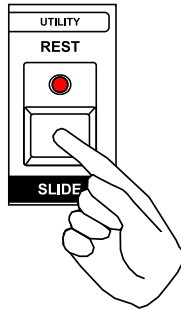

To advance one step without entering any new data, click the RECORD button.

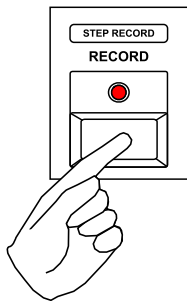

To leave STEP RECORD mode, click the FUNCTION button.

You can also continue to use grid recording on individual steps while in STEP RECORD mode. To do this, click and hold any pattern step button. The control values can be displayed and edited, when releasing the step button you can return to step recording.

PATTERNS

MUTING INDIVIDUAL CONTROLLERS

Individual controllers can be muted within a CONTROL type pattern to create pattern variations.

To enter CONTROL MUTE mode, press and hold (or double click) the TRANSPOSE/DRUM SELECT button, then press and hold (or double click) the MUTE button. The current mute status for each controller is shown on the LEDs of the first six white mini keyboard buttons. Unmuted controllers are shown as lit LEDs, while muted controllers are shown as unlit LEDs.

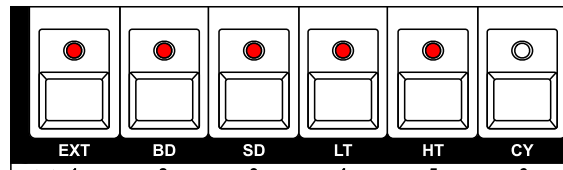
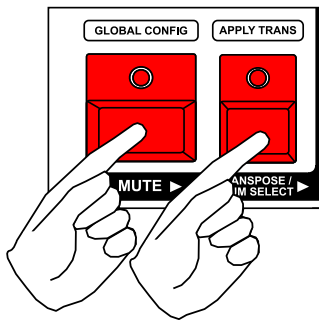

Controller 6 is muted

TIP: The MUTE and TRANSPOSE/DRUM SELECT buttons can be double clicked to pin the control mute function. This is useful for live performance when muting and unmuting individual controls.

To change the control mutes, while in control mute mode, click the white mini keyboard buttons to mute or unmute controllers.

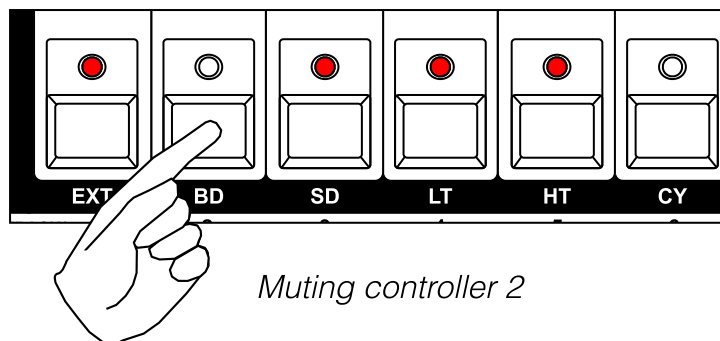

PATTERNS

SOLOING INDIVIDUAL CONTROLLERS

A single controller can be soloed, which will mute all other controllers. To solo a controller, while in CONTROL MUTE mode, press and hold the FUNCTION button, then click the controller you wish to solo. The selected controller will be unmuted, all other controllers will be muted.

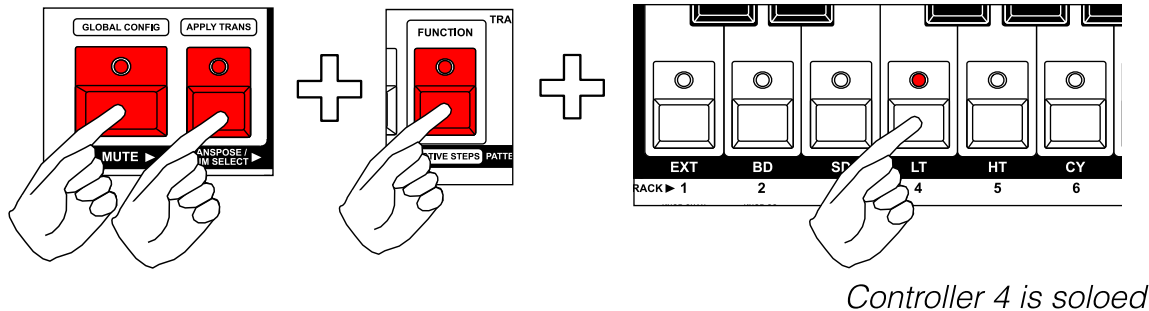

NOTE: Soloing a controller does not effect TRACK MUTES.

UNSOLOING CONTROLLERS

When a control is soloed, you can quickly unsolo it and return to the previous control mute settings.

To unsolo a controller, while in CONTROL SOLO mode, click the previously soloed control button. The control mute settings will be restored.

NOTE: You must unsolo a control before soloing a new control.

PATTERNS

LFO MODE

Control type patterns include an LFO (low frequency oscillator) function than can be used to create automated modulation of the controllers.

To enter LFO mode, press and hold (or double-click) the ROLL/ARP button.

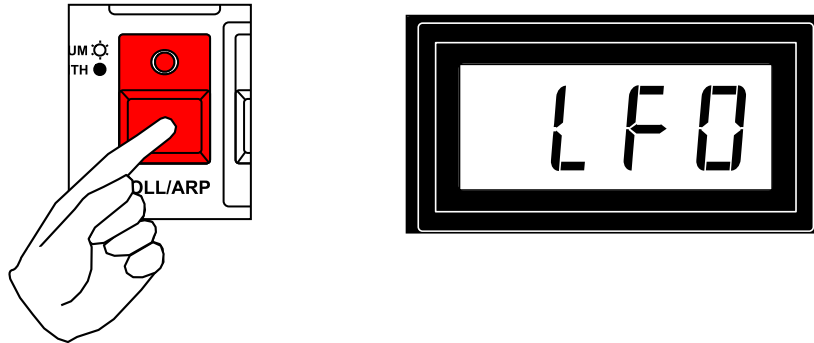

While in LFO mode, the first six white mini keyboard buttons can be used to engage the LFO for any of the six controllers.

While being modulated with the LFO, the sequenced pattern for that controller is overridden. When the LFO is released, the sequenced pattern resumes.

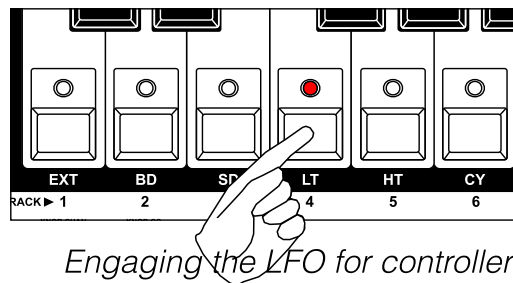

PATTERNS

CHANGING THE LFO SHAPE

The shape of the LFO can be changed to create different modulations.

The available shapes are:

TRIANGLE		Triangular shaped wave with equal time rising and falling
RAMP UP		The shape of a rising sawtooth wave.
RAMP DOWN		The shape of a falling sawtooth wave.
SQUARE		A square wave shape, with only maximum and minimum values generated.
RANDOM		A random wave shape, sometimes known as (random) sample and hold.

To change the LFO shape, while in ARPEGGIO mode, press the TIME button. The current shape will be displayed on the LED display. To change the shape, turn control knob 1. The new shape will be displayed on the LED display.

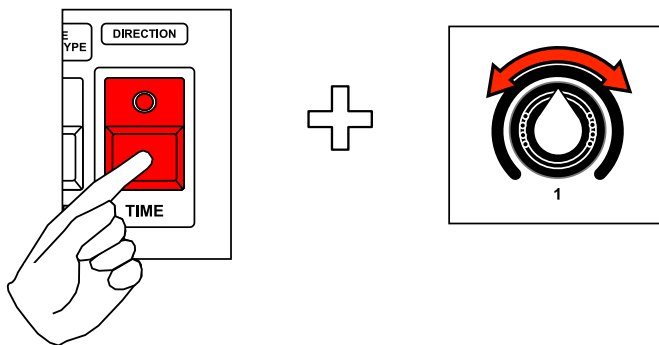

PATTERNS

CHANGING THE LFO SPEED

The speed of the LFO can be changed in units of pattern steps. The available speed range is from 2 to 128 steps. This means that the LFO speed is always relative to the pattern time scale and tempo.

To change the LFO speed, while in LFO mode, press the TIME button and then turn control knob 2. The number of steps will be displayed on the LED display.

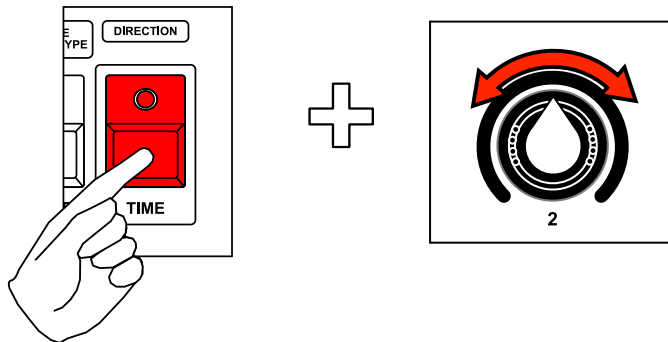

PATTERNS

CHANGING THE LFO MODULATION DEPTH

The modulation depth of the LFO can be adjusted to limit the range of control messages. Both the lower and upper limits of the control range can be set independently.

To change the LFO modulation depth, while in LFO mode, press the TIME button and then turn either control knob 3 for the lower limit or control knob 4 for the upper limit. The limit will be displayed on the LED display.

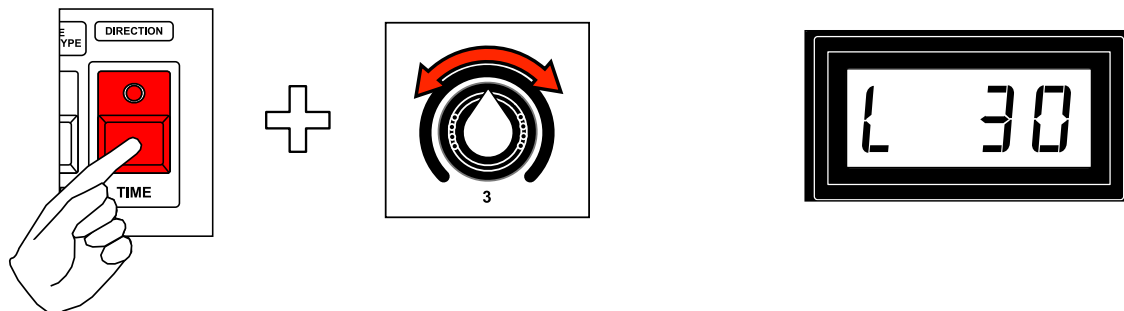

Setting LFO lower limit to 30

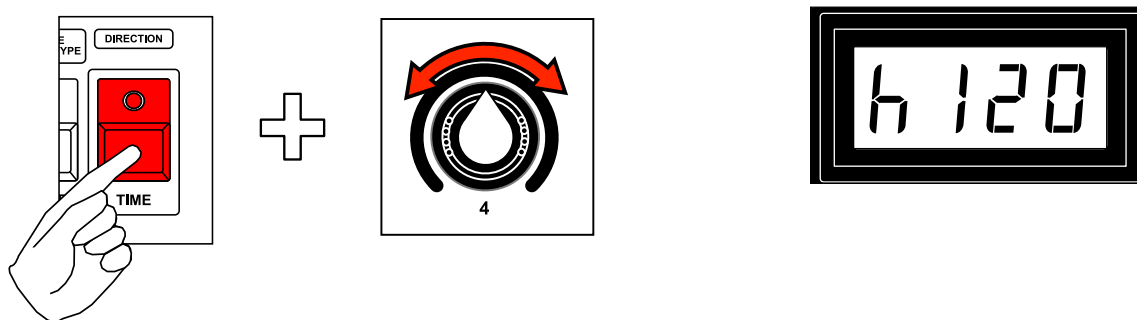

Setting LFO upper limit to 120

NOTE: The lower limit of the LFO cannot be set higher than the upper limit and vice versa.

PATTERNS

CHANGING THE LFO PHASE

The phase of the LFO can be changed in units of pattern steps. The available phase range is limited by the speed of the LFO. This means that the LFO phase number cannot exceed the number of steps defined for the speed.

To change the LFO phase, while in LFO mode, press the TIME button and then turn control knob 5. The phase will be displayed on the LED display.

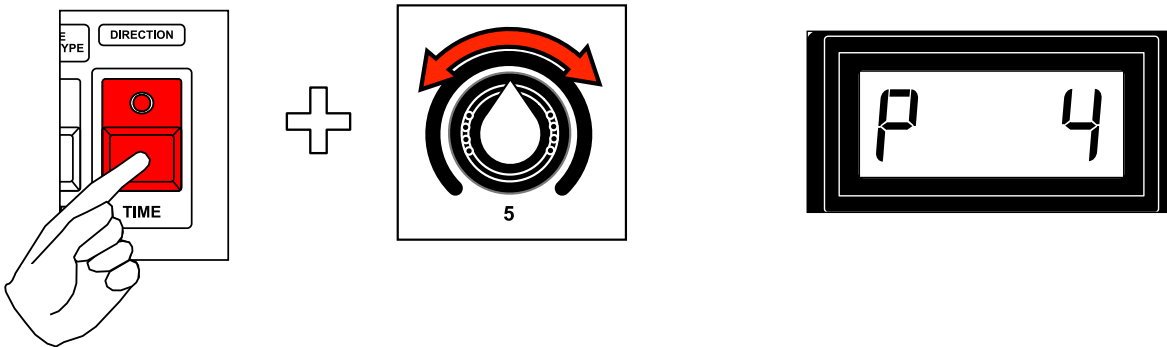

PATTERNS

LFO SLIDE

The LFO SLIDE function can be used to smooth the output of the LFO, this will send an intermediate value when using MIDI controllers and activate the slide circuit of the (optional) CV expansion board.

To activate LFO slide, while in LFO mode, click the slide button.

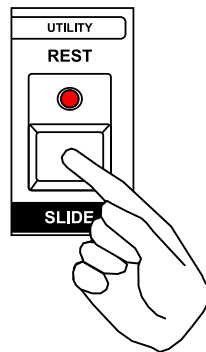

PATTERNS

LATCHING THE LFO

The LFO can be latched. When the LFO is latched, it will continue to play, even when leaving LFO mode.

You can add additional controllers or remove controllers from the LFO while the LFO is latched, by clicking the buttons of the mini keyboard.

To latch the LFO, while in LFO mode, click the FUNCTION button. To unlatch the LFO, click the FUNCTION button again.

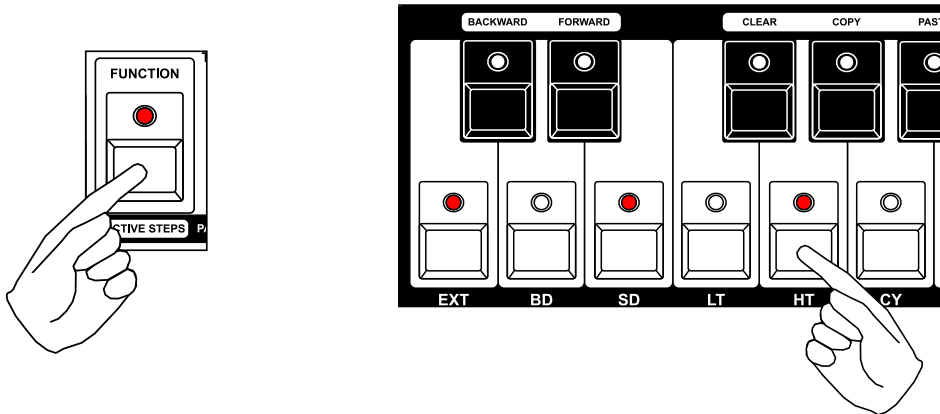

TIP: You can have different LFOs playing and latched in multiple tracks simultaneously.

RECORDING AN LFO

If you find an interesting LFO modulation, you can instantly record it directly into the pattern. To record an LFO, while in LFO mode, press and hold (or double-click) the RECORD button.

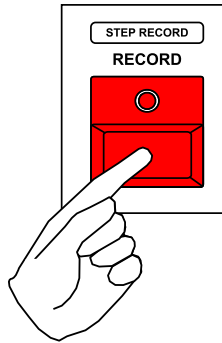

Momentary recording of an LFO can create interesting modulations in the sequenced pattern. By changing the LFO modulation settings and recording multiple takes, very complex modulations can be recorded into the pattern.

STEP FUNCTIONS

While holding a pattern step, you can also apply several functions to the individual step, such as rotate, clear, copy, paste and length. This can be used to make fine adjustments to a pattern during composition.

To use a step functions, while holding a pattern step, press and hold the FUNCTION button. Now the black (sharp) buttons of the mini-keyboard can be used to apply a function to the step. The note can also be shortened or lengthened using the OCTAVE DOWN and UP buttons.

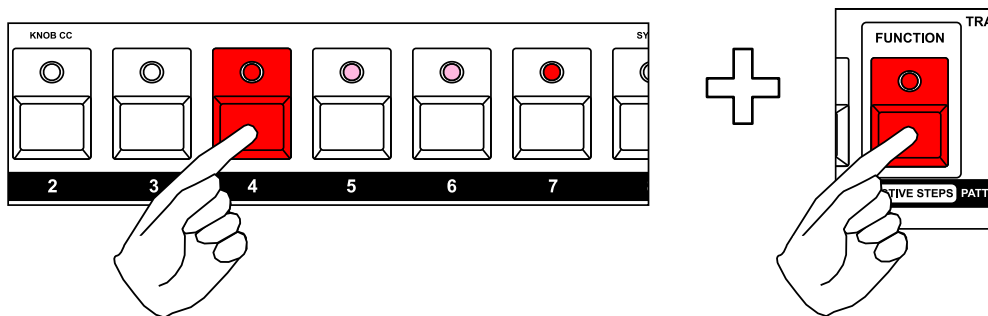

DRUM/CTRL: OPERATING ON ALL INSTRUMENTS

For DRUM and CONTROL type patterns, you can choose to apply the step function to all instruments, or a single instrument.

By default, the step function will only apply to the selected instrument. If you wish to apply the function to all instruments, press and hold the TRANPOSE/DRUM SELECT button while performing the function.

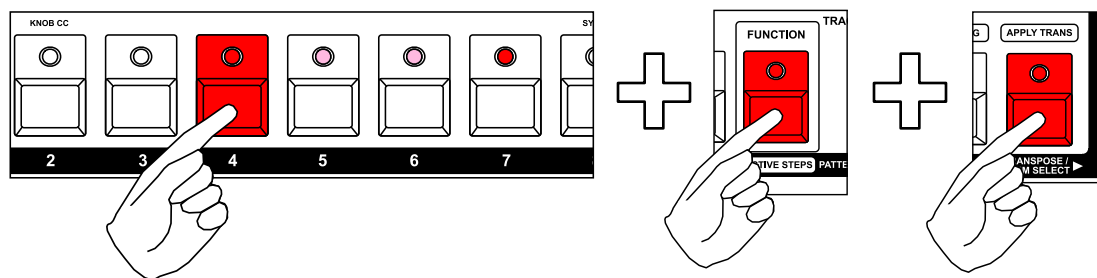

PATTERNS

STEP ROTATE

Rotating a step backwards or forwards will move the selected step location within the programmed pattern. This is useful when only one note is recorded into the wrong step location.

To rotate a step, while holding the pattern step button and FUNCTION, click the black mini-keyboard button labelled BACKWARD (C#) or the black mini-keyboard button labelled FORWARD (D#).

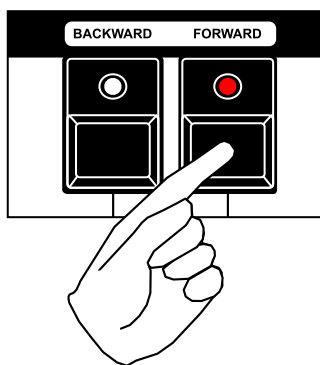

You can move a step forwards or backwards multiple steps, any previous notes on the effected steps will be overwritten.

STEP CLEAR

You can clear a selected step by clicking the black mini-keyboard button labelled CLEAR (F#). This will remove the step event. This serves the same purpose as clicking a pattern step button to turn it off.

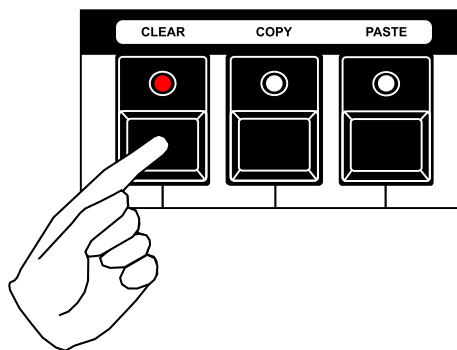

PATTERNS

STEP COPY

You can copy a selected step by clicking the black mini-keyboard button labelled COPY (G#). This will copy the selected step into the clipboard.

The length of a synth type note is also copied.

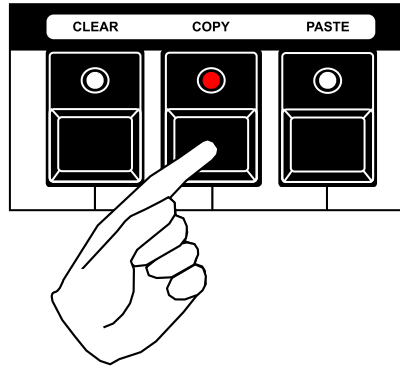

PATTERNS

STEP PASTE

You can paste a previously copied note by clicking the black mini-keyboard button labelled PASTE (A#). This will paste the clipboard step into the selected step.

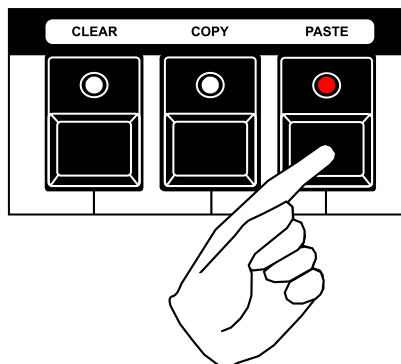

The length of the clipboard note is also pasted into the pattern, overwriting any previous step data.

The clipboard note can be pasted multiple times. This can be useful when a particular note needs to be repeated in several locations, avoiding the need to manually recreate the note on each step.

SYNTH1/SYNTH2: STEP LENGTH

The length of the selected step can be changed in STEP FUNCTION mode by clicking the OCTAVE DOWN or UP buttons. This is useful when you want to extend a note past a section boundary, for example if a note should be longer than 16 steps.

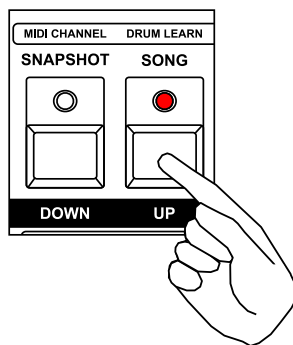

As the length of the note is increased, it will overwrite any previous step data.

PATTERN FUNCTIONS

There several useful functions that operate on patterns, which are available in FUNCTION MODE. These include things like pattern copy and paste, clear, rotate and randomize.

To enter FUNCTION MODE, press and hold (or double click) the FUNCTION button. The FUNCTION button is outlined with a color and text above the button. All of the available functions in function mode are shown as colored text surrounded by a colored line above the relevant button.

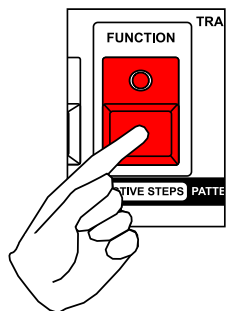

DRUM/CONTROL: OPERATING ON ALL INSTRUMENTS

By default, pattern functions apply to all instruments. To operate on individual instruments, press and hold the TRANSPOSE/DRUM SELECT button before performing the pattern function.

While holding the TRANSPOSE/DRUM SELECT button, the white keys of the mini-keyboard display the selected instrument. You can select a different instrument directly from the mini-keyboard. This makes it easy to apply pattern functions to different instruments individually.

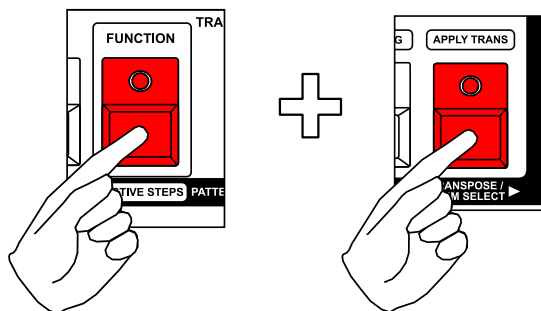

PATTERNS

SYNTH: APPLY TRANSPOSE

You can permanently apply the current synth pattern transposition amount directly to the sequence events.

This function is useful when you wish to transpose a pattern over a greater range, or view the pattern step events at the correct pitch.

To apply the current transposition to the pattern, while in FUNCTION mode, click the TRANSPOSE/DRUM SELECT button. The current transposition amount is applied to the sequence notes. This function also resets the current pattern transpose back to default (no transposition).

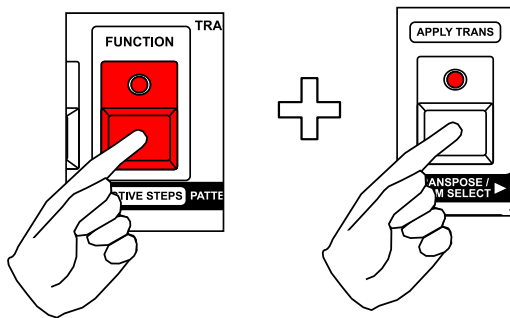

PATTERNS

PATTERN ROTATE

The pattern rotate function allows you to shift all pattern events forwards or backwards one step at a time. This is useful when a pattern is off-beat in relation to other patterns. It can also be useful for creating interesting variations of existing patterns.

To rotate a pattern, in FUNCTION mode, click the BACKWARD (C#) or FORWARD (D#) buttons on the mini keyboard. BACKWARD will rotate the pattern backward (left) and D FORWARD will rotate the pattern forward (right).

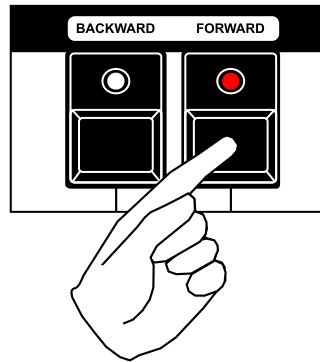

The pattern step LEDs will change to show the new event locations.

PATTERNS

PATTERN CLEAR

The pattern clear function will remove all note events and reset all steps to the default pitch on a SYNTH type pattern. It will also reset the pattern length to 16 steps, time scale to 1x (4/4) and shuffle amount to zero.

To clear a pattern, in FUNCTION mode, press and hold the CLEAR(F#) button on the mini keyboard, then click the pattern step button of the pattern you wish to clear. The current pattern is shown with a brightly lit LED on the pattern step buttons.

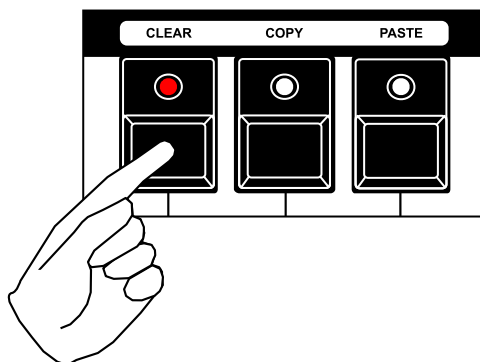

PATTERN COPY

Patterns can be copied into a temporary buffer for pasting into another pattern location or transmitting via MIDI system exclusive. Pattern copy can also be used to copy patterns between tracks.

To copy a pattern, in FUNCTION mode, press and hold the COPY (G#) button on the mini keyboard, then click the pattern step button of the pattern you wish to copy. The current pattern is shown with a brightly lit LED on the pattern step buttons.

The copied pattern is now stored in the pattern buffer.

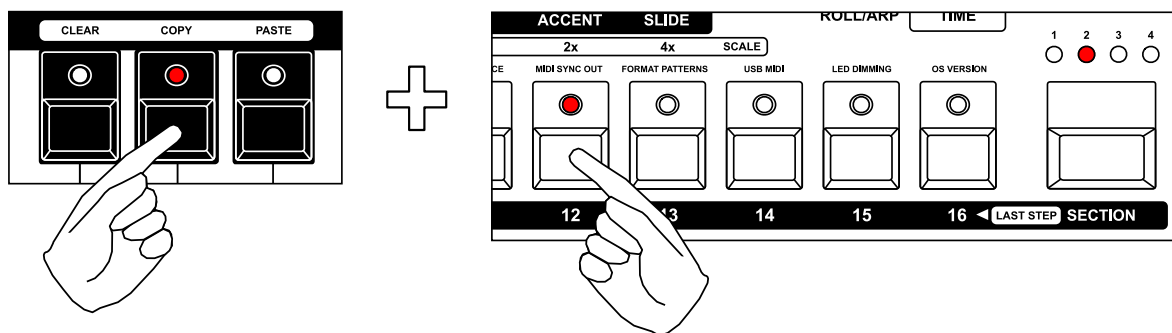

PATTERNS

PATTERN PASTE

When a pattern has been copied into the pattern buffer using the COPY function, it can be pasted into any other pattern location.

To paste a pattern, in FUNCTION mode, press and hold the PASTE (A#) button on the mini keyboard, then click the pattern step button of the pattern you wish to paste into. The current pattern is shown with a brightly lit LED on the pattern step buttons.

The same pattern can be pasted into multiple pattern locations

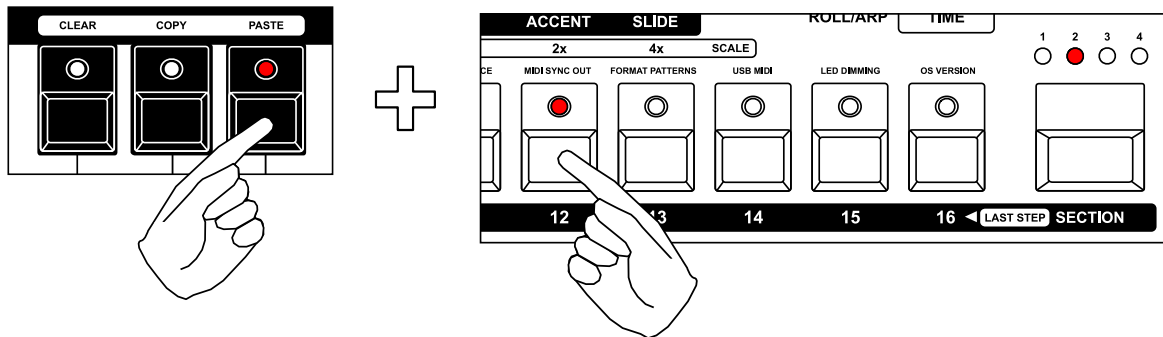

PATTERNS

PATTERN RANDOMIZE

Pattern data can be randomized to create unexpected variations. Using randomize along with precise pattern editing can result in usable patterns that might not have been obvious through traditional sequencing.

Randomize can selectively act on the step events of a pattern, including pitches, gates, velocity and slide. To access the randomize function, in FUNCTION mode, hold the RANDOMIZE button.

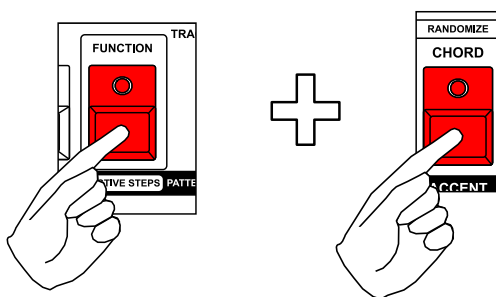

RANDOMIZE VALUE

If you do not want to randomize the values of steps in the current pattern, you can turn off value randomization.

For SYNTH type patterns, this means turning off the randomization of pitch. For DRUM type patterns, this turns off randomization of velocity. For CONTROL type patterns this turns off randomization of the control values.

While holding the RANDOMIZE button, the TRANSPOSE button can be used to turn on/off the randomization of values in the pattern.

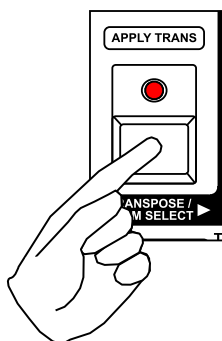

PATTERNS

RANDOMIZE GATE

If you do not want to randomize the gates of the current pattern, you can turn off gate randomization.

For SYNTH type patterns, this means turning off the randomization of note events. For DRUM type patterns, this turns off randomization of drum triggers. For CONTROL type patterns this turns off randomization of control triggers.

While holding the RANDOMIZE button, the TIME button can be used to turn on/off the randomization of gates in the pattern.

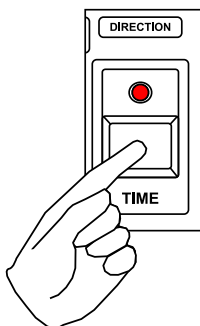

SYNTH1/SYNTH2: RANDOMIZATION PITCHES

For SYNTH type patterns, you can specify which pitches will be generated by the RANDOMIZE function. This is useful to generate patterns that have specific notes that will fit into your melodic structure.

While holding the RANDOMIZE button, the keys of the mini-keyboard will show the pitches that can be generated. To remove/add a pitch, click the corresponding button of the mini-keyboard.

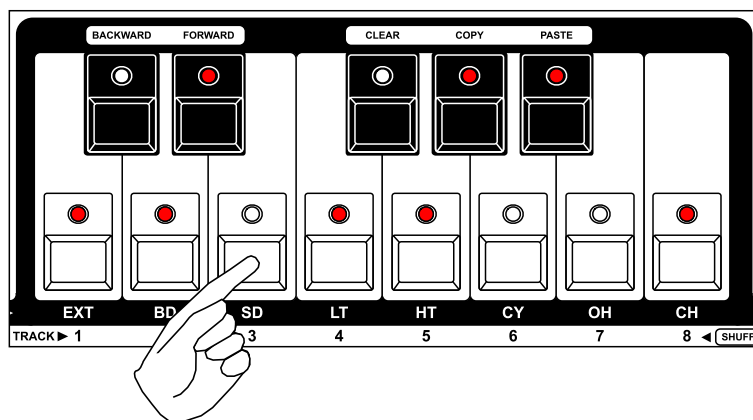

PATTERNS

SYNTH1/SYNTH2: PITCH RANGE BIAS

For SYNTH type patterns, you can introduce a bias that will generate notes in a certain pitch range. The bias will cause notes to be mostly low range, middle range or high range. The pitch bias is useful to generate patterns with a specific range, such as a bassline.

While holding the RANDOMIZE button, the OCTAVE DOWN/UP buttons can be used to introduce a bias.

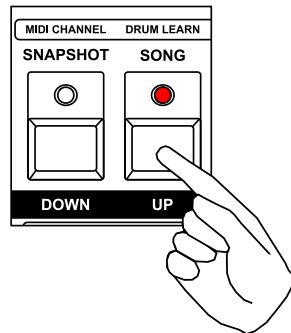

SYNTH1: SLIDE RANDOMIZATION

For SYNTH1 type patterns, you can specify whether slide events will be generated by the RANDOMIZE function. This is useful to generate patterns that have no slide events.

While holding the RANDOMIZE button, the SLIDE button will show if slide events will be generated. To turn on/off slides, click the SLIDE button.

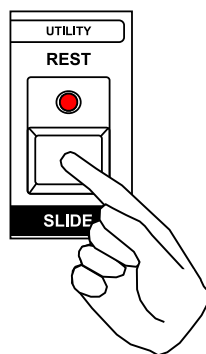

PATTERNS

DRUM/CTRL: INSTRUMENT EXCLUDE

For DRUM and CONTROL type patterns, you can specify which instruments/controls will be affected by the RANDOMIZE function. This is useful to generate random patterns for only a specific instrument while leaving other instruments untouched.

While holding the RANDOMIZE button, the keys of the mini-keyboard will show the instruments or controls that will be randomized. To remove/add an instrument, click the corresponding button of the mini-keyboard.

For DRUM type patterns, you can move between the instrument groups by clicking BACKWARD/FORWARD buttons.

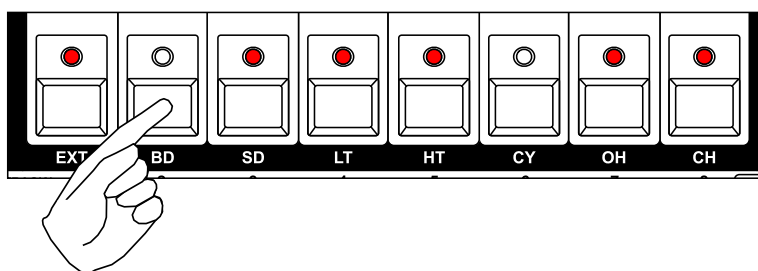

Excluding BD and CY from randomization

PATTERNS

EXECUTING RANDOMIZATION

To perform randomization of the current pattern, in FUNCTION mode, press and hold the RANDOMIZE (accent) button, then click the SECTION button to confirm. The section LEDs blink to warn that randomize is a destructive operation.

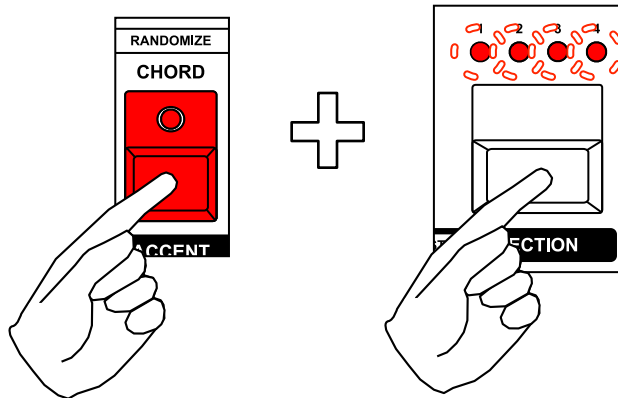

After pressing the SECTION button, the pattern will be immediately randomized.

The SECTION button can be clicked multiple times to repeatedly generate random patterns.





TIP: Randomize is a destructive operation. All current pattern information will be overwritten. You can use the UNDO function to recover from accidental randomization.

PATTERNS

PATTERN DIRECTION

Patterns can be set to play in various directions, which is useful for creating interesting sequence variations.

The current available directions are:

FORWARD		Pattern steps are played one after the other in a forward direction.
BACKWARD		Pattern steps are played one after the other in a backward direction.
PENDULUM		Pattern steps are played one after the other in a forward direction, then direction switches to backward. First and last steps are repeated.
RANDOM		Pattern steps are played in a random order.
PROBABILITY		The next pattern step is selected based on percent probability that it will be the next step forward, otherwise it will be the next step backward.

To view the current pattern direction, while in FUNCTION MODE, press the DIRECTION (time) button. The direction will be displayed on the LED display.

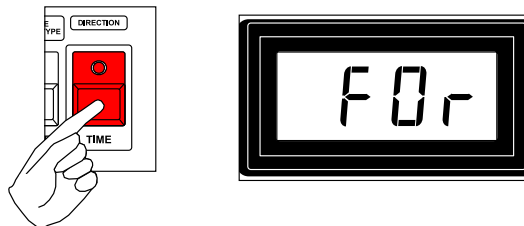

PATTERNS

To change the direction, while in FUNCTION mode, press the DIRECTION (time) button and then rotate control knob 1 or click BACKWARD/FORWARD. The LED display will change to show the selected pattern direction.

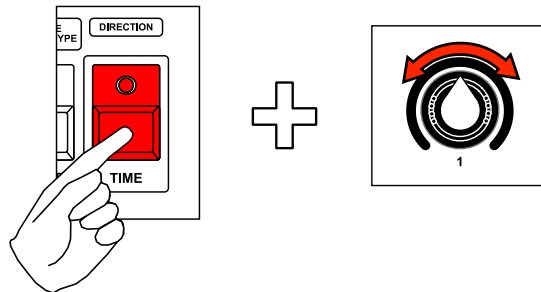

When the sequencer is playing, changes to pattern direction will not take effect until the pattern loops. This keeps the pattern in sync with other playing patterns.

The reverse pattern direction will always play the first step of the pattern first and then play backwards. This keeps the downbeat of a programmed pattern in the correct location in relation to other playing patterns, for more musical results.

PATTERNS

PROBABILITY DIRECTION

The probability playback direction can be used to introduce some random qualities to the pattern during playback.

Probability uses a defined percentage amount to determine whether the next step played will be the previous step or the following step from the current step location.

With a percentage of 50%, there is a 50/50 chance that the next step played will be the previous step. As the percentage is decreased, it becomes more likely that the sequence will play the previous step, until 0% which means that the pattern will play completely backwards. In contrast, a percentage of 100% will cause the pattern to play completely forwards

To adjust the percentage parameter, first select the probability direction, then while holding the DIRECTION button, rotate control knob 2.

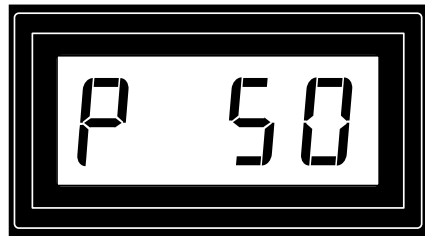
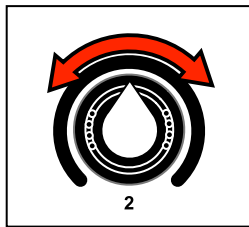

SNAPSHOTS

Snapshots are used to store the current settings of all tracks. They are extremely useful for live performance, to recall the settings for all tracks with a single button press.

A snapshot records the following settings for all tracks:

- pointers to selected patterns and pattern chains
- track mute status
- pattern transpose value for selected SYNTH type patterns
- drum instrument mutes for selected DRUM type patterns
- controller mutes for selected CONTROL patterns
- MIDI effects values for each track
- MIDI channel and port assignments for each track
- The current sequencer tempo

There are two groups of 64 snapshots (four banks of 16) for a total of 128 snapshots available.

Songs are created using a sequence of snapshots.

To enter SNAPSHOT mode, press and hold (or double click) the SNAPSHOT (down) button. The snapshot LED will light or blink to indicate you are in SNAPSHOT mode.

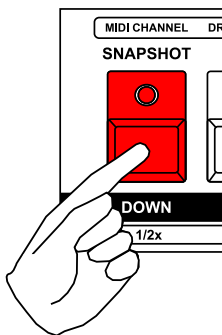

Used snapshot locations will be shown with a dimly lit LED, while the current snapshot is shown with a brightly lit LED. If no snapshots have been created, then snapshot location 1 is automatically selected.

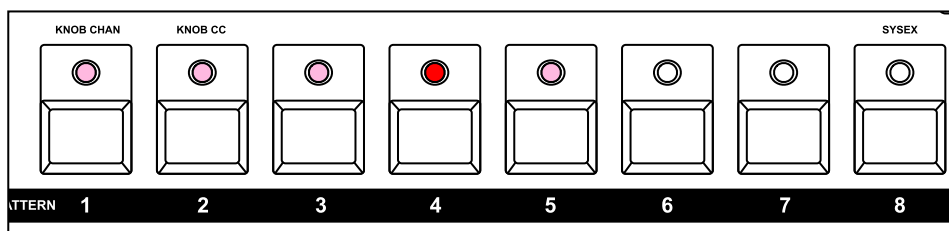

SNAPSHOTS

Use the SECTION button to move between the four snapshot banks in the current group.

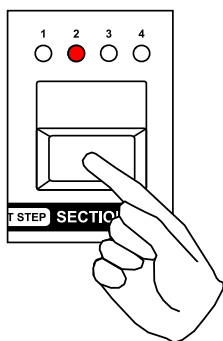

To switch between the two groups of 64 snapshots, while holding the SNAPSHOT button, click the BACKWARD or FORWARD button. The current snapshot group is displayed on the LED display.

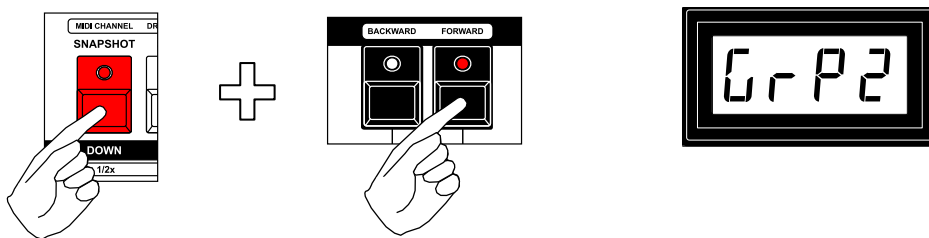

Selecting snapshot group 2

CREATING SNAPSHOTS

Initially all snapshot locations are empty. By default, an empty snapshot points to the pattern of the same number in all tracks, for example, snapshot 2 points to pattern 2 in all 8 tracks.

There are two ways to create a new snapshot, depending on how you like to work. To simplify terminology we will call these methods **SNAPSHOT RECORD** and **SNAPSHOT PASTE**.

In the **SNAPSHOT RECORD** method, you set up selected patterns and pattern chains for each track, set MIDI effects, track mutes, synth pattern transpose and drum pattern instrument mutes. This setup is then recorded to a new snapshot location. Because snapshots point to pattern locations (without actually storing pattern data) any changes to a pattern used by multiple snapshots will be heard in all snapshots that use that pattern. This is useful when you want to make a change to a pattern once and have that change applied throughout a song.

In the **SNAPSHOT PASTE** method, you set up track mutes, MIDI effects, and pattern programming. Instead of recording this as a new snapshot with pointers to the same patterns, you can paste the current settings into a new snapshot location and at the same time copy the actual pattern data into new pattern locations which will be used by the new snapshot. This is useful when you wish to create unique variations of patterns that do not get applied throughout a song.

Both methods are covered in more detail in the following sections.

SNAPSHOTS

SNAPSHOT RECORD

Recording a new snapshot will only maintain pointers to the currently selected patterns and pattern chains in each track, it does not modify pattern data. This means that recording a new snapshot could point to the same patterns used by a previous snapshot, if the pattern selections have not changed. This can be useful when making song wide changes to a pattern, or if you wish to conserve pattern usage. Because the transpose and drum/ctrl mute state is stored with the snapshot, you can use a single pattern with different snapshot settings to create variation.

To record a new snapshot, while in SNAPSHOT mode, press and hold the RECORD button, then press a pattern step button. The new snapshot location will be recorded and selected automatically.

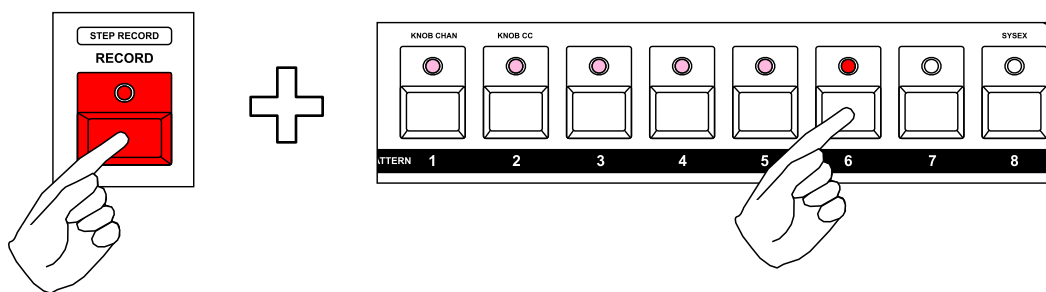

TIP: You can continue to set the track mutes, pattern transpose and drum instrument mutes without leaving SNAPSHOT mode, making it much quicker to create and store snapshot variations.

SNAPSHOTS

SNAPSHOT PASTE

Pasting a new snapshot will still point to patterns, but it will copy the current patterns in each track to new pattern locations and point to these new patterns.

This means that pasting a new snapshot will point to different patterns than the previous snapshot. This can be useful when making variations of a pattern, which are not applied across an entire song or shared by other snapshots.

Because pasting the snapshot copies the current patterns forward and each pattern will have it's own transpose/mute settings, it is recommended to turn off snapshot transpose/mute recall in SNAPSHOT CONFIG mode. Otherwise, the transpose settings from the previous patterns will be applied when the new snapshot is selected, even if the new patterns have been modified.

NOTE: Pasting a snapshot will only copy the current EDIT PATTERN for each track, it does not copy pattern chains. If a pattern chain is selected in the current track, it will not be maintained in the pasted snapshot.

To paste a new snapshot, while in SNAPSHOT mode, first press and hold the PASTE button.

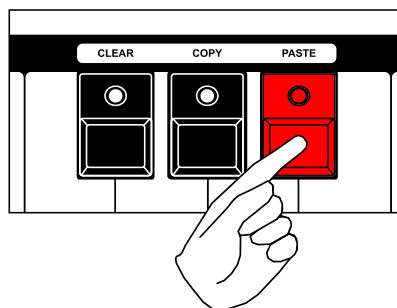

When the paste button is first pressed, the current snapshot settings are automatically copied into a buffer for pasting. This means that there is not a dedicated SNAPSHOT COPY operation.

SNAPSHOTS

While the PASTE button is held, you will also notice that the eight track select LEDs will be lit. These indicate which of the eight tracks will be copied forward into new pattern locations. To exclude a track from the pattern paste operation, click the track button to disable it. An excluded track will continue to use the current selected pattern in the new snapshot.

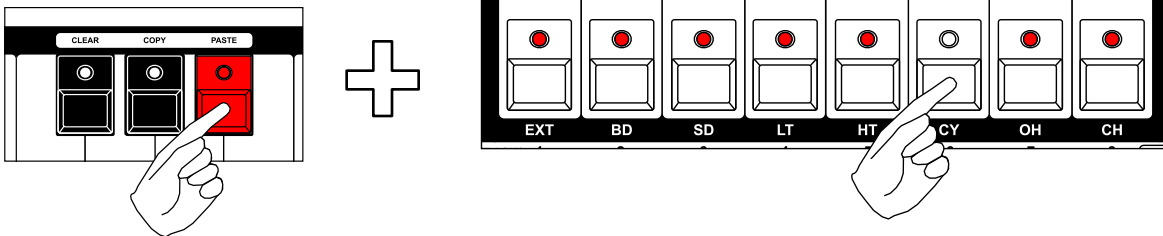

Once you have selected the tracks to copy forward, click the pattern select button of the new snapshot location to create. The new snapshot will be automatically selected and point to the new patterns that were also copied forward.

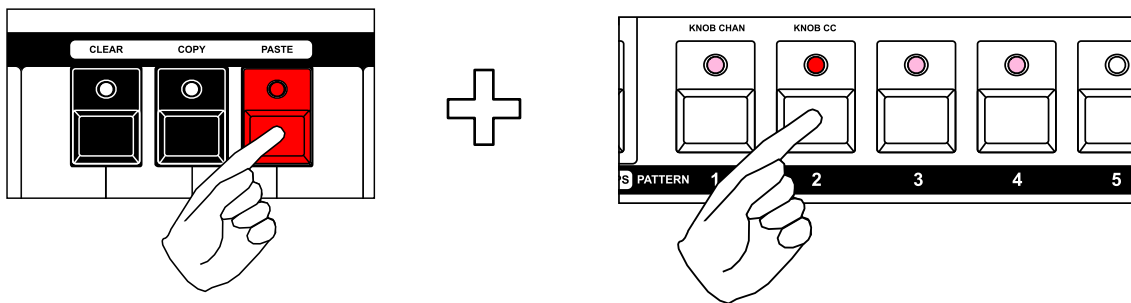

The new pattern locations used by the pasted snapshot will always be the pattern with the same number as the new snapshot. For example, if you paste into snapshot location 9, all patterns copied forward will be pasted into pattern location 9 across all tracks. Any existing pattern data in these locations will be overwritten!

Because there are 128 (2 groups x 64) total snapshots, and only 64 total patterns per track, pasting a snapshot in one snapshot group could overwrite pattern data used by the same numbered snapshot in the other snapshot group. In general, it is recommended to only use SNAPSHOT PASTE within one snapshot group per project, using the second snapshot group as a "variation" of the first, possibly with varied track mute settings or MIDI effects that will apply to the same patterns.

SNAPSHOTS

RECALLING SNAPSHOTS

Once you have recorded some snapshots, you can recall them when needed.

To select a snapshot, while in SNAPSHOT mode, click one of the pattern step buttons. It is possible to recall an unused snapshot and it will recall the default settings.

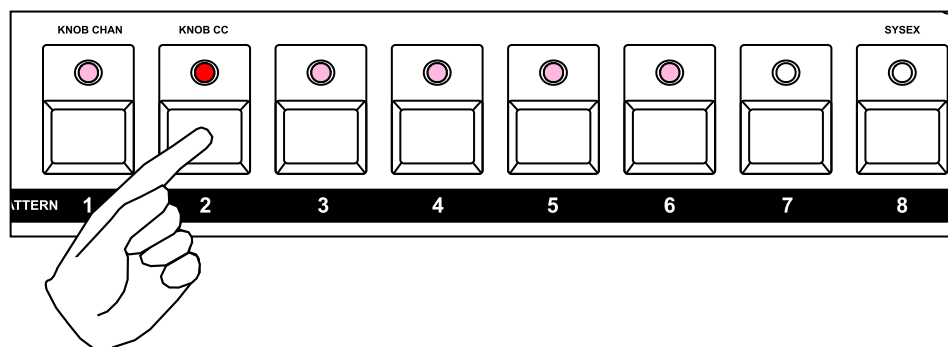

The settings for track mutes, selected patterns and (optionally) pattern transpose/drum/ctrl mute, MIDI effects, MIDI ports, channels and tempo will be recalled.

If the sequencer is running, the snapshot will be recalled when all current patterns or the MASTER TRACK have looped.

CLEARING SNAPSHOTS

Clearing a snapshot sets that snapshot location as unused. It will assign all tracks with patterns that match the snapshot number, for example clearing snapshot 6 will automatically assign pattern 6 to all tracks in the snapshot.

To clear a snapshot, while in SNAPSHOT mode, press and hold the CLEAR (F sharp) button, then click the step button for the snapshot you wish to clear. You can clear snapshots other than the currently selected snapshot.

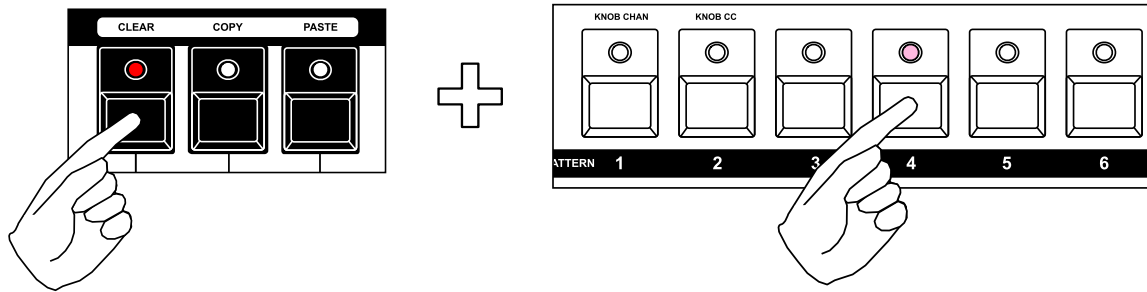

SNAPSHOT FUNCTION MODE

SNAPSHOT FUNCTION mode allows control of MIDI effects without leaving snapshot mode.

To enter SNAPSHOT FUNCTION mode, while in SNAPSHOT MODE, press and hold (or double-click) the FUNCTION button.

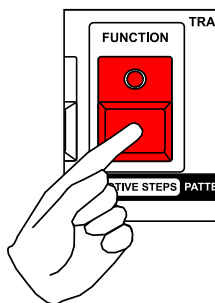

While in SNAPSHOT FUNCTION mode, you can use the control knobs to modify MIDI effects settings for the current selected track. See the section on MIDI effects for details.

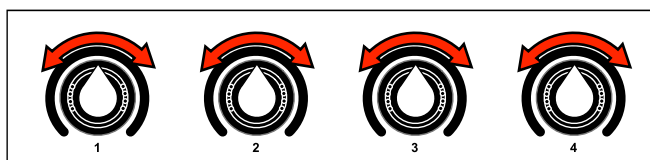

While in SNAPSHOT FUNCTION mode, the eight track select buttons can also be used to change the currently selected track. This is useful to change the destination of the MIDI effects or the transpose/mute functions without leaving SNAPSHOT FUNCTION mode.

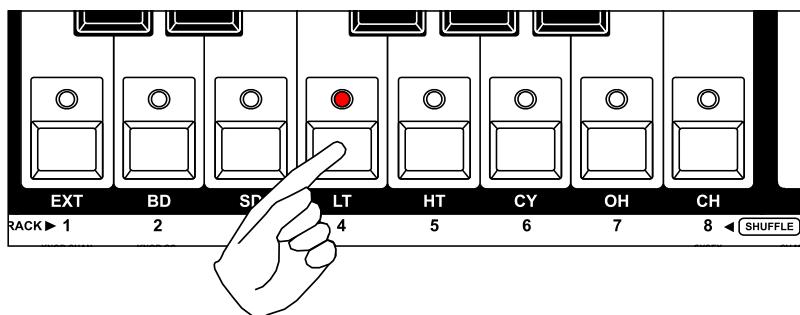

SNAPSHOT UTILITY MODE

There are some additional utility functions that can be accessed with the SNAPSHOT UTILITY mode. This includes configuring the snapshot recall settings for MIDI effects, transpose/mute and MIDI ports/channels.

To enter SNAPSHOT UTILITY mode, while in SNAPSHOT FUNCTION MODE, click the UTILITY button.

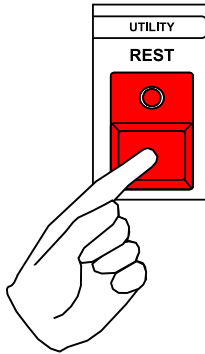

To exit SNAPSHOT UTILITY mode, click the FUNCTION button.

SNAPSHOTS

SNAPSHOT RECALL SETTINGS

Snapshots store the settings for track MIDI effects, MIDI channel/port, pattern transpose/mute, track mute as well as the current sequencer tempo. In some cases you may not wish to recall these settings when selecting a snapshot. This is useful when performing a song and using MIDI effects in realtime, because recalling MIDI effects would introduce jumps in the performance.

To configure which settings are recalled by the snapshot, you can enable or disable the recall of MIDI effects, MIDI channel/port, track mutes and pattern transpose/mute separately.

TRACK MIDI PORT/CHANNEL RECALL

In SNAPSHOT UTILITY mode, the C sharp (BACKWARD) button shows the recall of MIDI channel/port. Click the button to toggle the setting. When the LED is lit, MIDI channel/port for each track will be recalled.

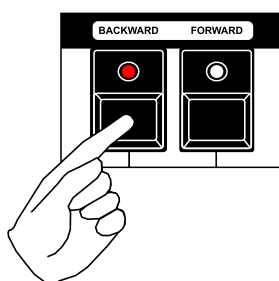

Enabling snapshot recall of track MIDI port/channel settings

TRACK MIDI EFFECTS RECALL

In SNAPSHOT UTILITY mode, the D sharp (FORWARD) button shows the recall of MIDI effects. Click the button to toggle the setting. When the LED is lit, MIDI effects for each track will be recalled with snapshots.

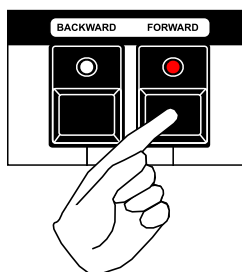

Enabling snapshot recall of track MIDI effects settings

SNAPSHOTS

TRANPOSE INST MUTE RECALL

In SNAPSHOT UTILITY mode, the TRANPOSE button shows the recall of pattern transpose and drum/ctrl mutes. Click the button to toggle the setting. When the LED is lit, transpose or instrument mutes for each track will be recalled with snapshots.

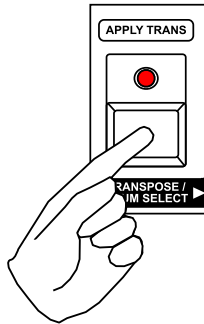

Enabling snapshot recall of transpose and inst mute

TRACK MUTE RECALL

In SNAPSHOT UTILITY mode, the MUTE button shows the recall of track mutes. Click the MUTE button to toggle the setting. When the LED is lit, track mutes will be recalled with snapshots.



Enabling snapshot recall of track mute

SNAPSHOTS

SNAPSHOT TEMPO RECALL

Whenever a new snapshot is created, the current sequencer tempo is stored with the snapshot. This tempo can be recalled with the snapshot to dynamically change the sequencer tempo.

Tempo recall with snapshots is controlled by the TEMPO LOCK function in TIME MODE.

If TEMPO LOCK is engaged, the tempo of the sequencer will change with each snapshot, otherwise the stored tempo is not recalled.

SONGS

Songs are used to automate the playback of snapshots, this allows a performance to be captured and replayed. SONG PLAY mode only allows songs to be played back, no edits can be made in song play mode. To edit or record a song, you can use either song step record or realtime record modes.

PLAYING SONGS

Playback of songs is mostly a “read-only” activity, meaning that you cannot edit song steps or patterns while in song playback. This is useful for live performance when you do not wish to make any accidental changes to an arrangement. With this in mind, song mode can be useful even with a single pattern.

ENTERING SONG PLAY MODE

To enter SONG PLAY mode double-click the SONG button, when SONG mode is active, the LED above the SONG button will blink. To exit SONG mode, double-click the SONG button again.

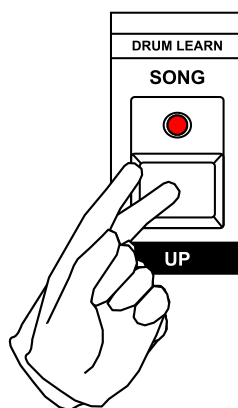

NOTE: SONG MODE is entered and exited using a double-click to avoid entering or leaving SONG MODE accidentally.

You can leave song mode while the sequencer is playing and the current song step will be remembered. This allows you to break out of a song during live performance to create spontaneous changes and then resume the song where it left off.

When stopping the sequencer, the song will automatically reset to song step 1 unless you specifically choose a starting step while the sequencer is stopped.

SELECTING SONGS

There are 32 song locations available. To select a song, press and hold the SONG button, then press one of the 16 pattern select buttons to select a song location. Use the section button to move between the two song banks.

The current selected song is shown with a brightly lit LED.

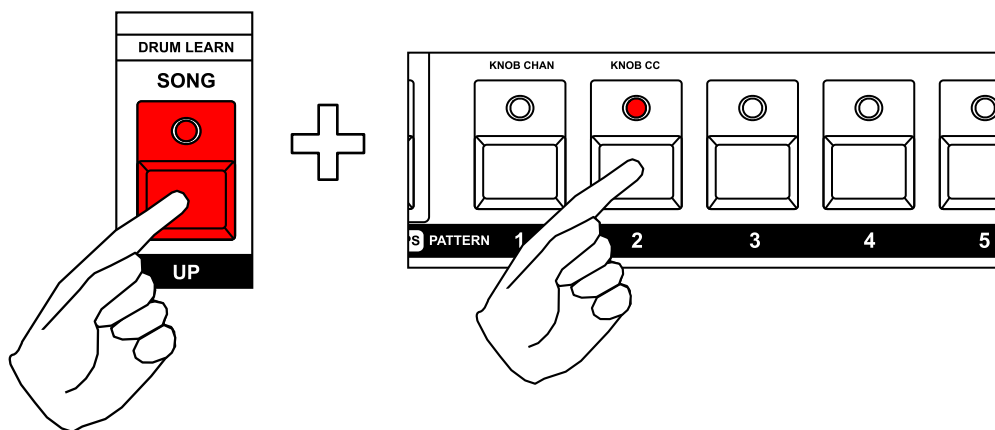

CREATING SONG CHAINS

You can also chain multiple songs to play songs in sequence automatically. To select a song chain, press and hold the pattern step button for the first song in the chain, then click the pattern step button for the last song in the chain. The song chain should light across all selected song locations.

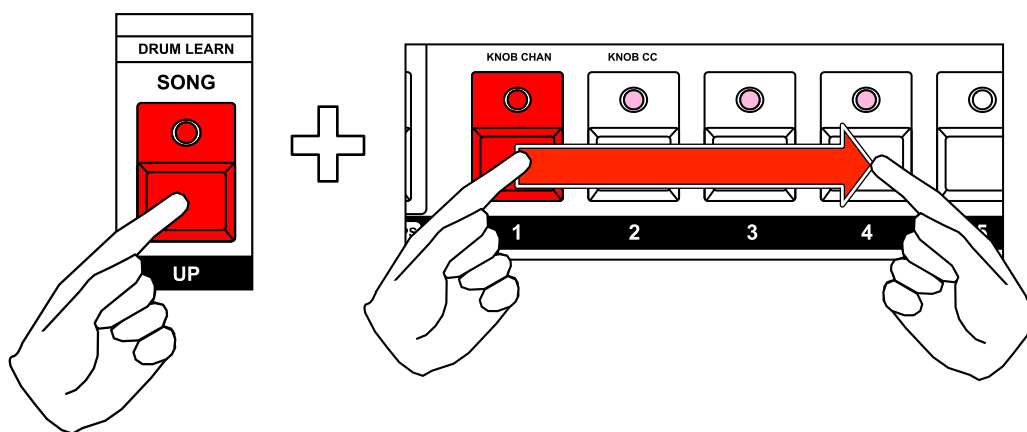

When chaining songs, the currently playing song is shown with a blinking LED.

SNAPSHOTS

SONG LOCATION SHORTCUTS

While holding the SONG button, you can quickly move to either the first or last song step with the BACKWARD or FORWARD buttons.

To move to the first song step, click BACKWARD.

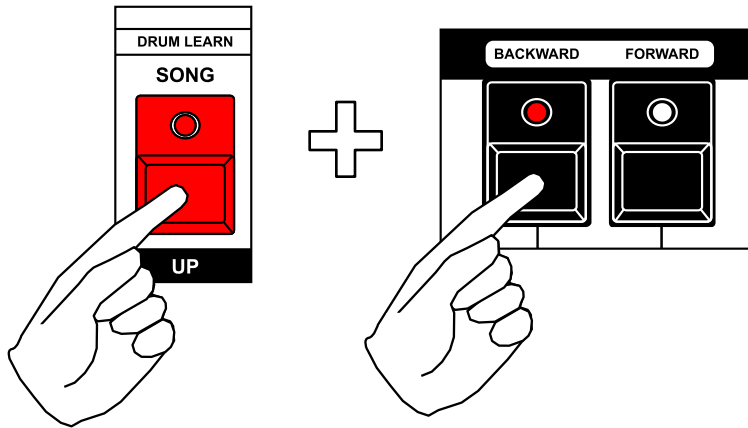

To move to the last song step, click FORWARD.

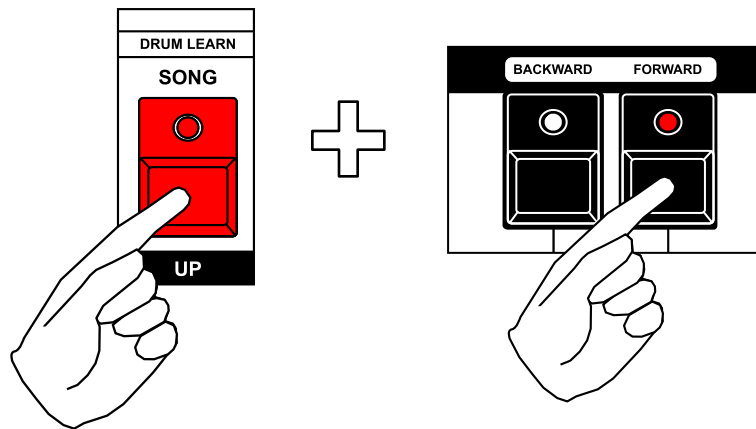

SNAPSHOTS

STARTING FROM A SPECIFIC SONG STEP

When the sequencer is stopped, you can also move to a specific song step using the BACKWARD and FORWARD button. This is useful if you wish to start song playback from a specific step.

To move back one song step, while in SONG PLAY mode, click BACKWARD.

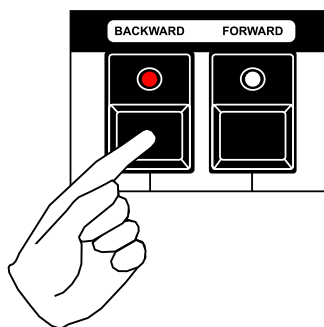

To move forward one song step, click FORWARD.

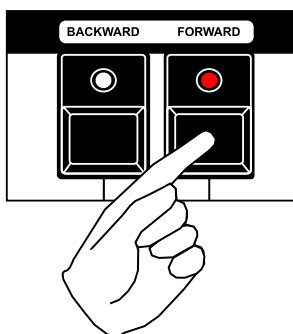

RECORDING SONGS

Songs can be recorded or edited in realtime or using song step record mode. Realtime recording is a great way to capture a live performance, while step recording allows you to make precise edits.

You can also enter and exit song recording at any point during song playback if you wish to edit a song on the fly.

REALTIME SONG RECORD

To enter realtime SONG RECORD mode, while in SONG mode, press the RECORD button.

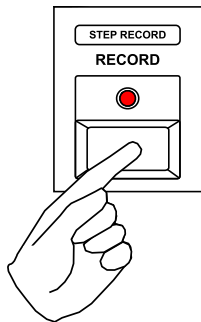

Song recording will begin from the currently selected song step, which is displayed on the LED display. The sequencer must be running to realtime record a song, if it is not running, you can click the RUN/STOP button to start the sequencer.

While in REALTIME SONG RECORD mode, you can select snapshots in realtime. Each repetition of a snapshot is also recorded into the song step repeats.

When selecting a new snapshot, the snapshot recall is quantized to the loop point of the current playing snapshot.

When the snapshot is recalled, the song step is automatically incremented. If a snapshot is looped for more than eight repetitions, a new song step is created automatically with the same snapshot assigned and repetitions continue to be recorded.

To exit REALTIME SONG RECORD, click either the REST (slide) button to set the last step or click the RECORD button. The song will then loop and continue playback from the first step.

SNAPSHOTS

PAUSE RECORD REALTIME SONG

You can also use the PAUSE RECORD feature in realtime song record.

PAUSE RECORD allows a stopped sequencer to be started with the first click of a snapshot button and then commence realtime recording of the song. This is useful when you wish to record a performance precisely from a specific point in a song.

To use PAUSE RECORD, in SONG MODE with the sequencer stopped, hold the RECORD button, then click the RUN/STOP button. The LEDs of both the RECORD and RUN/STOP will blink while the sequencer is paused.

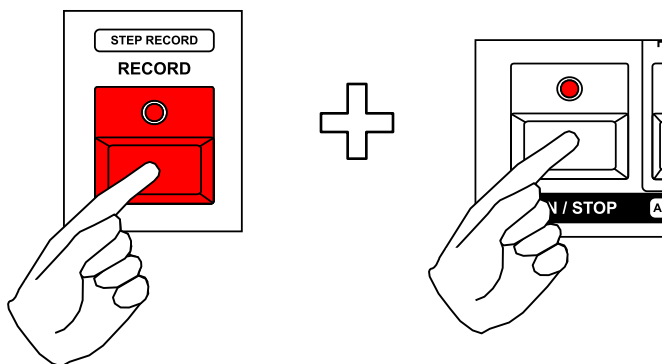

SNAPSHOTS

SONG STEP RECORD

Songs can be manually edited or created in song STEP RECORD mode. While in STEP RECORD mode, the sequencer does not advance through the song during playback, allowing arbitrary edits to be made to a specific song step.

To enter realtime SONG STEP RECORD mode, while in SONG mode, press and hold FUNCTION and then click the RECORD button.

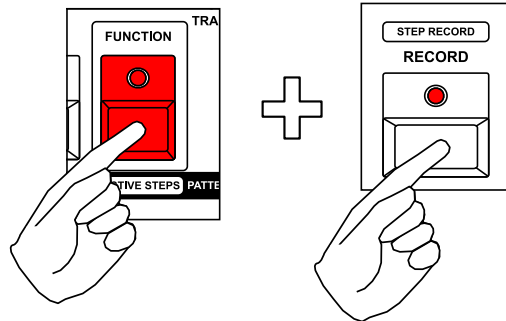

SNAPSHOTS

SELECTING CURRENT SONG STEP

While in STEP RECORD mode, you can move to specific song steps by clicking the BACKWARD (C#) or FORWARD (D#) buttons.

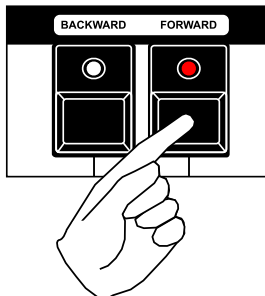

Each song can have a maximum of 64 song steps. The current selected song step will be displayed on the LED display.

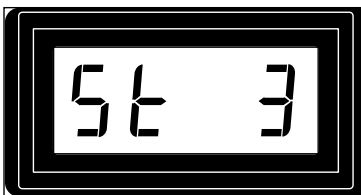

Changing the song step happens immediately, to make programming songs quicker, but this also means that it can introduce abrupt changes as patterns and pattern settings change.

SNAPSHOTS

DELETING CURRENT SONG STEP

While in STEP RECORD mode, you can delete the current song step and shift all subsequent song steps forward.

To delete a song step, first select the song step you wish to remove using the BACKWARD or FORWARD buttons. Once you have navigated to the step to clear, to delete the step, click the CLEAR button.

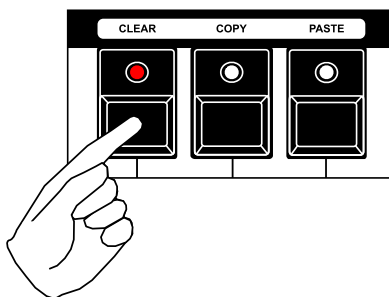

The last step of the song also moves forward when a song step is deleted, making the song shorter.

NOTE: Deleting a SONG STEP cannot be undone!

SNAPSHOTS

INSERTING A SONG STEP

While in STEP RECORD mode, you can insert a copy of the current song step and shift all subsequent song steps backward.

To insert a song step, first select the step in song you wish to insert from, using the BACKWARD or FORWARD buttons. Once you have navigated to the desired step, click the PASTE button to copy and insert a new instance of the step.

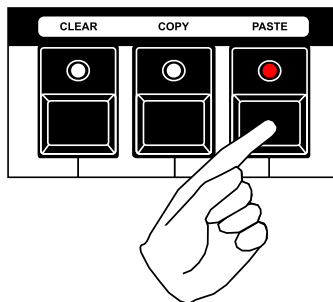

The last step of the song also increases by one step when a song step is inserted, making the song longer (up to the maximum song length of 64 steps).

NOTE: Inserting a SONG STEP cannot be undone! Song step 64 will be shifted out and overwritten each time a steps inserted.

SNAPSHOTS

SETTING SONG STEP REPEATS

While in song STEP RECORD mode, you can set the number of times a song step should repeat before moving to the next song step. A song step can be set to a maximum of eight repetitions.

The current song step repeat is shown on the white buttons of the mini keyboard, with the current number of repeats shown as a series of lit LEDs. When a song is playing, the current repeat location is shown as a blinking LED on the mini keyboard.

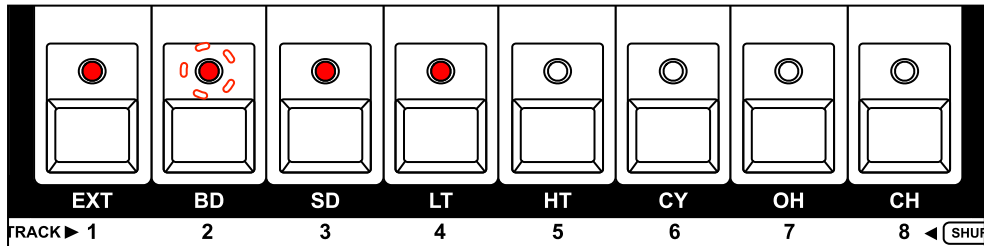

To change the number of song step repeats, click one of the white mini keyboard buttons.

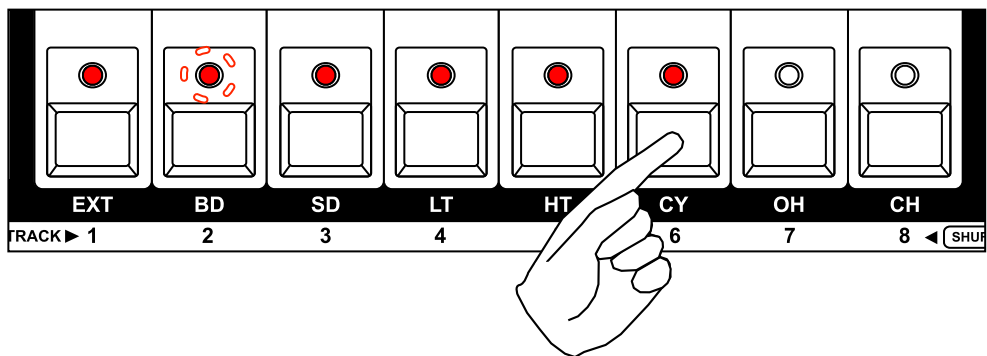

SNAPSHOTS

ASSIGNING SNAPSHOTS TO SONG STEPS

Each song step has an assigned snapshot. You can choose any of the 128 available snapshot locations, including blank snapshots.

The current assigned snapshot is shown with a brightly lit LED on the step buttons, or if the selected snapshot is not in the currently selected bank, the section LED for the bank with the current snapshot is shown with a dimly lit LED.

To assign a snapshot to a song step, while in SONG STEP RECORD mode, click one of the 16 pattern step buttons. You can also switch snapshot banks by clicking the SECTION button.

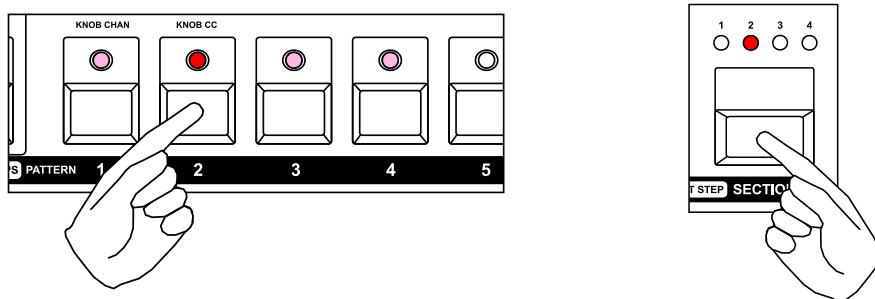

SETTING THE LAST SONG STEP

Any song step can be designated as the last step in the song. When a song reaches the last step it will loop to the beginning of the song or move to the next song in a song chain.

To set a song step as the last step, while in SONG STEP RECORD mode, click the REST button. The REST LED will light to indicate the step is the last song step.

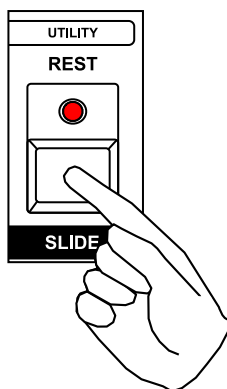

SONG FUNCTIONS

Song functions allow songs to be cleared, copied or pasted.

To enter SONG FUNCTION mode, while in SONG MODE, press and hold (or double-click) the FUNCTION button.



CLEARING A SONG

A song can be cleared to reset all song settings.

The cleared settings are:

Song length	Reset to 1 step
Song step snapshot	Reset to snapshot 1 for all steps
Song step repeats	Reset to 1 repeat for all steps

To clear a song, while in SONG FUNCTION mode, click the CLEAR button (F sharp).

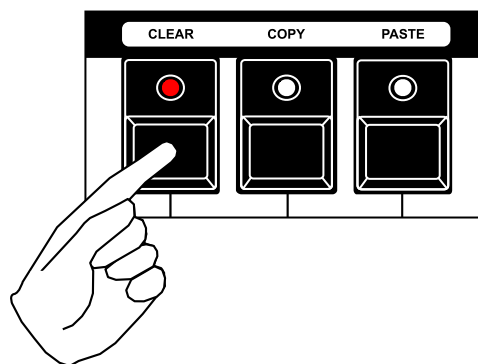

NOTE: The contents of the current selected song will be cleared, this action cannot be undone.

SNAPSHOTS

COPYING A SONG

To copy the current selected song to the clipboard, while in SONG FUNCTION mode, click the COPY (G sharp) button.

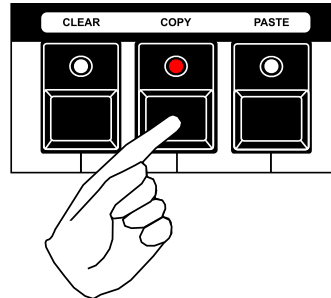

PASTING A SONG

To paste the contents of the song clipboard into the currently selected song, while in SONG FUNCTION mode, click the PASTE (A sharp) button.

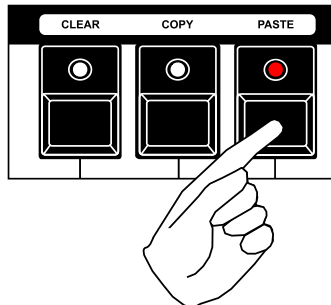

NOTE: The contents of the current selected song will be overwritten, this action cannot be undone.

GLOBAL CONFIG

Global CONFIG mode is where changes that effect the whole machine are made, this includes global control knob settings, CV, synchronization and MIDI settings.

To enter CONFIG mode, press and hold the FUNCTION button, then click the MUTE button. While in CONFIG mode, the mute and function LEDs will blink.

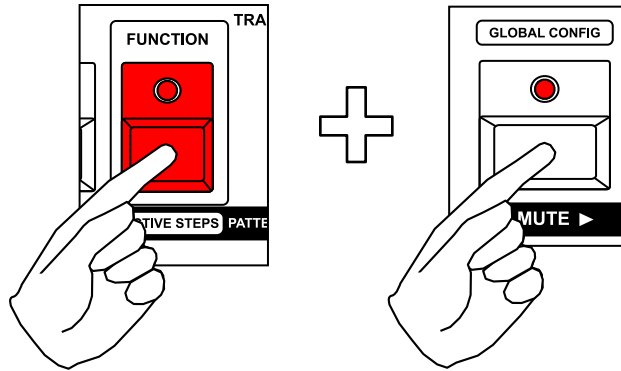

To exit CONFIG mode, click either the MUTE or FUNCTION button.

SETTING GLOBAL KNOB CHANNELS

The MIDI channel and port for each control knob can be set separately. This allows each control knob to be used to control a different device if needed.

The MIDI channel for each control knob can also be set to "track" which will change the MIDI channel and MIDI controller number according to the currently selected track.

To set the MIDI channel for a control knob, while in CONFIG mode, press and hold pattern step button 1, then turn the control knob you wish to set.

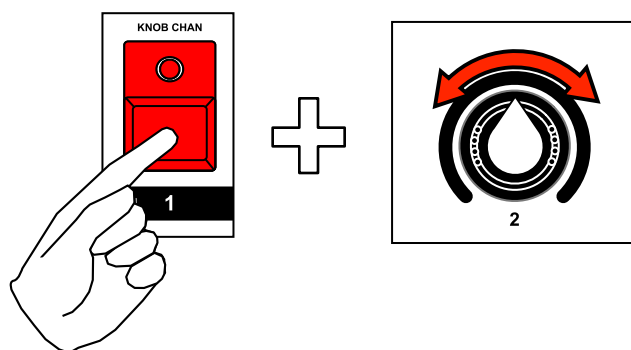

The channel of the knob will be displayed on the LED display. You can set the channel from the range 1 to 16 for any of the three output ports (port 1, port 2 or USB) or "tr". To have the knob channel and controller change according to the selected track, rotate the knob all the way clockwise until the LED display shows "tr".

If you just want to view the current channel assigned to a knob without changing it, while holding pattern step button 1, press and hold the track select button corresponding to the controller knob that you wish to view.

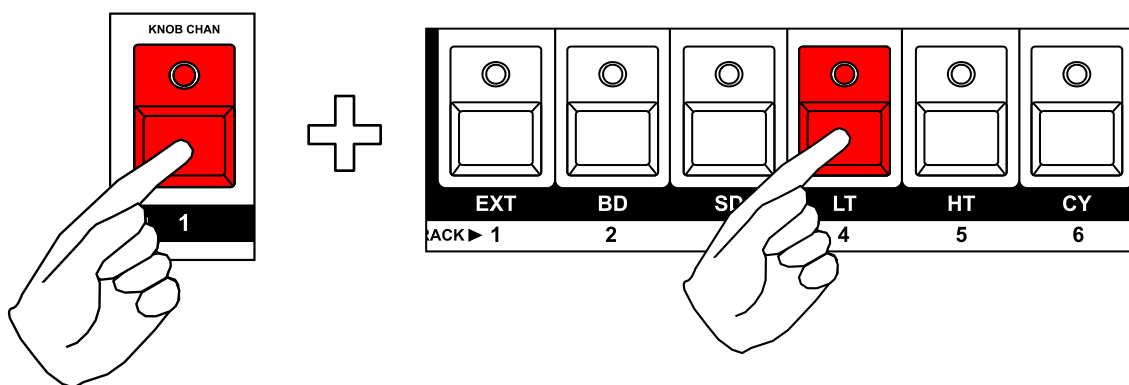

SETTING GLOBAL KNOB CONTROLLER NUMBERS

The MIDI controller number for each control knob can be set separately. This allows each control knob to be used to control a different parameter of a device if needed.

To set the MIDI controller number for a control knob, while in CONFIG mode, press and hold pattern step button 2, then turn the control knob you wish to set. The controller number of the knob will be displayed on the LED display. You can set the controller number from the range 0 to 127.

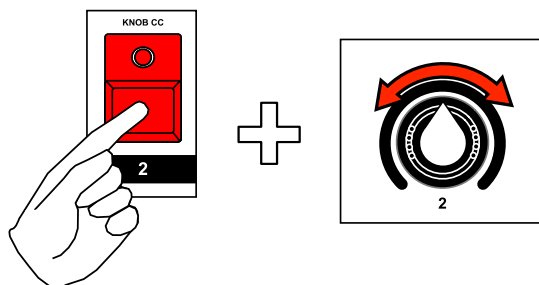

If you just want to view the current controller assigned to a knob without changing it, while holding pattern step button 2, press and hold the track select button corresponding to the controller knob that you wish to view.

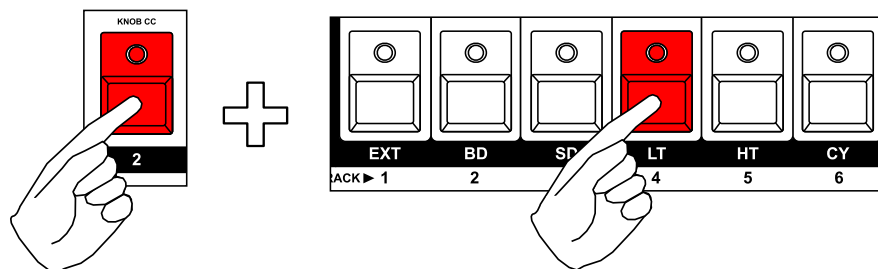

NOTE: If the global knob channel is set to "TR", the knob is configured to use track level settings and the global controller is not used. In this case the controller setting will show "---" and cannot be changed.

For more details on setting the track specific controllers, please see the section on TRACK UTILITY mode.

DUMP MACHINE STATE

The internal data for the entire machine, including PATTERNS, TRACKS, SNAPSHOTS and CONFIG can be dumped via MIDI system exclusive messages for backup, transfer and storage.

NOTE: The USB MIDI setting in GLOBAL CONFIG MODE controls whether MIDI system exclusive is sent via USB MIDI or DIN MIDI outputs. By default, USB MIDI is selected, which transfers system exclusive at much greater speed.

To dump the entire machine, while in GLOBAL CONFIG MODE, click the SYSEX (pattern step 8) button. The machine state will be sent immediately.

To receive a machine state dump, your SYSEX receiver should be listening for multiple sysex messages.

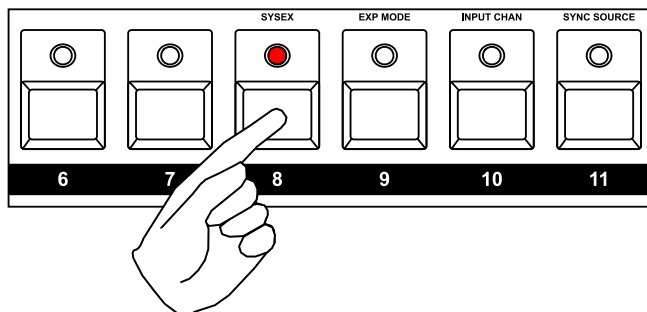





To reload a system exclusive dump into ENGINE, replay the MIDI file into Engine. Engine does not need to be in a special mode. All data will be overwritten immediately, but if the sequencer is playing, new patterns will not start until the current patterns loop.

TIP: If you are in GLOBAL CONFIG mode when receiving a system exclusive dump, the LED display will briefly show when a dump is successfully completed.

CV EXPANSION MODE

There are several modes available for the optional CV expansion board. These can be changed as needed after the CV expansion board has been installed and enabled.

The available modes are:

OFF		CV/Gate is not used
8 tracks		Each track has a dedicated pair of CV/Gate outputs (default)
4 tracks		Four tracks will each use two CV/Gate output pairs for expanded control
1 track		One track will use all 8 output pairs.
controls and clocks		The six control knobs and tempo knob will be output as continuous control voltages along with various clock signals from the CV/Gate outputs.

To set the CV mode, while in CONFIG mode, press and hold the EXP MODE (step 9) button. Rotate control knob 1 to change the current CV mode.

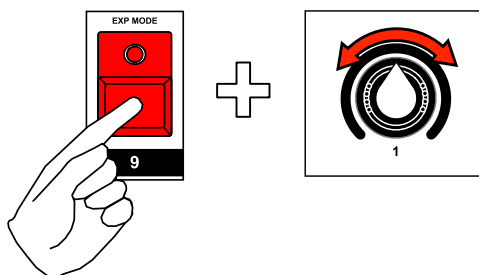

The current CV mode will be displayed on the LED display.



Changing the CV mode takes effect immediately.

GLOBAL CONFIG

CV MODE: 8 TRACKS

In "8 tracks" mode, each of the eight tracks has a dedicated CV/Gate output pair.

For SYNTH type patterns, the outputs produce CV and Gate signals that correspond to the programmed pattern using pitch 1 for each step.

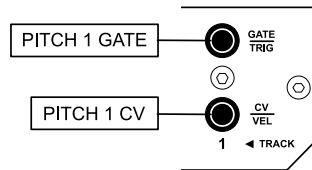

SYNTH TYPE PATTERN
ON TRACK 1

For DRUM type patterns, the output is tied to the EXT drum instrument. The outputs produce a trigger from the GATE/TRIG output and an accent trigger from the CV/VEL output.

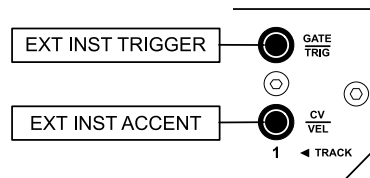

DRUM TYPE PATTERN
ON TRACK 1

For CONTROL type patterns, the output is tied to the control value 1. The outputs produce a trigger from the GATE/TRIG output and a control voltage from the CV/VEL output.

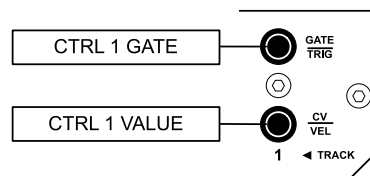

CTRL TYPE PATTERN
ON TRACK 1

GLOBAL CONFIG

CV MODE: 4 TRACKS

In "4 tracks" mode, you can choose four tracks to share the outputs. Each selected track will have two output pairs.

To select the four assigned tracks, when setting CV MODE to "4 tr", click the track select buttons to turn on/off four tracks.

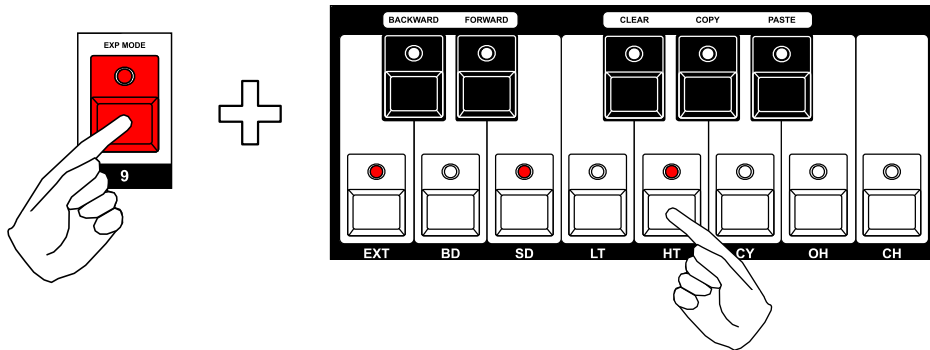

For SYNTH type patterns, the outputs produce CV and Gate signals on one output pair. The second output pair generates an accent trigger on GATE/TRIG and a variable velocity voltage on CV/VEL.

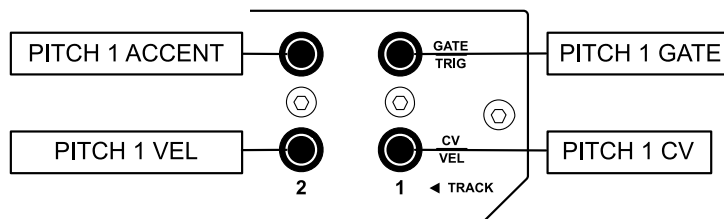

SYNTH TYPE PATTERN
ON TRACK 1

GLOBAL CONFIG

For DRUM type patterns, the outputs are tied to the EXT and BD drum instruments. The outputs produce triggers from the GATE/TRIG outputs and accent triggers from the CV/VEL outputs.

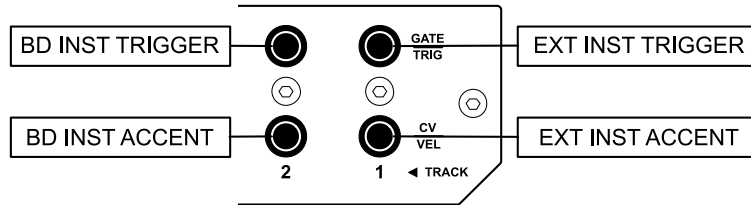

DRUM TYPE PATTERN
ON TRACK 1

For CONTROL type patterns, the outputs are tied to control values 1 and 2. The outputs produce gate signals from the GATE/TRIG outputs and control voltages from the CV/VEL outputs.

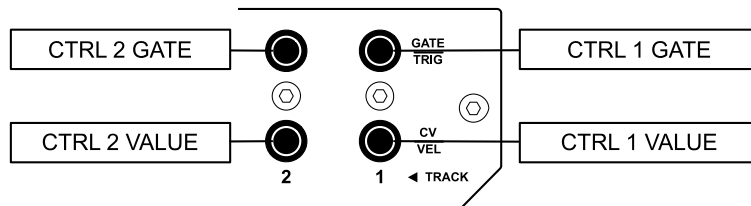

CTRL TYPE PATTERN
ON TRACK 1

GLOBAL CONFIG

CV MODE: 1 TRACK

In "1 track" mode, all of the output pairs are dedicated to a single track.

To select the assigned track, when setting CV MODE to "1 tr", click the track select buttons.

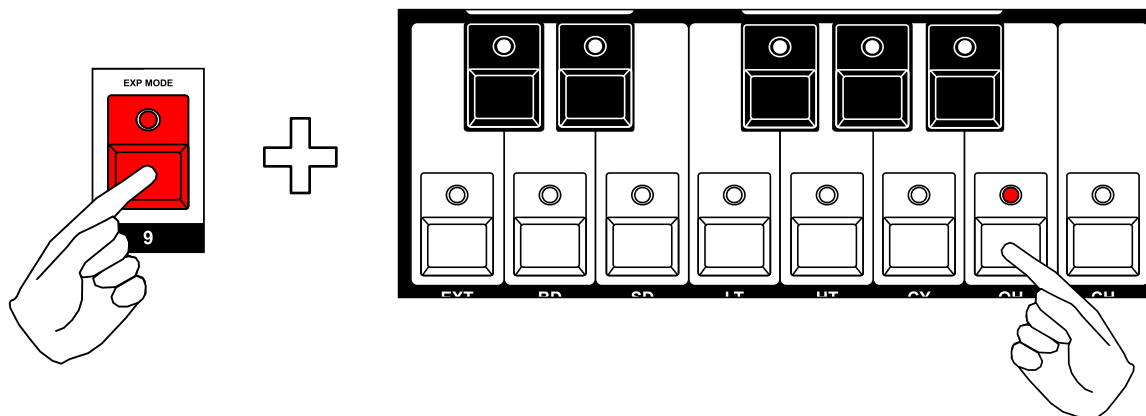

For SYNTH1 type patterns, CV/Gate output pair 7 produces CV and Gate signals, output pair 8 produces accent and velocity signals. CV outputs 1 through 6 output CV signals that correspond to the six control knobs and Gates 1 through 3 output clock signals at various divisions.

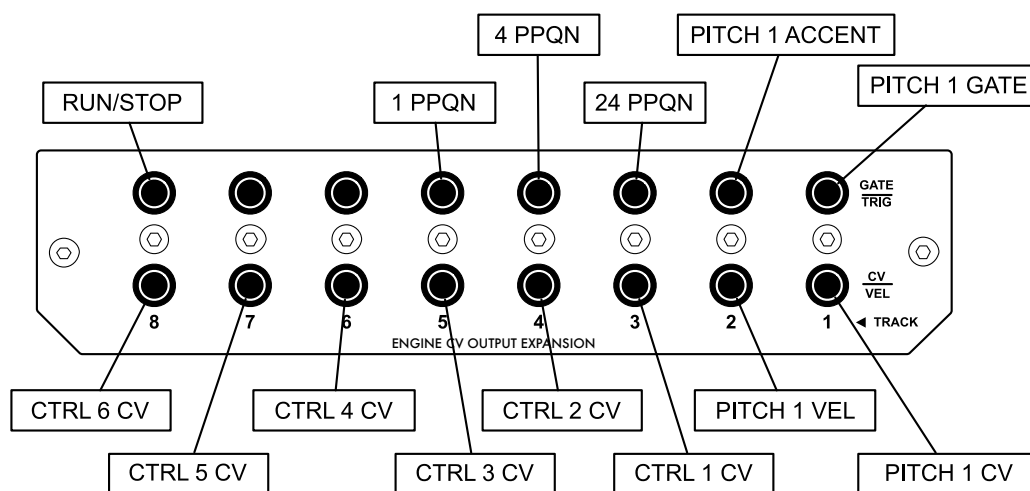

SYNTH1 TYPE PATTERN

GLOBAL CONFIG

For SYNTH2 type patterns, CV/Gate output pair 1 produces CV and Gate signals for pitch 1, output pair 2 produces accent and velocity signals for pitch 1. CV/Gate output pair 3 produces CV and Gate signals for pitch 2, output pair 4 produces accent and velocity signals for pitch 2, and so forth for the pitches 3 and 4.

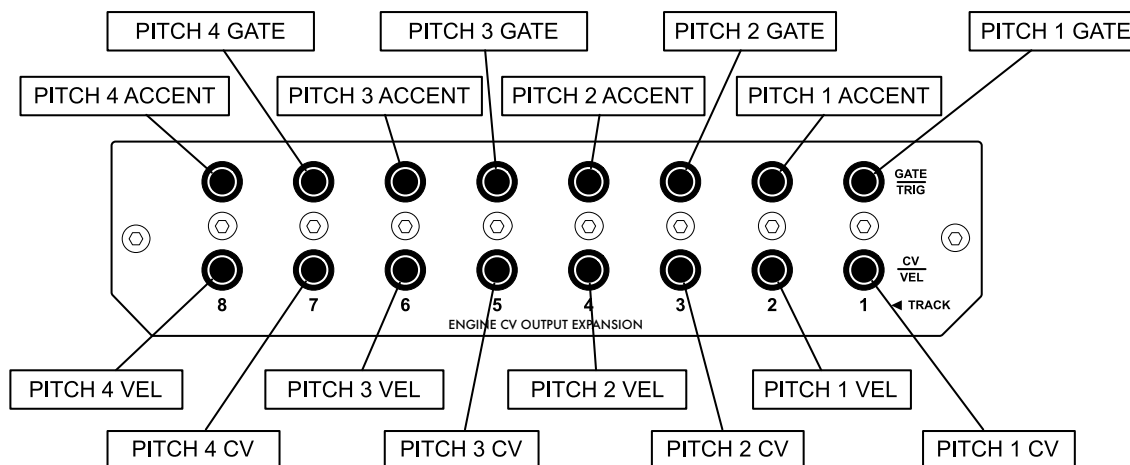

SYNTH2 TYPE PATTERN

For DRUM type patterns, each of the eight group 1 drum instruments have a dedicated CV/Gate output pair. The outputs produce triggers from the GATE/TRIG outputs and accent triggers from the CV/VEL outputs.

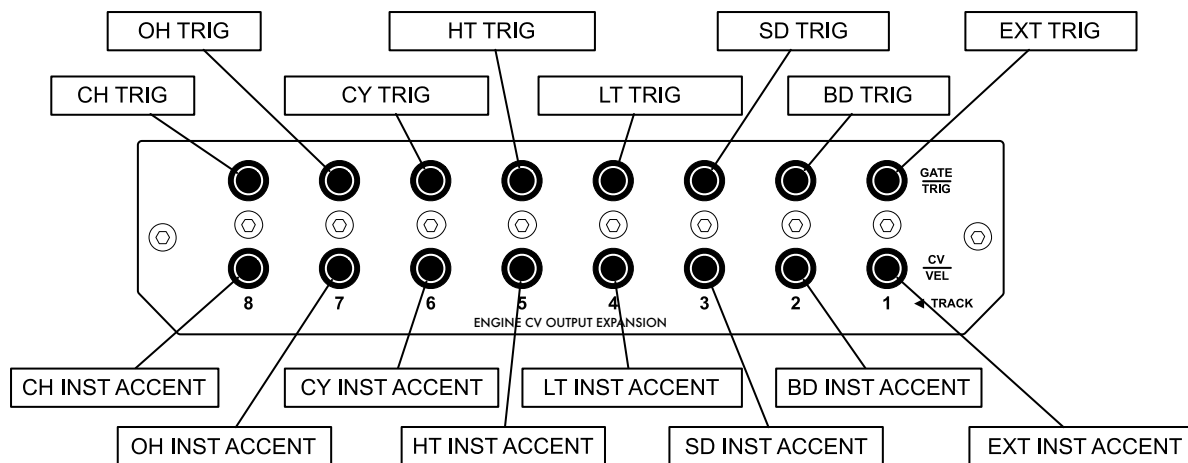

DRUM TYPE PATTERN

For CONTROL type patterns, CV/Gate outputs 1 through 6 output CV and Gate signals that correspond to the six controls. CV output 7 produces a voltage that corresponds to the TEMPO knob location.

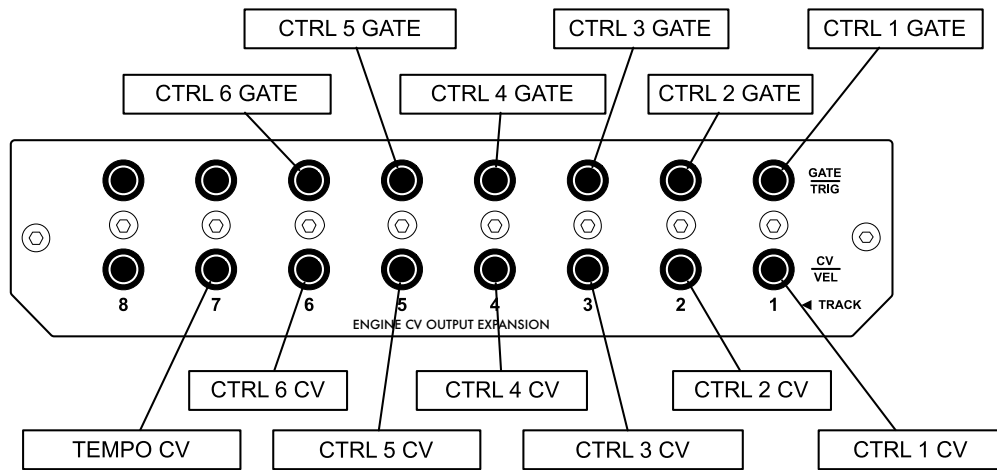

CTRL TYPE PATTERN

CV MODE: 6 CONTROLS AND CLOCKS

In "6 controls" mode, all of the output pairs are used to output either a CV voltage controlled by the control knobs or various clock divisions for synchronizing other devices.

The first seven CV outputs will generate a voltage that corresponds to the controller knob locations and the TEMPO knob location.

The eighth CV output generates a 5V pulse that is compatible with Volca sync signals.

The eight GATE outputs generate various clock signals.

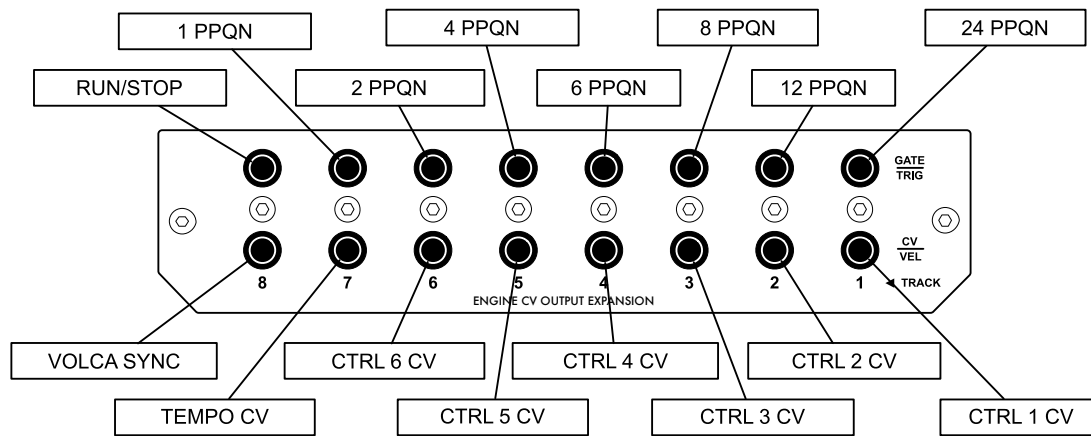



CONTROLS AND CLOCKS

GLOBAL CONFIG

When using "6 controls" mode, you can configure whether clock signals are sent while the sequencer is stopped.

The two available settings are:

CLOCK OFF		Clock messages will not be sent from the GATE outputs when the sequencer is stopped.
CLOCK ON		Clock messages will always be sent from the GATE outputs even when the sequencer is stopped.

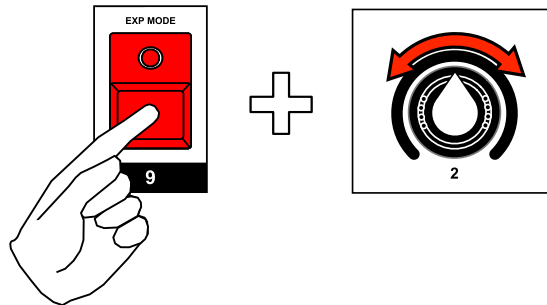

To configure clock transmission while holding the EXP MODE (step 9) button, rotate control knob 2.



SETTING INPUT MIDI CHANNEL

The MIDI input channel used for realtime recording from a MIDI controller can be changed to several different modes. This flexibility allows you to control how Engine responds to incoming MIDI without changing settings on your external controller.

The three available settings are:

SPECIFIC CHANNEL		MIDI channel 1 to 16 - static setting for the incoming MIDI channel to use
OMNI		Use MIDI messages coming in from any channel
TRACK		Dynamically changes the MIDI input channel according to the MIDI channel for the current selected track. Useful when connected to multiple controllers

To change the MIDI input setting, while in CONFIG mode, press and hold the INPUT CHAN (step 10) button. Rotate control knob 1 to change the MIDI input channel.

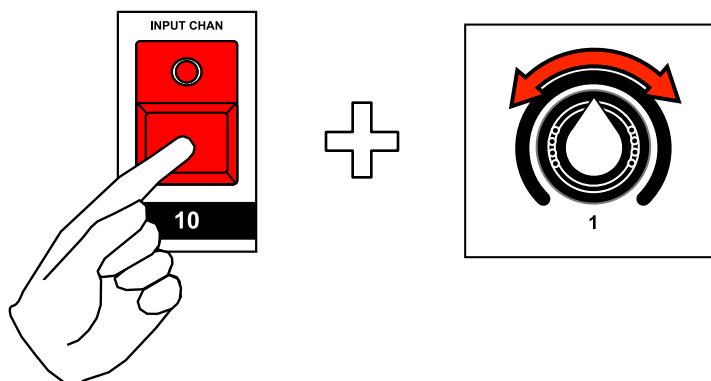

The current MIDI input setting will be shown on the LED display while holding the INPUT CHAN button.





ENABLING MIDI THRU

The MIDI input can be echoed to the MIDI outputs. The input data is merged with any MIDI data generated by the sequencer.

NOTE: Only MIDI system exclusive messages smaller than 600 bytes can be passed thru Engine. If you need to dump large SYSEX messages (upgrades, patches) connect directly from MIDI source to destination, without using Engine MIDI thru.

If MIDI SYNC output from the sequencer is enabled, then incoming MIDI clock will not be echoed.

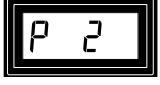
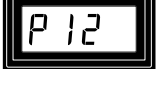
The four available settings are:

OFF		(default) MIDI input is not echoed to any outputs
PORT1		MIDI input is echoed directly to MIDI OUTPUT 1 only.
PORT2		MIDI input is echoed directly to MIDI OUTPUT 2 only.
PORT2 & PORT1		MIDI input is echoed directly to both MIDI OUTPUT 1 and MIDI OUTPUT 2.
TRACK		MIDI input is routed through the selected channel and rechannelized. Output is also processed by the CV output board according to the current CV mode.

To change the MIDI thru setting, while in CONFIG mode, press and hold the INPUT CHAN (step 10) button. Rotate control knob 2 or click BACKWARD/FORWARD to change the MIDI thru.

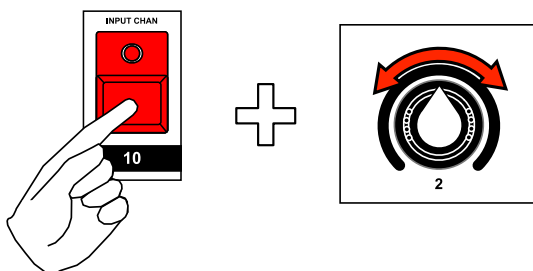

GLOBAL CONFIG

The current MIDI thru setting will be shown on the LED display.



MIDI input will be echoed to ports 1 and 2

ENABLING MIDI PROGRAM CHANGE RECEIVE

The reception of MIDI program change messages to change selected patterns can be enabled or disabled.

To change the reception of MIDI program change messages, while in CONFIG mode, press and hold the INPUT CHAN (step 10) button. Rotate control knob 3 or click BACKWARD/FORWARD.

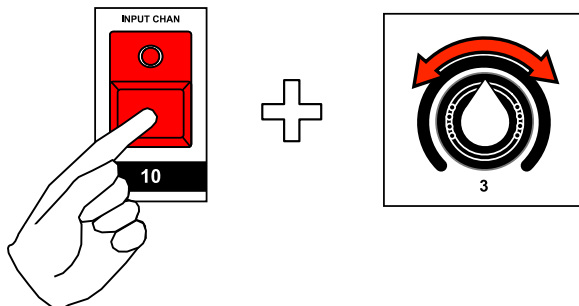

The current setting will be shown on the LED display.



MIDI program change will be received

SYNC SOURCE

Engine can be set to synchronize to different clocks. This includes MIDI clock (default), DIN Sync (24 or 48) or the internal clock.

When Engine is set to either MIDI or Internal clock, the DIN Sync port will send DIN sync at the configured clock rate.

If Engine is set to sync to DIN Sync, the DIN Sync port dynamically switches to become an input port.

SPECIFYING THE SYNC SOURCE

To change the sync source, while in CONFIG mode, press and hold SYNC SOURCE (step 11) button, then rotate control knob one or click BACKWARD/FORWARD to select the desired source.

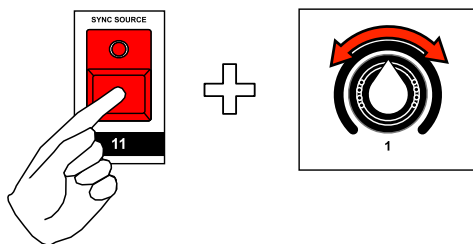

The current sync source will be shown on the LED display while holding the SYNC SOURCE button.



TIP: When syncing to an external clock, you can still start the internal clock. This allows the sequencer to continue running even if the external clock is stopped. When the master clock sends a new start, playback will automatically realign with the master clock and continue. This is useful during live performance when a master may need to be stopped to make changes, while Engine continues playback.

NOTE: When syncing to external clock, if clock messages stop arriving without a MIDI Stop, the sequencer will fall back to internal clock after two seconds.

SPECIFYING THE DIN RATE

Engine supports both DIN24 and DIN48 clock rates. To change the DIN clock rate, while in CONFIG mode, press and hold SYNC SOURCE (step 11) button, then rotate control knob two.

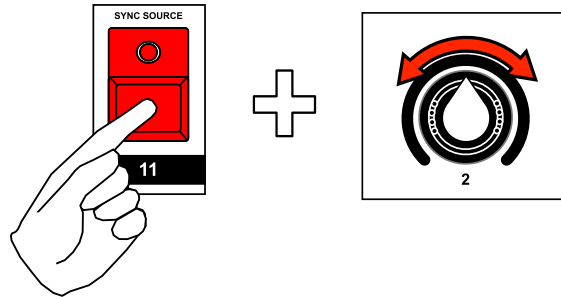

The current DIN clock rate will be shown on the LED display while holding the SYNC SOURCE button.

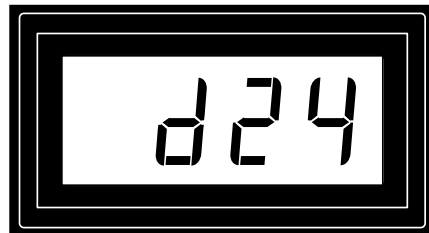

DIN clock at 24 ppqn

DIN CONTINUE

Although not officially part of the standard DIN sync spec, Engine supports DIN continue.

DIN continue is achieved by keeping the DIN run signal high and stopping transmission of DIN clocks when stopping the sequencer. Clocks are resumed when continuing the sequencer. If not continuing the sequencer (starting from the top) the DIN run line is momentarily dropped before sending DIN clocks.

This feature may work with some slave machines better than others. Specifically, some DIN sync devices may stop “responding” when an active clock is not present, meaning that the slave machine LEDs may stop blinking and buttons may not respond while it is “waiting” for a clock signal.

When DIN continue is disabled, the slave machine will always start from the top, even when continuing, which would cause the machines to be out of sync.

To turn on/off DIN continue, while in CONFIG mode, press and hold SYNC SOURCE (step 11) button, then rotate control knob three.

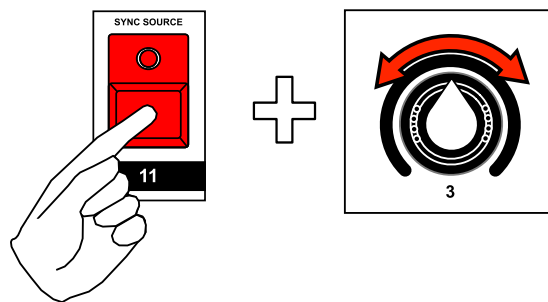

The current DIN continue state will be shown on the LED display while holding the SYNC SOURCE button.

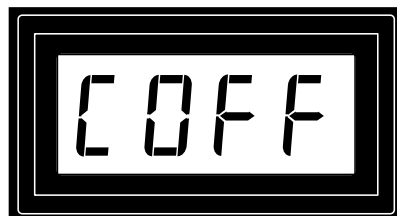

DIN continue turned off

SENDING MIDI CLOCK

You can determine whether Engine should send MIDI clock messages to the MIDI output ports. This is useful to eliminate MIDI message activity if no other devices will be synchronized to the Engine clock or if you would like to dedicate one of the three MIDI output ports as a clock output.

If MIDI clock send is enabled, Engine will send continuous MIDI clock messages even when the sequencer is stopped. MIDI Start and Stop messages will be sent when the sequencer is started or stopped.

MIDI sync will also be transmitted when Engine is synchronized to an external clock, meaning that Engine can be used as a DIN Sync to MIDI clock converter.

To change the sync output setting, while in CONFIG mode, press and hold the MIDI SYNC OUT (step 12) button, then rotate control knob one or click BACKWARD/FORWARD to select the desired outputs. You can select from OFF, MIDI OUTPUT 1, MIDI OUTPUT 2, USB MIDI or any combination of the three MIDI OUTPUTS.

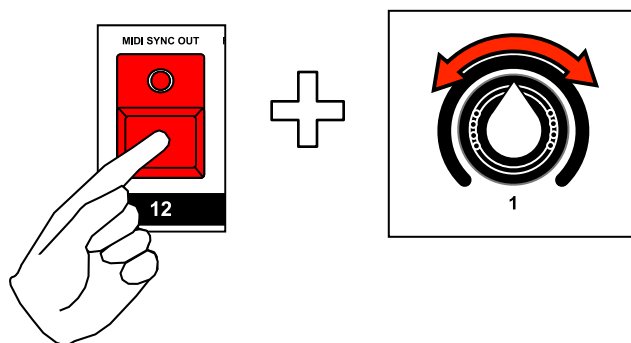

The current MIDI clock output setting will be shown on the LED display while holding the SYNC OUT button.



FORMAT ALL PATTERNS

Sometimes it may be necessary to erase all pattern data to start on a new project. It is possible to format all patterns while leaving TRACK, SONG, SNAPSHOT and CONFIG data intact.

The pattern type for each pattern will be maintained.

To format all patterns, while in GLOBAL CONFIG MODE, press and hold FORMAT PATTERNS (pattern step 13), then click the SECTION button to confirm the operation.

WARNING: This operation cannot be undone!

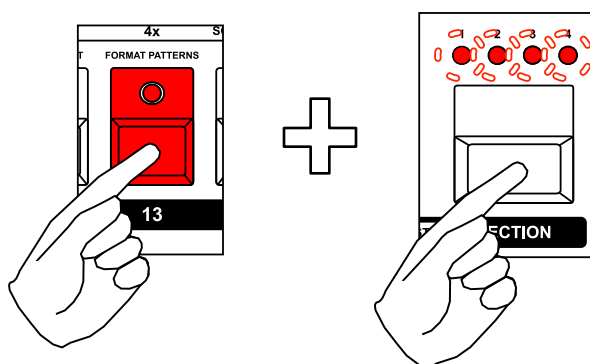

NOTE: To erase all memory, including TRACKS, SNAPSHOTS, SONGS and CONFIG, use the FACTORY RESET or MACHINE WIPE functions.

USB MIDI

Engine can send and receive MIDI from USB MIDI or standard MIDI simultaneously. There is no need to enable or disable USB MIDI for standard MIDI communication.

When receiving clock from an external source, the MIDI input will dynamically lock to the first port (USB or DIN MIDI) where clock is received. This prevents clock signals from becoming corrupted when received at both MIDI inputs simultaneously.

NOTE: Engine is a USB “device”, which means that it must be connected to a USB “host”, such as a computer, tablet or dedicated MIDI host converter box. You cannot plug another USB “device”, such as a MIDI controller keyboard, directly into the USB device port on Engine.

The USB MIDI setting controls which type of MIDI output will be used to transmit MIDI system exclusive messages. This is done to prevent system exclusive messages from clogging the standard MIDI outputs, which could negatively effect playback and synchronization. USB MIDI can handle system exclusive messages much quicker than standard MIDI.

To use USB MIDI for system exclusive transmissions, while in CONFIG MODE, click the USB MIDI (step 14) button.

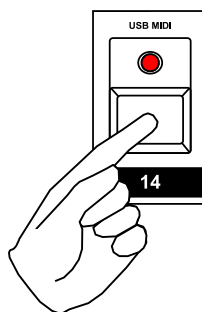

The current state of USB MIDI sysex transmission is shown by the USB MIDI LED, brightly lit means USB MIDI is used for system exclusive messages, unlit means standard MIDI is used for system exclusive messages.

DIMMING LEDS

The LED brightness for all LEDs can be adjusted as needed. This is particularly useful when moving between bright outdoor and dark indoor environments. Additionally, the difference between "bright" and "dim" can be adjusted separately. This allows you to customize how bright the dim LEDs are according to your own preference.

To adjust the LED brightness, in CONFIG mode, press and hold pattern step button 15. All of the various LEDs will light to show the current brightness. Half of the pattern steps will light at full brightness, while the other half light dimly.

To adjust the brightness of all LEDs, rotate control knob 1. The current LED brightness level will be shown on the LED display.

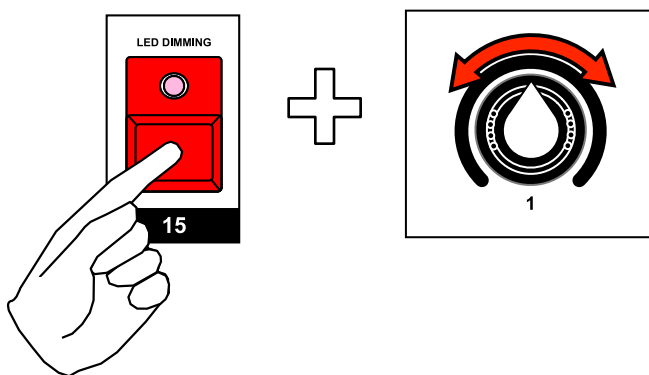

To adjust the relative dim LED level separately, rotate control knob 2.

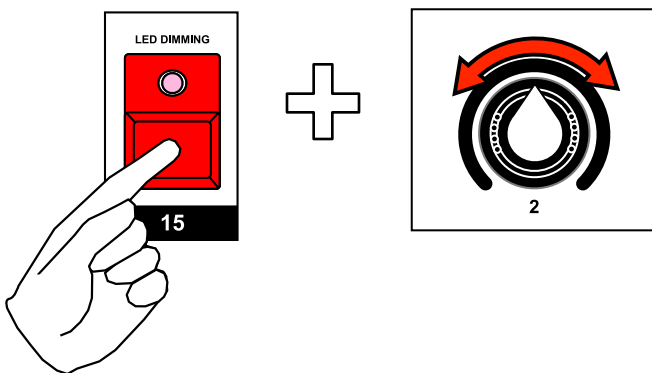

CHECKING OS VERSION

To check the current version of the Engine firmware, while in CONFIG mode, press and hold pattern step button 16. The current version number will be displayed on the LED display.

Periodically, new versions of the Engine firmware will be released to add new features and fix bugs. If the version displayed is less than the current version, it is recommended to update to the latest version.

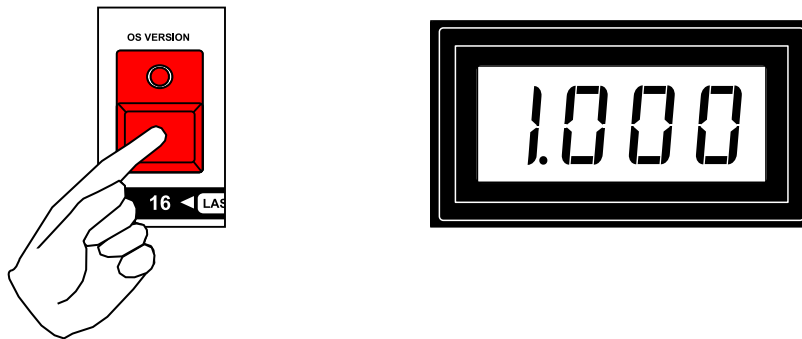

Minor revisions of the OS also include a sub version identifier, this can be displayed by holding the SECTION button while displaying the OS VERSION.

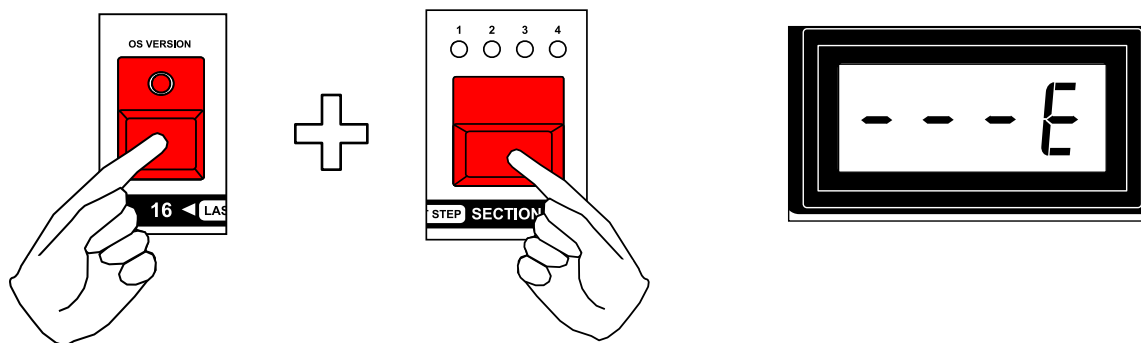

MASTER TRACK

Normally, Engine will automatically calculate when to advance snapshots and song steps based on the looping of the longest currently playing pattern across the eight tracks. This method is good for many cases, but in some cases you may wish to designate which track controls the loop point. For example, if you are using many short patterns that are less than 16 steps, unused patterns would control the loop point because they would be a default 16 steps long.

The MASTER TRACK setting allows you to do define which track is used to advance snapshots or song steps regardless of how long any other patterns in other tracks may be.

To set the MASTER TRACK, in CONFIG mode, click and hold the SNAPSHOT button. The current MASTER TRACK setting will be shown on the LED display. To change the setting, rotate control knob 1 or click the BACKWARD/FORWARD buttons.

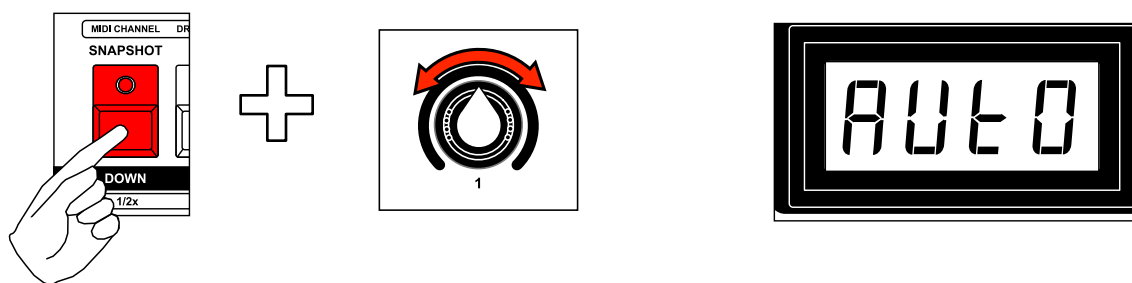

You can select the master track to be any of the eight tracks, or set it to “auto” mode which will dynamically choose the loop point based on the longest pattern in any of the eight tracks.

MIDI OUTPUT OVERLOAD

While it usually will not be a problem, it is possible for Engine to generate enough MIDI messages to overload the DIN MIDI output ports under certain circumstances. For example, this might happen if many tracks trigger all 16 drum instruments on the same step and use the same MIDI output port at high tempo (not something that would happen under normal usage!) This is a limitation of the serial MIDI protocol.

When this situation occurs, Engine will begin skipping messages in order to maintain internal timing.

To indicate that a MIDI overload is occurring, in GLOBAL CONFIG mode, the LED display will use the two leftmost decimal points to indicate which of the two MIDI outputs is overloading.

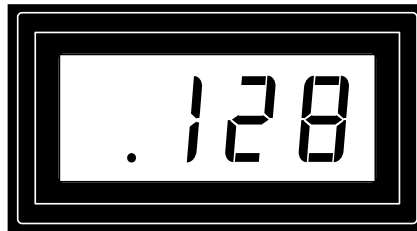

MIDI output 1 overloading

To alleviate the overload condition, you could reduce the number of MIDI messages being sent, distribute the messages across multiple output ports, or switch to USB MIDI which can handle much more load.

SUPPORT FOR ELEKTRON TURBOMIDI

Engine supports the TurboMIDI standard developed by Elektron Music Machines AB. When used with other devices that support TurboMIDI, Engine can negotiate speeds up to 10x MIDI on MIDI output 1.

To use TurboMIDI, connect the MIDI input and MIDI output 1 from Engine to the MIDI output and input of the other device. On the other device, initiate a TurboMIDI negotiation. This will vary depending on the other device, for example, on the Elektron TM-1 MIDI interface, press the "TURBO" button.

After successful negotiation, Engine will use TurboMIDI speed for all communications on MIDI input and MIDI output 1.

You can see the current status of TurboMIDI in CONFIG mode, by checking the TIME LED.

To force TurboMIDI to disable, you can click the TIME button while in CONFIG mode. TurboMIDI will also be disabled when rebooting Engine.

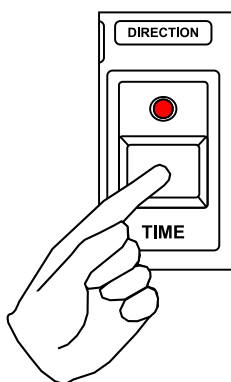

NOTE: TurboMIDI requires that MIDI input and output of both devices be connected. TurboMIDI is only supported on Engine MIDI output 1. MIDI output 2 will continue to operate at normal MIDI speed. TurboMIDI is disabled when USB MIDI is active.

UPDATING FIRMWARE

Occasionally the Engine operating system may need to be updated for bugfixes or new features. This can be done using the USB connection on the back of the machine.

There is a video of the update process available from the Social Entropy website.

It is recommended to back up your machine using MIDI system exclusive dump before performing the upgrade!

NOTE: There is a USB "limitation" with Windows PCs prior to Windows 10 that may cause the update to fail on the first attempt. Engine will appear bricked in this case, but don't freak out! Engine can be reset to force an update to proceed. Please see the video describing how to recover from a bad update: https://youtu.be/XtdymDkLp_c

Start by downloading the new OS file and the update utility from the Social Entropy website. (<http://www.socialentropy.com/engine>).

You will need the update utility to get the new operating system onto the machine.

From the update utility, choose the new OS hex file to upload to Engine.

Now, set the update utility to automatic mode by pressing the AUTO mode button in the update utility.

After installing the update utility and loading the OS hex file, you will need to connect Engine to your PC using the included USB cable.

With the Engine connected to your PC, you will now boot in update mode. To do this, press and hold both the SECTION button and the RECORD button while turning on the machine.

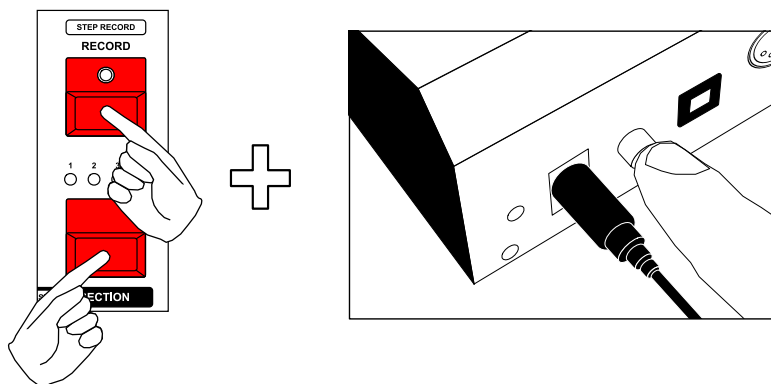

You should see the update utility recognize Engine and begin uploading the new operating system automatically, you can release the SECTION and RECORD buttons now.

After the new operating system is loaded, Engine will reboot itself running the new OS.

You can check the OS version in CONFIG mode by pressing the pattern step 16 button.

That completes the upgrade process.

MACHINE WIPE

It is possible to clear all patterns, songs and snapshots without changing other machine settings. This is useful when starting a new project that will use the same configuration for things like track MIDI settings, sync configuration, etc.

To wipe the machine, press and hold step 13 (FORMAT PATTERNS) while powering on the machine. The LED display will show "clr" and the SECTION LEDs will blink. Click the SECTION button to confirm and execute the wipe

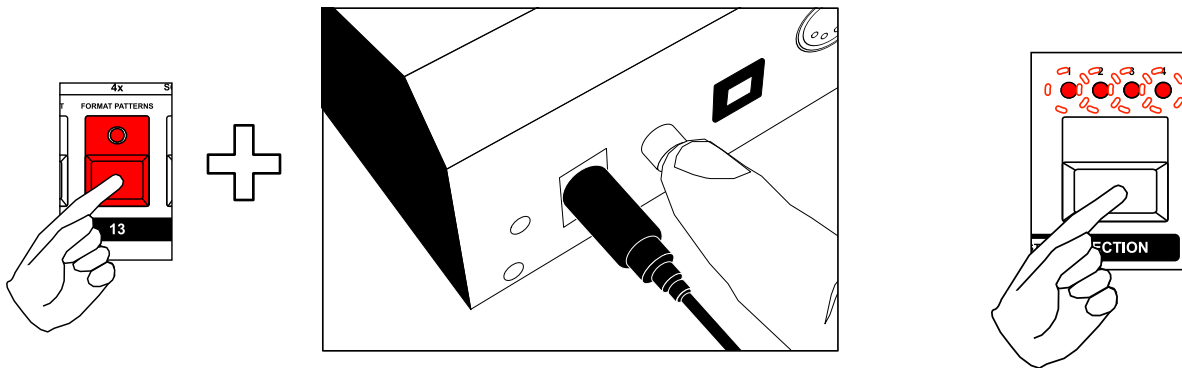

The machine will continue to boot normally after wiping.

FACTORY RESET

It is possible to initialize all memory to factory state, this will erase all data and reset all configurations. This may be necessary in some cases, when updating the operating system, or in the unlikely event that memory becomes corrupted. It is also useful when starting from scratch to initialize the machine to a known state.

To reset the machine, press and hold both FUNCTION and MUTE while powering on the machine. The LED display should briefly show "init" as memory is initialized.

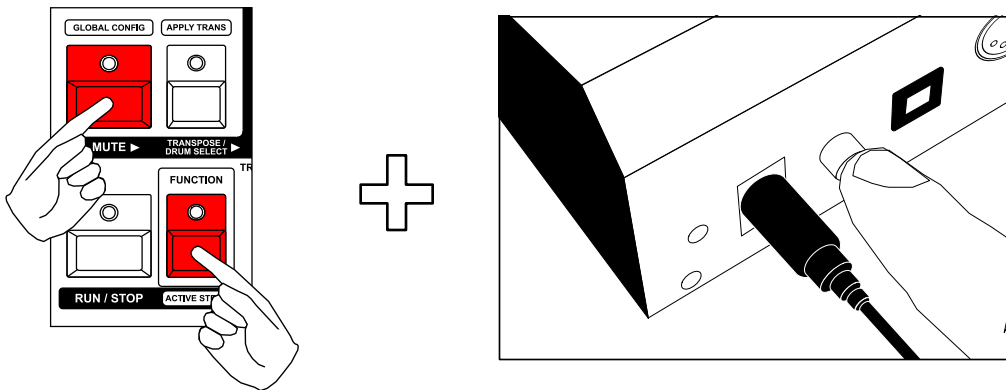

The machine will continue to boot normally after initialization.

CV GATE OUTPUT EXPANSION

Engine can be expanded with an optional CV/Gate output expansion board. The CV/Gate board adds eight pairs of CV/Gate output, which can be used to control modular synthesizers, etc.

The CV and Gate outputs use 1/8" (3.5mm) tip-ring (mono) jacks. Each output is buffered for circuit protection.

The range for the CV outputs is (about) -3V DC to +7V DC.

The GATE outputs are 0 to +10V DC.

The CV/Gate output expansion has a built in hardware slide circuit that is automatically engaged when a slide is programmed into a pattern. This gives a smooth analog slide on the CV output. The slide time is preset to about 70mS, the same as the classic 303 slide.

INSTALLING THE CV EXPANSION BOARD

To install the CV expansion, first power off and unplug Engine. Next you will need to remove the two hex screws holding the blanking panel in place over the expansion port.

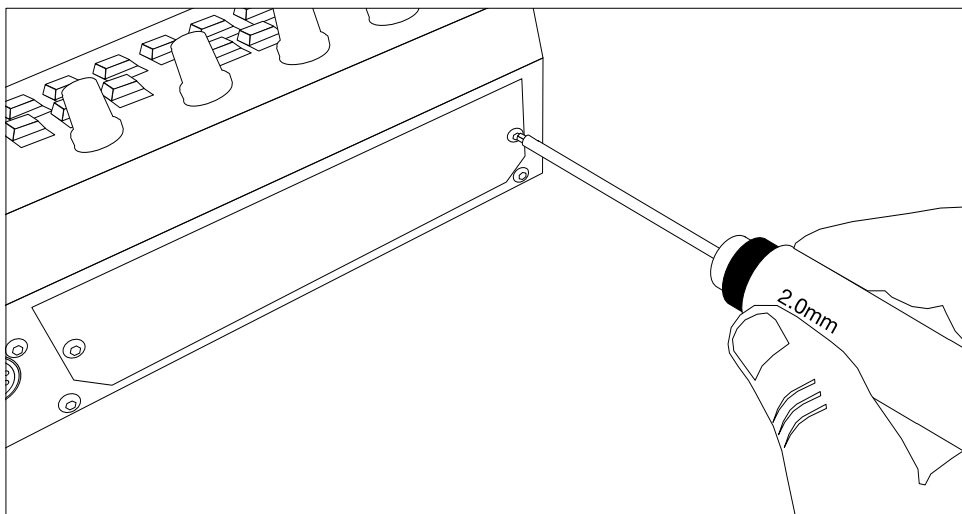

After removing the blanking panel, you will see a 10 pin connection header inside Engine, coming down from the mainboard.

CV EXPANSION

The CV expansion board should have a 10 pin ribbon cable attached to it. The ribbon cable should be carefully plugged into the Engine mainboard. Please pay attention to the connector orientation, there is an orientation key on both the ribbon connector and the header. If you have trouble connecting the ribbon cable, it can help to unplug it from the CV expansion board and plug it into the mainboard first.

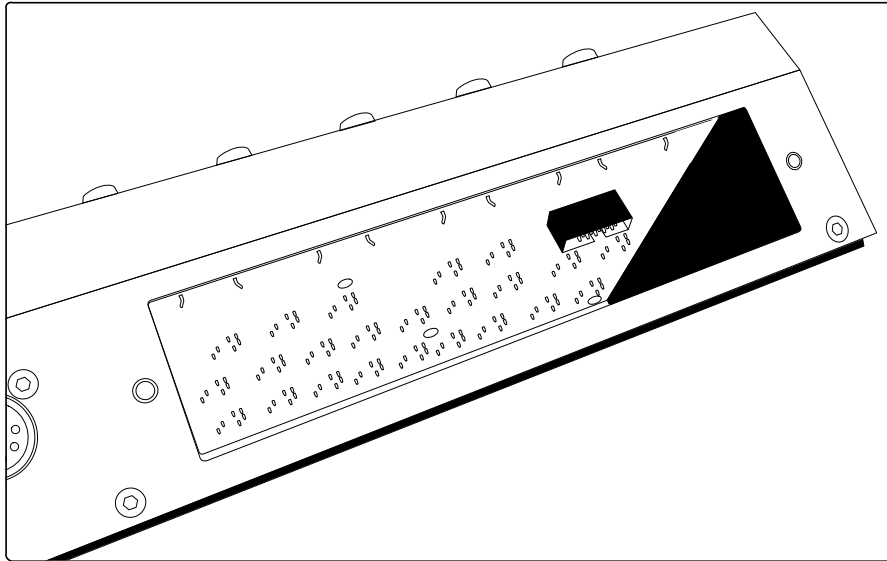

After plugging in the ribbon cable, carefully slide the CV expansion board into the Engine chassis. The mounting holes of the expansion panel should meet up with the threaded holes. Replace and tighten the hex screws to hold the expansion board in place.

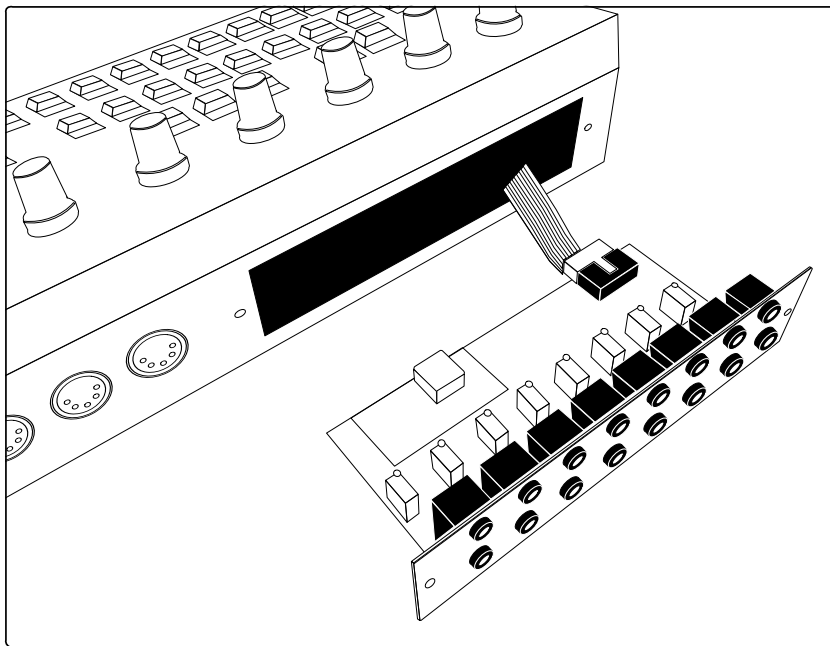

ENABLING THE CV EXPANSION BOARD

After installing the CV output expansion board, the machine must be configured to use the board. If the CV board is not enabled, any settings that relate to CV will show “----” on the LED display when accessed.

Enabling the CV board should only need to be performed once, and is maintained even after factory reset of memory.

To enable the CV board, you must boot Engine while holding down the EXP MODE (step 9) button.

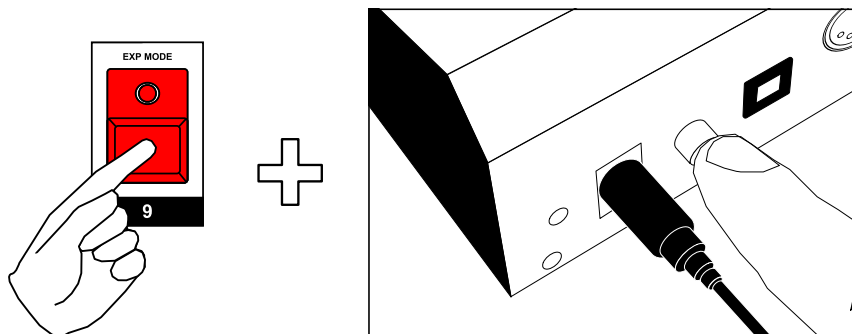

The LED display will show the current expansion board setting. The default setting is “Off”.

Change the expansion setting by rotating control knob 1 or clicking the FORWARD button to select “CV”.

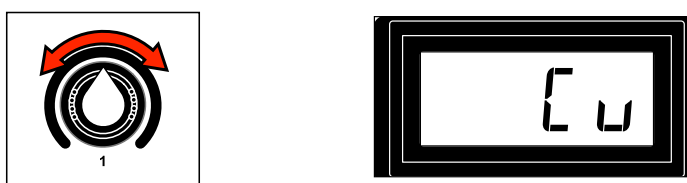

After selecting the “CV” setting, click the RUN/STOP button to resume normal operation.

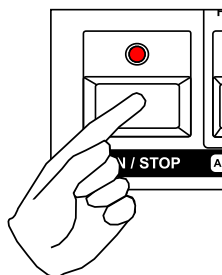

SELECTING THE CV MODE

The function of the CV/Gate outputs is controlled by the EXP MODE settings as defined in the CV EXPANSION MODE section of CONFIG MODE. The default CV MODE is "8 tracks". You can change the EXPANSION MODE to use the CV/Gate outputs for other purposes.

CV CONVERTER MODE

Engine has a special mode to act as a dedicated MIDI to CV converter box. This can be used as 8 monophonic tracks or a single 8-voice polyphonic converter.

It will also convert MIDI clock to DIN Sync in this mode. MIDI input is accepted from either USB or DIN MIDI.

All incoming MIDI is also echoed thru to both DIN MIDI outputs.

In CV converter mode, there are a few options that can be selected to control the conversion.

ENABLING CV CONVERTER MODE

To run Engine as a dedicated CV converter box, you must boot Engine while holding down the UTILITY button.

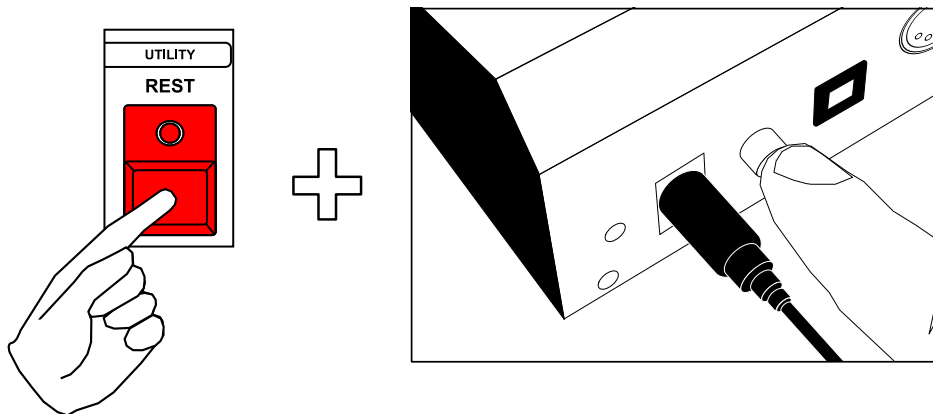

The LED display will show "CONV" to indicate converter mode is active.

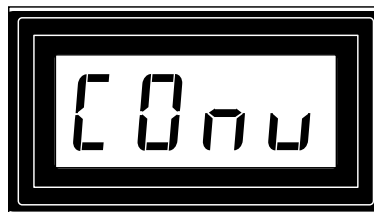

CV EXPANSION

ENDING CV CONVERTER MODE

To stop using CV converter mode, power Engine off and then on again (without holding any buttons). The sequencer mode will start normally.

MONOPHONIC/POLYPHONIC CONVERSION

In monophonic mode, each of the 8 CV/Gate pairs acts independently, each can be configured with a different MIDI channel, and slide mode. This allows you to control eight different analog devices from incoming MIDI.

In polyphonic mode, the 8 CV/Gate pairs are assigned to the same MIDI channel and use a dynamic voice allocation method to play up to eight notes. This can be useful for playing chords on analog synthesizers that have multiple oscillators.

To turn polyphonic mode on or off, click the CHORD (accent) button. Polyphonic mode is indicated by a lit CHORD LED.

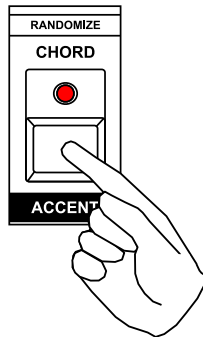

When in polyphonic mode, the MIDI channel assigned to conversion channel 1 is used for all eight CV/Gate outputs. Slide is not used in polyphonic conversion mode.

CV EXPANSION

SETTING CONVERSION MIDI CHANNELS

Each track can have a separate MIDI channel assigned. In polyphonic conversion mode, only the MIDI channel for track 1 is used.

To set the MIDI channel for a CV/Gate output, press and hold the TRACK button that corresponds to the CV/Gate pair. For example, to change the MIDI channel for CV/Gate output 3, press and hold the TRACK 3 button.

To change the MIDI channel, while holding the track button, rotate control knob 1.

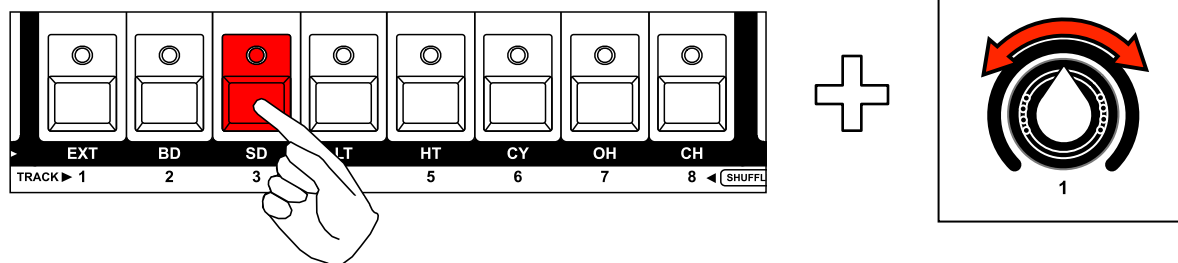

The current MIDI channel will be displayed on the LED display.

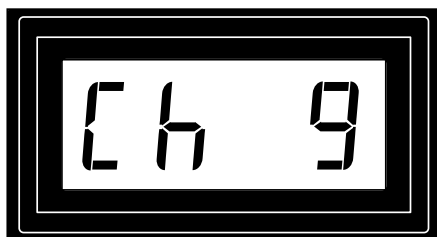

TIP: You can set multiple conversion channels to the same MIDI channel to control multiple monophonic synthesizers from the same MIDI notes.

CV EXPANSION

ENABLING HARDWARE SLIDE

In monophonic conversion mode, each track can have hardware slide enabled. This will cause any overlapping (legato) notes to produce a smooth slide on the CV output and the GATE will not be retriggered.

When slide is not enabled, CV pitch will change instantly, but the GATE will still not be retriggered.

To enable slide for a track, press and hold the track button that corresponds to the CV/ Gate pair. Then click the SLIDE button to enable hardware slide. Click again to disable slide.

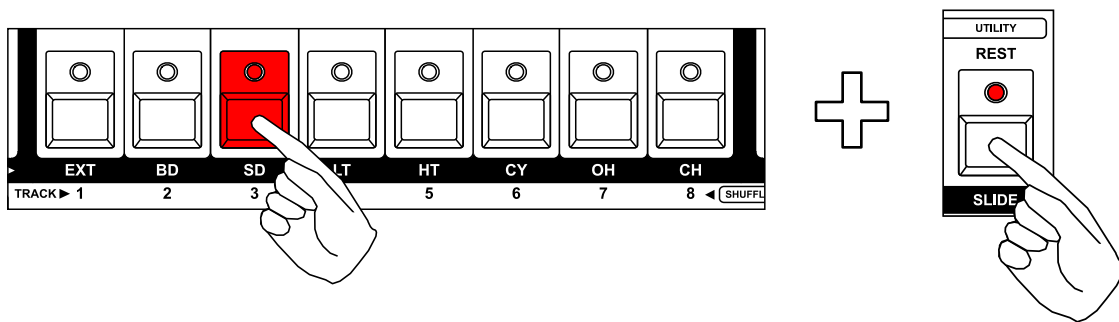







CV EXPANSION

CV/GATE OUTPUT MODE

Each track can be configured to send out CV using either Volt/Octave or Hz/Volt and Gate using either positive trigger or negative trigger. This allows the CV outputs to be used with a wide range of different analog devices. Each of the eight tracks can have a different setting for CV MODE.

NOTE: The CV MODE can only be set when the CV/Gate expansion board is installed and enabled.

The available modes are:

POSITIVE GATE, 1V/OCTAVE		Positive gate, 1 volt per octave
NEGATIVE GATE, 1V/OCTAVE		Negative gate, 1 volt per octave
POSITIVE GATE, Hz/V		Positive gate, hertz per volt
NEGATIVE GATE, Hz/V		Negative gate, hertz per volt
POSITIVE GATE, 1.2V/OCTAVE		Positive gate, 1.2 volts per octave
NEGATIVE GATE, 1.2V/OCTAVE		Negative gate, 1.2 volts per octave

To set the CV MODE for a track, press and hold the track button you wish to configure. Rotate control knob 2 to select the desired mode.

The current CV/Gate output mode will be shown on the LED display.

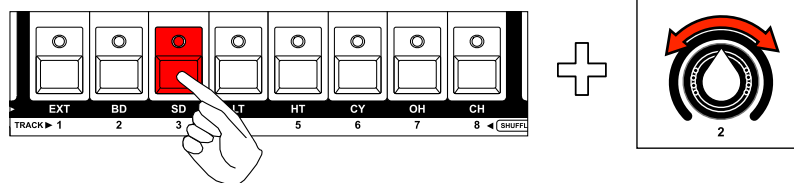

MIDI ROUTING DIAGRAM

This diagram shows the flow of MIDI data through Engine based on various settings.

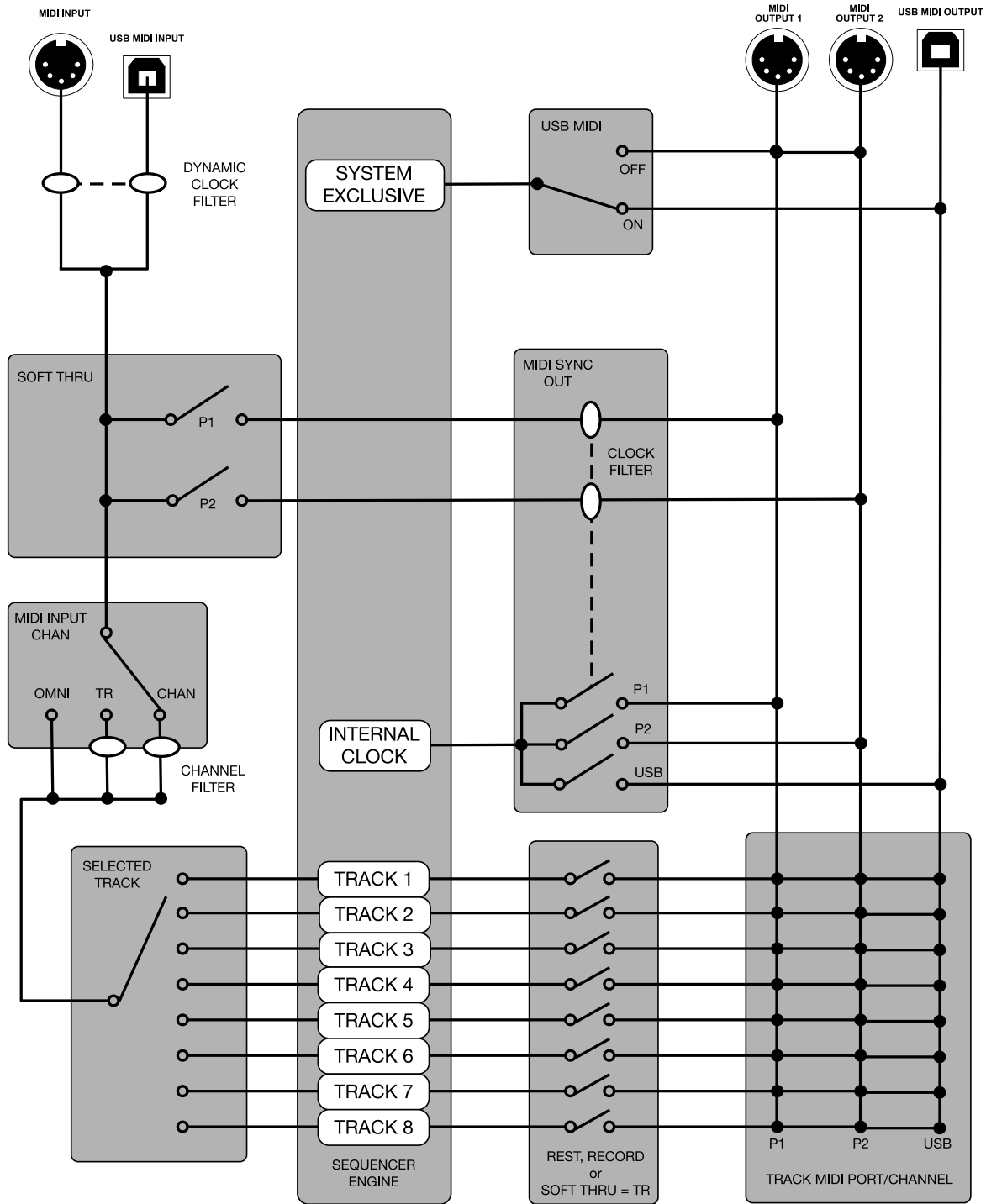

MIDI IMPLEMENTATION CHART

FUNCTION	TRANSMITTED	RECOGNIZED	REMARKS	
BASIC CHANNEL	DEFAULT	1 - 16	MIDI input and output channels can be set independently. Channel settings are stored in memory	
	CHANGED	1 - 16		
MODE	DEFAULT MESSAGES ALTERED	X X *****	X X	
NOTE NUMBER		0 - 127	0 - 127	
VELOCITY	NOTE ON	O	O	SYNTH1 type pattern velocity range is 0 - 127 SYNTH2 type patterns use four velocity values only DRUM type patterns use three velocity values only
	NOTE OFF	O	O	
AFTERTOUCH		X	X	
PITCH BEND		X	X	
CONTROL CHANGE		O	O	RECEIVED: recording of control type patterns
PROGRAM CHANGE		O	O	RECEIVED: Message selects current pattern TRANSMITTED: Message configured per pattern
SYSTEM EXCLUSIVE		O	O	Transmission of pattern and machine configuration
SYSTEM COMMON		O	X	RECEIVED: Only Song Position Pointer for reset to zero is handled.
SYSTEM REALTIME	CLOCK	O	O	
	COMMANDS	O	O	
AUX MESSAGES		X	X	
NOTES:			O : Yes X : No	

