



Apogee Symphony I/O

User's Guide



July 2018

Please Note: While Symphony I/O hardware and Maestro software are fully compatible with macOS 10.9.5 and higher, Symphony I/O firmware can only be updated using macOS 10.10.5 or lower. The Symphony I/O Firmware Updater is not compatible with macOS 10.11 or higher.

Contents

Overview	6
Introduction.....	6
Features.....	6
Package Contents	7
Register your product : apogeedigital.com/register	7
Symphony I/O Panel Tour	8
Front Panel	8
Rear Panel	9
I/O Module Cards	10
8x8 Module	10
8x8 + AES only	10
8x8 + Optical only	10
16x16 Module.....	11
16 Analog In + 16 Digital Out (A16 IP)	11
16 Analog Out + 16 Digital In (A16 OP)	11
2x6 Analog + AES + 8 Optical Module	12
Mic Pre Module	13
Installing I/O Modules	14
Types of Screws in Symphony I/O	14
Directions for Installing I/O Modules	15
Auto Power-On	21
Rack mounting Symphony I/O	22
Connecting Analog Inputs	23
Connecting Inputs to the Mic-Pre module	24
Connecting Analog Outputs	25
Audio Interface Modes	26
Symphony AIM	27
Symphony AIM Requirements	27
Thunderbolt Notes	27
Getting Started	28
Connecting to Symphony 64 ThunderBridge (sold separately)	28

Connecting to Symphony 64 PCIe card (sold separately)	30
Download and Install Software	32
Software Setup	34
Playback from iTunes	34
Select Symphony in your DAW.....	35
Monitoring the Input Signal.....	37
Pro Tools HD AIM.....	39
Pro Tools HD AIM Requirements	39
Getting Started	40
Making Connections	40
Setup Steps.....	42
USB AIM.....	45
USB AIM Requirements	45
Getting Started	45
Download and Install Software	45
Software Setup	47
Playback from iTunes	47
Select Symphony in your DAW	48
Monitoring the Input Signal	50
Standalone AIM	52
Standalone AIM Requirements	52
Getting Started	53
Maestro.....	54
Maestro Features	54
Devices Sidebar	54
Device Icon and ID Button	54
Toolbar.....	54
Input Tab Window	55
Mic Pre Module Input Tab Window	56
Output Tab Window	57
Speaker & Headphone Controls.....	58
Monitor Control Center.....	59
How to set the Monitor Outputs as a fixed Line-Out	59
How to Setup and Use Multiple Speaker Sets.....	60
How to connect & configure a Surround Speaker Setup	61
Adjust for Volume Differences Between Speakers	62
Direct Monitoring	63
Setup Headphone/Speaker Mixes.....	64
Device Settings Tab Window.....	65
Input Routing Tab Window.....	66
Output Routing Tab Window	67
Standalone Routing	68

Mixer Tab Window	69
System Setup Tab Window	70
Clocking with External Equipment	71
Configure Symphony as Clock Master	71
Configure Symphony as Clock Slave.....	72
Menu Bar Menus	73
Calibrating Symphony I/O	74
Soft Limit	75
Digital I/O Formats	76
Setting the Optical I/O Format.....	76
Using the S/PDIF Coax I/O.....	76
Meters.....	77
Meter Characteristics	77
Peak and Over Hold.....	77
Front Panel Meters.....	77
VBus - Symphony AIM.....	78
Working with VBus.....	78
Configuring VBus	78
Reference	79
Working in your Digital Audio Studio.....	79
Setting Levels	79
Understanding Latency	80
What is latency?.....	80
How does Maestro resolve latency?	81
Do I need the Maestro Mixer?	81
How do I set my software's I/O Buffer?	82
Troubleshooting - FAQ.....	83
How do I reset Symphony I/O to its factory default settings?.....	83
Not getting audio input/output in my DAW	83
No output from Symphony I/O	84
No sound or low level on outputs 1-2, How to set to Line Level?	84
Exclamation-mark (!) on front-panel/Symphony doesn't show up in Maestro	85
The firmware updater fails or gets stuck.....	85
Is Symphony Mobile still supported?	86
How do I set the Symphony I/O to auto power on?.....	86
How do I calibrate Symphony I/O?	86

SPDIF or ADAT/SMUX Optical isn't working	86
No Loop Sync option in Maestro?	86
2 Symphony I/Os together with Symphony 64 Thunderbridge or PCI ?	87
Symphony64 Thunderbridge/PCI not showing up after updating macOS	87
Symphony I/O + AD/DA16x or Rosetta on Symphony64 Thunderbridge/PCI?	88
Signal showing up in wrong place and/or routing is incorrect in Pro Tools HD	89
How does the routing for the 2x6 module show up in Pro Tools HD?	89
Delay Compensation with Pro Tools HD	90
Mic Pre Module FAQ	91
Pin Out Diagrams.....	92
Analog I/O and Inserts	92
AES IN/OUT	93
Specifications	94
Additional Support	95
General Support	95
Apogee Pro Care	95
Warranty Information and Legal Notices	96

Overview

Introduction

Symphony I/O is a multi-channel audio interface featuring Apogee's flagship AD/DA conversion, modular I/O (up to 32 inputs and outputs per chassis), Audio Interface Mode (AIM) technology for simple and direct connection to all popular audio workstations and formats, and optional world-class microphone preamps. Designed to deliver professional sound quality for audio recording, mixing and mastering, Symphony I/O is the ultimate music production centerpiece for any modern studio.



Features

- Up to 32 channels of modular analog I/O with optional 8 mic preamps
- Two (2) studio quality headphone outputs
- Choice of Thunderbolt*, PCIe, Pro Tools® HD (Mac/PC) or USB audio connectivity
- Ultra-low latency performance
- Monitor control from front-panel
- Designed in California, Built in the U.S.A.

*with optional Symphony64 Thunderbridge (sold separately)

Package Contents

- Symphony I/O
- USB 2.0 cable
- 3 pin-IEC power cable
- Rack-ears and screws
- QuickStart Guide



Register your product : apogeedigital.com/register

- Access Apogee's expert Technical Support for free
- Receive important product update information by email
- Take the Customer Satisfaction Survey for a chance to win Apogee gear!

Symphony I/O Panel Tour

Front Panel



1. **Power button** - When the rear panel AC Input is connected to an AC wall socket, the power switch and the Apogee icon will glow softly, indicating that Symphony I/O is in Standby. Press the power button for a half second to power up Symphony I/O. Symphony I/O may be configured to power on as soon as an AC voltage is present on the rear panel AC Input. You may find this preferable when using an external power switch (such as an equipment rack power strip) to power on the unit. See AutoPower for details.
2. **Level Meter Banks** - Each bank of 8 10-segment level meters may be configured in Maestro to display analog or digital inputs or outputs.
3. **Meter source LEDs** - These LED pointers indicate the signal source of each meter bank. For each bank, the format (Analog or Digital) and type (Input or Output) are indicated with a small triangle. For example, when Bank 1 is configured to display analog inputs and Bank 2 is configured to display analog outputs, the meter source LEDs appear as shown below.
4. **Clock source LEDs** - The four clock source LEDs (INTernal, WC, DIGital, LOOP) indicate Symphony I/O's clock source. For the details of how to set the clock source, see Setting the Clock Source.
5. **Sample Rate Display** - These 7-segment LEDs display Symphony I/O's sample rate. For the details of how to set the the sample rate, see Setting the Sample Rate.
6. **Front panel encoders** - The front panel encoders may be used to make a variety of settings, from listening levels to sample rate, clock source and Audio Interface Mode. The various encoder functions are described in the chapters Configuring your Symphony I/O System and Working with your Symphony I/O System.
7. **Front panel OLED Display** - The front panel OLED Display provides user feedback on input and output levels, system status and other Symphony I/O parameters.
8. **1/4" Headphone Outputs** - These 1/4" connectors provide individually assignable stereo headphone outputs.
9. **Removable Rack Ears** - Rack ears are included in the Accessories box for mounting Symphony I/O in a standard 19" equipment rack.

Rear Panel



1. **Module Slot 1** - The first I/O Module card must be installed in this slot (any module except the Mic-Pre)
2. **Module Slot 2** - Once a module has been installed in the Card 1 slot, an additional module may be installed in this slot. Mic Pre Modules must be installed in this slot when you have an 8x8 or 16x16 module in slot 1.
3. **Cooling Fan** - The cooling fan is automatically controlled by an internal thermostat.
4. **Symphony Main** - For connecting to a Symphony 64 Thunderbridge or PCIe card or a Pro Tools HD card.
5. **Symphony Thru** - Functionality for this port was never enabled, as daisy-chaining units isn't necessary.
6. **Ethernet** - This RJ-45 port was originally included on some older units for possible future development purposes, but was removed after the last hardware revision since it was no longer needed.
7. **USB** - This USB 'Type B' receptacle is used to connect Symphony I/O to an Apple Mac computer. If Audio Interface Mode is set to USB Audio, audio may be streamed to and from the Mac.
8. **WC Term** - This push-on, push-off button engages 75 ohm termination on the WC In BNC connector.
9. **WC In** - This BNC accepts word clock signals, allowing Symphony I/O to clock to external devices.
10. **WC Out** - This BNC transmits word clock signals, allowing Symphony I/O to clock external devices.
11. **Loop In** - This BNC accepts Loop Sync signals when Symphony I/O is in Pro Tools HD mode.
12. **Loop Out** - This BNC transmits Loop Sync signals when Symphony I/O is in Pro Tools HD mode.
13. **AC Input** - This IEC connector accepts an AC input of 100 to 250 volts at 47 to 63 Hz. No internal adjustments are required to power Symphony I/O from an AC connection in this range.

I/O Module Cards

The Symphony I/O has a configurable chassis allowing it the flexibility for use in any environment. Two card slots can be filled by any combination of several module cards providing a solution for everyone.

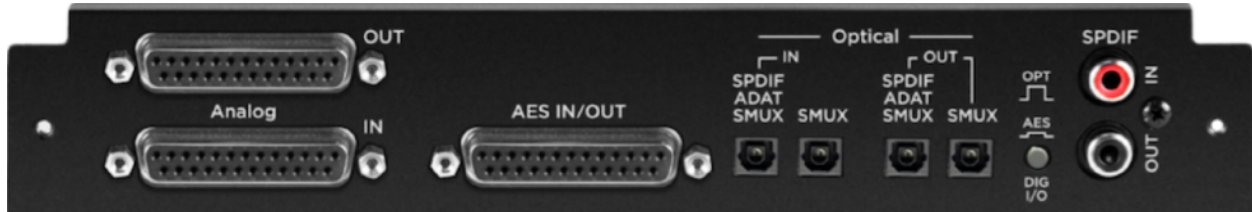

8x8 Module

Provides a total of 16 channels of audio input and output:

- 8 channels of analog input and output
- 8 channels of digital input and 8 channels of digital output through either the AES DB25 connector (Yamaha Pin-out configuration), or Optical ports

To select either Optical or AES digital audio:

1. Toggle the **DIG I/O** button to the desired position
2. Power-cycle the Symphony I/O (turn the unit off, then on)

Optical ports can be configured to use the S/PDIF or ADAT/SMUX protocols.

S/PDIF	44.1 - 192k Sample Rates	- 2 channels of audio in and 2 channels of audio out
ADAT	44.1 - 48k Sample Rates	- 8 channels of audio in and 8 channels of audio out
SMUX	88.2 - 96k Sample Rates	- 4 channels of audio in and 4 channels of audio provided per port - 8 channels in and 8 channels out total when using both ports

Digital Coaxial RCA S/PDIF ports are also provided.

- **SPDIF IN** replaces a pair of analog or digital audio inputs. Routing of the S/PDIF input is set with the S/PDIF Replaces drop down menu, found in Apogee Maestro's Input tab window.
- **SPDIF OUT** will duplicate any pair of analog or digital audio outputs. Routing of the S/PDIF Output is set with the S/PDIF Mirrors drop down menu, found in Apogee Maestro's Output tab window.

Note: The two variants of the 8x8 card are also compatible:

8x8 + AES only



8x8 + Optical only



16x16 Module



Provides 16 channels of analog input and output.

Digital Coaxial RCA S/PDIF ports are also provided.

- **SPDIF IN** replaces a pair of analog or digital audio inputs. Routing of the S/PDIF input is set with the S/PDIF Replaces drop down menu, found in Apogee Maestro's Input tab window.
- **SPDIF OUT** will duplicate any pair of analog or digital audio outputs. Routing of the S/PDIF Output is set with the S/PDIF Mirrors drop down menu, found in Apogee Maestro's Output tab window.

Note: The following 16 channel cards are also compatible:

16 Analog In + 16 Digital Out (A16 IP)



16 Analog Out + 16 Digital In (A16 OP)



2x6 Analog + AES + 8 Optical Module

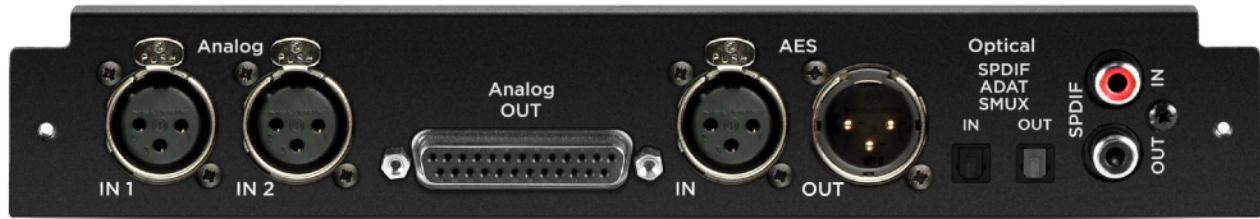

Provides up to 12 channels of audio input, and up to 16 channels of audio output.

INPUTS

2-channels of analog input via balanced XLR connectors

2-channels of AES digital audio input via XLR female connector

Up to 8-channels of digital audio input via Optical connector

SPDIF	44.1 - 192k Sample Rates	- 2 channels
ADAT	44.1 - 48k Sample Rates	- 8 channels
SMUX	88.2 - 96k Sample Rates	- 4 channels

OUTPUTS

6-channels of analog output via DB25 connector

2-channels of AES digital audio output via XLR make connector

Up to 8-channels of digital audio output via Optical connector

SPDIF	44.1 - 192k Sample Rates	- 2 channels
ADAT	44.1 - 48k Sample Rates	- 8 channels
SMUX	88.2 - 96k Sample Rates	- 4 channels

The Optical format is selected in Apogee Maestro's Device Settings tab window.

Digital Coaxial RCA S/PDIF ports are also provided.

- **SPDIF IN** replaces a pair of analog or digital audio inputs. Routing of the S/PDIF input is set with the S/PDIF Replaces drop down menu, found in Apogee Maestro's Input tab window.
- **SPDIF OUT** will duplicate any pair of analog or digital audio outputs. Routing of the S/PDIF Output is set with the S/PDIF Mirrors drop down menu, found in Apogee Maestro's Output tab window.

NOTE: The Mk II and SE modules (8x8 Mk II, 16x16 Mk II, 2x6 SE) introduced for Symphony I/O Mk II cannot be used in the original Symphony I/O chassis.

Mic Pre Module

The Mic Preamp Module upgrades the functionality of any 8x8 or 16x16 module by adding mic preamps to the existing line inputs. A direct connection between the Mic Preamp Module and the Analog I/O Module inserts a mic preamp stage before the line inputs.



1. **INSTRUMENTS 1-4** - These 1/4" TS connectors accept input from a wide range of instruments, including keyboards, guitars and other electronic instruments. The input impedance is high enough to avoid the loading of input sources such as passive electric guitars and basses.
2. **INSERTS Send 1-8** - This DB-25 connector provides 8 analog balanced line level sends routed after each channel's mic preamp stage.
3. **INSERTS Return 1-8** - This DB-25 connector accepts 8 analog balanced line level returns routed before each channel's A/D conversion stage.

Use the INSERT sends and returns to insert analog line level gear (such as compressors and equalizers) between a channel's mic preamp and A/D conversion stage.

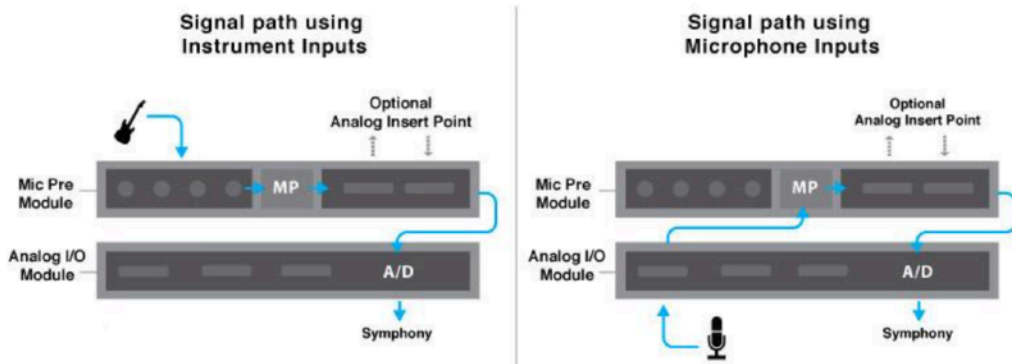

Installing I/O Modules

In most cases, Symphony I/O ships with the first I/O Module installed. For the infrequent case where no I/O Modules are installed, we recommend having them installed by Authorized Symphony I/O Technicians.

If you are brave enough to install them on your own, this section describes both how to install the first I/O Module as well as a second I/O Module.

Types of Screws in Symphony I/O

Be careful to keep track of these screws and use them only for their intended purposes



Stand off

Stand off – This secures the Modules to the chassis when using 2 Modules



Module/Rear Screw

Module/Rear Screw – Use these round head screws to secure Modules to the chassis and to secure the rear of the cover to the chassis



Rack Ear Screw

Rack Ear Screw – Use these undercut screws to attach the Rack Ears



Case Bottom Screw

Case Bottom Screw – Use these undercut screws to attach case on bottom of unit and to secure the center support

Directions for Installing I/O Modules

- 1.** Discharge Residual Electricity- **IMPORTANT!** Even when Symphony I/O is powered off but connected to the AC wall socket, voltages remain active throughout the system. Manipulating circuit boards under these conditions may result in permanent damage.
 - a.** Turn Symphony I/O off, but leave the AC cable connected.
 - b.** Ground yourself by touching the front panel of Symphony I/O to discharge static electricity.
 - c.** Unplug the AC cable from Symphony I/O.
 - d.** Wait for at least 2 minutes to let the power discharge from the circuitry.
- 2.** Use a Phillips screwdriver to remove the 11 screws holding the cover on.



- 3.** To remove the cover, slide it straight back until the underside clips prevent further movement. Then grasp the cover's side panels and gently bow the cover until the bottom lip is free.



4. Remove the 2 screws holding the center support in place, and lift out the support.



5. Remove both I/O Module blanking panels and set the screws aside for later use.



6. Remove the 9 screws indicated below, and set them aside for later use.

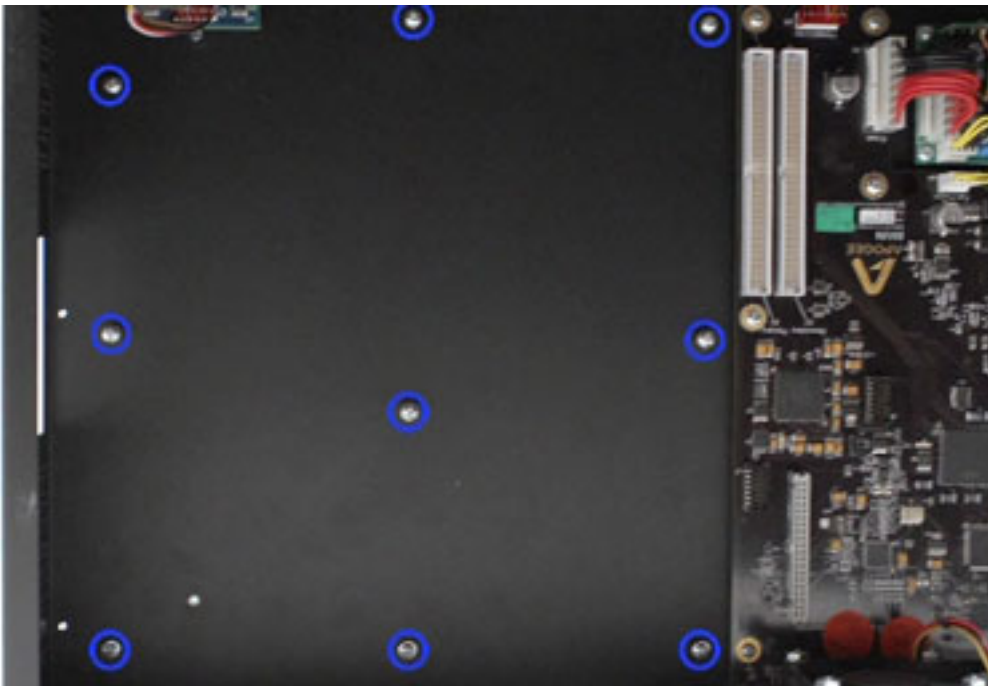

7. Place the first I/O Module into the chassis by inserting the I/O Module rear panel into the Symphony I/O Card 1 opening, then gently dropping the front of the I/O Module into place. Line up the I/O Module's mounting holes with the 9 nuts on the bottom of the chassis.

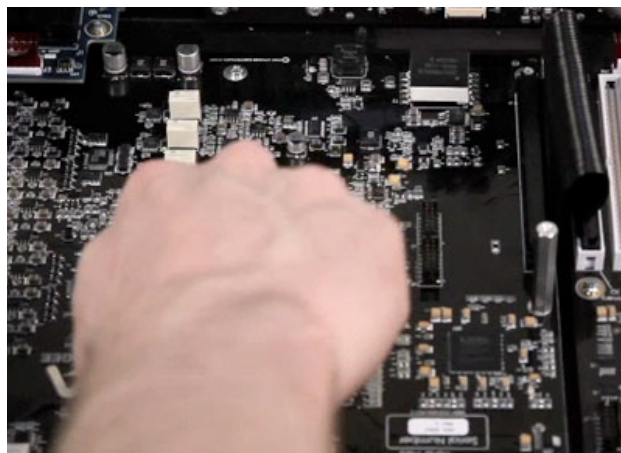

8. Secure the I/O Module by installing the 9 screws removed in Step 6. If you're installing a second I/O Module, install 9 stand-offs in the place of the 9 screws.

9. Secure the I/O Module rear panel to the chassis rear panel using the two screws from Step 4.

10. If you are only installing a single Module, replace the second slot's blanking panel.

11. Connect the provided ribbon cable between J1 on the Main board and J1 on the I/O Module. Be sure to align the key on each ribbon cable connector to the key slot on each receptacle.

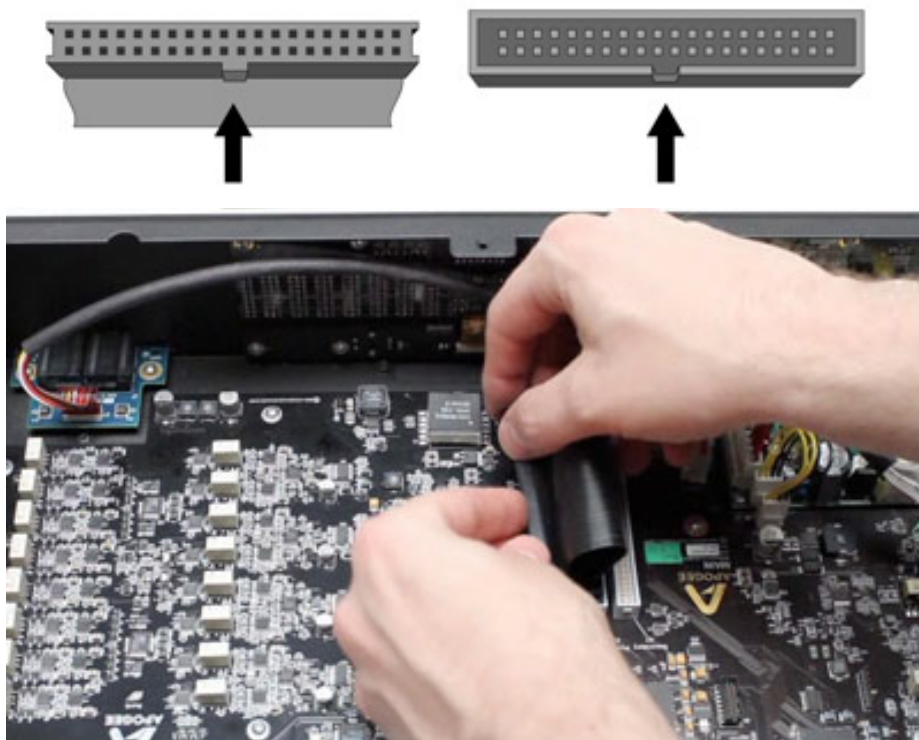

12. To install a second Module, insert the I/O Module rear panel into the Symphony I/O Card 2 opening, then gently dropping the front of the I/O Module into place. Line up the second I/O Module's mounting holes with the tops of the 9 stand-offs.

13. Connect the provided ribbon cable between J2 on the Main board and J1 on the second I/O Module. Make sure that the lower Module ribbon cable is nested into the upper Module ribbon cable as shown below.

Do not tuck the Primary I/O ribbon cable underneath the second Module or it could become frayed.

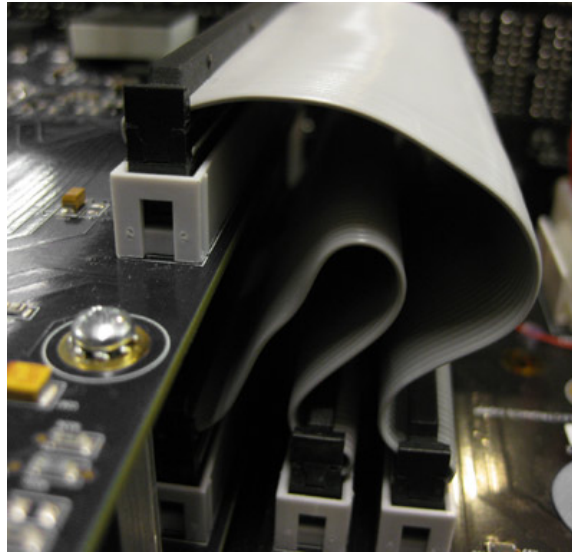

14. Reconnect the center support bar.

15. Reserving the steps to remove the cover, slide it back into place and secure with the 11 screws removed in Step 2. Use 6 undercut screws to secure the cover bottom and 5 round head screws to secure the cover's rear tab.

Auto Power-On

To configure Symphony I/O to power on as soon as AC power is present on the rear panel AC input, follow these steps. Auto Power is useful in circumstances where an external power switch is used to power on multiple devices, such as a rack of Symphony I/Os with a master power switch.

1. Disconnect Symphony I/O's AC input.
2. Remove the top cover as described in Installing I/O modules.
3. Place a jumper across pins **J18** (whose location is indicated below).
4. Replace the top cover before applying AC power.
5. The front panel power switch remains operational.

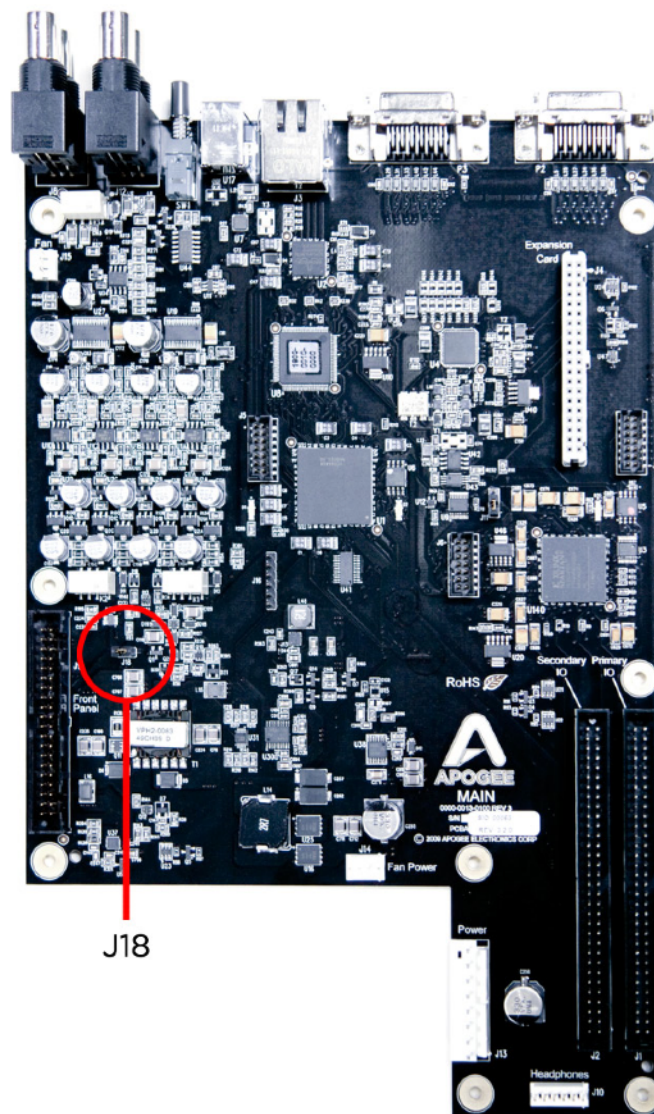

Rack mounting Symphony I/O

Rack ears are included in the Accessories box for mounting Symphony I/O in a standard 19" equipment rack.



1. Orient one rack ear to line up the ear's three holes with three holes found on the side of the chassis immediately behind the front panel extrusion.
2. Insert 3 screws (included) and finger tighten.



Rack Ear Screw – Use these undercut screws to attach the Rack Ears

Rack Ear Screw

3. Connect the second rack ear to the other side of the chassis.
4. On each side, line up the top and bottom of the rack ear with the top and bottom of the front panel extrusion and tighten the screws with a Phillips screwdriver. Don't over-tighten the screws.
5. Remove the screw-on feet by turning them counter-clockwise by hand or with a Philips screwdriver.



Connecting Analog Inputs

Connect line inputs to the rear-panel analog inputs using a DB25-to-8 Female XLR breakout cable. To connect analog inputs to a 2x6 module, you do not need a breakout cable. You would connect your line inputs to the 2 XLR inputs (Analog IN 1-2) on the left side of the rear-panel.

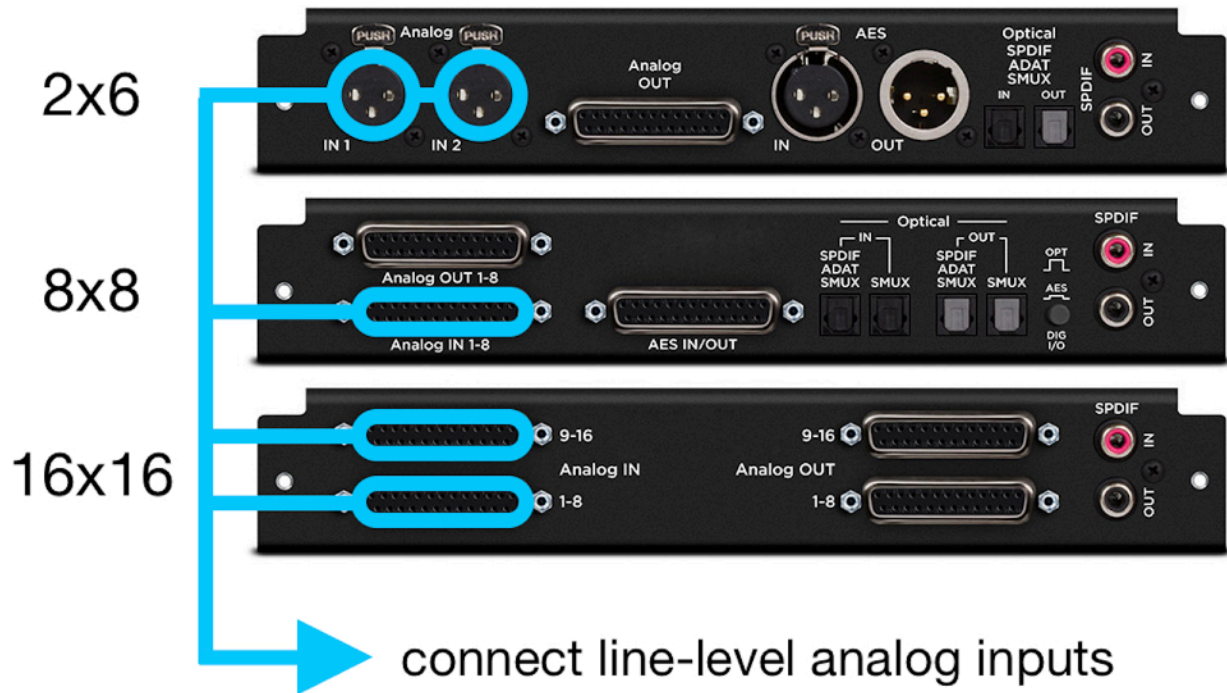

For a unit with an 8-channel Mic-Pre module installed in the top slot:

You would still use the same DB25-to-8 Female XLR breakout cable to connect your mic or line inputs into the bottom 8x8 or 16x16 module. The signal is then routed up through the Mic-Pre module after setting the input channels to 'Mic' or 'Inst' in the Apogee Maestro 2 software. Be sure that you don't connect your inputs to the Insert Sends and Returns on the Mic-Pre module. See next page for details.

Connecting Inputs to the Mic-Pre module

The Mic Preamp Module upgrades the functionality of any Analog I/O Module by adding mic preamps to the existing line inputs. A direct connection between the Mic Preamp Module and the Analog I/O Module inserts a mic preamp stage before the line inputs.

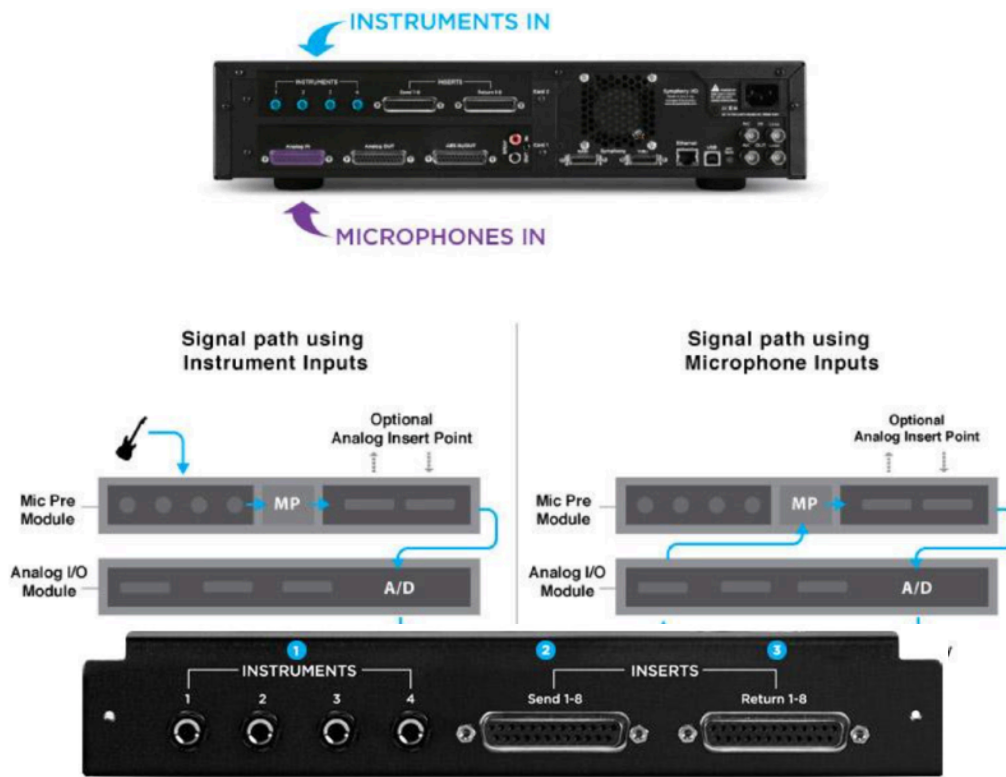

1. **INSTRUMENTS 1-4** - These 1/4" TS connectors accept input from a wide range of instruments, including keyboards, guitars and other electronic instruments. The input impedance is high enough to avoid the loading of input sources such as passive electric guitars and basses.
2. **INSERTS Send 1-8** - This DB-25 connector provides 8 analog balanced line level sends routed after each channel's mic preamp stage.
3. **INSERTS Return 1-8** - This DB-25 connector accepts 8 analog balanced line level returns routed before each channel's A/D conversion stage.

Use the INSERT sends and returns to insert analog line level gear (such as compressors and equalizers) between a channel's mic preamp and A/D conversion stage.

Connecting Analog Outputs

Connect monitor sources such as speakers, monitor controllers, and consoles to the rear-panel analog outputs using a DB25-to-8 Male XLR breakout cable.

Note: Analog Outputs 1-2 will default to a level of -20dB. It is recommended to turn the level down all the way and gradually bring it up when connecting speakers and playing audio for the first time.

If you are going to use an external monitor controller or console and would like Analog Outputs 1-2 to be at line-level like the other outputs, you can either turn them up to 0dB by using the left-side front-panel encoder knob to select the speaker icon and then using the right-side front-panel encoder knob to raise the level to 0dB. You could also do this in the Apogee Maestro app by going to the Output tab, scrolling over to the right, and raising the level to 0dB with the Main output's software knob or changing the output format from Speaker to Line.

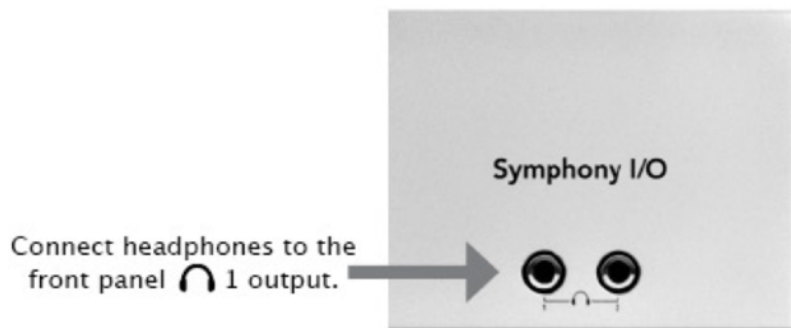

Audio Interface Modes

The Symphony I/O has four different Audio Interface Modes (abbreviated as AIM) to choose from—**Symphony** AIM, **Pro Tools HD** AIM, **USB** AIM, and **Standalone** AIM. Most people tend to use only one or sometimes two of the AIMs, although you can use all four if you would like. The Symphony I/O can only be in one AIM at a time, so when you switch to a different AIM (shown below), the unit will restart itself in the new AIM.

Choose your AIM by pushing in and holding on the right-side front-panel encoder knob, scrolling through the different selections until it shows the one you want, and then pushing in on the encoder knob again to restart the unit in the desired AIM.

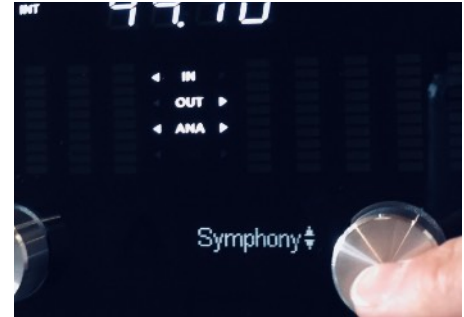

When you see a page in this user's guide with one of the AIM icons (shown below) in the upper right corner of the page, this means the information is specific to that AIM. If you are using USB AIM, for example, and you see only the Pro Tools HD AIM icon in the upper right corner of a page, you can skip that page. Any pages without a specific AIM icon in the upper right corner will apply to all four AIMs.



Symphony AIM

for use with a Symphony 64 Thunderbridge* or PCI card* and a Thunderbolt or PCI equipped Mac.
*sold separately



Pro Tools HD AIM

for use with an Avid Pro Tools HDX, HD Native (PCI card or Thunderbolt box), HD Accel Core, HD Accel, HD Core, or HD Process card and Pro Tools HD or Pro Tools Ultimate software.

Note- Pro Tools HD version 12.6 and greater requires a [DigiLink I/O license](http://www.avid.com/licenses/pro-tools-digilink-io-license) to use 3rd-party interfaces. Information available at <http://www.avid.com/licenses/pro-tools-digilink-io-license>



USB AIM

for using as a USB Audio interface with a USB (2.0, 3.0, 3.1, or USB-C) equipped Mac.



Standalone AIM

for using as a Standalone audio converter with optional parameter control through USB on a USB (2.0, 3.0, 3.1, or USB-C) equipped Mac.



Symphony AIM

Symphony AIM Requirements

Requirements when connecting to Symphony 64 ThunderBridge or PCI card:

- Apogee Symphony 64 ThunderBridge or PCI card (sold separately)
- mac OS Mavericks 10.9.5 or greater (64-bit and 32-bit kernel modes)
- [Symphony System Release Package 5.3 \(download from Apogee website\)](#)
- 4GB minimum RAM, 8GB recommended
- PC-32 ('Symphony') cable and Thunderbolt cable (if using Thunderbridge)

Note- For connection to Symphony Mobile Express/34 cards, you will need to download the Symphony Release 4.4 installer package and use mac OS 10.8.5 or below. This can be requested by contacting our [Support Department](#).

Thunderbolt Notes

- The two Thunderbolt 2 ports on the Symphony 64 ThunderBridge (sold separately) allow you to chain up to 6 Thunderbolt peripherals from the ThunderBridge.
- Thunderbolt 2 is backwards compatible and can connect to Thunderbolt 1, Thunderbolt 2, or Thunderbolt 3 Macs.
- Under most circumstances, the order in which peripherals or ports are connected doesn't matter.
 - Exception: If you're connecting peripherals with different Thunderbolt speed ratings, connect the higher speed devices closer to your Mac in the chain.
 - i.e. Mac > Thunderbolt 3 devices > Thunderbolt 2 devices > Thunderbolt devices
- A non-Thunderbolt device (i.e. Firewire, HDMI, DisplayPort, etc.) may be connected to the chain, but the adapter for the device must be placed at the end.

Some older Macs have mini **DisplayPort** connections that, while identical in appearance to a **Thunderbolt** port, don't support **Thunderbolt** peripherals. Verify that the **Thunderbolt** logo is present on your Mac's ports.



X Mini DisplayPort



✓ Thunderbolt Port

For Macs equipped with a Thunderbolt-3 port, Apple's Thunderbolt 3 to Thunderbolt 2 adapter can be used.

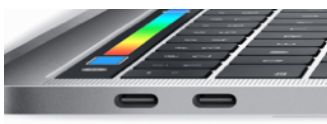

Thunderbolt-3 Port



Thunderbolt-3 to Thunderbolt-2 adapter



Getting Started

Before powering on, ensure that any speakers or amplifiers connected to Symphony's analog outputs are powered off, or the volume turned down to the minimum setting. This will prevent potential damage to your speakers and other equipment from "pops" that may occur as the unit boots up.

1. **Power off speakers**
2. **Power Symphony On**
3. **Power on speakers.**

Likewise, before powering Symphony off, ensure any speakers or amplifiers connected to Symphony's analog outputs are powered off, or the volume turned down to the minimum setting.

4. **Power off speakers**
5. **Power Symphony Off**

Connecting to Symphony 64 ThunderBridge (sold separately)

For Connecting to Symphony 64 PCI card, please skip to page 30.

If you've already set up your Symphony 64 ThunderBridge or PCI card, skip ahead to page 32.

1. Connect the included DC power supply to Symphony 64 ThunderBridge's DC input and to an AC outlet using the included cable (or using a standard IEC cable for your territory). The DC power supply accepts AC from 90-250 volts.
2. Connect the Main Symphony port of your Symphony I/O to Symphony 64 ThunderBridge Port 1: CH 1-32 and power on the connected unit.





6. Confirm that your Symphony I/O is in 'Symphony' mode by pushing in and holding on the right-side front-panel encoder knob, scrolling through the different Audio Interface Modes until it shows 'Symphony', and then pushing in on the encoder knob again to restart the unit in the 'Symphony' mode.

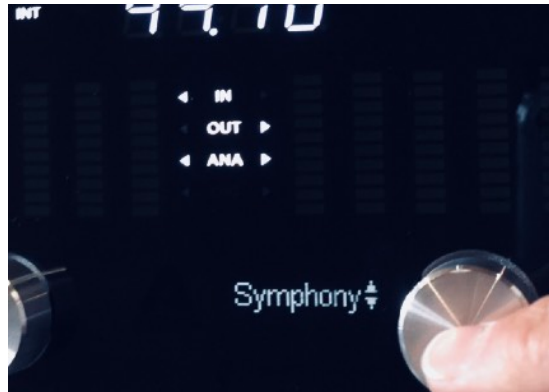

7. Connect one of Symphony 64 ThunderBridge's Thunderbolt ports to your Mac with a Thunderbolt cable - it doesn't matter which port is used.

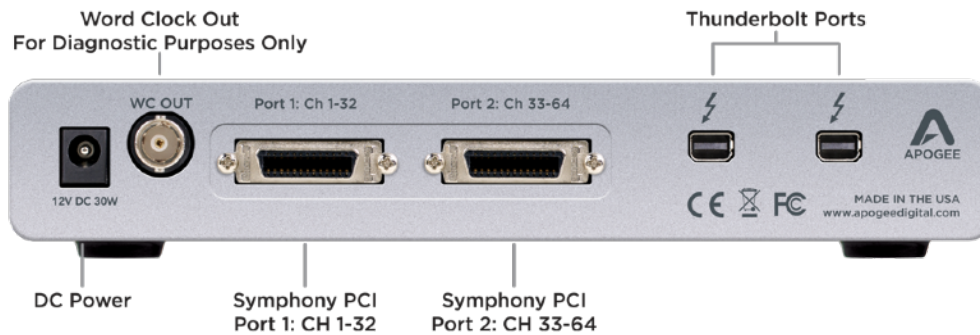

If you are connecting 2 Symphony I/Os to your Symphony 64 ThunderBridge, setup instructions can be found on page 88 of this User's Guide.

Skip ahead to page 32 to continue.



Connecting to Symphony 64 PCIe card (sold separately)

For Connecting the Symphony 64 ThunderBridge, please refer to page 28.

If you've already set up your Symphony 64 ThunderBridge or PCI card, skip ahead to page 32.

Install the Symphony 64 PCI Card (sold separately)

These instructions will also apply to installing the PCI card into a Thunderbolt to PCI chassis for use with a Thunderbolt Mac. Just replace the word 'Mac' with 'Thunderbolt to PCI chassis'.

1. Power down the Mac and wait for 5-10 minutes.
2. Disconnect all external cables to the Mac except the AC power cable.
3. Touch the Mac's metal PCI access covers to discharge any static electricity in your body.
4. Disconnect the AC Cable.
5. Remove the Mac's side cover and carefully put it aside.
6. Remove the Mac's PCI bracket by unscrewing the two thumb screws on the bracket.
7. Holding the Symphony PCI card by its corners, align the card's connector with the desired PCI slot and press the card firmly into place. If the card does not slide into place with minimal effort, remove the card, check alignment, and check for foreign objects.
8. Once the card is installed, re-attach the PCI bracket to secure the Symphony 64 card.

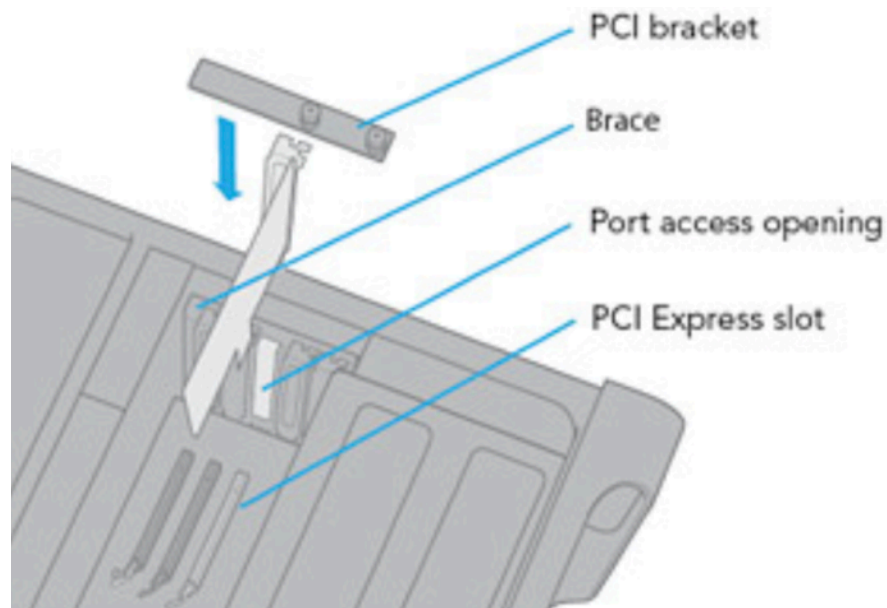



9. Re-install the Mac's side panel.

10. Using the 3 meter PC-32 cable included with the Symphony 64 card, connect the Symphony I/O's Main port to the Symphony 64 PCI card's Channels 1-32 port as shown below.

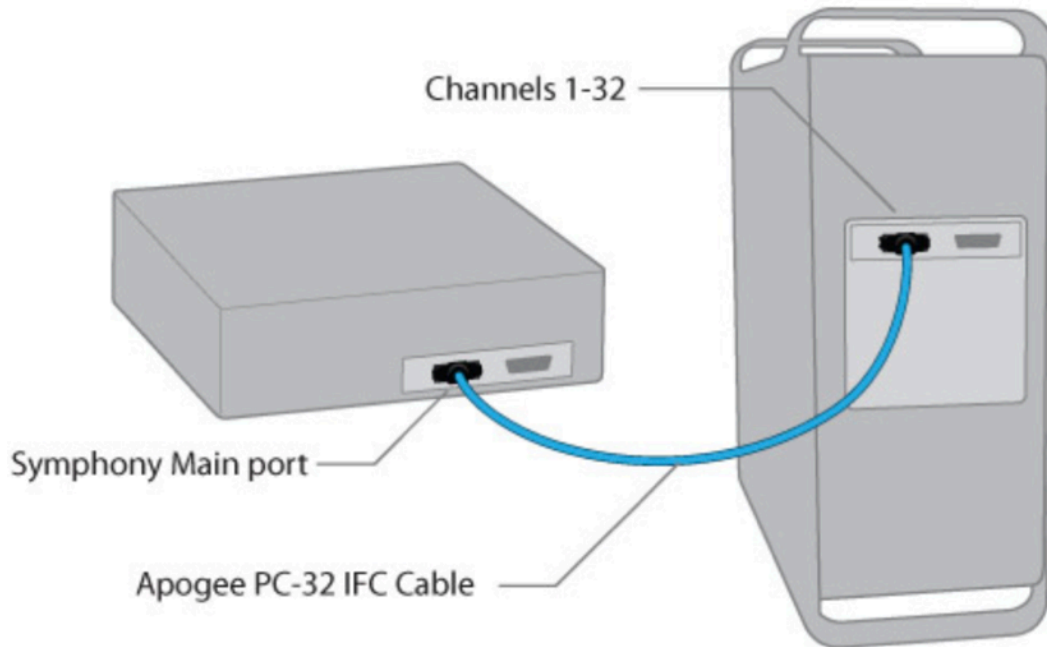

11. Power up your Mac and the Symphony I/O.

12. Confirm that your Symphony I/O is in 'Symphony' mode by pushing in and holding on the right-side front-panel encoder knob, scrolling through the different Audio Interface Modes until it shows 'Symphony', and then pushing in on the encoder knob again to restart the unit in the 'Symphony' mode.

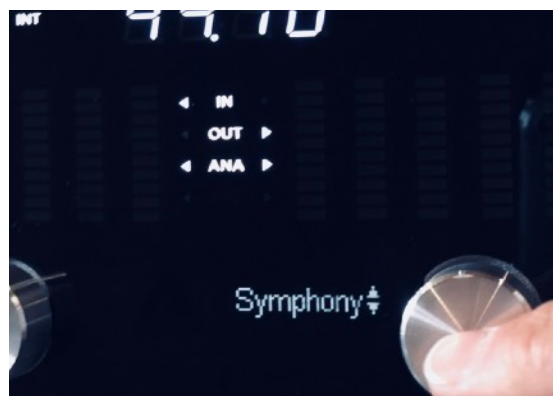



Download and Install Software

Before Symphony I/O will be recognized by your Mac, you must download & install the latest Symphony I/O Software from Apogee's website: www.apogeedigital.com/support/symphony-io

1. Connect Symphony I/O to your Mac's USB with the USB cable that was included with the Symphony I/O. Connect Symphony I/O to your Symphony 64 ThunderBridge or PCIe card if you're going to be using it in Symphony mode. Power up Symphony I/O.
2. Download the [Symphony I/O Release 5.3 installer package](#) and run the Symphony software installer. Restart your Mac.
3. After your Mac restarts, click 'Yes' to choose Symphony 64 (ThunderBridge or PCI card) for Mac sound input and output.

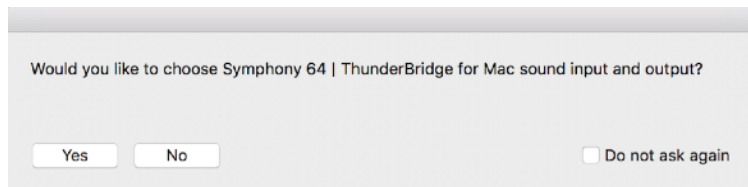

4. If you receive a 'firmware mismatch' dialog that says your Symphony I/O's firmware is not up-to-date, the firmware will need to be updated on a Mac running Mac OS 10.10.5 or below. **Never attempt a "force-update" if the firmware is already up to date. Doing this risks something going wrong during the update.**

While Symphony I/O hardware/software is fully compatible with Mac OS 10.9.5 and higher, Symphony I/O firmware can only be updated using Mac OS 10.10.5 or lower. The Symphony I/O an OS higher partition or Firmware Updater is not compatible with Mac OS 10.11 or higher. If your Mac is on than 10.10.5, you will need to install the Symphony I/O software on either another another Mac that is running OS 10.10.5 or lower.

There is NO NEED to run the Symphony 64 ThunderBridge Firmware Updater. There has only ever been one version of firmware released for the ThunderBridge and that is the version it has always shipped with.

5. If firmware is up-to-date, Launch Audio MIDI Setup (Applications> Utilities> Audio MIDI Setup).

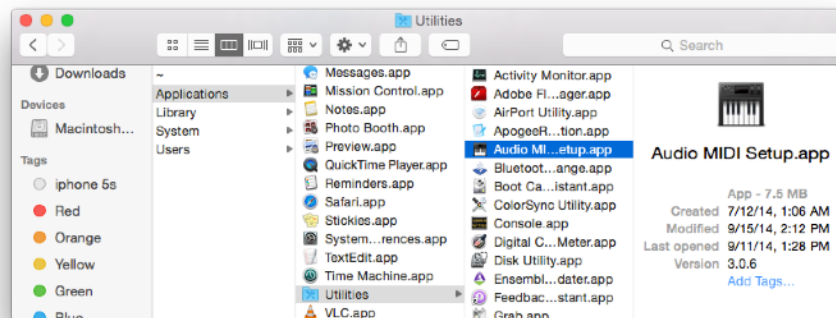



- In Audio MIDI Setup, make sure that 'Symphony64' (PCIe or ThunderBridge) is selected in the left-side column. In the 'Source' menu on the right, choose 'Port 1: 32ch' if you are using 1 Symphony I/O. Quit Audio MIDI Setup and restart the computer. Try to use Audio MIDI Setup instead of System Preferences Sound from now on, as it is very easy to accidentally select the wrong port setting in System Preferences Sound.

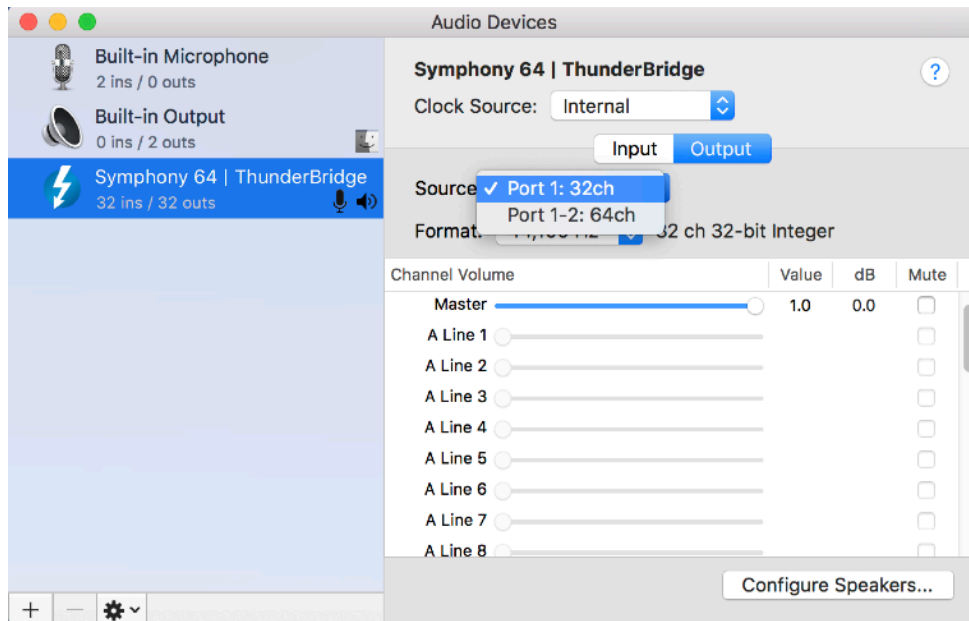

There should no longer be an exclamation mark (!) icon on the Symphony I/O's front panel and the status LEDs on the Symphony 64 (ThunderBridge or PCI) should now be solid green (ThunderBridge) or solid blue and white (PCI).

If not, please go back to page 28 and double-check every step.

Software Setup

Playback from iTunes

Note: Analog Outputs 1-2 will default to a level of -20dB. It is recommended to turn the level down all the way and gradually bring it up when connecting speakers and playing audio for the first time.

If you are going to use an external monitor controller or console and would like Analog Outputs 1-2 to be at line-level like the other outputs, you can either turn them up to 0dB by using the left-side front-panel encoder knob to select the speaker icon and then using the right-side front-panel encoder knob to raise the level to 0dB. You could also do this in the Apogee Maestro app by going to the Output tab, scrolling over to the right, and raising the level to 0dB with the Main output's software knob or changing the output format from Speaker to Line.

With 'Symphony64 (ThunderBridge or PCI)' selected as your Mac's default audio input and output, open Apple iTunes and play an audio selection. Using the front panel left hand encoder, select the speaker or headphone icon; use the right hand encoder to adjust the playback level of the selected output.



Select Symphony in your DAW

Most professional applications have their own audio preferences that are separate from Audio MIDI Setup or the Mac System Preferences. Basic steps for setting up Symphony are provided. For more detail on this topic, refer to the documentation that comes with your recording program.

Select Symphony in Logic Pro

1. Go to Logic Pro X > Preferences > Audio.

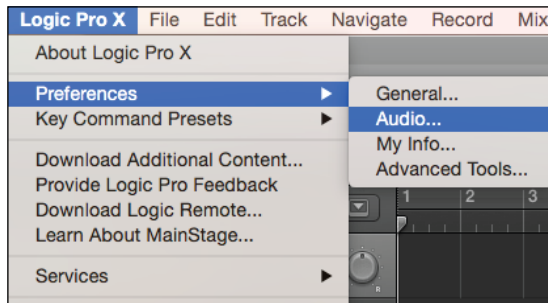

2. In the Devices Tab, select **Symphony 64 | ThunderBridge** (or PCI) in the Output and Input Device drop-down boxes.

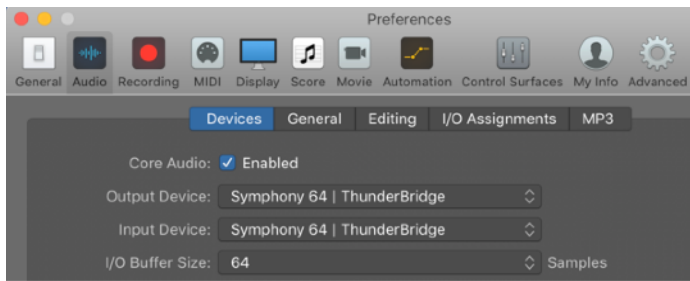

3. Start by setting the I/O Buffer Size to “64 Samples”. This setting may need to be adjusted based on your computer’s performance.
4. Select “Apply Changes” and close the Preferences window.

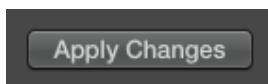

5. By selecting Symphony’s input and output labels that have been provided by its driver in Logic, the labels you see in Logic’s Channel Strip input and output slots correspond exactly to Symphony I/O’s hardware inputs and outputs, making I/O assignment much easier.

- a) In Logic, choose Mix > I/O Labels

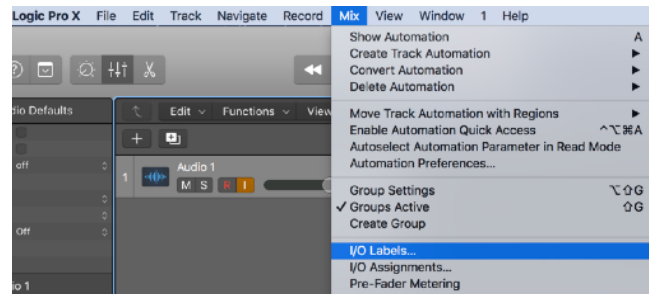

- b) Type Command-A to Select All
- c) Select the labels in the Provided by Driver column by clicking any of the circles in that column.

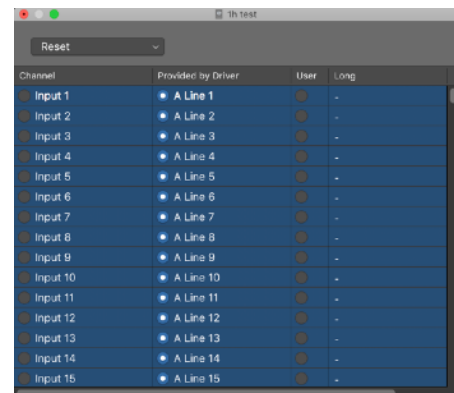

- d) Close the I/O Labels window

Select Symphony in Pro Tools

1. Go to Setup > Playback Engine.

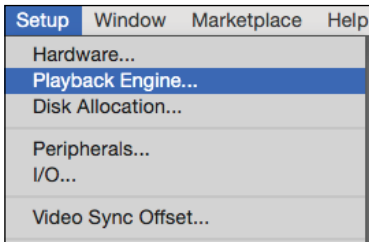

2. In the Playback Engine drop-down box, select **Symphony 64 | ThunderBridge** (or PCI) and uncheck the box next to "Ignore Errors During Playback/Record".

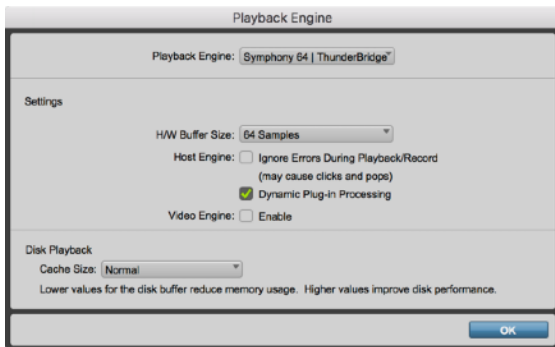

3. Start by setting the H/W Buffer Size to "64 Samples". This setting may need to be adjusted based on your computer's performance.

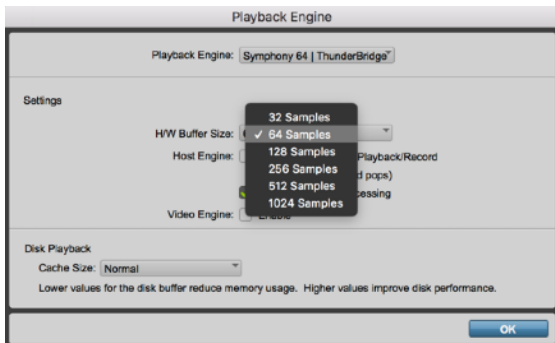

4. Select OK.

5. By selecting the Symphony's input and output labels that have been provided by its driver in ProTools, the labels you see in Pro Tools' Channel Strip input and output slots correspond exactly to Symphony I/O's hardware inputs and outputs, making I/O assignment much easier.

- a) In Pro Tools, choose Setup > I/O

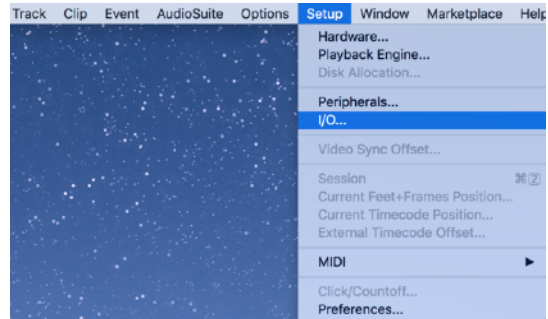

- b) In the I/O Setup window, click on the Input tab in the upper left and then click the 'Default' button in the lower left. Now do the same thing for the Output, Bus, and Insert tabs.

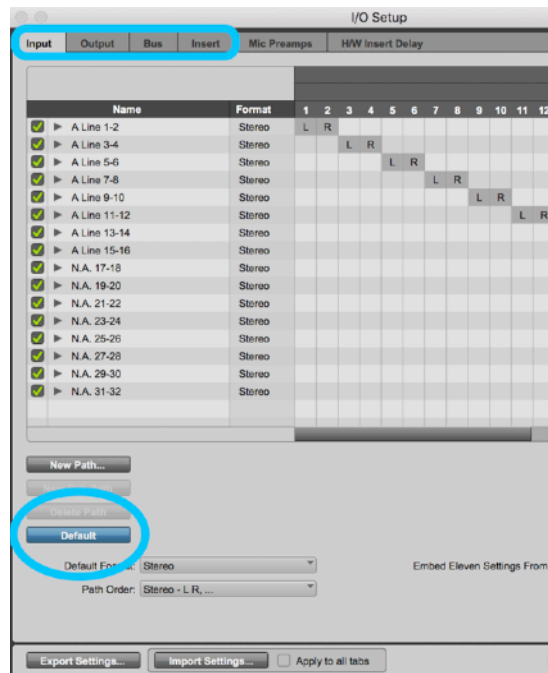

- c) Select OK.

Monitoring the Input Signal

Using your DAW to Monitor

By default, Symphony is configured for your recording software or DAW to perform the monitoring duty of passing your input signal on to your output.

Enable Input Monitor in Logic Pro X

1. Open Logic Pro X > Preferences > Audio

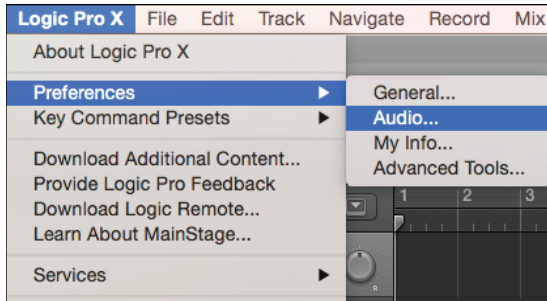

2. Make sure the Software Monitoring is checked in the Preferences > Audio > Devices menu.



3. Select the “I” button in each track you’d like to input monitor.

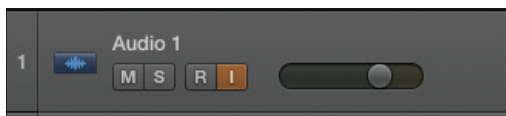

Enable Input Monitor in Pro Tools

- In Pro Tools Native, record enable the track to activate input monitoring.



- In Pro Tools HD, the “I” button enables input monitoring.



This concludes the Getting Started portion for **Symphony** AIM.

The next three sections of the User's Guide contain:



Pro Tools HD AIM (page 39)



USB AIM (page 45)



StandAlone AIM (page 52)

If you don't need to set up your Symphony I/O in any of the three additional AIMS and would like to skip ahead to the other parts of the User's Guide, you can go to:

Maestro - Control software for Symphony I/O's parameters and routing (page 54)

Calibration - Instructions for calibrating Symphony I/O (page 75)

Troubleshooting/FAQ - (page 84)



Pro Tools HD AIM

Pro Tools HD AIM Requirements

Requirements when connecting to Avid Pro Tools PCI cards:

- Avid Pro Tools HDX, HD Native (PCI card or Thunderbolt box), HD Core, HD Process, HD Accel, or HD Accel Core card installed in a computer in accordance with the Pro Tools HD Compatibility Grids, available at www.avid.com
- Using Symphony I/O with HDX or HD Native (PCI card or Thunderbolt box) requires either a mini-DigiLink to Female DigiLink adapter and a PC32 (DigiLink) cable or a PC32 (DigiLink) to Female mini-DigiLink adapter and a mini-DigiLink cable.
- Pro Tools 8.1, 9.0 or greater, 10.0 or greater, 11.0 or greater, 12.0 or greater, Pro Tools Ultimate 2018 or greater.

Note- Pro Tools HD version 12.6 and greater requires a [DigiLink I/O license](http://www.avid.com/licenses/pro-tools-digilink-io-license) to use 3rd-party interfaces. Information available at <http://www.avid.com/licenses/pro-tools-digilink-io-license>

Digital audio and clock configuration data, such as the session sample rate and hardware clock source, is transmitted via the PC-32 cable (referred to as a DigiLink cable in Pro Tools documentation). Software control data between Symphony I/O and [Apogee Maestro software](#) is transmitted via a USB connection.

Requirements for connecting to USB for software control from Apogee Maestro:

- mac OS Mavericks 10.9.5 or greater (64-bit and 32-bit kernel modes)
- 4GB minimum RAM, 8GB recommended
- USB port (2.0, 3.0, 3.1, or USB-C with an Apple USB-C to USB 2.0 adapter)

Connect Symphony I/O's USB port to a USB port on your Apple Mac to set these parameters in Maestro:

- Calibration
- Meter Configuration
- Digital I/O format
- Mic Pre settings such as phantom power, high pass (if a Mic Pre I/O Module is installed)

Once settings have been completed, USB may be disconnected, as it's not required for operation with Pro Tools.

These Symphony I/O parameters may be set using the front panel encoders:

- Speaker and Headphone Output Levels;
- Mic Pre Input gain (if a Mic Pre I/O Module is installed).

These parameters are set from Pro Tools software:

- Clock Source and Sample Rate;
- Audio routing.

Getting Started

Before powering on, ensure that any speakers or amplifiers connected to Symphony's analog outputs are powered off, or the volume turned down to the minimum setting. This will prevent potential damage to your speakers and other equipment from “pops” that may occur as the unit boots up.

1. **Power off speakers**
2. **Power Symphony On**
3. **Power on speakers.**

Likewise, before powering Symphony off, ensure any speakers or amplifiers connected to Symphony's analog outputs are powered off, or the volume turned down to the minimum setting.

4. **Power off speakers**
5. **Power Symphony Off**

Making Connections

In **Pro Tools HD** AIM, each i/o module installed in the Symphony I/O will emulate one Avid HD I/O- example: a Symphony I/O with an 8x8 module installed in the Primary slot and a 16x16 module installed in the Secondary slot will appear as two Avid HD I/Os in Pro Tools HD/Ultimate.

- Using a either a Pro Tools regular DigiLink cable and a mini-DigiLink to Female DigiLink adapter or a PC32 (DigiLink) to Female mini-DigiLink adapter and a mini-DigiLink cable, connect the Symphony I/O's **Main** port directly to a port on your HDX or HD Native card.

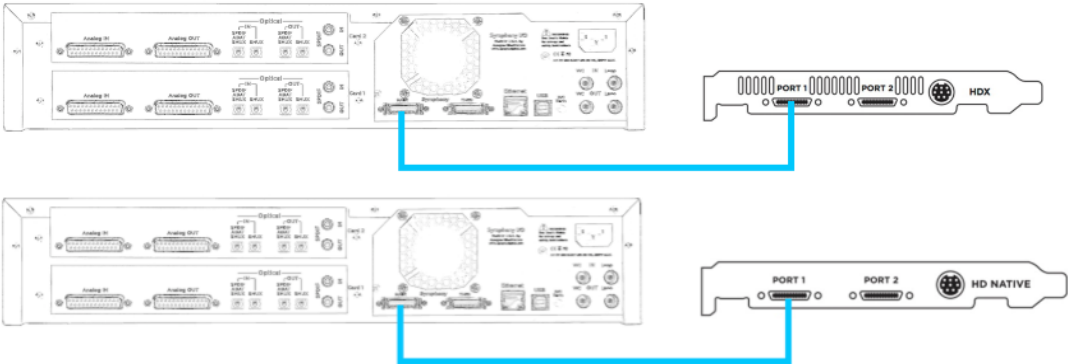

- Use a regular DigiLink cable (PC32) to connect the Symphony I/O's **Main** port to an HD Core or Accel card.

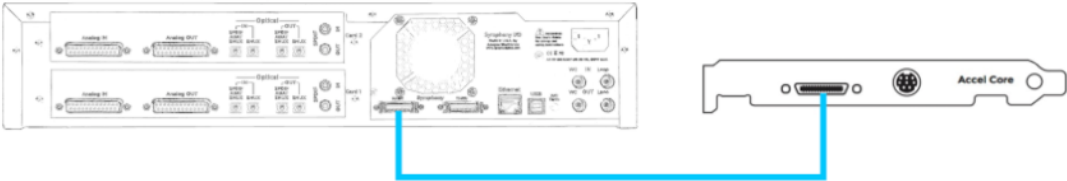

- Do not daisy chain Symphony I/O with other units. This includes Avid interfaces. Avid interfaces and Symphony I/O interfaces must be connected to separate ports.

✓ YES

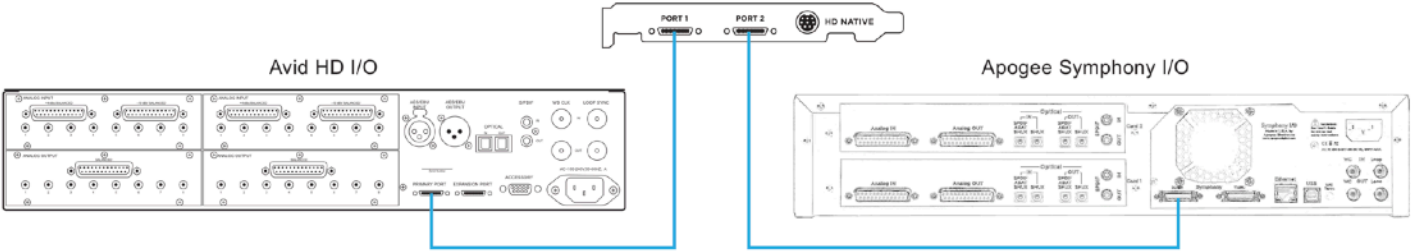

✗ NO

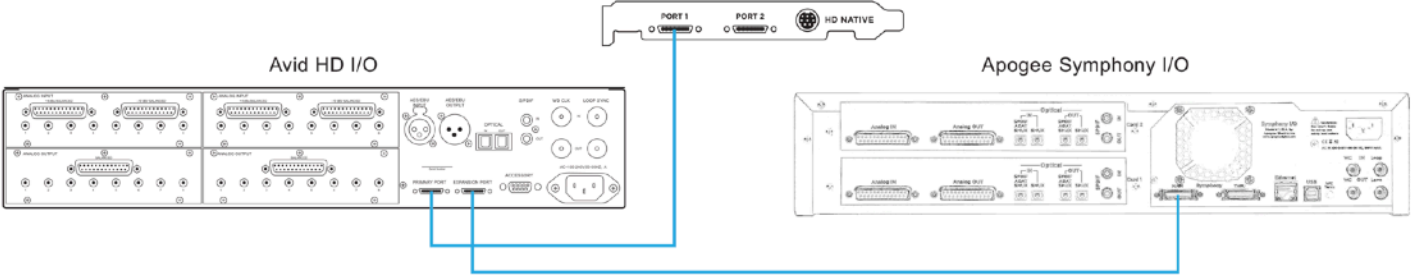

Setup Steps

Apogee software is not required to use Symphony I/O in Pro Tools HD AIM. Clock source, sample-rate and routing are all set from the Pro Tools software. Control over any other parameters can be done by installing 'Apogee Maestro' and connecting your Symphony I/O to your Mac via USB (if using Pro Tools on a PC, the Symphony can still be connected to a Mac via USB for software control through Apogee Maestro).

Use Apogee Maestro for controlling the following parameters:

- analog and digital calibration for inputs and outputs
- soft-limit for analog inputs
- front-panel metering behavior
- configuring the Symphony I/O for 'Star-clocking' by unchecking 'Use Loop Sync' box (we recommend using Loop Sync, as the system will run more smoothly with the Pro Tools software).
- headphone assignment
- SPDIF Coax i/o assignment

[To install Apogee Maestro, download and install the latest Symphony Release package.](#)

A Symphony I/O in Pro Tools HD mode is compatible with the following:

- HDX
- HD Native
- HD Native Thunderbolt box
- HD Accel
- HD Process
- HD Core

For the steps below, we will refer to whichever HD card(s) or HD Native Thunderbolt box you're using as 'the HD card'.

1. Confirm that you have **Pro Tools HD v8.1.1 or higher** (all versions from 8.1.1 up to the current- 2018 'Ultimate' at the time of this writing- are supported) installed on your Mac or PC, along with the applicable HD driver (a separate install) and a connected iLok with HD license. You will also need a **DigiLink I/O license** to use 3rd-party interfaces. Information available at <http://www.avid.com/licenses/pro-tools-digilink-io-license>
2. If you're using more than one Symphony I/O, make sure the unit that's going to be connected to Port 1 has two I/O modules installed, as explained in greater detail [here](#).
3. Power up the Symphony I/O and make sure it's in **Pro Tools HD AIM** by pushing in and holding on the right-side front-panel encoder knob and scrolling through the different modes with the knob until you get to 'Pro Tools HD' and then push in on the knob again to restart the unit in **Pro Tools HD AIM**.





4. You can not daisy-chain Symphony I/Os off of Avid interfaces or other Symphony I/Os. Since the Symphony I/O can contain 32 channels of I/O in one unit, it needs a dedicated port on the HD card. Connect the first Symphony I/O to Port 1 of the HD card (if you're using an Avid or Digi interface and you already have it connected to Port 1, you can connect the Symphony to Port 2 of the HD card). Connect any additional Symphony I/Os to the next port on the HD card(s). Keep in mind that each Symphony I/O will need its own port on any HD card (refer to diagrams on page 42).
5. **If you are using only one Symphony I/O and no other Avid or Digi interfaces, you can skip to the next step.** If you're using multiple interfaces, you will need to connect them all via Loop Sync, using BNC cables. Connect the Loop Sync output of the 1st interface to the Loop Sync input of the 2nd interface. Connect the Loop Sync output of the 2nd interface to the Loop Sync input of the 3rd interface and so on. Once you come to the last interface in the chain, send its Loop Sync output to the Loop Sync input of the 1st interface. If you're using a Digi Sync I/O or an Avid Sync HD, you would do the same thing, except you would treat the Sync I/O or Sync HD as the 1st interface and start by sending its Loop Sync output to the Loop Sync input of the 2nd unit and so on until you bring the Loop Sync output of the last unit in the chain to the Loop Sync input of the Sync I/O or Sync HD. Your Sync I/O or Sync HD must be connected to your HD card using the serial cable that was included with it to use it.
6. Make sure all Symphony I/Os and any other HD interfaces are connected properly and powered up and then launch Pro Tools.
7. After Pro Tools has launched, click on the 'Setup' menu in Pro Tools and select 'Playback Engine'. Confirm that HD, HDX, or HD Native is selected as the 'Current Engine'. If it's not, select it and click 'OK'. If it wasn't already selected in the Playback Engine and you had to select it, you will need to quit/relaunch Pro Tools after doing so.
8. Click on the 'Setup' menu in Pro Tools and select 'Hardware'. Confirm that the expected interfaces show up in the correct order under the 'Peripherals' column in the upper left-side corner. Keep in mind that each I/O module in a Symphony I/O will show up as one Avid HD I/O. The clock source dropdown menu in the Pro Tools Hardware page is where you would set the Symphony's external clock source if you weren't using Internal. Click 'OK' to exit.
9. **If you are not using a Sync I/O or Sync HD, you can skip to the next step.** If you are using a Sync I/O or Sync HD, click on the 'Setup' menu in Pro Tools and select 'Peripherals' and go to the 'Synchronization' tab. Under 'Synchronization Device', select 'Enable Sync HD'. Keep in mind that the older Sync I/O (blue) will not work with Pro Tools 11 and higher. If you're using Pro Tools 11 or higher, you will need to use a Sync HD (blue or gray and says 'HD' on it).
10. Click on the 'Setup' menu in Pro Tools and select 'I/O'.
11. Once the I/O Setup opens, select all of the channels in the left-hand column and hit 'Delete' on your keyboard. After you've deleted them, click the 'Default' button in the lower part of the screen and confirm that the "Compensate for delays..." checkbox is checked. Follow the same steps for the input, output, bus, and insert tabs in I/O Setup. Once you have gone through these steps in each tab, click the 'OK' button to confirm changes and exit.

You are now ready to use Symphony I/O with Pro Tools HD.

Keep in mind that the first 2 analog outputs of Symphony I/O will default to a -20dB level for using the Symphony I/O as a monitor controller.

If you're using an external monitor controller and would like all the Symphony I/O's outputs to be at 0dB line level, first make sure your external monitor controller is turned down all the way. There are two ways to set the main first 2 analog outputs to 0dB Line Level:

- You can raise or lower the level of outputs 1-2 from the front-panel by using the left-side knob to set the control for speaker (the speaker icon will be visible) and then using the right-side knob to raise the level to 0dB (make sure you're not setting the headphones to 0dB).
- You can launch 'Apogee Maestro' from your Applications folder if you are connected to the Mac via USB, go to the 'Output' tab, scroll all the way to the right until you see the Main Output control knob (with the speaker icon), and click on the drop-down menu and change the selection to 'Line'.

If you would like to change the headphone routing on the Symphony I/O, you will need to launch 'Apogee Maestro' from your Applications folder and go to the 'Output' tab. Scroll all the way to the right until you see the 2 headphone level knobs. Click on the drop-down menus next to them and you will see a list of all the available outputs you can send to the headphones.

This concludes the Getting Started portion for **Pro Tools HD** AIM.

The next two sections of the User's Guide contain:



USB AIM (page 45)



StandAlone AIM (page 52)

If you don't need to set up your Symphony I/O in USB or Standalone AIMS and would like to skip ahead to the other parts of the User's Guide, you can go to:

Maestro - Control software for Symphony I/O's parameters and routing (page 54)

Calibration - Instructions for calibrating Symphony I/O (page 75)

Troubleshooting/FAQ - (page 84)



USB AIM

USB AIM Requirements

Requirements when using as a USB Audio interface with a Mac:

- mac OS Mavericks 10.9.5 or greater (64-bit and 32-bit kernel modes)
- 4GB minimum RAM, 8GB recommended
- USB port (2.0, 3.0, 3.1, or USB-C with an Apple USB-C to USB 2.0 adapter)

Note: When a Symphony I/O is in USB AIM, it can use a max of 16 inputs and 16 outputs. This is important to note, in case you have two i/o modules installed and you don't have access to some or all of on the second module. You are able to prioritize your i/o by customizing the routing in Apogee

your i/o

Maestro- for example, if you had two 8x8 modules installed and wanted to use all 16 analog in and out, but the first 16 channels default to the 16 channels on the first include 8 analog i/o and 8 digital i/o. You could change the routing to use use the first and second modules instead of using any digital channels. See the Routing Maestro section on pages 66-67 for instructions on how to do this after section below.

channels of
module, which
8 analog i/o from the
part of the Apogee
you finish the Getting Started

Getting Started

Download and Install Software

Before Symphony I/O will be recognized by your Mac, you must download & install the latest Symphony I/O Software from Apogee's website: www.apogeedigital.com/support/symphony-io

1. Connect Symphony I/O to your Mac's USB with **the USB cable that was included with the Symphony I/O**.
2. Download the [Symphony I/O Release 5.3 installer package](#) and run the Symphony software installer. Restart your Mac.



3. After your Mac restarts, click 'Yes' to choose **Symphony I/O : USB** for Mac sound input and output.

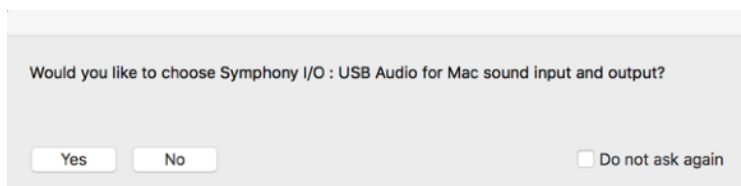

4. If you receive a 'firmware mismatch' dialog that says your Symphony I/O's firmware is not up-to-date, the firmware will need to be updated on a Mac running Mac OS 10.10.5 or below. **Never attempt a "force-update" if the firmware is already up to date. Doing this risks something going wrong during the update.**

While Symphony I/O hardware/software is fully compatible with Mac OS 10.9.5 and higher, Symphony I/O firmware can only be updated using Mac OS 10.10.5 or lower. The Symphony I/O Firmware Updater is not compatible with Mac OS 10.11 or higher. If your Mac is on an OS higher than 10.10.5, you will need to install the Symphony I/O software on either another partition or another Mac that is running OS 10.10.5 or lower.

There is NO NEED to run the Symphony 64 ThunderBridge Firmware Updater. There has only ever been one version of firmware released for the ThunderBridge and that is the version it has always shipped with. The Symphony 64 ThunderBridge isn't used with USB AIM anyway.

If firmware is up-to-date or if you never received a 'firmware mismatch', your Symphony I/O should now be ready to use in **USB** AIM.

There should no longer be an exclamation mark (!) icon on the Symphony I/O's front panel.



Software Setup

Playback from iTunes

Note: Analog Outputs 1-2 will default to a level of -20dB. It is recommended to turn the level down all the way and gradually bring it up when connecting speakers and playing audio for the first time.

If you are going to use an external monitor controller or console and would like Analog Outputs 1-2 to be at line-level like the other outputs, you can either turn them up to 0dB by using the left-side front-panel encoder knob to select the speaker icon and then using the right-side front-panel encoder knob to raise the level to 0dB. You could also do this in the Apogee Maestro app by going to the Output tab, scrolling over to the right, and raising the level to 0dB with the Main output's software knob or changing the output format from Speaker to Line.

With **Symphony I/O : USB** selected as your Mac's default audio input and output, open Apple iTunes and play an audio selection. Using the front panel left hand encoder, select the speaker or headphone icon; use the right hand encoder to adjust the playback level of the selected output.

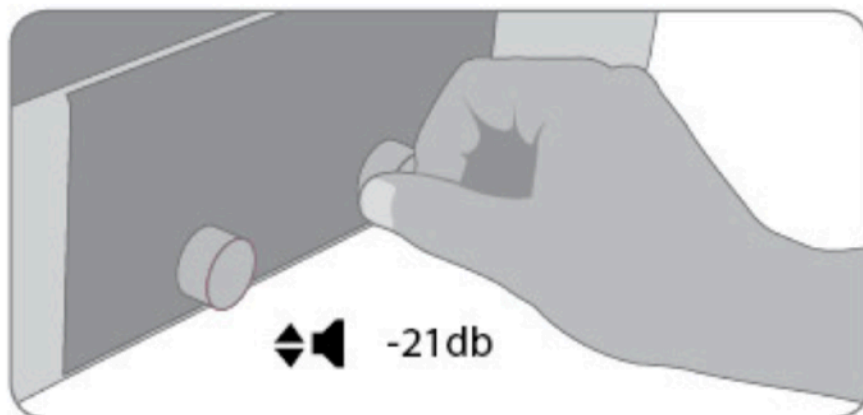



Select Symphony in your DAW

Most professional applications have their own audio preferences that are separate from Audio MIDI Setup or the Mac System Preferences. Basic steps for setting up Symphony are provided. For more detail on this topic, refer to the documentation that comes with your recording program.

Select Symphony in Logic Pro X

- 1. Go to Logic Pro X > Preferences > Audio.

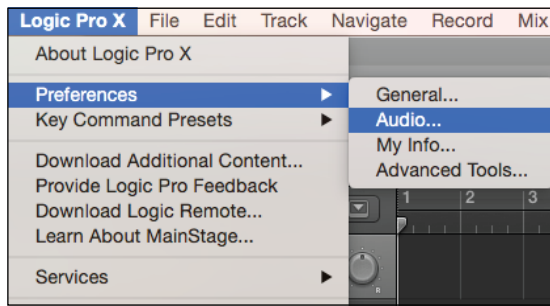

- 2. In the Devices Tab, select **Symphony I/O : USB Audio** in the Output and Input Device drop-down boxes.

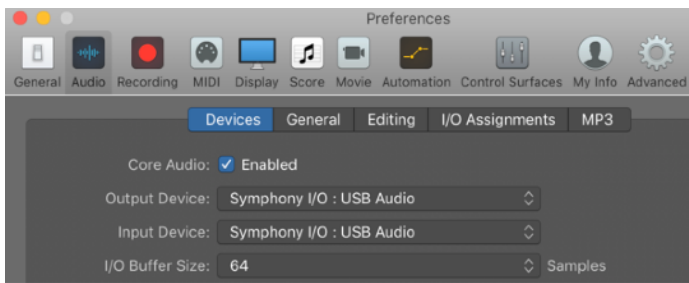

- 3. Start by setting the I/O Buffer Size to “64 Samples”. This setting may need to be adjusted based on your computer’s performance.
- 4. Select “Apply Changes” and close the Preferences window.

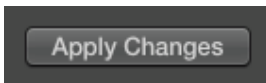

- 5. By selecting the Symphony I/O’s input and output labels that have been provided by its driver in Logic, the labels you see in Logic’s Channel Strip input and output slots correspond exactly to Symphony I/O’s hardware inputs and outputs, making I/O assignment much easier.

- a) In Logic, choose Mix > I/O Labels

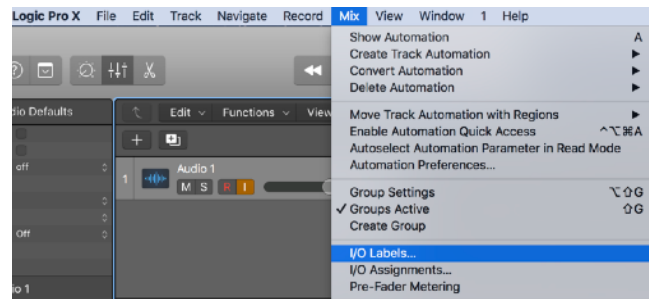

- b) Type Command-A to Select All
- c) Select the labels in the Provided by Driver column by clicking any of the circles in that column. Close the I/O Labels window

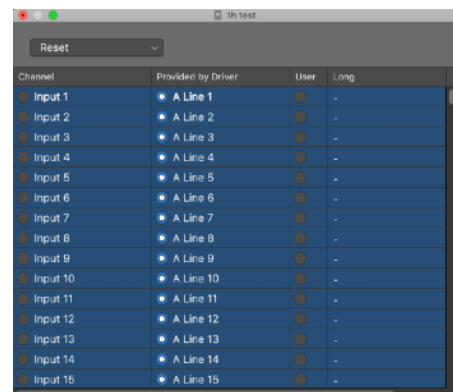



Select Symphony in Pro Tools

- 1. Go to Setup > Playback Engine.

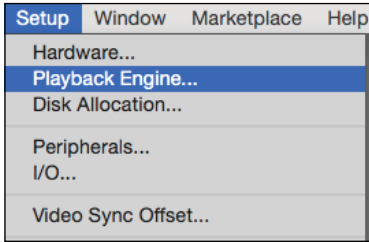

- 2. In the Playback Engine drop-down box, select **Symphony I/O : USB Audio** and uncheck the box next to "Ignore Errors During Playback/Record".

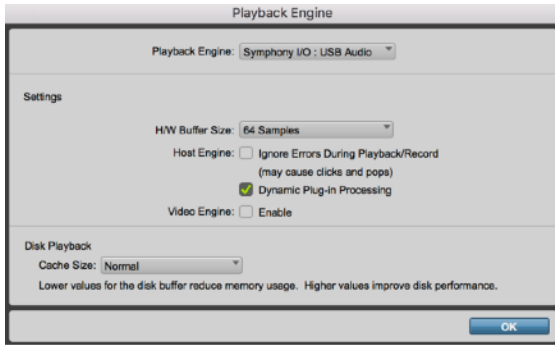

- 3. Start by setting the H/W Buffer Size to "64 Samples". This setting may need to be adjusted based on your computer's performance.

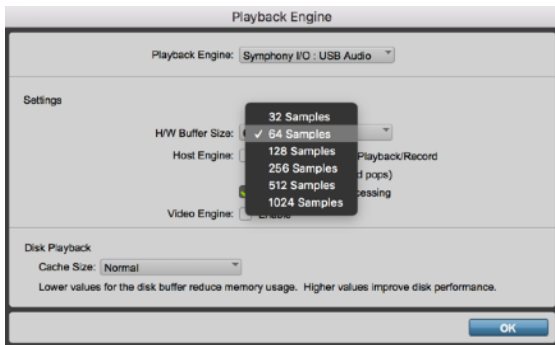

- 4. Select OK.

- 5. By selecting the Symphony I/O's input and output labels that have been provided by its driver in ProTools, the labels you see in Pro Tools' Channel Strip input and output slots correspond exactly to Symphony I/O's hardware inputs and outputs, making I/O assignment much easier.

- a) In Pro Tools, choose Setup > I/O

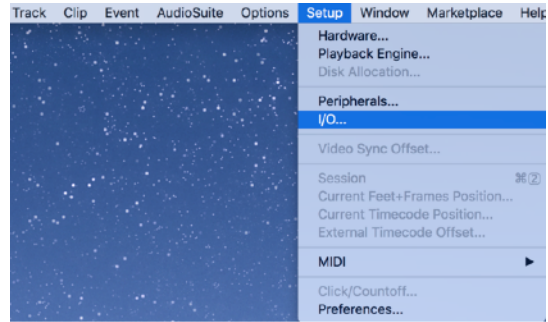

- b) In the I/O Setup window, click on the Input tab in the upper left and then click the 'Default' button in the lower left. Now do the same thing for the Output, Bus, and Insert tabs.

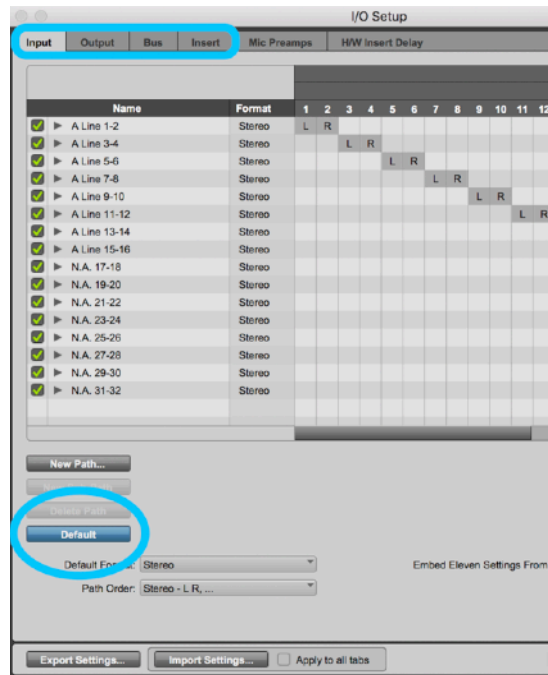

- c) Select OK.



Monitoring the Input Signal

Using your DAW to Monitor

By default, Symphony is configured for your recording software or DAW to perform the monitoring duty of passing your input signal on to your output.

Enable Input Monitor in Logic Pro X

1. Open Logic Pro X > Preferences > Audio

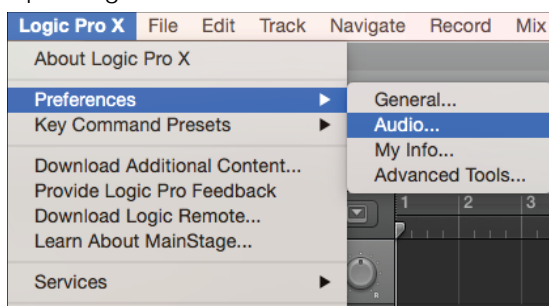

2. Make sure the Software Monitoring is checked in the Preferences > Audio > Devices menu.



3. Select the "I" button in each track you'd like to input monitor.

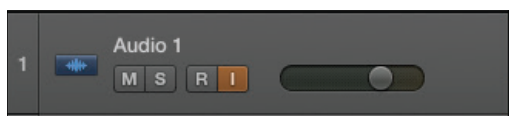

Enable Input Monitor in Pro Tools

- In Pro Tools Native, record enable the track to activate input monitoring.



- In Pro Tools HD, the "I" button enables input monitoring.





This concludes the Getting Started portion for **USB** AIM.

The next section of the User's Guide contains:



StandAlone AIM (page 52)

If you don't need to set up your Symphony I/O in Standalone AIM and would like to skip ahead to the other parts of the User's Guide, you can go to:

Maestro - Control software for Symphony I/O's parameters and routing (page 54)

Calibration - Instructions for calibrating Symphony I/O (page 75)

Troubleshooting/FAQ - (page 84)



StandAlone AIM

StandAlone AIM Requirements

In the case where the digital host system isn't computer-based (or is a computer-based system that interfaces with Symphony I/O using standard digital I/O such as AES or Optical), Symphony I/O's StandAlone mode offers the ability to route any I/O Module input to any I/O Module output. The most common StandAlone application is the use of Symphony I/O as a standalone A/D - D/A converter, where analog inputs are routed to the I/O Module's AES or Optical outputs and AES or Optical inputs are routed to analog outputs (A 16x16 Analog I/O module will simply default its routing to Analog In to Analog Out and vice versa). As soon as a Symphony I/O is put into **StandAlone** AIM, the StandAlone A/D-D/A routing is already routed so it's ready to use without any software.

Optional software control between Symphony I/O and Apogee Maestro software is transmitted via a USB connection. Connect Symphony I/O's USB port to a USB port on your Apple Mac to set these parameters in Maestro:

- Calibration
- Meter Configuration
- Digital I/O format
- Mic Pre settings such as phantom power, high pass (if a Mic Pre I/O Module is installed)
- Additional custom routing

Once settings have been completed, USB may be disconnected, as it's not required for StandAlone operation. These Symphony I/O parameters may be set using the front panel encoders:

- Sample rate and clock source
- Speaker and Headphone Output Levels;
- Mic Pre Input gain (if a Mic Pre I/O Module is installed).

If you need to use Apogee Maestro to adjust the additional parameters, here are the requirements for a USB-equipped Mac:

- mac OS Mavericks 10.9.5 or greater (64-bit and 32-bit kernel modes)
- 4GB minimum RAM, 8GB recommended
- USB port (2.0, 3.0, 3.1, or USB-C with an Apple USB-C to USB 2.0 adapter)



Getting Started

1. Power up the Symphony I/O and make sure it's in **StandAlone** AIM by pushing in and holding on the right-side front-panel encoder knob and scrolling through the different modes with the knob until you get to 'StandAlone' and then push in on the knob again to restart the unit in **StandAlone** AIM.



2. If you need to clock Symphony I/O externally and/or change the sample-rate while in **StandAlone** AIM, you can do so from the front-panel with these steps:
 - Press and hold the left hand encoder until the current clock source is shown on the OLED Display.
 - Turn the left-side encoder and select **INT** (Internal).
 - With **INT** still visible, turn the right-side encoder to select the desired sample-rate.
 - If you would like to clock the Symphony externally, turn the left-side encoder to select the desired clock source if you would like it to be external. Otherwise, push in either encoder knob to confirm selections.
 - When selecting 'Digital' for external clock source, turn the right-side encoder to select the digital input you want to use.
 - Push in either encoder knob to confirm the new clock source selection.
3. You are now ready to use Symphony I/O as a Standalone converter. As stated on the previous page, Symphony I/O doesn't require any software when it's in **StandAlone** AIM, but if you would like to adjust some additional parameters, such as calibration or digital i/o format, you will need to download the [Symphony I/O Release 5.3 installer package](#), run the Symphony software installer, and restart your Mac.
5. Connect Symphony I/O to your Mac's USB **with the USB cable that was included with the Symphony I/O** and launch Apogee Maestro, which is covered in the next section.

Maestro

Apogee Maestro is a controller software for your Symphony I/O. Though you do not need Maestro open to use your Symphony I/O, it provides access to all of Symphony's settings and parameters. Its level meters are also a useful diagnostic tool to see which inputs and outputs are receiving and sending signal. Maestro can be used in all four AIMs.

Maestro Features

While only basic settings may be made from the front panel controls, all Symphony features are available and can be controlled from Apogee Maestro software.

Devices Sidebar

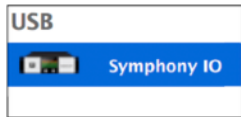

Any Maestro-compatible Apogee interface connected to the host computer is displayed in the Devices sidebar. Hardware settings are displayed by first selecting one or more interfaces in the Devices sidebar and then clicking on a tab.

Device Icon and ID Button



A device icon and ID button is placed adjacent to each row of parameters to identify the hardware unit to which the row belongs. By clicking on the ID button, the corresponding hardware unit's front panel will illuminate. Each hardware unit is assigned a Peripheral Prefix (A-Z, found in Maestro's Device Settings tab window) which is displayed on the ID button.

Toolbar

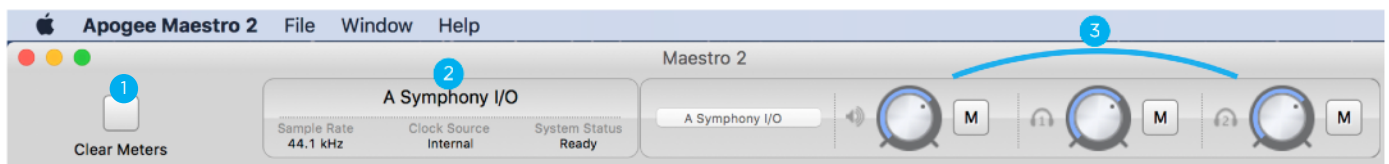

1. Clear Meters

This button clears all held peak and over indications on all hardware and software meters.

2. System Status

This window displays the sample rate, clock source, and system status of the currently selected system. A system status of "Ready" indicates that all detected units are properly connected and clocked

3. Toolbar Monitor Controls

These controls offer immediate access to one peripheral's speaker and headphone volume controls, regardless of the Devices Sidebar selection.

Input Tab Window

Settings for Symphony's analog and digital inputs are found in the input tab.

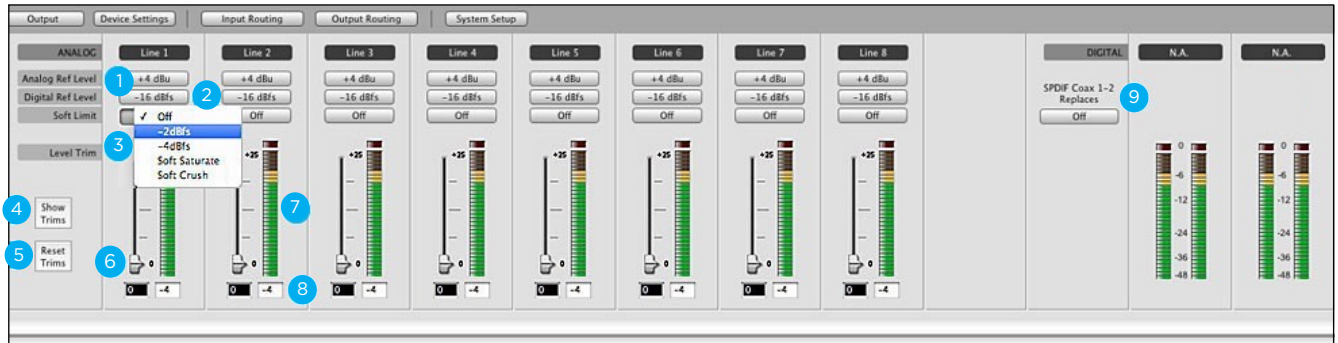

1. **Analog Level**
 - Use this drop down menu to choose the analog level for each A/D conversion channel.
 - Option+click any channel to set the reference for all channels**
 - Choose **+4dBu** when connecting to “pro” gear, such as an external mic pre, compressor, or EQ, with outputs at a +4dBu nominal level.
 - Choose **-10dBV** when connecting to “semi-pro”, hi-fi, or musical instrument gear with outputs at a -10 dBV nominal level.
 - When an optional Mic Pre Module is installed, the following entries become available:
 - Choose **Mic** when connecting microphones or direct boxes, or any devices that needs to run through a microphone preamplifier.
 - Choose **Inst** when connecting a guitar or keyboard, or any high impedance (Hi-Z) instrument to the 1/4” input (balanced TRS or unbalance TS). The signal is sent through a Hi-Z to Low-Z conversion circuit before sent through the microphone preamplifier circuit.
2. **Digital Ref Level**
 - When Analog Level is set to +4 dBu or -10 dBV, use this pop-up menu to choose the digital reference level for each A/D conversion channel.
 - Option-select any channel to set the digital reference for all channels**
3. **Soft Limit**
 - Choose from 4 analog input limiting selections. (On 16x16 modules, select “On” to engage. This option begins to attenuate transient peaks at a threshold of -4dBfs)
4. **Show/Hide Trims**
 - Click this button to display or hide all Trim faders.
5. **Reset Trims**
 - Click this button to reset all Trim faders.
6. **Trim Fader**
 - Once the desired reference levels have been chosen, click Show Trims, then use the Trim Fader to precisely trim the A/D conversion level within +/- 0.1 dB. Note that numerical values may be entered directly in the Trim level readout. Press Tab to advance to the adjacent Trim level readout for entering values.
7. **A/D Converter Meter**
 - This meter displays the level of the input after A/D conversion in the range -48 to 0 dBfs.
8. **Meter Level Readout**
 - This indicator provides an accurate reading of the analog input meter to an accuracy of 0.1 dB. The reading is used primarily to calibrate the A/D converter stage with a steady input tone.
9. **S/PDIF Replaces**
 - To use the S/PDIF Coax input, it's necessary to select another analog or digital channel pair which the S/PDIF Coax input will replace on the Input Routing grid. Use this drop down menu to select the channel pair to be replaced.

Mic Pre Module Input Tab Window

When a Mic Pre I/O Module is installed and Analog Level is set to Mic or Instrument, the following additional controls become available:

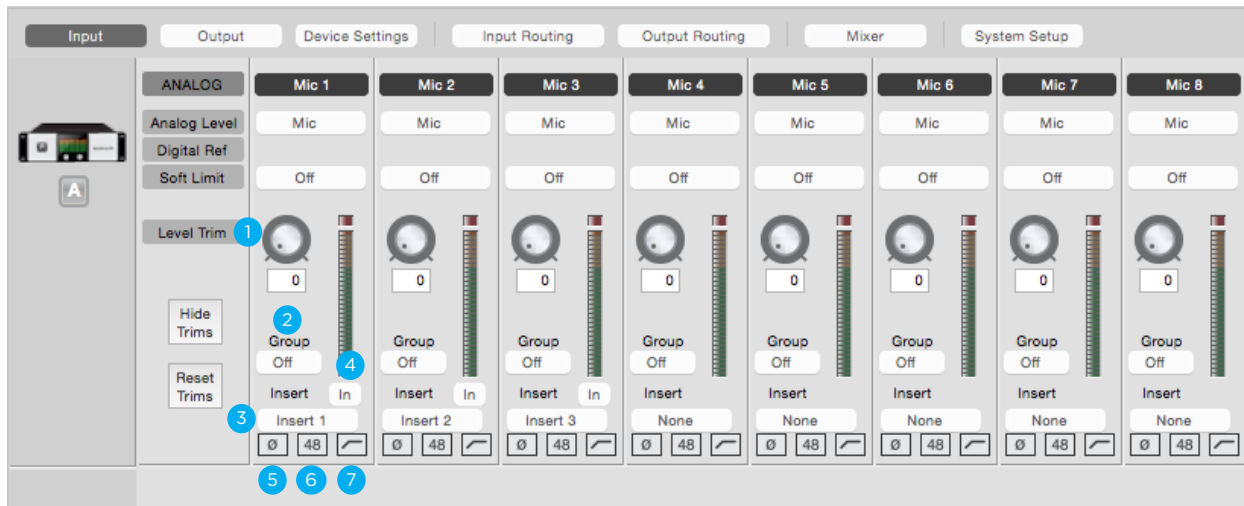

- 1. Level Trim** - Use this knob to adjust the gain of the mic pre.
- 2. Group** - Use this drop down to choose a Level Trim group, for controlling the Level Trim of multiple inputs simultaneously. Any level offset that exists before inputs are grouped will be preserved after a group is chosen.
- 3. Insert Select** - Use this drop down to insert one of the eight rear panel send/return pairs into the input signal path. Insert labels may be customized in the Device Settings tab window. The insert point occurs after the mic pre and high pass filter and before the A/D conversion stage.
- 4. Insert In** - Use this button to enable the Insert Return. The Insert Sent is always active once an insert is selected. Thus, the Insert Sent may be used as an analog direct out when an insert is selected but the In button isn't depressed.
- 5. Polarity** - Use this button to invert the polarity of the input signal.
- 6. 48** - Use this button to enable 48 volt phantom power on the corresponding Analog IN channel. Condenser mics require 48 volt phantom power to operate.
- 7. High Pass** - Use this button to engage an 80Hz high-pass filter on the input.

Output Tab Window

Settings and controls for Symphony's analog and digital outputs are found in the Output tab.

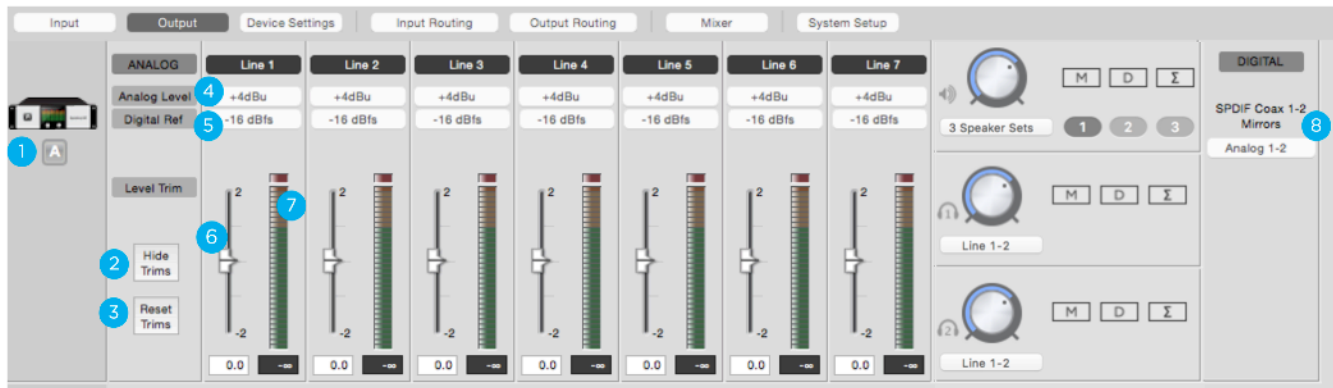

- 1. Device Icon & ID Button** - Use this drop down menu to choose the analog level for each D/A conversion channel.
Option+Select any channel to set the reference for all channels.
 - Choose **+4dBu** when connecting to 'pro' gear with inputs at a +4dBu nominal level.
 - Choose **-10dBV** when connecting to 'semi-pro', hi-fi, or musical instrument gear with inputs at a -10 dBV nominal level.
- 2. Show/Hide Trims** - Displays or hides the Trim faders
- 3. Reset Trims** - Resets all Trim faders.
- 4. Analog Ref Level** - When calibrating Symphony I/O, use this drop down menu to choose the analog reference level for each D/A conversion channel. Option-select any channel to set the analog reference for all channels.
- 5. Digital Ref Level** - Use this pop-up menu to choose the digital reference level for each D/A conversion channel. Option-select any channel to set the digital reference for all channels.
- 6. Trim Fader** - Once the desired reference levels have been chosen, click Show Trims, then use the Trim fader to precisely trim the D/A conversion level within ± 0.1 dB. Please note that, because the D/A Meter displays the digital signal before conversion, it's necessary to measure the analog output with an external voltmeter when calibrating.
- 7. D/A Meter** - Displays the level of the output *before* D/A conversion.
- 8. S/PDIF Mirrors** - The S/PDIF coaxial output may be set to mirror (i.e. transmit in parallel) any of the analog or digital outputs pairs on the routing grid. Use this pop-up menu to select the output pair that is mirrored by the S/PDIF coaxial output.

Speaker & Headphone Controls

The following settings control the configuration and level of the rear panel analog outputs and front panel headphone output.

- 1. Speaker Level** - Controls the speaker output level.
- 2. Analog Out Format** - Sets the format of the analog outputs.

- **Line:** Output 1/2 are configured as line outputs. Functions such as level control, Mute, Dim, and Sum to Mono are disabled.
- **Stereo:** Output 1/2 are configured as speaker outputs (with all monitor functions available). Outputs 3-10 are configured as line outputs.
- **2 Speaker Sets:** Output 1/2 and outputs 3/4 are configured as two pairs of stereo outputs. Switch between the stereo pairs with the Speaker Select buttons. These outputs are adjusted simultaneously with the Output Controller knob.
- **3 Speaker Sets:** Output 1-6 are configured as three pairs of stereo outputs. Switch between the stereo pairs with the Speaker Select buttons. These outputs are adjusted simultaneously with the Output Controller knob.
- **5.1, 7.1:** Outputs are configured as speaker outputs, suitable for connection to a 5.1 or 7.1 (8x8 or 16x16 cards only) speaker system. These outputs are adjusted simultaneously with the Output Controller knob.

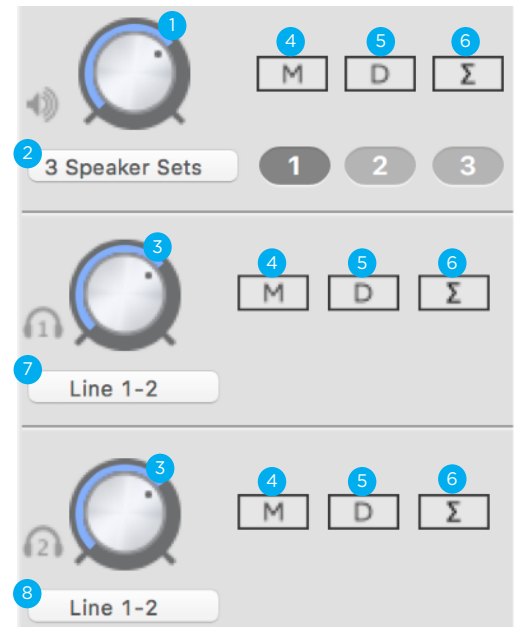

- 3. Headphone Level** Controls the output level of the corresponding headphone output.
- 4. Mute** Select "M" to mute the speaker or headphone output.
- 5. Dim** Select "D" to lower the speaker or headphone output level by 15dB. This function is a convenient for briefly lowering the playback volume in the speakers or headphones in order to hold a conversation without completely muting the output.
- 6. Sum to Mono** Select "Σ" to combine the left and right channels of the speaker or headphone outputs to mono. This function is useful to check mono compatibility of a stereo signal.
- 7. HP 1 Routing** Selects the software outputs you want routed to Headphone Out 1.
- 8. HP 2 Routing** Selects the software outputs you want routed to Headphone Out 2.

Monitor Control Center

Symphony I/O is equipped with several monitoring features to provide for your monitoring needs.

How to set the Monitor Outputs as a fixed Line-Out

This setting changes the Monitor Outputs from a variable volume controlled by the Output Controller knob to a fixed output at the full +4dBu or -10dBV reference level. This setting is convenient for connecting Symphony to an external monitor control device such as a mixer or control center.

1. Open Maestro and click the “Output” tab (or use the keyboard combination [⌘+2]).

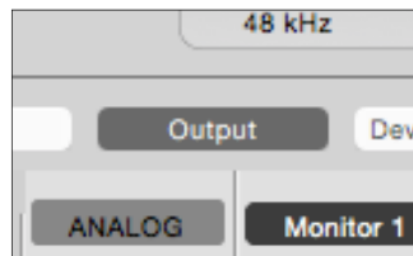

2. In the Speaker Output section all the way to the right of the window, click the Speaker Output drop-down box and select “Line”.

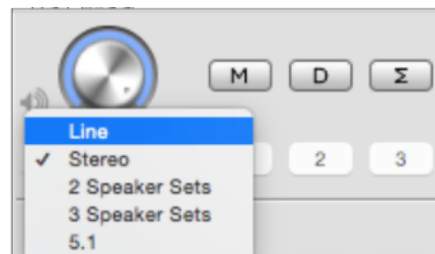

Note: This disables Symphony’s monitor functionality, including level control and mute.

How to Setup and Use Multiple Speaker Sets

It is possible to connect up to three pairs of speaker monitors and toggle between them. This is very useful to check how a mix sounds through different speakers and systems.

1. Connect the first pair of speakers to Monitor Out 1/2, the second pair to Line Out 3/4, and if desired a third pair to Line Out 5/6.
2. Open Maestro and click the “Output” tab (or use the keyboard combination [⌘+2]).

3. From the Speaker Output Select drop-down box, select “2 Speaker Sets” or “3 Speaker Sets”.

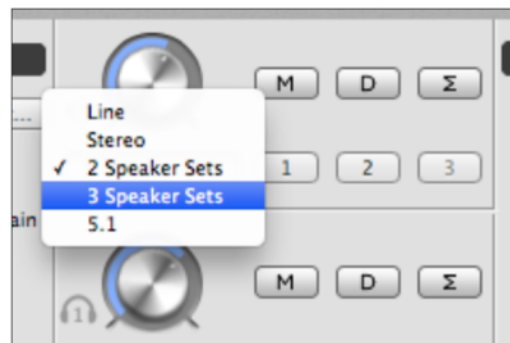

4. Click the Speaker Set 1, 2, or 3 button to select which speaker set is active.



Note: To activate multiple speaker sets simultaneously, hold down [command ⌘] and select another speaker set button.

How to connect & configure a Surround Speaker Setup

When using Symphony with a surround speaker setup, the first set of outputs can be configured as speaker outputs suitable for connection to a 5.1 or 7.1 speaker system depending on which module card is installed in slot 1. With this configuration, turning the Output Controller knob will adjust all applicable line-outputs simultaneously.

1. Connect your speakers to Symphony's outputs 1 - 6

A standard 5.1 surround setup is routed as follows:

- Output 1: Front Left
- Output 2: Front Right
- Output 3: Center
- Output 4: Sub-woofer
- Output 5: Left Surround
- Output 6: Right Surround

3. In the Speaker Output section, click the Speaker Output drop-down box and select "5.1"

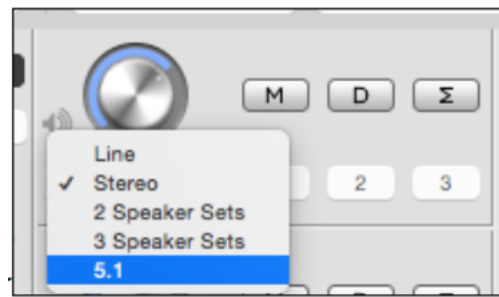

2. Open Maestro and click the "Output" tab (or use the keyboard combination [⌘+2]).

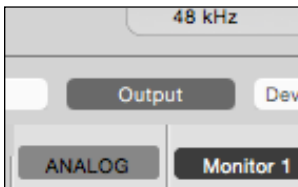

NOTE:

When a 8x8 or 16x16 module card is in the bottom Module 1 slot, an additional option for 7.1 becomes available.

Adjust for Volume Differences Between Speakers

There may be cases where the perceived volume of one of two or three speaker sets, or a speaker in a surround setup, is slightly different from the others. The output Trim controls in Maestro can be used to compensate for this so all speakers produce the same perceived volume levels.

1. Open Maestro and select the Output tab window.

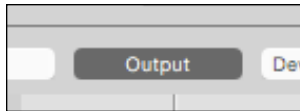

2. Select the 'Show Trims' button.

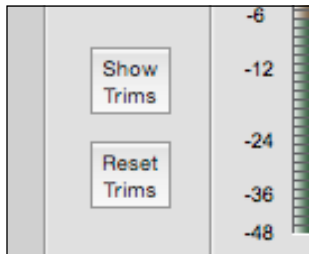

3. Decrease or Increase the trims for the outputs connected to speakers that need adjusting.

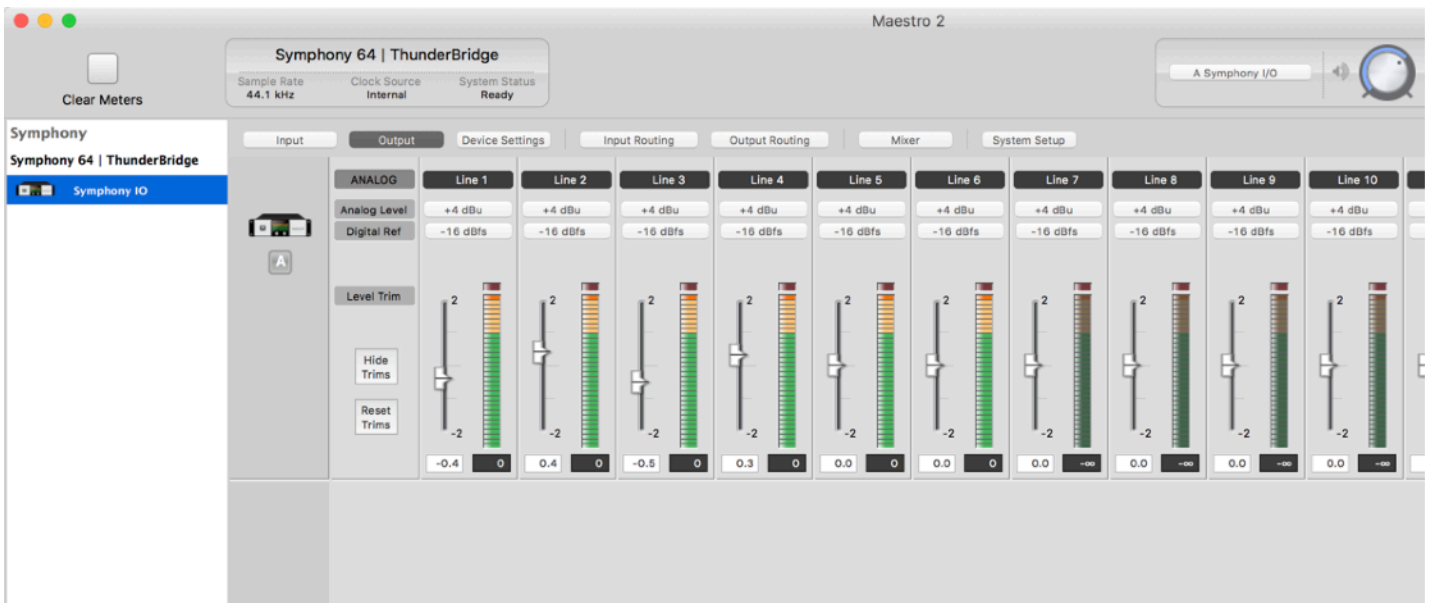

Direct Monitoring

If you do not have any recording software open, or do not want to use it's monitoring function due to issues such as high latency (see "Understanding Latency" on page 81), then you can use one of the Low-Latency Maestro Mixers built into Symphony to monitor your signal instead. **NOTE:** Mixers not available in Pro Tools HD AIM.

1. Open Maestro and select the Output Routing tab (or use the keyboard combination [⌘+5]).



2. To monitor using Speakers Connected to outputs 1/2: Click the left-most box next to **Mixer 1**. Now hardware Outputs **Line 1/2** will draw signal from the Maestro **Mixer 1**.

Software Outputs		Line 1/2	Line 3/4
1-2	NA.		
3-4	A Line 3/4		X
5-6	A Line 5/6		
7-8	A Line 7/8		
9-10	A Line 9/10		
11-12	A Line 11/12		
13-14	A Line 13/14		
15-16	A Line 15/16		
17-18	NA.		
19-20	NA.		
21-22	NA.		
23-24	NA.		
25-26	NA.		
27-28	NA.		
29-30	NA.		
31-32	NA.		
33-34	Mixer 1	X	
35-36	Mixer 2		

NOTE: The Mixer's location on the grid will vary based on the Module Card(s) installed.

3. In the Output tab, make sure your Headphones are set to mirror whatever hardware output you assigned **Mixer 1** to.

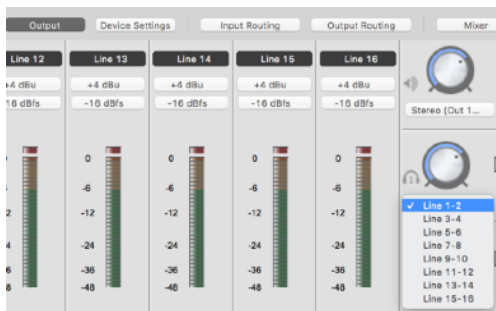

4. Select the Mixer tab (or use the keyboard combination [⌘+6]).

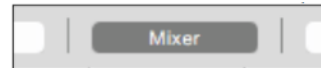

5. Adjust the level of input heard by adjusting the Input Fader, and level of audio playback from a computer program by adjusting the Software Return Fader.

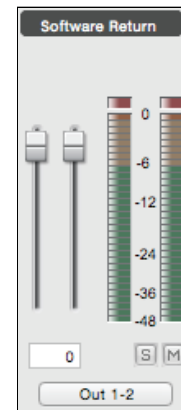
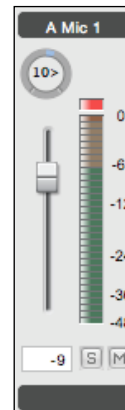

Setup Headphone/Speaker Mixes

Since there are two low-latency mixers in Maestro, these can send different mixes to the various Symphony audio outputs. For example, send one mix to the Line 1/2 output to your speakers, and a different mix to the Headphone output. **NOTE:** Mixers not available in Pro Tools HD AIM.

1. Open Maestro and click the Output Routing tab (or use the keyboard combination [⌘+5])

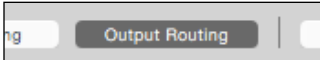

2. Route a Hardware Output listed at the top of the grid, such as **Line 1/2**, to **Mixer 1** on the left of the grid by clicking the box where they intersect. This places an "x" in that location. Now route another Hardware Output pair, such as **Line 3/4**, to **Mixer 2**.

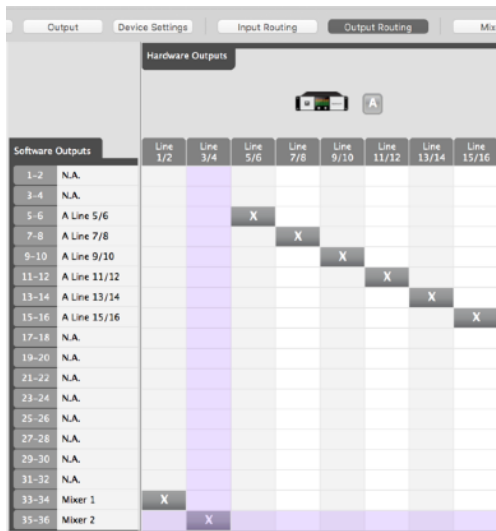

3. Go to the Output tab in Maestro and route one of the Headphone Outputs to mirror **Line 3-4**, which is receiving output from **Mixer 2**.

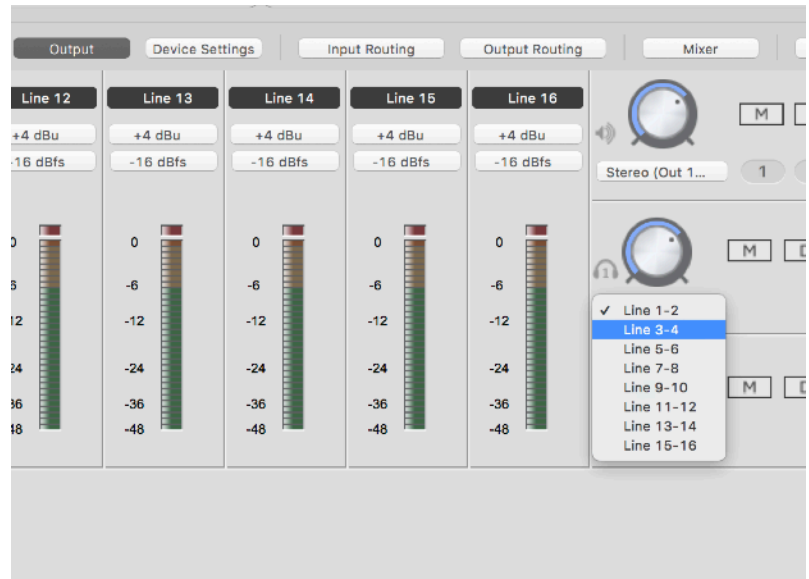

4. Select the Mixer tab (or use the keyboard combination [⌘+6])

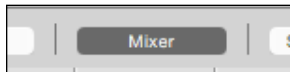

5. **Mixer 1** will be the speaker mix and **Mixer 2** will be the Headphone mix. Adjust the mixer channel faders, pan controls, and other settings to achieve the sound desired in each Mixer.

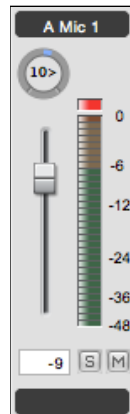

Device Settings Tab Window

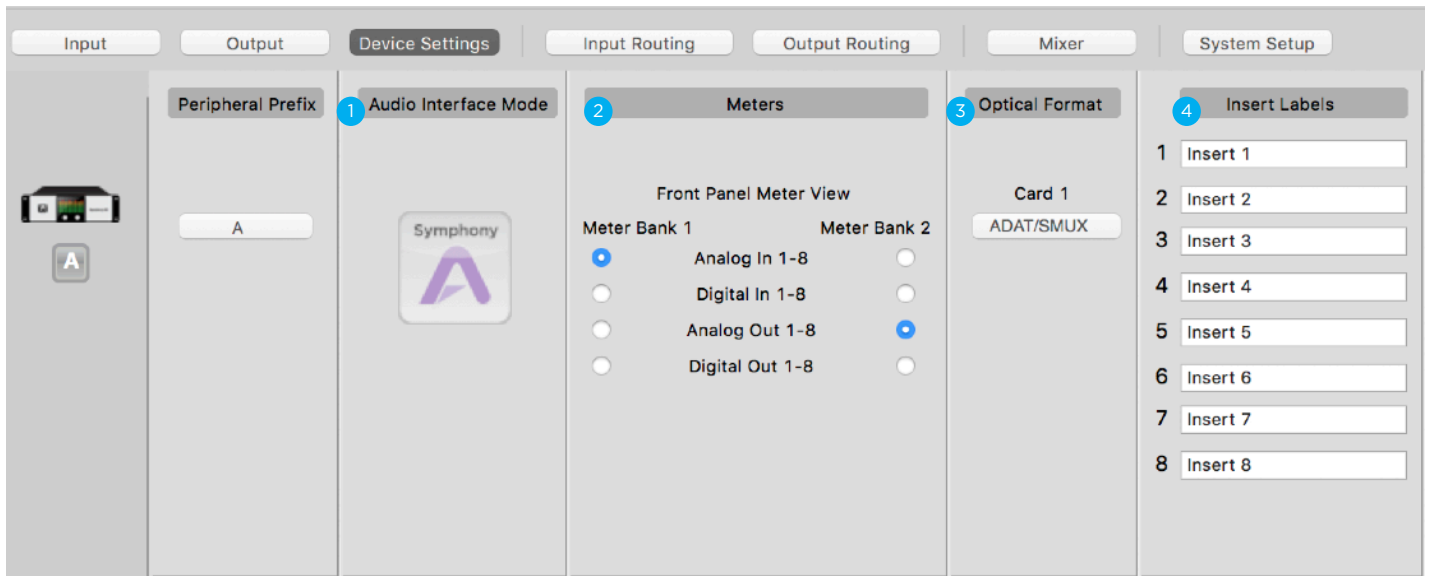

1. This section displays what **Audio Interface Mode (AIM)** the Symphony I/O is currently in.
2. This section allows you to change what metering is displayed in each bank on the front-panel.
3. If you have a module with optical i/o installed, this section allows you to toggle between ADAT/SMUX and SPDIF optical formats.
4. If you have a Mic Pre module installed, this section lets you customize the Insert labels.

Input Routing Tab Window

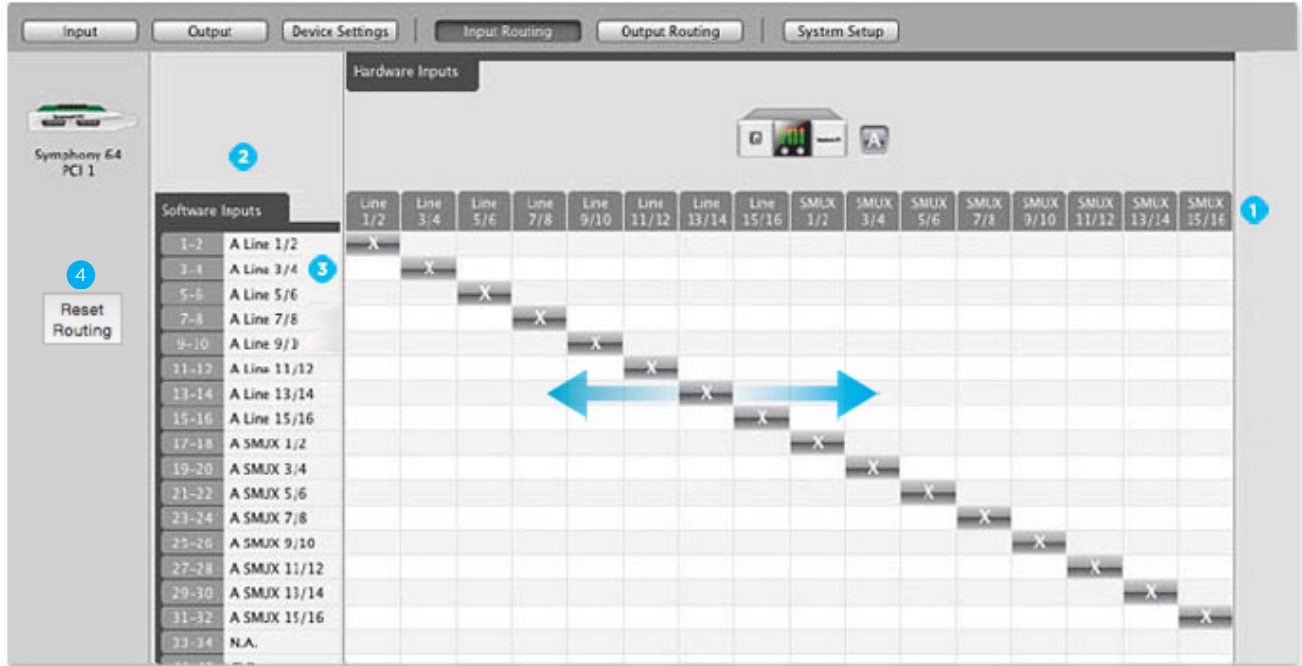

The Input Routing tab window determines how Symphony I/O hardware inputs are routed to audio software inputs. The number of input channels that are available to a computer recording program is determined by Symphony's driver. The Input Routing window determines how Symphony's physical hardware inputs are routed to these software inputs.

- 1. Hardware Inputs Columns** - The hardware analog and digital inputs of all peripherals connected to Symphony are displayed in these columns.
- 2. Software Inputs Rows** - Available audio software inputs are displayed in these rows in pairs (1-2, 3-4, etc.)
- 3. Software Inputs Labels** - Once a connection has been made between hardware and software inputs, the software input label (consisting of the peripheral prefix plus the hardware input label) appears in these fields.
 - For these labels to appear in your Audio software input/output assignments, ensure that the software is set to accept labels transmitted through Symphony's Core Audio driver.
- 4. Reset Routing** - Restores the factory default routing.

Audio connections between hardware and software inputs are made by positioning markers on the routing grid at the intersection of the desired hardware and software channels. By default, hardware inputs are routed sequentially to software inputs. Note that the movement of markers is restricted based on the routing capability of the system. On the Input Routing page, one hardware input may be assigned to multiple software inputs (in effect splitting the signal) but multiple hardware inputs may not be assigned to one software input (an operation which would require the summing of input signals). Each marker's range of motion is indicated by the horizontal shading on the routing grid, as depicted above by arrows on the input routing grid.

Output Routing Tab Window

The number of output channels that appear to audio programs in the computer is determined by Symphony's Core Audio driver. The Output Routing tab window determines how these software outputs are routed to Symphony's physical hardware outputs.

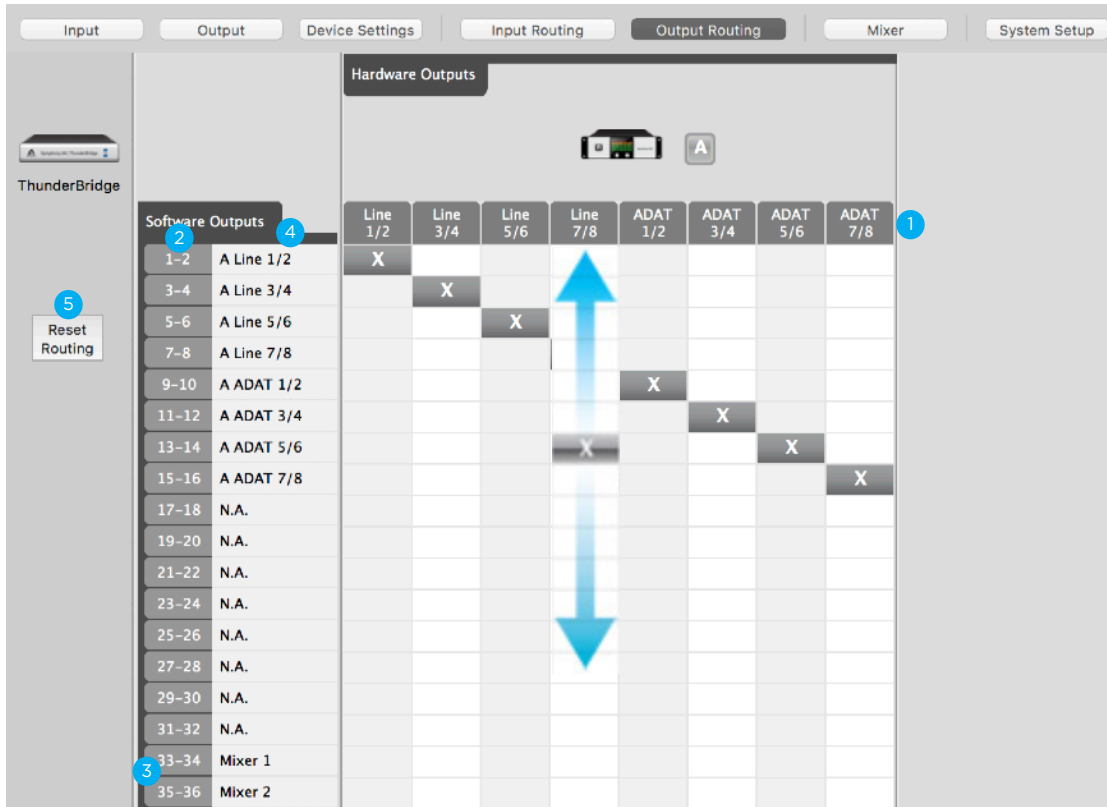

1. **Hardware Outputs Columns** - The hardware analog and digital outputs of all peripherals connected to Symphony are displayed in these columns.
2. **Software Outputs Rows** - Available audio software outputs are listed in these rows in pairs (1-2, 3-4, etc.)
3. **Mixer 1-2 Outputs Rows** - The two low latency mixer outputs appear at the bottom of the Software Outputs list, and may be assigned to one or more hardware output pairs.
4. **Software Outputs Labels** - Once a connection has been made between software and hardware outputs, the software output label (consisting of the peripheral prefix plus the hardware output label) appears in these fields.
5. **Reset Routing** - Restores the factory default routing.

Manipulation of the Output Routing Tab Window is essentially the same as the Input Routing Tab Window, with the important distinction that one software output may be assigned to multiple hardware outputs but multiple software outputs may not be assigned to one hardware output. Each marker's range of motion is indicated by the vertical shading on the routing grid, as depicted above by arrows on the Output routing grid.

Note that each marker represents an odd-even pair of audio signals - it's not possible to route the odd and even signal of a pair to different destinations.



StandAlone Routing

When audio interface mode is set to Standalone, only one routing tab (called the Standalone Routing tab window, unsurprisingly) is displayed. The Standalone Routing tab window determines how hardware inputs (on installed I/O Modules) are routed to hardware outputs. In Standalone mode, the PC-32 audio streams (to and from a Symphony 64 card) are not active, and thus don't appear on the grid. If multiple Symphony I/O in Standalone audio interface mode are detected, a separate Standalone Routing grid is displayed for each interface.

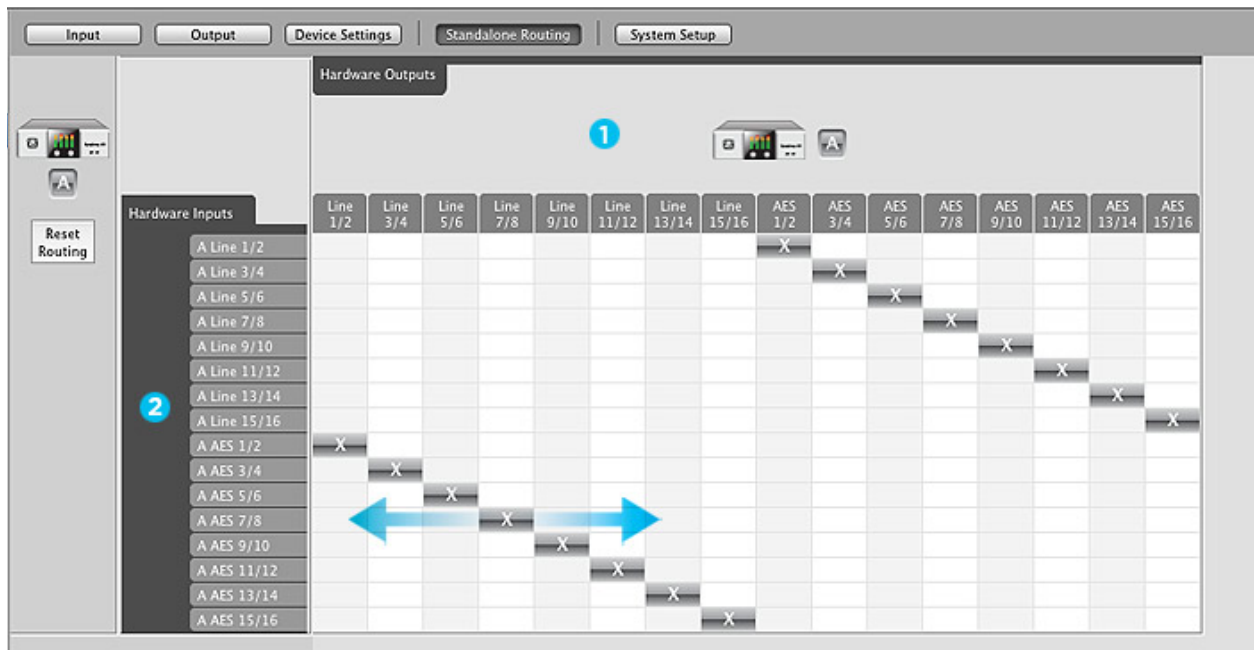

1. **Hardware Output Row** - The hardware analog and digital outputs of the Symphony I/O are displayed in this row.
2. **Hardware Input Column** - The hardware analog and digital inputs of the Symphony I/O are displayed in this row.

Audio connections between hardware inputs and outputs are made by positioning markers on the routing grid at the intersection of the desired hardware input and output. By default, analog inputs are routed sequentially to digital outputs and digital inputs are routed to analog outputs, the desired routing to use Symphony I/O as a standalone A-to-D and D-to-A converter. Similar to the Input and Output Routing grids (Symphony audio interface mode) marker movement is restricted based on the routing capability of the system. One hardware input may be assigned to multiple hardware outputs (in effect splitting the signal) but multiple hardware inputs may not be assigned to one hardware output (an operation which would require the summing of input signals). Each marker's range of motion is indicated by the vertical shading on the routing grid, as depicted above by arrows on the Standalone routing grid.

Mixer Tab Window

The Maestro Mixer provides a low latency patch from Symphony's inputs to its outputs. This is useful for when latency through software audio applications are too long, but also when wanting to monitor your input signal without needing to have an audio software application open at all.

Two independent mixers are provided for various uses, such as where multiple performers each require a different low latency mix.

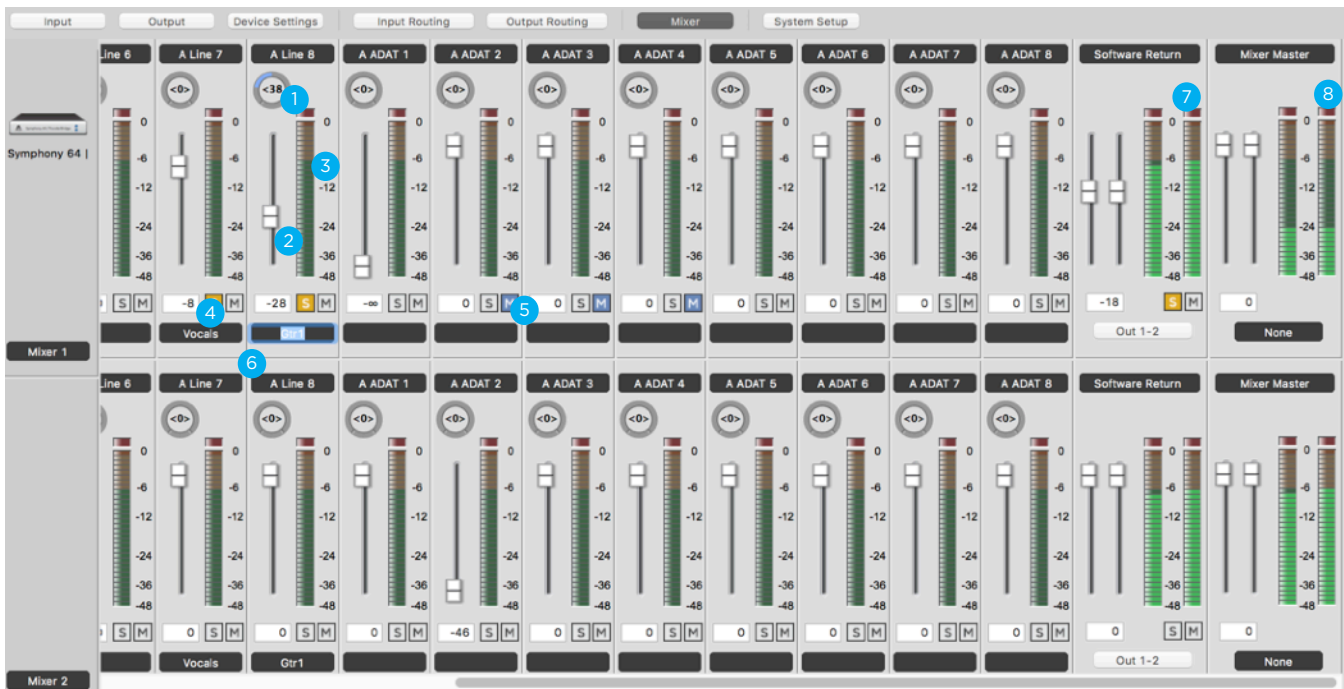

- 1. Pan** - This rotary knob pans the input signal between the left and right sides of the mixer's stereo output.
- 2. Input Fader and Readout** - This slider sets the level of the input signal in the mixer's stereo output. The level of the fader is indicated in the adjacent window.
- 3. Input Meter** - This bar-graph meter displays the pre-fader input level.
- 4. Input Solo** - This button mutes all input channels whose Solo buttons are not engaged.
- 5. Input Mute** - This button mutes the input channel.
- 6. Input Custom Label** - Alphanumeric labels may be entered in these text boxes.
- 7. Software Return** - Stereo fader for any audio coming from software, such as your DAW or iTunes. You can click on the dropdown menu below to assign a software output to it.
- 8. Mixer Master** - Stereo Master fader for Mixer. You would typically leave this at 0.

System Setup Tab Window

NOTE: parameters in the System Setup tab may change/disappear depending on what AIM you're using.

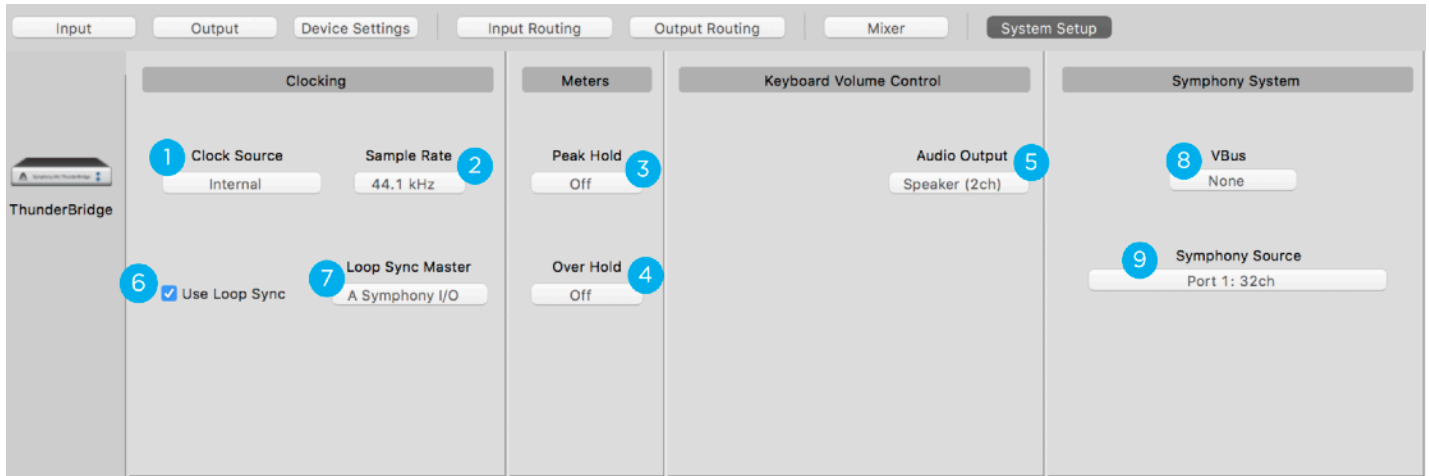

In most cases, Symphony hardware interface is part of a larger Mac-based audio system. Settings that encompass the integrated hardware-software system are found on this tab window.

- 1. Clock Source*** - This drop down selects the clock source. The following sources may be selected:
 - Internal:** Symphony is clocked from its internal crystal.
 - Word Clock:** Symphony is clocked from an external signal connected to the rear panel BNC input.
 - SPDIF Coax, SPDIF Optical, ADAT, or SMUX:** Symphony is clocked from a digital audio input. The clock sources listed will vary depending on sample rate and optical input settings.
- 2. Sample Rate** - Selects Symphony's sample rate. In some cases this setting may be overridden by software running on the computer (i.e. When a DAW session project is open).
- 3. Peak Hold** - Sets the time that peak indications are held on software and front panel meters.
- 4. Over Hold** - Sets the time that over indications are held on software and front panel meters.
- 5. Keyboard Volume Control** - The audio system may be configured so that the Mac keyboard volume controls set the output level of Symphony's speaker or headphone outputs.
- 6. Use Loop Sync**** - In a multi-unit system, the units will default to locking to each other via Loop Sync. Uncheck this box to use 'star-clocking'. We recommend using Loop Sync.
- 7. Loop Sync Master***** - In a multi-unit system in **Symphony** AIM, you can use this menu to switch which unit is the Loop Master. In **Pro Tools HD** AIM, Loop Master is selected in Pro Tools software.
- 8. VBus***** - In **Symphony** AIM, you can use this menu to enable different amounts of **Virtual Bus** i/o that allow you to route audio between different applications. See page xx for more on VBus.
- 9. Sym. Source***** - In **Symphony** AIM, you need to set this for 'Port 1' if you have 1 unit and 'Ports 1-2' for 2.

* Only available in **Symphony** & **Standalone** AIMS. In **Pro Tools HD** AIM, clock source is selected in Pro Tools. **USB** AIM is always Internal.

** Only available in **Symphony** & **Pro Tools HD** AIMS.

*** Only available in **Symphony** AIM.



Clocking with External Equipment

When connecting digital audio cables between Symphony and another digital audio device, a clocking relationship must also be set. Whether connecting two or more devices, one must be set as the clock master, and all other devices must be set as clock slaves.

NOTE: Changing clock-source from Maestro is only available in **Symphony** and **StandAlone** AIMS. In **Pro Tools HD** AIM, clock-source is set in the Hardware window of the Pro Tools software. The clock-source is always set to Internal in **USB** AIM.

Configure Symphony as Clock Master

1. Open Maestro and select the 'System Setup' tab (or use the keyboard combination $\text{⌘}+7$).

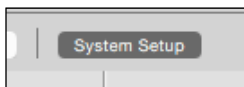

2. In the Clocking section, set Clock Source to 'Internal'.

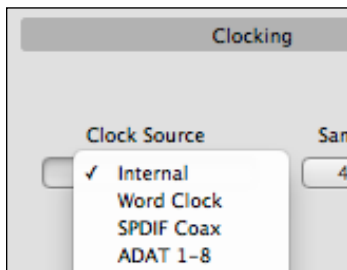

3. When Symphony is using its internal clock, the Home display will show "INTERNAL".

Clock signal is sent to all of Symphony's digital audio outputs and BNC Word Clock output.

4. Connect a digital audio cable (optical or coaxial) out of Symphony and into the external equipment.
Or connect a BNC Word Clock cable from the OUT of Symphony to the IN of the external equipment.
5. Make the appropriate settings on the external equipment to set it as a slave.
 - The sample rate must match on both devices. Though the Slave device may automatically switch to the appropriate sample rate, this may not always occur and the sample rate will need to be set manually.



Configure Symphony as Clock Slave

NOTE: Changing clock-source from Maestro is only available in **Symphony** and **StandAlone** AIMs. In **Pro Tools HD** AIM, clock-source is set in the Hardware window of the Pro Tools software. External clocking is not available in **USB** AIM.

1. Set the external device as the clock master.
2. Connect a digital audio cable (optical or coaxial) out of the external device and into Symphony. Or connect a BNC Word Clock* cable out of the external gear to Symphony's BNC IN port.
3. Open Maestro and select the "System Setup" tab (or use the keyboard combination **⌘+7**).

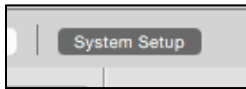

4. In the Clocking Section, set Clock Source to the appropriate external connection.

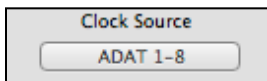

•Set the Clock Source to "ADAT", "SMUX", or "SPDIF Optical" when using an optical cable. Symphony's front panel will also reflect the source.

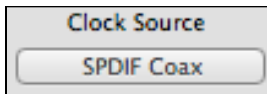

•Set the Clock Source to "SPDIF Coax" when using a coaxial audio cable. Symphony's front panel will also reflect the source.

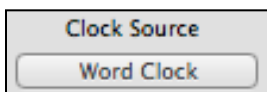

•Set the Clock Source to "Word Clock" when using a BNC word clock cable. Symphony's front panel will also reflect the source.

* BNC is the preferred method of transferring digital clock. Use this connection whenever possible and make sure to follow appropriate termination practices.

If Symphony doesn't receive or is unable to lock to a external clock source, the display's clock source indication will turn red, and the sample rate will blink. When this happens, check your connections for a bad or misconfigured cable, and make sure the sample rate of the master and slave devices are set to the same value.

Menu Bar Menus

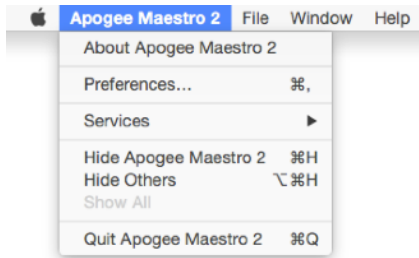

About Apogee Maestro - Choose this menu item to display version information for all the hardware connected and software elements installed on your Mac.

Preferences - Choose this menu item to display Maestro's Preference panel.

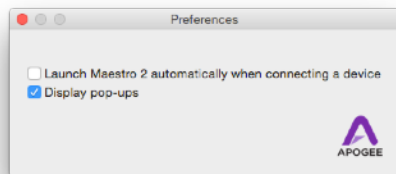

- **Launch Maestro automatically when connecting a device** - This launches Maestro when an Apogee device is connected to the computer.
- **Display pop-ups** - check this box to cause a transparent overlay to appear on your mac screen whenever the speaker or headphone levels are adjusted.

Hide Apogee Maestro - Choose this menu item to hide the Maestro application.

Hide Others - Choose this menu item to hide all other open applications.

Show all - If any open applications have been hidden, choose this menu item to reveal all open applications.

Quit Apogee Maestro - Choose this menu item to quit Maestro.



Rescan - Choose this menu item to re-initialize the link between Maestro and Apogee hardware connected to the Mac, in the case where the hardware is correctly connected and powered on but not detected by Maestro.

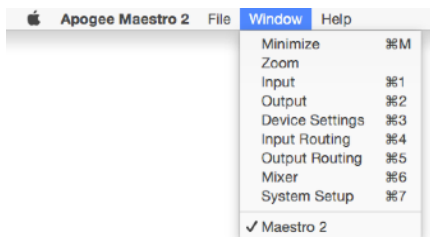

Selecting an item in the **Window Menu** switches to a view of that selection

Calibrating Symphony I/O

Symphony I/O's A/D and D/A converters may be calibrated to operate at optimum levels with a wide variety of analog gear. The calibration process is performed in the following three steps:

1. Choose Analog Input and Output Levels
2. Choose Digital Input and Output Ref (Reference) Levels
3. Adjust Input and Output Trims.

Step 1 – Choose the Analog Levels

In Maestro's Input tab, set Analog Level to match the nominal operating level of connected analog equipment. Consult the operating instructions of the equipment to determine its nominal operating level.

The following settings are available:

- **+4 dBu** – Choose this setting when connecting to professional audio gear that operates at a nominal level of +4 dBu. As a general rule, high-end mic preamps, professional mixing consoles and tape machines operate at +4 dBu nominal level.
- **-10 dBV** – Choose this setting when connecting to semi-pro or consumer gear such as home stereos and "project" studio equipment.
- **Variable** – Choose this setting when a precise nominal level setting isn't necessary. For example, the operating level of electronic instruments may greatly vary from model to model; by choosing Variable, it's easy to obtain a satisfactory input level without a lot of fuss.

When connecting Symphony I/O's Inputs and outputs to the same device (for example, a mixing console), it's best to set the analog output level (in Maestro's Output tab window) to the same setting as the input level, to preserve unity gain.

Step 2 -Choose the Digital Reference levels

The Digital Reference level determines the amount of headroom before digital overs occur, and is set according to user preference. As a general rule, the more unpredictable the audio source being recorded, the lower the Digital Reference should be set in order to maximize headroom. For example, when recording musical content with unpredictable peaks, set Digital Reference to -18 or -20 dBfs. When recording an automated mix, where dynamic range is both carefully managed and peaks are predictable, a higher Digital Reference (around -14 to -12 dBfs) may be preferable.

Again, it's best to set the Digital Output Reference level at the same setting as the Digital Input Reference level, to preserve unity gain through the system.

Step 3 – Adjust Trims

When interfacing even the highest quality analog gear, slight level adjustments are necessary to ensure that each channel's actual gain equals the theoretical gain based on the analog and digital levels selected. Follow these steps to trim each channel:

1. Click Show Trims on the Input and Output tabs to display trim faders for each analog channel.
2. Connect a 1kHz sine wave to an A/D channel at a level equal to the selected analog reference (for example, +4 dBu).
3. Adjust the channel's Input trim fader until the actual digital level, as displayed in the Meter Level Readout, is equal to the selected digital reference. For example, if Digital Ref is set to -16dBfs, it's likely that the actual level detected in Maestro will equal something like -16.2 dBfs. Adjust the Trim fader until the detected level equals -16.
4. To calibrate the D/A, route a 1kHz sine to a D/A channel at a level equal to the selected digital reference. Most digital audio workstations offer a Test Generator function to generate a sine wave at a specified digital level.
5. Adjust the channel's Output trim fader until the signal reads +4dBu (or the selected Output analog reference) using an external meter. If using a standard volt-ohmmeter, set it to read AC Volts, and adjust the trim until the external meter reads a voltage of 1.228 V. Note that on the Output tab, the Meter Level Readout is pre-Trim, so that adjustments to the Trim fader aren't reflected in the level displayed.
6. Note that when Output Digital Ref is set to -20dBfs, only a negative Trim value is possible (0dB to -2 dB).

Soft Limit

Soft Limit is Apogee's proprietary analog process for taming transients before A/D conversion. By gently rounding transients in a transparent manner, it's possible to maximize level BEFORE the A/D conversion stage and prevent unwanted distortion from clipping.

Soft Limit Settings

Soft Limit may be engaged on each analog input in Maestro's Input tab window. The following settings are available:

- **-2 dBfs** - Soft Limit begins to attenuate transient peaks at a level of -2 dBfs. This is the most transparent Soft Limit setting.
- **-4 dBfs** - Soft Limit begins to attenuate transient peaks at a level of -4 dBfs. This is the threshold of previous implementations of Soft Limit.
- **Soft Saturate** - a lower threshold, plus asymmetrical clipping in a manner similar to tube circuits.
- **Soft Crush** - The most extreme setting, where audible distortion and dirty mojo are required. Take that, drums!

Soft Limit on the 16x16 Analog IO Module - On the 16x16 Analog IO Module's inputs, soft limit functionality is restricted to On and Off. The On setting corresponds to the -4 dBfs setting on other IO Modules.

When to use Soft Limit

Soft Limit is an analog process that instantaneously rounds transient peaks beginning at -4dbfs. For all intents and purposes attack and release times may be considered instantaneous. As with any peak reduction device working at such fast time constants, Soft Limit is most effective with signals whose peak information is much greater than its average (or RMS) information, such as drums, percussion and plucked instruments. Soft Limit may not be the appropriate choice for limiting signals whose crest factor (peak to RMS ratio) is low, such as bass or organ.

Digital I/O Formats

Setting the Optical I/O Format

When using an optical I/O Module, set the format of the optical inputs and outputs to either ADAT/SMUX or S/PDIF using the Optical Format drop down menu, found on the Device Settings tab. The following format selections are available:

ADAT – This format transmits 8 channels of digital audio over one Toslink (optical) cable at sample rates of 44.1 to 48 kHz. The ADAT format, originally found on Alesis ADAT digital recorders, is found on a wide array of digital devices such as keyboards, audio PCI cards and audio interfaces.

SMUX – This format transmits 8 channels of digital audio over 2 Toslink cables at sample rates of 88.2kHz to 96kHz. The SMUX format, an extension of the ADAT format, allows the transmission of digital audio data at higher sample rates.

S/PDIF – This format transmits 2 channels of digital audio over 1 Toslink cable at sample rates of 44.1kHz to 96kHz. S/PDIF optical format connections are often found on keyboards, CD players and other consumer audio devices.

Using the S/PDIF Coax I/O

The S/PDIF Coax format transmits 2 channels of digital audio over 1 coaxial cable at sample rates of 44.1 to 192 kHz. S/PDIF Coax format connections are found on audio PCI cards, audio interfaces, digital effects units and CD players.

S/PDIF Coax Input

It's necessary to replace a stereo pair of analog or digital inputs with the S/PDIF Coax Input in order for the S/PDIF Coax Input to appear on the Routing tab grid. Use the **S/PDIF Coax Replaces** drop down menu, in Maestro's Input tab, to select the analog or digital input pair to be replaced by the S/PDIF Coax Input pair.

S/PDIF Coax Output

The S/PDIF Coax Output is "tapped" from one of the other analog or digital stereo output pairs. Use the **S/PDIF Coax Mirrors** drop down menu, in Maestro's Output tab, to choose which analog or digital stereo output pair will be duplicated on the S/PDIF Coax Output.

Meters

Meter Characteristics

Level meters on Symphony I/O's front panel and throughout Maestro display audio levels in the range of 0 to -48 dB full scale (fs).

An Over indicator at the top of each meter lights when three or more consecutive full scale samples have occurred. Though three consecutive full scale samples is most likely inaudible, the Over indicator serves as an "early warning" that the level should be reduced.

Peak and Over Hold

The amount of time that Peak and over indicators are held may be selected with the Peak Hold and Over Hold drop down menus, found in Maestro's System Setup tab window.

Both Peak and Over Hold may be set to the following times:

Off - Peaks and Overs are indicated but not held.

2 seconds - Peaks and Overs are held for 2 seconds, then cleared.

Infinite - Peaks and Overs are held infinitely (or, more accurately, a really long time) until cleared by the user by pressing Clear Meters in Maestro or clicking the front panel lefthand encoder.

Clear the Front Panel and Software Level Meters by clicking the Front Panel Left Hand Encoder or the Maestro Toolbar Clear Meters button. The message "Meters Cleared" will appear on the front panel OLED Display.

Front Panel Meters

Symphony I/O includes 2 banks of 8 level meters on the front panel. Select the audio signals to be displayed on each bank using the Meters buttons in the Device Settings tab window.



VBus - **Symphony** AIM

Working with VBus

Apogee's VBus is only available when Audio Interface Mode is set to Symphony. VBus creates virtual hardware buses to allow expanded routing of audio within one application or between different audio applications. For example, it's possible in Logic Pro to record a submix of multiple audio tracks onto a new audio track as described below. It's also possible to route between two audio applications by selecting a VBus output in the source application and a VBus input in the destination application. As an example, the output of a soft synth opened as a Standalone application may be routed via VBus to the inputs of your DAW application.

Configuring VBus

To choose the number of VBus channels, open Maestro > System Setup. In the VBus drop down menu, select the number of virtual buses desired.

In order for VBus I/O to appear in your audio application's I/O list as VBus In 1-2, 3-4, etc, it's necessary to specify the use of the Symphony driver's names in the application's I/O list. For example in Logic Pro, open Audio>Audio Configuration>View>I/O Labels and option-click on all the I/O found under the Driver's I/O Label column.

As an example of how to use VBus, let's record a submix of drums onto a new stereo audio track in Logic.

1. Open Maestro and select 8 Channels under the VBus Selections menu.
2. In Logic's Track Mixer, set the outputs of the individual drum audio tracks to VBout 1/2.
3. Create two audio tracks (or one stereo track) and set their inputs to VBin 1 and VBin 2.
4. Record-enable the new track and commence recording. The new track will record the mix of the individual drum tracks.

Reference

Working in your Digital Audio Studio

This chapter presents a variety of topics that, while not directly related to the Symphony I/O system, are encountered when working in the modern digital studio.

Setting Levels
Understanding Latency
Before Recording

Setting Levels

How do I set a recording level?

Once your microphone or instrument is connected, your audio software is configured and you've created a new recording track, just how do you set the input gain for a proper recording level in your audio software? There's no simple answer, but with a few guidelines and a bit of experience, you can master setting a proper level.

Ideally, the input gain should be set so that when the input signal is at its loudest, the level in audio software (or in Maestro) is just below maximum without lighting the Over indicator. In reality, it's unlikely that you'll be able to guess just the right gain setting to accomplish this - when your gain is too low, the signal never gets close to maximum and when your gain is too high, a digital Over may occur.

Now, with a 24-bit system (such as Symphony I/O), the noise floor is so low that there's no real penalty for undershooting the gain setting and recording at a lower level. There IS a penalty for overshooting the gain setting - a digital Over that results in significantly increased distortion. Thus, it's better to work with a recording level that's a bit too low than a level that's a bit too high.

Just how much to undershoot the gain setting is determined by the nature of the sound being recorded. As a general rule, instruments such as bass and organ have a more consistent level than percussive instruments, such as a tambourine, and may be recorded at a higher level. Also, the performer's skill and playing style can dictate more or less caution when setting levels. As you gain experience, you'll be able to more accurately set a good recording level while avoiding digital overs.

How do I set the input level of my powered speakers?

Most powered speakers offer an input volume control, often labelled as input sensitivity. Rather than describe an overly complicated method for setting this control, the easiest way to determine the right setting is to note where you generally set Symphony I/O's output level. If you find yourself rarely turning the output past a very low output level (say, -35 dB), decrease the input sensitivity on the speaker. If, on the other hand, you find yourself setting Symphony I/O's level for full output and the speakers aren't loud enough, increase the input sensitivity. Ideally, Symphony I/O's Speaker output should be at 0 dB (i.e. no attenuation) when you're listening at your absolute maximum desired volume.

Understanding Latency

What is latency?

When recording with most computer-based digital audio applications, a delay between the input and output of the recording system often disturbs the timing of the musicians who are performing. This delay, known as latency, means that the musician hears the notes he produces a few milliseconds after having produced them. As anyone who has spoken on a phone call with echo knows, relatively short delays can confuse the timing of any conversation, spoken or musical.

To illustrate the effect of latency, **Figure A** depicts the typical signal path of a vocal overdub session. A vocalist sings into a microphone, which is routed through a hardware interface to the audio software application for recording. In the software application, the vocalist's live signal is mixed with the playback of previously recorded tracks, and routed back through the hardware interface to the vocalist's headphones. Because of the audio application's latency, the vocalist hears his performance delayed by several milliseconds in his headphones.

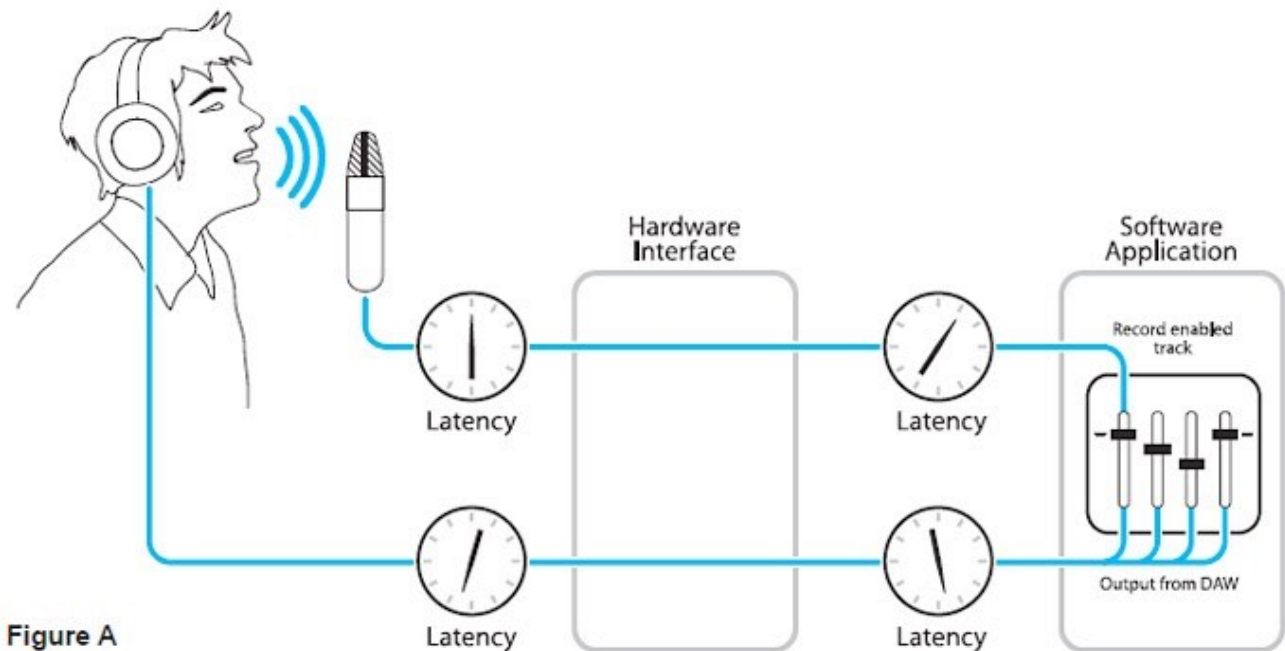

Figure A

How does Maestro resolve latency?

By routing the hardware input directly to the hardware output and mixing in playback as shown in **Figure B**, it's possible to create a headphone listening signal with a much shorter delay.

First, the signal being recorded (in this case, a vocal mic) is split in the hardware interface and routed to both the software application for recording and directly back to the hardware outputs without going through the latency-inducing software; this creates a low latency path from mic to headphones. Next, a stereo mix of playback tracks is routed to the low latency mixer and combined with the hardware input(s). This allows the performer to hear both himself without a confusing delay plus the playback needed for overdubbing.

Note that the software application's mixer is used to set a stereo mix of playback tracks while the low latency mixer is used to set the balance between the stereo playback mix and the hardware inputs.

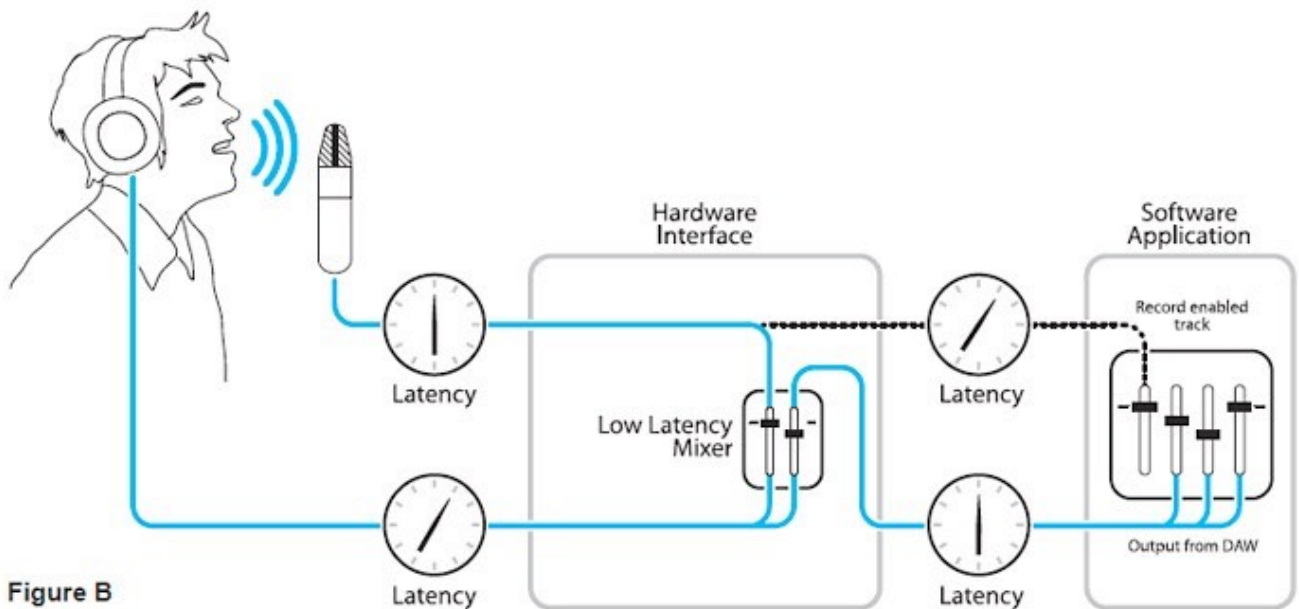

Do I need the Maestro Mixer?

The Maestro mixer serves to provide a low latency listening mix while recording. Therefore if you're using Symphony to listen to iTunes or audio from another program, there's no need to use the mixer.

It's also possible that the latency of your particular recording system is low enough to be unnoticeable by you or other performers, especially since Symphony uses the very efficient Thunderbolt™ 2 Technology. If you've set your audio software's input/output buffers according to the guidelines below and latency doesn't bother you or other performers, there's no need to use the Maestro mixer.

How do I set my software's I/O Buffer?

The I/O Buffer setting found in most audio software is one of the most crucial, but often ignored, settings in a Mac-based recording system.

When choosing a buffer setting, a compromise between the latency through the application and the amount of computer processor power accessible to the application must be made.

A lower Buffer setting results in lower latency but less available processing power. If the application can't access enough processor power, processor overruns may occur, resulting in audible clicks and pops or error messages that interrupt playback and recording.

A higher Buffer setting, on the other hand, results in greater amount of accessible processor power (i.e. less chance of overruns) but increases the latency. Determining the best setting requires some trial-and-error in order to find the best compromise.

Keep in mind that as tracks and plug-ins are added to a software session, processor requirements increase. Thus, the buffer setting that works during the early stages of a session might result in processor overruns during later stages.

The best strategy is to set the buffer to a lower setting during recording and accept certain limitations on plug-in usage, and then raise the buffer during mixing to utilize the computer's full processor power when latency isn't an issue.

With the processing power of today's Macs, you may find that adjustment of the Buffer isn't necessary, and you can leave it at a setting for low latency and still access a sufficient amount of processing power when adding tracks and plug-ins. If you do encounter clicks, pops or software errors, don't hesitate to experiment with the Buffer setting.

Troubleshooting - FAQ

How do I reset Symphony I/O to its factory default settings?

1. Start with Symphony turned off.
2. Hold down the left side front-panel encoder knob.
3. Turn Symphony on.
4. Once you see “Reset All But Cal No”, you can turn the right side encoder knob to select Yes and then push it in to reset everything on the unit except the calibration. If you would like to reset calibration as well, you would use the left side encoder knob to first switch from “Reset All But Cal” to “Reset All” and then use the right side encoder knob to select Yes.
5. This completes the hardware reset of Symphony.

Not getting audio input/output in my DAW

If you're not able to get any audio input/output in your DAW with Symphony I/O, there are a couple things to check:

- Confirm that there isn't an exclamation-mark (!) icon on the front-panel of the Symphony I/O. If there is, try unplugging/replugging the USB cable from your Mac to your Symphony if it's USB AIM. If it's in Symphony AIM, double-check the 'Source' setting in Audio MIDI Setup- is it correctly set for 'Port 1' if you have 1 unit and 'Ports 1-2' if you have 2 units? If not, change the setting and restart your Mac. If it's in Pro Tools HD AIM, double-check the connection to the Pro Tools HD card. Confirm that you have an iLok with a Pro Tools HD license connected.
- Do you have the Symphony I/O (or Symphony 64) selected as your default i/o in your DAW and 'Audio MIDI Setup' (Applications > Utilities> 'Audio MIDI Setup') ?
- Launch 'Apogee Maestro' from your Applications folder and go to the 'Input Routing' tab. Click the 'Reset Routing' button. Do the same thing in the 'Output Routing' tab.
- Unless you have the Mic-Pre module installed in your Symphony I/O, you can **not** connect microphones directly to the analog inputs of the i/o modules, as the inputs do not have mic-pres and are Line-Level only.
- Confirm that your Monitor settings are properly set by going to the 'Output' tab in Maestro and scrolling all the way to the right. Once you're there, check that the outputs aren't muted or turned down too low. If you're using Speaker Sets on the main outputs, check that the correct speaker set is selected.

No output from Symphony I/O

- Is the output volume up? Check on the front-panel or in Maestro's output tab to make sure the main output is turned up enough.
- Is the output muted? Check the front-panel, Maestro's output tab, and Audio MIDI Setup (Applications > Utilities > Audio MIDI Setup) to make sure output's not muted.
- Is the routing correct? Go to Maestro's input and output routing tabs and click "reset routing" in each tab.
- Is the SymI/O selected in your application's audio preferences? For "Symphony AIM", it will show up as "Symphony64", for "USB AIM", it will show up as "SymphonyI/O: USB", and for "ProTools HD AIM", it will show up as an Avid HD I/O.
- If you're monitoring through headphones, are the correct headphone outputs selected? Go to Maestro's output tab and confirm that the correct headphone outputs are selected in the 2 headphone drop-down menus under the headphone software encoders. The headphones will default to the 1st 2 outputs of the SymphonyI/O. Try toggling the headphone outputs to something else and then back to "1-2".
- Try toggling sample-rate or quitting/relaunching whatever application you're using.
- Are you in the correct AIM (Audio Interface Mode)? Confirm that the SymphonyI/O is in the correct AIM and configured properly. Make sure that you've quit all audio apps and that the SymI/O is powered up. Push in and hold on the right-side front-panel encoder. This will bring you to the AIM selection menu. Scroll to whichever AIM you're trying to use and then push in on the right-side encoder to select the AIM and the SymI/O will powercycle itself and restart in the chosen AIM

No sound or low level on outputs 1-2, How to set to Line Level?

If the first 2 analog outputs of Symphony I/O are too low in level or are muted, it is important to keep in mind that the first 2 analog outputs on Symphony I/O will default to -20dB and can be muted or dimmed, as many people use Symphony I/O as their monitor controller.

If you do not wish to use Symphony I/O as a monitor controller and want to set analog outputs 1/2 to Line Level like the rest of the analog outputs, follow the steps below.

There are a couple of ways to set them to line level like the rest of the outputs-

Using the front-panel encoders

Turn the left encoder knob until you see the speaker icon on the front-panel

Turn the right encoder knob to bring the output level up to 0dB

Using the Maestro's output tab

Launch 'Apogee Maestro 2' from your Applications folder

Scroll all the way to the right

You will see 3 software encoder knobs- one for the Main Speaker outs and 2 for headphones

You can turn the Speaker output knob up to 0dB or click on the drop-down menu where it says 'Stereo Out 1/2' and select 'Line'. This will set it for 0dB Line Level and disable monitor control so you don't accidentally mute the main outs or turn them down.

Once you make this setting, it will be remembered until you change it again.

Exclamation-mark (!) on front-panel/Symphony doesn't show up in Maestro

USB Audio mode

- Confirm your firmware and software is up to date and that the versions match. Go through steps on page 44.
- Confirm that your Symphony I/O is in 'USB Audio' mode by pushing in and holding on the right-side front-panel encoder and scrolling through the different modes until you get to 'USB Audio' and then push in on the encoder again to restart the unit in 'USB Audio' mode.
- Confirm that you're using the Apogee USB cable that was included with the Symphony I/O. Unplug USB cable and then plug back in to a different port and restart your Mac.
- Power-cycle Symphony I/O.

Symphony mode (Symphony 64 PCIe or Thunderbridge)

- Confirm that firmware and software is up to date and that the versions match. Go through steps on page 31.
- Confirm that your Symphony I/O is in 'Symphony' mode by pushing in and holding on the right-side front-panel encoder and scrolling through the different modes until you get to 'Symphony' and then push in on the encoder again to restart the unit in 'Symphony' mode.
- Launch Audio MIDI Setup (Applications> Utilities> Audio MIDI Setup). We recommend using Audio MIDI Setup instead of System Preferences Sound. Make sure that 'Symphony64' (PCIe or Thunderbridge) is selected in the left-side column. In the 'Source' menu on the right, choose the appropriate port selection depending on how many Symphony I/Os you have. If you have 1 unit, choose 'Port 1: 32ch'... if you have 2 units, choose 'Ports 1-2: 64Chs'. Quit Audio MIDI Setup and restart the computer.
- If you've gone through the above steps and the exclamation mark (!) icon still remains on the front-panel, there is a chance that the PC-32 port on either the Symphony I/O and/or the Symphony 64 PCIe/Thunderbridge isn't making a complete connection and needs to be cleaned with rubbing alcohol. Follow these instructions:
 - Disconnect the PC-32 cable ('Symphony' or 'Digi-Link' cable) and apply some rubbing alcohol (isopropyl) to the pins on the inside of the PC-32 cable's connector end. Make sure to apply the alcohol to the top and bottom of the pins on the connector. Now plug in and unplug the cable to the 'Main' port of the Symphony I/O. Do this about 20 times, so the port gets clean. Now repeat this with the Main port on the Symphony 64 PCIe or Thunderbridge. After each port has been cleaned, reconnect the PC-32 cable, power-cycle the Symphony I/O, and restart your Mac.

The firmware updater fails or gets stuck

Please Note: While Symphony I/O hardware and software are fully compatible with mac OS 10.9.5 and higher, Symphony I/O firmware can only be updated using mac OS 10.10.5 or lower. [The Symphony I/O Firmware Updater is not compatible with mac OS 10.11 or higher.](#)

If the firmware update fails or stalls and never completes, quit the firmware updater app, power-cycle the Symphony I/O, and try the update again, using the following steps:

- **Try connecting the Symphony I/O to a different USB hub**
- **Try connecting the Symphony I/O to an Apple keyboard**
- **Try connecting the Symphony I/O to a different USB port on your Mac**
- **Try the firmware update on a different Mac if you have access to one**

You may have to try the firmware update several times before it gets through. It is not recommended to try downgrading back to the older firmware versions.

Is Symphony Mobile still supported?

Unfortunately, Symphony Mobile is no longer supported with our latest Symphony System installers and current Mac OS versions. The last Symphony Release Installer package that officially supported the Symphony Mobile card was **Symphony Release 4.4**. This installer is compatible with the following Mac OS versions: 10.6.8, 10.7.5, and 10.8.5. Anything after 10.8.5 is not supported. If you would like this installer, you can request it from our [Support department](#).

How do I set the Symphony I/O to auto power on?

Refer to page 21.

How do I calibrate Symphony I/O?

Refer to page 74.

SPDIF or ADAT/SMUX Optical isn't working

- Open Maestro and go to the "Device Settings" tab and confirm that the "Optical Format" drop-down menu is set to the correct format.
- Make sure that both Symphony I/O and any digital device are set to the same sample-rate and that one is clocked to the other.
- Toggle sample-rate back & forth
- Reload audio driver in software (for example- in Logic, go to audio preferences, make a change and click "Apply Changes").
- wiggle optical cables and try different optical cables

No Loop Sync option in Maestro?

The Loop Sync option in the Maestro software's System Setup tab will disappear under certain conditions.

- Loop Sync is not available when Symphony I/O is in Standalone AIM or USB AIM.
- When in Symphony AIM, if a legacy converter is connected to the other port on the Symphony64PCI or Thunderbridge card, Loop Sync will disappear.

The legacy converters affected are AD-16x, DA-16x, Rosetta-200, and Rosetta-800 with the x-symphony option card installed. If you need to change this setting, you will need to quit the Maestro software, then change your setup to avoid one of the conditions listed above. Reopen Maestro and the loop sync option will reappear.

2 Symphony I/Os together with Symphony 64 Thunderbridge or PCI ?

1. Assuming both units are on the same firmware versions, connect the first unit to the first port of the Symphony64 Thunderbridge or PCIe card using a PC-32 cable. Connect one end of the cable to the “main port” on the back of the first Symphony I/O and the other end of the cable to the 1st port (on the left) of the Symphony64 Thunderbridge or PCIe card.
2. Connect the 2nd Symphony I/O to the 2nd port of the Symphony64 Thunderbridge or PCIe card using a PC-32 cable. Connect one end of the cable to the “main port” on the back of the second Symphony I/O and the other end of the cable to the 2nd port (on the right) of the Symphony64 Thunderbridge or PCIe card.
3. Connect the 2 Symphony I/O’s to each other using BNC cables with the Loop Sync connectors. Connect “in” from one unit to the “out” of the other and vice versa. Make sure you’re using the Loop Sync connectors (on the right side) and NOT the Word Clock connectors (on the left side).
4. Make sure each Symphony I/O is set for “SYM AIM” (Symphony Audio Interface Mode) by pressing in and holding on the right side encoder on the front-panel until it brings you to the AIM menu. If it says “Symphony”, it’s already in SYM AIM and you can just push the encoder again to exit the menu. If not, scroll through the menu until it says “Symphony” and then push in on the encoder again. The unit will power down and restart itself in SYM AIM. Do this for both units.
5. Open up “Audio MIDI Setup” (Applications> Utilities> Audio MIDI Setup). Select “Symphony64” in the left-hand device column. Make sure it’s selected as your computer’s default i/o. The speaker and microphone icons should appear next to it. If they don’t, click on the drop-down menu below with the “gear” icon and select both “Use this device for sound input” and “Use this device for sound output”.
6. With “Symphony64” selected in Audio MIDI Setup, go to the center part of the Audio MIDI Setup window and set the “Source” drop-down menu to ‘Ports 1-2: 64Chs’. Quit Audio MIDI Setup and restart your computer.

Symphony64 Thunderbridge/PCI not showing up after updating macOS

There is a known issue where the Symphony64 Thunderbridge would show up with the generic ‘Device’ label and wouldn’t work correctly after updating to macOS 10.12 Sierra.

This issue has been fixed in the latest Sierra-compatible Symphony software installer.

If you are updating to macOS 10.12 Sierra and use Symphony64 Thunderbridge, make sure to run the [most current Symphony installer](#) that is compatible with Sierra.

Symphony I/O + AD/DA16x or Rosetta on Symphony64 Thunderbridge/PCI?

Yes, Symphony I/O can be used with Legacy interfaces. Please note the following instructions to do so:

1. The rule for Symphony I/O connection is- “1 Symphony I/O per port”, so that means the supported configuration is 1 Symphony I/O on port 1 of the Symphony64 Thunderbridge or PCIe card and any Legacy interfaces on port 2 of the Symphony64 Thunderbridge or PCIe card. You can't daisy-chain Symphony I/O's, but you *can* daisy-chain Legacy interfaces.
2. First, make sure your Legacy interface (AD16x, DA16x, Rosetta 200, Rosetta 800) have an X-Symphony option card properly installed with the current X-Symphony firmware (version 2.7)
3. Connect your Symphony I/O directly to your computer's USB ports- don't use a hub. Power up the Symphony I/O.
4. Download the latest [Symphony I/O Release package](#) from our website and follow the steps on page 31.
5. After the firmware has successfully updated, connect the Symphony I/O to the first port of the Symphony64 Thunderbridge or PCIe card using a PC-32 cable. Connect one end of the cable to the “main port” on the back of the first Symphony I/O and the other end of the cable to the 1st port (on the left) of the Symphony64 Thunderbridge or PCIe card.
6. Connect the 1st Legacy device to the 2nd port of the Symphony64 Thunderbridge or PCIe card using a PC-32 cable. Connect one end of the cable to the “primary port” on the back of the 1st Legacy device and the other end of the cable to the 2nd port (on the right) of the Symphony64 Thunderbridge or PCIe card. Chain any additional Legacy devices using the “primary” and “expansion” ports.
7. If you're using multiple Legacy devices, send the Word Clock output of the 1st Legacy device to the Word Clock input of the 2nd Legacy device and so on, using BNC cables and t-connectors, if necessary.
8. Send the Word Clock output of the Symphony I/O to the Word Clock input of the 1st Legacy device using a BNC cable.
9. Make sure the Symphony I/O is set for Symphony AIM by pressing in and holding on the right side encoder on the front-panel until it brings you to the AIM menu. If it says “Symphony”, it's already in Symphony AIM... you can just push in on the encoder again to exit the menu. If not, scroll through the menu until it says “Symphony” and then push in on the encoder again. The unit will power down and restart itself in Symphony AIM.
10. Power up all the Legacy devices and make sure they're set for “External Word Clock” as their clock source.
11. Run the software installer included in the Release download. Restart the computer.
12. After the computer restarts, open up “Audio MIDI Setup” (Applications> Utilities> Audio MIDI Setup). Select “Symphony64” in the left-hand device column. Make sure it's selected as your computer's default i/o. The speaker and microphone icons should appear next to it... if they don't, click on the drop-down menu below with the “gear” icon and select both “Use this device for sound input” and “Use this device for sound output”.
13. With “Symphony64” selected in Audio MIDI Setup, go to the center part of the Audio MIDI Setup window and set the “Source” drop-down menu to ‘Ports 1-2: 64Chs’. Quit Audio MIDI Setup and restart your computer.
14. After the computer restarts, wait for the system to configure- the exclamation mark (!) icon on the front-panel of Symphony I/O will eventually go away and the Legacy units will switch to “Ext” clocking... After this happens, launch Maestro2 and confirm that all the interfaces show up properly. If a device is showing up as the wrong unit, such as a DA16x in Advanced routing showing up as an AD16x, go to the “Device Settings” tab in Maestro2, highlight the device in the left-hand device column and then select “DA16x” in the “Device Type” drop-down menu. Quit Maestro and restart the computer. If an AD16x in standard routing is showing up as a Rosetta800, quit Maestro and restart the computer.

Signal showing up in wrong place and/or routing is incorrect in Pro Tools HD

- You will need to make sure the 'Playback Engine' is set for whatever HD card you're using. If the HD card isn't showing up in the 'Playback Engine', you need to double-check the HD license on your iLok and confirm that you have installed the applicable HD driver (usually a separate install from the main Pro Tools software). Double-check the Pro Tools setup steps on page 40.
- You may need to reset the I/O paths in Pro Tools. This is a very common thing. Click on the 'Setup' menu in Pro Tools and select 'I/O'. Once the I/O Setup opens, select all of the channels in the left-hand column and hit 'Delete' on your keyboard. After you've deleted them, click the 'Default' button in the lower part of the screen and confirm that the "Compensate for delays..." checkbox is checked. Follow the same steps for the input, output, bus, and insert tabs in I/O Setup. Once you have gone through these steps in each tab, click the 'OK' button to confirm changes and exit.
- Using a 2x6 module in the primary slot of a unit **with two modules installed** is not supported.
- There is a known issue when using Symphony I/O in Pro Tools HD mode with a Pro Tools HD Native card or HD Native Thunderbolt. The routing will be incorrect and/or audio will not show up where expected when you connect 2 Symphony I/Os and the **1st unit only has one I/O module installed**. This only occurs with HD Native— not with HDX or the older Core/Accel/Process HD cards.

Solution:

Make sure the 1st unit connected to the HD Native card or HD Native Thunderbolt on Port 1 has 2 I/O modules installed if you have 2 units connected.

How does the routing for the 2x6 module show up in Pro Tools HD?

When using a 2x6 i/o module in a Symphony I/O, the 2x6 i/o module shows up as a 16ch Avid HD I/O in Pro Tools HD. Here is how the I/O corresponds with the ProTools I/O (*Note that PT inputs 3 through 6 are nothing. This is so all the input and output channel numbers line up with each other when using hardware inserts*):

Pro Tools Inputs 1-2	Line Inputs 1-2
Pro Tools Inputs 3-4	N.A.
Pro Tools Inputs 5-6	N.A.
Pro Tools Inputs 7-8	AES Inputs 1-2
Pro Tools Inputs 9-16	Optical Inputs 1-8
Pro Tools Outputs 1-6	Line Outputs 1-6
Pro Tools Outputs 7-8	AES Outputs 1-2
Pro Tools Outputs 9-16	Optical Outputs 1-8

Delay Compensation with Pro Tools HD

Delay Compensation

In order for hardware to be “delay compensation compatible”, the delay through the hardware’s A/D, D/A and digital I/O must be equal to the delay through the emulated Avid hardware. This way, when the delay compensation function applies sample delays to signal paths based on Avid hardware, no timing errors are introduced due to the fact that third-party hardware is in use. When used as an analog or digital hardware insert, Symphony I/O provides a signal path that sample accurately reproduces the delay of an HD I/O.

Symphony I/O Delay Comp Implementation

Ideally, Symphony I/O’s A/D delay would be equal to the HD I/O’s A/D delay and Symphony I/O’s D/A delay would be equal to the HD I/O’s D/A delay. This would ensure that any conceivable signal path through Symphony would have the same delay as HD I/O. Unfortunately, this isn’t the case. During the design phase of Symphony I/O, a high priority was placed on the ESS DAC chip, which has remarkable characteristics that greatly exceed other DACs. One tradeoff was that the chip’s propagation delay was longer than the DAC used in the HD I/O, and couldn’t be reduced without a compromise in D/A quality. To accommodate for this, the propagation delay of Symphony I/O’s A/D side was reduced by the corresponding amount, so that Symphony I/O’s A/D - D/A path is equal to that of the HD I/O. This offset is shown below using theoretical delay values.

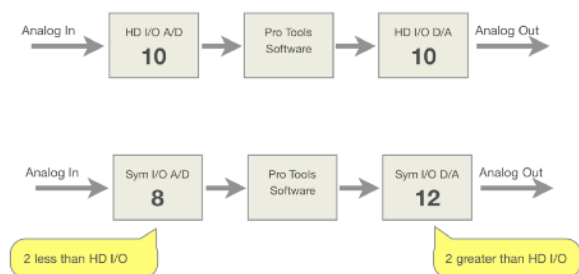

Hardware Insert

If Symphony I/O is used as a hardware insert, it provides a signal path that sample accurately reproduces the delay of an HD I/O. Please see the notes below concerning a 1 sample delay bug and sub-sample delay.

Using Symphony I/O & HD I/O together

When using Symphony I/O with an HD I/O, delay through all tracks is equal IF HD I/O inputs are routed only to HD I/O outputs and Symphony I/O inputs are routed to Symphony I/O outputs. When signal paths use a mix of HD I/O and Symphony I/O inputs and outputs, delay differences of a few samples will occur. For example, if a single snare mic were routed to both an HD I/O and Symphony I/O A/D input, the snare would be recorded to Pro Tools a few samples earlier on the Symphony I/O track. If both track were then mixed in Pro Tools to an HD I/O output, comb filtering would be heard. The obvious workaround is to avoid sending phase sensitive signals through different interfaces - a rule of thumb that applies to any digital audio system. Don’t send the snare close mic to HD I/O and the overheads to Symphony I/O.

One Sample Delay Compensation Bug

During the several years that Apogee has tested delay compensation with Apogee hardware, we’ve infrequently but consistently encountered a bug whereby delay compensation is off by 1 sample. We’ve observed this bug while using Avid hardware interfaces as well. The 1 sample error is fairly rarely encountered, and usually resolved by closing and relaunching the session.

Sub-Sample Delay Differences

While Symphony I/O’s A/D - D/A propagation delay is the same as HD I/O’s to the sample, there is a sub-sample difference that’s difficult to measure and isn’t seen in Pro Tools even at the highest magnification. This sub-sample difference is observable when performing “null” tests to verify delay compensation, but doesn’t result in degradation of the audio signal at all. It’s important to note that this error is below the measurement resolution of Pro Tools and most audio measurement systems.

Mic Pre Module FAQ

Q. Does it add 8 additional channels to my system?

A. No. It only provides the option of selecting a mic pre to your existing card in slot 1. For example: If you have an 8x8 module in slot 1 of your Symphony I/O, this provides you with 8 channels of analog line-level input. If this is the only card you have installed, you'd have to use external mic preamps to connect microphones to this system. By adding a Mic Pre module in slot 2, this provides those 8 channels with high-quality mic preamps internally instead. Whether to use your 8 analog inputs as line-level or mic preamps is [selectable in the Maestro 2 software's Input screen](#).

Q. Do I plug my mic into one of the four ¼" inputs on the Mic Pre module? What are they for?

A. These ¼" inputs are for connecting high impedance sources such as an electric guitar, bass guitar, or keyboards to the Mic Pre card. It makes it convenient to connect these ¼" sources to the Symphony instead of using an adapter to plug into the XLR input of the card in Slot 1. Enable these in [Maestro's Input screen](#) by selecting "Instrument" as the channel's Analog Source.

Q. What are the Inserts Send/Return for? How do you use them? Where is the insert point?

A. This is a hardware insert for the Microphone Preamps. They are used to insert additional equipment such as Compressors and Equalizers to your input path. You turn Inserts On/Off via [Maestro's Input screen](#), and the insert option is only visible on channels that have the source set to "Mic" or "Instrument". The insert point is after the preamp and high-pass filter but before the A/D conversion stage.

Q. Can I use the Mic Pre module with the [2x6 analog card](#) or the [16 Digital In + 16 Analog Out card](#) (sometimes called the 16ch D/A card)?

A. No. The Mic Pre module cannot be used with the 2x6 analog card or the 16 digital in + 16 analog out card because they do not have at least 8 channels of analog input available.

Q. Can I use the Mic Pre module with the [16x16 analog I/O card](#) or [16 Analog In + 16 Digital Out card](#)?

A. Yes. The first 8 channels of the 16 input channels can be set as "Mic" via [Maestro's Input screen](#), and the channels 9-16 are limited to line-level.

Pin Out Diagrams

Analog I/O and Inserts

Pinout for Analog IN (8x8 module, 16x16 module) and INSERTS RETURN 1-8 (Mic Pre I/O Module)

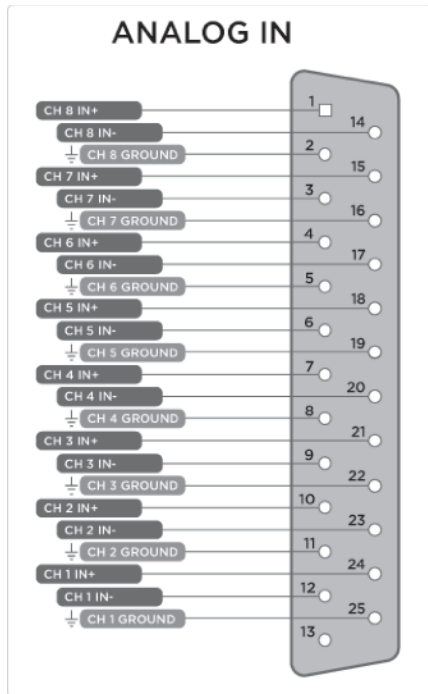

Pinout for Analog OUT (8x8 module, 16x16 module, 2x6 module) and INSERTS SEND 1-8 (Mic Pre I/O Module)

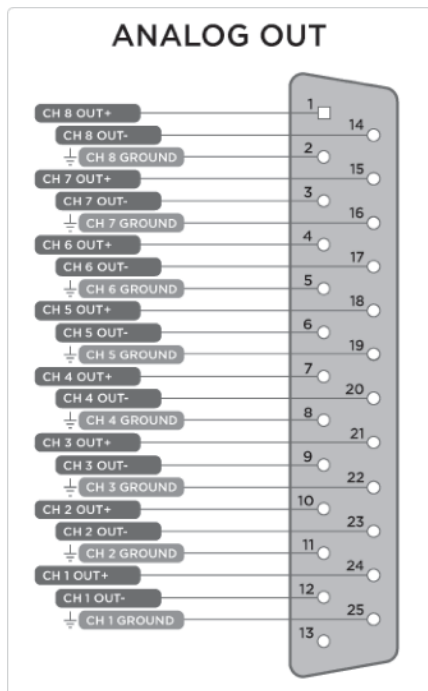

AES IN/OUT

Pinout for AES IN/OUT (8x8 module)

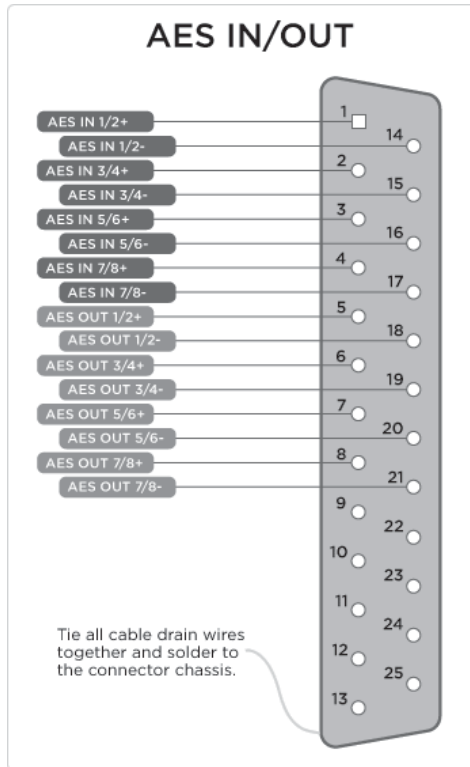

Specifications

Highlights:

A/D THD+N: -113dB @ +20dBu (0.00024%)
D/A THD+N: -117dB @ +20dBu (0.00014%)
D/A Dynamic Range: 129dB A weighted
Apogee's proprietary Perfect Symmetry Circuitry (PSC)
Software controlled AD/DA reference setting
Variable gain input for keyboards
Ultra low latency AD/DA conversion

Analog to Digital:

THD+N: -113dB @ 20dBu (0.00024%)
Dynamic range: 120dB A weighted
Maximum input levels:
+4dB setting - 24dBu
-10dB setting - +6dBV
Variable gain setting - 25dB of gain
Frequency response at 44.1kHz 1-20,000 Hz (+/- 0.05dB)
Input impedance: 10K

Digital to Analog:

THD+N: -117dB @ 20dBu (0.00014%)
Dynamic Range: 129dB A weighted
Max output levels - ∞ to +24dBu
Frequency response at 44.1 kHz: dc to 20kHz (+/- 0.05dB)
Output impedance: 25 Ohm
Outputs are balanced through Apogee's proprietary Perfect Symmetry Circuitry (PSC)

Headphones:

THD+N: -105dB @19dBu
Dynamic Range: 119db A weighted
Output impedance: 30 Ohm

Power:

90-240VAC, 50-60Hz, 150W

Operating System:

mac OS 10.9.5 or greater

Package Contents:

Symphony I/O Interface
USB Cable
Power Cable
Rack Ears and Screws
Quick Start Guide

Packaging Sizes:

Symphony I/O Chassis Box
Inches: 22.875 L x 17.75 W x 9.25 D
Centimeters: 58.1 L x 45.1 W x 23.5 D

I/O Module Box

Inches: 13.75 L x 12.25 W x 3.25 D
Centimeters: 34.9 L x 31.1 W x 8.3 D

Additional Support

General Support

For more information:

- Apogee KnowledgeBase and FAQs
- Apogee Product Registration
- How to contact Apogee Technical Support

Visit: <http://www.apogeedigital.com/support/>

Apogee Pro Care



Want priority access and expedited repair? Consider an Apogee ProCare membership.

It's never been easier to get back to work.

As a ProCare member you'll have premium access to Apogee's world-class technical support group for the life of your agreement. The contract is fully transferable by the original registered owner of the agreement. All Apogee support technicians reside and are continuously trained at Apogee Electronics, Santa Monica, CA.

Learn more at: www.apogeedigital.com/apogee-procare

Warranty Information and Legal Notices

Symphony Warranty Information and Legal Notices

Registration and Warranty Information

Be sure to register your Symphony, either by filling in the enclosed Registration Card or by completing the on-line registration form at our Web site: www.apogeedigital.com/support/contact-support

If you do so, Apogee can contact you with any update information. As enhancements and upgrades are developed, you will be contacted at the registration address. Firmware updates are free for the first year of ownership unless otherwise stated.

Please address any inquiries to your dealer or directly to Apogee at:

APOGEE ELECTRONICS CORPORATION
1715 Berkeley St Santa Monica, CA 90404, USA
web: www.apogeedigital.com/support

APOGEE ELECTRONICS CORPORATION warrants this product to be free of defects in material and manufacture under normal use for a period of 12 months. The term of this warranty begins on the date of sale to the purchaser. Units returned for warranty repair to Apogee or an authorized Apogee warranty repair facility will be repaired or replaced at the manufacturer's option, free of charge.

ALL UNITS RETURNED TO APOGEE OR AN AUTHORIZED APOGEE REPAIR FACILITY MUST BE PREPAID, INSURED AND PROPERLY PACKAGED, PREFERABLY IN THEIR ORIGINAL BOX.

Apogee reserves the right to change or improve design at any time without prior notification. Design changes are not implemented retroactively, and the incorporation of design changes into future units does not imply the availability of an upgrade to existing units. This warranty is void if Apogee determines, in its sole business judgment, the defect to be the result of abuse, neglect, alteration or attempted repair by unauthorized personnel. The warranties set forth above are in lieu of all other warranties, expressed or implied, and Apogee specifically disclaims any and all implied warranty of merchantability or of fitness for a particular purpose. The buyer acknowledges and agrees that in no event shall the company be held liable for any special, indirect, incidental or consequential damages, or for injury, loss or damage sustained by any person or property, that may result from this product failing to operate correctly at any time.

USA: Some states do not allow for the exclusion or limitation of implied warranties or liability for incidental or consequential damage, so the above exclusion may not apply to you. This warranty gives you specific legal rights, and you may have other rights which vary from state to state.

Service Information

Symphony contains no user-serviceable components; refer to qualified service personnel for repair or upgrade. Your warranty will be voided if you tamper with the internal components. If you have any questions with regard to the above, please contact Apogee.

In the event your Symphony needs to be upgraded or repaired, it is necessary to contact Apogee prior to shipping, and a Return Materials Authorization (RMA) number will be assigned. This number will serve as a reference for you and helps facilitate and expedite the return process. Apogee requires that shipments be pre-paid and insured — unless otherwise authorized in advance.

IMPORTANT: ANY SHIPMENT THAT IS NOT PRE-PAID OR IS SENT WITHOUT AN RMA NUMBER WILL NOT BE ACCEPTED.

Warnings

FCC Warning

This equipment has been tested and found to comply with the limits for a Class A digital device, pursuant to Part 15 of the FCC rules. These limits are designed to provide reasonable protection against harmful interference when operated in a commercial environment. This equipment generates, uses, and can radiate radio frequency energy and, if not installed and used in accordance with the instruction manual, may cause harmful interference to radio communications. Operation of this equipment in a residential area is likely to cause harmful interference, in which case the user will be required to take whatever measures necessary to correct the interference at his own expense.

Copyright Notice

Symphony is a computer-based device, and as such contains and uses software in ROMs. This software, and all related documentation, including this User's Guide contain proprietary information which is protected by copyright laws. All rights are reserved. No part of the software and its related documentation may be copied, transferred, or modified. You may not modify, adapt, translate, lease, distribute, resell for profit or create derivative works based on the software and its related documentation or any part thereof without prior written consent from Apogee Electronics Corporation, U.S.A.

Software Notice

Redistribution and use in source and binary forms, with or without modification, are permitted provided that the following conditions are met:

1. Redistributions of source code must retain the above copyright notice, this list of conditions and the following disclaimer.
2. Redistributions in binary form must reproduce the above copyright notice, this list of conditions and the following disclaimer in the documentation and/or other materials provided with the distribution.

THIS SOFTWARE IS PROVIDED BY THE COPYRIGHT HOLDERS AND CONTRIBUTORS "AS IS" AND ANY EXPRESS OR IMPLIED WARRANTIES, INCLUDING, BUT NOT LIMITED TO, THE IMPLIED WARRANTIES OF MERCHANTABILITY AND FITNESS FOR A PARTICULAR PURPOSE ARE DISCLAIMED. IN NO EVENT SHALL THE COPYRIGHT OWNER OR CONTRIBUTORS BE LIABLE FOR ANY DIRECT, INDIRECT, INCIDENTAL, SPECIAL, EXEMPLARY, OR CONSEQUENTIAL DAMAGES (INCLUDING, BUT NOT LIMITED TO, PROCUREMENT OF SUBSTITUTE GOODS OR SERVICES; LOSS OF USE, DATA, OR PROFITS; OR BUSINESS INTERRUPTION) HOWEVER CAUSED AND ON ANY THEORY OF LIABILITY, WHETHER IN CONTRACT, STRICT LIABILITY, OR TORT (INCLUDING NEGLIGENCE OR OTHERWISE) ARISING IN ANY WAY OUT OF THE USE OF THIS SOFTWARE, EVEN IF ADVISED OF THE POSSIBILITY OF SUCH DAMAGE.

Declarations of Conformity

This device complies with Part 15 of the FCC Rules. Operation is subject to the following two conditions:

1. This device may not cause harmful interference
2. This device must accept any interference received, including interference that may cause undesired operation.

This equipment has been tested and found to comply with the limits of a Class B digital device, pursuant to Part 15 of the FCC Rules. These limits are designed to provide reasonable protection against harmful interference in a residential installation. This equipment generates, uses and can radiate radio frequency energy and, if not installed and used in accordance with the instructions, may cause harmful interference to radio communications. If this equipment does cause harmful interference to radio or television reception, which can be determined by turning the equipment off and on, the user is encouraged to try to correct the interference by one or more of the following measures:

1. Re-orient or relocate the receiving antenna.
2. Increase the separation between the equipment and receiver.
3. Connect the equipment into an outlet on a different circuit from that to which the receiver is connected.
4. Consult the dealer or an experienced radio/TV technician for help.

NOTE: The use of non-shielded cable with this equipment is prohibited.

CAUTION: Changes or modifications not expressly approved by the manufacturer responsible for compliance could void the user's authority to operate the equipment.

Apogee Electronics Corp.
1715 Berkeley Street
Santa Monica, CA 90404, USA

Betty Bennett, CEO.

Industry Canada Notice

This Class B digital apparatus meets all requirements of the Canadian Interference-Causing Equipment Regulations. Cet appareil numérique de la classe B respecte toutes les exigences du Règlement sur le matériel brouilleur du Canada.

Declaration of Conformity – CE

Apogee Electronics Corporation hereby declares that the product, the Symphony, to which this declaration relates, is in material conformity with the following standards or other normative documents:

- EN50081-1/EN55022; 1995
 - EN50082-1/IEC 801-2, 3, 4; 1992
- following the provisions of:
- 73/23/EEC – Low Voltage Directive
 - 89/336/EEC – EMC Directive

Declaration of Conformity – Japan

Apogee Electronics Corporation hereby declares that Symphony, to which this declaration relates, is in material conformity with the VCCI Class A standard.

Declaration of Conformity – Australia

Apogee Electronics Corporation hereby declares that Symphony is in material conformity with AN/NZS standard requirements.

